

MASTER CATALOG **2023**

METRIC



SOLID CARBIDE END MILLING | MODULAR END MILLING

HARVI™ | TE

Innovative proprietary design features driving maximum productivity.

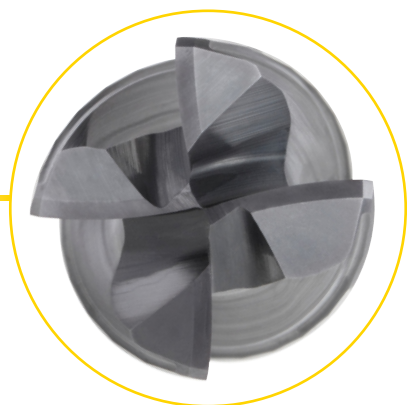

Twisted end face.

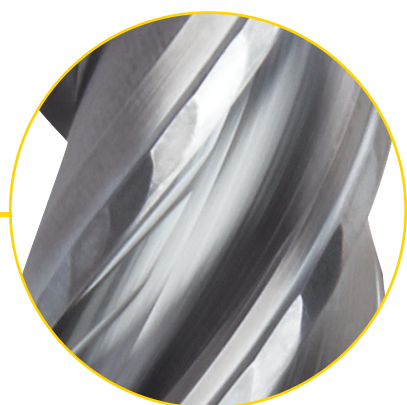

Faceted eccentric relief.



Chip gashes within flutes.

MASTER CATALOG

Services & Support	2-3
Contact Information	2-3
High-Performance Solid Carbide End Milling	4-119
Roughing & Finishing with One Tool.....	4-6, 8-45
Dynamic Milling.....	7, 46-60
Roughers and Finishers	62-72
Aluminum Machining.....	73-91
CFRP, High-Temperature Alloys, and Hard Materials Machining.....	92-99
End Mills for Specific Applications.....	100-108
Economy & General-Purpose Applications.....	109-116
Nomenclatures.....	117-119
High-Performance Modular End Milling	120-161
Roughing & Finishing with One Tool.....	120-121, 124-135
Roughers and Finishers	121-122, 124-125, 136-139
Aluminum Machining.....	122, 124-125, 140-142
Specific Applications	123-125, 143-154
Adapters and Wrenches	155-158
Nomenclatures.....	159-161
General Information	162-165
Grades and Grade Descriptions	162-163
Key to Column Headings	164
Material Cross Reference.....	165

CAS — Customer Application Support

Get Fast and Reliable Answers to Your Toughest Problems

Our CAS Team is the metalworking industry's leading help desk resource for tooling application solutions and problem resolution.

Easy Access to Proven Metalworking Expertise!

Kennametal Application Engineers assist customers and engineering groups throughout the world with expert tool selection and application recommendations for the entire range of Kennametal tooling.



Region	Originating Country	Language	CAS Hotline	Email
North America	USA	English	800 835 3668	na.techsupport@kennametal.com
	Mexico	Spanish	1800 253 0758	na.techsupport@kennametal.com
Africa	South Africa	English	+27117489300	na.techsupport@kennametal.com
Europe	Austria	German	0223 63181360	eu.techsupport@kennametal.com
	Belgium	English/French	0279 06 540	eu.techsupport@kennametal.com
	Denmark	English	808 89298	na.techsupport@kennametal.com
	Finland	English	0800 919412	na.techsupport@kennametal.com
	France	French	01 60 12 83 00	eu.techsupport@kennametal.com
	Germany	German	06003 8277110	eu.techsupport@kennametal.com
	Israel	English	—	na.techsupport@kennametal.com
	Italy	Italian	028 95 96 212	eu.techsupport@kennametal.com
	Netherlands	English	076 79 95 220	eu.techsupport@kennametal.com
	Norway	English	800 10080	na.techsupport@kennametal.com
	Poland	Polish	616 656 553	eu.techsupport@kennametal.com
	Russia	English	—	eu.techsupport@kennametal.com
	Sweden	English	0207 99246	na.techsupport@kennametal.com
UK	English	0138 44 08 095	na.techsupport@kennametal.com	
Ukraine	English	—	eu.techsupport@kennametal.com	
Asia Pacific	Australia	English	1800 666 667	ap-kmt.techsupport@kennametal.com
	India	English	1 800 103 5227	in.techsupport@kennametal.com
	Japan	English	03 3820 2855	ap-kmt.techsupport@kennametal.com
	Korea (South)	English	+82 2 2100 6100	ap-kmt.techsupport@kennametal.com
	Malaysia	English	1800 812 990	ap-kmt.techsupport@kennametal.com
	New Zealand	English	0800 450 941	ap-kmt.techsupport@kennametal.com
	Singapore	English	1800 6221031	ap-kmt.techsupport@kennametal.com
	Taiwan	English	0800 666 197	ap-kmt.techsupport@kennametal.com
Thailand	English	1800 4417820	ap-kmt.techsupport@kennametal.com	

Numbers shown only serve the originating country listed.

Service & Sales Centers Around the World



















Region	Country	Sales Hotline	Email
North America	United States	+1 800 446 7738	FtMill.Service@kennametal.com
	Canada	+1 800 446 7738	toronto.service@kennametal.com
	Mexico	+1 888 402 4963	k-mx.service@kennametal.com
Central/South America	Argentina	+54 11 4719 0700	buenos-aires.ventas@kennametal.com
	Brazil	+55 19 3936 9200	bra.marketing@kennametal.com
	Chile	+56 2 2264 1177	kennametalchile@kennametalchile.cl
Africa	Egypt	+44 1384 408060	na.techsupport@kennametal.com
	South Africa	+27 11 748 9300	na.techsupport@kennametal.com
Europe	Austria	+43 2236 3798980	brunn.sales@kennametal.com
	Belgium	+32 0800 81 372	belgium.sales@kennametal.com
	Czech Republic	+420 800 900 840	k-prha.sales@kennametal.com
	France	+33 1 60 12 81 00	info.fr@kennametal.com
	Germany	+49 6003 8277 0	rosbach.sales@kennametal.com
	Great Britain	+44 1384 408060	kingswinford.service@kennametal.com
	Hungary	+36 96 618 150	gyoer.sales@kennametal.com
	Ireland	+44 1384 408060	na.techsupport@kennametal.com
	Italy	+39 02 895 961	milano.vendite@kennametal.com
	Luxemborg	+32 4 248 48 48	liege.sales@kennametal.com
	Netherlands	+31 0800 44 33 201	netherlands.sales@kennametal.com
	Poland	+48 61 6656501	poland.service@kennametal.com
	Portugal	+351 22 4119 400	porto.service@kennametal.com
	Russia	+7 495 4115386	moscow.information@kennametal.com
Slovakia	+421 0800 044 053	k-eu-zilina.sales@kennametal.com	
Spain	+34 93 586 03 50	barcelona.service@kennametal.com	
Turkey	+90 216 574 4780	tr.information@kennametal.com	
Asia Pacific	Australia	+61 800 666 667	k-au.service@kennametal.com
	China	+86 400 889 2135	k-cn.service@kennametal.com
	India	+91 800 103 5138	k-bngl.information@kennametal.com
	Indonesia	+65 6265 9222	k-sg.sales@kennametal.com
	Japan	+81 3 3820 2855	k-jp.service@kennametal.com
	Korea (South)	+82 2 2109 6100	k-kr-service@kennametal.com
	Malaysia	+60 3 5569 9080	k-sg.sales@kennametal.com
	New Zealand	+64 0800 536626	k-nz.service@kennametal.com
	Singapore*	+65 62659222	k-sg.sales@kennametal.com
	Taiwan	+886 4 2350 1920	taiwan.service@kennametal.com
Thailand	+66 2 642 3455	k-sg.sales@kennametal.com	

*Vietnam and Philippines individuals should contact the Singapore office.

Visit kennametal.com to find local Authorized Kennametal Distributors.





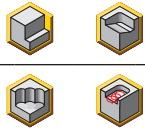
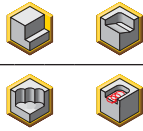
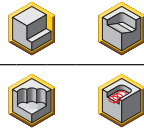
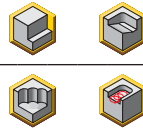
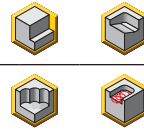
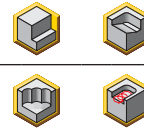























Tool Selector

HIGH-PERFORMANCE ROUGHING AND FINISHING						
HARVI™ I TE						
						
Series	H1TE4CH..R..	H1TE4CH..N..	H1TE4CH..S..	H1TE4RA..N..	H1TE4RA..E..	H1TE4SE..N..
Page	10	11	12	13-14	15-17	18
Tool type						
Rougher	●	●	●	●	●	●
Finisher	○	○	○	○	○	○
Chamfering						
Main operation						
Workpiece material						
Primary	P M K	P M K	P M K	P M K S	P M K S	P M K
Secondary	S H	S H	S H	H	H	S H
Corner style						
Corner radius [Rε]	—	—	—	0,25-6,0mm	0,25-6,0mm	—
Corner chamfer width [BCH]	0,2-0,5mm	0,15-0,35mm	0,1-0,35mm	—	—	—
Cutter diameter [D1]	2-25mm	2-25mm	2-25mm	4-25mm	4-25mm	2-25mm
Length of cut	1,8-3 x D1	1,8-3 x D1	1,2-2 x D1	1,5 x D	1,8-2,75 x D1	1,8-3 x D1
Maximum cutting depth [Ap1 max]	5-45mm	6-45mm	4-30mm	6-37,5mm	11-45mm	6-45mm
Flute helix angle	36°/39°	36°/39°	36°/39°	36°/39°	36/39	36°/39°
Number of flutes [ZU]	4	4	4	4	4	4
Center cutting	✓	✓	✓	✓	✓	✓
Additional operations						

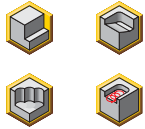
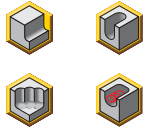











- Primary
- Secondary

Tool Selector

HIGH-PERFORMANCE ROUGHING AND FINISHING						
	HARVI™ I TE		HARVI II		HARVI III	
						
Series	H1TE4SE..S..	H1TEBN..N-L	UCDE	UDDE	UJDE	UJDE with Neck
Page	19	20	28-30	31-33	33-34	35-36
Tool type						
Rougher	●	●	●	●	○	○
Finisher	○	○	○	○	●	●
Chamfering						
Main operation						
Workpiece material						
Primary	P M K	P M K	P M K S	P M S	M S	M S
Secondary	S H	S H	H	H	P H	P H
Corner style			 	 	 	 
Corner radius [R _ε]	—	—	0,25-0,75mm	0,20-6mm	0,50-0,75mm	0,50-6mm
Corner chamfer width [BCH]	—	—	—	—	—	—
Cutter diameter [D1]	2-25mm	2-20mm	4-25mm	6-25mm	10-25mm	10-25mm
Length of cut	1,2-2 x D1	1-2,7 x D	1,8-2,7 x D1	1,8-2,4 x D	1,8-2,2 x D	1,8-2,2 x D
Maximum cutting depth [A _{p1} max]	4-30mm	2-50mm	11-45mm	13-45mm	22-45mm	22-45mm
Flute helix angle	36°/39°	36°/39°	38°	38°	38°	38°
Number of flutes [ZU]	4	4	5	5	6	6
Center cutting	✓	✓			✓	✓
Additional operations						

































- Primary
- Secondary

Tool Selector

HIGH-PERFORMANCE ROUGHING AND FINISHING			
	HARVI™ III		HARVI II Long
			
Series	UJBE	UJBE	UGDE
Page	36	37	38-39
Tool type			
Rougher	○	○	
Finisher	●	●	●
Chamfering			
Main operation			
Workpiece material			
Primary	M S	M S	P M S
Secondary	P H	P H	K H
Corner style			
Corner radius [R _ε]	—	—	0,20-6mm
Corner chamfer width [BCH]	—	—	—
Cutter diameter [D1]	10-20mm	4-10mm	6-25mm
Length of cut	1 x D1	4,7-7 x D	3-5 x D
Maximum cutting depth [A _{p1} max]	10-20mm	26-39mm	18-125mm
Flute helix angle	38°	38°	43°
Number of flutes [ZU]	6	6	5
Center cutting	✓	✓	
Additional operations			

- Primary
- Secondary

Tool Selector

DYNAMIC MILLING							
	KOR5™ DS		KOR5™ DA			KOR6™ DT	
				NEW! 			
Series	KOR5..R..	KOR5..L..	KOR5..R..I	KOR5..L..I..	KOR5..R..C	KOR6..R..	KOR6..L..
Page	48	49	50-51	53-55	51-53	55-56	56-57
Tool type							
Rougher	●	●	●	●	●	●	●
Finisher	○	○	○	○	○		
Chamfering							
Main operation							
Workpiece material							
Primary	P M	P M	N	N	N	S	S
Secondary	K S H	K S H				P M K H	P M K H
Corner style			 	 	 		
Corner radius [R _ε]	0,50–1mm	0,50–1mm	0,20–2,50mm	0,20–2,50mm	0,20–2,50mm	0,05–1mm	0,50–1mm
Corner chamfer width [BCH]	–	–	–	–	–	–	–
Cutter diameter [D1]	8–25mm	8–25mm	10–25mm	10–25mm	10–25mm	8–25mm	8–25mm
Length of cut	3 x D	5 x D	3 x D	5 x D	3 x D	3 x D	5 x D
Maximum cutting depth [A _{p1} max]	24–75mm	40–125mm	30–60mm	50–125mm	30–60mm	24–75mm	40–125mm
Flute helix angle	40°	40°	35°	35°	35°	38°	38°
Number of flutes [ZU]	5	5	5	5	5	6	6
Coolant							
Additional operations							

- Primary
- Secondary

HARVI™ I TE

High-Performance Roughing and Finishing with Maximum Versatility



Materials



Applications



Slotting



3D Profiling



Side Milling/
Shoulder Milling



Ramping



Slotting:
Ball Nose



Helical Interpolation



Plunge Milling



Trochoidal Milling

Four-flute end mill for roughing and finishing covering the broadest range of applications and materials.

The HARVI I TE series solid carbide end mills ensure maximum metal removal rates in a variety of operations, including dynamic milling and extreme ramping operations.

Applicable in steels, stainless steel, cast iron, high-temperature alloys, and hardened materials.

HARVI I TE — Maximum metal removal. Maximum productivity. Maximum benefit.

Chamfered.

**Chamfered.
Sharp edge.
Short version.**

**Necked.
Chamfered.
Radiused.
Sharp edge.**

**Extended neck.
Radiused.**

**Ball nose.
Short version
with neck.
Long version.**



Faceted eccentric relief.



Chip gashes within the flutes.



Twisted end face.

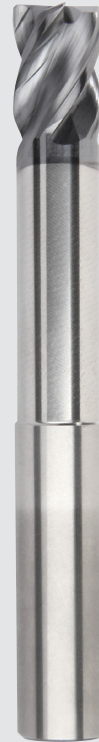

Asymmetrical divided flutes and variable helix.

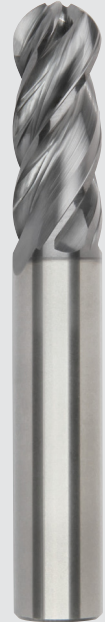

Proprietary end face design — Twisted cutting edge increases corner stability, enabling soft cutting action even at highest ramping angles.

Asymmetrical divided flutes and variable helix, enabling vibration dampening and unmatched feed rates.

Proprietary relief — A precision-faceted eccentric relief reduces vibrations and friction. For excellent cutting conditions in multiple materials.

Proprietary flute design — Innovative chip gashes within the flutes reduce cutting forces and support efficient chip evacuation.

Proprietary core design — Increases tool stability.

HARVI™ I TE • Chamfered • 4 Flutes • Plain Shank • Metric

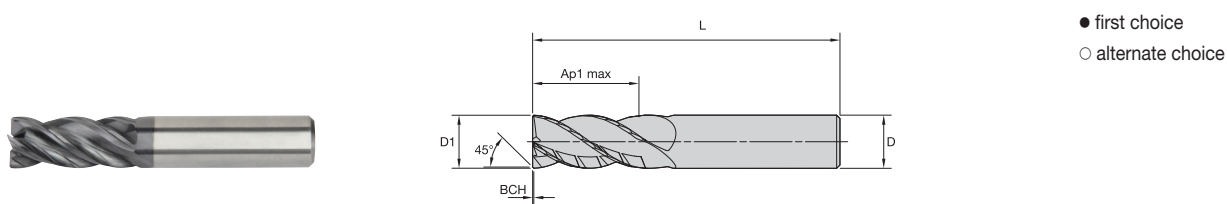

- first choice
- alternate choice

P	●
M	●
K	●
N	●
S	○
H	○

order number	catalogue number	D1	D	Ap1 max	L	BCH	KCPM15
6767929	H1TE4CH0200R005HAM	2,00	6,00	5,00	50,00	0,20	●
6767930	H1TE4CH0250R006HAM	2,50	6,00	6,00	50,00	0,20	●
6767951	H1TE4CH0300R007HAM	3,00	6,00	7,00	54,00	0,30	●
6767952	H1TE4CH0350R008HAM	3,50	6,00	8,00	54,00	0,30	●
6675697	H1TE4CH0400R012HAM	4,00	6,00	12,00	55,00	0,40	●
6675698	H1TE4CH0500R013HAM	5,00	6,00	13,00	57,00	0,40	●
6675699	H1TE4CH0600R013HAM	6,00	6,00	13,00	57,00	0,40	●
6675700	H1TE4CH0800R016HAM	8,00	8,00	16,00	63,00	0,40	●
6675742	H1TE4CH1000R022HAM	10,00	10,00	22,00	72,00	0,50	●
6675743	H1TE4CH1200R026HAM	12,00	12,00	26,00	83,00	0,50	●
6675744	H1TE4CH1400R026HAM	14,00	14,00	26,00	83,00	0,50	●
6675745	H1TE4CH1600R032HAM	16,00	16,00	32,00	92,00	0,50	●
6675746	H1TE4CH1800R032HAM	18,00	18,00	32,00	92,00	0,50	●
6675747	H1TE4CH2000R038HAM	20,00	20,00	38,00	104,00	0,50	●
6675748	H1TE4CH2500R045HAM	25,00	25,00	45,00	121,00	0,50	●

HARVI I TE • Chamfered • 4 Flutes • Weldon® Shank • Metric

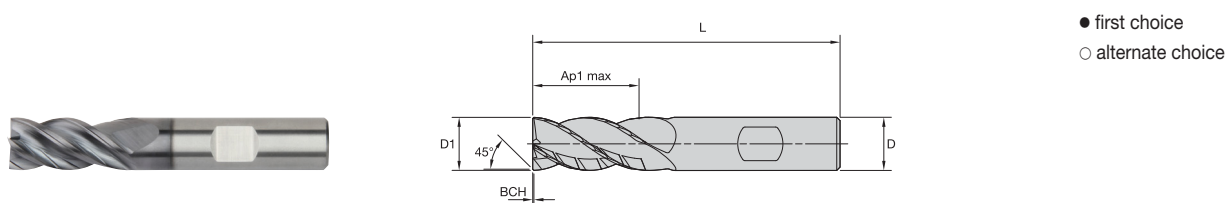

- first choice
- alternate choice

P	●
M	●
K	●
N	●
S	○
H	○

order number	catalogue number	D1	D	Ap1 max	L	BCH	KCPM15
6767953	H1TE4CH0200R005HBM	2,00	6,00	5,00	50,00	0,20	●
6767954	H1TE4CH0250R006HBM	2,50	6,00	6,00	50,00	0,20	●
6767955	H1TE4CH0300R007HBM	3,00	6,00	7,00	54,00	0,30	●
6767956	H1TE4CH0350R008HBM	3,50	6,00	8,00	54,00	0,30	●
6675749	H1TE4CH0400R012HBM	4,00	6,00	12,00	55,00	0,40	●
6675750	H1TE4CH0500R013HBM	5,00	6,00	13,00	57,00	0,40	●
6675751	H1TE4CH0600R013HBM	6,00	6,00	13,00	57,00	0,40	●
6675752	H1TE4CH0800R016HBM	8,00	8,00	16,00	63,00	0,40	●
6675753	H1TE4CH1000R022HBM	10,00	10,00	22,00	72,00	0,50	●
6675754	H1TE4CH1200R026HBM	12,00	12,00	26,00	83,00	0,50	●
6675755	H1TE4CH1400R026HBM	14,00	14,00	26,00	83,00	0,50	●
6675756	H1TE4CH1600R032HBM	16,00	16,00	32,00	92,00	0,50	●
6675757	H1TE4CH1800R032HBM	18,00	18,00	32,00	92,00	0,50	●
6675758	H1TE4CH2000R038HBM	20,00	20,00	38,00	104,00	0,50	●
6687137	H1TE4CH2500R045HBM	25,00	25,00	45,00	121,00	0,50	●

162-163	164	117-119	168



HARVI™ I TE • Chamfered • 4 Flutes • Necked • Plain Shank • Metric

● first choice

○ alternate choice

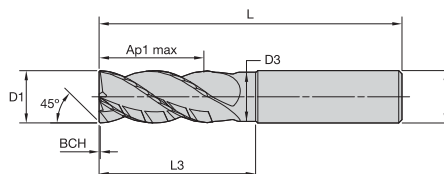

P	●
M	●
K	●
N	●
S	○
H	○

order number	catalogue number	D1	D	D3	Ap1 max	L3	L	BCH	KCPM15
6767959	H1TE4CH0200N006HAM	2,00	6,00	—	6,00	—	57,00	0,10	●
6767960	H1TE4CH0250N006HAM	2,50	6,00	—	6,00	—	57,00	0,10	●
6767961	H1TE4CH0300N008HAM	3,00	6,00	2,82	8,00	16,50	57,00	0,10	●
6767962	H1TE4CH0350N010HAM	3,50	6,00	3,29	10,00	16,50	57,00	0,10	●
6676308	H1TE4CH0400N011HAM	4,00	6,00	3,76	11,00	16,00	57,00	0,15	●
6676310	H1TE4CH0500N013HAM	5,00	6,00	4,70	13,00	18,00	57,00	0,15	●
6676332	H1TE4CH0600N013HAM	6,00	6,00	5,64	13,00	18,00	57,00	0,15	●
6676334	H1TE4CH0800N016HAM	8,00	8,00	7,52	16,00	24,00	63,00	0,20	●
6676336	H1TE4CH1000N022HAM	10,00	10,00	9,40	22,00	30,00	72,00	0,20	●
6676338	H1TE4CH1200N026HAM	12,00	12,00	11,28	26,00	36,00	83,00	0,20	●
6676340	H1TE4CH1400N026HAM	14,00	14,00	13,16	26,00	42,00	83,00	0,25	●
6676342	H1TE4CH1600N032HAM	16,00	16,00	15,04	32,00	48,00	92,00	0,35	●
6676344	H1TE4CH2000N038HAM	20,00	20,00	18,80	38,00	60,00	104,00	0,35	●
6676346	H1TE4CH2500N045HAM	25,00	25,00	24,00	45,00	75,00	121,00	0,35	●

HARVI I TE • Chamfered • 4 Flutes • Necked • Weldon® Shank • Metric

● first choice

○ alternate choice

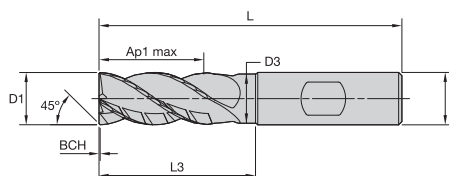

P	●
M	●
K	●
N	●
S	○
H	○

order number	catalogue number	D1	D	D3	Ap1 max	L3	L	BCH	KCPM15
6767963	H1TE4CH0200N006HBM	2,00	6,00	—	6,00	—	57,00	0,10	●
6767964	H1TE4CH0250N006HBM	2,50	6,00	—	6,00	—	57,00	0,10	●
6767965	H1TE4CH0300N008HBM	3,00	6,00	2,82	8,00	16,50	57,00	0,10	●
6767966	H1TE4CH0350N010HBM	3,50	6,00	3,29	10,00	16,50	57,00	0,10	●
6676309	H1TE4CH0400N011HBM	4,00	6,00	3,76	11,00	16,00	57,00	0,15	●
6676331	H1TE4CH0500N013HBM	5,00	6,00	4,70	13,00	18,00	57,00	0,15	●
6676333	H1TE4CH0600N013HBM	6,00	6,00	5,64	13,00	18,00	57,00	0,15	●
6676335	H1TE4CH0800N016HBM	8,00	8,00	7,52	16,00	24,00	63,00	0,20	●
6676337	H1TE4CH1000N022HBM	10,00	10,00	9,40	22,00	30,00	72,00	0,20	●
6676339	H1TE4CH1200N026HBM	12,00	12,00	11,28	26,00	36,00	83,00	0,20	●
6676341	H1TE4CH1400N026HBM	14,00	14,00	13,16	26,00	42,00	83,00	0,25	●
6676343	H1TE4CH1600N032HBM	16,00	16,00	15,04	32,00	48,00	92,00	0,35	●
6676345	H1TE4CH2000N038HBM	20,00	20,00	18,80	38,00	60,00	104,00	0,35	●
6676347	H1TE4CH2500N045HBM	25,00	25,00	24,00	45,00	75,00	121,00	0,35	●

162-163	164	117-119	168

HARVI™ I TE • Chamfered • 4 Flutes • Short • Plain Shank • Metric

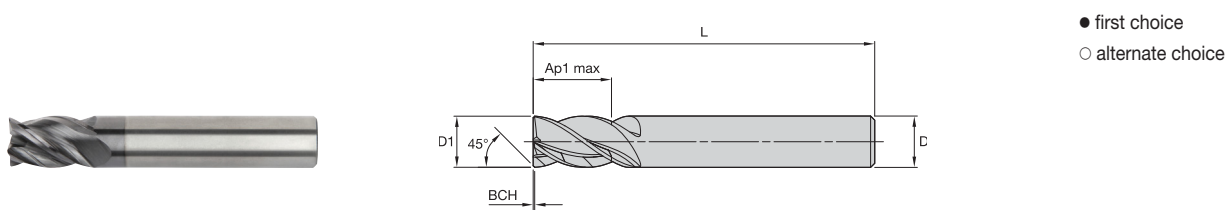

- first choice
- alternate choice

P	●
M	●
K	●
N	●
S	○
H	○

order number	catalogue number	D1	D	Ap1 max	L	BCH	KCPM15
6769607	H1TE4CH0200S004HAM	2,00	6,00	4,00	54,00	0,10	●
6769608	H1TE4CH0250S005HAM	2,50	6,00	5,00	54,00	0,10	●
6769609	H1TE4CH0300S006HAM	3,00	6,00	6,00	54,00	0,10	●
6769610	H1TE4CH0350S007HAM	3,50	6,00	7,00	54,00	0,10	●
6769611	H1TE4CH0400S008HAM	4,00	6,00	8,00	54,00	0,15	●
6769613	H1TE4CH0500S009HAM	5,00	6,00	9,00	54,00	0,15	●
6769614	H1TE4CH0600S010HAM	6,00	6,00	10,00	54,00	0,15	●
6769615	H1TE4CH0800S012HAM	8,00	8,00	12,00	58,00	0,20	●
6769616	H1TE4CH1000S014HAM	10,00	10,00	14,00	66,00	0,25	●
6769617	H1TE4CH1200S016HAM	12,00	12,00	16,00	73,00	0,25	●
6769619	H1TE4CH1400S018HAM	14,00	14,00	18,00	75,00	0,25	●
6769620	H1TE4CH1600S022HAM	16,00	16,00	22,00	82,00	0,35	●
6769621	H1TE4CH1800S024HAM	18,00	18,00	24,00	92,00	0,35	●
6769622	H1TE4CH2000S026HAM	20,00	20,00	26,00	92,00	0,35	●
6769623	H1TE4CH2500S030HAM	25,00	25,00	30,00	121,00	0,35	●

HARVI I TE • Chamfered • 4 Flutes • Short • Weldon® Shank • Metric

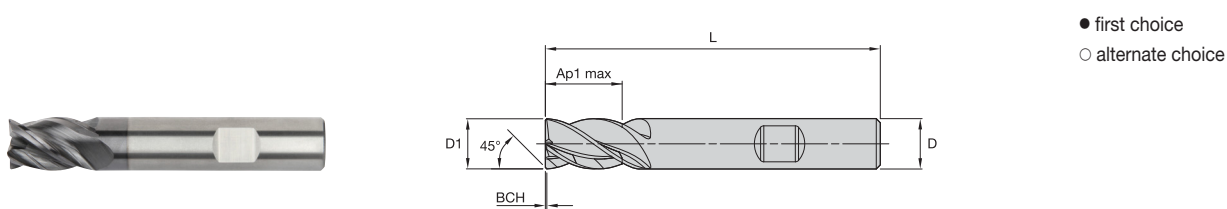

- first choice
- alternate choice

P	●
M	●
K	●
N	●
S	○
H	○

order number	catalogue number	D1	D	Ap1 max	L	BCH	KCPM15
6769625	H1TE4CH0200S004HBM	2,00	6,00	4,00	54,00	0,10	●
6769626	H1TE4CH0250S005HBM	2,50	6,00	5,00	54,00	0,10	●
6769627	H1TE4CH0300S006HBM	3,00	6,00	6,00	54,00	0,10	●
6769628	H1TE4CH0350S007HBM	3,50	6,00	7,00	54,00	0,10	●
6769629	H1TE4CH0400S008HBM	4,00	6,00	8,00	54,00	0,15	●
6769630	H1TE4CH0500S009HBM	5,00	6,00	9,00	54,00	0,15	●
6769631	H1TE4CH0600S010HBM	6,00	6,00	10,00	54,00	0,15	●
6769632	H1TE4CH0800S012HBM	8,00	8,00	12,00	58,00	0,20	●
6769633	H1TE4CH1000S014HBM	10,00	10,00	14,00	66,00	0,25	●
6769634	H1TE4CH1200S016HBM	12,00	12,00	16,00	73,00	0,25	●
6769635	H1TE4CH1400S018HBM	14,00	14,00	18,00	75,00	0,25	●
6769636	H1TE4CH1600S022HBM	16,00	16,00	22,00	82,00	0,35	●
6769637	H1TE4CH1800S024HBM	18,00	18,00	24,00	92,00	0,35	●
6769638	H1TE4CH2000S026HBM	20,00	20,00	26,00	92,00	0,35	●
6769639	H1TE4CH2500S030HBM	25,00	25,00	30,00	121,00	0,35	●

162-163	164	117-119	168



HARVI™ I TE • Radiused • 4 Flutes • Necked • Plain Shank • Metric

● first choice

○ alternate choice

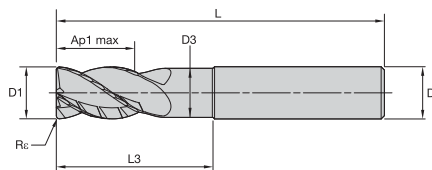

P	●
M	●
K	○
N	○
S	○
H	○

order number	catalogue number	D1	D	D3	Ap1 max	L3	L	Rε	KCSM15
6767968	H1TE4RA0400N006HAR025M	4,00	6,00	3,76	6,00	12,00	57,00	0,25	●
6767969	H1TE4RA0400N006HAR050M	4,00	6,00	3,76	6,00	12,00	57,00	0,50	●
6676190	H1TE4RA0600N009HAR050M	6,00	6,00	5,64	9,00	18,00	63,00	0,50	●
6676231	H1TE4RA0600N009HAR100M	6,00	6,00	5,64	9,00	18,00	63,00	1,00	●
6676234	H1TE4RA0800N012HAR050M	8,00	8,00	7,52	12,00	24,00	68,00	0,50	●
6676235	H1TE4RA0800N012HAR100M	8,00	8,00	7,52	12,00	24,00	68,00	1,00	●
6676238	H1TE4RA1000N015HAR050M	10,00	10,00	9,40	15,00	30,00	76,00	0,50	●
6676239	H1TE4RA1000N015HAR100M	10,00	10,00	9,40	15,00	30,00	76,00	1,00	●
6676240	H1TE4RA1000N015HAR200M	10,00	10,00	9,40	15,00	30,00	76,00	2,00	●
6676251	H1TE4RA1000N015HAR300M	10,00	10,00	9,40	15,00	30,00	76,00	3,00	●
6676252	H1TE4RA1000N015HAR400M	10,00	10,00	9,40	15,00	30,00	76,00	4,00	●
6676257	H1TE4RA1200N018HAR050M	12,00	12,00	11,28	18,00	36,00	83,00	0,50	●
6676258	H1TE4RA1200N018HAR100M	12,00	12,00	11,28	18,00	36,00	83,00	1,00	●
6676259	H1TE4RA1200N018HAR200M	12,00	12,00	11,28	18,00	36,00	83,00	2,00	●
6676260	H1TE4RA1200N018HAR300M	12,00	12,00	11,28	18,00	36,00	83,00	3,00	●
6676271	H1TE4RA1200N018HAR400M	12,00	12,00	11,28	18,00	36,00	83,00	4,00	●
6676277	H1TE4RA1600N024HAR050M	16,00	16,00	15,04	24,00	48,00	100,00	0,50	●
6676278	H1TE4RA1600N024HAR100M	16,00	16,00	15,04	24,00	48,00	100,00	1,00	●
6676279	H1TE4RA1600N024HAR200M	16,00	16,00	15,04	24,00	48,00	100,00	2,00	●
6676280	H1TE4RA1600N024HAR300M	16,00	16,00	15,04	24,00	48,00	100,00	3,00	●
6676281	H1TE4RA1600N024HAR400M	16,00	16,00	15,04	24,00	48,00	100,00	4,00	●
6676282	H1TE4RA1600N024HAR600M	16,00	16,00	15,04	24,00	48,00	100,00	6,00	●
6676289	H1TE4RA2000N030HAR050M	20,00	20,00	18,80	30,00	60,00	115,00	0,50	●
6676290	H1TE4RA2000N030HAR100M	20,00	20,00	18,80	30,00	60,00	115,00	1,00	●
6676291	H1TE4RA2000N030HAR200M	20,00	20,00	18,80	30,00	60,00	115,00	2,00	●
6676292	H1TE4RA2000N030HAR300M	20,00	20,00	18,80	30,00	60,00	115,00	3,00	●
6676293	H1TE4RA2000N030HAR400M	20,00	20,00	18,80	30,00	60,00	115,00	4,00	●
6676294	H1TE4RA2000N030HAR600M	20,00	20,00	18,80	30,00	60,00	115,00	6,00	●
6676299	H1TE4RA2500N038HAR050M	25,00	25,00	24,00	37,50	75,00	135,00	0,50	●
6676300	H1TE4RA2500N038HAR100M	25,00	25,00	24,00	37,50	75,00	135,00	1,00	●
6676301	H1TE4RA2500N038HAR200M	25,00	25,00	24,00	37,50	75,00	135,00	2,00	●
6676302	H1TE4RA2500N038HAR300M	25,00	25,00	24,00	37,50	75,00	135,00	3,00	●
6676303	H1TE4RA2500N038HAR400M	25,00	25,00	24,00	37,50	75,00	135,00	4,00	●
6676304	H1TE4RA2500N038HAR600M	25,00	25,00	24,00	37,50	75,00	135,00	6,00	●

162-163	164	117-119	168

HARVI™ I TE • Radiused • 4 Flutes • Necked • Weldon® Shank • Metric

● first choice

○ alternate choice

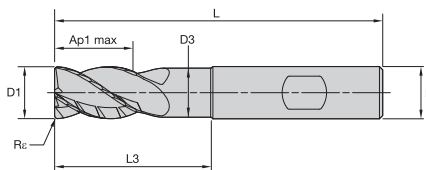

P	●
M	●
K	○
N	○
S	○
H	○

order number	catalogue number	D1	D	D3	Ap1 max	L3	L	Rε	KCSM15
6767970	H1TE4RA0400N006HBR025M	4,00	6,00	3,76	6,00	12,00	57,00	0,25	●
6767981	H1TE4RA0400N006HBR050M	4,00	6,00	3,76	6,00	12,00	57,00	0,50	●
6676232	H1TE4RA0600N009HBR050M	6,00	6,00	5,64	9,00	18,00	63,00	0,50	●
6676233	H1TE4RA0600N009HBR100M	6,00	6,00	5,64	9,00	18,00	63,00	1,00	●
6676236	H1TE4RA0800N012HBR050M	8,00	8,00	7,52	12,00	24,00	68,00	0,50	●
6676237	H1TE4RA0800N012HBR100M	8,00	8,00	7,52	12,00	24,00	68,00	1,00	●
6676253	H1TE4RA1000N015HBR050M	10,00	10,00	9,40	15,00	30,00	76,00	0,50	●
6676254	H1TE4RA1000N015HBR100M	10,00	10,00	9,40	15,00	30,00	76,00	1,00	●
6676255	H1TE4RA1000N015HBR200M	10,00	10,00	9,40	15,00	30,00	76,00	2,00	●
6676256	H1TE4RA1000N015HBR300M	10,00	10,00	9,40	15,00	30,00	76,00	3,00	●
6687139	H1TE4RA1000N015HBR400M	10,00	10,00	9,40	15,00	30,00	76,00	4,00	●
6676272	H1TE4RA1200N018HBR050M	12,00	12,00	11,28	18,00	36,00	83,00	0,50	●
6676273	H1TE4RA1200N018HBR100M	12,00	12,00	11,28	18,00	36,00	83,00	1,00	●
6676274	H1TE4RA1200N018HBR200M	12,00	12,00	11,28	18,00	36,00	83,00	2,00	●
6676275	H1TE4RA1200N018HBR300M	12,00	12,00	11,28	18,00	36,00	83,00	3,00	●
6676276	H1TE4RA1200N018HBR400M	12,00	12,00	11,28	18,00	36,00	83,00	4,00	●
6676283	H1TE4RA1600N024HBR050M	16,00	16,00	15,04	24,00	48,00	100,00	0,50	●
6676284	H1TE4RA1600N024HBR100M	16,00	16,00	15,04	24,00	48,00	100,00	1,00	●
6676285	H1TE4RA1600N024HBR200M	16,00	16,00	15,04	24,00	48,00	100,00	2,00	●
6676286	H1TE4RA1600N024HBR300M	16,00	16,00	15,04	24,00	48,00	100,00	3,00	●
6676287	H1TE4RA1600N024HBR400M	16,00	16,00	15,04	24,00	48,00	100,00	4,00	●
6676288	H1TE4RA1600N024HBR600M	16,00	16,00	15,04	24,00	48,00	100,00	6,00	●
6676295	H1TE4RA2000N030HBR050M	20,00	20,00	18,80	30,00	60,00	115,00	0,50	●
6676296	H1TE4RA2000N030HBR100M	20,00	20,00	18,80	30,00	60,00	115,00	1,00	●
6676297	H1TE4RA2000N030HBR200M	20,00	20,00	18,80	30,00	60,00	115,00	2,00	●
6676298	H1TE4RA2000N030HBR300M	20,00	20,00	18,80	30,00	60,00	115,00	3,00	●
6687140	H1TE4RA2000N030HBR400M	20,00	20,00	18,80	30,00	60,00	115,00	4,00	●
6687151	H1TE4RA2000N030HBR600M	20,00	20,00	18,80	30,00	60,00	115,00	6,00	●
6676305	H1TE4RA2500N038HBR050M	25,00	25,00	24,00	37,50	75,00	135,00	0,50	●
6687152	H1TE4RA2500N038HBR100M	25,00	25,00	24,00	37,50	75,00	135,00	1,00	●
6687153	H1TE4RA2500N038HBR200M	25,00	25,00	24,00	37,50	75,00	135,00	2,00	●
6687154	H1TE4RA2500N038HBR300M	25,00	25,00	24,00	37,50	75,00	135,00	3,00	●
6676306	H1TE4RA2500N038HBR400M	25,00	25,00	24,00	37,50	75,00	135,00	4,00	●
6676307	H1TE4RA2500N038HBR600M	25,00	25,00	24,00	37,50	75,00	135,00	6,00	●

162-163	164	117-119	168



HARVI™ | TE • Radiused • 4 Flutes • Extended Neck • Plain Shank • Metric

- first choice
- alternate choice

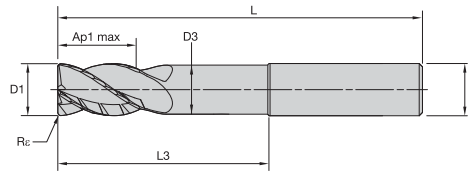

P	●
M	●
K	○
N	○
S	●
H	○

order number	catalogue number	D1	D	D3	Ap1 max	L3	L	Re	KCSM15
6929435	H1TE4RA0400E011HAR025M	4,00	6,00	3,76	11,00	15,00	57,00	0,25	●
6929436	H1TE4RA0400E011HAR050M	4,00	6,00	3,76	11,00	15,00	57,00	0,50	●
6929439	H1TE4RA0600E013HAR050M	6,00	6,00	5,64	13,00	32,00	70,00	0,50	●
6929440	H1TE4RA0600E013HAR100M	6,00	6,00	5,64	13,00	32,00	70,00	1,00	●
6929443	H1TE4RA0800E019HAR050M	8,00	8,00	7,52	19,00	40,00	76,00	0,50	●
6929444	H1TE4RA0800E019HAR100M	8,00	8,00	7,52	19,00	40,00	76,00	1,00	●
6929447	H1TE4RA1000E022HAR050M	10,00	10,00	9,40	22,00	58,00	100,00	0,50	●
6929448	H1TE4RA1000E022HAR100M	10,00	10,00	9,40	22,00	58,00	100,00	1,00	●
6929449	H1TE4RA1000E022HAR200M	10,00	10,00	9,40	22,00	58,00	100,00	2,00	●
6929450	H1TE4RA1000E022HAR250M	10,00	10,00	9,40	22,00	58,00	100,00	2,50	●
6929451	H1TE4RA1000E022HAR300M	10,00	10,00	9,40	22,00	58,00	100,00	3,00	●
6929452	H1TE4RA1000E022HAR400M	10,00	10,00	9,40	22,00	58,00	100,00	4,00	●
6929459	H1TE4RA1200E026HAR050M	12,00	12,00	11,28	26,00	53,00	100,00	0,50	●
6929460	H1TE4RA1200E026HAR100M	12,00	12,00	11,28	26,00	53,00	100,00	1,00	●
6929461	H1TE4RA1200E026HAR200M	12,00	12,00	11,28	26,00	53,00	100,00	2,00	●
6929462	H1TE4RA1200E026HAR250M	12,00	12,00	11,28	26,00	53,00	100,00	2,50	●
6929463	H1TE4RA1200E026HAR300M	12,00	12,00	11,28	26,00	53,00	100,00	3,00	●
6929464	H1TE4RA1200E026HAR400M	12,00	12,00	11,28	26,00	53,00	100,00	4,00	●
6929471	H1TE4RA1600E032HAR050M	16,00	16,00	15,04	32,00	73,00	125,00	0,50	●
6929472	H1TE4RA1600E032HAR100M	16,00	16,00	15,04	32,00	73,00	125,00	1,00	●
6929473	H1TE4RA1600E032HAR200M	16,00	16,00	15,04	32,00	73,00	125,00	2,00	●
6929474	H1TE4RA1600E032HAR250M	16,00	16,00	15,04	32,00	73,00	125,00	2,50	●
6929475	H1TE4RA1600E032HAR300M	16,00	16,00	15,04	32,00	73,00	125,00	3,00	●
6929476	H1TE4RA1600E032HAR400M	16,00	16,00	15,04	32,00	73,00	125,00	4,00	●
6929477	H1TE4RA1600E032HAR600M	16,00	16,00	15,04	32,00	73,00	125,00	6,00	●
6929485	H1TE4RA2000E038HAR050M	20,00	20,00	18,80	38,00	73,00	125,00	0,50	●
6929486	H1TE4RA2000E038HAR100M	20,00	20,00	18,80	38,00	73,00	125,00	1,00	●
6929487	H1TE4RA2000E038HAR200M	20,00	20,00	18,80	38,00	73,00	125,00	2,00	●
6929488	H1TE4RA2000E038HAR250M	20,00	20,00	18,80	38,00	73,00	125,00	2,50	●
6929489	H1TE4RA2000E038HAR300M	20,00	20,00	18,80	38,00	73,00	125,00	3,00	●
6929490	H1TE4RA2000E038HAR400M	20,00	20,00	18,80	38,00	73,00	125,00	4,00	●
6929491	H1TE4RA2000E038HAR600M	20,00	20,00	18,80	38,00	73,00	125,00	6,00	●
6929499	H1TE4RA2500E045HAR050M	25,00	25,00	24,00	45,00	75,00	135,00	0,50	●
6929500	H1TE4RA2500E045HAR100M	25,00	25,00	24,00	45,00	75,00	135,00	1,00	●
6929501	H1TE4RA2500E045HAR200M	25,00	25,00	24,00	45,00	75,00	135,00	2,00	●
6929502	H1TE4RA2500E045HAR250M	25,00	25,00	24,00	45,00	75,00	135,00	2,50	●
6929503	H1TE4RA2500E045HAR300M	25,00	25,00	24,00	45,00	75,00	135,00	3,00	●
6929504	H1TE4RA2500E045HAR400M	25,00	25,00	24,00	45,00	75,00	135,00	4,00	●
6929505	H1TE4RA2500E045HAR600M	25,00	25,00	24,00	45,00	75,00	135,00	6,00	●

162-163	164	117-119	168

HARVI™ I TE • Radiused • 4 Flutes • Extended Neck • Weldon® Shank • Metric

- first choice
- alternate choice

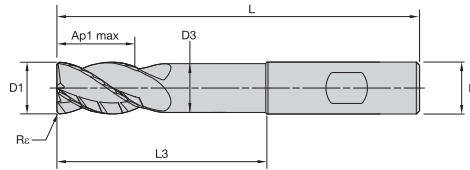

P	●
M	●
K	○
N	○
S	●
H	○
	○

order number	catalogue number	D1	D	D3	Ap1 max	L3	L	Rc	KCSM15
6929437	H1TE4RA0400E011HBR025M	4,00	6,00	3,76	11,00	15,00	57,00	0,25	●
6929438	H1TE4RA0400E011HBR050M	4,00	6,00	3,76	11,00	15,00	57,00	0,50	●
6929441	H1TE4RA0600E013HBR050M	6,00	6,00	5,64	13,00	32,00	70,00	0,50	●
6929442	H1TE4RA0600E013HBR100M	6,00	6,00	5,64	13,00	32,00	70,00	1,00	●
6929445	H1TE4RA0800E019HBR050M	8,00	8,00	7,52	19,00	40,00	76,00	0,50	●
6929446	H1TE4RA0800E019HBR100M	8,00	8,00	7,52	19,00	40,00	76,00	1,00	●
6929453	H1TE4RA1000E022HBR050M	10,00	10,00	9,40	22,00	58,00	100,00	0,50	●
6929454	H1TE4RA1000E022HBR100M	10,00	10,00	9,40	22,00	58,00	100,00	1,00	●
6929455	H1TE4RA1000E022HBR200M	10,00	10,00	9,40	22,00	58,00	100,00	2,00	●
6929456	H1TE4RA1000E022HBR250M	10,00	10,00	9,40	22,00	58,00	100,00	2,50	●
6929457	H1TE4RA1000E022HBR300M	10,00	10,00	9,40	22,00	58,00	100,00	3,00	●
6929458	H1TE4RA1000E022HBR400M	10,00	10,00	9,40	22,00	58,00	100,00	4,00	●
6929465	H1TE4RA1200E026HBR050M	12,00	12,00	11,28	26,00	53,00	100,00	0,50	●
6929466	H1TE4RA1200E026HBR100M	12,00	12,00	11,28	26,00	53,00	100,00	1,00	●
6929467	H1TE4RA1200E026HBR200M	12,00	12,00	11,28	26,00	53,00	100,00	2,00	●
6929468	H1TE4RA1200E026HBR250M	12,00	12,00	11,28	26,00	53,00	100,00	2,50	●
6929469	H1TE4RA1200E026HBR300M	12,00	12,00	11,28	26,00	53,00	100,00	3,00	●
6929470	H1TE4RA1200E026HBR400M	12,00	12,00	11,28	26,00	53,00	100,00	4,00	●
6929478	H1TE4RA1600E032HBR050M	16,00	16,00	15,04	32,00	73,00	125,00	0,50	●
6929479	H1TE4RA1600E032HBR100M	16,00	16,00	15,04	32,00	73,00	125,00	1,00	●
6929480	H1TE4RA1600E032HBR200M	16,00	16,00	15,04	32,00	73,00	125,00	2,00	●
6929481	H1TE4RA1600E032HBR250M	16,00	16,00	15,04	32,00	73,00	125,00	2,50	●
6929482	H1TE4RA1600E032HBR300M	16,00	16,00	15,04	32,00	73,00	125,00	3,00	●
6929483	H1TE4RA1600E032HBR400M	16,00	16,00	15,04	32,00	73,00	125,00	4,00	●
6929484	H1TE4RA1600E032HBR600M	16,00	16,00	15,04	32,00	73,00	125,00	6,00	●
6929492	H1TE4RA2000E038HBR050M	20,00	20,00	18,80	38,00	73,00	125,00	0,50	●
6929493	H1TE4RA2000E038HBR100M	20,00	20,00	18,80	38,00	73,00	125,00	1,00	●
6929494	H1TE4RA2000E038HBR200M	20,00	20,00	18,80	38,00	73,00	125,00	2,00	●
6929495	H1TE4RA2000E038HBR250M	20,00	20,00	18,80	38,00	73,00	125,00	2,50	●
6929496	H1TE4RA2000E038HBR300M	20,00	20,00	18,80	38,00	73,00	125,00	3,00	●
6929497	H1TE4RA2000E038HBR400M	20,00	20,00	18,80	38,00	73,00	125,00	4,00	●
6929498	H1TE4RA2000E038HBR600M	20,00	20,00	18,80	38,00	73,00	125,00	6,00	●
6929506	H1TE4RA2500E045HBR050M	25,00	25,00	24,00	45,00	75,00	135,00	0,50	●
6929507	H1TE4RA2500E045HBR100M	25,00	25,00	24,00	45,00	75,00	135,00	1,00	●
6929508	H1TE4RA2500E045HBR200M	25,00	25,00	24,00	45,00	75,00	135,00	2,00	●
6929509	H1TE4RA2500E045HBR250M	25,00	25,00	24,00	45,00	75,00	135,00	2,50	●
6929510	H1TE4RA2500E045HBR300M	25,00	25,00	24,00	45,00	75,00	135,00	3,00	●
6929511	H1TE4RA2500E045HBR400M	25,00	25,00	24,00	45,00	75,00	135,00	4,00	●
6929512	H1TE4RA2500E045HBR600M	25,00	25,00	24,00	45,00	75,00	135,00	6,00	●

162-163	164	117-119	168

HARVI™ I TE • Radiused • 4 Flutes • Extended Neck • Safe-Lock™ Shank • Metric

- first choice
- alternate choice

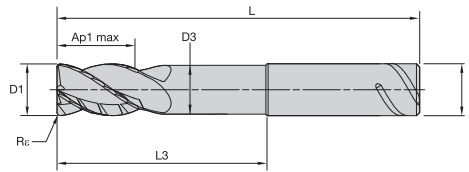

P	●
M	●
K	○
N	○
S	○
H	○

order number	catalogue number	D1	D	D3	Ap1 max	L3	L	Re	KCSM15
6929513	H1TE4RA1200E026SLR050M	12,00	12,00	11,28	26,00	53,00	100,00	0,50	●
6929514	H1TE4RA1200E026SLR100M	12,00	12,00	11,28	26,00	53,00	100,00	1,00	●
6929515	H1TE4RA1200E026SLR200M	12,00	12,00	11,28	26,00	53,00	100,00	2,00	●
6929516	H1TE4RA1200E026SLR250M	12,00	12,00	11,28	26,00	53,00	100,00	2,50	●
6929517	H1TE4RA1200E026SLR300M	12,00	12,00	11,28	26,00	53,00	100,00	3,00	●
6929518	H1TE4RA1200E026SLR400M	12,00	12,00	11,28	26,00	53,00	100,00	4,00	●
6929519	H1TE4RA1600E032SLR050M	16,00	16,00	15,04	32,00	73,00	125,00	0,50	●
6929520	H1TE4RA1600E032SLR100M	16,00	16,00	15,04	32,00	73,00	125,00	1,00	●
6929531	H1TE4RA1600E032SLR200M	16,00	16,00	15,04	32,00	73,00	125,00	2,00	●
6929532	H1TE4RA1600E032SLR250M	16,00	16,00	15,04	32,00	73,00	125,00	2,50	●
6929533	H1TE4RA1600E032SLR300M	16,00	16,00	15,04	32,00	73,00	125,00	3,00	●
6929534	H1TE4RA1600E032SLR400M	16,00	16,00	15,04	32,00	73,00	125,00	4,00	●
6929535	H1TE4RA1600E032SLR600M	16,00	16,00	15,04	32,00	73,00	125,00	6,00	●
6929536	H1TE4RA2000E038SLR050M	20,00	20,00	18,80	38,00	73,00	125,00	0,50	●
6929538	H1TE4RA2000E038SLR100M	20,00	20,00	18,80	38,00	73,00	125,00	1,00	●
6929539	H1TE4RA2000E038SLR200M	20,00	20,00	18,80	38,00	73,00	125,00	2,00	●
6929540	H1TE4RA2000E038SLR250M	20,00	20,00	18,80	38,00	73,00	125,00	2,50	●
6929541	H1TE4RA2000E038SLR300M	20,00	20,00	18,80	38,00	73,00	125,00	3,00	●
6929542	H1TE4RA2000E038SLR400M	20,00	20,00	18,80	38,00	73,00	125,00	4,00	●
6929543	H1TE4RA2000E038SLR600M	20,00	20,00	18,80	38,00	73,00	125,00	6,00	●
6929545	H1TE4RA2500E045SLR050M	25,00	25,00	24,00	45,00	75,00	135,00	0,50	●
6929546	H1TE4RA2500E045SLR100M	25,00	25,00	24,00	45,00	75,00	135,00	1,00	●
6929547	H1TE4RA2500E045SLR200M	25,00	25,00	24,00	45,00	75,00	135,00	2,00	●
6929548	H1TE4RA2500E045SLR250M	25,00	25,00	24,00	45,00	75,00	135,00	2,50	●
6929549	H1TE4RA2500E045SLR300M	25,00	25,00	24,00	45,00	75,00	135,00	3,00	●
6929550	H1TE4RA2500E045SLR400M	25,00	25,00	24,00	45,00	75,00	135,00	4,00	●
6929551	H1TE4RA2500E045SLR600M	25,00	25,00	24,00	45,00	75,00	135,00	6,00	●

162-163	164	117-119	168



HARVI™ I TE • Square End • 4 Flutes • Necked • Plain Shank • Metric

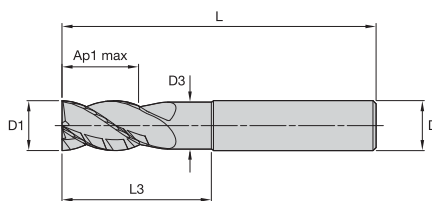

● first choice

○ alternate choice

P	●
M	●
K	●
N	●
S	○
H	○

order number	catalogue number	D1	D	D3	Ap1 max	L3	L	KCPM15
6769543	H1TE4SE0200N006HAM	2,00	6,00	—	6,00	—	57,00	●
6769544	H1TE4SE0250N006HAM	2,50	6,00	—	6,00	—	57,00	●
6769545	H1TE4SE0300N008HAM	3,00	6,00	2,82	8,00	16,00	57,00	●
6769546	H1TE4SE0350N010HAM	3,50	6,00	3,29	10,00	16,00	57,00	●
6769547	H1TE4SE0400N011HAM	4,00	6,00	3,76	11,00	16,00	57,00	●
6769548	H1TE4SE0500N013HAM	5,00	6,00	4,70	13,00	18,00	57,00	●
6769549	H1TE4SE0600N013HAM	6,00	6,00	5,64	13,00	18,00	57,00	●
6769563	H1TE4SE0800N016HAM	8,00	8,00	7,52	16,00	24,00	63,00	●
6769564	H1TE4SE1000N022HAM	10,00	10,00	9,40	22,00	30,00	72,00	●
6769565	H1TE4SE1200N026HAM	12,00	12,00	11,28	26,00	36,00	83,00	●
6769566	H1TE4SE1400N026HAM	14,00	14,00	13,16	26,00	42,00	83,00	●
6769567	H1TE4SE1600N032HAM	16,00	16,00	15,04	32,00	48,00	92,00	●
6769568	H1TE4SE1800N035HAM	18,00	18,00	16,92	35,00	54,00	92,00	●
6769569	H1TE4SE2000N038HAM	20,00	20,00	18,80	38,00	60,00	104,00	●
6769581	H1TE4SE2500N045HAM	25,00	25,00	24,00	45,00	75,00	121,00	●

HARVI I TE • Square End • 4 Flutes • Necked • Weldon® Shank • Metric

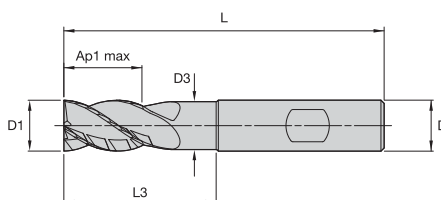
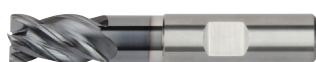

● first choice

○ alternate choice

P	●
M	●
K	●
N	●
S	○
H	○

order number	catalogue number	D1	D	D3	Ap1 max	L3	L	KCPM15
6769582	H1TE4SE0200N006HBM	2,00	6,00	—	6,00	—	57,00	●
6769583	H1TE4SE0250N006HBM	2,50	6,00	—	6,00	—	57,00	●
6769584	H1TE4SE0300N008HBM	3,00	6,00	2,82	8,00	16,00	57,00	●
6769585	H1TE4SE0350N010HBM	3,50	6,00	3,29	10,00	16,00	57,00	●
6769586	H1TE4SE0400N011HBM	4,00	6,00	3,76	11,00	16,00	57,00	●
6769587	H1TE4SE0500N013HBM	5,00	6,00	4,70	13,00	18,00	57,00	●
6769588	H1TE4SE0600N013HBM	6,00	6,00	5,64	13,00	18,00	57,00	●
6769589	H1TE4SE0800N016HBM	8,00	8,00	7,52	16,00	24,00	63,00	●
6769590	H1TE4SE1000N022HBM	10,00	10,00	9,40	22,00	30,00	72,00	●
6769591	H1TE4SE1200N026HBM	12,00	12,00	11,28	26,00	36,00	83,00	●
6769592	H1TE4SE1400N026HBM	14,00	14,00	13,16	26,00	42,00	83,00	●
6769593	H1TE4SE1600N032HBM	16,00	16,00	15,04	32,00	48,00	92,00	●
6769594	H1TE4SE1800N035HBM	18,00	18,00	16,92	35,00	54,00	92,00	●
6769595	H1TE4SE2000N038HBM	20,00	20,00	18,80	38,00	60,00	104,00	●
6769596	H1TE4SE2500N045HBM	25,00	25,00	24,00	45,00	75,00	121,00	●

162-163	164	117-119	168



HARVI™ I TE • Square End • 4 Flutes • Short • Plain Shank • Metric

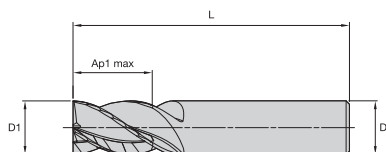

● first choice

○ alternate choice

P	●
M	●
K	●
N	●
S	○
H	○

order number	catalogue number	D1	D	Ap1 max	L	KCPM15
6769558	H1TE4SE0200S004HAM	2,00	6,00	4,00	54,00	●
6769559	H1TE4SE0250S005HAM	2,50	6,00	5,00	54,00	●
6769560	H1TE4SE0300S006HAM	3,00	6,00	6,00	54,00	●
6769681	H1TE4SE0350S007HAM	3,50	6,00	7,00	54,00	●
6769682	H1TE4SE0400S008HAM	4,00	6,00	8,00	54,00	●
6769683	H1TE4SE0500S009HAM	5,00	6,00	9,00	54,00	●
6769684	H1TE4SE0600S010HAM	6,00	6,00	10,00	54,00	●
6769685	H1TE4SE0800S012HAM	8,00	8,00	12,00	58,00	●
6769686	H1TE4SE1000S014HAM	10,00	10,00	14,00	66,00	●
6769687	H1TE4SE1200S016HAM	12,00	12,00	16,00	73,00	●
6769688	H1TE4SE1400S018HAM	14,00	14,00	18,00	75,00	●
6769689	H1TE4SE1600S022HAM	16,00	16,00	22,00	82,00	●
6769690	H1TE4SE1800S024HAM	18,00	18,00	24,00	92,00	●
6769701	H1TE4SE2000S026HAM	20,00	20,00	26,00	92,00	●
6769702	H1TE4SE2500S030HAM	25,00	25,00	30,00	121,00	●

HARVI I TE • Square End • 4 Flutes • Short • Weldon® Shank • Metric

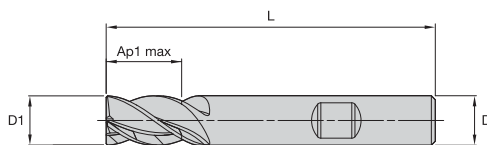

● first choice

○ alternate choice

P	●
M	●
K	●
N	●
S	○
H	○

order number	catalogue number	D1	D	Ap1 max	L	KCPM15
6769705	H1TE4SE0200S004HBM	2,00	6,00	4,00	54,00	●
6769706	H1TE4SE0250S005HBM	2,50	6,00	5,00	54,00	●
6769707	H1TE4SE0300S006HBM	3,00	6,00	6,00	54,00	●
6769708	H1TE4SE0350S007HBM	3,50	6,00	7,00	54,00	●
6769709	H1TE4SE0400S008HBM	4,00	6,00	8,00	54,00	●
6769710	H1TE4SE0500S009HBM	5,00	6,00	9,00	54,00	●
6769711	H1TE4SE0600S010HBM	6,00	6,00	10,00	54,00	●
6769712	H1TE4SE0800S012HBM	8,00	8,00	12,00	58,00	●
6769713	H1TE4SE1000S014HBM	10,00	10,00	14,00	66,00	●
6769714	H1TE4SE1200S016HBM	12,00	12,00	16,00	73,00	●
6769715	H1TE4SE1400S018HBM	14,00	14,00	18,00	75,00	●
6769716	H1TE4SE1600S022HBM	16,00	16,00	22,00	82,00	●
6769717	H1TE4SE1800S024HBM	18,00	18,00	24,00	92,00	●
6769718	H1TE4SE2000S026HBM	20,00	20,00	26,00	92,00	●
6769719	H1TE4SE2500S030HBM	25,00	25,00	30,00	121,00	●

162-163	164	117-119	168

HARVI™ I TE • Ball Nose • 4 Flutes • Necked • Plain Shank • Metric

● first choice
○ alternate choice

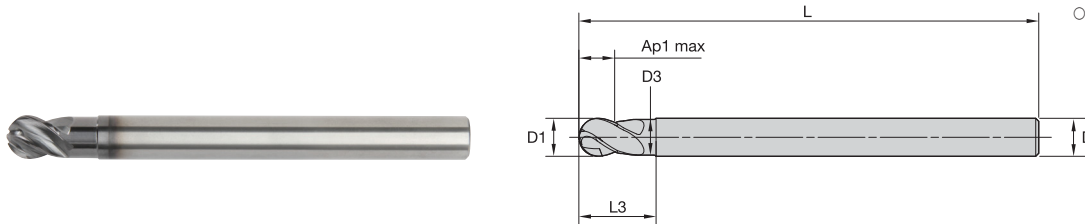

P	●
M	●
K	●
N	●
S	○
H	○

order number	catalogue number	D1	D	D3	Ap1 max	L3	L	KCPM15
6768005	H1TE4BN0200N002HAM	2,00	4,00	—	2,00	—	50,00	●
6768007	H1TE4BN0300N003HAM	3,00	4,00	2,82	3,00	6,00	50,00	●
6768008	H1TE4BN0400N004HAM	4,00	4,00	3,76	4,00	8,00	50,00	●
6768009	H1TE4BN0500N005HAM	5,00	6,00	4,70	5,00	10,00	63,00	●
6768010	H1TE4BN0600N006HAM	6,00	6,00	5,64	6,00	12,00	76,00	●
6768031	H1TE4BN0800N008HAM	8,00	8,00	7,52	8,00	16,00	100,00	●
6768032	H1TE4BN1000N010HAM	10,00	10,00	9,40	10,00	20,00	121,00	●
6768033	H1TE4BN1200N012HAM	12,00	12,00	11,28	12,00	24,00	125,00	●
6768034	H1TE4BN1600N016HAM	16,00	16,00	15,04	16,00	32,00	150,00	●
6768035	H1TE4BN2000N020HAM	20,00	20,00	18,80	20,00	40,00	166,00	●

HARVI I TE • Ball Nose • 4 Flutes • Long • Plain Shank • Metric

● first choice
○ alternate choice

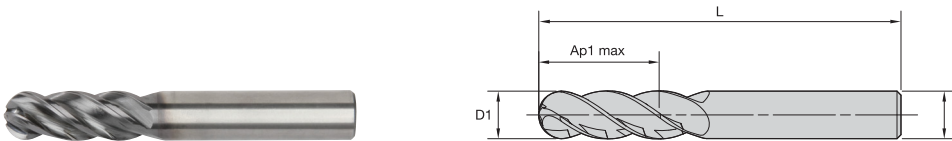

P	●
M	●
K	●
N	●
S	○
H	○

order number	catalogue number	D1	D	Ap1 max	L	KCPM15
6767984	H1TE4BN0200L005HAM	2,00	4,00	5,00	50,00	●
6767985	H1TE4BN0300L008HAM	3,00	4,00	8,00	50,00	●
6767986	H1TE4BN0400L010HAM	4,00	4,00	10,00	50,00	●
6767987	H1TE4BN0500L013HAM	5,00	6,00	13,00	55,00	●
6767988	H1TE4BN0600L015HAM	6,00	6,00	15,00	55,00	●
6767989	H1TE4BN0800L020HAM	8,00	8,00	20,00	63,00	●
6767990	H1TE4BN1000L025HAM	10,00	10,00	25,00	76,00	●
6768001	H1TE4BN1200L030HAM	12,00	12,00	30,00	83,00	●
6768003	H1TE4BN1600L040HAM	16,00	16,00	40,00	110,00	●
6768004	H1TE4BN2000L050HAM	20,00	20,00	50,00	150,00	●

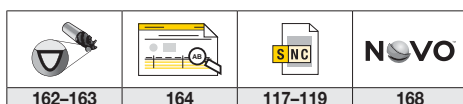

HARVI™ I TE • Side Milling/Slotting • Application Data • Metric



Material Group					KCPM15-KCSM15		Recommended feed per tooth (fz = mm/th) for side milling (A). For slotting (B), reduce fz by 20%.												
	A		B		Cutting Speed – vc m/min		D1 – Diameter												
	ap	ae	ap	min	max	mm	2,0	3,0	4,0	5,0	6,0	8,0	10,0	12,0	16,0	20,0	25,0		
P	0	1,5 x D1	0,5 x D1	1,25 x D1	150	–	200	fz	0,015	0,023	0,031	0,040	0,048	0,066	0,079	0,091	0,111	0,125	0,136
	1	1,5 x D1	0,5 x D1	1,25 x D1	150	–	200	fz	0,015	0,023	0,031	0,040	0,048	0,066	0,079	0,091	0,111	0,125	0,136
	2	1,5 x D1	0,5 x D1	1,25 x D1	140	–	190	fz	0,015	0,023	0,031	0,040	0,048	0,066	0,079	0,091	0,111	0,125	0,136
	3	1,5 x D1	0,5 x D1	1,25 x D1	120	–	160	fz	0,012	0,019	0,026	0,033	0,040	0,055	0,067	0,077	0,096	0,111	0,125
	4	1,5 x D1	0,5 x D1	1,25 x D1	90	–	150	fz	0,012	0,018	0,024	0,030	0,036	0,049	0,059	0,069	0,084	0,097	0,107
	5	1,5 x D1	0,5 x D1	1,25 x D1	60	–	100	fz	0,010	0,016	0,021	0,027	0,032	0,044	0,053	0,062	0,077	0,089	0,100
M	6	1,5 x D1	0,5 x D1	1,25 x D1	50	–	75	fz	0,009	0,013	0,018	0,022	0,027	0,037	0,044	0,051	0,063	0,071	0,078
	1	1,5 x D1	0,5 x D1	1,25 x D1	90	–	115	fz	0,012	0,019	0,026	0,033	0,040	0,055	0,067	0,077	0,096	0,111	0,125
	2	1,5 x D1	0,5 x D1	1,25 x D1	60	–	80	fz	0,010	0,016	0,021	0,027	0,032	0,044	0,053	0,062	0,077	0,089	0,100
K	3	1,5 x D1	0,5 x D1	1,0 x D1	60	–	70	fz	0,009	0,013	0,018	0,022	0,027	0,037	0,044	0,051	0,063	0,071	0,078
	1	1,5 x D1	0,5 x D1	1,0 x D1	120	–	150	fz	0,015	0,023	0,031	0,040	0,048	0,066	0,079	0,091	0,111	0,125	0,136
	2	1,5 x D1	0,5 x D1	1,0 x D1	110	–	140	fz	0,012	0,019	0,026	0,033	0,040	0,055	0,067	0,077	0,096	0,111	0,125
S	3	1,5 x D1	0,5 x D1	1,0 x D1	110	–	130	fz	0,010	0,016	0,021	0,027	0,032	0,044	0,053	0,062	0,077	0,089	0,100
	1	1,5 x D1	0,5 x D1	0,75 x D1	50	–	90	fz	0,012	0,019	0,026	0,033	0,040	0,055	0,067	0,077	0,096	0,111	0,125
	2	1,5 x D1	0,5 x D1	0,75 x D1	50	–	80	fz	0,010	0,016	0,021	0,027	0,032	0,044	0,053	0,062	0,077	0,089	0,100
	3	1,5 x D1	0,5 x D1	0,50 x D1	25	–	40	fz	0,007	0,010	0,014	0,018	0,021	0,029	0,035	0,041	0,051	0,059	0,067
H	4	1,5 x D1	0,5 x D1	1,25 x D1	50	–	60	fz	0,008	0,013	0,017	0,023	0,028	0,040	0,049	0,057	0,071	0,082	0,092
	1	1,5 x D1	0,5 x D1	1,0 x D1	80	–	140	fz	0,012	0,018	0,024	0,030	0,036	0,049	0,059	0,069	0,084	0,097	0,107
	2	1,5 x D1	0,5 x D1	1,0 x D1	70	–	120	fz	0,009	0,013	0,018	0,022	0,027	0,037	0,044	0,051	0,063	0,071	0,078

NOTE: Lower value of cutting speed is used for high stock removal applications or for higher hardness (machinability) within group.
Higher value of cutting speed is used for finishing applications or for lower hardness (machinability) within group.
Above parameters are based on ideal conditions.
For smaller taper machining centers, please adjust parameters accordingly on diameters greater than 12mm.
For tools with reach >4,5 x D, reduce Fz up to 30% and use lower range of cutting speed as starting condition.

Adjustment Factor for Feed and Speed Calculation • Metric

	Ae/D	2%	4%	5%	8%	10%	12%	20%	30%	40%	50%	100%
Speed factor	Kv	2,1–3,6	1,6–3	1,6–2,5	1,6	1,4	1,38	1,3	1,2	1,1	1	0,9
Feed factor	KFz	3,58	2,56	2,3	1,84	1,67	1,54	1,25	1,09	1,02	1	1

NOTE: For an Ae/D ratio of 5% or less there is a range given for speed factor Kv, which allows the user to either be more conservative at the lower value or more aggressive with the higher value.
This can also be considered based on the machinability of the material, from difficult to free cutting.
These calculations are for roughing/semi-finishing cuts when used with the recommended base Fz.
For light finishing cuts requiring improved surface quality it is recommended to reduce the base Fz approximately 50% and then apply these factors.

To calculate application-specific cutting data, please use Kv coefficient table above for adaptation of cutting speed and KFz for feed respectively.

$$Vc_{new} = Vc \cdot Kv$$

$$Fz_{new} = Fz \cdot KFz$$

Calculation example:

Application: D = 20mm;
M2 material group;
Ae = 2mm
Cutting data recommendation: Vc = 80 m/min;
Fz = 0,089 mm/th
Adjustment coefficients: Ae = 2mm equals 10,0%;
Kv = 1,4; KFz = 1,67

Final cutting data recommendation:

Vc new = 80 * 1,4 = 112 m/min
Fz new = 0,089 * 1,67 = 0,15 mm/min

HARVI™ I TE • Application Information • Ramping

Linear Ramping

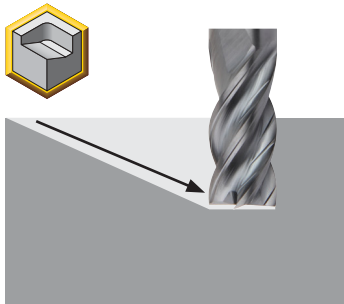

Helical Ramping

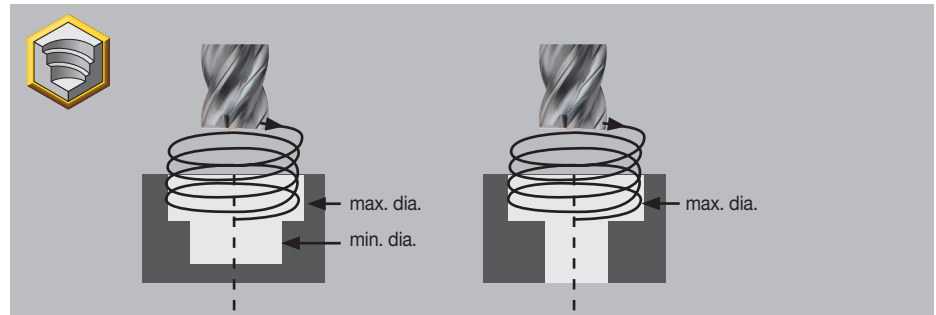

ATTENTION!

For helical ramping operations, the min. and max. hole diameter can be calculated with the following formula:

Min. hole Ø = End mill -Ø x 1,1 + 2x corner configuration (Re/CHF) size. Hole -Ø/End mill -Ø min 1:1,15

Max. hole Ø = 2x End mill -Ø 2x corner configuration (Re/CHF) size. Hole -Ø/End mill -Ø max 1:1,9

HARVI I TE • Ramping 0°-15° • Application Data • Metric



Material Group	Max Depth	Cutting Speed – vc m/min		Diameter – D1 [Ømin-Ømax] for helical interpolation															
		min	Start	max	mm	2,0	3,0	4,0	5,0	6,0	8,0	10,0	12,0	14,0	16,0	18,0	20,0	25,0	
		KCPM15-KCSM15			Recommended feed per tooth (fz = mm/z) for Helical Interpolation and Ramping – z _{eff} = 2														
P	0	1,25 x D1	150	175	200	fz	0,015	0,023	0,031	0,040	0,048	0,066	0,079	0,091	0,102	0,111	0,119	0,125	0,136
	1	1,25 x D1	150	175	200	fz	0,015	0,023	0,031	0,040	0,048	0,066	0,079	0,091	0,102	0,111	0,119	0,125	0,136
	2	1,25 x D1	140	165	190	fz	0,015	0,023	0,031	0,040	0,048	0,066	0,079	0,091	0,102	0,111	0,119	0,125	0,136
	3	1,25 x D1	120	140	160	fz	0,012	0,019	0,026	0,033	0,040	0,055	0,067	0,077	0,087	0,096	0,104	0,111	0,125
	4	1,25 x D1	90	120	150	fz	0,012	0,018	0,024	0,030	0,036	0,049	0,059	0,069	0,077	0,084	0,091	0,097	0,107
	5	1,25 x D1	60	80	100	fz	0,010	0,016	0,021	0,027	0,032	0,044	0,053	0,062	0,070	0,077	0,083	0,089	0,100
M	6	1,25 x D1	50	65	75	fz	0,009	0,013	0,018	0,022	0,027	0,037	0,044	0,051	0,057	0,063	0,067	0,071	0,078
	1	1,25 x D1	90	100	115	fz	0,012	0,019	0,026	0,033	0,040	0,055	0,067	0,077	0,087	0,096	0,104	0,111	0,125
	2	1,25 x D1	60	70	80	fz	0,010	0,016	0,021	0,027	0,032	0,044	0,053	0,062	0,070	0,077	0,083	0,089	0,100
K	3	1,0 x D1	60	65	70	fz	0,009	0,013	0,018	0,022	0,027	0,037	0,044	0,051	0,057	0,063	0,067	0,071	0,078
	1	1,0 x D1	120	135	150	fz	0,015	0,023	0,031	0,040	0,048	0,066	0,079	0,091	0,102	0,111	0,119	0,125	0,136
	2	1,0 x D1	110	125	140	fz	0,012	0,019	0,026	0,033	0,040	0,055	0,067	0,077	0,087	0,096	0,104	0,111	0,125
S	3	1,0 x D1	110	120	130	fz	0,010	0,016	0,021	0,027	0,032	0,044	0,053	0,062	0,070	0,077	0,083	0,089	0,100
	1	0,75 x D1	50	70	90	fz	0,012	0,019	0,026	0,033	0,040	0,055	0,067	0,077	0,087	0,096	0,104	0,111	0,125
	2	0,75 x D1	50	65	80	fz	0,010	0,016	0,021	0,027	0,032	0,044	0,053	0,062	0,070	0,077	0,083	0,089	0,100
	3	0,5 x D1	25	30	40	fz	0,007	0,010	0,014	0,018	0,021	0,029	0,035	0,041	0,046	0,051	0,055	0,059	0,067
H	4	1,25 x D1	50	55	60	fz	0,008	0,013	0,017	0,023	0,028	0,040	0,049	0,057	0,064	0,071	0,076	0,082	0,092
	1	1,0 x D1	80	110	140	fz	0,012	0,018	0,024	0,030	0,036	0,049	0,059	0,069	0,077	0,084	0,091	0,097	0,107
	2	1,0 x D1	70	90	120	fz	0,009	0,013	0,018	0,022	0,027	0,037	0,044	0,051	0,057	0,063	0,067	0,071	0,078

NOTE: Ø min and Ø max to be calculated with formula for helical ramping above.

HARVI™ I TE • Ramping 15°-30° • Application Data • Metric



Material Group	Max Depth	Cutting Speed – vc m/min		Diameter – D1 [Ømin–Ømax] for helical interpolation															
		min	Start	max	mm	2,0	3,0	4,0	5,0	6,0	8,0	10,0	12,0	14,0	16,0	18,0	20,0	25,0	
		<p>Recommended feed per tooth (fz = mm/z) for Helical Interpolation and Ramping – z_{eff} = 2</p> <p>KCPM15-KCSM15</p>																	
P	0	1,25 x D1	150	165	175	fz	0,011	0,017	0,023	0,030	0,036	0,050	0,059	0,068	0,076	0,083	0,089	0,094	0,102
	1	1,25 x D1	150	165	175	fz	0,011	0,017	0,023	0,030	0,036	0,050	0,059	0,068	0,076	0,083	0,089	0,094	0,102
	2	1,25 x D1	140	155	165	fz	0,011	0,017	0,023	0,030	0,036	0,050	0,059	0,068	0,076	0,083	0,089	0,094	0,102
	3	1,25 x D1	120	130	140	fz	0,009	0,014	0,019	0,025	0,030	0,041	0,050	0,058	0,065	0,072	0,078	0,083	0,094
	4	1,25 x D1	90	105	120	fz	0,009	0,013	0,018	0,022	0,027	0,037	0,045	0,051	0,058	0,063	0,068	0,073	0,080
	5	1,25 x D1	60	70	80	fz	0,008	0,012	0,016	0,020	0,024	0,033	0,040	0,046	0,052	0,058	0,062	0,067	0,075
M	1	1,25 x D1	90	95	100	fz	0,009	0,014	0,019	0,025	0,030	0,041	0,050	0,058	0,065	0,072	0,078	0,083	0,094
	2	1,25 x D1	60	65	70	fz	0,008	0,012	0,016	0,020	0,024	0,033	0,040	0,046	0,052	0,058	0,062	0,067	0,075
	3	1,0 x D1	60	62	65	fz	0,007	0,010	0,013	0,017	0,020	0,028	0,033	0,038	0,043	0,047	0,050	0,053	0,059
K	1	1,0 x D1	120	130	135	fz	0,011	0,017	0,023	0,030	0,036	0,050	0,059	0,068	0,076	0,083	0,089	0,094	0,102
	2	1,0 x D1	110	120	125	fz	0,009	0,014	0,019	0,025	0,030	0,041	0,050	0,058	0,065	0,072	0,078	0,083	0,094
	3	1,0 x D1	110	115	120	fz	0,008	0,012	0,016	0,020	0,024	0,033	0,040	0,046	0,052	0,058	0,062	0,067	0,075
S	1	0,75 x D1	50	60	70	fz	0,009	0,014	0,019	0,025	0,030	0,041	0,050	0,058	0,065	0,072	0,078	0,083	0,094
	2	0,75 x D1	50	55	65	fz	0,008	0,012	0,016	0,020	0,024	0,033	0,040	0,046	0,052	0,058	0,062	0,067	0,075
	3	0,5 x D1	25	27	30	fz	0,005	0,008	0,010	0,013	0,016	0,022	0,026	0,031	0,035	0,038	0,042	0,045	0,051
	4	1,25 x D1	50	52	55	fz	0,006	0,009	0,013	0,017	0,021	0,030	0,037	0,043	0,048	0,053	0,057	0,061	0,069
H	1	1,0 x D1	80	95	110	fz	0,009	0,013	0,018	0,022	0,027	0,037	0,045	0,051	0,058	0,063	0,068	0,073	0,080
	2	1,0 x D1	70	80	90	fz	0,007	0,010	0,013	0,017	0,020	0,028	0,033	0,038	0,043	0,047	0,050	0,053	0,059

NOTE: Ø min and Ø max to be calculated with formula for helical ramping above.

HARVI I TE • Ramping 30°-45° • Application Data • Metric





Material Group	Max Depth	Cutting Speed – vc m/min		Diameter – D1 [Ømin–Ømax] for helical interpolation															
		min	Start	max	mm	2,0	3,0	4,0	5,0	6,0	8,0	10,0	12,0	14,0	16,0	18,0	20,0	25,0	
		<p>Recommended feed per tooth (fz = mm/z) for Helical Interpolation and Ramping – z_{eff} = 2</p> <p>KCPM15-KCSM15</p>																	
P	0	1,25 x D1	140	150	165	fz	0,009	0,014	0,019	0,024	0,029	0,040	0,048	0,055	0,061	0,067	0,071	0,075	0,082
	1	1,25 x D1	140	150	165	fz	0,009	0,014	0,019	0,024	0,029	0,040	0,048	0,055	0,061	0,067	0,071	0,075	0,082
	2	1,25 x D1	140	150	165	fz	0,009	0,014	0,019	0,024	0,029	0,040	0,048	0,055	0,061	0,067	0,071	0,075	0,082
	3	1,25 x D1	105	115	120	fz	0,007	0,011	0,015	0,020	0,024	0,033	0,040	0,046	0,052	0,058	0,062	0,067	0,075
	4	1,25 x D1	90	100	110	fz	0,007	0,011	0,014	0,018	0,022	0,030	0,036	0,041	0,046	0,051	0,055	0,058	0,064
	5	1,25 x D1	70	75	80	fz	0,006	0,009	0,013	0,016	0,019	0,026	0,032	0,037	0,042	0,046	0,050	0,053	0,060
M	1	1,25 x D1	75	85	90	fz	0,007	0,011	0,015	0,020	0,024	0,033	0,040	0,046	0,052	0,058	0,062	0,067	0,075
	2	1,25 x D1	50	55	60	fz	0,006	0,009	0,013	0,016	0,019	0,026	0,032	0,037	0,042	0,046	0,050	0,053	0,060
	3	1,0 x D1	45	50	55	fz	0,005	0,008	0,011	0,013	0,016	0,022	0,027	0,031	0,034	0,038	0,040	0,043	0,047
K	1	1,0 x D1	110	120	130	fz	0,009	0,014	0,019	0,024	0,029	0,040	0,048	0,055	0,061	0,067	0,071	0,075	0,082
	2	1,0 x D1	100	110	120	fz	0,007	0,011	0,015	0,020	0,024	0,033	0,040	0,046	0,052	0,058	0,062	0,067	0,075
	3	1,0 x D1	90	100	110	fz	0,006	0,009	0,013	0,016	0,019	0,026	0,032	0,037	0,042	0,046	0,050	0,053	0,060
S	1	0,75 x D1	80	85	90	fz	0,007	0,011	0,015	0,020	0,024	0,033	0,040	0,046	0,052	0,058	0,062	0,067	0,075
	2	0,75 x D1	55	60	65	fz	0,006	0,009	0,013	0,016	0,019	0,026	0,032	0,037	0,042	0,046	0,050	0,053	0,060
	3	0,5 x D1	20	25	28	fz	0,004	0,006	0,008	0,011	0,013	0,017	0,021	0,025	0,028	0,031	0,033	0,036	0,040
	4	1,25 x D1	35	40	45	fz	0,005	0,008	0,010	0,014	0,017	0,024	0,029	0,034	0,038	0,042	0,046	0,049	0,055
H	1	1,0 x D1	75	80	85	fz	0,007	0,011	0,014	0,018	0,022	0,030	0,036	0,041	0,046	0,051	0,055	0,058	0,064
	2	1,0 x D1	65	70	75	fz	0,005	0,008	0,011	0,013	0,016	0,022	0,027	0,031	0,034	0,038	0,040	0,043	0,047

NOTE: Ø min and Ø max to be calculated with formula for helical ramping above.



HARVI™ I TE • Plunging/Drilling • Application Data • Metric



Material Group	 		KCPM15-KCSM15			Recommended feed per revolution (fn =mm/rev) for plunging and drilling															
	Max Depth	Applicable	Coolant	Cutting Speed – vc m/min			D1 – Diameter														
				min	Start	max	mm	2,0	3,0	4,0	5,0	6,0	8,0	10,0	12,0	14,0	16,0	18,0	20,0	25,0	
P	0	1,5 x D	●	Preferred	140	150	165	fn	0,028	0,033	0,040	0,045	0,055	0,065	0,080	0,095	0,110	0,120	0,140	0,160	0,180
	1	1,5 x D	●	Required	140	150	165	fn	0,028	0,033	0,040	0,045	0,055	0,065	0,080	0,095	0,110	0,120	0,140	0,160	0,180
	2	1,5 x D	●	Required	140	150	165	fn	0,028	0,033	0,040	0,045	0,055	0,065	0,080	0,095	0,110	0,120	0,140	0,160	0,180
	3	1 x D	●	Required	105	115	120	fn	0,015	0,020	0,028	0,033	0,040	0,050	0,060	0,070	0,085	0,100	0,110	0,125	0,150
	4	1 x D	●	Required	90	100	110	fn	0,015	0,020	0,028	0,033	0,040	0,050	0,060	0,070	0,085	0,100	0,110	0,125	0,150
	5	0,5 x D	●	Required	70	75	80	fn	0,010	0,014	0,018	0,020	0,025	0,035	0,040	0,050	0,055	0,065	0,075	0,085	0,100
M	6	0,5 x D	●	Required	55	60	65	fn	0,010	0,014	0,018	0,020	0,025	0,035	0,040	0,050	0,055	0,065	0,075	0,085	0,100
	1	0,75 x D	●	Required	75	85	90	fn	0,015	0,020	0,028	0,033	0,040	0,050	0,060	0,070	0,085	0,100	0,110	0,125	0,150
	2	0,5 x D	●	Required	50	55	60	fn	0,010	0,014	0,018	0,020	0,025	0,035	0,040	0,050	0,055	0,065	0,075	0,085	0,100
K	3	0,5 x D	●	Required	45	50	55	fn	0,010	0,014	0,018	0,020	0,025	0,035	0,040	0,050	0,055	0,065	0,075	0,085	0,100
	1	1,5 x D	●	Preferred	110	120	130	fn	0,028	0,033	0,040	0,045	0,055	0,065	0,080	0,095	0,110	0,120	0,140	0,160	0,180
	2	1 x D	●	Required	100	110	120	fn	0,015	0,020	0,028	0,033	0,040	0,050	0,060	0,070	0,085	0,100	0,110	0,125	0,150
S	3	1 x D	●	Required	90	100	110	fn	0,015	0,020	0,028	0,033	0,040	0,050	0,060	0,070	0,085	0,100	0,110	0,125	0,150
	1	0,3 x D	○	Required	80	85	90	fn	0,015	0,020	0,028	0,033	0,040	0,050	0,060	0,070	0,085	0,100	0,110	0,125	0,150
	2	0,1 x D	○	Required	55	60	65	fn	0,010	0,014	0,018	0,020	0,025	0,035	0,040	0,050	0,055	0,065	0,075	0,085	0,100
	3	0,1 x D	○	Required	20	25	28	fn	0,008	0,010	0,012	0,015	0,018	0,022	0,028	0,033	0,040	0,045	0,050	0,060	0,070
H	4	0,2 x D	○	Required	35	40	45	fn	0,010	0,014	0,018	0,020	0,025	0,035	0,040	0,050	0,055	0,065	0,075	0,085	0,100
	1	0,3 x D	○	Required	75	80	85	fn	0,015	0,020	0,028	0,033	0,040	0,050	0,060	0,070	0,085	0,100	0,110	0,125	0,150
	2	0,2 x D	○	Required	65	70	75	fn	0,010	0,014	0,018	0,020	0,025	0,035	0,040	0,050	0,065	0,075	0,085	0,100	

Application Recommendation for Surface Profiling with HARVI™ I TE

Not all four cutting edges reach the center of the HARVI I TE series ball nose end mill. Due to this, certain tilt angles will engage different numbers of cutting edges and can alter the required cutting parameters. This will also be altered by the depths of cut, which will change the contact area and resulting number of edges engaged.

When surface profiling with any ball nose end mill, optimum performance will be achieved by tilting away from the center of the tool if possible. This is due to the fact that at the tip of the tool only the center cutting edges exist (two in the case of HARVI I TE), and also the fact that the rotational velocity is zero in the center. Therefore, Kennametal recommends tilting the end mill to engage more cutting edges and avoid the zero-speed condition.

As the HARVI I series ball nose end mills do have two center cutting edges, it is possible to machine without tilting if the application requires this. Just factor in the reduced number of cutting edges into the cutting parameter calculations.



At the tip of the tool, only the center cutting edges exist.
The rotational velocity is zero in the center.



When surface profiling with any ball nose end mill, optimum performance will be achieved by tilting away from the center of the tool if possible

HARVI I TE Ball Nose



0°



24°



52°–55°

In the case of the HARVI I TE ball nose end mill, it is possible to take much larger depths of cut than other standard ball nose end mills.

Therefore, a large depth of cut can result in partial engagement of all four edges at small- or zero-tilt angles.

For tilt angles less than 24° and shallow profiling depths, only two cutting edges will be typically engaged.

As the end mill is tilted above this, then all four edges will at least be partially engaged.

For maximum profiling performance, a tilt angle of 52°–55° will result in full engagement of all edges with a wide range of cutting depths.

It is important then to decide if the cutting depth is small (profiling) and important to analyze the effect of tilt, or whether the cutting depth is large (roughing / slotting) and then the effect of tilt is minimized.

HARVI™ Series

High-Performance
Roughing and Finishing



Materials



Applications



Ramping



Slotting: Square End



Trochoidal Milling



Shoulder Milling



Profiling

Roughing and finishing in multiple materials.

Unequally spaced flutes to minimize vibrations and provide high tool life and superior surface quality. Safe-Lock™ shanks with pullout protection deliver increased process safety. Proprietary tapered-core design improves tool stability in roughing and finishing applications.

HARVI II

Five-flute end mill for high-feed roughing and finishing with one tool in multiple materials.

HARVI II Long

Five-flute end mill for semi-finishing and finishing of thin walls and deep pockets in titanium, steels, and stainless steels with excellent surface finishes.

HARVI™ II



Harvi II: Non-center cutting.

Harvi II Long: High feed rate capability for corner machining operations delivers additional productivity.

HARVI III



Harvi III & Harvi III Ball Nose: Tailored axial and radial rake angles result in lower cutting forces and lower pressure on cutting edge, providing smooth cutting action and best surface finishes.

Center cutting design enables radial and axial finishing pass after roughing operation.

Harvi III Taper Ball Nose: Six flutes in ball nose section and taper section for highest metal removal rates.

Taper angles of 4° and 6° for a broad range of applications.

HARVI III

Six-flute end mill for high-feed roughing and finishing with maximum metal removal rates in titanium and stainless steel with excellent surfaces.

HARVI III Ball Nose

Six-flute end mill for 3D profiling with highest productivity in titanium and stainless steel.

HARVI III Taper Ball Nose

Six-flute end mill for 5-axis machining of steel, stainless steel, nickel-based alloys, and titanium to significantly increase output and decrease machining time.

HARVI™ II • Radiused • 5 Flutes • Plain Shank • Metric

- first choice
- alternate choice

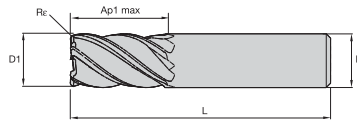
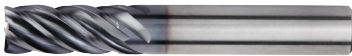

P	●	●
M	●	●
K	●	●
N	●	●
S	●	●
H	○	○

order number	catalogue number	D1	D	Ap1 max	L	Re	KCPM15	KC643M
3524411	UCDE0400A5ARA	4,00	6,00	11,00	55,00	0,25	●	●
4046284	UCDE0400A5ARA	4,00	6,00	11,00	55,00	0,25	●	●
3524433	UCDE0500A5ARA	5,00	6,00	13,00	57,00	0,25	●	●
4046288	UCDE0500A5ARA	5,00	6,00	13,00	57,00	0,25	●	●
3524435	UCDE0600A5ARA	6,00	6,00	13,00	57,00	0,40	●	●
4046291	UCDE0600A5ARA	6,00	6,00	13,00	57,00	0,40	●	●
3524437	UCDE0700A5ARA	7,00	8,00	16,00	63,00	0,40	●	●
4046374	UCDE0700A5ARA	7,00	8,00	16,00	63,00	0,40	●	●
3524439	UCDE0800A5ARA	8,00	8,00	19,00	63,00	0,50	●	●
4046377	UCDE0800A5ARA	8,00	8,00	19,00	63,00	0,50	●	●
3524441	UCDE0900A5ARA	9,00	10,00	19,00	72,00	0,50	●	●
4046380	UCDE0900A5ARA	9,00	10,00	19,00	72,00	0,50	●	●
3524443	UCDE1000A5ARA	10,00	10,00	22,00	72,00	0,50	●	●
4046383	UCDE1000A5ARA	10,00	10,00	22,00	72,00	0,50	●	●
3524445	UCDE1200A5ARA	12,00	12,00	26,00	83,00	0,75	●	●
4046386	UCDE1200A5ARA	12,00	12,00	26,00	83,00	0,75	●	●
3524447	UCDE1400A5ARA	14,00	14,00	26,00	83,00	0,75	●	●
4046389	UCDE1400A5ARA	14,00	14,00	26,00	83,00	0,75	●	●
3524449	UCDE1600A5ARA	16,00	16,00	32,00	92,00	0,75	●	●
4046392	UCDE1600A5ARA	16,00	16,00	32,00	92,00	0,75	●	●
3524451	UCDE1800A5ARA	18,00	18,00	32,00	92,00	0,75	●	●
4046395	UCDE1800A5ARA	18,00	18,00	32,00	92,00	0,75	●	●
3524453	UCDE2000A5ARA	20,00	20,00	38,00	104,00	0,75	●	●
4046398	UCDE2000A5ARA	20,00	20,00	38,00	104,00	0,75	●	●
3524455	UCDE2500A5ARA	25,00	25,00	45,00	121,00	0,75	●	●
4046401	UCDE2500A5ARA	25,00	25,00	45,00	121,00	0,75	●	●

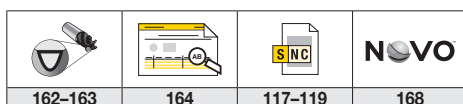

HARVI™ II • Radiused • 5 Flutes • Weldon® Shank • Metric

- first choice
- alternate choice

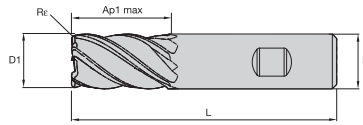
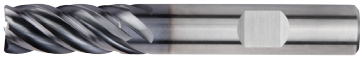

P	●	●
M	●	●
K	●	●
N	●	●
S	●	●
H	○	○

order number	catalogue number	D1	D	Ap1 max	L	Re	KCPM15	KC643M
3524462	UCDE0400B5ARA	4,00	6,00	11,00	55,00	0,25	●	●
4046286	UCDE0400B5ARA	4,00	6,00	11,00	55,00	0,25	●	●
3524473	UCDE0500B5ARA	5,00	6,00	13,00	57,00	0,25	●	●
4046290	UCDE0500B5ARA	5,00	6,00	13,00	57,00	0,25	●	●
3524474	UCDE0600B5ARA	6,00	6,00	13,00	57,00	0,40	●	●
4046373	UCDE0600B5ARA	6,00	6,00	13,00	57,00	0,40	●	●
3524475	UCDE0700B5ARA	7,00	8,00	16,00	63,00	0,40	●	●
4046376	UCDE0700B5ARA	7,00	8,00	16,00	63,00	0,40	●	●
3524476	UCDE0800B5ARA	8,00	8,00	19,00	63,00	0,50	●	●
4046379	UCDE0800B5ARA	8,00	8,00	19,00	63,00	0,50	●	●
4046382	UCDE0900B5ARA	9,00	10,00	19,00	72,00	0,50	●	●
3524478	UCDE1000B5ARA	10,00	10,00	22,00	72,00	0,50	●	●
4046385	UCDE1000B5ARA	10,00	10,00	22,00	72,00	0,50	●	●
3524479	UCDE1200B5ARA	12,00	12,00	26,00	83,00	0,75	●	●
4046388	UCDE1200B5ARA	12,00	12,00	26,00	83,00	0,75	●	●
3524480	UCDE1400B5ARA	14,00	14,00	26,00	83,00	0,75	●	●
4046391	UCDE1400B5ARA	14,00	14,00	26,00	83,00	0,75	●	●
3524481	UCDE1600B5ARA	16,00	16,00	32,00	92,00	0,75	●	●
4046394	UCDE1600B5ARA	16,00	16,00	32,00	92,00	0,75	●	●
3524482	UCDE1800B5ARA	18,00	18,00	32,00	92,00	0,75	●	●
4046397	UCDE1800B5ARA	18,00	18,00	32,00	92,00	0,75	●	●
3524483	UCDE2000B5ARA	20,00	20,00	38,00	104,00	0,75	●	●
4046400	UCDE2000B5ARA	20,00	20,00	38,00	104,00	0,75	●	●
3524484	UCDE2500B5ARA	25,00	25,00	45,00	121,00	0,75	●	●
4046403	UCDE2500B5ARA	25,00	25,00	45,00	121,00	0,75	●	●

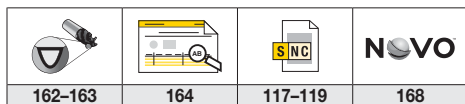

HARVI™ II • Square End • 5 Flutes • Plain Shank • Metric

- first choice
- alternate choice

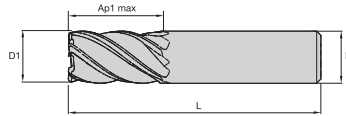
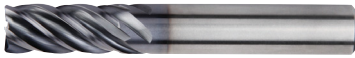

P	●	●
M	●	●
K	●	●
N	●	●
S	●	●
H	○	○

order number	catalogue number	D1	D	Ap1 max	L	KCPM15	KC643M
3524456	UCDE0400A5ASA	4,00	6,00	11,00	55,00	●	●
4046285	UCDE0400A5ASA	4,00	6,00	11,00	55,00	●	●
3524412	UCDE0500A5ASA	5,00	6,00	13,00	57,00	●	●
4046289	UCDE0500A5ASA	5,00	6,00	13,00	57,00	●	●
3524434	UCDE0600A5ASA	6,00	6,00	13,00	57,00	●	●
4046292	UCDE0600A5ASA	6,00	6,00	13,00	57,00	●	●
3524436	UCDE0700A5ASA	7,00	8,00	16,00	63,00	●	●
4046375	UCDE0700A5ASA	7,00	8,00	16,00	63,00	●	●
3524438	UCDE0800A5ASA	8,00	8,00	19,00	63,00	●	●
4046378	UCDE0800A5ASA	8,00	8,00	19,00	63,00	●	●
3524440	UCDE0900A5ASA	9,00	10,00	19,00	72,00	●	●
4046381	UCDE0900A5ASA	9,00	10,00	19,00	72,00	●	●
3524442	UCDE1000A5ASA	10,00	10,00	22,00	72,00	●	●
4046384	UCDE1000A5ASA	10,00	10,00	22,00	72,00	●	●
3524444	UCDE1200A5ASA	12,00	12,00	26,00	83,00	●	●
4046387	UCDE1200A5ASA	12,00	12,00	26,00	83,00	●	●
3524446	UCDE1400A5ASA	14,00	14,00	26,00	83,00	●	●
4046390	UCDE1400A5ASA	14,00	14,00	26,00	83,00	●	●
3524448	UCDE1600A5ASA	16,00	16,00	32,00	92,00	●	●
4046393	UCDE1600A5ASA	16,00	16,00	32,00	92,00	●	●
3524450	UCDE1800A5ASA	18,00	18,00	32,00	92,00	●	●
4046396	UCDE1800A5ASA	18,00	18,00	32,00	92,00	●	●
3524452	UCDE2000A5ASA	20,00	20,00	38,00	104,00	●	●
4046399	UCDE2000A5ASA	20,00	20,00	38,00	104,00	●	●
3524454	UCDE2500A5ASA	25,00	25,00	45,00	121,00	●	●
4046402	UCDE2500A5ASA	25,00	25,00	45,00	121,00	●	●

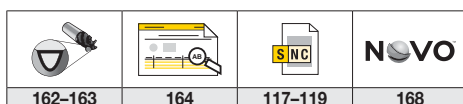

HARVI™ II • Radiused • 5 Flutes • Necked • Plain Shank • Metric

- first choice
- alternate choice

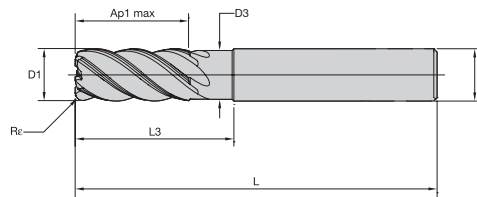

P	●
M	●
K	●
N	●
S	●
H	○

order number	catalogue number	D1	D	D3	Ap1 max	L3	L	Re	KC643M
3524486	UDDE0600A5ARA	6,00	6,00	5,64	13,00	18,00	63,00	0,50	●
3524487	UDDE0600A5ARB	6,00	6,00	5,64	13,00	18,00	63,00	1,00	●
3524488	UDDE0600A5ARC	6,00	6,00	5,64	13,00	18,00	63,00	1,50	●
3524490	UDDE0800A5ARA	8,00	8,00	7,52	19,00	24,00	76,00	0,50	●
3524491	UDDE0800A5ARB	8,00	8,00	7,52	19,00	24,00	76,00	1,00	●
3524492	UDDE0800A5ARC	8,00	8,00	7,52	19,00	24,00	76,00	2,00	●
3524514	UDDE1000A5ARA	10,00	10,00	9,40	22,00	30,00	76,00	0,50	●
3524515	UDDE1000A5ARB	10,00	10,00	9,40	22,00	30,00	76,00	1,00	●
3524516	UDDE1000A5ARC	10,00	10,00	9,40	22,00	30,00	76,00	2,00	●
3524517	UDDE1000A5ARD	10,00	10,00	9,40	22,00	30,00	76,00	2,50	●
3524520	UDDE1200A5ARB	12,00	12,00	11,28	26,00	36,00	83,00	1,00	●
3524521	UDDE1200A5ARC	12,00	12,00	11,28	26,00	36,00	83,00	2,00	●
3524522	UDDE1200A5ARD	12,00	12,00	11,28	26,00	36,00	83,00	3,00	●
3524519	UDDE1200A5ARA	12,00	12,00	11,28	26,00	36,00	84,00	0,50	●
3873932	UDDE1400A5ARA	14,00	14,00	13,15	26,00	42,00	84,00	0,50	●
3874034	UDDE1400A5ARC	14,00	14,00	13,15	26,00	42,00	84,00	2,00	●
3874035	UDDE1400A5ARD	14,00	14,00	13,15	26,00	42,00	84,00	3,00	●
3524524	UDDE1600A5ARA	16,00	16,00	15,04	32,00	48,00	100,00	0,50	●
3524525	UDDE1600A5ARB	16,00	16,00	15,04	32,00	48,00	100,00	1,00	●
3524526	UDDE1600A5ARC	16,00	16,00	15,04	32,00	48,00	100,00	2,00	●
3524527	UDDE1600A5ARD	16,00	16,00	15,04	32,00	48,00	100,00	3,00	●
3524528	UDDE1600A5ARE	16,00	16,00	15,04	32,00	48,00	100,00	4,00	●
6063443	UDDE1600A5ARP	16,00	16,00	15,04	32,00	48,00	100,00	6,00	●
3524530	UDDE2000A5ARA	20,00	20,00	18,80	38,00	60,00	115,00	0,50	●
3524531	UDDE2000A5ARB	20,00	20,00	18,80	38,00	60,00	115,00	1,00	●
3524532	UDDE2000A5ARC	20,00	20,00	18,80	38,00	60,00	115,00	2,00	●
3524533	UDDE2000A5ARD	20,00	20,00	18,80	38,00	60,00	115,00	3,00	●
3524534	UDDE2000A5ARE	20,00	20,00	18,80	38,00	60,00	115,00	4,00	●
6063444	UDDE2000A5ARP	20,00	20,00	18,80	38,00	60,00	115,00	6,00	●
3524536	UDDE2500A5ARA	25,00	25,00	23,50	45,00	75,00	135,00	0,50	●
3524537	UDDE2500A5ARB	25,00	25,00	23,50	45,00	75,00	135,00	1,00	●
3524538	UDDE2500A5ARC	25,00	25,00	23,50	45,00	75,00	135,00	2,00	●
3524539	UDDE2500A5ARD	25,00	25,00	23,50	45,00	75,00	135,00	3,00	●
3524540	UDDE2500A5ARE	25,00	25,00	23,50	45,00	75,00	135,00	4,00	●

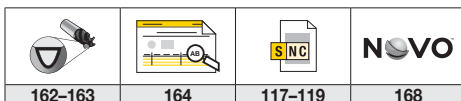

HARVI™ II • Radiused • 5 Flutes • Necked • Weldon® Shank • Metric

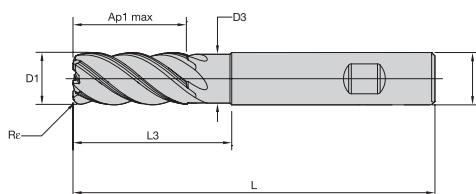

● first choice

○ alternate choice

P	■	●
M	■	●
K	■	●
N	■	●
S	■	●
H	■	○

order number	catalogue number	D1	D	D3	Ap1 max	L3	L	Re	KC643M
3524542	UDDE0600B5ARA	6,00	6,00	5,64	13,00	18,00	63,00	0,20	●
3524543	UDDE0600B5ARB	6,00	6,00	5,64	13,00	18,00	63,00	0,50	●
3524544	UDDE0600B5ARC	6,00	6,00	5,64	13,00	18,00	63,00	1,00	●
3524545	UDDE0600B5ARD	6,00	6,00	5,64	13,00	18,00	63,00	1,50	●
3524546	UDDE0800B5ARA	8,00	8,00	7,52	19,00	24,00	76,00	0,20	●
3524547	UDDE0800B5ARB	8,00	8,00	7,52	19,00	24,00	76,00	0,50	●
3524548	UDDE0800B5ARC	8,00	8,00	7,52	19,00	24,00	76,00	1,00	●
3524549	UDDE0800B5ARD	8,00	8,00	7,52	19,00	24,00	76,00	2,00	●
3524550	UDDE1000B5ARA	10,00	10,00	9,40	22,00	30,00	76,00	0,50	●
3524551	UDDE1000B5ARB	10,00	10,00	9,40	22,00	30,00	76,00	1,00	●
3524553	UDDE1000B5ARD	10,00	10,00	9,40	22,00	30,00	76,00	2,50	●
3524554	UDDE1200B5ARA	12,00	12,00	11,28	26,00	36,00	83,00	0,50	●
3524555	UDDE1200B5ARB	12,00	12,00	11,28	26,00	36,00	83,00	1,00	●
3524556	UDDE1200B5ARC	12,00	12,00	11,28	26,00	36,00	83,00	2,00	●
3524557	UDDE1200B5ARD	12,00	12,00	11,28	26,00	36,00	83,00	3,00	●
3874037	UDDE1400B5ARB	14,00	14,00	13,15	26,00	42,00	84,00	1,00	●
3524558	UDDE1600B5ARA	16,00	16,00	15,04	32,00	48,00	100,00	0,50	●
3524559	UDDE1600B5ARB	16,00	16,00	15,04	32,00	48,00	100,00	1,00	●
3524560	UDDE1600B5ARC	16,00	16,00	15,04	32,00	48,00	100,00	2,00	●
3524561	UDDE1600B5ARD	16,00	16,00	15,04	32,00	48,00	100,00	3,00	●
3524562	UDDE1600B5ARE	16,00	16,00	15,04	32,00	48,00	100,00	4,00	●
6064694	UDDE1600B5ARP	16,00	16,00	15,04	32,00	48,00	100,00	6,00	●
3524563	UDDE2000B5ARA	20,00	20,00	18,80	38,00	60,00	115,00	0,50	●
3524564	UDDE2000B5ARB	20,00	20,00	18,80	38,00	60,00	115,00	1,00	●
3524565	UDDE2000B5ARC	20,00	20,00	18,80	38,00	60,00	115,00	2,00	●
3524566	UDDE2000B5ARD	20,00	20,00	18,80	38,00	60,00	115,00	3,00	●
3524567	UDDE2000B5ARE	20,00	20,00	18,80	38,00	60,00	115,00	4,00	●
6064695	UDDE2000B5ARP	20,00	20,00	18,80	38,00	60,00	115,00	6,00	●
3524568	UDDE2500B5ARA	25,00	25,00	23,50	45,00	75,00	135,00	0,50	●
3524569	UDDE2500B5ARB	25,00	25,00	23,50	45,00	75,00	135,00	1,00	●
3524570	UDDE2500B5ARC	25,00	25,00	23,50	45,00	75,00	135,00	2,00	●
3524571	UDDE2500B5ARD	25,00	25,00	23,50	45,00	75,00	135,00	3,00	●
3524572	UDDE2500B5ARE	25,00	25,00	23,50	45,00	75,00	135,00	4,00	●
6064696	UDDE2500B5ARP	25,00	25,00	23,50	45,00	75,00	135,00	6,00	●

HARVI II • Radiused • 5 Flutes • Necked • Safe-Lock™ Shank • Metric

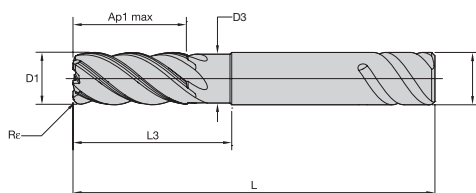

● first choice

○ alternate choice

P	■	●
M	■	●
K	■	●
N	■	●
S	■	●
H	■	○

order number	catalogue number	D1	D	D3	Ap1 max	L3	L	Re	KCSM15
5358354	UDDE1200E5AQE	12,00	12,00	11,28	26,00	36,00	83,00	0,50	●
5358358	UDDE1600E5AQE	16,00	16,00	15,04	32,00	48,00	100,00	0,50	●
5358359	UDDE1600E5AQQ	16,00	16,00	15,04	32,00	48,00	100,00	1,00	●
5358390	UDDE1600E5AQQ	16,00	16,00	15,04	32,00	48,00	100,00	2,00	●
5358394	UDDE2000E5AQE	20,00	20,00	18,80	38,00	60,00	115,00	0,50	●
5358399	UDDE2500E5AQE	25,00	25,00	23,50	45,00	75,00	135,00	0,50	●

HARVI™ II • Square End • 5 Flutes • Necked • Plain Shank • Metric

- first choice
- alternate choice

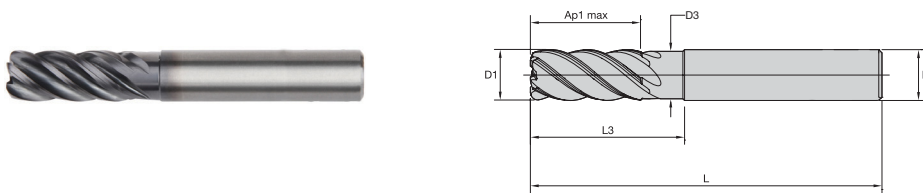

P	●
M	●
K	●
N	●
S	●
H	○

order number	catalogue number	D1	D	D3	Ap1 max	L3	L	
3524485	UDDE0600A5ASA	6,00	6,00	5,64	13,00	18,00	63,00	●
3524489	UDDE0800A5ASA	8,00	8,00	7,52	19,00	24,00	76,00	●
3524513	UDDE1000A5ASA	10,00	10,00	9,40	22,00	30,00	76,00	●
3524518	UDDE1200A5ASA	12,00	12,00	11,28	26,00	36,00	83,00	●
3873931	UDDE1400A5ASA	14,00	14,00	13,15	26,00	42,00	84,00	●
3524523	UDDE1600A5ASA	16,00	16,00	15,04	32,00	48,00	100,00	●
3524529	UDDE2000A5ASA	20,00	20,00	18,80	38,00	60,00	115,00	●

KC643M

HARVI III • Radiused • 6 Flutes • Plain Shank • Metric

- first choice
- alternate choice

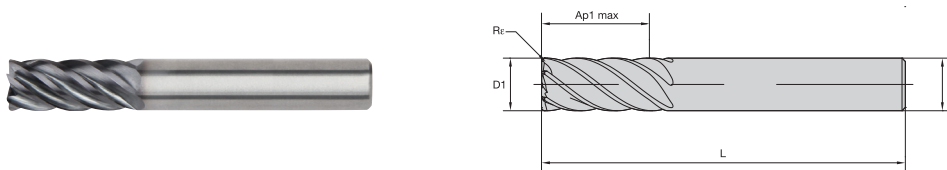

P	○
M	●
K	●
N	●
S	●
H	○

order number	catalogue number	D1	D	Ap1 max	L	Re	
5350287	UJDE1000A6ARE	10,00	10,00	22,00	72,00	0,50	●
5350324	UJDE1200A6ARF	12,00	12,00	26,00	83,00	0,75	●
5350336	UJDE1400A6ARF	14,00	14,00	26,00	83,00	0,75	●
5350339	UJDE1600A6ARF	16,00	16,00	32,00	92,00	0,75	●
5350613	UJDE2000A6ARF	20,00	20,00	38,00	104,00	0,75	●
5350649	UJDE2500A6ARF	25,00	25,00	45,00	121,00	0,75	●

KCSM15

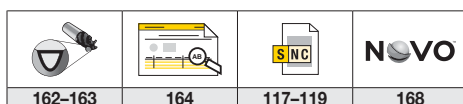

HARVI™ III • Radiused • 6 Flutes • Safe-Lock™ Shank • Metric

- first choice
- alternate choice

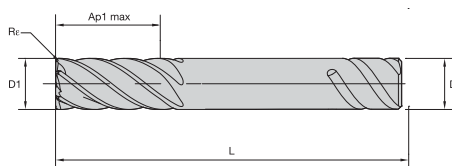

P	●
M	●
K	●
N	●
S	●
H	○

order number	catalogue number	D1	D	Ap1 max	L	Re	KCSM15
5350326	UJDE1200E6ARF	12,00	12,00	26,00	83,00	0,75	●
5350340	UJDE1600E6ARF	16,00	16,00	32,00	92,00	0,75	●
5350615	UJDE2000E6ARF	20,00	20,00	38,00	104,00	0,75	●
5350650	UJDE2500E6ARF	25,00	25,00	45,00	121,00	0,75	●

HARVI III • Square End • 6 Flutes • Plain Shank • Metric

- first choice
- alternate choice

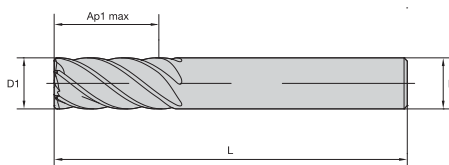

P	●
M	●
K	●
N	●
S	●
H	○

order number	catalogue number	D1	D	Ap1 max	L	KCSM15
5350288	UJDE1000A6AS	10,00	10,00	22,00	72,00	●
5350325	UJDE1200A6AS	12,00	12,00	26,00	83,00	●
5350338	UJDE1400A6AS	14,00	14,00	26,00	83,00	●
5350341	UJDE1600A6AS	16,00	16,00	32,00	92,00	●
5350616	UJDE2000A6AS	20,00	20,00	38,00	104,00	●
5350651	UJDE2500A6AS	25,00	25,00	45,00	121,00	●

162-163	164	117-119	168

HARVI™ III • Radiused • 6 Flutes • Necked • Plain Shank • Metric

- first choice
- alternate choice

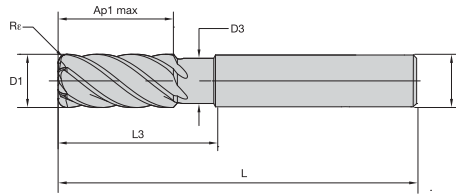

P	●
M	●
K	●
N	●
S	●
H	○

order number	catalogue number	D1	D	D3	Ap1 max	L3	L	R _ε	KCSM15
5350289	UJDE1000A6AQE	10,00	10,00	9,40	22,00	30,00	76,00	0,50	●
5350320	UJDE1000A6AQG	10,00	10,00	9,40	22,00	30,00	76,00	1,00	●
5350321	UJDE1000A6AQK	10,00	10,00	9,40	22,00	30,00	76,00	2,00	●
5350327	UJDE1200A6AQE	12,00	12,00	11,28	26,00	36,00	83,00	0,50	●
5350328	UJDE1200A6AQG	12,00	12,00	11,28	26,00	36,00	83,00	1,00	●
5350329	UJDE1200A6AQK	12,00	12,00	11,28	26,00	36,00	83,00	2,00	●
5350330	UJDE1200A6AQM	12,00	12,00	11,28	26,00	36,00	83,00	3,00	●
5350342	UJDE1600A6AQE	16,00	16,00	15,04	32,00	48,00	100,00	0,50	●
5350343	UJDE1600A6AQG	16,00	16,00	15,04	32,00	48,00	100,00	1,00	●
5350344	UJDE1600A6AQK	16,00	16,00	15,04	32,00	48,00	100,00	2,00	●
5350345	UJDE1600A6AQM	16,00	16,00	15,04	32,00	48,00	100,00	3,00	●
5350346	UJDE1600A6AQN	16,00	16,00	15,04	32,00	48,00	100,00	4,00	●
6063446	UJDE1600A6AQP	16,00	16,00	15,04	32,00	48,00	100,00	6,00	●
5350617	UJDE2000A6AQE	20,00	20,00	18,80	38,00	60,00	115,00	0,50	●
5350618	UJDE2000A6AQG	20,00	20,00	18,80	38,00	60,00	115,00	1,00	●
5350619	UJDE2000A6AQK	20,00	20,00	18,80	38,00	60,00	115,00	2,00	●
5350640	UJDE2000A6AQM	20,00	20,00	18,80	38,00	60,00	115,00	3,00	●
5350641	UJDE2000A6AQN	20,00	20,00	18,80	38,00	60,00	115,00	4,00	●
6063447	UJDE2000A6AQP	20,00	20,00	18,80	38,00	60,00	115,00	6,00	●
5350653	UJDE2500A6AQG	25,00	25,00	23,50	45,00	75,00	135,00	1,00	●
5350655	UJDE2500A6AQM	25,00	25,00	23,50	45,00	75,00	135,00	3,00	●
5350656	UJDE2500A6AQN	25,00	25,00	23,50	45,00	75,00	135,00	4,00	●

HARVI III • Radiused • 6 Flutes • Necked • Safe-Lock™ Shank • Metric

- first choice
- alternate choice

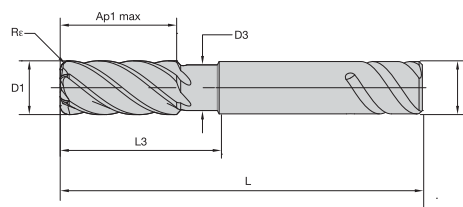

P	●
M	●
K	●
N	●
S	●
H	○

order number	catalogue number	D1	D	D3	Ap1 max	L3	L	R _ε	KCSM15
5350332	UJDE1200E6AQE	12,00	12,00	11,28	26,00	36,00	83,00	0,50	●
5350333	UJDE1200E6AQG	12,00	12,00	11,28	26,00	36,00	83,00	1,00	●
5350348	UJDE1600E6AQE	16,00	16,00	15,04	32,00	48,00	100,00	0,50	●
5350349	UJDE1600E6AQG	16,00	16,00	15,04	32,00	48,00	100,00	1,00	●
5350350	UJDE1600E6AQK	16,00	16,00	15,04	32,00	48,00	100,00	2,00	●
5350352	UJDE1600E6AQN	16,00	16,00	15,04	32,00	48,00	100,00	4,00	●
5350644	UJDE2000E6AQE	20,00	20,00	18,80	38,00	60,00	115,00	0,50	●
5350645	UJDE2000E6AQG	20,00	20,00	18,80	38,00	60,00	115,00	1,00	●
5350646	UJDE2000E6AQK	20,00	20,00	18,80	38,00	60,00	115,00	2,00	●
5350648	UJDE2000E6AQN	20,00	20,00	18,80	38,00	60,00	115,00	4,00	●
5350658	UJDE2500E6AQE	25,00	25,00	23,50	45,00	75,00	135,00	0,50	●
5350662	UJDE2500E6AQN	25,00	25,00	23,50	45,00	75,00	135,00	4,00	●

162-163	164	117-119	168

HARVI™ III • Square End • 6 Flutes • Necked • Plain Shank • Metric

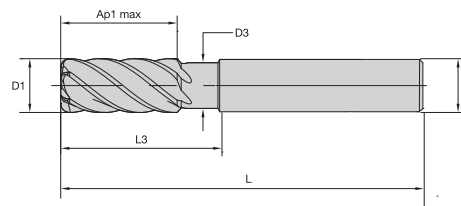

- first choice
- alternate choice

P	●
M	●
K	●
N	●
S	●
H	○

order number	catalogue number	D1	D	D3	Ap1 max	L3	L	KCSM15
5350323	UJDE1000A6ANS	10,00	10,00	9,40	22,00	30,00	76,00	●
5350331	UJDE1200A6ANS	12,00	12,00	11,28	26,00	36,00	83,00	●
5350347	UJDE1600A6ANS	16,00	16,00	15,04	32,00	48,00	100,00	●
5350642	UJDE2000A6ANS	20,00	20,00	18,80	38,00	60,00	115,00	●

HARVI III • Ball Nose • 6 Flutes • Plain Shank • Metric

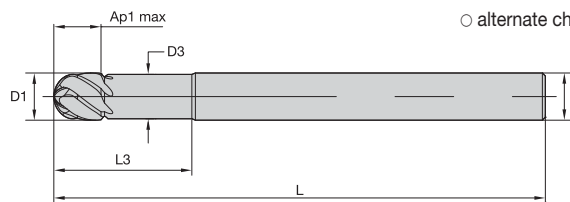

- first choice
- alternate choice

P	●
M	●
K	●
N	●
S	●
H	○

order number	catalogue number	D1	D	D3	Ap1 max	L3	L	KCSM15
5606546	UJBE1000A6AN	10,00	10,00	9,40	10,00	30,00	72,00	●
5606542	UJBE1000A6AL	10,00	10,00	9,40	10,00	30,00	121,50	●
5606547	UJBE1200A6AN	12,00	12,00	11,28	12,00	36,00	83,00	●
5606543	UJBE1200A6AL	12,00	12,00	11,28	12,00	36,00	125,00	●
5606548	UJBE1600A6AN	16,00	16,00	15,04	16,00	48,00	100,00	●
5606544	UJBE1600A6AL	16,00	16,00	15,04	16,00	48,00	150,00	●
5606549	UJBE2000A6AN	20,00	20,00	18,80	20,00	60,00	115,00	●
5606545	UJBE2000A6AL	20,00	20,00	18,80	20,00	60,00	150,00	●

162-163	164	117-119	168

HARVI™ III • Taper Ball Nose • 6 Flutes • Plain Shank • Metric

- first choice
- alternate choice

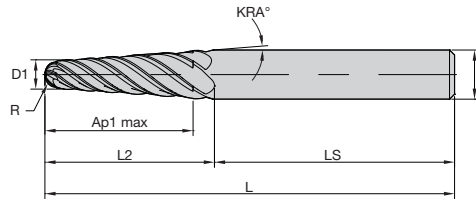
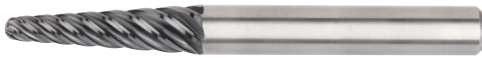

P	●
M	●
K	●
N	●
S	●
H	○

order number	catalogue number	D1	D	Ap1 max	L2	LS	L	R	KRA	KCSM15
5970180	UJBE0400A6CP	4,00	8,00	26,00	30,53	45,47	76,00	2,00	4,00	●
5970211	UJBE0400A6BP	4,00	10,00	25,00	30,44	58,56	89,00	2,00	6,00	●
5970212	UJBE0500A6CP	5,00	10,00	33,00	38,16	50,84	89,00	2,50	4,00	●
5970213	UJBE0500A6BP	5,00	12,00	29,00	35,67	64,33	100,00	2,50	6,00	●
5970214	UJBE0600A6BP	6,00	12,00	39,00	45,80	54,20	100,00	3,00	4,00	●
5970215	UJBE0600A6CP	6,00	16,00	42,00	50,42	59,59	110,00	3,00	6,00	●
5970218	UJBE0800A6CP	8,00	14,00	39,00	46,76	53,24	100,00	4,00	4,00	●
5970221	UJBE1000A6BP	10,00	16,00	25,00	33,28	76,72	110,00	5,00	6,00	●
5970220	UJBE1000A6CP	10,00	16,00	39,00	47,73	62,27	110,00	5,00	4,00	●

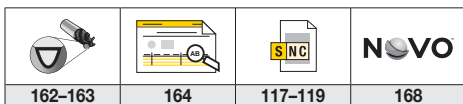

HARVI™ II Long • Radiused • 5 Flutes • 3 x D • Plain Shank • Metric

- first choice
- alternate choice

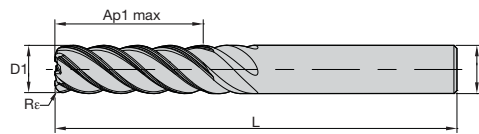

P	●
M	●
K	○
N	●
S	●
H	○

order number	catalogue number	D1	D	Ap1 max	L	Rε	KC643M
4124324	UGDE0600A5ARA	6,00	6,00	18,00	63,00	0,20	●
4124325	UGDE0600A5ARB	6,00	6,00	18,00	63,00	0,50	●
4124326	UGDE0600A5ARC	6,00	6,00	18,00	63,00	1,00	●
4124330	UGDE0800A5ARA	8,00	8,00	24,00	67,00	0,20	●
4124331	UGDE0800A5ARB	8,00	8,00	24,00	67,00	0,50	●
4124332	UGDE0800A5ARC	8,00	8,00	24,00	67,00	1,00	●
4124346	UGDE1000A5ARA	10,00	10,00	30,00	76,00	0,50	●
4124347	UGDE1000A5ARB	10,00	10,00	30,00	76,00	1,00	●
4124348	UGDE1000A5ARC	10,00	10,00	30,00	76,00	2,00	●
4124349	UGDE1000A5ARD	10,00	10,00	30,00	76,00	2,50	●
4124354	UGDE1200A5ARA	12,00	12,00	36,00	100,00	0,50	●
4124355	UGDE1200A5ARB	12,00	12,00	36,00	100,00	1,00	●
4124356	UGDE1200A5ARC	12,00	12,00	36,00	100,00	2,00	●
4124357	UGDE1200A5ARD	12,00	12,00	36,00	100,00	2,50	●
4156131	UGDE1400A5ARD	14,00	14,00	42,00	100,00	3,00	●
4124362	UGDE1600A5ARA	16,00	16,00	48,00	110,00	1,00	●
4124363	UGDE1600A5ARB	16,00	16,00	48,00	110,00	2,00	●
4124364	UGDE1600A5ARC	16,00	16,00	48,00	110,00	2,50	●
4124365	UGDE1600A5ARD	16,00	16,00	48,00	110,00	3,00	●
4124366	UGDE1600A5ARE	16,00	16,00	48,00	110,00	4,00	●
6064700	UGDE1600A5ARP	16,00	16,00	48,00	110,00	6,00	●
4124372	UGDE2000A5ARA	20,00	20,00	60,00	125,00	1,00	●
4124373	UGDE2000A5ARB	20,00	20,00	60,00	125,00	2,00	●
4124374	UGDE2000A5ARC	20,00	20,00	60,00	125,00	2,50	●
4124375	UGDE2000A5ARD	20,00	20,00	60,00	125,00	3,00	●
4124376	UGDE2000A5ARE	20,00	20,00	60,00	125,00	4,00	●
6064701	UGDE2000A5ARP	20,00	20,00	60,00	125,00	6,00	●
4124382	UGDE2500A5ARA	25,00	25,00	75,00	150,00	1,00	●
4124383	UGDE2500A5ARB	25,00	25,00	75,00	150,00	2,00	●
4124384	UGDE2500A5ARC	25,00	25,00	75,00	150,00	2,50	●
4124385	UGDE2500A5ARD	25,00	25,00	75,00	150,00	3,00	●
4124386	UGDE2500A5ARE	25,00	25,00	75,00	150,00	4,00	●
6064702	UGDE2500A5ARP	25,00	25,00	75,00	150,00	6,00	●

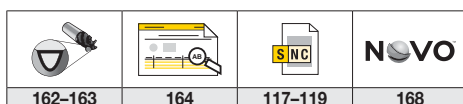

HARVI™ II Long • Radiused • 5 Flutes • 5 x D • Plain Shank • Metric

● first choice
○ alternate choice

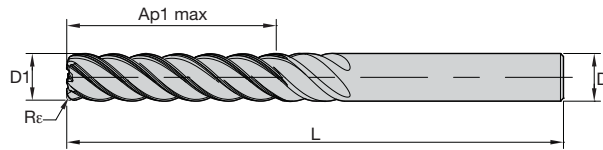

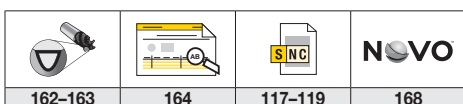

P	●
M	●
K	○
N	●
S	●
H	○

order number	catalogue number	D1	D	Ap1 max	L	Re	KC643M
4124327	UGDE0600A5BRA	6,00	6,00	30,00	76,00	0,20	●
4124328	UGDE0600A5BRB	6,00	6,00	30,00	76,00	0,50	●
4124329	UGDE0600A5BRC	6,00	6,00	30,00	76,00	1,00	●
4124343	UGDE0800A5BRA	8,00	8,00	40,00	87,00	0,20	●
4124344	UGDE0800A5BRB	8,00	8,00	40,00	87,00	0,50	●
4124345	UGDE0800A5BRC	8,00	8,00	40,00	87,00	1,00	●
4124350	UGDE1000A5BRA	10,00	10,00	50,00	100,00	0,50	●
4124351	UGDE1000A5BRB	10,00	10,00	50,00	100,00	1,00	●
4124352	UGDE1000A5BRC	10,00	10,00	50,00	100,00	2,00	●
4124353	UGDE1000A5BRD	10,00	10,00	50,00	100,00	2,50	●
4124358	UGDE1200A5BRA	12,00	12,00	60,00	125,00	0,50	●
4124359	UGDE1200A5BRB	12,00	12,00	60,00	125,00	1,00	●
4124360	UGDE1200A5BRC	12,00	12,00	60,00	125,00	2,00	●
4124361	UGDE1200A5BRD	12,00	12,00	60,00	125,00	2,50	●
4156132	UGDE1400A5BRD	14,00	14,00	70,00	120,00	3,00	●
4124367	UGDE1600A5BRA	16,00	16,00	80,00	141,00	1,00	●
4124368	UGDE1600A5BRB	16,00	16,00	80,00	141,00	2,00	●
4124369	UGDE1600A5BRC	16,00	16,00	80,00	141,00	2,50	●
4124370	UGDE1600A5BRD	16,00	16,00	80,00	141,00	3,00	●
4124371	UGDE1600A5BRE	16,00	16,00	80,00	141,00	4,00	●
6063449	UGDE1600A5BRP	16,00	16,00	80,00	141,00	6,00	●
4124377	UGDE2000A5BRA	20,00	20,00	100,00	166,00	1,00	●
4124378	UGDE2000A5BRB	20,00	20,00	100,00	166,00	2,00	●
4124379	UGDE2000A5BRC	20,00	20,00	100,00	166,00	2,50	●
4124380	UGDE2000A5BRD	20,00	20,00	100,00	166,00	3,00	●
4124381	UGDE2000A5BRE	20,00	20,00	100,00	166,00	4,00	●
6063450	UGDE2000A5BRP	20,00	20,00	100,00	166,00	6,00	●
4124387	UGDE2500A5BRA	25,00	25,00	125,00	190,00	1,00	●
4124388	UGDE2500A5BRB	25,00	25,00	125,00	190,00	2,00	●
4124390	UGDE2500A5BRD	25,00	25,00	125,00	190,00	3,00	●
4124391	UGDE2500A5BRE	25,00	25,00	125,00	190,00	4,00	●
6063471	UGDE2500A5BRP	25,00	25,00	125,00	190,00	6,00	●

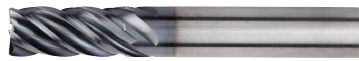

HARVI™ II • UCDE • Application Data • Metric



Material Group					KC643M		KCPM15		Recommended feed per tooth (fz = mm/th) for side milling (A). For slotting (B), reduce fz by 10%.										
	A		B		Cutting Speed – vc m/min		Cutting Speed – vc m/min		mm	D1 – Diameter									
	ap	ae	ap		min	max	min	max		5,0	6,0	8,0	10,0	12,0	14,0	16,0	18,0	20,0	25,0
P	0	1,5 x D	0,5 x D	1 x D	150	200	150	200	fz	0,036	0,044	0,060	0,072	0,083	0,092	0,101	0,108	0,114	0,124
	1	1,5 x D	0,5 x D	1 x D	150	200	150	200	fz	0,036	0,044	0,060	0,072	0,083	0,092	0,101	0,108	0,114	0,124
	2	1,5 x D	0,5 x D	1 x D	140	190	140	190	fz	0,036	0,044	0,060	0,072	0,083	0,092	0,101	0,108	0,114	0,124
	3	1,5 x D	0,5 x D	1 x D	120	160	120	160	fz	0,030	0,036	0,050	0,061	0,070	0,079	0,087	0,095	0,101	0,114
	4	1,5 x D	0,5 x D	0,75 x D	90	150	90	150	fz	0,027	0,033	0,045	0,054	0,062	0,070	0,077	0,083	0,088	0,098
	5	1,5 x D	0,5 x D	1 x D	60	100	60	100	fz	0,024	0,029	0,040	0,048	0,056	0,063	0,070	0,076	0,081	0,091
M	6	1,5 x D	0,5 x D	0,75 x D	50	75	50	75	fz	0,020	0,025	0,034	0,040	0,047	0,052	0,057	0,061	0,065	0,071
	1	1,5 x D	0,5 x D	1 x D	90	115	90	115	fz	0,030	0,036	0,050	0,061	0,070	0,079	0,087	0,095	0,101	0,114
	2	1,5 x D	0,5 x D	1 x D	60	80	60	80	fz	0,024	0,029	0,040	0,048	0,056	0,063	0,070	0,076	0,081	0,091
K	3	1,5 x D	0,5 x D	1 x D	60	70	60	70	fz	0,020	0,025	0,034	0,040	0,047	0,052	0,057	0,061	0,065	0,071
	1	1,5 x D	0,5 x D	1 x D	120	150	120	150	fz	0,036	0,044	0,060	0,072	0,083	0,092	0,101	0,108	0,114	0,124
	2	1,5 x D	0,5 x D	1 x D	110	140	110	140	fz	0,030	0,036	0,050	0,061	0,070	0,079	0,087	0,095	0,101	0,114
S	3	1,5 x D	0,5 x D	1 x D	110	130	110	130	fz	0,024	0,029	0,040	0,048	0,056	0,063	0,070	0,076	0,081	0,091
	1	1,5 x D	0,3 x D	0,3 x D	50	90	-	-	fz	0,030	0,036	0,050	0,061	0,070	0,079	0,087	0,095	0,101	0,114
	2	1,5 x D	0,3 x D	0,3 x D	25	40	-	-	fz	0,016	0,019	0,026	0,032	0,037	0,042	0,046	0,050	0,054	0,061
	3	1,5 x D	0,3 x D	0,3 x D	25	40	-	-	fz	0,016	0,019	0,026	0,032	0,037	0,042	0,046	0,050	0,054	0,061
H	4	1,5 x D	0,5 x D	1 x D	50	60	-	-	fz	0,021	0,026	0,037	0,045	0,052	0,058	0,064	0,069	0,074	0,084
	1	1,5 x D	0,5 x D	0,75 x D	80	140	80	140	fz	0,027	0,033	0,045	0,054	0,062	0,070	0,077	0,083	0,088	0,098

NOTE: Those guidelines may require variations to achieve optimum results.
 Lower value of cutting speed is used for high stock removal applications or for higher hardness (machinability) within group.
 Higher value of cutting speed is used for finishing applications or for lower hardness (machinability) within group.
 Above parameters are based on ideal conditions. For smaller taper machining centers, please adjust parameters accordingly on >12mm diameter.

HARVI™ II • UDDE • Application Data • Metric



Material Group					KCSM15/ KC643M		Recommended feed per tooth (fz = mm/th) for side milling (A). For slotting (B), reduce fz by 10%.									
	A		B		Cutting Speed – vc m/min		D1 – Diameter									
	ap	ae	ap		min	max	mm	6,0	8,0	10,0	12,0	14,0	16,0	18,0	20,0	25,0
P	5	1,5 x D	0,5 x D	1 x D	60	100	fz	0,029	0,040	0,048	0,056	0,063	0,070	0,076	0,081	0,091
	6	1,5 x D	0,5 x D	0,75 x D	50	75	fz	0,025	0,034	0,040	0,047	0,052	0,057	0,061	0,065	0,071
K	1	1,5 x D	0,5 x D	1 x D	120	150	fz	0,044	0,060	0,072	0,083	0,092	0,101	0,108	0,114	0,124
	2	1,5 x D	0,5 x D	1 x D	110	140	fz	0,036	0,050	0,061	0,07	0,079	0,087	0,095	0,101	0,114
	3	1,5 x D	0,5 x D	1 x D	110	130	fz	0,029	0,040	0,048	0,056	0,063	0,070	0,076	0,081	0,091
S	1	1,5 x D	0,3 x D	0,3 x D	50	90	fz	0,036	0,050	0,061	0,07	0,079	0,087	0,095	0,101	0,114
	2	1,5 x D	0,3 x D	0,3 x D	25	40	fz	0,019	0,026	0,032	0,037	0,042	0,046	0,050	0,054	0,061
	3	1,5 x D	0,3 x D	0,3 x D	25	40	fz	0,019	0,026	0,032	0,037	0,042	0,046	0,050	0,054	0,061
	4	1,5 x D	0,5 x D	1 x D	50	60	fz	0,026	0,037	0,045	0,052	0,058	0,064	0,069	0,074	0,084
H	1	1,5 x D	0,5 x D	0,75 x D	80	140	fz	0,033	0,045	0,054	0,062	0,070	0,077	0,083	0,088	0,098

NOTE: Lower value of cutting speed is used for high stock removal applications or for higher hardness (machinability) within group.
 Higher value of cutting speed is used for finishing applications or for lower hardness (machinability) within group.
 Above parameters are based on ideal conditions. For smaller taper machining centers, please adjust parameters accordingly on > 12mm diameter.
 Side milling applications – for longest reach (L3) tools, reduce Ae by 30%.
 Slot milling applications – for longest reach (L3) tools, reduce Ae by 30%.

HARVI II UCDE & UDDE • Adjustment Factor for Feed and Speed Calculation • Metric

	Ae/D	2%	4%	5%	8%	10%	12%	20%	30%	40%	50%	100%
Speed factor	Kv	2,1–3,6	1,6–3	1,6–2,5	1,6	1,4	1,38	1,3	1,2	1,1	1	0,9
Feed factor	KFz	3,58	2,56	2,3	1,84	1,67	1,54	1,25	1,09	1,02	1	1

NOTE: For an Ae/D ratio of 5% or less there is a range given for speed factor Kv, which allows the user to either be more conservative at the lower value or more aggressive with the higher value.
 This can also be considered based on the machinability of the material, from difficult to free cutting.
 These calculations are for roughing/semi-finishing cuts when used with the recommended base Fz.
 For light finishing cuts requiring improved surface quality it is recommended to reduce the base Fz approximately 50% and then apply these factors.

To calculate application-specific cutting data, please use Kv coefficient table above for adaptation of cutting speed and KFz for feed respectively.

Vc new = Vc * Kv
 Fz new = Fz * KFz

Calculation example:

Application: D = 20mm, HARVI II UCDE;
 M2 material group;
 Ae = 2mm
 Cutting data recommendation: Vc = 80 m/min;
 Fz = 0,089 mm/th
 Adjustment coefficients: Ae = 2mm equals 10,0%;
 Kv = 1,4; KFz = 1,67

Final cutting data recommendation:

Vc new = 80 * 1,4 = 112 m/min
 Fz new = 0,089 * 1,67 = 0,15 mm/min

HARVI™ III • UJDE • Application Data • Metric



With Neck

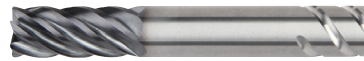

Without Neck

Material Group			KCSM15		Recommended feed per tooth (fz = mm/th) for side milling (A).							
	A		Cutting Speed – vc m/min		mm	D1 – Diameter						
	ap	ae	min	max		10,0	12,0	16,0	18,0	20,0	25,0	
P	4	Ap1 max	0,4 x D	90	150	fz	0,054	0,062	0,077	0,083	0,088	0,098
	5	Ap1 max	0,4 x D	60	100	fz	0,048	0,056	0,070	0,076	0,081	0,091
M	1	Ap1 max	0,4 x D	90	115	fz	0,061	0,070	0,087	0,095	0,101	0,114
	2	Ap1 max	0,4 x D	60	80	fz	0,048	0,056	0,070	0,076	0,081	0,091
	3	Ap1 max	0,4 x D	60	70	fz	0,040	0,047	0,057	0,061	0,065	0,071
S	1	Ap1 max	0,4 x D	50	90	fz	0,061	0,070	0,087	0,095	0,101	0,114
	2	Ap1 max	0,4 x D	25	40	fz	0,032	0,037	0,046	0,050	0,054	0,061
	3	Ap1 max	0,4 x D	25	40	fz	0,032	0,037	0,046	0,050	0,054	0,061
	4	Ap1 max	0,4 x D	50	60	fz	0,045	0,052	0,064	0,069	0,074	0,084
H	1	Ap1 max	0,4 x D	80	140	fz	0,054	0,062	0,077	0,083	0,088	0,098

NOTE: Lower value of cutting speed is used for high stock removal applications or for higher hardness (machinability) within group.
 Higher value of cutting speed is used for finishing applications or for lower hardness (machinability) within group.
 Above parameters are based on ideal conditions. For smaller taper machining centers, please adjust parameters accordingly on >12mm diameter.

HARVI™ III Ball Nose • UJBE • Application Data • Metric



Ball Nose



Taper Ball Nose

Material Group	A		KCSM15			Recommended feed per tooth (fz = mm/th) for side milling (A).							
	A		Cutting Speed – vc m/min			D1 – Diameter							
	ap	ae	min	–	max	mm	10,0	12,0	16,0	18,0	20,0	25,0	
P	0	Ap max	0,4 x D	150	–	200	fz	0,072	0,083	0,101	0,108	0,114	0,124
	1	Ap max	0,4 x D	150	–	200	fz	0,072	0,083	0,101	0,108	0,114	0,124
	2	Ap max	0,4 x D	140	–	190	fz	0,072	0,083	0,101	0,108	0,114	0,124
	3	Ap max	0,4 x D	120	–	160	fz	0,061	0,070	0,087	0,095	0,101	0,114
	4	Ap max	0,4 x D	90	–	150	fz	0,054	0,062	0,077	0,083	0,088	0,098
	5	Ap max	0,4 x D	60	–	100	fz	0,048	0,056	0,070	0,076	0,081	0,091
M	6	Ap max	0,4 x D	50	–	75	fz	0,040	0,047	0,057	–	0,065	0,071
	1	Ap max	0,4 x D	90	–	115	fz	0,061	0,070	0,087	0,095	0,101	0,114
	2	Ap max	0,4 x D	60	–	80	fz	0,048	0,056	0,070	0,076	0,081	0,091
S	3	Ap max	0,4 x D	60	–	70	fz	0,040	0,047	0,057	0,061	0,065	0,071
	1	Ap max	0,4 x D	50	–	90	fz	0,061	0,070	0,087	0,095	0,101	0,114
	2	Ap max	0,4 x D	25	–	40	fz	0,032	0,037	0,046	0,050	0,054	0,061
H	3	Ap max	0,4 x D	25	–	40	fz	0,032	0,037	0,046	0,050	0,054	0,061
	4	Ap max	0,4 x D	50	–	60	fz	0,045	0,052	0,064	0,069	0,074	0,084
H	1	Ap max	0,4 x D	80	–	140	fz	0,054	0,062	0,077	0,083	0,088	0,098

* For the above cutting data, do not exceed an overall Ae of 0,8mm.

NOTE: Lower value of cutting speed is used for high stock removal applications or for higher hardness (machinability) within group.

Higher value of cutting speed is used for finishing applications or for lower hardness (machinability) within group.

Above parameters are based on ideal conditions. For smaller taper machining centers, please adjust parameters accordingly on >12mm diameter.

HARVI III UJDE & UJBE • Adjustment Factor for Feed and Speed Calculation • Metric

	Ae/D	2%	4%	5%	8%	10%	12%	20%	30%	40%	50%	100%
Speed factor	Kv	2,1–3,6	1,6–3	1,6–2,5	1,6	1,4	1,38	1,3	1,2	1,1	1	0,9
Feed factor	KFz	3,58	2,56	2,3	1,84	1,67	1,54	1,25	1,09	1,02	1	1

NOTE: For an Ae/D ratio of 5% or less there is a range given for speed factor Kv, which allows the user to either be more conservative at the lower value or more aggressive with the higher value.

This can also be considered based on the machinability of the material, from difficult to free cutting.

These calculations are for roughing/semi-finishing cuts when used with the recommended base Fz.

For light finishing cuts requiring improved surface quality it is recommended to reduce the base Fz approximately 50% and then apply these factors.

To calculate application-specific cutting data, please use Kv coefficient table above for adaptation of cutting speed and KFz for feed respectively.

Vc new = Vc * Kv
Fz new = Fz * KFz

Calculation example:

Application: D = 20mm;
M2 material group;
Ae = 2mm
Cutting data recommendation: Vc = 80 m/min;
Fz = 0,089 mm/th
Adjustment coefficients: Ae = 2mm equals 10,0%;
Kv = 1,4; KFz = 1,67

Final cutting data recommendation:

Vc new = 80 * 1,4 = 112 m/min
Fz new = 0,089 * 1,67 = 0,15 mm/min

HARVI™ II Long • UGDE • Application Data • Metric



3 x D Lengths of Cut



5 x D Lengths of Cut

Material Group			KC643M		Recommended feed per tooth (fz = mm/th) for side milling (A).									
	A		Cutting Speed – vc m/min		mm	D1 – Diameter								
	ap	ae	min	max		6,0	8,0	10,0	12,0	14,0	16,0	20,0	25,0	
P	1	Ap1 max	0,05 x D*	300	400	fz	0,044	0,060	0,072	0,083	0,092	0,101	0,114	0,124
	2	Ap1 max	0,05 x D*	280	380	fz	0,044	0,060	0,072	0,083	0,092	0,101	0,114	0,124
	3	Ap1 max	0,05 x D*	240	320	fz	0,036	0,050	0,061	0,070	0,079	0,087	0,101	0,114
	4	Ap1 max	0,05 x D*	180	300	fz	0,033	0,045	0,054	0,062	0,070	0,077	0,088	0,098
	5	Ap1 max	0,05 x D*	120	200	fz	0,029	0,040	0,048	0,056	0,063	0,070	0,081	0,091
M	1	Ap1 max	0,05 x D*	180	230	fz	0,036	0,050	0,061	0,070	0,079	0,087	0,101	0,114
	2	Ap1 max	0,05 x D*	120	160	fz	0,029	0,040	0,048	0,056	0,063	0,070	0,081	0,091
	3	Ap1 max	0,05 x D*	120	140	fz	0,025	0,034	0,040	0,047	0,052	0,057	0,065	0,071
K	1	Ap1 max	0,05 x D*	240	300	fz	0,044	0,060	0,072	0,083	0,092	0,101	0,114	0,124
	2	Ap1 max	0,05 x D*	220	260	fz	0,036	0,050	0,061	0,070	0,079	0,087	0,101	0,114
	3	Ap1 max	0,05 x D*	200	260	fz	0,029	0,040	0,048	0,056	0,063	0,070	0,081	0,091
S	1	Ap1 max	0,05 x D*	100	180	fz	0,036	0,050	0,061	0,070	0,079	0,087	0,101	0,114
	2	Ap1 max	0,05 x D*	100	180	fz	0,036	0,050	0,061	0,070	0,079	0,087	0,101	0,114
	3	Ap1 max	0,05 x D*	50	80	fz	0,019	0,026	0,032	0,037	0,042	0,046	0,054	0,061
	4	Ap1 max	0,05 x D*	100	120	fz	0,026	0,037	0,045	0,052	0,058	0,064	0,074	0,084
H	1	Ap1 max	0,05 x D*	160	280	fz	0,033	0,045	0,054	0,062	0,070	0,077	0,088	0,098

* For the above cutting data, do not exceed an overall Ae of 0,8mm.

NOTE: Lower value of cutting speed is used for high stock removal applications or for higher hardness (machinability) within group.

Higher value of cutting speed is used for finishing applications or for lower hardness (machinability) within group.

Above parameters are based on ideal conditions. For smaller taper machining centers, please adjust parameters accordingly on >12mm diameter.

Application Recommendation for Surface Profiling with HARVI™ III Ball Nose Series

Not all six cutting edges reach the center of the HARVI III series ball nose end mill. Due to this, certain tilt angles will engage different numbers of cutting edges and can alter the required cutting parameters. This will also be altered by the depths of cut, which will change the contact area and resulting number of edges engaged.

When surface profiling with any ball nose end mill, optimum performance will be achieved by tilting away from the center of the tool if possible. This is due to the fact that at the tip of the tool only the center cutting edges exist (two in the case of HARVI III series), and also the fact that the rotational velocity is zero in the center. Therefore, Kennametal recommends tilting the end mill to engage more cutting edges and avoid the zero-speed condition.

As the HARVI III series ball nose end mills do have two center cutting edges, it is possible to machine without tilting if the application requires this. Just factor in the reduced number of cutting edges into the cutting parameter calculations.



At the tip of the tool, only the center cutting edges exist.
The rotational velocity is zero in the center.



When surface profiling with any ball nose end mill, optimum performance will be achieved by tilting away from the center of the tool if possible.

HARVI III Ball Nose & HARVI III Taper Ball Nose



For tilt angles less than 15° and shallow profiling depths, only two cutting edges will be typically engaged. As the end mill is tilted above this, the next two edges will engage.



After reaching a tilt angle of at least 22°, then all six edges will at least be partially engaged.



For maximum profiling performance, a tilt angle of 40°-45° will result in full engagement of all edges with a wide range of cutting depths.

KOR™ Series

High-Performance Dynamic Milling



Materials



Applications



Ramping



Trochoidal Milling



Side Milling/Shoulder
Milling: Roughing



Side Milling/Shoulder
Milling: Finishing

KOR Series

Designed for dynamic milling with low radial engagement and full length of cut. Maximizes capabilities of 5-axis machines, using CAM tool path generation software.

KOR5^{DA} — Dynamic Rougher for Aluminum

With chip splitters for near-perfect chip management.

Safe-Lock™ shanks available for pullout protection.

With and without internal coolant.

NEW!

5 x D length of cut with internal-coolant for a broader application range.

KOR5™ DA



Proprietary flute forms reduce vibrations and improve tool life.

KOR5^{DS}



Helix angles tailored to target material to minimize vibration and optimize tool life.

KOR6™ DT



Front end geometries for maximum tool life in helical and ramping operations.

KOR5^{DS} — Dynamic Rougher for Steel and Stainless Steel

With chip deformers for near-perfect chip management at high surface quality.

Safe-Lock™ and Weldon® shanks for pullout protection.

3 x D and 5 x D with plain and Weldon shanks.

KOR6^{DT} — Dynamic Rougher for Titanium

With chip splitters for optimized chip management.

3 x D and 5 x D with plain and Weldon shanks.

KOR5™ DS • Radiused • 5 Flutes • 3 x D • Plain Shank • Metric

- first choice
- alternate choice

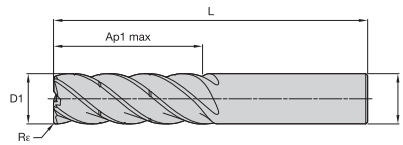

P	●
M	●
K	○
N	○
S	●
H	○

order number	catalogue number	D1	D	Ap1 max	L	Re	KC643M
6763959	KOR5RA0800R024HAR050CM	8,00	8,00	24,00	67,00	0,50	●
6763960	KOR5RA1000R030HAR050CM	10,00	10,00	30,00	80,00	0,50	●
6763981	KOR5RA1200R036HAR075CM	12,00	12,00	36,00	100,00	0,75	●
6763982	KOR5RA1600R048HAR100CM	16,00	16,00	48,00	110,00	1,00	●
6763984	KOR5RA2000R060HAR100CM	20,00	20,00	60,00	125,00	1,00	●
6763985	KOR5RA2500R075HAR100CM	25,00	25,00	75,00	150,00	1,00	●

KOR5 DS • Radiused • 5 Flutes • 3 x D • Weldon® Shank • Metric

- first choice
- alternate choice

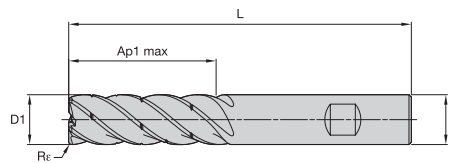

P	●
M	●
K	○
N	○
S	●
H	○

order number	catalogue number	D1	D	Ap1 max	L	Re	KC643M
6763986	KOR5RA0800R024HBR050CM	8,00	8,00	24,00	67,00	0,50	●
6763987	KOR5RA1000R030HBR050CM	10,00	10,00	30,00	80,00	0,50	●
6763988	KOR5RA1200R036HBR075CM	12,00	12,00	36,00	100,00	0,75	●
6763989	KOR5RA1600R048HBR100CM	16,00	16,00	48,00	110,00	1,00	●
6763992	KOR5RA2000R060HBR100CM	20,00	20,00	60,00	125,00	1,00	●
6763993	KOR5RA2500R075HBR100CM	25,00	25,00	75,00	150,00	1,00	●

162-163	164	117-119	168

KOR5™ DS • Radiused • 5 Flutes • 5 x D • Plain Shank • Metric

● first choice
○ alternate choice

order number	catalogue number	D1	D	Ap1 max	L	Re	KC643M
6768036	KOR5RA0800L040HAR050CM	8,00	8,00	40,00	87,00	0,50	●
6768037	KOR5RA1000L050HAR050CM	10,00	10,00	50,00	100,00	0,50	●
6768038	KOR5RA1200L060HAR075CM	12,00	12,00	60,00	125,00	0,75	●
6768039	KOR5RA1600L080HAR100CM	16,00	16,00	80,00	141,00	1,00	●
6768040	KOR5RA2000L100HAR100CM	20,00	20,00	100,00	170,00	1,00	●
6768042	KOR5RA2500L125HAR100CM	25,00	25,00	125,00	200,00	1,00	●

KOR5 DS • Radiused • 5 Flutes • 5 x D • Weldon® Shank • Metric

● first choice
○ alternate choice

order number	catalogue number	D1	D	Ap1 max	L	Re	KC643M
6768043	KOR5RA0800L040HBR050CM	8,00	8,00	40,00	87,00	0,50	●
6768044	KOR5RA1000L050HBR050CM	10,00	10,00	50,00	100,00	0,50	●
6768045	KOR5RA1200L060HBR075CM	12,00	12,00	60,00	125,00	0,75	●
6768046	KOR5RA1600L080HBR100CM	16,00	16,00	80,00	141,00	1,00	●
6768047	KOR5RA2000L100HBR100CM	20,00	20,00	100,00	170,00	1,00	●
6768048	KOR5RA2500L125HBR100CM	25,00	25,00	125,00	200,00	1,00	●

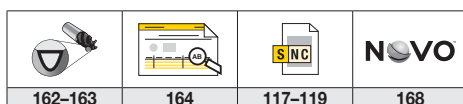

KOR5™ DA • Radiused • 5 Flutes • 3 x D • Internal Coolant • Plain Shank • Metric

- first choice
- alternate choice

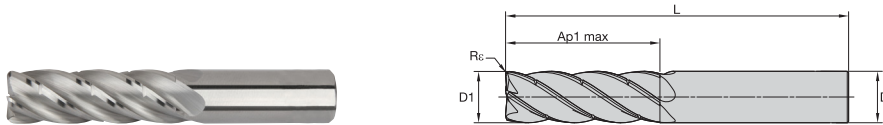

P	■
M	■
K	■
N	●
S	■
H	■

order number	catalogue number	D1	D	Ap1 max	L	R _c	K600
6754973	KOR5RA1000R030HAR020IM	10,00	10,00	30,00	75,00	0,20	●
6754974	KOR5RA1000R030HAR050IM	10,00	10,00	30,00	75,00	0,50	●
6754975	KOR5RA1000R030HAR100IM	10,00	10,00	30,00	75,00	1,00	●

KOR5 DA • Radiused • 5 Flutes • 3 x D • Internal Coolant • Safe-Lock™ Shank • Metric

- first choice
- alternate choice

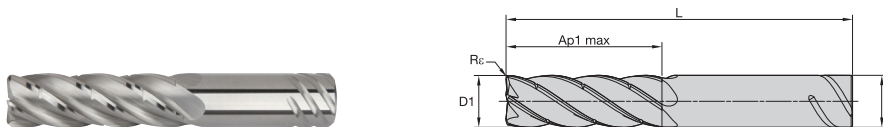

P	■
M	■
K	■
N	●
S	■
H	■

order number	catalogue number	D1	D	Ap1 max	L	R _c	K600
6754977	KOR5RA1200R036SLR020IM	12,00	12,00	36,00	87,00	0,20	●
6754978	KOR5RA1200R036SLR050IM	12,00	12,00	36,00	87,00	0,50	●
6754979	KOR5RA1200R036SLR150IM	12,00	12,00	36,00	87,00	1,50	●
6754980	KOR5RA1200R036SLR250IM	12,00	12,00	36,00	87,00	2,50	●
6755002	KOR5RA1600R048SLR050IM	16,00	16,00	48,00	104,00	0,50	●
6755003	KOR5RA1600R048SLR200IM	16,00	16,00	48,00	104,00	2,00	●
6755004	KOR5RA1600R048SLR250IM	16,00	16,00	48,00	104,00	2,50	●
6755006	KOR5RA2000R060SLR050IM	20,00	20,00	60,00	120,00	0,50	●
6755007	KOR5RA2000R060SLR250IM	20,00	20,00	60,00	120,00	2,50	●
6755009	KOR5RA2500R075SLR050IM	25,00	25,00	75,00	144,00	0,50	●
6755010	KOR5RA2500R075SLR250IM	25,00	25,00	75,00	144,00	2,50	●

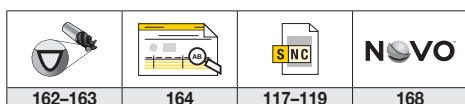

KOR5™ DA • Square End • 5 Flutes • 3 x D • Internal Coolant • Plain Shank • Metric

- first choice
- alternate choice

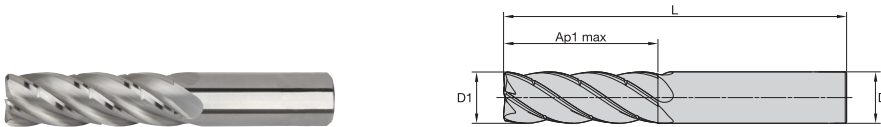

P	■
M	■
K	■
N	●
S	■
H	■
	■

order number	catalogue number	D1	D	Ap1 max	L	K600
6754972	KOR5SE1000R030HAIM	10,00	10,00	30,00	75,00	●

KOR5 DA • Square End • 5 Flutes • 3 x D • Internal Coolant • Safe-Lock™ Shank • Metric

- first choice
- alternate choice

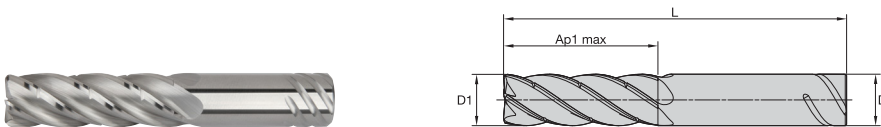

P	■
M	■
K	■
N	●
S	■
H	■
	■

order number	catalogue number	D1	D	Ap1 max	L	K600
6754976	KOR5SE1200R036SLIM	12,00	12,00	36,00	87,00	●
6755001	KOR5SE1600R048SLIM	16,00	16,00	48,00	104,00	●
6755005	KOR5SE2000R060SLIM	20,00	20,00	60,00	120,00	●
6755008	KOR5SE2500R075SLIM	25,00	25,00	75,00	144,00	●

KOR5 DA • Radiused • 5 Flutes • 3 x D • Plain Shank • Metric

- first choice
- alternate choice

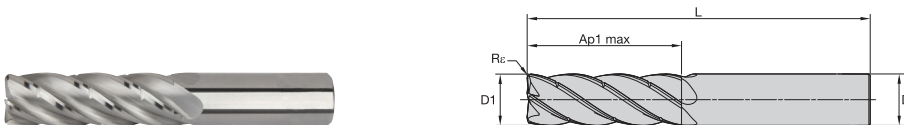

P	■
M	■
K	■
N	●
S	■
H	■
	■

order number	catalogue number	D1	D	Ap1 max	L	Rε	K600
6755013	KOR5RA1000R030HAR020CM	10,00	10,00	30,00	75,00	0,20	●
6755014	KOR5RA1000R030HAR050CM	10,00	10,00	30,00	75,00	0,50	●
6755015	KOR5RA1000R030HAR100CM	10,00	10,00	30,00	75,00	1,00	●

KOR5™ DA • Radiused • 5 Flutes • 3 x D • Safe-Lock™ Shank • Metric

- first choice
- alternate choice

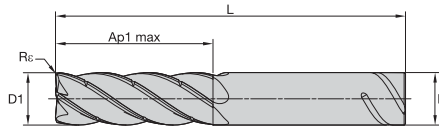

P	■	■
M	■	■
K	■	■
N	■	●
S	■	■
H	■	■

order number	catalogue number	D1	D	Ap1 max	L	Rc	K600
6755017	KOR5RA1200R036SLR020CM	12,00	12,00	36,00	87,00	0,20	●
6755018	KOR5RA1200R036SLR050CM	12,00	12,00	36,00	87,00	0,50	●
6755019	KOR5RA1200R036SLR150CM	12,00	12,00	36,00	87,00	1,50	●
6755020	KOR5RA1200R036SLR250CM	12,00	12,00	36,00	87,00	2,50	●
6755032	KOR5RA1600R048SLR050CM	16,00	16,00	48,00	104,00	0,50	●
6755033	KOR5RA1600R048SLR200CM	16,00	16,00	48,00	104,00	2,00	●
6755034	KOR5RA1600R048SLR250CM	16,00	16,00	48,00	104,00	2,50	●
6755036	KOR5RA2000R060SLR050CM	20,00	20,00	60,00	120,00	0,50	●
6755037	KOR5RA2000R060SLR250CM	20,00	20,00	60,00	120,00	2,50	●
6755039	KOR5RA2500R075SLR050CM	25,00	25,00	75,00	144,00	0,50	●
6755040	KOR5RA2500R075SLR250CM	25,00	25,00	75,00	144,00	2,50	●

KOR5 DA • Square End • 5 Flutes • 3 x D • Plain Shank • Metric

- first choice
- alternate choice

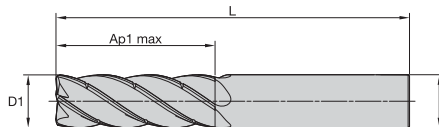

P	■	■
M	■	■
K	■	■
N	■	●
S	■	■
H	■	■

order number	catalogue number	D1	D	Ap1 max	L	K600
6755012	KOR5SE1000R030HACM	10,00	10,00	30,00	75,00	●

162-163	164	117-119	168

KOR5™ DA • Square End • 5 Flutes • 3 x D • Safe-Lock™ Shank • Metric

- first choice
- alternate choice

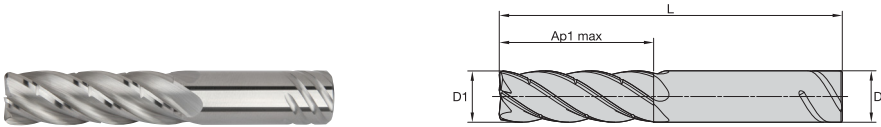

P	■
M	■
K	■
N	●
S	■
H	■

order number	catalogue number	D1	D	Ap1 max	L	K600
6755016	KOR5SE1200R036SLCM	12,00	12,00	36,00	87,00	●
6755031	KOR5SE1600R048SLCM	16,00	16,00	48,00	104,00	●
6755035	KOR5SE2000R060SLCM	20,00	20,00	60,00	120,00	●
6755038	KOR5SE2500R075SLCM	25,00	25,00	75,00	144,00	●

KOR5 DA • Radiused • 5 Flutes • 5 x D • Internal Coolant • Plain Shank • Metric

- first choice
- alternate choice

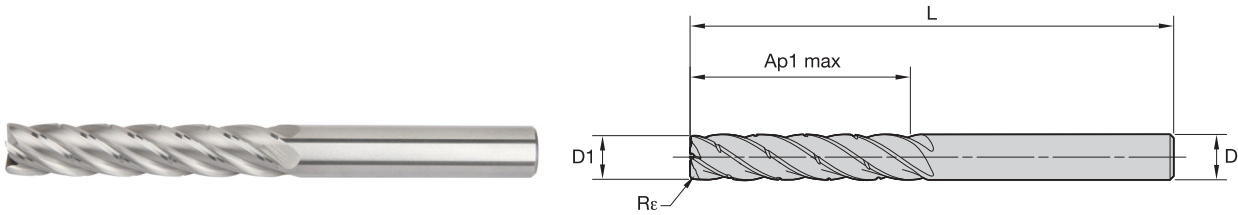

P	■
M	■
K	■
N	●
S	■
H	■

order number	catalogue number	D1	D	Ap1 max	L	Rc	K600
6974931	KOR5RA1000L050HAR020IM	10,00	10,00	50,00	100,00	0,20	●
6974932	KOR5RA1000L050HAR050IM	10,00	10,00	50,00	100,00	0,50	●
6974933	KOR5RA1000L050HAR100IM	10,00	10,00	50,00	100,00	1,00	●

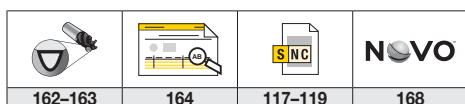

KOR5™ DA • Radiused • 5 Flutes • 5 x D • Internal Coolant • Safe-Lock™ Shank • Metric

● first choice
○ alternate choice

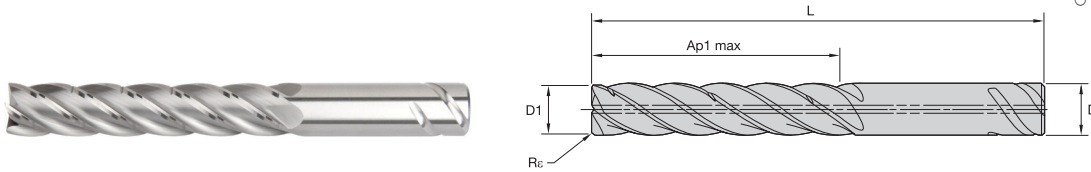

P	■
M	■
K	■
N	●
S	■
H	■

order number	catalogue number	D1	D	Ap1 max	L	Re	K600
6974935	KOR5RA1200L060SLR020IM	12,00	12,00	60,00	115,00	0,20	●
6974936	KOR5RA1200L060SLR050IM	12,00	12,00	60,00	115,00	0,50	●
6974937	KOR5RA1200L060SLR150IM	12,00	12,00	60,00	115,00	1,50	●
6974938	KOR5RA1200L060SLR250IM	12,00	12,00	60,00	115,00	2,50	●
6974940	KOR5RA1600L080SLR050IM	16,00	16,00	80,00	141,00	0,50	●
6974941	KOR5RA1600L080SLR200IM	16,00	16,00	80,00	141,00	2,00	●
6974942	KOR5RA1600L080SLR250IM	16,00	16,00	80,00	141,00	2,50	●
6974944	KOR5RA2000L100SLR050IM	20,00	20,00	100,00	166,00	0,50	●
6974945	KOR5RA2000L100SLR250IM	20,00	20,00	100,00	166,00	2,50	●
6974947	KOR5RA2500L125SLR050IM	25,00	25,00	125,00	200,00	0,50	●
6974948	KOR5RA2500L125SLR250IM	25,00	25,00	125,00	200,00	2,50	●

KOR5 DA • Square End • 5 Flutes • 5 x D • Internal Coolant • Plain Shank • Metric

● first choice
○ alternate choice

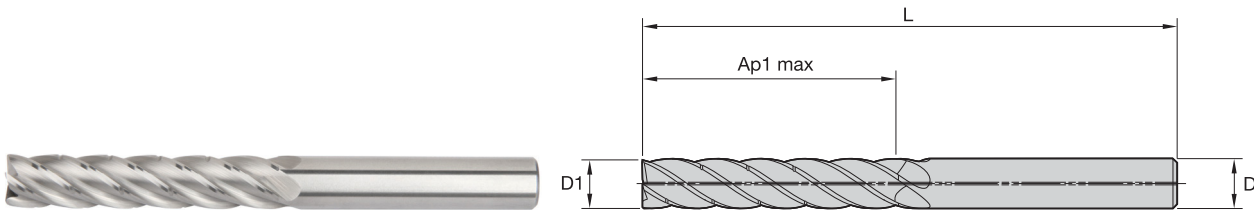

P	■
M	■
K	■
N	●
S	■
H	■

order number	catalogue number	D1	D	Ap1 max	L	K600
6974934	KOR5SE1000L050HAIM	10,00	10,00	50,00	100,00	●

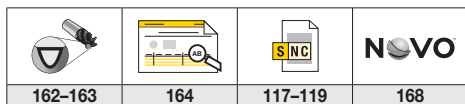

KOR5™ DA • Square End • 5 Flutes • 5 x D • Internal Coolant • Safe-Lock™ Shank • Metric

- first choice
- alternate choice

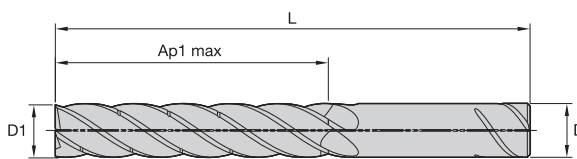

P	■
M	■
K	■
N	●
S	■
H	■

order number	catalogue number	D1	D	Ap1 max	L		K600
6974939	KOR5SE1200L060SLIM	12,00	12,00	60,00	115,00	●	●
6974943	KOR5SE1600L080SLIM	16,00	16,00	80,00	141,00	●	●
6974946	KOR5SE2000L100SLIM	20,00	20,00	100,00	166,00	●	●
6974949	KOR5SE2500L125SLIM	25,00	25,00	125,00	200,00	●	●

KOR6™ DT • Radiused • 6 Flutes • 3 x D • Plain Shank • Metric

- first choice
- alternate choice

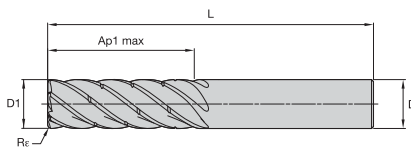

P	■
M	○
K	○
N	○
S	●
H	○

order number	catalogue number	D1	D	Ap1 max	L	Re	KCSM15
6767693	KOR6RA0800R024HAR050M	8,00	8,00	24,00	67,00	0,50	●
6767694	KOR6RA1000R030HAR050M	10,00	10,00	30,00	80,00	0,50	●

162-163	164	117-119	168

KOR6™ DT • Radiused • 6 Flutes • 3 x D • Weldon® Shank • Metric

- first choice
- alternate choice

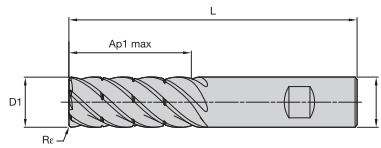

P	<input checked="" type="checkbox"/>
M	<input type="checkbox"/>
K	<input type="checkbox"/>
N	<input type="checkbox"/>
S	<input checked="" type="checkbox"/>
H	<input type="checkbox"/>

order number	catalogue number	D1	D	Ap1 max	L	Re	KCSM15
6767699	KOR6RA0800R024HBR050M	8,00	8,00	24,00	67,00	0,50	●
6767700	KOR6RA1000R030HBR050M	10,00	10,00	30,00	80,00	0,50	●
6767701	KOR6RA1200R036HBR075M	12,00	12,00	36,00	100,00	0,75	●
6767702	KOR6RA1600R048HBR100M	16,00	16,00	48,00	110,00	1,00	●
6767703	KOR6RA2000R060HBR100M	20,00	20,00	60,00	125,00	1,00	●
6767705	KOR6RA2500R075HBR100M	25,00	25,00	75,00	150,00	1,00	●

KOR6 DT • Radiused • 6 Flutes • 3 x D • Safe-Lock™ Shank • Metric

- first choice
- alternate choice

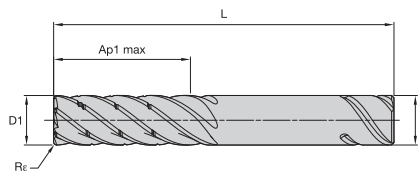

P	<input checked="" type="checkbox"/>
M	<input type="checkbox"/>
K	<input type="checkbox"/>
N	<input type="checkbox"/>
S	<input checked="" type="checkbox"/>
H	<input type="checkbox"/>

order number	catalogue number	D1	D	Ap1 max	L	Re	KCSM15
6767695	KOR6RA1200R036SLR075M	12,00	12,00	36,00	100,00	0,75	●
6767696	KOR6RA1600R048SLR100M	16,00	16,00	48,00	110,00	1,00	●
6767697	KOR6RA2000R060SLR100M	20,00	20,00	60,00	125,00	1,00	●
6767698	KOR6RA2500R075SLR100M	25,00	25,00	75,00	150,00	1,00	●

KOR6 DT • Radiused • 6 Flutes • 5 x D • Plain Shank • Metric

- first choice
- alternate choice

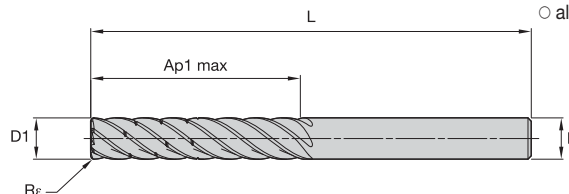

P	<input checked="" type="checkbox"/>
M	<input type="checkbox"/>
K	<input type="checkbox"/>
N	<input type="checkbox"/>
S	<input checked="" type="checkbox"/>
H	<input type="checkbox"/>

order number	catalogue number	D1	D	Ap1 max	L	Re	KCSM15
6767641	KOR6RA0800L040HAR050CM	8,00	8,00	40,00	87,00	0,50	●
6767642	KOR6RA1000L050HAR050CM	10,00	10,00	50,00	100,00	0,50	●

KOR6™ DT • Radiused • 6 Flutes • 5 x D • Weldon® Shank • Metric

● first choice
○ alternate choice

order number	catalogue number	D1	D	Ap1 max	L	Re	KCSM15
6767647	KOR6RA0800L040HBR050CM	8,00	8,00	40,00	87,00	0,50	●
6767648	KOR6RA1000L050HBR050CM	10,00	10,00	50,00	100,00	0,50	●
6767649	KOR6RA1200L060HBR075CM	12,00	12,00	60,00	125,00	0,75	●
6767650	KOR6RA1600L080HBR100CM	16,00	16,00	80,00	141,00	1,00	●
6767651	KOR6RA2000L100HBR100CM	20,00	20,00	100,00	166,00	1,00	●
6767652	KOR6RA2500L125HBR100CM	25,00	25,00	125,00	190,00	1,00	●

KOR6 DT • Radiused • 6 Flutes • 5 x D • Safe-Lock™ Shank • Metric

● first choice
○ alternate choice

order number	catalogue number	D1	D	Ap1 max	L	Re	KCSM15
6767643	KOR6RA1200L060SLR075CM	12,00	12,00	60,00	125,00	0,75	●
6767644	KOR6RA1600L080SLR100CM	16,00	16,00	80,00	141,00	1,00	●
6767645	KOR6RA2000L100SLR100CM	20,00	20,00	100,00	166,00	1,00	●
6767646	KOR6RA2500L125SLR100CM	25,00	25,00	125,00	190,00	1,00	●

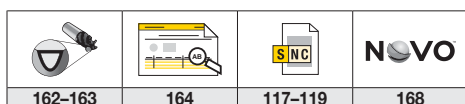

KOR5™ DS & KOR6™ DT • 3 x D • Application Data • Metric

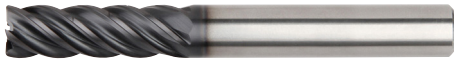

KOR5 DS 3 x D



KOR6 DT 3 x D

Material Group			KC643M			Recommended feed per tooth (fz = mm/th) for side milling (A).							
	A		Cutting Speed – vc m/min			mm	D1 – Diameter						
	ap	ae	min	–	max		8,0	10,0	12,0	16,0	20,0	25,0	
P	0	3 x D	0,1 x D	150	–	440	fz	0,072	0,086	0,099	0,121	0,137	0,149
	1	3 x D	0,1 x D	150	–	440	fz	0,072	0,086	0,099	0,121	0,137	0,149
	2	3 x D	0,1 x D	140	–	418	fz	0,072	0,086	0,099	0,121	0,137	0,149
	3	3 x D	0,1 x D	120	–	352	fz	0,060	0,073	0,084	0,105	0,121	0,137
	4	3 x D	0,1 x D	90	–	330	fz	0,054	0,065	0,075	0,092	0,106	0,117
	5	3 x D	0,1 x D	60	–	220	fz	0,048	0,058	0,067	0,084	0,097	0,109
M	3	3 x D	0,1 x D	50	–	165	fz	0,040	0,048	0,056	0,068	0,078	0,085
	1	3 x D	0,1 x D	90	–	253	fz	0,060	0,073	0,084	0,105	0,121	0,137
	2	3 x D	0,1 x D	60	–	176	fz	0,048	0,058	0,067	0,084	0,097	0,109
K	3	3 x D	0,1 x D	60	–	154	fz	0,040	0,048	0,056	0,068	0,078	0,085
	1	3 x D	0,1 x D	120	–	330	fz	0,072	0,086	0,099	0,121	0,137	0,149
	2	3 x D	0,1 x D	110	–	308	fz	0,060	0,073	0,084	0,105	0,121	0,137
S	3	3 x D	0,1 x D	110	–	286	fz	0,048	0,058	0,067	0,084	0,097	0,109
	1	3 x D	0,1 x D	50	–	198	fz	0,060	0,073	0,084	0,105	0,121	0,137
	2	3 x D	0,1 x D	25	–	88	fz	0,032	0,038	0,045	0,056	0,065	0,074
	3	3 x D	0,1 x D	25	–	88	fz	0,032	0,038	0,045	0,056	0,065	0,074
H	4	3 x D	0,1 x D	50	–	132	fz	0,044	0,053	0,062	0,077	0,089	0,100
	1	3 x D	0,1 x D	80	–	308	fz	0,054	0,065	0,075	0,092	0,106	0,117
	2	3 x D	0,1 x D	70	–	264	fz	0,040	0,048	0,056	0,068	0,078	0,085

NOTE: Lower value of cutting speed is used for high stock removal applications or for higher hardness (machinability) within group.

Higher value of cutting speed is used for finishing applications or for lower hardness (machinability) within group.

Side milling applications – for longest reach (L3) tools, reduce Ae by 30%.

For better surface finish, reduce feed per tooth.

KOR5™ DS & KOR6™ DT • 5 x D • Application Data • Metric



KOR5 DS 5 x D



KOR6 DT 5 x D

Material Group	A		Cutting Speed – vc m/min			Recommended feed per tooth (fz = mm/th) for side milling (A).							
	ap	ae	min	–	max	mm	D1 – Diameter						
							8,0	10,0	12,0	16,0	20,0	25,0	
P	0	5 x D	0,05 x D	150	–	540	fz	0,097	0,117	0,134	0,163	0,185	0,200
	1	5 x D	0,05 x D	150	–	540	fz	0,097	0,117	0,134	0,163	0,185	0,200
	2	5 x D	0,05 x D	140	–	513	fz	0,097	0,117	0,134	0,163	0,185	0,200
	3	5 x D	0,05 x D	120	–	432	fz	0,081	0,098	0,114	0,141	0,164	0,184
	4	5 x D	0,05 x D	90	–	405	fz	0,073	0,087	0,101	0,124	0,143	0,158
	5	5 x D	0,05 x D	60	–	270	fz	0,065	0,078	0,091	0,113	0,131	0,147
M	6	5 x D	0,05 x D	50	–	202,5	fz	0,054	0,065	0,075	0,092	0,105	0,115
	1	5 x D	0,05 x D	90	–	310,5	fz	0,081	0,098	0,114	0,141	0,164	0,184
	2	5 x D	0,05 x D	60	–	216	fz	0,065	0,078	0,091	0,113	0,131	0,147
K	3	5 x D	0,05 x D	60	–	189	fz	0,054	0,065	0,075	0,092	0,105	0,115
	1	5 x D	0,05 x D	120	–	405	fz	0,097	0,117	0,134	0,163	0,185	0,200
	2	5 x D	0,05 x D	110	–	378	fz	0,081	0,098	0,114	0,141	0,164	0,184
S	3	5 x D	0,05 x D	110	–	351	fz	0,065	0,078	0,091	0,113	0,131	0,147
	1	5 x D	0,05 x D	50	–	243	fz	0,081	0,098	0,114	0,141	0,164	0,184
	2	5 x D	0,05 x D	25	–	108	fz	0,043	0,052	0,060	0,075	0,087	0,099
H	3	5 x D	0,05 x D	25	–	108	fz	0,043	0,052	0,060	0,075	0,087	0,099
	4	5 x D	0,05 x D	50	–	162	fz	0,060	0,072	0,084	0,104	0,120	0,135
	1	5 x D	0,05 x D	80	–	378	fz	0,073	0,087	0,101	0,124	0,143	0,158
H	2	5 x D	0,05 x D	70	–	324	fz	0,054	0,065	0,075	0,092	0,105	0,115

NOTE: Lower value of cutting speed is used for high stock removal applications or for higher hardness (machinability) within group.
 Higher value of cutting speed is used for finishing applications or for lower hardness (machinability) within group.
 Side milling applications – for longest reach (L3) tools, reduce Ae by 30%.
 For better surface finish, reduce feed per tooth.

KOR5 DS & KOR6 DT • Adjustment Factor for Feed and Speed Calculation • Metric

	Ae/D	2%	4%	5%	8%	10%	12%	20%	30%	40%	50%	100%
Speed factor	Kv	2,1–3,6	1,6–3	1,6–2,5	1,6	1,4	1,38	1,3	1,2	1,1	1	0,9
Feed factor	KFz	3,58	2,56	2,3	1,84	1,67	1,54	1,25	1,09	1,02	1	1

NOTE: For an Ae/D ratio of 5% or less there is a range given for speed factor Kv, which allows the user to either be more conservative at the lower value or more aggressive with the higher value.
 This can also be considered based on the machinability of the material, from difficult to free cutting.
 These calculations are for roughing/semi-finishing cuts when used with the recommended base Fz.
 For light finishing cuts requiring improved surface quality it is recommended to reduce the base Fz approximately 50% and then apply these factors.

To calculate application specific cutting data, please use KV coefficient table to the right for adaptation of cutting speed and KFz for feed respectively.

Vc new = Vc * Kv
 Fz new = IPT * KFz

Calculation example:

Application: D1 = 25mm, KOR5^{DS} / KOR6^{DT} 3 x D;
 P5 material group;
 Ae 2,5mm (Ae = 10% of D1)
 Cutting data recommendation: 220m/min;
 Fz = 0,109 mm/z
 Adjustment coefficients: Ae = 2,5mm equals 10%;
 Kv = 1,4; KFz = 1,67

Final cutting data recommendation:

Vc new = 220 * 1,4 = 308mm/min
 Fz new = 0,109 * 1,67 = 0,182mm/z

KOR5™ DA • Application Data • Metric



Material Group	A		B		K600			Recommended feed per tooth (fz = mm/th)					
	ap		ae		Cutting Speed – vc m/min			D1 – Diameter					
	ap	ae	ap	min	max	mm	10,0	12,0	16,0	20,0	25,0		
N	1	0,5 x D1	0,5 x D1	0,25 x D1	200	–	2000	fz	0,080	0,120	0,160	0,200	0,225
	2	0,5 x D1	0,5 x D1	0,25 x D1	200	–	1500	fz	0,070	0,110	0,140	0,180	0,213

NOTE: These guidelines may require variations to achieve optimum results. For better surface finish, reduce feed per tooth.
 For cutting aluminum with high silicon, TiCN coating is recommended.
 Ap for milling machine with ceramic bearings spindle, multiply by 0,5.
 Above parameters are based on ideal conditions. For smaller taper machining centers, please adjust parameters accordingly on >12mm diameter.

KOR5™ DA • Adjustment Factor Table for Feed Calculation • Metric

Ae/D1	2%	5%	10%	20%	30%	40%	50%	100%
Max Ap	Ap1 Max	Ap1 Max	Ap1 Max	Ap1 Max	2 x D1	1 x D1	0,5 x D1	0,25 x D1
Feed Multiplier (KFz)	3,60	2,30	1,70	1,25	1,09	1,02	1,00	0,90

To calculate application specific cutting data, please use Kv coefficient table to the right for adaptation of cutting speed and KFz for feed respectively.

$Fz_{new} = IPT \cdot KFz$

Calculation example:

Application: D1 = 25mm;
 N2 material group;
 Ae 2,5mm (Ae = 10% of D1)
 Cutting data recommendation: 1500m/min;
 Fz = 0,213 mm/z
 Adjustment coefficients: Ae = 2,5mm equals 10%;
 KFz = 1,70

Final cutting data recommendation:

$Fz_{new} = 0,213 \cdot 1,70 = 0,362 \text{ mm/z}$

Online Catalog

Can't find your paper copy of our catalog anymore?
No worries. Go to catalogs.kennametal.com to see what's out there.

Search for what you need, watch a video, and share pages with others, all from one site! Go to catalogs.kennametal.com, and if you want to check it out on your mobile device, just download the FREE app for iOS or Android™.

1 Search for what you need

2 Watch videos

3 Share with others

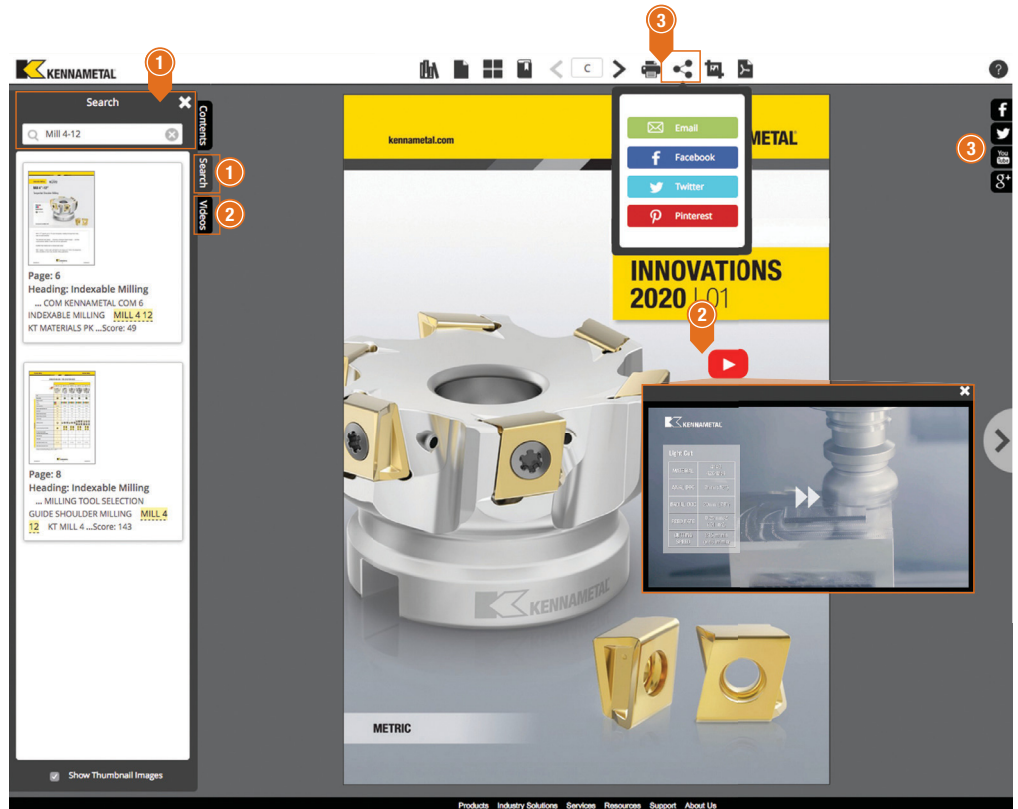

Check out our new catalog app.
Available in the Google Play™ Store or
the App Store®.





















Tool Selector

ROUGHERS							
KenCut™ RR							
Series	F3BH-F4BJ-F5BJ-WSMLX	F3BH-F4BJ-WSMLX	RUDC	F3BH-DL	F3BS-DK-DL	F4BJ-DL	F4BJ-F6BJ-DL
Page	66	66	67	67	68	68	69
Tool type							
Rougher	●	●	●	●	●	●	●
Finisher						○	○
Chamfering							
Main operations							
Workpiece material							
Primary	P M K	P M K	P M K S	P M K	P M K	P M	P M K
Secondary	H	H	H		H	K S H	S H
Corner style							
Corner radius [Rε]	—	—	—	0,45mm	—	—	—
Corner chamfer width [BCH]	0,30–0,50mm	0,30–0,50mm	0,30–0,50mm	0,10–0,40mm	—	0,10–0,40mm	0,10–0,40mm
Cutting diameter [D1]	4–25mm	8–20mm	4–25mm	4–16mm	6–20mm	6–20mm	6–25mm
Length of cut	1,1–2,8 x D	1,2–2,2x D	1,8–2,6 x D	1,6–2 x D	1,6–2 x D	1,9–2,4 x D	1,8–2,4 x D
Maximum cutting depth [Ap1 max]	8–45mm	11–38mm	8–45mm	8–26mm	10–38mm	13–38mm	13–45mm
Flute helix angle	20°	20°	30°	30°	35°	30°	45°
Number of flutes [ZU]	3–5	3–4	3–5	3	3	4	4–6
Center cutting	✓	✓	✓	✓	✓	✓	
Additional operations				 	 	 	

- Primary
- Secondary

Tool Selector

FINISHERS				
KenCut™ FF				
				
Series	F3AS-DK	F6AJ-F8AJ-DL	F8AJ-F10AJ-DK	RSM II FSDE Short
Page	kennametal.com	kennametal.com	kennametal.com	kennametal.com
Tool type				
Rougher				
Finisher	●	●	●	●
Chamfering				
Main operations				
Workpiece material				
Primary	P M K	P M K	P M K	M S
Secondary	H	H	H	P H
Corner style				
Corner radius [Rε]	0,25–0,45mm	—	1,00mm	0,50–6,00mm
Corner chamfer width [BCH]	—	0,10–0,40mm	—	—
Cutting diameter [D1]	3–16mm	6–25mm	8–20mm	10–25mm
Length of cut	1–1,3 x D	2–3 x D	1 x D	2 x D
Maximum cutting depth [Ap1 max]	4–16mm	13–75mm	8–20mm	20–50mm
Flute helix angle	35°	45°	45°	36°
Number of flutes [ZU]	3	6-8	8–10	9–19
Center cutting	✓		✓	
Additional operations	  			

- Primary
- Secondary

KenCut™ RR

High-Performance Roughing



Materials



Applications



Ramping



Shoulder Milling



Slotting: Square End



Plunge Milling

Solid carbide end mill with roughing geometries for low cutting forces and low spindle power consumption even in unstable conditions.

The KenCut RR solid carbide end mill series is designed for high metal removal rates in a wide range of workpiece materials such as steels, stainless steels, cast irons, high-temperature alloys, and in certain cases, hardened materials.

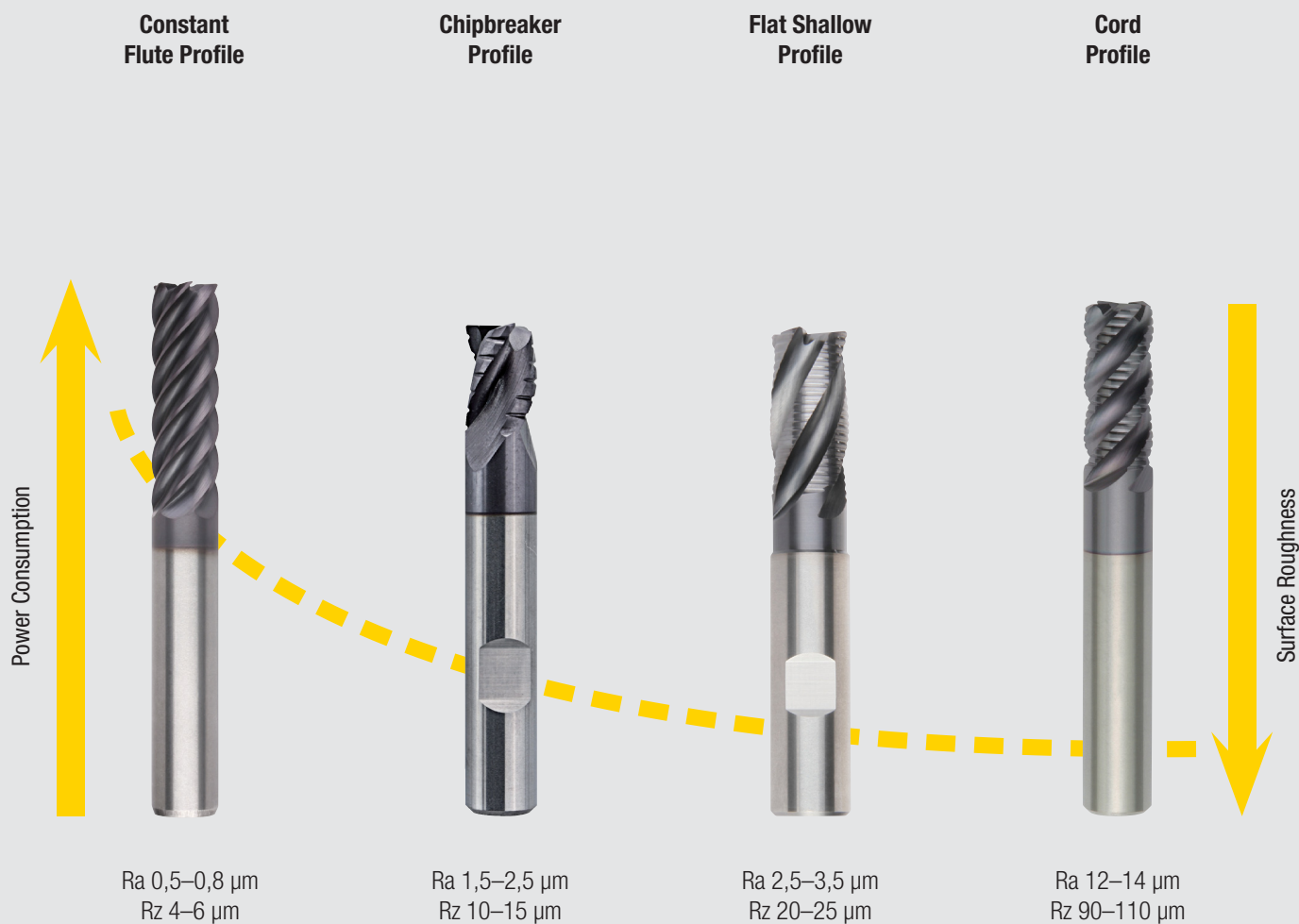

Tailored geometries for low cutting forces and low spindle power consumption.
 Center cutting for plunging, ramping, profiling, high-feed slotting, and side milling.
 Roughing and semi-finishing for fewer tool changes and less downtime.
 Internal coolant for improved chip evacuation and extended tool life.

KenCut™ RR • F3BH-F4BJ-F5BJ-WSMLX • Chamfered • 3–5 Flutes • Weldon® Shank • Metric

- first choice
- alternate choice

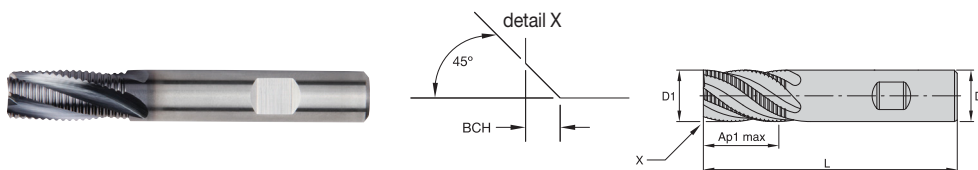

P	●
M	●
K	●
N	●
S	●
H	○

order number	catalogue number	D1	D	Ap1 max	L	BCH	Z U	KCPM15
4047065	F3BH0400BWS20L110	4,00	6,00	11,00	55,00	0,30	3	●
4047066	F3BH0500BWS20L130	5,00	6,00	13,00	57,00	0,30	3	●
4047067	F3BH0600BWS20L080	6,00	6,00	8,00	54,00	0,30	3	●
4047068	F3BH0600BWS20L130	6,00	6,00	13,00	57,00	0,30	3	●
4047070	F3BH0800BWS20L110	8,00	8,00	11,00	58,00	0,30	3	●
4047069	F3BH0800BWM20L160	8,00	8,00	16,00	63,00	0,30	3	●
4047071	F4BJ1000BWM20L130	10,00	10,00	13,00	66,00	0,50	4	●
4047072	F4BJ1000BWM20L220	10,00	10,00	22,00	72,00	0,50	4	●
4047074	F4BJ1200BWM20L160	12,00	12,00	16,00	73,00	0,50	4	●
4047073	F4BJ1200BWL20L260	12,00	12,00	26,00	83,00	0,50	4	●
4047075	F4BJ1400BWL20L260	14,00	14,00	26,00	83,00	0,50	4	●
4047076	F4BJ1600BWL20L190	16,00	16,00	19,00	82,00	0,50	4	●
4047077	F4BJ1600BWL20L320	16,00	16,00	32,00	92,00	0,50	4	●
4047078	F4BJ2000BWL20L220	20,00	20,00	22,00	92,00	0,50	4	●
4047079	F4BJ2000BWX20L380	20,00	20,00	38,00	104,00	0,50	4	●
4047080	F5BJ2500BWX20L450	25,00	25,00	45,00	121,00	0,50	5	●

KenCut RR • F3BH-F4BJ-WSMLX • Chamfered • 3–4 Flutes • Internal Coolant • Weldon® Shank • Metric

- first choice
- alternate choice

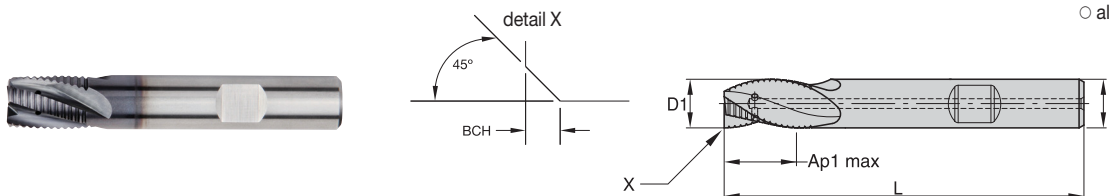

P	●
M	●
K	●
N	●
S	●
H	○

order number	catalogue number	D1	D	Ap1 max	L	BCH	Z U	KCPM15
4046468	F3BH0800BWS20C110	8,00	8,00	11,00	58,00	0,30	3	●
4046467	F3BH0800BWM20C160	8,00	8,00	16,00	63,00	0,30	3	●
4046469	F4BJ1000BWM20C130	10,00	10,00	13,00	66,00	0,50	4	●
4046470	F4BJ1000BWM20C220	10,00	10,00	22,00	72,00	0,50	4	●
4046472	F4BJ1200BWM20C160	12,00	12,00	16,00	73,00	0,50	4	●
4046471	F4BJ1200BWL20C260	12,00	12,00	26,00	83,00	0,50	4	●
4046484	F4BJ1600BWL20C320	16,00	16,00	32,00	92,00	0,50	4	●
4046486	F4BJ2000BWX20C380	20,00	20,00	38,00	104,00	0,50	4	●

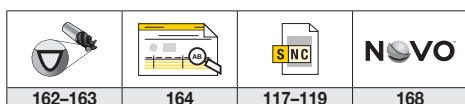

KenCut™ RR • RUDC • Chamfered • 3 Flutes • With Neck • Weldon® Shank • Metric

● first choice
○ alternate choice

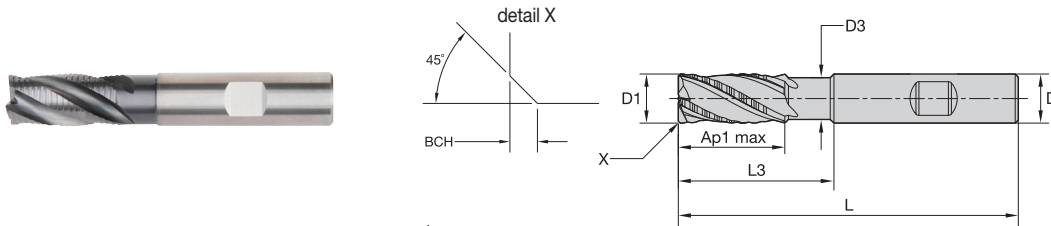

P	●
M	●
K	●
N	●
S	●
H	○

order number	catalogue number	D1	D	D3	Ap1 max	L3	L	BCH	KCPM15
5357041	RUDC0400B3BN	4,00	6,00	3,60	8,00	21,00	57,00	0,30	●
5357042	RUDC0500B3BN	5,00	6,00	4,60	13,00	21,00	57,00	0,30	●
5357043	RUDC0600B3BN	6,00	6,00	5,50	13,00	21,00	57,00	0,30	●
5357044	RUDC0800B3BN	8,00	8,00	7,50	16,00	27,00	63,00	0,30	●
5357045	RUDC1000B4BN	10,00	10,00	9,50	22,00	32,00	72,00	0,50	●
5357046	RUDC1200B4BN	12,00	12,00	11,00	26,00	38,00	83,00	0,50	●
5357047	RUDC1400B4BN	14,00	14,00	13,00	26,00	38,00	83,00	0,50	●
5357048	RUDC1600B4BN	16,00	16,00	15,00	32,00	44,00	92,00	0,50	●
5357049	RUDC1800B4BN	18,00	18,00	17,00	32,00	44,00	92,00	0,50	●
5357090	RUDC2000B4BN	20,00	20,00	19,00	38,00	54,00	104,00	0,50	●
5357091	RUDC2500B5BN	25,00	25,00	24,00	45,00	65,00	121,00	0,50	●

KenCut RR • F3BH-DL • Chamfered • 3 Flutes • Long • Weldon® Shank • Metric

● first choice
○ alternate choice

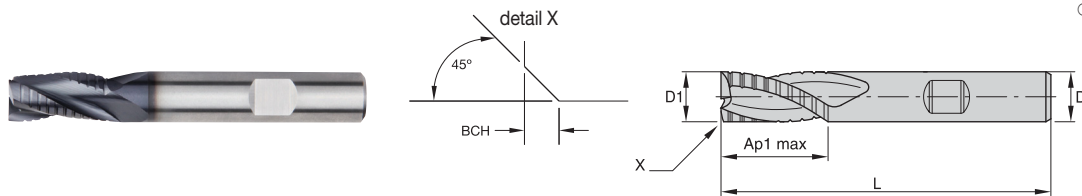

P	●
M	●
K	●
N	●
S	●
H	○

order number	catalogue number	D1	D	Ap1 max	L	BCH	KCPM15
4046458	F3BH0400BDL30	4,00	6,00	8,00	57,00	0,10	●
4046459	F3BH0500BDL30	5,00	6,00	13,00	57,00	0,10	●
4046460	F3BH0600BDL30	6,00	6,00	10,00	57,00	0,10	●
4046461	F3BH0800BDL30	8,00	8,00	16,00	63,00	0,20	●
4046462	F3BH1000BDL30	10,00	10,00	19,00	72,00	0,30	●
4046463	F3BH1200BDL30	12,00	12,00	22,00	83,00	0,30	●
4046464	F3BH1600BDL30	16,00	16,00	26,00	92,00	0,40	●

162-163	164	117-119	168

KenCut™ RR • F3BS-DL • Radiused • 3 Flutes • Short • Long • Weldon® Shank • Metric

- first choice
- alternate choice

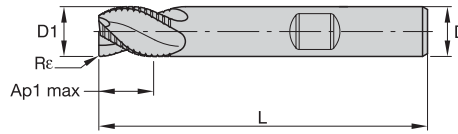
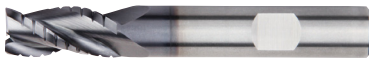

P	●
M	●
K	●
N	●
S	●
H	○

order number	catalogue number	D1	D	Ap1 max	L	Re	KCPM15
4046479	F3BS0600BDL35	6,00	6,00	10,00	57,00	0,45	●
4046481	F3BS0800BDL35	8,00	8,00	16,00	63,00	0,45	●
4046493	F3BS1000BDL35	10,00	10,00	19,00	72,00	0,45	●
4046495	F3BS1200BDL35	12,00	12,00	22,00	83,00	0,45	●

KenCut RR • F4BJ-DL • Chamfered • 4 Flutes • Short • Long • Weldon® Shank • Metric

- first choice
- alternate choice

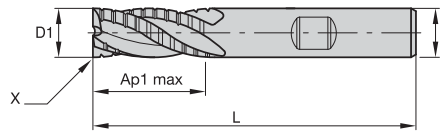
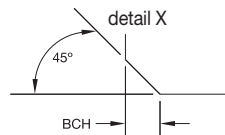
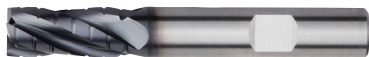

P	●
M	●
K	○
N	○
S	○
H	○

order number	catalogue number	D1	D	Ap1 max	L	BCH	KCPM15
4046856	F4BJ0600BDL30	6,00	6,00	13,00	57,00	0,10	●
4046857	F4BJ0800BDL30	8,00	8,00	19,00	63,00	0,20	●
4046858	F4BJ1000BDL30	10,00	10,00	22,00	72,00	0,30	●
4046859	F4BJ1200BDL30	12,00	12,00	26,00	83,00	0,30	●
4046860	F4BJ1400BDL30	14,00	14,00	26,00	83,00	0,30	●
4046861	F4BJ1600BDL30	16,00	16,00	32,00	92,00	0,40	●
4046862	F4BJ1800BDL30	18,00	18,00	32,00	92,00	0,40	●
4047063	F4BJ2000BDL30	20,00	20,00	38,00	104,00	0,40	●

162-163	164	117-119	168

KenCut™ RR • F4BJ-F6BJ-DL • Chamfered • 4 Flutes • Long • Weldon® Shank • Metric

- first choice
- alternate choice

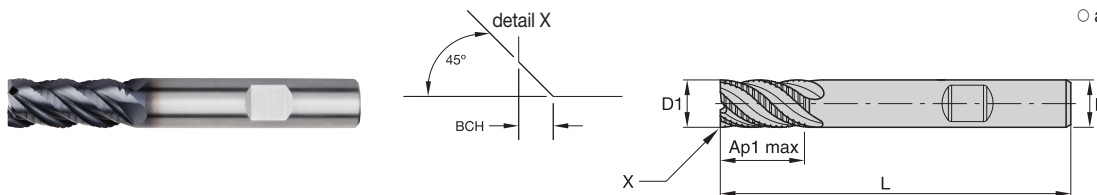

P	●
M	●
K	●
N	●
S	○
H	○

order number	catalogue number	D1	D	Ap1 max	L	BCH	KCPM15
4047275	F4BJ0600BDL45	6,00	6,00	13,00	57,00	0,10	●
4047276	F4BJ0800BDL45	8,00	8,00	19,00	63,00	0,20	●
4047277	F4BJ1000BDL45	10,00	10,00	22,00	72,00	0,30	●
4047278	F4BJ1200BDL45	12,00	12,00	26,00	83,00	0,30	●
4047279	F6BJ1600BDL45	16,00	16,00	32,00	92,00	0,40	●
4047280	F6BJ2000BDL45	20,00	20,00	38,00	104,00	0,40	●
4047281	F6BJ2500BDL45	25,00	25,00	45,00	121,00	0,40	●

KenCut RR • F3BH-F4BJ-F5BJ...WS-WM-WL-WX • Application Data • Metric



KenCut RR – F3BH-F4BJ-F5BJ...WS-WM-WL-WX



KenCut RR – F3BH-F4BJ...WS-WM-WL-WX • Internal Coolant

Material Group	A		B		Cutting Speed – vc m/min		Recommended feed per tooth (fz = mm/th) for side milling (A). For slotting (B), reduce fz by 20%.											
	ap		ap		min	max	D1 – Diameter											
	ap	ae	ap	ap	mm	4,0	5,0	6,0	8,0	10,0	12,0	14,0	16,0	18,0	20,0	25,0		
P	0	1,5 x D	0,5 x D	1 x D	150	200	fz	0,024	0,031	0,037	0,051	0,061	0,070	0,079	0,086	0,092	0,097	0,105
	1	1,5 x D	0,5 x D	1 x D	150	200	fz	0,024	0,031	0,037	0,051	0,061	0,070	0,079	0,086	0,092	0,097	0,105
	2	1,5 x D	0,5 x D	1 x D	140	190	fz	0,024	0,031	0,037	0,051	0,061	0,070	0,079	0,086	0,092	0,097	0,105
	3	1,5 x D	0,4 x D	0,75 x D	120	160	fz	0,020	0,025	0,031	0,043	0,051	0,060	0,067	0,074	0,080	0,086	0,097
	4	1,5 x D	0,3 x D	0,3 x D	90	150	fz	0,018	0,023	0,028	0,038	0,046	0,053	0,060	0,065	0,070	0,075	0,083
M	5	1,5 x D	0,4 x D	0,75 x D	60	100	fz	0,016	0,021	0,025	0,034	0,041	0,048	0,054	0,059	0,064	0,069	0,077
	1	1,5 x D	0,4 x D	0,75 x D	90	115	fz	0,020	0,025	0,031	0,043	0,051	0,060	0,067	0,074	0,080	0,086	0,097
	2	1,5 x D	0,4 x D	0,75 x D	60	80	fz	0,016	0,021	0,025	0,034	0,041	0,048	0,054	0,059	0,064	0,069	0,077
K	3	1,5 x D	0,4 x D	0,75 x D	60	70	fz	0,014	0,017	0,021	0,029	0,034	0,040	0,044	0,048	0,052	0,055	0,060
	1	1,5 x D	0,5 x D	1 x D	120	150	fz	0,024	0,031	0,037	0,051	0,061	0,070	0,079	0,086	0,092	0,097	0,105
	2	1,5 x D	0,4 x D	1 x D	110	140	fz	0,020	0,025	0,031	0,043	0,051	0,060	0,067	0,074	0,080	0,086	0,097
H	3	1,5 x D	0,4 x D	1 x D	110	130	fz	0,016	0,021	0,025	0,034	0,041	0,048	0,054	0,059	0,064	0,069	0,077
	1	1,5 x D	0,3 x D	0,3 x D	80	140	fz	0,018	0,023	0,028	0,038	0,046	0,053	0,060	0,065	0,070	0,075	0,083

NOTE: Those guidelines may require variations to achieve optimum results.
 Lower value of cutting speed is used for high stock removal applications or for higher hardness (machinability) within group.
 Higher value of cutting speed is used for finishing applications or for lower hardness (machinability) within group.
 Above parameters are based on ideal conditions. For smaller taper machining centers, please adjust parameters accordingly on >12mm diameter.

162-163	164	117-119	168

KenCut™ RR • RUDC • Application Data • Metric



Material Group					KCPM15		Recommended feed per tooth (fz = mm/th) for side milling (A). For slotting (B), reduce fz by 10%.											
	A		B		Cutting Speed – vc m/min		mm	D1 – Diameter										
	ap	ae	ap		min	max		4,0	5,0	6,0	8,0	10,0	12,0	14,0	16,0	18,0	20,0	25,0
P	0	1,5 x D	0,5 x D	1 x D	150	200	fz	0,024	0,031	0,037	0,051	0,061	0,070	0,079	0,086	0,092	0,097	0,105
	1	1,5 x D	0,5 x D	1 x D	150	200	fz	0,024	0,031	0,037	0,051	0,061	0,070	0,079	0,086	0,092	0,097	0,105
	2	1,5 x D	0,5 x D	1 x D	140	190	fz	0,024	0,031	0,037	0,051	0,061	0,070	0,079	0,086	0,092	0,097	0,105
	3	1,5 x D	0,4 x D	0,75 x D	120	160	fz	0,020	0,025	0,031	0,043	0,051	0,060	0,067	0,074	0,080	0,086	0,097
	4	1,5 x D	0,3 x D	0,3 x D	90	150	fz	0,018	0,023	0,028	0,038	0,046	0,053	0,060	0,065	0,070	0,075	0,083
M	1	1,5 x D	0,4 x D	0,75 x D	90	115	fz	0,020	0,025	0,031	0,043	0,051	0,060	0,067	0,074	0,080	0,086	0,097
	2	1,5 x D	0,4 x D	0,75 x D	60	80	fz	0,016	0,021	0,025	0,034	0,041	0,048	0,054	0,059	0,064	0,069	0,077
	3	1,5 x D	0,4 x D	0,75 x D	60	70	fz	0,014	0,017	0,021	0,029	0,034	0,040	0,044	0,048	0,052	0,055	0,060
K	1	1,5 x D	0,5 x D	1 x D	120	150	fz	0,024	0,031	0,037	0,051	0,061	0,070	0,079	0,086	0,092	0,097	0,105
	2	1,5 x D	0,4 x D	1 x D	110	140	fz	0,020	0,025	0,031	0,043	0,051	0,060	0,067	0,074	0,080	0,086	0,097
	3	1,5 x D	0,4 x D	1 x D	110	130	fz	0,016	0,021	0,025	0,034	0,041	0,048	0,054	0,059	0,064	0,069	0,077
S	1	1,5 x D	0,4 x D	0,75 x D	50	90	fz	0,020	0,025	0,031	0,043	0,051	0,060	0,067	0,074	0,080	0,086	0,097
	3	1,5 x D	0,3 x D	0,3 x D	25	40	fz	0,011	0,014	0,017	0,022	0,027	0,032	0,036	0,039	0,043	0,046	0,052
H	1	1,5 x D	0,3 x D	0,3 x D	80	140	fz	0,018	0,023	0,028	0,038	0,046	0,053	0,060	0,065	0,070	0,075	0,083

NOTE: Lower value of cutting speed is used for high stock removal applications or for higher hardness (machinability) within group.
Higher value of cutting speed is used for finishing applications or for lower hardness (machinability) within group.
Above parameters are based on ideal conditions. For smaller taper machining centers, please adjust parameters accordingly on >12mm diameter.

KenCut RR • F3BH...DL • Application Data • Metric

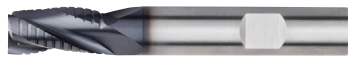



Material Group					KCPM15		Recommended feed per tooth (fz = mm/th) for side milling (A). For slotting (B), reduce fz by 10%.							
	A		B		Cutting Speed – vc m/min		mm	D1 – Diameter						
	ap	ae	ap		min	max		4,0	6,0	8,0	10,0	12,0	16,0	20,0
P	1	1 x D	0,4 x D	0,75 x D	150	200	fz	0,028	0,044	0,060	0,072	0,083	0,101	0,114
	2	1 x D	0,4 x D	0,75 x D	140	190	fz	0,028	0,044	0,060	0,072	0,083	0,101	0,114
	3	1 x D	0,4 x D	0,75 x D	120	160	fz	0,023	0,036	0,050	0,061	0,070	0,087	0,101
	4	1 x D	0,3 x D	0,3 x D	90	150	fz	0,021	0,033	0,045	0,054	0,062	0,077	0,088
	5	1 x D	0,4 x D	0,75 x D	60	100	fz	0,019	0,029	0,040	0,048	0,056	0,070	0,081
	6	1 x D	0,3 x D	0,3 x D	50	75	fz	0,016	0,025	0,034	0,040	0,047	0,057	0,065
M	1	1 x D	0,4 x D	0,75 x D	80	100	fz	0,023	0,036	0,050	0,061	0,070	0,087	0,101
	2	1 x D	0,4 x D	0,75 x D	60	80	fz	0,019	0,029	0,040	0,048	0,056	0,070	0,081
	3	1 x D	0,4 x D	0,75 x D	60	80	fz	0,016	0,025	0,034	0,040	0,047	0,057	0,065
K	1	1 x D	0,4 x D	0,75 x D	120	160	fz	0,028	0,044	0,060	0,072	0,083	0,101	0,114
	2	1 x D	0,4 x D	0,75 x D	110	140	fz	0,023	0,036	0,050	0,061	0,070	0,087	0,101
	3	1 x D	0,4 x D	0,75 x D	100	130	fz	0,019	0,029	0,040	0,048	0,056	0,070	0,081

NOTE: Lower value of cutting speed is used for high stock removal applications or for higher hardness (machinability) within group.
Higher value of cutting speed is used for finishing applications or for lower hardness (machinability) within group.
Above parameters are based on ideal conditions. For smaller taper machining centers, please adjust parameters accordingly on >12mm diameter.

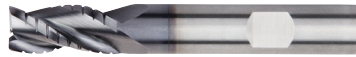
KenCut™ RR • F3BS...DK-DL • Application Data • Metric





Material Group						KCPM15		Recommended feed per tooth (fz = mm/th) for side milling (A). For slotting (B), reduce fz by 20%.					
		A		B		Cutting Speed – vc m/min		D1 – Diameter					
		ap	ae	ap	min	max	mm	6,0	8,0	10,0	12,0	16,0	20,0
P	1	1 x D	0,4 x D	0,75 x D	150	200	fz	0,044	0,060	0,072	0,083	0,101	0,114
	2	1 x D	0,4 x D	0,75 x D	140	190	fz	0,044	0,060	0,072	0,083	0,101	0,114
	3	1 x D	0,4 x D	0,75 x D	120	160	fz	0,036	0,050	0,061	0,070	0,087	0,101
	4	1 x D	0,3 x D	0,3 x D	90	150	fz	0,033	0,045	0,054	0,062	0,077	0,088
	5	1 x D	0,4 x D	0,75 x D	60	100	fz	0,029	0,040	0,048	0,056	0,070	0,081
	6	1 x D	0,3 x D	0,3 x D	50	75	fz	0,025	0,034	0,040	0,047	0,057	0,065
M	1	1 x D	0,4 x D	0,75 x D	80	100	fz	0,036	0,050	0,061	0,070	0,087	0,101
	2	1 x D	0,4 x D	0,75 x D	60	80	fz	0,029	0,040	0,048	0,056	0,070	0,081
	3	1 x D	0,4 x D	0,75 x D	60	80	fz	0,025	0,034	0,040	0,047	0,057	0,065
K	1	1 x D	0,4 x D	0,75 x D	120	160	fz	0,044	0,060	0,072	0,083	0,101	0,114
	2	1 x D	0,4 x D	0,75 x D	110	140	fz	0,036	0,050	0,061	0,070	0,087	0,101
	3	1 x D	0,4 x D	0,75 x D	100	130	fz	0,029	0,040	0,048	0,056	0,070	0,081
H	1	1 x D	0,3 x D	0,3 x D	100	140	fz	0,033	0,045	0,054	0,062	0,077	0,088

NOTE: Lower value of cutting speed is used for high stock removal applications or for higher hardness (machinability) within group.
Higher value of cutting speed is used for finishing applications or for lower hardness (machinability) within group.
Above parameters are based on ideal conditions. For smaller taper machining centers, please adjust parameters accordingly on >12mm diameter.

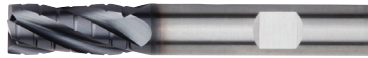
KenCut RR • F4BJ...DL • Application Data • Metric



Material Group						KCPM15		Feed per Tooth – fz information is for side milling (A). For slotting (B), reduce fz by 20%.							
		A		B		Cutting Speed – vc m/min		D1 – Diameter							
		ap	ae	ap	min	max	mm	4,0	5,0	6,0	8,0	10,0	12,0	16,0	20,0
P	3	0,8 x D	0,5 x D	0,75 x D	160	180	fz	0,020	0,025	0,031	0,043	0,051	0,063	0,078	0,101
	4	0,8 x D	0,4 x D	0,5 x D	140	160	fz	0,018	0,023	0,028	0,038	0,046	0,056	0,069	0,088
	5	0,8 x D	0,5 x D	0,75 x D	60	100	fz	0,016	0,021	0,025	0,034	0,041	0,051	0,063	0,081
	6	0,8 x D	0,4 x D	0,5 x D	50	80	fz	0,014	0,017	0,021	0,029	0,034	0,042	0,051	0,065
M	1	0,8 x D	0,5 x D	0,75 x D	80	100	fz	0,020	0,025	0,031	0,043	0,051	0,063	0,078	0,101
	2	0,8 x D	0,4 x D	0,75 x D	60	80	fz	0,016	0,021	0,025	0,034	0,041	0,051	0,063	0,081
	3	0,8 x D	0,4 x D	0,75 x D	60	80	fz	0,014	0,017	0,021	0,029	0,034	0,042	0,051	0,065
K	1	0,8 x D	0,5 x D	0,75 x D	120	160	fz	0,024	0,031	0,037	0,051	0,061	0,075	0,091	0,114
	2	0,8 x D	0,5 x D	0,75 x D	110	140	fz	0,020	0,025	0,031	0,043	0,051	0,063	0,078	0,101
	3	0,8 x D	0,4 x D	0,75 x D	100	130	fz	0,016	0,021	0,025	0,034	0,041	0,051	0,063	0,081
S	1	0,8 x D	0,4 x D	0,75 x D	90	115	fz	0,020	0,025	0,031	0,043	0,051	0,063	0,078	0,101
	2	0,8 x D	0,25 x D	0,3 x D	20	40	fz	0,011	0,014	0,017	0,022	0,027	0,033	0,042	0,054
	3	0,8 x D	0,4 x D	0,75 x D	50	80	fz	0,016	0,021	0,025	0,034	0,041	0,051	0,063	0,081
	4	0,8 x D	0,3 x D	0,5 x D	45	65	fz	0,013	0,018	0,022	0,031	0,038	0,046	0,058	0,074
H	1	0,8 x D	0,5 x D	0,5 x D	120	140	fz	0,018	0,023	0,028	0,038	0,046	0,056	0,069	0,088
	2	0,8 x D	0,2 x D	0,3 x D	80	130	fz	0,014	0,017	0,021	0,029	0,034	0,042	0,051	0,065
	3	0,8 x D	0,15 x D	0,2 x D	70	100	fz	0,011	0,014	0,017	0,023	0,027	0,034	0,041	0,052

NOTE: Toes guidelines may require possible variations to achieve optimum results.
Lower value of cutting speed is used for high stock removal applications or for higher hardness (machinability) within group.
Higher value of cutting speed is used for finishing applications or for lower hardness (machinability) within group.
For rougher tool with six flutes, use Ap in slotting 60% of table value
Above parameters are based on ideal conditions. For smaller taper machining centers, please adjust parameters accordingly on >12mm diameter.

KenCut™ RR • F4BJ-F6BJ...DL • Application Data • Metric

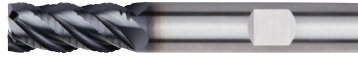

Material Group						KCPM15		Recommended feed per tooth (fz = mm/th) for side milling (A). For slotting (B), reduce fz by 20%.						
		A		B	Cutting Speed – vc m/min		mm	D1 – Diameter						
		ap	ae	ap	min	max		6,0	8,0	10,0	12,0	16,0	20,0	25,0
P	3	1,0 x D	0,5 x D	0,75 x D	120	160	fz	0,036	0,050	0,061	0,070	0,087	0,101	0,114
	4	1,0 x D	0,3 x D	0,75 x D	90	150	fz	0,033	0,045	0,054	0,062	0,077	0,088	0,098
	5	1,0 x D	0,5 x D	0,75 x D	60	100	fz	0,029	0,040	0,048	0,056	0,070	0,081	0,091
M	6	1,0 x D	0,3 x D	0,3 x D	50	75	fz	0,025	0,034	0,040	0,047	0,057	0,065	0,071
	1	1,0 x D	0,5 x D	0,75 x D	80	100	fz	0,036	0,050	0,061	0,070	0,087	0,101	0,114
	2	1,0 x D	0,5 x D	0,75 x D	60	80	fz	0,029	0,040	0,048	0,056	0,070	0,081	0,091
K	3	1,0 x D	0,5 x D	0,75 x D	60	80	fz	0,025	0,034	0,040	0,047	0,057	0,065	0,071
	1	1,0 x D	0,5 x D	1 x D	120	160	fz	0,044	0,060	0,072	0,083	0,101	0,114	0,124
	2	1,0 x D	0,5 x D	1 x D	110	140	fz	0,036	0,050	0,061	0,070	0,087	0,101	0,114
S	3	1,0 x D	0,5 x D	1 x D	100	130	fz	0,029	0,040	0,048	0,056	0,070	0,081	0,091
	1	1,0 x D	0,3 x D	0,75 x D	50	90	fz	0,036	0,050	0,061	0,070	0,087	0,101	0,114
	2	1,0 x D	0,3 x D	0,75 x D	50	90	fz	0,019	0,026	0,032	0,037	0,046	0,054	0,061
	3	1,0 x D	0,3 x D	0,75 x D	20	40	fz	0,019	0,026	0,032	0,037	0,046	0,054	0,061
H	4	1,0 x D	0,4 x D	0,75 x D	45	65	fz	0,026	0,037	0,045	0,052	0,064	0,074	0,084
	1	1,0 x D	0,3 x D	0,3 x D	80	140	fz	0,033	0,045	0,054	0,062	0,077	0,088	0,098
	2	1,0 x D	0,2 x D	0,2 x D	70	120	fz	0,025	0,034	0,040	0,047	0,057	0,065	0,071
	3	1,0 x D	0,2 x D	0,2 x D	60	90	fz	0,019	0,026	0,032	0,037	0,046	0,054	0,061

NOTE: Those guidelines may require variations to achieve optimum results.









































Lower value of cutting speed is used for high stock removal applications or for higher hardness (machinability) within group.

Higher value of cutting speed is used for finishing applications or for lower hardness (machinability) within group.

Above parameters are based on ideal conditions. For smaller taper machining centers, please adjust parameters accordingly on >12mm diameter.

















For rougher tool with 6 flutes, use Ap in slotting 60% of table value

Tool Selector

ALUMINUM MACHINING						
	MaxiMet™			KenCut™ AL		
						
Series	MaxiMet ABDF	MaxiMet ABDE	MaxiMet ABDE	F1AA...WS-M	F2AA-ADL45	F2AA-WMLX
Page	78	78	79	80	80	81
Tool type						
Rougher	○	○	○	○	○	○
Finisher	●	●	●	●	●	●
Chamfering						
Main operations						
Workpiece material						
Primary	N	N	N	N	N	N
Secondary						
Corner style						
Corner radius [R _e]	–	–	–	–	–	0,50–4,00mm
Corner chamfer width [BCH]	–	–	–	–	–	–
Cutting diameter [D1]	1,5–20mm	3–20mm	6–25mm	2–12mm	4–20mm	6–25mm
Length of cut	1,9–4 x D	1,9–4 x D	1,5 x D	2–5 x D	1,6–2 x D	1,5 x D
Maximum cutting depth [A _{p1} max]	6–38mm	12–38mm	9–37,5mm	10–25mm	8–32mm	9–37,5mm
Flute helix angle	45°	38°	38°	30°	45°	45°
Number of flutes [ZU]	2	3	3	1	2	2
Center cutting	✓	✓	✓	✓	✓	✓
Additional operations	   	   	   	 	   	   



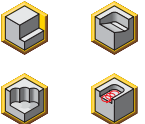

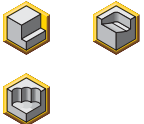
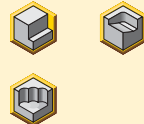













- Primary
- Secondary

Tool Selector

ALUMINUM MACHINING					
	KenCut™ AL		KenCut ALR		
					
Series	F3AA-AWSL45	F3AA-WSMLX	F3BA-WSMLX	F3BA-WSMLX	F3BA-DL
Page	81	82	83	83	kennametal.com
Tool type					
Rougher	○	○	●	●	●
Finisher	●	●			
Chamfering					
Main operations					
Workpiece material					
Primary	N	N	N	N	N
Secondary					
Corner style					
Corner radius [Rε]	—	0,50–4,00mm	0,25–1,50mm	0,25–1,50mm	0,25–1,00mm
Corner chamfer width [BCH]	—	—	—	—	—
Cutting diameter [D1]	3–20mm	6–25mm	6–25mm	8–25mm	6–20mm
Length of cut	1,9–4 x D	1,5 x D	1,8–2,1 x D	2 x D	1,3 x D
Maximum cutting depth [Ap1 max]	12–38mm	9–37,5mm	13–45mm	16–45mm	8–24mm
Flute helix angle	45°	45°	40°	30°	40°
Number of flutes [ZU]	3	3	3	3	3
Center cutting	✓	✓	✓	✓	✓
Additional operations					

- Primary
- Secondary

Tool Selector

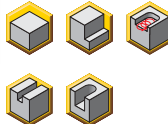
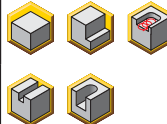
ALUMINUM MACHINING					
KenCut™ AQ					
					
Series	ALCB	ALCC	ALCR	ALSB	ALSR
Page	84	84	85	86	85
Tool type					
Rougher	●	●	●	●	●
Finisher	○	○	○	○	○
Chamfering					
Main operations					
Workpiece material					
Primary	N	N	N	N	N
Secondary					
Corner style					
Corner radius [Rε]	0,2–0,3mm	0,2–0,3mm	0,3mm	0,4mm	0,4mm
Corner chamfer width [BCH]	–	–	–	–	–
Cutting diameter [D1]	12–20mm	6–20mm	12–20mm	25–50mm	25–40mm
Length of cut	1 x D	1,5–2 x D	2 x D	0,5 x D	1 x 1,3 x D
Maximum cutting depth [Ap1 max]	6–20mm	10–28mm	24–40mm	15mm	32–50mm
Axial rake angle	3°	3°	9°–12°	6°	6°
Number of flutes [ZU]	2	2	2	4–5	2–3
Center cutting		✓	✓		
Additional operations					

- Primary
- Secondary

MaxiMet™ and KenCut™ A-Series

High-Performance Aluminum
Roughing and Finishing



Materials

N

Applications



Face Milling



Shoulder Milling



Trochoidal Milling



Slotting: Square End



Plunge Milling



Pocketing



Helical Milling



Plunge Milling:
Ball Nose



Ramping



Side/Shoulder Milling:
Slotting: Square End

Center-cutting design enables plunging, slotting, and profiling applications in any type of aluminum workpiece materials. Designed to deliver exceptional chip evacuation and generate the highest floor-to-wall straightness.

KenCut AL & ALR

Roughers with cord profile available.

Multiple corner radii and extended neck configurations available as standard.

KenCut AQ

Ideal for roughing and finishing operations, all tools are minimum quantity lubrication (MQL) ready.

The sharp cutting edges and low-friction rake surfaces guarantee high-quality surface finishes.

KenCut™ AL & ALR



One-, two-, and three-fluted roughers and finishers for a variety of aluminum applications.

MaxiMet™



The MaxiMet solid end mill series provides exceptional metal removal rates and combines roughing and finishing operations in any aluminum plunging, slotting, and profiling application.

KenCut AQ

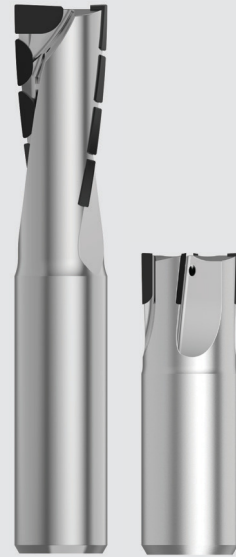

PCD tools for high-speed aluminum machining reduce machining time drastically, providing up to 10 times higher productivity compared to solid carbide solutions.

MaxiMet

Unequal three-flute spacing reduces vibrations and provides chatter-free machining.

1 x D slotting capability and side milling capability up to 0,5 x D radial and 1,5 x D axial engagement result in fewer tool passes and increased productivity.

Suitable for MQL (minimum quantity lubrication).

Exceptional wall-to-floor perpendicularity in thin-wall applications.

MaxiMet™ • Square End • 2 Flutes • Plain Shank • Metric

- first choice
- alternate choice

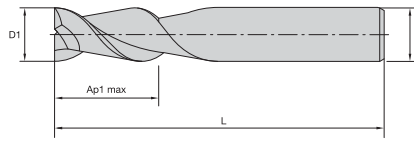

P	■	■
M	■	■
K	■	■
N	■	●
S	■	■
H	■	■

order number	catalogue number	D1	D	Ap1 max	L	K600
3637552	ABDF0150A2AS	1,50	3,00	6,00	38,00	●
3637553	ABDF0200A2AS	2,00	3,00	8,00	38,00	●
3637554	ABDF0250A2AS	2,50	3,00	9,00	38,00	●
3637555	ABDF0300A2AS	3,00	3,00	12,00	38,00	●
3637556	ABDF0400A2AS	4,00	4,00	12,00	50,00	●
3637557	ABDF0500A2AS	5,00	6,00	14,00	50,00	●
3637558	ABDF0600A2AS	6,00	6,00	16,00	50,00	●
3637559	ABDF0800A2AS	8,00	8,00	20,00	63,00	●
3637560	ABDF1000A2AS	10,00	10,00	22,00	76,00	●
3637561	ABDF1200A2AS	12,00	12,00	25,00	76,00	●
3637562	ABDF1400A2AS	14,00	14,00	32,00	83,00	●
3637563	ABDF1600A2AS	16,00	16,00	32,00	89,00	●
3637564	ABDF1800A2AS	18,00	18,00	38,00	100,00	●
3637565	ABDF2000A2AS	20,00	20,00	38,00	104,00	●

MaxiMet • Square End • 3 Flutes • Plain Shank • Metric

- first choice
- alternate choice

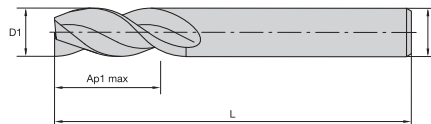

P	■	■
M	■	■
K	■	■
N	■	●
S	■	■
H	■	■

order number	catalogue number	D1	D	Ap1 max	L	K600
3637429	ABDE0300A3AS	3,00	3,00	12,00	38,00	●
3637430	ABDE0400A3AS	4,00	4,00	12,00	50,00	●
3637431	ABDE0500A3AS	5,00	5,00	14,00	50,00	●
3637432	ABDE0600A3AS	6,00	6,00	16,00	50,00	●
3637463	ABDE0800A3AS	8,00	8,00	20,00	63,00	●
3637464	ABDE1000A3AS	10,00	10,00	22,00	76,00	●
3637465	ABDE1200A3AS	12,00	12,00	25,00	76,00	●
3637466	ABDE1400A3AS	14,00	14,00	32,00	83,00	●
3637467	ABDE1600A3AS	16,00	16,00	32,00	89,00	●
3637468	ABDE1800A3AS	18,00	18,00	38,00	100,00	●
3637469	ABDE2000A3AS	20,00	20,00	38,00	104,00	●

162-163	164	117-119	168

MaxiMet™ • Radiused • 3 Flutes • Necked • Plain Shank • Metric

- first choice
- alternate choice

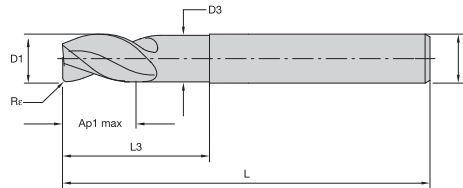

P	■
M	■
K	■
N	●
S	■
H	■

order number	catalogue number	D1	D	D3	Ap1 max	L3	L	Rc	K600
3637389	ABDE0600A3ARA	6,00	6,00	5,40	9,00	18,00	63,00	0,20	●
3637390	ABDE0600A3ARB	6,00	6,00	5,40	9,00	18,00	63,00	0,50	●
3637391	ABDE0600A3ARC	6,00	6,00	5,40	9,00	18,00	63,00	1,00	●
3637392	ABDE0800A3ARA	8,00	8,00	7,20	12,00	24,00	76,00	0,20	●
3637413	ABDE0800A3ARB	8,00	8,00	7,20	12,00	24,00	76,00	0,50	●
3637414	ABDE0800A3ARC	8,00	8,00	7,20	12,00	24,00	76,00	1,00	●
5414455	ABDE1000A3ARG	10,00	10,00	9,50	15,00	30,00	76,00	1,00	●
5414456	ABDE1000A3ARK	10,00	10,00	9,50	15,00	30,00	76,00	2,00	●
5414458	ABDE1000A3ARN	10,00	10,00	9,50	15,00	30,00	76,00	4,00	●
3637415	ABDE1000A3ARA	10,00	10,00	9,00	15,00	30,00	89,00	0,20	●
3637416	ABDE1000A3ARB	10,00	10,00	9,00	15,00	30,00	89,00	0,50	●
3637417	ABDE1000A3ARC	10,00	10,00	9,00	15,00	30,00	89,00	1,50	●
5414459	ABDE1200A3ARG	12,00	12,00	11,50	18,00	36,00	83,00	1,00	●
5414470	ABDE1200A3ARK	12,00	12,00	11,50	18,00	36,00	83,00	2,00	●
5414471	ABDE1200A3ARM	12,00	12,00	11,50	18,00	36,00	83,00	3,00	●
5414473	ABDE1200A3ARN	12,00	12,00	11,50	18,00	36,00	83,00	4,00	●
3637419	ABDE1200A3ARB	12,00	12,00	10,80	18,00	36,00	100,00	0,50	●
6066131	ABDE1200A3ARL	12,00	12,00	11,50	18,00	36,00	100,00	2,50	●
3637420	ABDE1200A3ARC	12,00	12,00	10,80	18,00	36,00	100,00	1,50	●
3637418	ABDE1200A3ARA	12,00	12,00	10,80	18,00	36,00	100,00	0,20	●
5414474	ABDE1600A3ARM	16,00	16,00	15,00	24,00	48,00	100,00	3,00	●
5414475	ABDE1600A3ARN	16,00	16,00	15,00	24,00	48,00	100,00	4,00	●
3637423	ABDE1600A3ARC	16,00	16,00	14,40	24,00	48,00	110,00	1,00	●
3637424	ABDE1600A3ARD	16,00	16,00	14,40	24,00	48,00	110,00	2,00	●
6066132	ABDE1600A3ARL	16,00	16,00	15,00	24,00	48,00	110,00	2,50	●
3637421	ABDE1600A3ARA	16,00	16,00	14,40	24,00	48,00	110,00	0,20	●
3637422	ABDE1600A3ARB	16,00	16,00	14,40	24,00	48,00	110,00	0,50	●
5414477	ABDE2000A3ARK	20,00	20,00	19,00	30,00	60,00	115,00	2,00	●
5414478	ABDE2000A3ARM	20,00	20,00	19,00	30,00	60,00	115,00	3,00	●
3637427	ABDE2000A3ARC	20,00	20,00	18,80	30,00	60,00	125,00	1,50	●
3637428	ABDE2000A3ARD	20,00	20,00	18,80	30,00	60,00	125,00	4,00	●
3637425	ABDE2000A3ARA	20,00	20,00	18,80	30,00	60,00	125,00	0,20	●
3637426	ABDE2000A3ARB	20,00	20,00	18,80	30,00	60,00	125,00	0,50	●
5414479	ABDE2500A3ARE	25,00	25,00	24,00	37,50	75,00	135,00	0,50	●

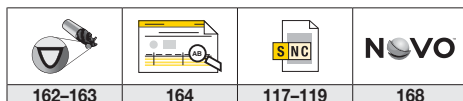

KenCut™ AL • F1AA-WS-M • Square End • 1 Flute • Plain Shank • Metric

- first choice
- alternate choice

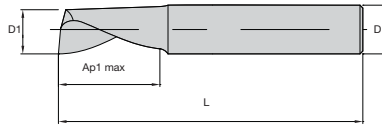

P	■
M	■
K	■
N	●
S	■
H	■

order number	catalogue number	D1	D	Ap1 max	L	K600
2433330	F1AA0200AWS30	2,00	2,00	10,00	40,00	●
2433331	F1AA0300AWS30	3,00	3,00	10,00	40,00	●
2433332	F1AA0400AWS30	4,00	4,00	14,00	50,00	●
2433343	F1AA0500AWS30	5,00	5,00	16,00	60,00	●
2433344	F1AA0600AWS30	6,00	6,00	20,00	60,00	●
2433345	F1AA0800AWM30	8,00	8,00	25,00	75,00	●
2433346	F1AA1000AWM30	10,00	10,00	25,00	75,00	●
2433347	F1AA1200AWM30	12,00	12,00	25,00	75,00	●

KenCut AL • F2AA-ADL45 • Square End • 2 Flutes • Plain Shank • Metric

- first choice
- alternate choice

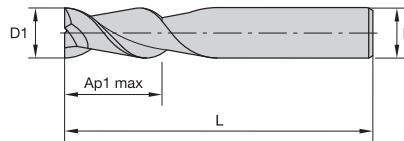

P	■
M	■
K	■
N	●
S	■
H	■

order number	catalogue number	D1	D	Ap1 max	L	K600
1199807	F2AA0400ADL45	4,00	6,00	8,00	57,00	●
1199808	F2AA0500ADL45	5,00	6,00	10,00	57,00	●
1199811	F2AA0600ADL45	6,00	6,00	10,00	57,00	●
1199812	F2AA0800ADL45	8,00	8,00	16,00	63,00	●
1199815	F2AA1000ADL45	10,00	10,00	19,00	72,00	●
1199816	F2AA1200ADL45	12,00	12,00	22,00	83,00	●
1199819	F2AA1400ADL45	14,00	14,00	22,00	83,00	●
1199820	F2AA1600ADL45	16,00	16,00	26,00	92,00	●
1199824	F2AA2000ADL45	20,00	20,00	32,00	104,00	●

162-163	164	117-119	168

KenCut™ AL • F2AA-WMLX • Square End • 2 Flutes • Plain Shank • Metric

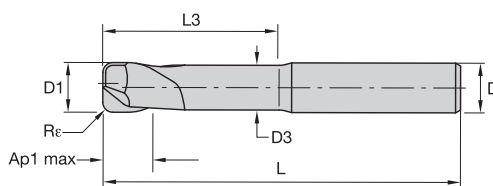

● first choice

○ alternate choice

P	■
M	■
K	■
N	●
S	■
H	■

order number	catalogue number	D1	D	D3	Ap1 max	L3	L	Re	K600
2445703	F2AA0600AWM45R050	6,00	6,00	5,80	9,00	18,00	63,00	0,50	●
2445704	F2AA0600AWM45R100	6,00	6,00	5,80	9,00	18,00	63,00	1,00	●
2445705	F2AA0800AWM45R050	8,00	8,00	7,80	12,00	24,00	68,00	0,50	●
2430467	F2AA1000AWL45R050	10,00	10,00	9,50	15,00	30,00	76,00	0,50	●
2430507	F2AA1000AWL45R200	10,00	10,00	9,50	15,00	30,00	76,00	2,00	●
2430517	F2AA1000AWL45R300	10,00	10,00	9,50	15,00	30,00	76,00	3,00	●
2430468	F2AA1200AWL45R050	12,00	12,00	11,50	18,00	36,00	84,00	0,50	●
2430518	F2AA1200AWL45R300	12,00	12,00	11,50	18,00	36,00	84,00	3,00	●
2430513	F2AA1200AWL45R400	12,00	12,00	11,50	18,00	36,00	84,00	4,00	●
2430469	F2AA1600AWX45R050	16,00	16,00	15,00	24,00	48,00	100,00	0,50	●
2430509	F2AA1600AWX45R200	16,00	16,00	15,00	24,00	48,00	100,00	2,00	●
2430514	F2AA1600AWX45R400	16,00	16,00	15,00	24,00	48,00	100,00	4,00	●
2430470	F2AA2000AWX45R050	20,00	20,00	19,00	30,00	60,00	115,00	0,50	●
2430515	F2AA2000AWX45R400	20,00	20,00	19,00	30,00	60,00	115,00	4,00	●
2430471	F2AA2500AWX45R050	25,00	25,00	24,00	37,50	75,00	135,00	0,50	●

KenCut AL • F3AA-AWSL45 • Square End • 3 Flutes • Plain Shank • Metric

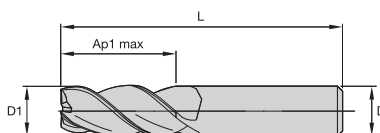

● first choice

○ alternate choice

P	■
M	■
K	■
N	●
S	■
H	■

order number	catalogue number	D1	D	Ap1 max	L	K600
1805750	F3AA0300AWS45	3,00	3,00	12,00	38,00	●
1805929	F3AA0400AWS45	4,00	4,00	12,00	50,00	●
1805930	F3AA0500AWS45	5,00	6,00	14,00	50,00	●
1805931	F3AA0600AWS45	6,00	6,00	16,00	50,00	●
1805932	F3AA0800AWM45	8,00	8,00	20,00	63,00	●
1805983	F3AA1000AWL45	10,00	10,00	22,00	76,00	●
1805984	F3AA1200AWL45	12,00	12,00	25,00	76,00	●
1805985	F3AA1400AWL45	14,00	14,00	32,00	83,00	●
1805986	F3AA1600AWL45	16,00	16,00	32,00	89,00	●
1805987	F3AA1800AWL45	18,00	18,00	38,00	100,00	●
1805988	F3AA2000AWX45	20,00	20,00	38,00	104,00	●

162-163	164	117-119	168

KenCut™ AL • F3AA-WSMLX • Radiused • 3 Flutes • Extended Neck • Plain Shank • Metric

- first choice
- alternate choice

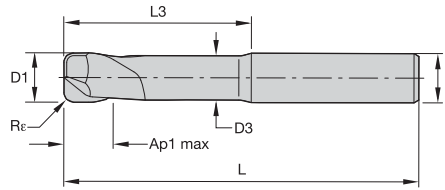

P	■
M	■
K	■
N	●
S	■
H	■

order number	catalogue number	D1	D	D3	Ap1 max	L3	L	Re	K600
2445707	F3AA0600AWM45R050	6,00	6,00	5,80	9,00	18,00	63,00	0,50	●
2445708	F3AA0600AWM45R100	6,00	6,00	5,80	9,00	18,00	63,00	1,00	●
2445709	F3AA0800AWM45R050	8,00	8,00	7,80	12,00	24,00	68,00	0,50	●
2445710	F3AA0800AWM45R100	8,00	8,00	7,80	12,00	24,00	68,00	1,00	●
2404945	F3AA1000AWL45R050	10,00	10,00	9,50	15,00	30,00	76,00	0,50	●
2404950	F3AA1000AWL45R100	10,00	10,00	9,50	15,00	30,00	76,00	1,00	●
2406115	F3AA1000AWL45R200	10,00	10,00	9,50	15,00	30,00	76,00	2,00	●
2429642	F3AA1000AWL45R300	10,00	10,00	9,50	15,00	30,00	76,00	3,00	●
2404951	F3AA1200AWL45R100	12,00	12,00	11,50	18,00	36,00	83,00	1,00	●
2406116	F3AA1200AWL45R200	12,00	12,00	11,50	18,00	36,00	83,00	2,00	●
2429673	F3AA1200AWL45R300	12,00	12,00	11,50	18,00	36,00	83,00	3,00	●
2406121	F3AA1200AWL45R400	12,00	12,00	11,50	18,00	36,00	83,00	4,00	●
2404946	F3AA1200AWL45R050	12,00	12,00	11,50	18,00	36,00	84,00	0,50	●
2404947	F3AA1600AWX45R050	16,00	16,00	15,00	24,00	48,00	100,00	0,50	●
2404952	F3AA1600AWX45R100	16,00	16,00	15,00	24,00	48,00	100,00	1,00	●
2406117	F3AA1600AWX45R200	16,00	16,00	15,00	24,00	48,00	100,00	2,00	●
2429674	F3AA1600AWX45R300	16,00	16,00	15,00	24,00	48,00	100,00	3,00	●
2406122	F3AA1600AWX45R400	16,00	16,00	15,00	24,00	48,00	100,00	4,00	●
2404948	F3AA2000AWX45R050	20,00	20,00	19,00	30,00	60,00	115,00	0,50	●
2406113	F3AA2000AWX45R100	20,00	20,00	19,00	30,00	60,00	115,00	1,00	●
2406118	F3AA2000AWX45R200	20,00	20,00	19,00	30,00	60,00	115,00	2,00	●
2429675	F3AA2000AWX45R300	20,00	20,00	19,00	30,00	60,00	115,00	3,00	●
2404949	F3AA2500AWX45R050	25,00	25,00	24,00	37,50	75,00	135,00	0,50	●
2406114	F3AA2500AWX45R100	25,00	25,00	24,00	37,50	75,00	135,00	1,00	●
2406119	F3AA2500AWX45R200	25,00	25,00	24,00	37,50	75,00	135,00	2,00	●

162-163	164	117-119	168

KenCut™ ALR • F3BA-WSMLX • Radiused • 3 Flutes • Weldon® Shank • Metric

- first choice
- alternate choice

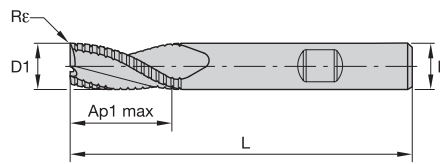

P	■
M	■
K	■
N	●
S	■
H	■

order number	catalogue number	D1	D	Ap1 max	L	Re	K600
1805808	F3BA0600BWS40	6,00	6,00	13,00	57,00	0,25	●
1807047	F3BA0800BWM40	8,00	8,00	16,00	63,00	0,25	●
1807048	F3BA1000BWM40	10,00	10,00	22,00	72,00	0,50	●
1807049	F3BA1200BWL40	12,00	12,00	26,00	83,00	0,50	●
1807050	F3BA1600BWL40	16,00	16,00	32,00	92,00	1,00	●
1807051	F3BA2000BWX40	20,00	20,00	38,00	104,00	1,00	●
1807052	F3BA2500BWX40	25,00	25,00	45,00	121,00	1,50	●

KenCut ALR • F3BA-WSMLX • Radiused • 3 Flutes • Internal Coolant • Weldon Shank • Metric

- first choice
- alternate choice

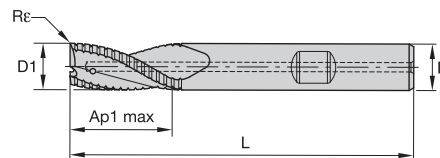

P	■
M	■
K	■
N	●
S	■
H	■

order number	catalogue number	D1	D	Ap1 max	L	Re	K600
1805825	F3BA0800BWM40C160	8,00	8,00	16,00	63,00	0,25	●
1807346	F3BA1000BWM40C220	10,00	10,00	22,00	72,00	0,50	●
1807347	F3BA1200BWL40C260	12,00	12,00	26,00	83,00	0,50	●
1807348	F3BA1600BWL40C320	16,00	16,00	32,00	92,00	1,00	●
1807349	F3BA2000BWX40C380	20,00	20,00	38,00	104,00	1,00	●
1807350	F3BA2500BWX40C450	25,00	25,00	45,00	121,00	1,50	●

162-163	164	117-119	168

KenCut™ AQ • ALCB • Radiused • 2 Flutes • 1 x D • Internal Coolant • Plain Shank • Metric

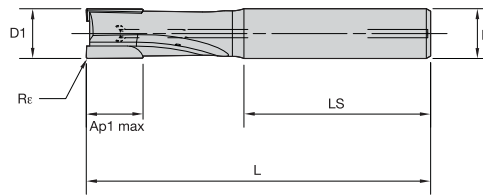

- first choice
- alternate choice

P	■
M	■
K	■
N	●
S	■
H	■

order number	catalogue number	D1	D	Ap1 max	L	LS	Re		KD1410
6752771	ALCB2RA0600N006HAR020IM	6,00	6,00	6,00	57,00	36,00	0,20	●	
6752772	ALCB2RA0800N008HAR020IM	8,00	8,00	8,00	63,00	36,00	0,20	●	
6752773	ALCB2RA1000N010HAR020IM	10,00	10,00	10,00	76,00	40,00	0,20	●	
6752774	ALCB2RA1200N012HAR030IM	12,00	12,00	12,00	83,00	45,00	0,30	●	
6752775	ALCB2RA1600N016HAR030IM	16,00	16,00	16,00	95,00	48,00	0,30	●	
6752776	ALCB2RA2000N020HAR030IM	20,00	20,00	20,00	108,00	50,00	0,30	●	

KenCut AQ • ALCC • Radiused • 2 Flutes • 1,5 x D • Internal Coolant • Plain Shank • Metric

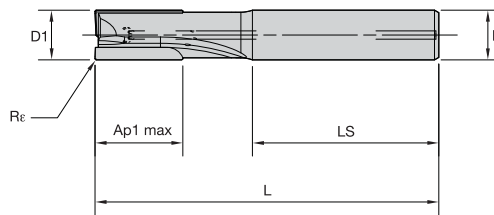

- first choice
- alternate choice

P	■
M	■
K	■
N	●
S	■
H	■

order number	catalogue number	D1	D	Ap1 max	L	LS	Re		KD1410
6752777	ALCC2RA0600N010HAR020IM	6,00	6,00	10,00	57,00	36,00	0,20	●	
6752778	ALCC2RA0800N015HAR020IM	8,00	8,00	15,00	63,00	36,00	0,20	●	
6752779	ALCC2RA1000N015HAR020IM	10,00	10,00	15,00	76,00	40,00	0,20	●	
6752780	ALCC2RA1200N020HAR030IM	12,00	12,00	20,00	83,00	45,00	0,30	●	
6752791	ALCC2RA1600N025HAR030IM	16,00	16,00	25,00	95,00	48,00	0,30	●	
6752792	ALCC2RA20600N028HAR030IM	20,00	20,00	28,00	108,00	50,00	0,30	●	

162-163	164	117-119	168

KenCut™ AQ • ALCR • Radiused • 2 Flutes • 2 x D • Internal Coolant • Plain Shank • Metric

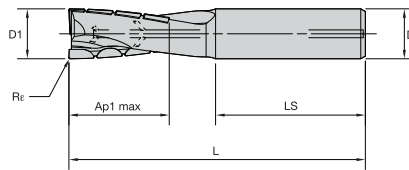

- first choice
- alternate choice

P	■
M	■
K	■
N	●
S	■
H	■

order number	catalogue number	D1	D	Ap1 max	L	LS	Rε	
6752793	ALCR2RA1200N024HAR030IM	12,00	12,00	24,00	83,00	45,00	0,30	●
6752794	ALCR2RA1600N032HAR030IM	16,00	16,00	32,00	95,00	48,00	0,30	●
6752795	ALCR2RA2000N040HAR030IM	20,00	20,00	40,00	108,00	50,00	0,30	●

KD1410

KenCut AQ • ALSR • Radiused • 2–3 Flutes • 1,25 x D • Helical • Internal Coolant • Plain Shank • Metric

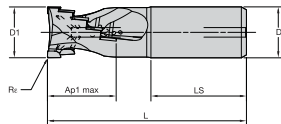

- first choice
- alternate choice

P	■
M	■
K	■
N	●
S	■
H	■

order number	catalogue number	D1	D	Ap1 max	L	LS	Rε	Z U
6752800	ALSR2RA2500N032HAR040IM	25,00	25,00	32,00	115,00	56,00	0,40	2
6752811	ALSR2RA3200N040HAR040IM	32,00	32,00	40,00	125,00	60,00	0,40	2
6752812	ALSR2RA4000N050HAR040IM	40,00	32,00	40,00	125,00	60,00	0,40	3

KD1410

162–163	164	117–119	168

KenCut™ AQ • ALSB • Radiused • 4–5 Flutes • 1,25 x D • Internal Coolant • Plain Shank • Metric

- first choice
- alternate choice

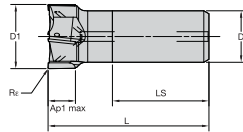

P	Blue
M	Yellow
K	Red
N	Green
S	Orange
H	Grey

order number	catalogue number	D1	D	Ap1 max	L	LS	R _ε	Z U	KD1410
6752796	ALSB4RA2500N015HAR040IM	25,00	25,00	15,00	100,00	56,00	0,40	4	●
6752797	ALSB4RA3200N015HAR040IM	32,00	32,00	15,00	100,00	60,00	0,40	4	●
6752798	ALSB4RA4000N015HAR040IM	40,00	32,00	15,00	100,00	60,00	0,40	4	●
6752799	ALSB5RA5000N015HAR040IM	50,00	32,00	15,00	100,00	60,00	0,40	5	●

MaxiMet™ • ABDE... • Extended Neck • Application Data • Metric

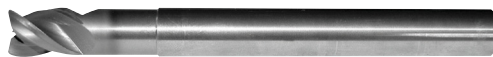

Material Group					K600		Feed per Tooth — fz information is for side milling (A). For slotting (B), reduce fz by 20%.						
	A		B		Cutting Speed — vc m/min		D1 — Diameter						
	ap	ae	ap		min	max	mm	6,0	8,0	10,0	12,0	16,0	20,0
N	1	1 x D	0,5 x D	1,0 x D	500	2000	fz	0,060	0,080	0,100	0,120	0,160	0,200
	2	1 x D	0,5 x D	1,0 x D	500	1500	fz	0,054	0,072	0,090	0,108	0,144	0,180
	3	1 x D	0,5 x D	1,0 x D	500	1500	fz	0,042	0,056	0,070	0,084	0,112	0,140
	4	1 x D	0,5 x D	1,0 x D	400	750	fz	0,042	0,056	0,070	0,084	0,112	0,140
	5	1 x D	0,5 x D	1,0 x D	250	1000	fz	0,054	0,072	0,090	0,108	0,144	0,180

NOTE: Those guidelines may require variations to achieve optimum results. For better surface finish, reduce feed per tooth.
 For cutting aluminum with high silicon, TiCN coating is recommended.
 Ap for milling machine with ceramic bearings spindle, multiply by 0,5.
 Above parameters are based on ideal conditions. For smaller taper machining centers, please adjust parameters accordingly on >12mm diameter.
 For tools with reach >3 x D, reduce Fz by 20%.
 For tools with reach >5 x D, reduce Fz by 30%.
 For tools with reach >10 x D, reduce Vc and Fz by 30%.

162–163	164	117–119	168



MaxiMet™ • ABDE-ABDF • Extended Neck • Application Data • Metric



MaxiMet ABDE



MaxiMet ABDF

Material Group					ABDE... • ABDF...		Feed per Tooth – fz information is for side milling (A). For slotting (B), reduce fz by 20%.													
	A		B		Cutting Speed – vc m/min		D1 – Diameter													
	ap	ae	ap		min	max	mm	1,5	2,0	3,0	4,0	6,0	8,0	10,0	12,0	14,0	16,0	18,0	20,0	25,0
N	1	1,5 x D	0,5 x D	1,0 x D	500	2000	fz	0,014	0,018	0,027	0,036	0,054	0,072	0,090	0,108	0,126	0,144	0,162	0,180	0,225
	2	1,5 x D	0,5 x D	1,0 x D	500	1500	fz	0,012	0,016	0,024	0,032	0,049	0,065	0,081	0,097	0,113	0,130	0,146	0,162	0,203
	3	1,5 x D	0,5 x D	1,0 x D	500	1500	fz	0,009	0,013	0,019	0,025	0,038	0,050	0,063	0,076	0,088	0,101	0,113	0,126	0,158
	4	1,5 x D	0,5 x D	1,0 x D	400	750	fz	0,009	0,013	0,019	0,025	0,038	0,050	0,063	0,076	0,088	0,101	0,113	0,126	0,158
	5	1,5 x D	0,5 x D	1,0 x D	250	1000	fz	0,012	0,016	0,024	0,032	0,049	0,065	0,081	0,097	0,113	0,130	0,146	0,162	0,203

KenCut™ AL • F1AA...WS-WM • Application Data • Metric



Material Group					K600		Feed per Tooth – fz information is for side milling (A). For slotting (B), reduce fz by 20%.													
	A		B		Cutting Speed – vc m/min		D1 – Diameter													
	ap	ae	ap		min	max	mm	2,0	3,0	4,0	5,0	6,0	8,0	10,0	12,0					
N	1	1,2 x D	0,5 x D	1,0 x D	500	2000	fz	0,014	0,021	0,028	0,035	0,042	0,056	0,070	0,084					
	2	1,2 x D	0,5 x D	1,0 x D	500	1500	fz	0,013	0,019	0,025	0,032	0,038	0,050	0,063	0,076					
	3	1,2 x D	0,5 x D	1,0 x D	500	1500	fz	0,010	0,015	0,020	0,025	0,029	0,039	0,049	0,059					
	4	1,2 x D	0,5 x D	1,0 x D	400	750	fz	0,010	0,015	0,020	0,025	0,029	0,039	0,049	0,059					
	5	1,2 x D	0,5 x D	1,0 x D	250	1000	fz	0,013	0,019	0,025	0,032	0,038	0,050	0,063	0,076					

NOTE: Ap for milling machine with ceramic bearings spindle, multiply by 0,5.
For better surface finish, reduce feed per tooth.
Above parameters are based on ideal conditions. For smaller taper machining centers, please adjust parameters accordingly on >12mm diameter.

KenCut™ AL • F3BA-F3AA-F2AA • Application Data • Metric

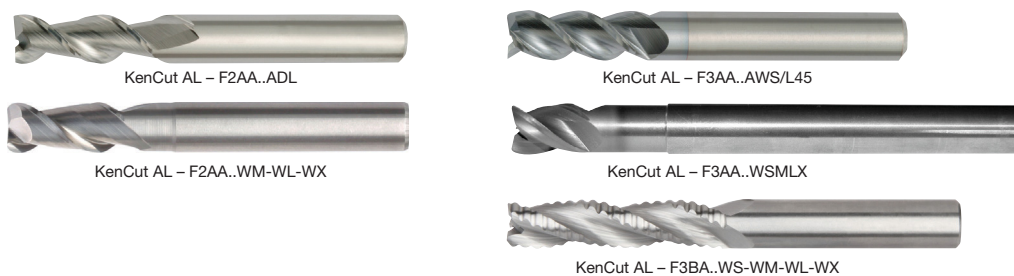

Material Group					F3BA-F3AA-F2AA		Feed per Tooth — fz information is for side milling (A). For slotting (B), reduce fz by 20%.													
	A		B		Cutting Speed — vc m/min		D1 — Diameter													
	ap	ae	ap		min	max	mm	1,5	2,0	3,0	4,0	6,0	8,0	10,0	12,0	14,0	16,0	18,0	20,0	25,0
N	1	1,5 x D	0,5 x D	1,0 x D	500	2000	fz	0,014	0,018	0,027	0,036	0,054	0,072	0,090	0,108	0,126	0,144	0,162	0,180	0,225
	2	1,5 x D	0,5 x D	1,0 x D	500	1500	fz	0,012	0,016	0,024	0,032	0,049	0,065	0,081	0,097	0,113	0,130	0,146	0,162	0,203
	3	1,5 x D	0,5 x D	1,0 x D	500	1500	fz	0,009	0,013	0,019	0,025	0,038	0,050	0,063	0,076	0,088	0,101	0,113	0,126	0,158
	4	1,5 x D	0,5 x D	1,0 x D	400	750	fz	0,009	0,013	0,019	0,025	0,038	0,050	0,063	0,076	0,088	0,101	0,113	0,126	0,158
	5	1,5 x D	0,5 x D	1,0 x D	250	1000	fz	0,012	0,016	0,024	0,032	0,049	0,065	0,081	0,097	0,113	0,130	0,146	0,162	0,203

KenCut AL • F3BA...DL4... • Application Data • Metric



Material Group					K600		Feed per Tooth — fz information is for side milling (A). For slotting (B), reduce fz by 20%.							
	A		B		Cutting Speed — vc m/min		D1 — Diameter							
	ap	ae	ap		min	max	mm	6,0	8,0	10,0	12,0	16,0	18,0	20,0
N	1	1,0 x D	0,5 x D	1,0 x D	500	2000	fz	0,078	0,104	0,130	0,156	0,208	0,234	0,260
	2	1,0 x D	0,5 x D	1,0 x D	500	1500	fz	0,070	0,094	0,117	0,140	0,187	0,211	0,234
	3	1,0 x D	0,5 x D	1,0 x D	500	1500	fz	0,055	0,073	0,091	0,109	0,146	0,164	0,182
	4	1,0 x D	0,5 x D	1,0 x D	400	750	fz	0,055	0,073	0,091	0,109	0,146	0,164	0,182
	5	1,0 x D	0,5 x D	1,0 x D	250	1000	fz	0,070	0,094	0,117	0,140	0,187	0,211	0,234

NOTE: Those guidelines may require variations to achieve optimum results. For better surface finish, reduce feed per tooth.
 Above parameters are based on ideal conditions. For smaller taper machining centers, please adjust parameters accordingly on >12mm diameter.
 For cutting aluminum with high silicon, TiCN coating is recommended.
 Ap for milling machine with ceramic bearings spindle, multiply by 0,5.
 Side milling applications — for longest reach (L3) tools, reduce Ae by 30%.
 Slot milling applications — for longest reach (L3) tools, reduce Ae by 30%.

KenCut™ ALR • F3BA...BWS/M/L/X40... • Application Data • Metric



Material Group					K600		Feed per Tooth — fz information is for side milling (A). For slotting (B), reduce fz by 20%.								
	A		B		Cutting Speed — vc m/min		D1 — Diameter								
	ap	ae	ap		min	max	mm	6,0	8,0	10,0	12,0	16,0	18,0	20,0	25,0
N	1	1,5 x D	0,5 x D	1,0 x D	500	2000	fz	0,072	0,096	0,120	0,144	0,192	0,216	0,240	0,300
	2	1,5 x D	0,5 x D	1,0 x D	500	1500	fz	0,065	0,086	0,108	0,130	0,173	0,194	0,216	0,270
	3	1,5 x D	0,5 x D	1,0 x D	500	1500	fz	0,050	0,067	0,084	0,101	0,134	0,151	0,168	0,210
	4	1,5 x D	0,5 x D	1,0 x D	400	750	fz	0,050	0,067	0,084	0,101	0,134	0,151	0,168	0,210
	5	1,5 x D	0,5 x D	1,0 x D	250	1000	fz	0,065	0,086	0,108	0,130	0,173	0,194	0,216	0,270

NOTE: Ap for milling machine with ceramic bearings spindle, multiply by 0,5.
For better surface finish, reduce feed per tooth.
Above parameters are based on ideal conditions. For smaller taper machining centers, please adjust parameters accordingly on >12mm diameter.

KenCut ALR • F3BA..BWM/L/X40C.. • Application Data • Metric



Material Group					K600		Feed per Tooth — fz information is for side milling (A). For slotting (B), reduce fz by 20%.								
	A		B		Cutting Speed — vc m/min		D1 — Diameter								
	ap	ae	ap		min	max	mm	6,0	8,0	10,0	12,0	16,0	18,0	20,0	25,0
N	1	1,5 x D	0,5 x D	1,25 x D	500	2000	fz	0,072	0,096	0,120	0,144	0,192	0,216	0,240	0,300
	2	1,5 x D	0,5 x D	1,25 x D	500	1500	fz	0,065	0,086	0,108	0,130	0,173	0,194	0,216	0,270
	3	1,5 x D	0,5 x D	1,25 x D	500	1500	fz	0,050	0,067	0,084	0,101	0,134	0,151	0,168	0,210
	4	1,5 x D	0,5 x D	1,25 x D	400	750	fz	0,050	0,067	0,084	0,101	0,134	0,151	0,168	0,210
	5	1,5 x D	0,5 x D	1,25 x D	250	1000	fz	0,065	0,086	0,108	0,130	0,173	0,194	0,216	0,270

NOTE: Ap for milling machine with ceramic bearings spindle, multiply by 0,5.
For better surface finish, reduce feed per tooth.
Above parameters are based on ideal conditions. For smaller taper machining centers, please adjust parameters accordingly on >12mm diameter.

MaxiMet & KenCut AL/ALR-Series • Adjustment Factor for Feed and Speed Calculation • Metric

	Ae/D	2%	4%	5%	8%	10%	12%	20%	30%	40%	50%	100%
Speed factor	Kv	2,1—3,6	1,6—3	1,6—2,5	1,6	1,4	1,38	1,3	1,2	1,1	1	0,9
Feed factor	KFz	3,58	2,56	2,3	1,84	1,67	1,54	1,25	1,09	1,02	1	1

NOTE: For an Ae/D ratio of 5% or less there is a range given for speed factor Kv, which allows the user to either be more conservative at the lower value or more aggressive with the higher value.
This can also be considered based on the machinability of the material, from difficult to free cutting.
These calculations are for roughing/semi-finishing cuts when used with the recommended base Fz.
For light finishing cuts requiring improved surface quality it is recommended to reduce the base Fz approximately 50% and then apply these factors.

To calculate application specific cutting data, please use Kv coefficient table to the right for adaptation of cutting speed and KFz for feed respectively.

Vc new = Vc * Kv
Fz new = IPT * KFz

Calculation example:

Application: D1 = 20mm;
N2 material group (Maximet ABDE);
Ae 2,0mm (Ae = 10% of D1)
Cutting data recommendation: 1500m/min;
Fz = 0,180mm/z
Adjustment coefficients: Ae = 2,0mm equals 10%;
Kv = 1,4; KFz = 1,67

Final cutting data recommendation:

Vc new = 1500 * 1,4 = 2100mm/min
Fz new = 0,180 * 1,67 = 0,301mm/z



KenCut™ AQ • ALCB • Application Data • Metric



Material Group					KD1410			Recommended feed per tooth (fz = mm/th) for side milling (A). For slotting (B), reduce fz by 20%.						
	A		B	Cutting Speed – vc m/min			mm	D1 – Diameter						
	ap	ae	ap	min	–	max		6,0	8,0	10,0	12,0	16,0	20,0	
N	1	1 x D	0,25 x D	0,5 x D	200	–	3000	Fz	0,070	0,080	0,090	0,140	0,160	0,160
	2	1 x D	0,25 x D	0,5 x D	200	–	3000	Fz	0,070	0,080	0,090	0,140	0,160	0,160
	3	1 x D	0,25 x D	0,5 x D	180	–	1400	Fz	0,060	0,070	0,080	0,120	0,140	0,140
	4	1 x D	0,25 x D	0,5 x D	200	–	800	Fz	0,060	0,070	0,080	0,100	0,120	0,120
	5	1 x D	0,25 x D	0,5 x D	200	–	1000	Fz	0,050	0,060	0,070	0,090	0,100	0,100
	6	1 x D	0,25 x D	0,5 x D	150	–	800	Fz	0,040	0,050	0,060	0,060	0,080	0,080
	7	1 x D	0,25 x D	0,5 x D	250	–	500	Fz	0,040	0,050	0,060	0,060	0,080	0,080

NOTE: Maximum allowed operation speed 30000 rev./min.
Maximum allowed cutting speed 3000 m/min

KenCut AQ • ALCC • Application Data • Metric



Material Group					KD1410			Recommended feed per tooth (fz = mm/th) for side milling (A). For slotting (B), reduce fz by 20%.					
	A		B	Cutting Speed – vc m/min			mm	D1 – Diameter					
	ap	ae	ap	min	–	max		6,0	8,0	10,0	12,0	16,0	
N	1	1,5 x D	0,15 x D	0,5 x D	200	–	3000	Fz	0,070	0,080	0,090	0,140	0,160
	2	1,5 x D	0,15 x D	0,5 x D	200	–	3000	Fz	0,070	0,080	0,090	0,140	0,160
	3	1,5 x D	0,15 x D	0,5 x D	180	–	1400	Fz	0,060	0,070	0,080	0,120	0,140
	4	1,5 x D	0,15 x D	0,5 x D	200	–	800	Fz	0,060	0,070	0,080	0,100	0,120
	5	1,5 x D	0,15 x D	0,5 x D	200	–	1000	Fz	0,050	0,060	0,070	0,090	0,100
	6	1,5 x D	0,15 x D	0,5 x D	150	–	800	Fz	0,040	0,050	0,060	0,060	0,080
	7	1,5 x D	0,15 x D	0,5 x D	250	–	500	Fz	0,040	0,050	0,060	0,060	0,080

NOTE: Maximum allowed operation speed 30000 rev./min.
Maximum allowed cutting speed 3000 m/min

KenCut AQ • ALCR • Application Data • Metric



Material Group					KD1410			Recommended feed per tooth (fz = mm/th) for side milling (A). For slotting (B), reduce fz by 20%.			
	A		B	Cutting Speed – vc m/min			mm	D1 – Diameter			
	ap	ae	ap	min	–	max		12,0	16,0	20,0	
N	1	2 x D	0,2 x D	0,5 x D	200	–	3000	Fz	0,140	0,160	0,160
	2	2 x D	0,2 x D	0,5 x D	200	–	3000	Fz	0,140	0,160	0,160
	3	2 x D	0,2 x D	0,5 x D	180	–	1400	Fz	0,120	0,140	0,140
	4	2 x D	0,2 x D	0,5 x D	200	–	800	Fz	0,100	0,120	0,120
	5	2 x D	0,2 x D	0,5 x D	200	–	1000	Fz	0,090	0,100	0,100
	6	2 x D	0,2 x D	0,5 x D	150	–	800	Fz	0,060	0,080	0,080
	7	2 x D	0,2 x D	0,5 x D	250	–	500	Fz	0,060	0,080	0,080

NOTE: Maximum allowed operation speed 30000 rev./min.
Maximum allowed cutting speed 3000 m/min

KenCut™ AQ • ALSB • Application Data • Metric



Material Group					KD1410			Recommended feed per tooth (fz = mm/th) for side milling (A). For slotting (B), reduce fz by 20%.				
	A		B		Cutting Speed – vc m/min			mm	D1 – Diameter			
	ap	ae	ap		min		max		25,0	32,0	40,0	50,0
N	1	L10	0,25 x D	0,5 x L10	200	–	3000	Fz	0,180	0,200	0,200	0,220
	2	L10	0,25 x D	0,5 x L10	200	–	3000	Fz	0,180	0,200	0,200	0,220
	3	L10	0,25 x D	0,5 x L10	180	–	1400	Fz	0,160	0,180	0,180	0,200
	4	L10	0,25 x D	0,5 x L10	200	–	800	Fz	0,140	0,160	0,160	0,180
	5	L10	0,25 x D	0,5 x L10	200	–	1000	Fz	0,120	0,120	0,120	0,140
	6	L10	0,25 x D	0,5 x L10	150	–	800	Fz	0,100	0,100	0,100	0,120
	7	L10	0,25 x D	0,5 x L10	250	–	500	Fz	0,100	0,100	0,100	0,120

NOTE: Maximum allowed operation speed 30000 rev./min.
Maximum allowed cutting speed 3000 m/min



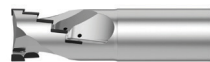























KenCut AQ • ALSR • Application Data • Metric



Material Group					KD1410			Recommended feed per tooth (fz = mm/th) for side milling (A). For slotting (B), reduce fz by 20%.				
	A		B		Cutting Speed – vc m/min			mm	D1 – Diameter			
	ap	ae	ap		min		max		25,0	32,0	40,0	
N	1	1,25 x D	0,2 x D	0,25 x D	200	–	3000	Fz	0,180	0,200	0,200	
	2	1,25 x D	0,2 x D	0,25 x D	200	–	3000	Fz	0,180	0,200	0,200	
	3	1,25 x D	0,2 x D	0,25 x D	180	–	1400	Fz	0,160	0,180	0,180	
	4	1,25 x D	0,2 x D	0,25 x D	200	–	800	Fz	0,140	0,160	0,160	
	5	1,25 x D	0,2 x D	0,25 x D	200	–	1000	Fz	0,120	0,120	0,120	
	6	1,25 x D	0,2 x D	0,25 x D	150	–	800	Fz	0,100	0,100	0,100	
	7	1,25 x D	0,2 x D	0,25 x D	250	–	500	Fz	0,100	0,100	0,100	























NOTE: Maximum allowed operation speed 30000 rev./min.
Maximum allowed cutting speed 3000 m/min

Tool Selector

	CFRP MACHINING			HIGH-TEMP MACHINING	
	KenCut™ CF			KenCut HT	
					
Series	CCNC	CDDC	CBDB	EADE	EADE
Page	kennametal.com	kennametal.com	kennametal.com	96	96
Tool type					
Rougher				●	●
Finisher	●	●	●		
Chamfering					
Main operations					
Workpiece material					
Primary	C	C	C	S	S
Secondary					
Corner style					
Corner radius [Rε]	—	—	—	0,50-1,50mm	0,50-1,50mm
Corner chamfer width [BCH]	0,13mm	0,25mm	0,76-1,14mm	—	—
Cutting diameter [D1]	6-12mm	6-12mm	6-12mm	4-12mm	4-12mm
Length of cut	1,8-6 x D	1,8-6 x D	1,5-6 x D	0,75 x D	0,75 x D
Maximum cutting depth [Ap1 max]	18-36mm	18-36mm	18-36mm	3-9mm	3-9mm
Flute helix angle	25°	25°	15°	40°	40°
Number of flutes [ZU]	3-4	6	12	4	6
Center cutting	✓				
Additional operations		  	 	 	   





















- Primary
- Secondary

Tool Selector

HARD MACHINING					
KenCut™ HM					
					
Series	F2AT-WMLX	F4-5AJ-WSMLX	F4AJ-WSLX	F6-8AV-DL	F2AL-WLMX
Page	kennametal.com	kennametal.com	kennametal.com	kennametal.com	kennametal.com
Tool type					
Rougher					
Finisher	●	●	●	●	●
Chamfering					
Main operations					
Workpiece material					
Primary	P H	P H	P H	P H	P H
Secondary					
Corner style					
Corner radius [Rε]	0,30–4,00mm	0,50–3,00mm	–	0,5–1,5mm	–
Corner chamfer width [BCH]	–	–	–	–	–
Cutting diameter [D1]	2–12mm	6–20mm	6–20mm	6–25mm	2–12mm
Length of cut	1 x D	1,5 x D	1,5 x D	1,8–3 x D	1 x D
Maximum cutting depth [Ap1 max]	2–12mm	9–30mm	9–38mm	13–75mm	2–12mm
Flute helix angle	20°	50°	50°	45°	20°
Number of flutes [ZU]	2	4–5	4	6–8	2
Center cutting	✓	✓	✓	✓	✓
Additional operations	 	 			

- Primary
- Secondary

Tool Selector

HARD MACHINING					
KenCut™ HM					
					
Series	F2AL-WLM	F2AL-WLMX	F2AB-WLMX	F4AL..WL-WM-WX	F4AT-WSMLX
Page	kennametal.com	kennametal.com	kennametal.com	kennametal.com	kennametal.com
Tool type					
Rougher					
Finisher	●	●	●	●	●
Chamfering					
Main operations					
Workpiece material					
Primary	P H	P H	P H	P H	P H
Secondary					
Corner style					
Corner radius [R _ε]	–	–	–	–	0,30–3,00mm
Corner chamfer width [BCH]	–	–	–	–	–
Cutting diameter [D1]	1–16mm	6–16mm	2–12mm	3–10mm	4–12mm
Length of cut	1 x D	1 x D	0,5 x D	1,5 x D	0,5–1 x D
Maximum cutting depth [A _{p1} max]	1–16mm	6–16mm	1–6mm	4–15mm	2–12mm
Flute helix angle	30°	30°	30°	30°	20°
Number of flutes [ZU]	2	2	2	4	4
Center cutting	✓	✓	✓	✓	✓
Additional operations					

- Primary
- Secondary

KenCut™ HT

High-Performance
High-Temperature Alloys Machining



Materials

S

Applications



Face Milling



Ramping



3D Profiling



Shoulder Milling

Solid ceramic end mill for high-speed roughing of nickel-based high-temperature alloys.

The solid ceramic end mills offer extremely high tool life even at cutting speeds up to 1000m/min.

SiAlON solid ceramic grade for exceptionally high metal removal rates in nickel-based high-temperature alloy machining.

Up to five times higher tool life compared to solid carbide end mills, resulting in fewer tool changes and less downtime.

Highest cutting speed capability for drastically reduced machining time.

Four-flute version for pocketing and slotting, six-flute version for face milling and profiling.

KenCut™ HT • EADE • Radiused • 4 Flutes • Necked • Plain Shank • Metric

- first choice
- alternate choice

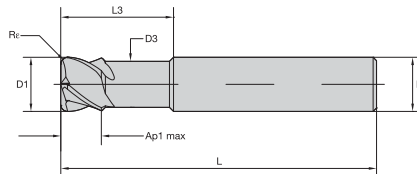

P	■
M	■
K	■
N	■
S	●
H	■

order number	catalogue number	D1	D	D3	Ap1 max	L3	L	Rε	KYS40
5348060	EADE0400A4AQE	4,00	6,00	3,84	3,00	8,00	50,00	0,50	●
5348062	EADE0600A4AQF	6,00	6,00	5,76	4,50	12,00	50,00	0,75	●
5348064	EADE0800A4AQG	8,00	8,00	7,68	6,00	16,00	57,00	1,00	●
5348066	EADE1000A4AQH	10,00	10,00	9,60	7,50	20,00	63,00	1,25	●
5348068	EADE1200A4AQJ	12,00	12,00	11,52	9,00	23,50	70,00	1,50	●

KenCut HT • EADE • Radiused • 6 Flutes • Plain Shank • Metric

- first choice
- alternate choice

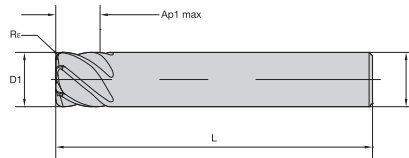



P	■
M	■
K	■
N	■
S	●
H	■

order number	catalogue number	D1	D	Ap1 max	L	Rε	KYS40
5348069	EADE0400A6ARE	4,00	6,00	3,00	50,00	0,50	●
5348070	EADE0600A6ARF	6,00	6,00	4,50	50,00	0,75	●
5348071	EADE0800A6ARG	8,00	8,00	6,00	57,00	1,00	●
5348072	EADE1000A6ARH	10,00	10,00	7,50	63,00	1,25	●
5348073	EADE1200A6ARJ	12,00	12,00	9,00	70,00	1,50	●

162-163	164	117-119	168

KenCut™ HT • EADE • 4 Flutes • Application Data • Metric





Material Group					KYS40		Recommended feed per tooth (fz = mm/th) for side milling (A). For slotting (B), reduce fz by 20%.					
	A		B		Cutting Speed – vc m/min		mm	D1 – Diameter				
	ap	ae	ap		min	max		4,0	6,0	8,0	10,0	12,0
S 3	Ap1 max	0,1 x D*	0,5 x D*		250	1000	fz	0,020	0,024	0,028	0,030	0,032

NOTE: For above cutting data, do not exceed an overall ae of 1mm.
Use Ap of 0,5mm as starting condition.

KenCut HT • EADE • 6 Flutes • Application Data • Metric



Material Group					KYS40		Recommended feed per tooth (fz = mm/th) for side milling (A).					
	A		B		Cutting Speed – vc m/min		mm	D1 – Diameter				
	ap	ae	ap	ae	min	max		4,0	6,0	8,0	10,0	12,0
S 3	Ap1 max*	0,1 x D*			250	1000	fz	0,020	0,024	0,028	0,030	0,032

NOTE: For above cutting data, do not exceed an overall ae of 1mm.
Use Ap of 0,5mm as starting condition.

KenCut™ HT Application Recommendation



Materials to cut	Cutting speed	Coolant
<ul style="list-style-type: none"> Nickel-based high-temperature alloys. Cobalt-based alloys after consulting technical assistance. P6 and M1-3 stainless steels after consulting technical assistance. Do not apply on iron-based high-temperature alloys. 	<ul style="list-style-type: none"> Maximum RPM machine can provide recommended cutting speed: 1,300–3,300 SFM. Highly dynamic machines recommended. Use of spindle speeders applicable (no wet coolant). 	<ul style="list-style-type: none"> Power cool nozzle preferred to flush chips away. Pressurized air applicable. Minimal quantity lubrication (MQL) and dry applicable. No coolant with emulsion or oil due to thermal shock.

Adaptation	Milling strategy	Reconditioning service
<ul style="list-style-type: none"> Hydraulic chuck with or without sleeve preferred. Collet or milling power chucks applicable. Balancing at 25,000 RPM (2,5G) preferred. 	<ul style="list-style-type: none"> Conventional milling preferred at lower speeds. Climb milling preferred at higher speeds. 	Not applicable.

Wear Indication

New

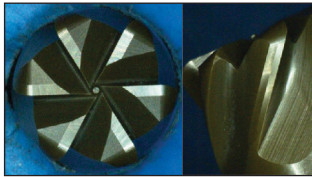

Used

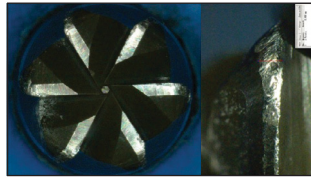

Wear rate 0,48mm. Still good to use.

End of Tool Life

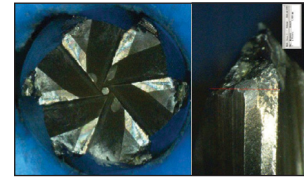

Wear rate 1,4mm. End of tool life reached.

Chip Formation

Carbide



Regular curled chips. Shape and length depend on end mill geometry and cutting data.

Ceramic

















Chips are nearly like dust. Pressurized air coolant recommended to blow away chips.

KenCut™ HT Application Recommendation

Problem	Cause	Remedy
Excessive bur formation	<ul style="list-style-type: none"> Softness of material to cut. Excessive wear on radii. 	<ul style="list-style-type: none"> Use undersize end mills that leave stock for finishing operation. Replace tool as end of tool life reached. Check tool runout.
Sudden breakage	<ul style="list-style-type: none"> Vibration of the workpiece. Unstable tool clamping. Use of 6-flute tooling in slotting. 	<ul style="list-style-type: none"> Check workpiece and tool clamping. Use of 4-flute EADE recommended.
Chips sticking	<ul style="list-style-type: none"> Lack of cutting speed. 	<ul style="list-style-type: none"> Increase cutting speed.
Chipping	<ul style="list-style-type: none"> Unstable tool and/or workpiece clamping. Initial cutting speed too high. 	<ul style="list-style-type: none"> Check workpiece and tool clamping. Reduce cutting speed during initial cut and increase as cutting continues.
Thermal cracks	<ul style="list-style-type: none"> Wet coolant. 	<ul style="list-style-type: none"> Do not use wet coolant.

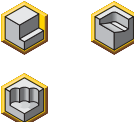
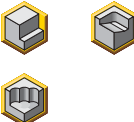





















Tool Selector

	KEY WAY MACHINING		HIGH-FEED MACHINING	
	KenCut™ KS		KenFeed™	
				
Series	F2AU	F3AU	KHDA	KMDA
Page	104	105	106	107
Tool type				
Rougher				
Finisher	●	●	●	●
Chamfering				
Main operations				
Workpiece material				
Primary	P M K S	P M K S	H	H
Secondary	H	H		P
Corner style				
Corner radius [Rε]	0,12–0,40mm	0,12–0,40mm	0,38–1,25mm	0,38–1,25mm
Corner chamfer width [BCH]	–	–	–	–
Cutting diameter [D1]	1,8–19,7mm	2,8–19,7mm	6–20mm	6–20mm
Length of cut	1–1,4 x D	1–1,4 x D	–	–
Maximum cutting depth [Ap1 max]	2–20mm	4–20mm	0,2–0,67mm	0,32–1,05mm
Flute helix angle	38°	38°	20°	20°
Number of flutes [ZU]	2	3	6	6
Center cutting	✓	✓		
Additional operations				

● Primary

○ Secondary

Tool Selector

SMALL PARTS MACHINING					
Micro Mills					
					
Series	F2AH-WSM	F2AL-WS	F2AL-WS..L	F2AL-WM	F3AH-WS
Page	kennametal.com	kennametal.com	kennametal.com	kennametal.com	kennametal.com
Tool type					
Rougher					
Finisher	●	●	●	●	●
Chamfering					
Main operations					
Workpiece material					
Primary	P K H	P M	P H	P H	P M K N
Secondary					
Corner style					
Corner radius [Rε]	–	–	–	–	–
Corner chamfer width [BCH]	–	–	–	–	–
Cutting diameter [D1]	0,3–2,5mm	0,6–3mm	0,3–6mm	1,5–4mm	0,5–3mm
Length of cut	1,3–1,5 x D	1,5–3 x D	1 x D	1,6 x D	1,3–4 x D
Maximum cutting depth [Ap1 max]	0,4–3,7mm	1,5–5mm	0,3–6mm	1,6–6mm	1,5–12mm
Flute helix angle	30°	30°	30°	30°	30°
Number of flutes [ZU]	2	2	2	2	3
Center cutting	✓	✓	✓	✓	✓
Additional operations	 				 

- Primary
- Secondary

KenFeed™ and KenCut™ KS

High-Feed Machining and
Key Way Machining



Materials



Applications



Slotting: Square End



Ramping



3D Profiling



Plunge Milling:
Ball Nose



Shoulder Milling:

KenFeed

The KenFeed solid carbide end mill series is designed for maximum metal removal rates in heat-treated steels up to 67 HRC by taking very shallow-depth cuts at extremely high feed rates.

During face milling, the proprietary front-end geometry is entirely in contact with the workpiece, providing up to 55% engagement compared to regular ball nose-type tooling with only 5–10%.

The 3 x D neck and the extended-reach design is ideal for multiple applications like ramping, circular interpolation, 3D profiling, face milling, and pocketing.

Six-flute design for increased metal removal rates and higher productivity.

KenFeed™



Six-flute solid carbide end mill for high-feed roughing and finishing of medium and hard steels.

KenCut™ KS



Two- and three-fluted end mills providing highest precision when machining slots for a shaft-to-hub connection.

KenCut KS

Key slot radii transition between floor and wall increases durability of machined components by preventing cracks through stress peaks.

True 90° wall straightness due to tapered peripheral edges creating a defined passive force during finishing cut using conventional milling.

Two-fluted tools for unstable machining conditions.

Three-fluted tools with unequally spaced flutes for chatter-free machining at high feed rates.

KenCut™ KS • F2AU • Radiused • 2 Flutes • Plain Shank • Metric

- first choice
- alternate choice

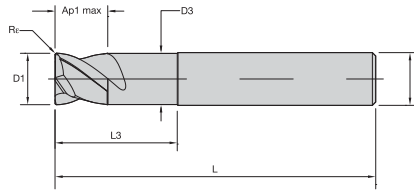
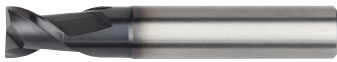

P	●
M	●
K	●
N	●
S	●
H	○

order number	catalogue number	D1	D	D3	Ap1 max	L3	L	R _ε	KC643M
4090779	F2AU0180ADK38	1,80	4,00	1,75	2,00	6,00	38,00	0,12	●
4090780	F2AU0280ADK38	2,80	6,00	2,75	4,00	12,00	50,00	0,12	●
4090781	F2AU0380ADK38	3,80	6,00	3,71	5,00	16,00	54,00	0,12	●
4090782	F2AU0480ADK38	4,80	6,00	4,71	6,00	16,00	54,00	0,20	●
4090783	F2AU0575ADK38	5,75	6,00	5,71	7,00	18,00	54,00	0,20	●
4090784	F2AU0775ADK38	7,75	8,00	7,70	9,00	22,00	58,00	0,20	●
4090785	F2AU0970ADK38	9,70	10,00	9,65	11,00	26,00	66,00	0,33	●
4090786	F2AU1170ADK38	11,70	12,00	11,64	12,00	28,00	73,00	0,33	●
4090787	F2AU1370ADK38	13,70	14,00	13,64	14,00	30,00	75,00	0,33	●
4090788	F2AU1570ADK38	15,70	16,00	15,64	16,00	34,00	82,00	0,33	●
4090789	F2AU1770ADK38	17,70	18,00	17,64	18,00	36,00	84,00	0,40	●
4090790	F2AU1970ADK38	19,70	20,00	19,63	20,00	42,00	92,00	0,40	●

KenCut KS • F2AU • Radiused • 2 Flutes • Weldon® Shank • Metric

- first choice
- alternate choice

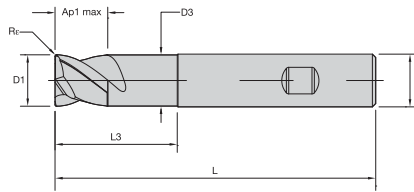

P	●
M	●
K	●
N	●
S	●
H	○

order number	catalogue number	D1	D	D3	Ap1 max	L3	L	R _ε	KC643M
4090795	F2AU0775BDK38	7,75	8,00	7,70	9,00	22,00	58,00	0,20	●
4090796	F2AU0970BDK38	9,70	10,00	9,65	11,00	26,00	66,00	0,33	●

162-163	164	117-119	168

KenCut™ KS • F3AU • Radiused • 3 Flutes • Plain Shank • Metric

- first choice
- alternate choice

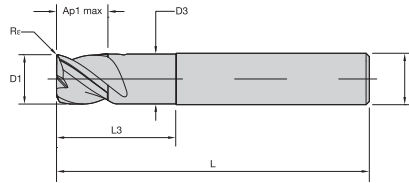

P	●
M	●
K	●
N	●
S	●
H	○

order number	catalogue number	D1	D	D3	Ap1 max	L3	L	Rε	KC643M
4090567	F3AU0280ADK38	2,80	6,00	2,75	4,00	12,00	50,00	0,12	●
4090568	F3AU0380ADK38	3,80	6,00	3,71	5,00	16,00	54,00	0,12	●
4090569	F3AU0480ADK38	4,80	6,00	4,71	6,00	16,00	54,00	0,20	●
4090570	F3AU0575ADK38	5,75	6,00	5,71	7,00	18,00	54,00	0,20	●
4090571	F3AU0775ADK38	7,75	8,00	7,70	9,00	22,00	58,00	0,20	●
4090572	F3AU0970ADK38	9,70	10,00	9,65	11,00	26,00	66,00	0,33	●
4090773	F3AU1170ADK38	11,70	12,00	11,64	12,00	28,00	73,00	0,33	●
4090774	F3AU1370ADK38	13,70	14,00	13,64	14,00	30,00	75,00	0,33	●
4090775	F3AU1570ADK38	15,70	16,00	15,64	16,00	34,00	82,00	0,33	●
4090776	F3AU1770ADK38	17,70	18,00	17,64	18,00	36,00	84,00	0,40	●
4090777	F3AU1970ADK38	19,70	20,00	19,63	20,00	42,00	92,00	0,40	●

KenCut KS • F3AU • Radiused • 3 Flutes • Weldon® Shank • Metric

- first choice
- alternate choice

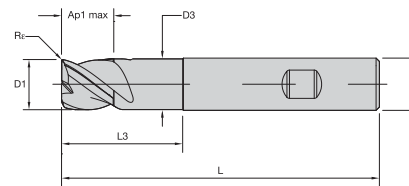
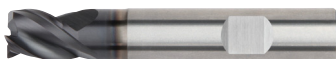

P	●
M	●
K	●
N	●
S	●
H	○

order number	catalogue number	D1	D	D3	Ap1 max	L3	L	Rε	KC643M
4061085	F3AU0280BDK38	2,80	6,00	2,75	4,00	12,00	50,00	0,12	●
4061086	F3AU0380BDK38	3,80	6,00	3,71	5,00	16,00	54,00	0,12	●
4061087	F3AU0480BDK38	4,80	6,00	4,71	6,00	16,00	54,00	0,20	●
4061091	F3AU0970BDK38	9,70	10,00	9,65	11,00	26,00	66,00	0,33	●

162-163	164	117-119	168

KenFeed™ • KHDA • Torus • 6 Flutes • Plain Shank • Metric

- first choice
- alternate choice

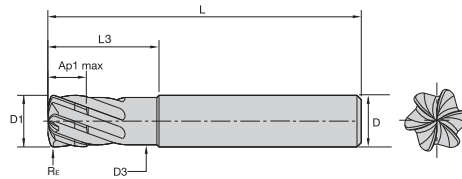

P	■
M	■
K	■
N	■
S	■
H	●

KC639M

order number	catalogue number	D1	D	D3	Ap1 max	L3	L	Re	
3351707	KHDA0600A6ANA	6,00	6,00	5,00	0,20	18,00	63,00	0,38	●
3351708	KHDA0800A6ANA	8,00	8,00	7,00	0,27	24,00	76,00	0,50	●
3351709	KHDA1000A6ANA	10,00	10,00	9,00	0,33	30,00	89,00	0,63	●
3351710	KHDA1200A6ANA	12,00	12,00	11,00	0,40	36,00	100,00	0,75	●
3351711	KHDA1600A6ANA	16,00	16,00	15,00	0,54	48,00	110,00	1,00	●
3351712	KHDA2000A6ANA	20,00	20,00	19,00	0,67	60,00	125,00	1,25	●

KenFeed • KHDA • Torus • 6 Flutes • Programming Data

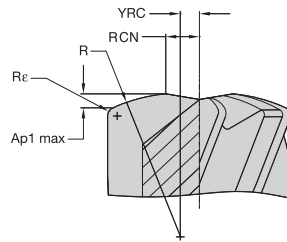

geometrical parameters							ramping guide for circular and linear ramping						
							circular interpolation		linear ramping				
							optimal range of circle diameter for a single pass		calculated length per ramp angle				
catalogue number	D1	Ap1 max	R	Re	YRC	RCN	smallest	largest	1°	2°	3°	4°	5°
KHDA0600A6ANA	6	0,20	9	0,375	0,75	1,26	8,52	12,00	11,458	5,727	3,816	2,860	2,286
KHDA0800A6ANA	8	0,27	12	0,500	1,00	1,68	11,36	16,00	15,468	7,732	5,152	3,861	3,086
KHDA1000A6ANA	10	0,33	15	0,625	1,25	2,10	14,20	20,00	18,906	9,450	6,297	4,719	3,772
KHDA1200A6ANA	12	0,40	18	0,750	1,50	2,52	17,04	24,00	22,916	11,455	7,632	5,720	4,572
KHDA1600A6ANA	16	0,54	24	1,000	2,00	3,36	22,72	32,00	30,937	15,464	10,304	7,722	6,172
KHDA2000A6ANA	20	0,67	30	1,250	2,50	4,20	28,40	40,00	38,384	19,186	12,784	9,581	7,658
recommended percentage of programmed feed rate to use while ramping									100%	70%	50%	30%	10%

162-163	164	117-119	168

KenFeed™ • KMDA • Torus • 6 Flutes • Plain Shank • Metric

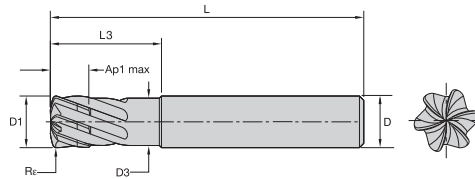

- first choice
- alternate choice

P	●
M	●
K	●
N	●
S	●
H	●

order number	catalogue number	D1	D	D3	Ap1 max	L3	L	Re	KC639M
3352369	KMDA0600A6ANA	6,00	6,00	5,00	0,32	18,00	63,00	0,38	●
3352370	KMDA0800A6ANA	8,00	8,00	7,00	0,42	24,00	76,00	0,50	●
3352371	KMDA1000A6ANA	10,00	10,00	9,00	0,53	30,00	89,00	0,63	●
3352372	KMDA1200A6ANA	12,00	12,00	11,00	0,63	36,00	100,00	0,75	●
3352493	KMDA1600A6ANA	16,00	16,00	15,00	0,84	48,00	110,00	1,00	●
3352494	KMDA2000A6ANA	20,00	20,00	19,00	1,05	60,00	125,00	1,25	●

KenFeed • KMDA • Torus • 6 Flutes • Programming Data

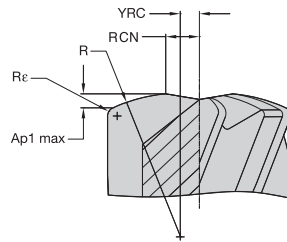

geometrical parameters							ramping guide for circular and linear ramping						
							circular interpolation		linear ramping				
							optimal range of circle diameter for a single pass		calculated length per ramp angle				
catalogue number	D1	Ap1 max	R	Re	YRC	RCN	smallest	largest	1°	2°	3°	4°	5°
KMDA0600A6ANA	6	0,32	6	0,375	0,75	1,32	8,64	12,00	18,333	9,164	6,106	4,576	3,658
KMDA0800A6ANA	8	0,42	8	0,500	1,00	1,76	11,52	16,00	24,062	12,027	8,014	6,006	4,801
KMDA1000A6ANA	10	0,53	10	0,625	1,25	2,20	14,40	20,00	30,364	15,177	10,113	7,579	6,058
KMDA1200A6ANA	12	0,63	12	0,750	1,50	2,64	17,28	24,00	36,093	18,041	12,021	9,009	7,201
KMDA1600A6ANA	16	0,84	16	1,000	2,00	3,52	23,04	32,00	48,124	24,054	16,028	12,013	9,601
KMDA2000A6ANA	20	1,05	20	1,250	2,50	4,40	28,80	40,00	60,154	30,068	20,035	15,016	12,002
recommended degree of programmed feed rate to use while ramping									100%	70%	50%	30%	10%

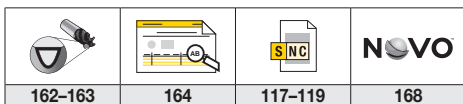

KenCut™ KS • Application Data • Metric

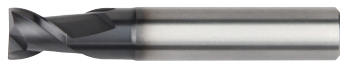

KenCut KS – F2AU



KenCut KS – F3AU

Material Group					KC643M		Recommended feed per tooth (fz = mm/th) for side milling (A). For slotting (B), reduce fz by 10%.											
	A		B		Cutting Speed – vc m/min			D1 – Diameter										
	ap	ae	ap		min	max	mm	2,0	3,0	4,0	6,0	8,0	10,0	12,0	14,0	16,0	20,0	
P	0	1 x D	0,5 x D	0,75 x D	150	–	200	fz	0,014	0,021	0,028	0,044	0,060	0,072	0,083	0,092	0,101	0,114
	1	1 x D	0,5 x D	0,75 x D	150	–	200	fz	0,014	0,021	0,028	0,044	0,060	0,072	0,083	0,092	0,101	0,114
	2	1 x D	0,5 x D	0,75 x D	140	–	190	fz	0,014	0,021	0,028	0,044	0,060	0,072	0,083	0,092	0,101	0,114
	3	1 x D	0,5 x D	0,75 x D	120	–	160	fz	0,011	0,017	0,023	0,036	0,050	0,061	0,070	0,079	0,087	0,101
	4	1 x D	0,5 x D	0,75 x D	90	–	150	fz	0,010	0,016	0,021	0,033	0,045	0,054	0,062	0,070	0,077	0,088
	5	1 x D	0,5 x D	0,75 x D	60	–	100	fz	0,009	0,014	0,019	0,029	0,040	0,048	0,056	0,063	0,070	0,081
M	1	1 x D	0,5 x D	0,75 x D	90	–	115	fz	0,011	0,017	0,023	0,036	0,050	0,061	0,070	0,079	0,087	0,101
	2	1 x D	0,5 x D	0,75 x D	60	–	80	fz	0,009	0,014	0,019	0,029	0,040	0,048	0,056	0,063	0,070	0,081
	3	1 x D	0,5 x D	0,75 x D	60	–	70	fz	0,008	0,012	0,016	0,025	0,034	0,040	0,047	0,052	0,057	0,065
K	1	1 x D	0,5 x D	0,75 x D	120	–	150	fz	0,014	0,021	0,028	0,044	0,060	0,072	0,083	0,092	0,101	0,114
	2	1 x D	0,5 x D	0,75 x D	110	–	140	fz	0,011	0,017	0,023	0,036	0,050	0,061	0,070	0,079	0,087	0,101
	3	1 x D	0,5 x D	0,75 x D	110	–	130	fz	0,009	0,014	0,019	0,029	0,040	0,048	0,056	0,063	0,070	0,081
S	1	1 x D	0,3 x D	0,3 x D	50	–	90	fz	0,011	0,017	0,023	0,036	0,050	0,061	0,070	0,079	0,087	0,101
	2	1 x D	0,3 x D	0,3 x D	25	–	40	fz	0,006	0,009	0,013	0,019	0,026	0,032	0,037	0,042	0,046	0,054
	3	1 x D	0,3 x D	0,3 x D	25	–	40	fz	0,006	0,009	0,013	0,019	0,026	0,032	0,037	0,042	0,046	0,054
	4	1 x D	0,5 x D	0,75 x D	50	–	60	fz	0,007	0,011	0,016	0,026	0,037	0,045	0,052	0,058	0,064	0,074
H	1	1 x D	0,5 x D	0,75 x D	80	–	140	fz	0,010	0,016	0,021	0,033	0,045	0,054	0,062	0,070	0,077	0,088

NOTE: Those guidelines may require variations to achieve optimum results.
 Lower value of cutting speed is used for high stock removal applications or for higher hardness (machinability) within group.
 Higher value of cutting speed is used for finishing applications or for lower hardness (machinability) within group.
 Above parameters are based on ideal conditions. For smaller taper machining centers, please adjust parameters accordingly on >12mm diameter.

KenFeed™ • KHDA • Application Data • Metric



Material Group			KC639M		Feed per Tooth – fz information is for side milling (A).							
	A		Cutting Speed – vc m/min		D1 – Diameter							
	ap	ae	min	max	mm	6,0	8,0	10,0	12,0	16,0	20,0	
H	2	0,03 x D	0,55 x D	100	120	fz	0,200	0,300	0,300	0,400	0,500	0,600
	3	0,03 x D	0,55 x D	80	100	fz	0,200	0,300	0,300	0,400	0,500	0,600
	4	0,03 x D	0,55 x D	50	70	fz	0,150	0,200	0,250	0,300	0,400	0,500

NOTE: These guidelines may require possible variations to achieve optimum results.























KenFeed • KMDA • Application Data • Metric



Material Group			KC639M		Feed per Tooth – fz information is for side milling (A).							
	A		Cutting Speed – vc m/min		D1 – Diameter							
	ap	ae	min	max	mm	6,0	8,0	10,0	12,0	16,0	20,0	
P	4	0,05 x D	0,55 x D	160	180	fz	0,300	0,500	0,500	0,500	0,600	0,700
H	1	0,05 x D	0,55 x D	140	160	fz	0,300	0,500	0,500	0,500	0,600	0,700
	2	0,05 x D	0,55 x D	100	120	fz	0,200	0,300	0,300	0,400	0,500	0,600

























NOTE: These guidelines may require possible variations to achieve optimum results.

Tool Selector

ECONOMIC ROUGHING AND FINISHING				
GOmill™				
				
Series	GOmill UEBC 2FL	GOmill UEDE 3FL	GOmill UEBE 3FL	GOmill UEDE 4FL
Page	113	113-114	114	115
Tool type				
Rougher	●	●	●	●
Finisher	○	○	○	○
Chamfering				
Main operations				
Workpiece material				
Primary	P M K S	P M K S	P M K S	P M K S
Secondary	H	H	H	H
Corner style				
Corner radius [R _ε]	—	—	—	—
Corner chamfer width [BCH]	—	—	—	0,4-0,5mm
Cutting diameter [D1]	2-12mm	2-12mm	2-12mm	4-12mm
Length of cut	1,3-2 x D	1,3-2 x D	1,3-2 x D	1,3-1,8 x D
Maximum cutting depth [A _{p1} max]	4-15mm	4-15mm	4-15mm	7-15mm
Flute helix angle	30°	38°	38°	38°
Number of flutes [ZU]	2	3	3	4
Center cutting	✓	✓	✓	✓
Additional operations	 	  	 	  

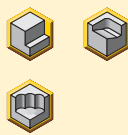
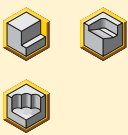
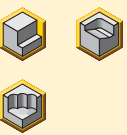



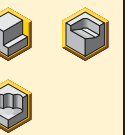



















- Primary
- Secondary

Tool Selector

GENERAL PURPOSE ROUGHING AND FINISHING							
GOMILL™ GP							
							
Series	GOMill GP 2CH..DK-DL	GOMill GP 2CH..DD	2CH..MR-ML-MX	2BN..DK-DL	2BN..DD	2BN..MR-ML-MX	3CH..DK-DL
Page	kennametal.com	kennametal.com	kennametal.com	kennametal.com	kennametal.com	kennametal.com	kennametal.com
Tool type							
Rougher	●	●	●	●	●	●	●
Finisher	○	○	○	○	○	○	○
Chamfering							
Main operations							
Workpiece material							
Primary	P M K	P M K	P M K	P M K	P M K	P M K	P M K
Secondary	N	N	N	N	N	N	N
Corner style							
Corner radius [Rε]	—	—	—	—	—	—	—
Corner chamfer width [BCH]	0,1–0,3mm	0,1–0,3mm	0,1–0,3mm	—	—	—	0,1–0,3mm
Cutting diameter [D1]	2–20mm	3–20mm	3–20mm	2–20mm	2–20mm	1–20mm	2–20mm
Length of cut	1–2,3 x D	1,4–2,7 x D	1,9–8,3 x D	1–3 x D	1,6–3,5 x D	1,9–6,3 x D	1–3 x D
Maximum cutting depth [Ap1 max]	3–32mm	8–32mm	6,3–75mm	6–32mm	7–32mm	4–75mm	3–32mm
Flute helix angle	30°	30°	30°	30°	30°	30°	30°
Number of flutes [ZU]	2	2	2	2	2	2	3
Center cutting	✓	✓	✓	✓	✓	✓	✓
Additional operations							

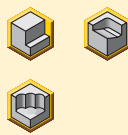
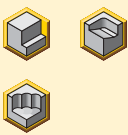
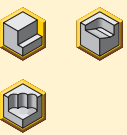
- Primary
- Secondary

Tool Selector

GENERAL PURPOSE ROUGHING AND FINISHING							
GOMill™ GP							
							
Series	3CH..MS-MX	4CH..DK-DL	4CH..DD	4CH..MR-ML-MX	4BN..DK-DL	4BN..DD	4BN..MR-ML
Page	kennametal.com	kennametal.com	kennametal.com	kennametal.com	kennametal.com	kennametal.com	kennametal.com
Tool type							
<i>Rougher</i>	●	●	●	●	●	●	●
<i>Finisher</i>	○	○	○	○	○	○	○
<i>Chamfering</i>							
Main operations							
Workpiece material							
<i>Primary</i>	P M K	P M K	P M K	P M K	P M K	P M K	P M K
<i>Secondary</i>	N	N	N	N	N	N	N
Corner style							
Corner radius [Rε]	—	—	—	—	—	—	—
Corner chamfer width [BCH]	0,1–0,3mm	0,1–0,3mm	0,1–0,3mm	0,1–0,3mm	—	—	—
Cutting diameter [D1]	1–20mm	2–20mm	4–20mm	2–20mm	3–20mm	4–20mm	3–20mm
Length of cut	2–6,3 x D	1,3–3,2 x D	1,8–2,8 x D	1,9–8,3 x D	1,8–2,8 x D	1,8–2,8 x D	2–6,7 x D
Maximum cutting depth [Ap1 max]	4–64mm	4–38mm	11–38mm	6,3–75mm	8–38mm	11–38mm	20–56mm
Flute helix angle	30°	30°	30°	30°	30°	30°	30°
Number of flutes [ZU]	3	4	4	4	4	4	4
Center cutting	✓	✓	✓	✓	✓	✓	✓
Additional operations							

- Primary
- Secondary

GOmill™

Economic Roughing and Finishing

Materials



Applications



Ramping



Slotting: Square End



Shoulder Milling



Short length of cut end mills

Economic, short length-of-cut solid carbide end mills for roughing and finishing in multiple materials.

The GOmill solid carbide end mill series provides extremely stable cutting conditions.

Short overall length and a soft cutting geometry makes this line also a perfect fit for mill-turn machines and driven units in lathes. Works with any adapter; clamping sleeve in hydraulic chucks are recommended.

Unequally spaced three- and four-flute versions minimize vibrations and provide high tool life and superior surface quality.

Economic solution due to shorter-than-regular shanks, reducing overall tooling cost.

Short length and high-performance geometry enable chatter-free, 1 x D full slot machining in multiple materials.

Center cutting for plunging and ramping.

GOmill™ • Ball Nose • 2 Flutes • Plain Shank • Metric

- first choice
- alternate choice

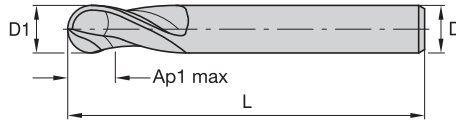

P	●
M	●
K	●
N	●
S	●
H	○

order number	catalogue number	D1	D	Ap1 max	L		KC643M
4152204	UEBC0200A2A	2,00	6,00	4,00	38,00	●	●
4152205	UEBC0300A2A	3,00	6,00	5,00	38,00	●	●
4152206	UEBC0400A2A	4,00	6,00	7,00	38,00	●	●
4152207	UEBC0500A2A	5,00	6,00	8,00	38,00	●	●
4152208	UEBC0600A2A	6,00	6,00	8,00	38,00	●	●
4152209	UEBC0800A2A	8,00	8,00	11,00	43,00	●	●
4152210	UEBC1000A2A	10,00	10,00	13,00	50,00	●	●
4152211	UEBC1200A2A	12,00	12,00	15,00	73,00	●	●

GOmill • Square End • 3 Flutes • Plain Shank • Metric

- first choice
- alternate choice

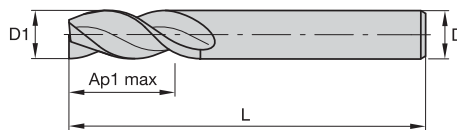

P	●
M	●
K	●
N	●
S	●
H	○

order number	catalogue number	D1	D	Ap1 max	L		KC643M
4032783	UEDE0200A3AS	2,00	6,00	4,00	38,00	●	●
4032784	UEDE0300A3AS	3,00	6,00	5,00	38,00	●	●
4032785	UEDE0400A3AS	4,00	6,00	7,00	38,00	●	●
4032786	UEDE0500A3AS	5,00	6,00	8,00	38,00	●	●
4032787	UEDE0600A3AS	6,00	6,00	8,00	38,00	●	●
4032788	UEDE0800A3AS	8,00	8,00	11,00	43,00	●	●
4032789	UEDE1000A3AS	10,00	10,00	13,00	50,00	●	●
4032790	UEDE1200A3AS	12,00	12,00	15,00	55,00	●	●

162-163	164	117-119	168

G0mill • Square End • 3 Flutes • Weldon® Shank • Metric

- first choice
- alternate choice

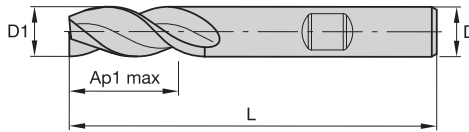

P	●
M	●
K	●
N	●
S	●
H	○

order number	catalogue number	D1	D	Ap1 max	L	KC643M
4032791	UEDE0200B3AS	2,00	6,00	4,00	38,00	●
4032792	UEDE0300B3AS	3,00	6,00	5,00	38,00	●
4032793	UEDE0400B3AS	4,00	6,00	7,00	38,00	●
4032794	UEDE0500B3AS	5,00	6,00	8,00	38,00	●
4032795	UEDE0600B3AS	6,00	6,00	8,00	38,00	●
4032796	UEDE0800B3AS	8,00	8,00	11,00	43,00	●
4032797	UEDE1000B3AS	10,00	10,00	13,00	50,00	●
4032798	UEDE1200B3AS	12,00	12,00	15,00	55,00	●

G0mill™ • Ball Nose • 3 Flutes • Plain Shank • Metric

- first choice
- alternate choice

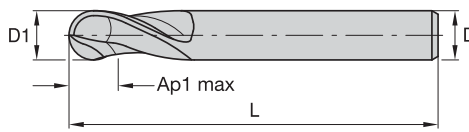

P	●
M	●
K	●
N	●
S	●
H	○

order number	catalogue number	D1	D	Ap1 max	L	KC643M
4032304	UEBE0200A3A	2,00	6,00	4,00	38,00	●
4032305	UEBE0300A3A	3,00	6,00	5,00	38,00	●
4032306	UEBE0400A3A	4,00	6,00	7,00	38,00	●
4032307	UEBE0500A3A	5,00	6,00	8,00	38,00	●
4032308	UEBE0600A3A	6,00	6,00	8,00	38,00	●
4032309	UEBE0800A3A	8,00	8,00	11,00	43,00	●
4032310	UEBE1000A3A	10,00	10,00	13,00	50,00	●
4032311	UEBE1200A3A	12,00	12,00	15,00	55,00	●

162-163	164	117-119	168

GOmill™ • Chamfered • 4 Flutes • Plain Shank • Metric

- first choice
- alternate choice

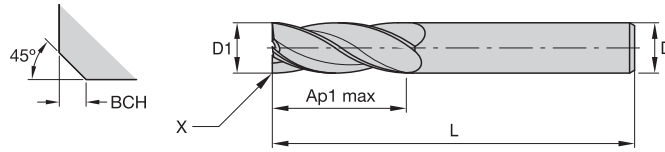
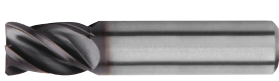

P	<input checked="" type="checkbox"/>
M	<input checked="" type="checkbox"/>
K	<input checked="" type="checkbox"/>
N	<input checked="" type="checkbox"/>
S	<input checked="" type="checkbox"/>
H	<input type="checkbox"/>

order number	catalogue number	D1	D	Ap1 max	L	BCH	KC643M
4032802	UEDE0400A4AH	4,00	6,00	7,00	38,00	0,40	●
4032813	UEDE0600A4AH	6,00	6,00	8,00	38,00	0,40	●
4032814	UEDE0800A4AH	8,00	8,00	11,00	43,00	0,40	●
4032815	UEDE1000A4AH	10,00	10,00	13,00	50,00	0,50	●
4032816	UEDE1200A4AH	12,00	12,00	15,00	55,00	0,50	●

GOmill • Chamfered • 4 Flutes • Weldon® Shank • Metric

- first choice
- alternate choice

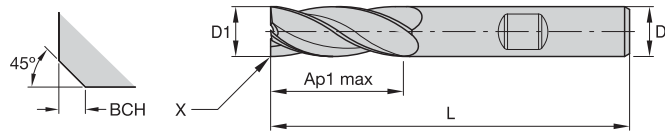
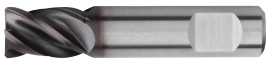

P	<input checked="" type="checkbox"/>
M	<input checked="" type="checkbox"/>
K	<input checked="" type="checkbox"/>
N	<input checked="" type="checkbox"/>
S	<input checked="" type="checkbox"/>
H	<input type="checkbox"/>

order number	catalogue number	D1	D	Ap1 max	L	BCH	KC643M
4032817	UEDE0400B4AH	4,00	6,00	7,00	38,00	0,40	●
4032820	UEDE0600B4AH	6,00	6,00	8,00	38,00	0,40	●
4032821	UEDE0800B4AH	8,00	8,00	11,00	43,00	0,40	●
4032822	UEDE1000B4AH	10,00	10,00	13,00	50,00	0,50	●
4032823	UEDE1200B4AH	12,00	12,00	15,00	55,00	0,50	●

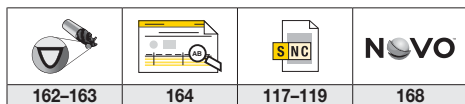

GOmill™ • UEBC, UEBE, & UEDE • Application Data • Metric



GOmill – 2 Flutes – UEBC



GOmill – 3 Flutes – UEBE

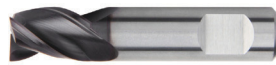

GOmill – 3 Flutes – UEDE

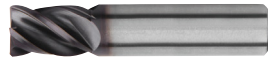

GOmill – 4 Flutes – UEDE

Material Group					KC643M			Recommended feed per tooth (fz = mm/th) for side milling (A). For slotting (B), reduce fz by 10%.								
	A		B	Cutting Speed – vc m/min			mm	D1 – Diameter								
	ap	ae	ae	min	max	2,0		3,0	4,0	5,0	6,0	8,0	10,0	12,0		
P	0	1,5 x D	0,5 x D	1 x D	150	–	200	fz	0,014	0,022	0,028	0,036	0,044	0,060	0,072	0,083
	1	1,5 x D	0,5 x D	1 x D	150	–	200	fz	0,014	0,022	0,028	0,036	0,044	0,060	0,072	0,083
	2	1,5 x D	0,5 x D	1 x D	140	–	190	fz	0,014	0,022	0,028	0,036	0,044	0,060	0,072	0,083
	3	1,5 x D	0,5 x D	1 x D	120	–	160	fz	0,012	0,018	0,023	0,030	0,036	0,050	0,061	0,070
	4	1,5 x D	0,5 x D	0,75 x D	90	–	150	fz	0,011	0,016	0,021	0,027	0,033	0,045	0,054	0,062
	5	1,5 x D	0,5 x D	1 x D	60	–	100	fz	0,010	0,015	0,019	0,024	0,029	0,040	0,048	0,056
M	1	1,5 x D	0,5 x D	1 x D	90	–	115	fz	0,012	0,018	0,023	0,030	0,036	0,050	0,061	0,070
	2	1,5 x D	0,5 x D	1 x D	60	–	80	fz	0,010	0,015	0,019	0,024	0,029	0,040	0,048	0,056
	3	1,5 x D	0,5 x D	1 x D	60	–	70	fz	0,008	0,012	0,016	0,020	0,025	0,034	0,040	0,047
K	1	1,5 x D	0,5 x D	1 x D	120	–	150	fz	0,014	0,022	0,028	0,036	0,044	0,060	0,072	0,083
	2	1,5 x D	0,5 x D	1 x D	110	–	140	fz	0,012	0,018	0,023	0,030	0,036	0,050	0,061	0,070
	3	1,5 x D	0,5 x D	1 x D	110	–	130	fz	0,010	0,015	0,019	0,024	0,029	0,040	0,048	0,056
S	1	1,5 x D	0,3 x D	0,3 x D	50	–	90	fz	0,012	0,018	0,023	0,030	0,036	0,050	0,061	0,070
	2	1,5 x D	0,3 x D	0,3 x D	25	–	40	fz	0,006	0,010	0,013	0,016	0,019	0,026	0,032	0,037
	3	1,5 x D	0,3 x D	0,3 x D	25	–	40	fz	0,006	0,010	0,013	0,016	0,019	0,026	0,032	0,037
	4	1,5 x D	0,5 x D	1 x D	50	–	60	fz	0,008	0,013	0,016	0,021	0,026	0,037	0,045	0,052
H	1	1,5 x D	0,5 x D	0,75 x D	80	–	140	fz	0,011	0,016	0,021	0,027	0,033	0,045	0,054	0,062

NOTE: Lower value of cutting speed is used for high stock removal applications or for higher hardness (machinability) within group.
Higher value of cutting speed is used for finishing applications or for lower hardness (machinability) within group.

GOmill Series • Adjustment Factor for Feed and Speed Calculation • Metric

	Ae/D	2%	4%	5%	8%	10%	12%	20%	30%	40%	50%	100%
Speed factor	Kv	2,1–3,6	1,6–3	1,6–2,5	1,6	1,4	1,38	1,3	1,2	1,1	1	0,9
Feed factor	KFz	3,58	2,56	2,3	1,84	1,67	1,54	1,25	1,09	1,02	1	1

NOTE: For an Ae/D ratio of 5% or less there is a range given for speed factor Kv, which allows the user to either be more conservative at the lower value or more aggressive with the higher value.
This can also be considered based on the machinability of the material, from difficult to free cutting.
These calculations are for roughing/semi-finishing cuts when used with the recommended base Fz.
For light finishing cuts requiring improved surface quality it is recommended to reduce the base Fz approximately 50% and then apply these factors.

To calculate application specific cutting data, please use Kv coefficient table to the right for adaptation of cutting speed and KFz for feed respectively.

Vc new = Vc * Kv
Fz new = IPT * KFz

Calculation example:

Application: D1 = 12mm;
P4 material group;
Ae 1,2mm (Ae = 10% of D1)
Cutting data recommendation: 150m/min;
Fz = 0,062mm/z
Adjustment coefficients: Ae = 1,2mm equals 10%;
Kv = 1,4; KFz = 1,67

Final cutting data recommendation:

Vc new = 150 * 1,4 = 210m/min
Fz new = 0,062 * 1,67 = 0,103mm/z

HARVI™ I TE • KOR™ • PCD • Catalog Numbering System

Each character in our catalog number signifies a specific trait of that product. Use the following key columns and corresponding images to easily identify which attributes apply.

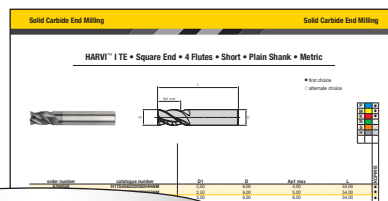

H1TE4SE1200S016HAM

H1TE	4	SE	1200	S	016	HA			M																														
Series	Number of Flutes	Front End Style	Cutting Diameter D1	Flute Section Style	Length of Cut Ap1 max	Shank Style	Radius	Specific Features	Standard																														
<p>H1TE = HARVI I TE</p> <p>KOR = KOR</p> <p>ALCB = Basic PCD end mill with carbide body</p> <p>ALCC = Complex PCD end mill carbide body</p> <p>ALCR = Roughing PCD end mill with carbide body</p> <p>ALSB = Basic PCD end mill with steel body</p> <p>ALSR = Basic PCD end mill with steel body</p>	<p>1 = 1-Flute</p> <p>2 = 2-Flute</p> <p>3 = 3-Flute</p> <p>4 = 4-Flute</p> <p>5 = 5-Flute</p> <p>6 = 6-Flute</p> <p>7 = 7-Flute</p> <p>8 = 8-Flute</p> <p>9 = 9-Flute</p> <p>M = Multi-flute</p>	<p>SE = Sharp Edge</p> <p>CH = Chamfer</p> <p>RA = Radius</p> <p>BN = Ball Nose</p> <p>TB = Taper Ball Nose</p> <p>TO = Torroid</p>	<p>Metric = D1 in mm</p> <p>Inch = D1 in decimal inch</p>	<p>N = Neck</p> <p>E = Extended Neck</p> <p>S = Short Without Neck</p> <p>R = Regular Without Neck</p> <p>L = Long Without Neck</p> <p>X = Extra Long Without Neck</p>	<p>Metric = Ap1 Max in mm</p> <p>Inch = Ap1 Max in decimal inch</p>	<p>HA = Plain</p> <p>HB = Weldon®</p> <p>SL = Safe-Lock™</p> <p>DL = DUO-LOCK™</p>		<p>C = Chip Splitter</p> <p>I = Internal Coolant</p> <p>O = Coolant Grooves in Shank</p> <p>P = Polished Flutes</p>	<p>M = Metric</p> <p>Blank = Inch</p>																														
						<table border="1"> <thead> <tr> <th>Radius Metric</th> <th>Radius Inch</th> </tr> </thead> <tbody> <tr><td>R020 = 0,2mm</td><td>R010 = .010"</td></tr> <tr><td>R025 = 0,25mm</td><td>R015 = .015"</td></tr> <tr><td>R030 = 0,3mm</td><td>R030 = .030"</td></tr> <tr><td>R040 = 0,4mm</td><td>R060 = .060"</td></tr> <tr><td>R050 = 0,5mm</td><td>R090 = .090"</td></tr> <tr><td>R075 = 0,75mm</td><td>R120 = .120"</td></tr> <tr><td>R100 = 1,0mm</td><td>R160 = .160"</td></tr> <tr><td>R125 = 1,25mm</td><td>R250 = .250"</td></tr> <tr><td>R150 = 1,5mm</td><td>R190 = .190"</td></tr> <tr><td>R200 = 2,0mm</td><td>R375 = .375"</td></tr> <tr><td>R250 = 2,5mm</td><td>R045 = .045"</td></tr> <tr><td>R300 = 3,0mm</td><td></td></tr> <tr><td>R400 = 4,0mm</td><td></td></tr> <tr><td>R500 = 5,0mm</td><td></td></tr> <tr><td>R600 = 6,0mm</td><td></td></tr> </tbody> </table>	Radius Metric	Radius Inch	R020 = 0,2mm	R010 = .010"	R025 = 0,25mm	R015 = .015"	R030 = 0,3mm	R030 = .030"	R040 = 0,4mm	R060 = .060"	R050 = 0,5mm	R090 = .090"	R075 = 0,75mm	R120 = .120"	R100 = 1,0mm	R160 = .160"	R125 = 1,25mm	R250 = .250"	R150 = 1,5mm	R190 = .190"	R200 = 2,0mm	R375 = .375"	R250 = 2,5mm	R045 = .045"	R300 = 3,0mm		R400 = 4,0mm		R500 = 5,0mm		R600 = 6,0mm		
Radius Metric	Radius Inch																																						
R020 = 0,2mm	R010 = .010"																																						
R025 = 0,25mm	R015 = .015"																																						
R030 = 0,3mm	R030 = .030"																																						
R040 = 0,4mm	R060 = .060"																																						
R050 = 0,5mm	R090 = .090"																																						
R075 = 0,75mm	R120 = .120"																																						
R100 = 1,0mm	R160 = .160"																																						
R125 = 1,25mm	R250 = .250"																																						
R150 = 1,5mm	R190 = .190"																																						
R200 = 2,0mm	R375 = .375"																																						
R250 = 2,5mm	R045 = .045"																																						
R300 = 3,0mm																																							
R400 = 4,0mm																																							
R500 = 5,0mm																																							
R600 = 6,0mm																																							

Catalog Numbering System

Each character in our catalog number signifies a specific trait of that product. Use the following key columns and corresponding images to easily identify which attributes apply.

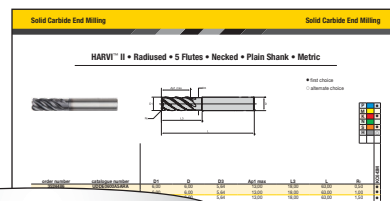

UDDE1000A5ARA

UD	D	E	1000	A	5	A	R	A
Series	Front End Style	Helix Angle	Cutting Diameter D1	Shank Style	Number of Flutes	Length of Cut Ap1 Max	Specific Features	Radius
AA = Aluminum AB = MaxiMet™ CB = CFRP Burr CC = CFRP Compression CD = CFRP Downcutter CR = CFRP Ball GA = General Application KH = KenFeed™ (Hard Steels) KM = KenFeed (Medium Steels) RU = Rougher (Flat Shallow Profile) UC = HARVI II™ (Material Group M) UD = HARVI II (Material Group S) UG = HARVI II Long (3 x D & 5 x D) UJ = HARVI III Center Cut & Eccentric Relief UE = GOMill™ FS = RSM II Multiflute (Material Group S) EA = Ceramic End Mill (Nickel-Based Alloys)	B = Ballnose RH D = Square End RH	A = 0-10 B = 11-20 C = 21-30 D = 31-35 E = 36-40 F = 41-45 G = 46-60 V = Variable Helix	Metric = D1 in mm Inch = D1 in decimal inch	Metric A = Plain B = Weldon® C = Whistle Notch D = Weldon & Whistle Notch E = Plain & Safe-Lock™ X = DUO-LOCK™ Inch J = Plain K = Weldon N = Safe-Lock Y = DUO-LOCK	1 2 3 4 5 6 7 8 9 A = 10 B = 11 C = 12 D = 13 E = 14 F = 15 G = 16 H = 17 I = 18 J = 19 M = multi	A = Regular B = Long C = Extra Long D = XX Long	B = HARVI III Aero C = Coolant H = Chamfer K = Extended Reach + Neck + Radius L = Extended Reach + Neck + Chamfer M = Extended Reach + Neck + Sharp Edge N = Necked P = Tapered Q = Necked + Radius R = Radius S = Square (Sharp Edge) T = Toroid U = Necked + Sharp Edge V = Necked + Chamfer Y = Necked + Radius + Coolant	Metric A = 0,20 B = 0,25 C = 0,30 D = 0,40 E = 0,50 F = 0,75 G = 1,00 H = 1,25 J = 1,50 K = 2,00 L = 2,50 M = 3,00 N = 4,00 P = 6,00 Q = 5,00 S = Sharp Edge X = Custom Inch A = .015 B = .030 C = .060 D = .090 E = .120 F = .250 H = .190 J = .375 K = .500

Catalog Numbering System



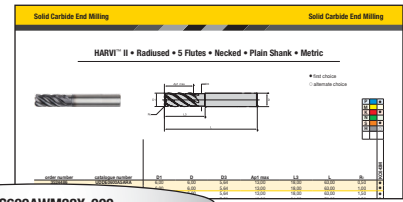















Each character in our catalog number signifies a specific trait of that product. Use the following key columns and corresponding images to easily identify which attributes apply.



F4AS600AWM38X-000



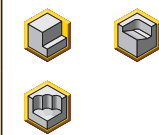

























F Tool Type	4 Number of Flutes	AS Series	600 Cutting Diameter D1	A Shank Style	WM Tool Length	38 Helix Angle	 Specific Feature	X-000 Radius
<p>F = Solid Carbide End Mill Metric</p>	<p>1 2 3 4 5 6 7 8 9 10 11 15 19</p>	<p>AA = Aluminum Rough/Finish AB = MaxiMet™ for Aluminum AL = Ball Nose for Hardened Material AS = DIN Standard End Mills AT = Toroidal End Mill for Hardened Material AU = Key Way End Mill AV = Multiflute End Mills for Hardened Material AW = HARVI™ I Ball Nose and Taper Ball Nose BA = Rougher Cord Style for Aluminum BH = 3FL Rougher Cord Style DIN 6527 BJ = 4-6FL Rougher Cord Style DIN 6527 BS = Rougher Chipbreaker Profile</p>	<p>Metric = D1 in mm Inch = D1 in decimal inch</p>	<p>A = Plain B = Weldon® E = Safe-Lock™</p>	<p>DK = DIN6527 Short DL = DIN6527 Long WS = Factory Standard Short WM = Factory Standard Medium WL = Factory Standard Long WX = Factory Standard Xtra Long</p>	<p>Blank = Not defined</p>	<p>Blank = Non coolant C = Internal Coolant</p>	<p>_100 = Length of Cut Ap1 Max in mm/10 E100 = Neck Length in mm/10 L100 = Length of Cut Ap1 Max in mm/10 R100 = Radius in mm/10</p>

Tool Selector

HIGH-PERFORMANCE ROUGHING & FINISHING					
	HARVI™ I TE		HARVI I		
	NEW!	NEW!			
					
Series	H1TE4CH..R	H1TE4RA..R	UKDV	ULDV	UKBV
Page	126	126	127	127	128
Tool type					
Rougher	●	●	●	●	●
Finisher	○	○	○	○	○
Chamfering					
Main operations					
Workpiece material					
Primary	P M K	P M K S	P M	S	P M
Secondary	S H	H	K S	P M H	K S H
Corner style					
Corner radius [R _ε]	—	0,5–3,0mm	—	0,5–4mm	—
Corner chamfer width [BCH]	0,15–0,48mm	—	0,5mm	—	—
Cutting diameter [D1]	10–32mm	10–20mm	10–32mm	10–32mm	10–25mm
Length of cut	1,5 x D	1,5 x D	1,5 x D	1,5 x D	1,5 x D
Maximum cutting depth [A _{p1} max]	15–37,5mm	15–30mm	15–48mm	15–48mm	15–37,5mm
Flute helix angle	36°/39°	36°/39°	37°/39°	37°/39°	37°/39°
Number of flutes [ZU]	4	4	4	4	4
Center cutting	✓	✓	✓	✓	✓
Additional operations					























- Primary
- Secondary

Tool Selector

	HIGH-PERFORMANCE ROUGHING & FINISHING		HP ROUGHING & FINISHING		ROUGHER	
	HARVI™ II		HARVI III		KenCut™ RR	
						
Series	UCDV	UDDV	UJDV	UJBV	RQDB	RKDF
Page	128	129	130	130	136	136
Tool type						
Rougher	○	○			●	●
Finisher	●	●	●	●		
Chamfering						
Main operations						
Workpiece material						
Primary	P M	S	S	P M	P M	S
Secondary	K S H	P H	P M H	K S H	K S H	P M K H
Corner style						
Corner radius [R _ε]	—	0,5–5mm	0,5–4mm	—	—	0,5–0,75mm
Corner chamfer width [BCH]	0,5mm	—	—	—	0,5mm	—
Cutting diameter [D1]	10–32mm	10–32mm	10–32mm	10–25mm	10–25mm	10–25mm
Length of cut	1,5 x D	1,5 x D	1,5 x D	1,5 x D	1,5 x D	1,5 x D
Maximum cutting depth [A _{p1} max]	15–48mm	15–48mm	15–48mm	15–37,5mm	15–37,5mm	15–37,5mm
Flute helix angle	37°/39°	37°/39°	37°/39°	37°/39°	20°	45°
Number of flutes [ZU]	5	5	6	6	4 & 5	4 & 6
Center cutting	—	—	✓	✓	—	✓
Additional operations	 	 			 	 























- Primary
- Secondary

Tool Selector

	FINISHER		ALUMINUM MACHINING		
	KenCut FF	RSM II™	MaxiMet™		
					
Series	F MDF	FS DE	AB DF	AB DE	AB BE
Page	138	138	140	140	141
Tool type					
Rougher			●	●	●
Finisher	●	●	○	●	●
Chamfering					
Main operations					
Workpiece material					
Primary	P M	S	N	N	N
Secondary	K S H	P M H			
Corner style					
Corner radius [R _c]	0,5–0,75mm	0,5–4mm	–	0,5–4mm	–
Corner chamfer width [BCH]	–	–	–	–	–
Cutting diameter [D1]	10–25mm	10–25mm	10–20mm	10–25mm	10–25mm
Length of cut	1,5 x D	1,5 x D	1,5 x D	1,5 x D	1,5 x D
Maximum cutting depth [A _{p1} max]	15–37,5mm	15–37,5mm	15–30mm	15–37,5mm	15–37,5mm
Flute helix angle	45°	36°	45°	38°	38°
Number of flutes [ZU]	6	9, 11, 15, & 19	2	3	3
Center cutting	✓	–	✓	✓	✓
Additional operations			 	 	 
					

- Primary
- Secondary

Tool Selector

	HIGH-FEED		DRIVEN TOOLING		CHAMFERER	
	KenFeed™		KenCut™ RR	KenCut FF	KenCut CM	
						
Series	KMDA	KSDB	RFDD	FGDF	XADA	XRDA
Page	143	144	146	146	148	148
Tool type						
Rougher	●	●	●	●		
Finisher	●	●		○		
Chamfering					●	●
Main operations						
Workpiece material						
Primary	H	S	P M	P M	P M	P M
Secondary	P	P M	K H	K S H	K N S H	K N S H
Corner style					—	—
Corner radius [R _ε]	0,36–1,25mm	0,36–1,25mm	0,4mm	0,33–0,4mm	—	—
Corner chamfer width [BCH]	—	—	—	—	—	—
Cutting diameter [D1]	10–20mm	10–20mm	10–20mm	10–20mm	10–16mm	10–16mm
Length of cut	—	—	0,75 x D	0,75 x D	2–4mm	1,5–4mm
Maximum cutting depth [A _{p1} max]	0,33–0,67mm	0,33–0,67mm	7,5–15mm	7,5–15mm	2–4mm	1,5–4mm
Flute helix angle	20°	20°	35°	42°/45°/48°	0°	0°
Number of flutes [ZU]	6	6	3	3	4, 5, & 6	4, 5, & 6
Center cutting	—	—	✓	✓	—	—
Additional operations			 	 		

- Primary
- Secondary

Modular End Milling



DUO-LOCK™

Modular End Milling



NEW!

Portfolio Materials



Portfolio Applications



Plunge Milling



Ramping



Slotting



Side Milling/
Shoulder Milling



3D Milling/Profiling



Chamfer Milling



Side Milling/Shoulder
Milling: Radius

DUO-LOCK®
by HAIMER® and Kennametal

DUO-LOCK is a new revolutionary coupling for solid carbide end milling applications. This replaceable head design combines a high accuracy in runout and length repeatability with maximum stability, making it a precise and virtually unbreakable interface.

The **ONLY** modular system with the performance of a solid carbide end mill.

To adapt DUO-LOCK perfectly to your spindle, a vast array of adapters and extensions is available.

- Standard-length extensions with Safe-Lock™, cylindrical and conical.
- Cut-to-size extensions, cylindrical and conical.
- Integral adapters with HSK, PSC, DV, and BT back ends.

Intermediate diameters are available upon request as custom solutions.

Reconditioning will maximize tool life and your investment.

Double cone eliminates expensive presetting processes by providing an axial $10\mu\text{m}$ repeatability. Length repeatability from insert tip-to-tip within $50\mu\text{m}$.

3rd contact surface delivers high stiffness and highest accuracy below $5\mu\text{m}$ runout.



Vast array of roughing, finishing, profiling, and chamfering tools, and blanks available, covering all end milling applications.

Intelligent thread ensures stress level to remain below critical values, allowing $>25\%$ higher transmittable torque.

With a DUO-LOCK™ wrench, the tool change becomes easy and can be done in a few seconds.

Adapters

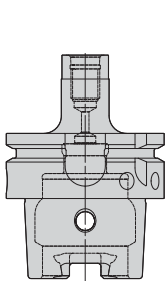

HSK

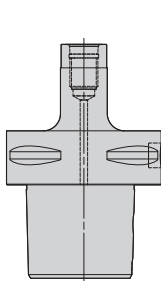

PSC

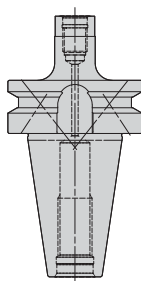

BT

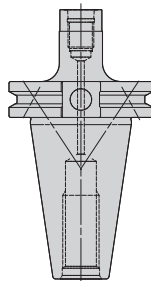

CV

Extensions

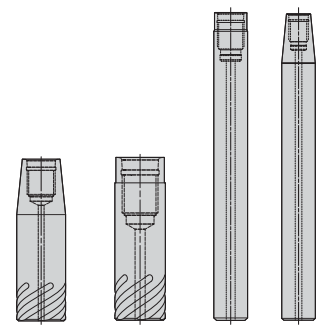

SAFE-LOCK®
by HAIMER®

Cut-to-length

DUO-LOCK™ • HARVI™ I TE • Chamfered • 4 Flutes • Metric

- first choice
- alternate choice

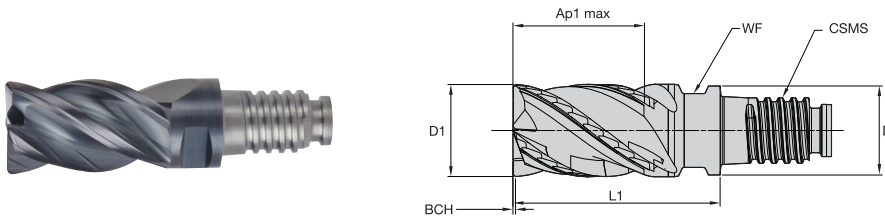

P	●
M	●
K	●
N	○
S	○
H	○

order number	catalogue number	D1	D	Ap1 max	L1	CSMS system size	WF	BCH	KCPM15
6953204	H1TE4CH1000R015DLM	10,00	9,60	15,00	22,50	DL10	8,00	0,50	●
6953205	H1TE4CH1200R018DLM	12,00	11,50	18,00	27,00	DL12	9,50	0,50	●
6953206	H1TE4CH1600R024DLM	16,00	15,50	24,00	36,00	DL16	13,00	0,50	●
6953207	H1TE4CH2000R030DLM	20,00	19,30	30,00	45,00	DL20	16,00	0,50	●
6953208	H1TE4CH2500R038DLM	25,00	24,00	37,50	56,50	DL25	21,00	0,50	●
6953209	H1TE4CH3200R048DLM	32,00	31,00	48,00	72,00	DL32	28,00	0,50	●

DUO-LOCK • HARVI I TE • Radiused • 4 Flutes • Metric

- first choice
- alternate choice

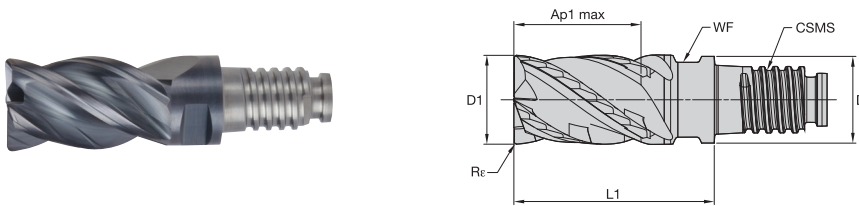

P	●
M	●
K	○
N	○
S	○
H	○

order number	catalogue number	D1	D	Ap1 max	L1	CSMS system size	WF	Rr	KCSM15
6953210	H1TE4RA1000R015DLR050M	10,00	9,60	15,00	22,50	DL10	8,00	0,50	●
6953261	H1TE4RA1200R018DLR050M	12,00	11,50	18,00	27,00	DL12	9,50	0,50	●
6953262	H1TE4RA1200R018DLR100M	12,00	11,50	18,00	27,00	DL12	9,50	1,00	●
6953263	H1TE4RA1600R024DLR100M	16,00	15,50	24,00	36,00	DL16	13,00	1,00	●
6953264	H1TE4RA1600R024DLR300M	16,00	15,50	24,00	36,00	DL16	13,00	3,00	●
6953265	H1TE4RA2000R030DLR300M	20,00	19,30	30,00	45,00	DL20	16,00	3,00	●

162-163	164	159-161	168

DUO-LOCK™ • HARVI™ I • Chamfered • 4 Flutes • Metric

- first choice
- alternate choice

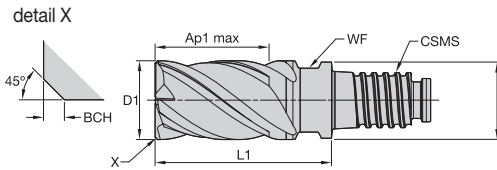

P	●
M	●
K	○
N	○
S	○
H	○

order number	catalogue number	D1	D	Ap1 max	L1	CSMS system size	WF	BCH	KCPM15
6072110	UKDV1000X4CV	10,00	9,60	15,00	22,50	DL10	8,00	0,50	●
6072161	UKDV1200X4CV	12,00	11,50	18,00	27,00	DL12	9,50	0,50	●
6072162	UKDV1600X4CV	16,00	15,50	24,00	36,00	DL16	13,00	0,50	●
6072163	UKDV2000X4CV	20,00	19,30	30,00	45,00	DL20	16,00	0,50	●
6072164	UKDV2500X4CV	25,00	24,00	37,50	56,50	DL25	21,00	0,50	●
6072165	UKDV3200X4CV	32,00	31,00	48,00	71,70	DL32	28,00	0,50	●

DUO-LOCK • HARVI I • Radiused • 4 Flutes • Metric

- first choice
- alternate choice

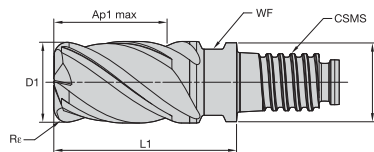

P	●
M	●
K	○
N	○
S	●
H	○

order number	catalogue number	D1	D	Ap1 max	L1	CSMS system size	WF	Re	KCSM15
6072166	ULDV1000X4CQE	10,00	9,60	15,00	22,50	DL10	8,00	0,50	●
6072167	ULDV1000X4CQG	10,00	9,60	15,00	22,50	DL10	8,00	1,00	●
6072168	ULDV1000X4CQJ	10,00	9,60	15,00	22,50	DL10	8,00	1,50	●
6072169	ULDV1200X4CQE	12,00	11,50	18,00	27,00	DL12	9,50	0,50	●
6072170	ULDV1200X4CQG	12,00	11,50	18,00	27,00	DL12	9,50	1,00	●
6072181	ULDV1200X4CQJ	12,00	11,50	18,00	27,00	DL12	9,50	1,50	●
6072182	ULDV1200X4CQL	12,00	11,50	18,00	27,00	DL12	9,50	2,50	●
6072183	ULDV1600X4CQG	16,00	15,50	24,00	36,00	DL16	13,00	1,00	●
6072184	ULDV1600X4CQJ	16,00	15,50	24,00	36,00	DL16	13,00	1,50	●
6072185	ULDV1600X4CQK	16,00	15,50	24,00	36,00	DL16	13,00	2,00	●
6072186	ULDV1600X4CQL	16,00	15,50	24,00	36,00	DL16	13,00	2,50	●
6072187	ULDV1600X4CQM	16,00	15,50	24,00	36,00	DL16	13,00	3,00	●
6408085	ULDV1600X4CQN	16,00	15,50	24,00	36,00	DL16	13,00	4,00	●
6072188	ULDV2000X4CQG	20,00	19,30	30,00	45,00	DL20	16,00	1,00	●
6072189	ULDV2000X4CQK	20,00	19,30	30,00	45,00	DL20	16,00	2,00	●
6072190	ULDV2000X4CQL	20,00	19,30	30,00	45,00	DL20	16,00	2,50	●
6072191	ULDV2000X4CQM	20,00	19,30	30,00	45,00	DL20	16,00	3,00	●
6072192	ULDV2000X4CQN	20,00	19,30	30,00	45,00	DL20	16,00	4,00	●
6408087	ULDV2000X4CQJ	20,00	19,30	30,00	45,00	DL20	16,00	5,00	●
6408088	ULDV2500X4CQG	25,00	24,00	37,50	56,50	DL25	21,00	1,00	●
6072193	ULDV2500X4CQL	25,00	24,00	37,50	56,50	DL25	21,00	2,50	●
6072194	ULDV2500X4CQN	25,00	24,00	37,50	56,50	DL25	21,00	4,00	●
6408089	ULDV2500X4CQJ	25,00	24,00	37,50	56,50	DL25	21,00	5,00	●
6408090	ULDV3200X4CQG	32,00	31,00	48,00	71,70	DL32	28,00	1,00	●
6072195	ULDV3200X4CQL	32,00	31,00	48,00	71,70	DL32	28,00	2,50	●
6072196	ULDV3200X4CQN	32,00	31,00	48,00	71,70	DL32	28,00	4,00	●
6408091	ULDV3200X4CQJ	32,00	31,00	48,00	71,70	DL32	28,00	5,00	●

162-163	164	159-161	168

DUO-LOCK™ • HARVI™ I • Ball Nose • 4 Flutes • Metric

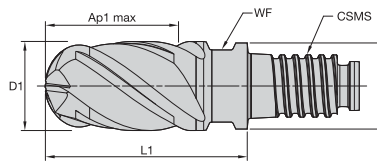

- first choice
- alternate choice

P	●
M	●
K	●
N	○
S	○
H	○

order number	catalogue number	D1	D	Ap1 max	L1	CSMS system size	WF	
6072411	UKBV1000X4CN	10,00	9,60	15,00	22,50	DL10	8,00	●
6072412	UKBV1200X4CN	12,00	11,50	18,00	27,00	DL12	9,50	●
6072413	UKBV1600X4CN	16,00	15,50	24,00	36,00	DL16	13,00	●
6072414	UKBV2000X4CN	20,00	19,30	30,00	45,00	DL20	16,00	●
6072415	UKBV2500X4CN	25,00	24,00	37,50	56,50	DL25	21,00	●

DUO-LOCK • HARVI II • Chamfered • 5 Flutes • Metric

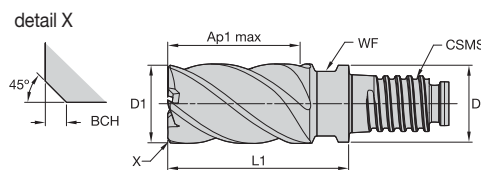

- first choice
- alternate choice

P	●
M	●
K	●
N	○
S	○
H	○

order number	catalogue number	D1	D	Ap1 max	L1	CSMS system size	WF	BCH
6072481	UCDV1000X5CV	10,00	9,60	15,00	22,50	DL10	8,00	0,50
6072482	UCDV1200X5CV	12,00	11,50	18,00	27,00	DL12	9,50	0,50
6072483	UCDV1600X5CV	16,00	15,50	24,00	36,00	DL16	13,00	0,50
6072484	UCDV2000X5CV	20,00	19,30	30,00	45,00	DL20	16,00	0,50
6072485	UCDV2500X5CV	25,00	24,00	37,50	56,50	DL25	21,00	0,50
6072486	UCDV3200X5CV	32,00	31,00	48,00	71,70	DL32	28,00	0,50

162-163	164	159-161	168

DUO-LOCK™ • HARVI™ II • Radiused • 5 Flutes • Metric

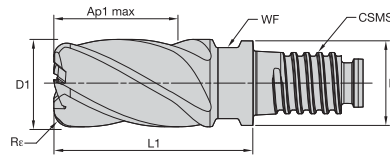

- first choice
- alternate choice

P	■	●
M	■	●
K	■	●
N	■	●
S	■	●
H	■	○
	■	○

order number	catalogue number	D1	D	Ap1 max	L1	CSMS system size	WF	Re	KC643M
6072487	UDDV1000X5CQE	10,00	9,60	15,00	22,50	DL10	8,00	0,50	●
6072488	UDDV1000X5CQJ	10,00	9,60	15,00	22,50	DL10	8,00	1,00	●
6072489	UDDV1000X5CQK	10,00	9,60	15,00	22,50	DL10	8,00	1,50	●
6072491	UDDV1200X5CQE	12,00	11,50	18,00	27,00	DL12	9,50	0,50	●
6072492	UDDV1200X5CQG	12,00	11,50	18,00	27,00	DL12	9,50	1,00	●
6072494	UDDV1200X5CQL	12,00	11,50	18,00	27,00	DL12	9,50	2,50	●
6072495	UDDV1600X5CQG	16,00	15,50	24,00	36,00	DL16	13,00	1,00	●
6072496	UDDV1600X5CQJ	16,00	15,50	24,00	36,00	DL16	13,00	1,50	●
6072497	UDDV1600X5CQK	16,00	15,50	24,00	36,00	DL16	13,00	2,00	●
6072498	UDDV1600X5CQL	16,00	15,50	24,00	36,00	DL16	13,00	2,50	●
6072499	UDDV1600X5CQM	16,00	15,50	24,00	36,00	DL16	13,00	3,00	●
6408050	UDDV1600X5CQN	16,00	15,50	24,00	36,00	DL16	13,00	4,00	●
6408071	UDDV1600X5CQP	16,00	15,50	24,00	36,00	DL16	13,00	6,00	●
6072500	UDDV2000X5CQG	20,00	19,30	30,00	45,00	DL20	16,00	1,00	●
6072501	UDDV2000X5CQK	20,00	19,30	30,00	45,00	DL20	16,00	2,00	●
6072502	UDDV2000X5CQL	20,00	19,30	30,00	45,00	DL20	16,00	2,50	●
6072503	UDDV2000X5CQM	20,00	19,30	30,00	45,00	DL20	16,00	3,00	●
6072504	UDDV2000X5CQN	20,00	19,30	30,00	45,00	DL20	16,00	4,00	●
6408072	UDDV2000X5CQQ	20,00	19,30	30,00	45,00	DL20	16,00	5,00	●
6408073	UDDV2500X5CQG	25,00	24,00	37,50	56,50	DL25	21,00	1,00	●
6072505	UDDV2500X5CQL	25,00	24,00	37,50	56,50	DL25	21,00	2,50	●
6072506	UDDV2500X5CQN	25,00	24,00	37,50	56,50	DL25	21,00	4,00	●
6408074	UDDV2500X5CQQ	25,00	24,00	37,50	56,50	DL25	21,00	5,00	●
6408075	UDDV3200X5CQG	32,00	31,00	48,00	71,70	DL32	28,00	1,00	●
6072507	UDDV3200X5CQL	32,00	31,00	48,00	71,70	DL32	28,00	2,50	●
6072508	UDDV3200X5CQN	32,00	31,00	48,00	71,70	DL32	28,00	4,00	●
6408076	UDDV3200X5CQQ	32,00	31,00	48,00	71,70	DL32	28,00	5,00	●

162-163	164	159-161	168

DUO-LOCK™ • HARVI™ III • Radiused • 6 Flutes • Metric

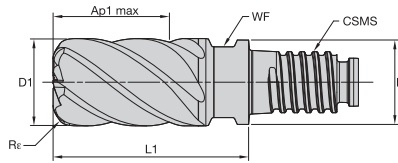

- first choice
- alternate choice

P	<input type="checkbox"/>
M	<input checked="" type="checkbox"/>
K	<input type="checkbox"/>
N	<input type="checkbox"/>
S	<input checked="" type="checkbox"/>
H	<input type="checkbox"/>
	<input type="checkbox"/>

order number	catalogue number	D1	D	Ap1 max	L1	CSMS system size	WF	Re	KCSM15
6072442	UJDV1000X6CQE	10,00	9,60	15,00	22,50	DL10	8,00	0,50	●
6072443	UJDV1000X6CQJ	10,00	9,60	15,00	22,50	DL10	8,00	1,00	●
6072444	UJDV1000X6CQK	10,00	9,60	15,00	22,50	DL10	8,00	1,50	●
6072445	UJDV1200X6CQE	12,00	11,50	18,00	27,00	DL12	9,50	0,50	●
6072447	UJDV1200X6CQJ	12,00	11,50	18,00	27,00	DL12	9,50	1,50	●
6072448	UJDV1200X6CQL	12,00	11,50	18,00	27,00	DL12	9,50	2,50	●
6072449	UJDV1600X6CQG	16,00	15,50	24,00	36,00	DL16	13,00	1,00	●
6072450	UJDV1600X6CQJ	16,00	15,50	24,00	36,00	DL16	13,00	1,50	●
6072561	UJDV1600X6CQK	16,00	15,50	24,00	36,00	DL16	13,00	2,00	●
6072562	UJDV1600X6CQL	16,00	15,50	24,00	36,00	DL16	13,00	2,50	●
6072563	UJDV1600X6CQM	16,00	15,50	24,00	36,00	DL16	13,00	3,00	●
6408077	UJDV1600X6CQN	16,00	15,50	24,00	36,00	DL16	13,00	4,00	●
6408078	UJDV1600X6CQP	16,00	15,50	24,00	36,00	DL16	13,00	6,00	●
6072564	UJDV2000X6CQG	20,00	19,30	30,00	45,00	DL20	16,00	1,00	●
6072565	UJDV2000X6CQK	20,00	19,30	30,00	45,00	DL20	16,00	2,00	●
6072567	UJDV2000X6CQM	20,00	19,30	30,00	45,00	DL20	16,00	3,00	●
6072568	UJDV2000X6CQN	20,00	19,30	30,00	45,00	DL20	16,00	4,00	●
6408079	UJDV2000X6CQQ	20,00	19,30	30,00	45,00	DL20	16,00	5,00	●
6408080	UJDV2500X6CQG	25,00	24,00	37,50	56,50	DL25	21,00	1,00	●
6072569	UJDV2500X6CQL	25,00	24,00	37,50	56,50	DL25	21,00	2,50	●
6072570	UJDV2500X6CQN	25,00	24,00	37,50	56,50	DL25	21,00	4,00	●
6408081	UJDV2500X6CQQ	25,00	24,00	37,50	56,50	DL25	21,00	5,00	●
6408083	UJDV3200X6CQG	32,00	31,00	48,00	71,70	DL32	28,00	1,00	●
6072572	UJDV3200X6CQN	32,00	31,00	48,00	71,70	DL32	28,00	4,00	●

DUO-LOCK • HARVI III • Ball Nose • 6 Flutes • Metric

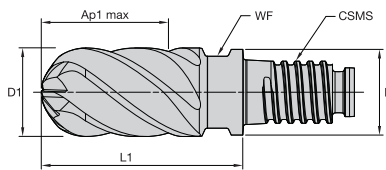

- first choice
- alternate choice

P	<input type="checkbox"/>
M	<input checked="" type="checkbox"/>
K	<input type="checkbox"/>
N	<input type="checkbox"/>
S	<input checked="" type="checkbox"/>
H	<input type="checkbox"/>
	<input type="checkbox"/>

order number	catalogue number	D1	D	Ap1 max	L1	CSMS system size	WF	KCSM15
6072386	UJBV1000X6CN	10,00	9,60	15,00	22,50	DL10	8,00	●
6072387	UJBV1200X6CN	12,00	11,50	18,00	27,00	DL12	9,50	●
6072388	UJBV1600X6CN	16,00	15,50	24,00	36,00	DL16	13,00	●
6072389	UJBV2000X6CN	20,00	19,30	30,00	45,00	DL20	16,00	●
6072390	UJBV2500X6CN	25,00	24,00	37,50	56,50	DL25	21,00	●

162-163	164	159-161	168

DUO-LOCK™ • HARVI™ I TE • Side Milling/Slotting • Application Data • Metric



Material Group					short		medium		long		Recommended feed per tooth (fz = mm/th) f or side milling (A). For slotting (B), reduce fz by 20%.										
	A		B		adapter reach						D1 – Diameter										
					KCPM15 Cutting Speed – vc m/min		KCPM15 Cutting Speed – vc m/min		KCPM15 Cutting Speed – vc m/min												
	ap	ae	ap		min	max	min	max	min	max	mm	10,0	12,0	16,0	18,0	20,0	25,0	32,0			
P	0	1,5 x D	0,5 x D	1 x D	150	–	200	135	–	180	135	–	180	fz	0,072	0,083	0,101	0,108	0,114	0,124	0,125
	1	1,5 x D	0,5 x D	1 x D	150	–	200	135	–	180	135	–	180	fz	0,072	0,083	0,101	0,108	0,114	0,124	0,125
	2	1,5 x D	0,5 x D	1 x D	140	–	190	126	–	171	126	–	171	fz	0,072	0,083	0,101	0,108	0,114	0,124	0,125
	3	1,5 x D	0,5 x D	1 x D	120	–	160	108	–	144	108	–	144	fz	0,061	0,070	0,087	0,095	0,101	0,114	0,123
	4	1,5 x D	0,5 x D	0,75 x D	90	–	150	81	–	135	81	–	135	fz	0,054	0,062	0,077	0,083	0,088	0,098	0,102
	5	1,5 x D	0,5 x D	1 x D	60	–	100	51	–	85	48	–	80	fz	0,048	0,056	0,070	0,076	0,081	0,091	0,099
M	1	1,5 x D	0,5 x D	1 x D	90	–	115	72	–	92	63	–	81	fz	0,061	0,070	0,087	0,095	0,101	0,114	0,123
	2	1,5 x D	0,5 x D	1 x D	60	–	80	48	–	64	42	–	56	fz	0,048	0,056	0,070	0,076	0,081	0,091	0,099
	3	1,5 x D	0,5 x D	1 x D	60	–	70	48	–	56	42	–	49	fz	0,040	0,047	0,057	0,061	0,065	0,071	0,073
K	1	1,5 x D	0,5 x D	1 x D	120	–	150	108	–	135	108	–	135	fz	0,072	0,083	0,101	0,108	0,114	0,124	0,125
	2	1,5 x D	0,5 x D	1 x D	110	–	140	99	–	126	99	–	126	fz	0,061	0,070	0,087	0,095	0,101	0,114	0,123
	3	1,5 x D	0,5 x D	1 x D	110	–	130	99	–	117	99	–	117	fz	0,048	0,056	0,070	0,076	0,081	0,091	0,099
S	1	1,5 x D	0,3 x D	0,3 x D	50	–	90	40	–	72	30	–	54	fz	0,061	0,070	0,087	0,095	0,101	0,114	0,123
	2	1,5 x D	0,3 x D	0,3 x D	50	–	80	40	–	64	30	–	48	fz	0,048	0,056	0,070	0,076	0,081	0,091	0,099
	3	1,5 x D	0,3 x D	0,3 x D	50	–	80	40	–	64	30	–	48	fz	0,032	0,037	0,046	0,050	0,054	0,061	0,067
	4	1,5 x D	0,5 x D	1 x D	50	–	60	40	–	48	30	–	36	fz	0,045	0,052	0,064	0,069	0,074	0,084	0,090
H	1	1,5 x D	0,5 x D	0,75 x D	80	–	140	64	–	112	48	–	84	fz	0,054	0,062	0,077	0,083	0,088	0,098	0,102
	2	1,5 x D	0,5 x D	0,5 x D	70	–	120	56	–	96	42	–	72	fz	0,040	0,047	0,057	0,061	0,065	0,071	0,073

NOTE: Lower value of cutting speed is used for high stock removal applications or for higher hardness (machinability) within group. Higher value of cutting speed is used for finishing applications or for lower hardness (machinability) within group. Above parameters are based on ideal conditions. For smaller taper machining centers, please adjust parameters accordingly on diameters greater than 12mm. For side milling with Ap larger than 1 x D, reduce Fz by 20%. Cylindrical shanks not recommended for full slotting.

DUO-LOCK • HARVI I TE • Ramping 0°-15° • Application Data • Metric





Material Group	Max Depth					Recommended feed per tooth (fz = mm/z) for Helical Interpolation and Ramping – z _{eff} = 2						
		KCPM15-KCSM15 Cutting Speed – vc m/min				Diameter – D1 [Ømin–Ømax] for helical interpolation						
		min	Start	max	mm	10,0	12,0	16,0	20,0	25,0	32,0	
P	0	1 x D	125	150	175	fz	0,055	0,065	0,075	0,087	0,095	0,105
	1	1 x D	125	150	175	fz	0,055	0,065	0,075	0,087	0,095	0,105
	2	1 x D	125	150	175	fz	0,055	0,065	0,075	0,087	0,095	0,105
	3	1 x D	110	130	150	fz	0,047	0,054	0,067	0,078	0,088	0,095
	4	1 x D	75	110	140	fz	0,041	0,048	0,059	0,068	0,075	0,080
	5	0,75 x D	50	70	90	fz	0,037	0,043	0,054	0,062	0,070	0,075
M	1	0,75 x D	40	55	70	fz	0,031	0,036	0,044	0,050	0,055	0,060
	2	0,75 x D	75	90	105	fz	0,047	0,054	0,067	0,078	0,088	0,095
	3	0,5 x D	40	50	65	fz	0,031	0,036	0,044	0,050	0,055	0,060
K	1	1 x D	110	125	140	fz	0,055	0,065	0,075	0,087	0,095	0,105
	2	1 x D	100	115	130	fz	0,047	0,054	0,067	0,078	0,088	0,095
	3	0,75 x D	90	105	120	fz	0,037	0,043	0,054	0,062	0,070	0,075
S	1	0,5 x D	40	60	80	fz	0,047	0,054	0,067	0,078	0,088	0,095
	2	0,5 x D	40	55	70	fz	0,037	0,043	0,054	0,062	0,070	0,075
	3	0,3 x D	20	25	35	fz	0,024	0,029	0,036	0,041	0,047	0,050
	4	0,75 x D	40	45	50	fz	0,034	0,040	0,050	0,057	0,064	0,070
H	1	0,75 x D	70	100	120	fz	0,041	0,048	0,059	0,068	0,075	0,080
	2	0,75 x D	60	90	110	fz	0,029	0,034	0,041	0,048	0,053	0,056

NOTE: Ø min and Ø max to be calculated with formula for helical ramping above.



DUO-LOCK™ • HARVI™ I TE • Plunging/Drilling • Application Data • Metric



Material Group	 			KCPM15-KCSM15			Recommended feed per revolution (fn =mm/rev) for plunging and drilling							
	Max Depth	Applicable	Coolant	Cutting Speed – vc m/min			D1 – Diameter							
				min	Start	max	mm	10,0	12,0	16,0	20,0	25,0	32,0	
P	0	1 x D	●	Preferred	110	130	150	fn	0,056	0,067	0,084	0,112	0,126	0,150
	1	1 x D	●	Required	110	130	150	fn	0,056	0,067	0,084	0,112	0,126	0,150
	2	1 x D	●	Required	110	130	150	fn	0,056	0,067	0,084	0,112	0,126	0,150
	3	1 x D	●	Required	100	105	120	fn	0,042	0,049	0,075	0,088	0,105	0,135
	4	1 x D	●	Required	70	85	100	fn	0,042	0,049	0,075	0,088	0,105	0,135
	5	0,75 x D	○	Required	45	50	65	fn	0,028	0,035	0,046	0,060	0,070	0,076
M	0	0,75 x D	○	Required	40	45	60	fn	0,028	0,035	0,046	0,060	0,070	0,076
	1	0,75 x D	●	Required	60	70	80	fn	0,042	0,049	0,075	0,088	0,105	0,135
	2	0,75 x D	○	Required	40	45	60	fn	0,028	0,035	0,046	0,060	0,070	0,076
K	0	0,5xD	○	Required	35	40	50	fn	0,028	0,035	0,046	0,060	0,070	0,076
	1	1 x D	●	Preferred	100	110	120	fn	0,056	0,067	0,084	0,112	0,126	0,150
	2	1 x D	●	Required	90	100	110	fn	0,042	0,049	0,075	0,088	0,105	0,135
S	3	0,75 x D	○	Required	75	85	100	fn	0,042	0,049	0,075	0,088	0,105	0,135
	1	0,5 x D	○	Required	35	40	55	fn	0,042	0,049	0,075	0,088	0,105	0,135
	2	0,5 x D	○	Required	30	35	45	fn	0,028	0,035	0,046	0,060	0,070	0,076
	3	0,3 x D	○	Required	15	20	28	fn	0,019	0,023	0,031	0,042	0,049	0,058
H	4	0,75 x D	○	Required	30	35	40	fn	0,031	0,035	0,045	0,058	0,070	0,076
	1	0,75 x D	○	Required	60	70	80	fn	0,042	0,049	0,075	0,088	0,105	0,135
	2	0,75 x D	○	Required	50	60	70	fn	0,029	0,034	0,053	0,062	0,074	0,095

NOTE: Other available diameters are not recommended for plunging applications.



DUO-LOCK • HARVI I • Application Data • Metric



UKDV



ULDV

Material Group	 		short	medium	long	Recommended feed per tooth (fz = mm/th) for side milling (A). For slotting (B), reduce fz by 20%.															
	UKDV	ULDV	A	B	adapter reach			D1 – Diameter													
					KCPM15	KCPM15	KCPM15														
					Cutting Speed – vc m/min		Cutting Speed – vc m/min		Cutting Speed – vc m/min												
				min	max	min	max	min	max	mm	10,0	12,0	16,0	20,0	25,0	32,0					
P	0	0	1,5 x D	0,5 x D	1 x D	150	–	200	135	–	180	135	–	180	fz	0,061	0,070	0,086	0,097	0,105	0,106
	1	1	1,5 x D	0,5 x D	1 x D	150	–	200	135	–	180	135	–	180	fz	0,061	0,070	0,086	0,097	0,105	0,106
	2	2	1,5 x D	0,5 x D	1 x D	140	–	190	126	–	171	126	–	171	fz	0,061	0,070	0,086	0,097	0,105	0,106
	3	3	1,5 x D	0,5 x D	1 x D	120	–	160	108	–	144	108	–	144	fz	0,051	0,060	0,074	0,086	0,097	0,105
	4	4	1,5 x D	0,4 x D	0,75 x D	90	–	150	81	–	135	81	–	135	fz	0,046	0,053	0,065	0,075	0,083	0,087
	5	5	1,5 x D	0,4 x D	1 x D	60	–	100	51	–	85	48	–	80	fz	0,041	0,048	0,059	0,069	0,077	0,084
M	6	6	1,5 x D	0,4 x D	0,75 x D	50	–	75	42,5	–	63,75	40	–	60	fz	0,034	0,040	0,048	0,055	0,060	0,062
	1	1	1,5 x D	0,4 x D	1 x D	90	–	115	72	–	92	63	–	80,5	fz	0,051	0,060	0,074	0,086	0,097	0,105
	2	2	1,5 x D	0,4 x D	1 x D	60	–	80	48	–	64	42	–	56	fz	0,041	0,048	0,059	0,069	0,077	0,084
K	3	3	1,5 x D	0,4 x D	1 x D	60	–	70	48	–	56	42	–	49	fz	0,034	0,040	0,048	0,055	0,060	0,062
	–	1	1,5 x D	0,5 x D	1 x D	120	–	150	108	–	135	108	–	135	fz	0,061	0,070	0,086	0,097	0,105	0,106
	–	2	1,5 x D	0,5 x D	1 x D	110	–	140	99	–	126	99	–	126	fz	0,051	0,060	0,074	0,086	0,097	0,105
S	–	3	1,5 x D	0,5 x D	1 x D	110	–	130	99	–	117	99	–	117	fz	0,041	0,048	0,059	0,069	0,077	0,084
	1	1	1,5 x D	0,3 x D	0,3 x D	50	–	90	40	–	72	30	–	54	fz	0,051	0,060	0,074	0,086	0,097	0,105
	2	2	1,5 x D	0,3 x D	0,3 x D	25	–	40	20	–	32	15	–	24	fz	0,027	0,032	0,039	0,046	0,052	0,057
	3	3	1,5 x D	0,3 x D	0,3 x D	25	–	40	20	–	32	15	–	24	fz	0,027	0,032	0,039	0,046	0,052	0,057
H	4	4	1,5 x D	0,4 x D	1 x D	50	–	60	40	–	48	30	–	36	fz	0,038	0,044	0,055	0,063	0,071	0,077
	–	1	1,5 x D	0,4 x D	0,75 x D	80	–	140	64	–	112	48	–	84	fz	0,046	0,053	0,065	0,075	0,083	0,087
	–	2	1,5 x D	0,2 x D	0,5 x D	70	–	120	56	–	96	42	–	72	fz	0,034	0,040	0,048	0,055	0,060	0,062

NOTE: Lower value of cutting speed is used for high stock removal applications or for higher hardness (machinability) within group.
Higher value of cutting speed is used for finishing applications or for lower hardness (machinability) within group.
Above parameters are based on ideal conditions. Please adjust parameters according to system stability.
For side milling with Ap larger than 1 x D, reduce Fz by 20%.
Cylindrical shanks not recommended for full slotting.



DUO-LOCK™ • HARVI™ I Ball Nose • Application Data • Metric



Material Group					short		medium		long		Recommended feed per tooth (fz = mm/th) for side milling (A). For slotting (B), reduce fz by 20%.								
	A		B		adapter reach						D1 – Diameter								
					KCPM15		KCPM15		KCPM15										
					Cutting Speed – vc m/min		Cutting Speed – vc m/min		Cutting Speed – vc m/min										
	ap	ae	ap		min	max	min	max	min	max	mm	10,0	12,0	16,0	20,0	25,0			
P	0	1,25 x D	0,5 x D	1 x D	150	–	200	135	–	180	135	–	180	fz	0,061	0,070	0,086	0,097	0,105
	1	1,25 x D	0,5 x D	1 x D	150	–	200	135	–	180	135	–	180	fz	0,061	0,070	0,086	0,097	0,105
	2	1,25 x D	0,5 x D	1 x D	140	–	190	126	–	171	126	–	171	fz	0,061	0,070	0,086	0,097	0,105
	3	1,25 x D	0,5 x D	1 x D	120	–	160	108	–	144	108	–	144	fz	0,051	0,060	0,074	0,086	0,097
	4	1,25 x D	0,4 x D	0,75 x D	90	–	150	81	–	135	81	–	135	fz	0,046	0,053	0,065	0,075	0,083
	5	1,25 x D	0,4 x D	1 x D	60	–	100	51	–	85	48	–	80	fz	0,041	0,048	0,059	0,069	0,077
M	1	1,25 x D	0,4 x D	0,75 x D	50	–	75	42,5	–	63,75	40	–	60	fz	0,034	0,040	0,048	0,055	0,060
	2	1,25 x D	0,4 x D	1 x D	90	–	115	72	–	92	63	–	80,5	fz	0,051	0,060	0,074	0,086	0,097
	3	1,25 x D	0,4 x D	1 x D	60	–	80	48	–	64	42	–	56	fz	0,041	0,048	0,059	0,069	0,077
K	1	1,25 x D	0,5 x D	1 x D	60	–	70	48	–	56	42	–	49	fz	0,034	0,040	0,048	0,055	0,060
	2	1,25 x D	0,5 x D	1 x D	120	–	150	108	–	135	108	–	135	fz	0,061	0,070	0,086	0,097	0,105
	3	1,25 x D	0,5 x D	1 x D	110	–	140	99	–	126	99	–	126	fz	0,051	0,060	0,074	0,086	0,097
S	1	1 x D	0,3 x D	0,3 x D	50	–	90	40	–	72	30	–	54	fz	0,051	0,060	0,074	0,086	0,097
	2	1 x D	0,3 x D	0,3 x D	25	–	40	20	–	32	15	–	24	fz	0,027	0,032	0,039	0,046	0,052
	3	1,25 x D	0,3 x D	0,3 x D	25	–	40	20	–	32	15	–	24	fz	0,027	0,032	0,039	0,046	0,052
	4	1,25 x D	0,4 x D	1 x D	50	–	60	40	–	48	30	–	36	fz	0,038	0,044	0,055	0,063	0,071
H	1	1,25 x D	0,4 x D	0,75 x D	80	–	140	64	–	112	48	–	84	fz	0,046	0,053	0,065	0,075	0,083
	2	1,25 x D	0,2 x D	0,5 x D	70	–	120	56	–	96	42	–	72	fz	0,034	0,040	0,048	0,055	0,060

NOTE: Lower value of cutting speed is used for high stock removal applications or for higher hardness (machinability) within group. Higher value of cutting speed is used for finishing applications or for lower hardness (machinability) within group. Above parameters are based on ideal conditions. Please adjust parameters according to system stability. For side milling with Ap larger than 1 x D, reduce Fz by 20%. Cylindrical shanks not recommended for full slotting.

DUO-LOCK • HARVI II • Application Data • Metric



UCDV



UDDV

Material Group					short		medium		long		Recommended feed per tooth (fz = mm/th) for side milling (A). For slotting (B), reduce fz by 20%.										
	A		B		adapter reach						D1 – Diameter										
					KCPM15		KCPM15		KCPM15												
					Cutting Speed – vc m/min		Cutting Speed – vc m/min		Cutting Speed – vc m/min												
	UCDV	UDDV	ap	ae	ap	min	max	min	max	min	max	mm	10,0	12,0	16,0	20,0	25,0	32,0			
P	0	–	1,5 x D	0,5 x D	1 x D	150	–	200	135	–	180	135	–	180	fz	0,061	0,070	0,086	0,097	0,105	0,106
	1	–	1,5 x D	0,5 x D	1 x D	150	–	200	135	–	180	135	–	180	fz	0,061	0,070	0,086	0,097	0,105	0,106
	2	–	1,5 x D	0,5 x D	1 x D	140	–	190	126	–	171	126	–	171	fz	0,061	0,070	0,086	0,097	0,105	0,106
	3	–	1,5 x D	0,5 x D	1 x D	120	–	160	108	–	144	108	–	144	fz	0,051	0,060	0,074	0,086	0,097	0,105
	4	–	1,5 x D	0,4 x D	0,75 x D	90	–	150	81	–	135	81	–	135	fz	0,046	0,053	0,065	0,075	0,083	0,087
	5	5	1,5 x D	0,4 x D	1 x D	60	–	100	51	–	85	48	–	80	fz	0,041	0,048	0,059	0,069	0,077	0,084
M	1	–	1,5 x D	0,4 x D	1 x D	50	–	75	42,5	–	63,75	40	–	60	fz	0,034	0,040	0,048	0,055	0,060	0,062
	2	–	1,5 x D	0,4 x D	1 x D	90	–	115	72	–	92	63	–	80,5	fz	0,051	0,060	0,074	0,086	0,097	0,105
	3	–	1,5 x D	0,4 x D	1 x D	60	–	80	48	–	64	42	–	56	fz	0,041	0,048	0,059	0,069	0,077	0,084
K	1	–	1,5 x D	0,5 x D	1 x D	60	–	70	48	–	56	42	–	49	fz	0,034	0,040	0,048	0,055	0,060	0,062
	2	–	1,5 x D	0,5 x D	1 x D	120	–	150	108	–	135	108	–	135	fz	0,061	0,070	0,086	0,097	0,105	0,106
	3	–	1,5 x D	0,5 x D	1 x D	110	–	130	99	–	117	99	–	117	fz	0,041	0,048	0,059	0,069	0,077	0,084
S	1	1	1,5 x D	0,3 x D	0,3 x D	50	–	90	40	–	72	30	–	54	fz	0,051	0,060	0,074	0,086	0,097	0,105
	2	2	1,5 x D	0,3 x D	0,3 x D	25	–	40	20	–	32	15	–	24	fz	0,027	0,032	0,039	0,046	0,052	0,057
	3	3	1,5 x D	0,3 x D	0,3 x D	25	–	40	20	–	32	15	–	24	fz	0,027	0,032	0,039	0,046	0,052	0,057
	4	4	1,5 x D	0,4 x D	1 x D	50	–	60	40	–	48	30	–	36	fz	0,038	0,044	0,055	0,063	0,071	0,077
H	1	1	1,5 x D	0,4 x D	0,75 x D	80	–	140	64	–	112	48	–	84	fz	0,046	0,053	0,065	0,075	0,083	0,087
	2	2	1,5 x D	0,2 x D	0,5 x D	70	–	120	56	–	96	42	–	72	fz	0,034	0,040	0,048	0,055	0,060	0,062

NOTE: Lower value of cutting speed is used for high stock removal applications or for higher hardness (machinability) within group. Higher value of cutting speed is used for finishing applications or for lower hardness (machinability) within group. Above parameters are based on ideal conditions. Please adjust parameters according to system stability. For side milling with Ap larger than 1 x D, reduce Fz by 20%. Cylindrical shanks not recommended for full slotting.



DUO-LOCK™ • HARVI™ III • Application Data • Metric



Roughing

Material Group			short		medium		long		Roughing – Recommended feed per tooth (fz = mm/th) for side milling (A).										
			adapter reach						D1 – Diameter										
	A		KCSM15		KCSM15		KCSM15												
	ap	ae	Cutting Speed – vc m/min		Cutting Speed – vc m/min		Cutting Speed – vc m/min		mm	10,0	12,0	16,0	20,0	25,0	32,0				
P	4	Ap max	0,4 x D	90	–	150	81	–	135	81	–	135	fz	0,046	0,053	0,065	0,075	0,083	0,087
	5	Ap max	0,4 x D	60	–	100	51	–	85	48	–	80	fz	0,041	0,048	0,059	0,069	0,077	0,084
M	1	Ap max	0,4 x D	90	–	115	72	–	92	63	–	80,5	fz	0,051	0,060	0,074	0,086	0,097	0,105
	2	Ap max	0,4 x D	60	–	80	48	–	64	42	–	56	fz	0,041	0,048	0,059	0,069	0,077	0,084
S	3	Ap max	0,4 x D	60	–	70	48	–	56	42	–	49	fz	0,034	0,040	0,048	0,055	0,060	0,062
	1	Ap max	0,4 x D	50	–	90	40	–	72	30	–	54	fz	0,051	0,060	0,074	0,086	0,097	0,105
	2	Ap max	0,4 x D	25	–	40	20	–	32	15	–	24	fz	0,027	0,032	0,039	0,046	0,052	0,057
	3	Ap max	0,4 x D	25	–	40	20	–	32	15	–	24	fz	0,027	0,032	0,039	0,046	0,052	0,057
H	4	Ap max	0,4 x D	50	–	60	40	–	48	30	–	36	fz	0,038	0,044	0,055	0,063	0,071	0,077
	1	Ap max	0,4 x D	80	–	140	64	–	112	48	–	84	fz	0,046	0,053	0,065	0,075	0,083	0,087
	2	Ap max	0,4 x D	70	–	120	56	–	96	42	–	72	fz	0,034	0,040	0,048	0,055	0,060	0,062

Finishing

Material Group			short		medium		long		Finishing – Recommended feed per tooth (fz = mm/th) for side milling (A).										
			adapter reach						D1 – Diameter										
	A		KCSM15		KCSM15		KCSM15												
	ap	ae	Cutting Speed – vc m/min		Cutting Speed – vc m/min		Cutting Speed – vc m/min		mm	10,0	12,0	16,0	20,0	25,0	32,0				
P	4	Ap max	0,06 x D	171	–	285	153,9	–	256,5	153,9	–	256,5	fz	0,046	0,053	0,065	0,075	0,083	0,087
	5	Ap max	0,06 x D	114	–	190	96,9	–	161,5	91,2	–	152	fz	0,041	0,048	0,059	0,069	0,077	0,084
M	1	Ap max	0,06 x D	171	–	218,5	136,8	–	174,8	119,2	–	152,95	fz	0,051	0,060	0,074	0,086	0,097	0,105
	2	Ap max	0,06 x D	114	–	152	91,2	–	121,6	79,8	–	106,4	fz	0,041	0,048	0,059	0,069	0,077	0,084
S	3	Ap max	0,06 x D	114	–	133	91,2	–	106,4	79,8	–	93,1	fz	0,034	0,040	0,048	0,055	0,060	0,062
	1	Ap max	0,06 x D	95	–	171	76	–	136,8	57	–	102,6	fz	0,051	0,060	0,074	0,086	0,097	0,105
	2	Ap max	0,06 x D	47,5	–	76	38	–	60,8	28,5	–	45,6	fz	0,027	0,032	0,039	0,046	0,052	0,057
	3	Ap max	0,06 x D	47,5	–	76	38	–	60,8	28,5	–	45,6	fz	0,027	0,032	0,039	0,046	0,052	0,057
H	4	Ap max	0,06 x D	95	–	114	76	–	91,2	57	–	68,4	fz	0,038	0,044	0,055	0,063	0,071	0,077
	1	Ap max	0,06 x D	152	–	266	121,8	–	212,8	91,2	–	159,6	fz	0,046	0,053	0,065	0,075	0,083	0,087
	2	Ap max	0,06 x D	133	–	228	106,4	–	182,4	79,8	–	136,8	fz	0,034	0,040	0,048	0,055	0,060	0,062

NOTE: Lower value of cutting speed is used for high stock removal applications or for higher hardness (machinability) within group.
 Higher value of cutting speed is used for finishing applications or for lower hardness (machinability) within group.
 Above parameters are based on ideal conditions. Please adjust parameters according to system stability.
 For side milling with Ap larger than 1 x D, reduce Fz by 20%.
 Cylindrical shanks not recommended for full slotting.

DUO-LOCK™ • HARVI™ III Ball Nose • Application Data • Metric



Roughing

Material Group			short			medium			long			Roughing – Recommended feed per tooth (fz = mm/th) for side milling (A).						
			adapter reach									D1 – Diameter						
	KCSM15			KCSM15			KCSM15											
	ap	ae	Cutting Speed – vc m/min			Cutting Speed – vc m/min			Cutting Speed – vc m/min			mm	10,0	12,0	16,0	20,0	25,0	
P	0	Ap max	0,4 x D	150	–	200	135	–	180	135	–	180	fz	0,052	0,060	0,073	0,082	0,089
	1	Ap max	0,4 x D	150	–	200	135	–	180	135	–	180	fz	0,052	0,060	0,073	0,082	0,089
	2	Ap max	0,4 x D	140	–	190	126	–	171	126	–	171	fz	0,052	0,060	0,073	0,082	0,089
	3	Ap max	0,4 x D	120	–	160	108	–	144	108	–	144	fz	0,044	0,051	0,063	0,073	0,082
	4	Ap max	0,4 x D	90	–	150	81	–	135	81	–	135	fz	0,039	0,045	0,055	0,064	0,070
	5	Ap max	0,4 x D	60	–	100	51	–	85	48	–	80	fz	0,035	0,041	0,050	0,058	0,066
M	6	Ap max	0,4 x D	50	–	75	42,5	–	63,75	40	–	60	fz	0,029	0,034	0,041	0,047	0,051
	1	Ap max	0,4 x D	90	–	115	72	–	92	63	–	80,5	fz	0,044	0,051	0,063	0,073	0,082
	2	Ap max	0,4 x D	60	–	80	48	–	64	42	–	56	fz	0,035	0,041	0,050	0,058	0,066
K	3	Ap max	0,4 x D	60	–	70	48	–	56	42	–	49	fz	0,029	0,034	0,041	0,047	0,051
	1	Ap max	0,4 x D	120	–	150	108	–	135	108	–	135	fz	0,052	0,060	0,073	0,082	0,089
	2	Ap max	0,4 x D	110	–	140	99	–	126	99	–	126	fz	0,044	0,051	0,063	0,073	0,082
S	3	Ap max	0,4 x D	110	–	130	99	–	117	99	–	117	fz	0,035	0,041	0,050	0,058	0,066
	1	Ap max	0,4 x D	50	–	90	40	–	72	30	–	54	fz	0,044	0,051	0,063	0,073	0,082
	2	Ap max	0,4 x D	25	–	40	20	–	32	15	–	24	fz	0,023	0,027	0,034	0,039	0,044
	3	Ap max	0,4 x D	25	–	40	20	–	32	15	–	24	fz	0,023	0,027	0,034	0,039	0,044
H	4	Ap max	0,4 x D	50	–	60	40	–	48	30	–	36	fz	0,032	0,037	0,046	0,054	0,060
	1	Ap max	0,4 x D	80	–	140	64	–	112	48	–	84	fz	0,039	0,045	0,055	0,064	0,070
	2	Ap max	0,4 x D	70	–	120	56	–	96	42	–	72	fz	0,029	0,034	0,041	0,047	0,051

Finishing

Material Group			short			medium			long			Finishing – Recommended feed per tooth (fz = mm/th) for side milling (A).						
			adapter reach									D1 – Diameter						
	KCSM15			KCSM15			KCSM15											
	ap	ae	Cutting Speed – vc m/min			Cutting Speed – vc m/min			Cutting Speed – vc m/min			mm	10,0	12,0	16,0	20,0	25,0	
P	0	Ap max	0,06 x D	285	–	380	257	–	342	257	–	342	fz	0,061	0,070	0,086	0,097	0,105
	1	Ap max	0,06 x D	285	–	380	257	–	342	257	–	342	fz	0,061	0,070	0,086	0,097	0,105
	2	Ap max	0,06 x D	266	–	361	239	–	325	239	–	325	fz	0,061	0,070	0,086	0,097	0,105
	3	Ap max	0,06 x D	228	–	304	205	–	274	205	–	274	fz	0,051	0,060	0,074	0,086	0,097
	4	Ap max	0,06 x D	171	–	285	154	–	257	154	–	257	fz	0,046	0,053	0,065	0,075	0,083
	5	Ap max	0,06 x D	114	–	190	97	–	162	91	–	152	fz	0,041	0,048	0,059	0,069	0,077
M	6	Ap max	0,06 x D	95	–	143	81	–	121	76	–	114	fz	0,034	0,040	0,048	0,055	0,060
	1	Ap max	0,06 x D	171	–	219	137	–	175	120	–	153	fz	0,051	0,060	0,074	0,086	0,097
	2	Ap max	0,06 x D	114	–	152	91	–	122	80	–	106	fz	0,041	0,048	0,059	0,069	0,077
K	3	Ap max	0,06 x D	114	–	133	91	–	106	80	–	93	fz	0,034	0,040	0,048	0,055	0,060
	1	Ap max	0,06 x D	228	–	285	205	–	257	205	–	257	fz	0,061	0,070	0,086	0,097	0,105
	2	Ap max	0,06 x D	209	–	266	188	–	239	188	–	239	fz	0,051	0,060	0,074	0,086	0,097
S	3	Ap max	0,06 x D	209	–	247	188	–	222	188	–	222	fz	0,041	0,048	0,059	0,069	0,077
	1	Ap max	0,06 x D	95	–	171	76	–	137	57	–	103	fz	0,051	0,060	0,074	0,086	0,097
	2	Ap max	0,06 x D	48	–	76	38	–	61	29	–	46	fz	0,027	0,032	0,039	0,046	0,052
	3	Ap max	0,06 x D	48	–	76	38	–	61	29	–	46	fz	0,027	0,032	0,039	0,046	0,052
H	4	Ap max	0,06 x D	95	–	114	76	–	91	57	–	68	fz	0,038	0,044	0,055	0,063	0,071
	1	Ap max	0,06 x D	152	–	266	122	–	213	91	–	160	fz	0,046	0,053	0,065	0,075	0,083
	2	Ap max	0,06 x D	133	–	228	106	–	182	80	–	137	fz	0,034	0,040	0,048	0,055	0,060

NOTE: Lower value of cutting speed is used for high stock removal applications or for higher hardness (machinability) within group.
 Higher value of cutting speed is used for finishing applications or for lower hardness (machinability) within group.
 Above parameters are based on ideal conditions. Please adjust parameters according to system stability.
 For side milling with Ap larger than 1 x D, reduce Fz by 20%.
 Cylindrical shanks not recommended for full slotting.

DUO-LOCK™ • KenCut™ RR • Chamfered • 4–5 Flutes • Metric

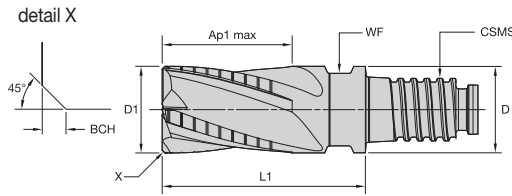

- first choice
- alternate choice

P	●
M	●
K	●
N	○
S	○
H	○

order number	catalogue number	D1	D	Ap1 max	L1	CSMS system size	WF	BCH	Z U	KCPM15
6127286	RQDB1000X4CV	10,00	9,60	15,00	22,50	DL10	8,00	0,50	4	●
6127287	RQDB1200X4CV	12,00	11,50	18,00	27,00	DL12	9,50	0,50	4	●
6127288	RQDB1600X4CV	16,00	15,50	24,00	36,00	DL16	13,00	0,50	4	●
6127289	RQDB2000X4CV	20,00	19,30	30,00	45,00	DL20	16,00	0,50	4	●
6127290	RQDB2500X5CV	25,00	24,00	37,50	56,50	DL25	21,00	0,50	5	●

DUO-LOCK • KenCut RR • Radiused • 4 & 6 Flutes • Metric

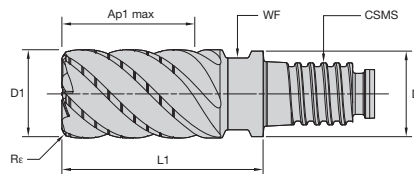

- first choice
- alternate choice

P	●
M	●
K	○
N	○
S	●
H	○

order number	catalogue number	D1	D	Ap1 max	L1	CSMS system size	WF	Re	Z U	KCSM15
6126912	RKDF1000X4CQE	10,00	9,60	15,00	22,50	DL10	8,00	0,50	4	●
6126913	RKDF1200X4CQF	12,00	11,50	18,00	27,00	DL12	9,50	0,75	4	●
6126914	RKDF1600X6CQF	16,00	15,50	24,00	36,00	DL16	13,00	0,75	6	●
6126915	RKDF2000X6CQF	20,00	19,30	30,00	45,00	DL20	16,00	0,75	6	●
6126916	RKDF2500X6CQF	25,00	24,00	37,50	56,50	DL25	21,00	0,75	6	●

162–163	164	159–161	168

DUO-LOCK™ • KenCut™ RR • RQDB • Application Data • Metric



Material Group					short		medium		long		Recommended feed per tooth (fz = mm/th) for side milling (A). For slotting (B), reduce fz by 20%.								
	A		B		adapter reach						D1 – Diameter								
					KCPM15		KCPM15		KCPM15										
	ap		ae		Cutting Speed – vc		Cutting Speed – vc		Cutting Speed – vc		Cutting Speed – vc								
ap		ae		ap		min	max	min	max	min	max	mm	10,0	12,0	16,0	20,0	25,0		
P	0	1,5 x D	0,5 x D	1 x D	120	–	160	108	–	144	108	–	144	fz	0,061	0,070	0,086	0,097	0,105
	1	1,5 x D	0,5 x D	1 x D	120	–	160	108	–	144	108	–	144	fz	0,061	0,070	0,086	0,097	0,105
	2	1,5 x D	0,5 x D	1 x D	112	–	152	100,8	–	136,8	100,8	–	136,8	fz	0,061	0,070	0,086	0,097	0,105
	3	1,5 x D	0,4 x D	0,75 x D	96	–	128	86,4	–	115,2	86,4	–	115,2	fz	0,051	0,060	0,074	0,086	0,097
	4	1,5 x D	0,3 x D	0,3 x D	72	–	120	64,8	–	108	64,8	–	108	fz	0,046	0,053	0,065	0,075	0,083
M	5	1,5 x D	0,4 x D	0,75 x D	48	–	80	40,8	–	68	38,4	–	64	fz	0,041	0,048	0,059	0,069	0,077
	1	1,5 x D	0,4 x D	0,75 x D	72	–	92	57,6	–	73,6	50,4	–	64,4	fz	0,051	0,060	0,074	0,086	0,097
	2	1,5 x D	0,4 x D	0,75 x D	48	–	64	38,4	–	51,2	33,6	–	44,8	fz	0,041	0,048	0,059	0,069	0,077
K	3	1,5 x D	0,4 x D	0,75 x D	48	–	56	38,4	–	44,8	33,6	–	39,2	fz	0,034	0,040	0,048	0,055	0,060
	1	1,5 x D	0,5 x D	1 x D	96	–	120	86,4	–	108	86,4	–	108	fz	0,061	0,070	0,086	0,097	0,105
	2	1,5 x D	0,4 x D	1 x D	88	–	112	79,2	–	100,8	79,2	–	100,8	fz	0,051	0,060	0,074	0,086	0,097
S	3	1,5 x D	0,4 x D	1 x D	88	–	104	79,2	–	93,6	79,2	–	93,6	fz	0,041	0,048	0,059	0,069	0,077
	1	1,5 x D	0,4 x D	0,75 x D	40	–	72	32	–	57,6	24	–	43,2	fz	0,051	0,060	0,074	0,086	0,097
	3	1,5 x D	0,4 x D	0,75 x D	20	–	32	16	–	25,6	12	–	19,2	fz	0,027	0,032	0,039	0,046	0,052
H	1	1,5 x D	0,3 x D	0,3 x D	64	–	112	51,2	–	89,6	38,4	–	67,2	fz	0,046	0,053	0,065	0,075	0,083

NOTE: Lower value of cutting speed is used for high stock removal applications or for higher hardness (machinability) within group.
 Higher value of cutting speed is used for finishing applications or for lower hardness (machinability) within group.
 Above parameters are based on ideal conditions. Please adjust parameters according to system stability.
 For side milling with Ap larger than 1 x D, reduce Fz by 20%.
 Cylindrical shanks not recommended for full slotting.

DUO-LOCK • KenCut RR • RKDF • Application Data • Metric



Material Group					short		medium		long		Recommended feed per tooth (fz = mm/th) for side milling (A). For slotting (B), reduce fz by 20%.								
	A		B		adapter reach						D1 – Diameter								
					KCSM15		KCSM15		KCSM15										
	ap		ae		Cutting Speed – vc		Cutting Speed – vc		Cutting Speed – vc		Cutting Speed – vc								
ap		ae		ap		min	max	min	max	min	max	mm	10,0	12,0	16,0	20,0	25,0		
P	3	1,0 x D	0,5 x D	0,75 x D	120	–	160	108	–	144	108	–	144	fz	0,051	0,060	0,074	0,086	0,097
	4	1,0 x D	0,3 x D	0,75 x D	90	–	150	81	–	135	81	–	135	fz	0,046	0,053	0,065	0,075	0,083
	5	1,0 x D	0,4 x D	0,75 x D	60	–	100	51	–	85	48	–	80	fz	0,041	0,048	0,059	0,069	0,077
	6	1,0 x D	0,3 x D	0,3 x D	50	–	75	42,5	–	63,75	40	–	60	fz	0,034	0,040	0,048	0,055	0,060
M	1	1,0 x D	0,4 x D	0,75 x D	90	–	115	72	–	92	63	–	80,5	fz	0,051	0,060	0,074	0,086	0,097
	2	1,0 x D	0,4 x D	0,75 x D	60	–	80	48	–	64	42	–	56	fz	0,041	0,048	0,059	0,069	0,077
	3	1,0 x D	0,4 x D	0,75 x D	60	–	70	48	–	56	42	–	49	fz	0,034	0,040	0,048	0,055	0,060
K	1	1,0 x D	0,5 x D	1 x D	120	–	150	108	–	135	108	–	135	fz	0,061	0,070	0,086	0,097	0,105
	2	1,0 x D	0,5 x D	1 x D	110	–	140	99	–	126	99	–	126	fz	0,051	0,060	0,074	0,086	0,097
	3	1,0 x D	0,5 x D	1 x D	110	–	130	99	–	117	99	–	117	fz	0,041	0,048	0,059	0,069	0,077
S	1	1,0 x D	0,3 x D	0,75 x D	50	–	90	40	–	72	30	–	54	fz	0,051	0,060	0,074	0,086	0,097
	2	1,0 x D	0,3 x D	0,75 x D	25	–	40	20	–	32	15	–	24	fz	0,027	0,032	0,039	0,046	0,052
	3	1,0 x D	0,3 x D	0,75 x D	25	–	40	20	–	32	15	–	24	fz	0,027	0,032	0,039	0,046	0,052
	4	1,0 x D	0,4 x D	0,75 x D	50	–	60	40	–	48	30	–	36	fz	0,038	0,044	0,055	0,063	0,071
H	1	1,0 x D	0,3 x D	0,3 x D	80	–	140	64	–	112	48	–	84	fz	0,046	0,053	0,065	0,075	0,083
	2	1,0 x D	0,2 x D	0,2 x D	70	–	120	56	–	96	42	–	72	fz	0,034	0,040	0,048	0,055	0,060
	3	1,0 x D	0,2 x D	0,2 x D	60	–	90	48	–	72	36	–	54	fz	0,027	0,032	0,039	0,046	0,052

NOTE: Lower value of cutting speed is used for high stock removal applications or for higher hardness (machinability) within group.
 Higher value of cutting speed is used for finishing applications or for lower hardness (machinability) within group.
 Above parameters are based on ideal conditions. Please adjust parameters according to system stability.
 For side milling with Ap bigger than 1 x D, reduce Fz by 20%.
 Cylindrical shanks not recommended for full slotting.



DUO-LOCK™ • KenCut™ FF • Radiused • 6 Flutes • Metric

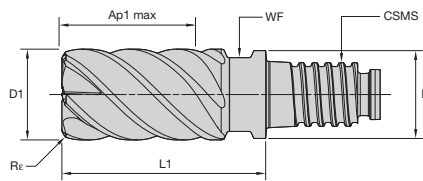

- first choice
- alternate choice

P	●
M	●
K	●
N	●
S	○
H	○

order number	catalogue number	D1	D	Ap1 max	L1	CSMS system size	WF	Re	
6127198	FMDF1000X6CQE	10,00	9,60	15,00	22,50	DL10	8,00	0,50	●
6127199	FMDF1200X6CQF	12,00	11,50	18,00	27,00	DL12	9,50	0,75	●
6127200	FMDF1600X6CQF	16,00	15,50	24,00	36,00	DL16	13,00	0,75	●
6127311	FMDF2000X6CQF	20,00	19,30	30,00	45,00	DL20	16,00	0,75	●
6127312	FMDF2500X6CQF	25,00	24,00	37,50	56,50	DL25	21,00	0,75	●

● KCPM15

DUO-LOCK • RSM II™ • Finisher • Radiused • Multi-Flute • Metric

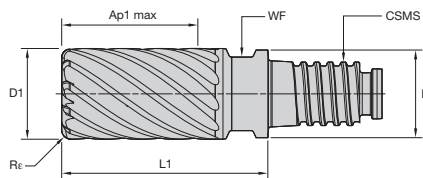

- first choice
- alternate choice

P	○
M	●
K	●
N	●
S	●
H	○

order number	catalogue number	D1	D	Ap1 max	L1	CSMS system size	WF	Re	Z U
6127040	FSDE1000X9CQE	10,00	9,60	15,00	22,50	DL10	8,00	0,50	9
6127072	FSDE1000X9CQJ	10,00	9,60	15,00	22,50	DL10	8,00	1,50	9
6127073	FSDE1200X9CQE	12,00	11,50	18,00	27,00	DL12	9,50	0,50	9
6127074	FSDE1200X9CQG	12,00	11,50	18,00	27,00	DL12	9,50	1,00	9
6127077	FSDE1600XBCQG	16,00	15,50	24,00	36,00	DL16	13,00	1,00	11
6127079	FSDE1600XBCQK	16,00	15,50	24,00	36,00	DL16	13,00	2,00	11
6408046	FSDE1600XBCQN	16,00	15,50	24,00	36,00	DL16	13,00	4,00	11
6127082	FSDE2000XFCQG	20,00	19,30	30,00	45,00	DL20	16,00	1,00	15
6127087	FSDE2500XJCQL	25,00	24,00	37,50	56,50	DL25	21,00	2,50	19
6127088	FSDE2500XJCQN	25,00	24,00	37,50	56,50	DL25	21,00	4,00	19
6408049	FSDE2500XJCQQ	25,00	24,00	37,50	56,50	DL25	21,00	5,00	19

● KC643M

162-163	164	159-161	168

DUO-LOCK™ • KenCut™ FF • FMDf • Application Data • Metric



Material Group			short			medium			long			Recommended feed per tooth (fz = mm/th) for side milling (A).						
			adapter reach									D1 – Diameter						
	A		KCPM15			KCPM15			KCPM15									
	ap	ae	Cutting Speed – vc m/min			Cutting Speed – vc m/min			Cutting Speed – vc m/min			mm	10,0	12,0	16,0	20,0	25,0	
P	0	1,5 x D	0,1 x D	150	–	200	135	–	180	135	–	180	fz	0,072	0,083	0,101	0,114	0,124
	1	1,5 x D	0,1 x D	150	–	200	135	–	180	135	–	180	fz	0,072	0,083	0,101	0,114	0,124
	2	1,5 x D	0,1 x D	140	–	190	126	–	171	126	–	171	fz	0,072	0,083	0,101	0,114	0,124
	3	1,5 x D	0,1 x D	120	–	160	108	–	144	108	–	144	fz	0,061	0,070	0,087	0,101	0,114
	4	1,5 x D	0,1 x D	90	–	150	81	–	135	81	–	135	fz	0,054	0,062	0,077	0,088	0,098
	5	1,5 x D	0,1 x D	60	–	100	51	–	85	48	–	80	fz	0,048	0,056	0,070	0,081	0,091
M	6	1,5 x D	0,1 x D	50	–	75	42,5	–	63,75	40	–	60	fz	0,040	0,047	0,057	0,065	0,071
	1	1,5 x D	0,1 x D	90	–	115	72	–	92	63	–	80,5	fz	0,061	0,070	0,087	0,101	0,114
	2	1,5 x D	0,1 x D	60	–	80	48	–	64	42	–	56	fz	0,048	0,056	0,070	0,081	0,091
K	3	1,5 x D	0,1 x D	60	–	70	48	–	56	42	–	49	fz	0,040	0,047	0,057	0,065	0,071
	1	1,5 x D	0,1 x D	120	–	150	108	–	135	108	–	135	fz	0,072	0,083	0,101	0,114	0,124
S	2	1,5 x D	0,1 x D	110	–	140	99	–	126	99	–	126	fz	0,061	0,070	0,087	0,101	0,114
	3	1,5 x D	0,1 x D	110	–	130	99	–	117	99	–	117	fz	0,048	0,056	0,070	0,081	0,091
	1	1,5 x D	0,1 x D	50	–	90	40	–	72	30	–	54	fz	0,061	0,070	0,087	0,101	0,114
	2	1,5 x D	0,1 x D	25	–	40	20	–	32	15	–	24	fz	0,032	0,037	0,046	0,054	0,061
H	3	1,5 x D	0,1 x D	25	–	40	20	–	32	15	–	24	fz	0,032	0,037	0,046	0,054	0,061
	4	1,5 x D	0,15 x D	50	–	60	40	–	48	30	–	36	fz	0,045	0,052	0,064	0,074	0,084
H	1	1,5 x D	0,1 x D	80	–	140	64	–	112	48	–	84	fz	0,054	0,062	0,077	0,088	0,098
	2	1,5 x D	0,1 x D	70	–	120	56	–	96	42	–	72	fz	0,040	0,047	0,057	0,065	0,071

NOTE: Lower value of cutting speed is used for high stock removal applications or for higher hardness (machinability) within group.
 Higher value of cutting speed is used for finishing applications or for lower hardness (machinability) within group.
 Above parameters are based on ideal conditions. Please adjust parameters according to system stability.
 For side milling with Ap larger than 1 x D, reduce Fz by 20%.
 Cylindrical shanks not recommended for full slotting.

DUO-LOCK • RSM II™ • FSDE • Application Data • Metric



Material Group			short			medium			long			Recommended feed per tooth (fz = mm/th) for side milling (A).						
			adapter reach									D1 – Diameter						
	A		KC643M			KC643M			KC643M									
	ap	ae	Cutting Speed – vc m/min			Cutting Speed – vc m/min			Cutting Speed – vc m/min			mm	10,0	12,0	16,0	20,0	25,0	
P	4	1,5 x D	0,2–0,3mm	135	–	495	122	–	446	122	–	446	fz	0,120	0,129	0,149	0,163	0,166
	5	1,5 x D	0,2–0,3mm	90	–	330	77	–	281	72	–	264	fz	0,108	0,116	0,135	0,150	0,155
M	1	1,5 x D	0,2–0,3mm	135	–	379,5	108	–	304	95	–	266	fz	0,135	0,145	0,169	0,187	0,193
	2	1,5 x D	0,2–0,3mm	90	–	264	72	–	211	63	–	185	fz	0,108	0,116	0,135	0,150	0,155
S	3	1,5 x D	0,2–0,3mm	90	–	231	72	–	185	63	–	162	fz	0,090	0,096	0,110	0,120	0,121
	1	1,5 x D	0,2–0,3mm	75	–	297	60	–	238	45	–	178	fz	0,135	0,145	0,169	0,187	0,193
	2	1,5 x D	0,2–0,3mm	37,5	–	132	30	–	106	23	–	79	fz	0,071	0,077	0,090	0,100	0,104
	3	1,5 x D	0,2–0,3mm	37,5	–	132	30	–	106	23	–	79	fz	0,071	0,077	0,090	0,100	0,104
H	4	1,5 x D	0,2–0,3mm	75	–	198	60	–	158	45	–	119	fz	0,099	0,107	0,124	0,138	0,142
	1	1,5 x D	0,2–0,3mm	120	–	462	96	–	370	72	–	277	fz	0,120	0,129	0,149	0,163	0,166
H	2	1,5 x D	0,2–0,3mm	105	–	396	84	–	317	63	–	238	fz	0,090	0,096	0,110	0,120	0,121

NOTE: For better surface finish, reduce feed per tooth.
 For side milling with Ap larger than 1 x D, reduce Fz by 20%.
 Cylindrical shanks not recommended for full slotting.

DUO-LOCK™ • MaxiMet™ • Square End • 2 Flutes • Metric

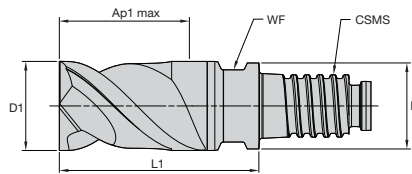

- first choice
- alternate choice

P	■
M	■
K	■
N	●
S	■
H	■

order number	catalogue number	D1	D	Ap1 max	L1	CSMS system size	WF	KG00
6151062	ABDF1000X2CU	10,00	9,60	15,00	22,50	DL10	8,00	●
6151063	ABDF1200X2CU	12,00	11,50	18,00	27,00	DL12	9,50	●
6151064	ABDF1600X2CU	16,00	15,50	24,00	36,00	DL16	13,00	●
6151066	ABDF2000X2CU	20,00	19,30	30,00	45,00	DL20	16,00	●

DUO-LOCK • MaxiMet • Radiused • 3 Flutes • Metric

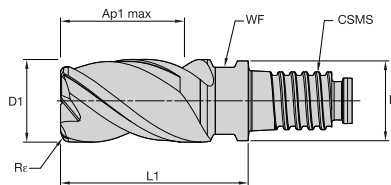

- first choice
- alternate choice

P	■
M	■
K	■
N	●
S	■
H	■

order number	catalogue number	D1	D	Ap1 max	L1	CSMS system size	WF	Re	KG00
6151025	ABDE1000X3CQE	10,00	9,60	15,00	22,50	DL10	8,00	0,50	●
6151026	ABDE1000X3CQG	10,00	9,60	15,00	22,50	DL10	8,00	1,00	●
6151027	ABDE1000X3CQJ	10,00	9,60	15,00	22,50	DL10	8,00	1,50	●
6151028	ABDE1200X3CQE	12,00	11,50	17,50	27,00	DL12	9,50	0,50	●
6151029	ABDE1200X3CQG	12,00	11,50	18,00	27,00	DL12	9,50	1,00	●
6151030	ABDE1200X3CQJ	12,00	11,50	18,00	27,00	DL12	9,50	1,50	●
6151031	ABDE1200X3CQL	12,00	11,50	18,00	27,00	DL12	9,50	2,50	●
6151034	ABDE1600X3CQK	15,97	15,50	24,00	36,00	DL16	13,00	2,00	●
6151035	ABDE1600X3CQL	15,97	15,50	24,00	36,00	DL16	13,00	2,50	●
6151036	ABDE1600X3CQM	15,97	15,50	24,00	36,00	DL16	13,00	3,00	●
6151032	ABDE1600X3CQG	16,00	15,50	24,00	36,00	DL16	13,00	1,00	●
6151033	ABDE1600X3CQJ	16,00	15,50	24,00	36,00	DL16	13,00	1,50	●
6408042	ABDE1600X3CQN	16,00	15,50	24,00	36,00	DL16	13,00	4,00	●
6151037	ABDE2000X3CQG	20,00	19,30	30,00	45,00	DL20	16,00	1,00	●
6151038	ABDE2000X3CQK	20,00	19,30	30,00	45,00	DL20	16,00	2,00	●
6151039	ABDE2000X3CQL	20,00	19,30	30,00	45,00	DL20	16,00	2,50	●
6151040	ABDE2000X3CQM	20,00	19,30	30,00	45,00	DL20	16,00	3,00	●
6408044	ABDE2000X3CQQ	20,00	19,30	30,00	45,00	DL20	16,00	5,00	●
6151043	ABDE2500X3CQL	25,00	24,00	37,50	56,50	DL25	21,00	2,50	●
6151044	ABDE2500X3CQN	25,00	24,00	37,50	56,50	DL25	21,00	4,00	●

162-163	164	159-161	168



DUO-LOCK™ • MaxiMet™ • Ball Nose • 3 Flutes • Metric

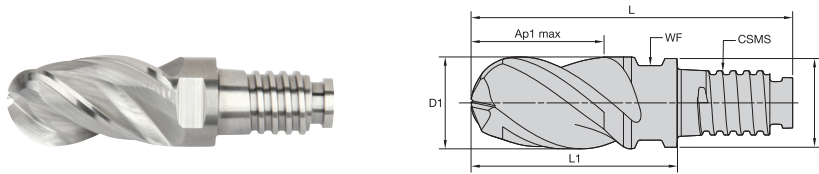

- first choice
- alternate choice

P	■
M	■
K	■
N	●
S	■
H	■

order number	catalogue number	D1	D	Ap1 max	L	L1	CSMS	WF	K600
6626771	ABBE1000X3CN	10,00	9,60	15,00	35,00	22,50	DL10	8,00	●
6626772	ABBE1200X3CN	12,00	11,50	18,00	42,00	27,00	DL12	9,50	●
6626773	ABBE1600X3CN	16,00	15,50	24,00	56,00	36,00	DL16	13,00	●
6626774	ABBE2000X3CN	20,00	19,30	30,00	68,90	45,00	DL20	16,00	●

DUO-LOCK • MaxiMet • ABDF & ABDE • Application Data • Metric



Material Group	A		B		short		medium		long		Recommended feed per tooth (fz = mm/th) for side milling (A). For slotting (B), reduce fz by 20%.							
	ap		ae		min		max		min		max		D1 – Diameter					
	1,5 x D		0,3 x D		1,0 x D		1,0 x D		1,0 x D		1,0 x D		mm					
	5		4		3		2		1		0		10,0 12,0 16,0 20,0					
N	1	1,5 x D	0,3 x D	1,0 x D	500	–	2000	400	–	1200	300	–	1200	fz	0,077	0,092	0,122	0,153
	2	1,5 x D	0,3 x D	1,0 x D	500	–	1500	400	–	900	300	–	900	fz	0,069	0,083	0,110	0,138
	3	1,5 x D	0,3 x D	1,0 x D	500	–	1500	400	–	900	300	–	900	fz	0,054	0,064	0,086	0,107
	4	1,5 x D	0,3 x D	1,0 x D	400	–	750	320	–	450	240	–	450	fz	0,054	0,064	0,086	0,107
	5	1,5 x D	0,3 x D	1,0 x D	250	–	1000	200	–	600	150	–	600	fz	0,069	0,083	0,110	0,138

NOTE: Ap for spindle with ceramic bearings multiply by 0,5.
 For better surface finish, reduce feed per tooth.
 Above parameters are based on ideal conditions. Please adjust parameters according to system stability.
 For side milling with Ap bigger than 1 x D, reduce Fz by 20%.
 Cylindrical shanks not recommended for full slotting.

162–163	164	159–161	168

DUO-LOCK™ • MaxiMet™ • ABBE • Application Data • Metric



Material Group					short			medium			long			Recommended feed per tooth (fz = mm/th) for side milling (A). For slotting (B), reduce fz by 20%.				
	A		B		adapter reach									D1 – Diameter				
					K600			K600			K600							
	ap		ae		ap		Cutting Speed – vc m/min			Cutting Speed – vc m/min			Cutting Speed – vc m/min					
	min	max	min	max	min	max	min	max	min	max	min	max	mm	10,0	12,0	16,0	20,0	
N	1	1,0 x D	0,5 x D	1,0 x D	500	–	2000	400	–	1600	300	–	1200	fz	0,075	0,090	0,120	0,150
	2	1,0 x D	0,5 x D	1,0 x D	500	–	1500	400	–	1200	300	–	900	fz	0,068	0,081	0,108	0,135
	3	1,0 x D	0,5 x D	1,0 x D	500	–	1500	400	–	1200	300	–	900	fz	0,053	0,063	0,084	0,105
	4	1,0 x D	0,5 x D	1,0 x D	400	–	750	320	–	600	240	–	450	fz	0,053	0,063	0,084	0,105
	5	1,0 x D	0,5 x D	1,0 x D	250	–	1000	200	–	800	150	–	600	fz	0,068	0,081	0,108	0,135
	6	1,0 x D	0,5 x D	1,0 x D	100	–	750	80	–	600	60	–	450	fz	0,075	0,090	0,120	0,150
	7	1,0 x D	0,5 x D	1,0 x D	100	–	750	80	–	600	60	–	450	fz	0,053	0,063	0,084	0,105

NOTE: These guidelines may require variations to achieve optimum results.
 Lower value of cutting speed is used for high stock removal applications or for higher hardness (machinability) within group.
 Higher value of cutting speed is used for finishing applications or for lower hardness (machinability) within group.
 Above parameters are based on ideal conditions. For smaller taper machining centers, please adjust parameters accordingly on diameters greater than 12mm.
 For better surface finish, reduce feed per tooth.

DUO-LOCK™ • KenFeed™ • KMDA • Radiused • 6 Flutes • Metric

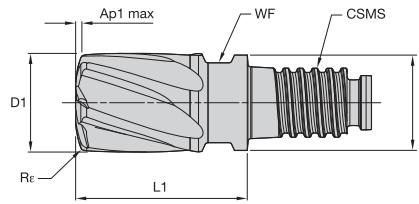

- first choice
- alternate choice

P	●
M	●
K	●
N	●
S	●
H	●

KC639M

order number	catalogue number	D1	D	Ap1 max	L1	CSMS	WF	Re	
6197625	KMDA1000X6BQX	10,00	9,60	0,53	17,50	DL10	8,00	0,63	●
6197626	KMDA1200X6BQF	12,00	11,50	0,63	21,00	DL12	9,50	0,75	●
6197627	KMDA1600X6BQG	16,00	15,50	0,84	28,00	DL16	13,00	1,00	●
6197628	KMDA2000X6BQH	20,00	19,30	1,05	35,00	DL20	16,00	1,25	●

DUO-LOCK • KenFeed • 6 Flutes • Programming Data

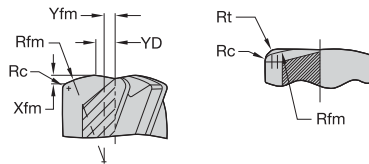

geometrical parameters							ramping guide for circular and linear ramping						
							circular interpolation		linear ramping				
							optimal range of circle diameter for a single pass		calculated length per ramp angle				
catalogue number	D1	Ap1 max	R	Re	YRC	RCN	smallest	largest	1°	2°	3°	4°	5°
KMDA1000X6BQX	10	0,53	10	0,625	1,25	2,20	14,40	20,00	30,20	15,09	10,06	7,54	6,02
KMDA1200X6BQF	12	0,63	12	0,750	1,50	2,64	17,28	24,00	36,24	18,11	12,07	9,05	7,23
KMDA1600X6BQG	16	0,84	16	1,000	2,00	3,52	23,04	32,00	48,31	24,15	16,09	12,06	9,64
KMDA2000X6BQH	20	1,05	20	1,250	2,50	4,40	28,80	40,00	60,39	30,19	20,11	15,08	12,05
recommended degree of programmed feed rate to use while ramping									100%	70%	50%	30%	10%

NOTE: YRC = distance from centerline to the crown of the R radius.
 RCN = distance from centerline to the start of the cutting edge. This dimension can also help determine the minimum circle size when helical ramping.
 R = the head radius size.
 Rc = the shoulder radius or radius at the corner of the cutter.

162-163	164	159-161	168

DUO-LOCK™ • KenFeed™ • KSDB • Radiused • 6 Flutes • Metric

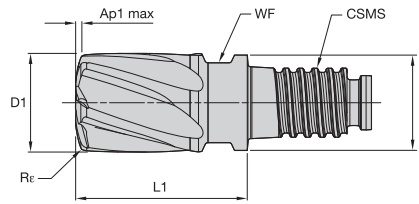

- first choice
- alternate choice

P	●
M	○
K	●
N	○
S	●
H	○

order number	catalogue number	D1	D	Ap1 max	L1	CSMS	WF	Rc	KC643M
6625741	KSDB1000X6BQX	10,00	9,60	0,53	17,50	DL10	8,00	0,63	●
6625742	KSDB1200X6BQX	12,00	11,50	0,63	21,00	DL12	9,50	0,75	●
6625743	KSDB1600X6BQX	16,00	15,50	0,84	28,00	DL16	13,00	1,00	●
6625744	KSDB2000X6BQX	20,00	19,30	1,05	35,00	DL20	16,00	1,25	●

DUO-LOCK • KenFeed • 6 Flutes • Programming Data

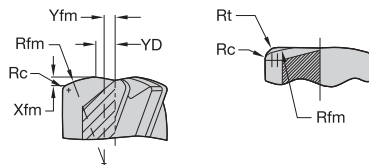

geometrical parameters										ramping guide for circular and linear interpolation						
										circular interpolation		linear interpolation				
										allowed range of hole diameter		calculated length per ramp angle				
catalogue number	D1	Ap1 max	Rfm	Rt	Rc	Xfm	Yfm	YD	Number of flutes	smallest	largest	1°	2°	3°	4°	5°
KSDB1000X6BQX	10,00	0,53	10,00	1,04	0,625	0,53	1,25	2,20	6	14,40	20,00	30,20	15,09	10,06	7,54	6,02
KSDB1200X6BQX	12,00	0,63	12,00	1,24	0,750	0,63	1,50	2,64	6	17,28	24,00	36,24	18,11	12,07	9,05	7,23
KSDB1600X6BQX	16,00	0,84	16,00	1,66	1,000	0,84	2,00	3,52	6	23,04	32,00	48,31	24,15	16,09	12,06	9,64
KSDB2000X6BQX	20,00	1,05	20,00	2,07	1,250	1,05	2,50	4,40	6	28,80	40,00	60,39	30,19	20,11	15,08	12,05
recommended degree of programmed feed rate to use while ramping										100%	70%	50%	30%	10%		

NOTE: YRC = distance from centerline to the crown of the R radius.
 RCN = distance from centerline to the start of the cutting edge. This dimension can also help determine the minimum circle size when helical ramping.
 R = the head radius size.
 Rc = the shoulder radius or radius at the corner of the cutter.

162-163	164	159-161	168

DUO-LOCK™ • KenFeed™ • KMDA • Application Data • Metric



Material Group			straight short			conical medium			conical long			Recommended feed per tooth (fz = mm/th) for side milling (A).					
			KC639M			KC639M			KC639M			D1 – Diameter					
	A		Cutting Speed – vc m/min			Cutting Speed – vc m/min			Cutting Speed – vc m/min								
	ap	ae	min	–	max	min	–	max	min	–	max	mm	10,0	12,0	16,0	20,0	
P	3	0,05 x D	0,55 x D	120	–	160	108	–	144	108	–	144	fz	0,424	0,491	0,610	0,707
	4	0,05 x D	0,55 x D	90	–	150	81	–	135	81	–	135	fz	0,378	0,437	0,538	0,616
H	1	0,05 x D	0,55 x D	80	–	140	64	–	112	48	–	84	fz	0,378	0,437	0,538	0,616
	2	0,05 x D	0,55 x D	70	–	120	56	–	96	42	–	72	fz	0,283	0,326	0,399	0,454

NOTE: These guidelines may require variations to achieve optimum results.
 Lower value of cutting speed is used for high stock removal applications or for higher hardness (machinability) within group.
 Higher value of cutting speed is used for finishing applications or for lower hardness (machinability) within group.
 Above parameters are based on ideal conditions. For smaller taper machining centers, please adjust parameters accordingly on diameters >12mm.
 For better surface finish, reduce feed per tooth.
 For tools with reach > 3 x D, reduce Fz by 20%.
 For tools with reach >5 x D, reduce Fz by 30%.
 For tools with reach >10 x D, reduce Vc and Fz by 30%.

DUO-LOCK • KenFeed • KSDB • Application Data • Metric



Material Group			short			medium			long			Recommended feed per tooth (fz = mm/th) for side milling (A).					
			adapter reach									D1 – Diameter					
	A		KC643M			KC643M			KC643M								
	ap	ae	Cutting Speed – vc m/min			Cutting Speed – vc m/min			Cutting Speed – vc m/min			mm	10,0	12,0	16,0	20,0	
P	5	0,05 x D	0,55 x D	60	–	100	51	–	85	48	–	80	fz	0,290	0,337	0,419	0,485
	6	0,05 x D	0,55 x D	50	–	75	43	–	64	40	–	60	fz	0,242	0,279	0,342	0,389
M	1	0,05 x D	0,55 x D	90	–	115	72	–	92	63	–	81	fz	0,363	0,421	0,523	0,606
	2	0,05 x D	0,55 x D	60	–	80	48	–	64	42	–	56	fz	0,290	0,337	0,419	0,485
S	3	0,05 x D	0,55 x D	60	–	70	48	–	56	42	–	49	fz	0,242	0,279	0,342	0,389
	1	0,05 x D	0,55 x D	50	–	90	40	–	72	30	–	54	fz	0,363	0,421	0,523	0,606
	2	0,05 x D	0,55 x D	25	–	40	20	–	32	15	–	24	fz	0,192	0,223	0,278	0,324
	3	0,05 x D	0,55 x D	25	–	40	20	–	32	15	–	24	fz	0,192	0,223	0,278	0,324
	4	0,05 x D	0,55 x D	50	–	60	40	–	48	30	–	36	fz	0,267	0,310	0,385	0,445

NOTE: These guidelines may require variations to achieve optimum results.
 Lower value of cutting speed is used for high stock removal applications or for higher hardness (machinability) within group.
 Higher value of cutting speed is used for finishing applications or for lower hardness (machinability) within group.
 Above parameters are based on ideal conditions. For smaller taper machining centers, please adjust parameters accordingly on diameters greater than 12mm.
 For cutting aluminum with high silicon TiCN coating is recommended.
 For better surface finish reduce feed per tooth.
 For tools with reach >3 x D, reduce Fz by 20%.
 For tools with reach >5 x D, reduce Fz by 30%.
 For tools with reach >10 x D, reduce Vc and Fz by 30%.

DUO-LOCK™ • KenCut™ RR • Radiused • 3 Flutes • Metric

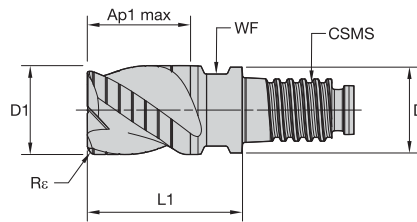

- first choice
- alternate choice

P	●
M	●
K	●
N	●
S	●
H	○

order number	catalogue number	D1	D	Ap1 max	L1	CSMS	WF	Re	KCPM15
6441047	RFDD1000X3AQD	10,00	9,60	7,50	17,50	DL10	8,00	0,40	●
6441048	RFDD1200X3AQD	12,00	11,50	9,00	21,00	DL12	9,50	0,40	●
6441049	RFDD1600X3AQD	16,00	15,50	12,00	28,00	DL16	13,00	0,40	●
6441050	RFDD2000X3AQD	20,00	19,30	15,00	35,00	DL20	16,00	0,40	●

DUO-LOCK • KenCut FF • Radiused • 3 Flutes • Metric

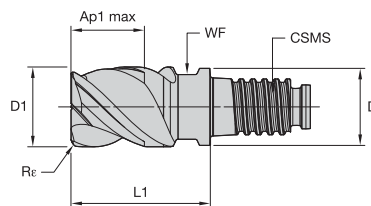

- first choice
- alternate choice

P	●
M	●
K	●
N	●
S	●
H	○

order number	catalogue number	D1	D	Ap1 max	L1	CSMS	WF	Re	KCPM15
6441043	FGDF0970X3AQX	9,70	9,60	7,50	17,50	DL10	8,00	0,33	●
6441029	FGDF1000X3AQD	10,00	9,60	7,50	17,50	DL10	8,00	0,40	●
6441044	FGDF1170X3AQX	11,70	11,50	9,00	21,00	DL12	9,50	0,33	●
6441030	FGDF1200X3AQD	12,00	11,50	9,00	21,00	DL12	9,50	0,40	●
6441045	FGDF1570X3AQX	15,70	15,50	12,00	28,00	DL16	13,00	0,33	●
6441041	FGDF1600X3AQD	16,00	15,50	12,00	28,00	DL16	13,00	0,40	●
6441046	FGDF1970X3AQD	19,70	19,30	15,00	35,00	DL20	16,00	0,40	●
6441042	FGDF2000X3AQD	20,00	19,30	15,00	35,00	DL20	16,00	0,40	●

162-163	164	159-161	168

DUO-LOCK™ • KenCut™ RR • Application Data • Metric



Material Group					straight short		conical medium			conical long			Recommended feed per tooth (fz = mm/th) for side milling (A). For slotting (B), reduce fz by 20%.					
	A		B		KCPM15		KCPM15			KCPM15			D1 – Diameter					
	ap	ae	ap		Cutting Speed – vc m/min		Cutting Speed – vc m/min			Cutting Speed – vc m/min			mm	10,0	12,0	16,0	20,0	
P	0	0,75 x D	0,5 x D	0,5 x D	150	–	200	135	–	180	135	–	180	fz	0,061	0,070	0,086	0,097
	1	0,75 x D	0,5 x D	0,5 x D	150	–	200	135	–	180	135	–	180	fz	0,061	0,070	0,086	0,097
	2	0,75 x D	0,5 x D	0,5 x D	140	–	190	126	–	171	126	–	171	fz	0,061	0,070	0,086	0,097
	3	0,75 x D	0,5 x D	0,5 x D	120	–	160	108	–	144	108	–	144	fz	0,051	0,060	0,074	0,086
	4	0,75 x D	0,4 x D	0,5 x D	90	–	150	81	–	135	81	–	135	fz	0,046	0,053	0,065	0,075
	5	0,75 x D	0,5 x D	0,5 x D	60	–	100	51	–	85	48	–	80	fz	0,041	0,048	0,059	0,069
M	6	0,75 x D	0,4 x D	0,5 x D	50	–	75	43	–	64	40	–	60	fz	0,034	0,040	0,048	0,055
	1	0,75 x D	0,4 x D	0,5 x D	90	–	115	72	–	92	63	–	81	fz	0,051	0,060	0,074	0,086
	2	0,75 x D	0,4 x D	0,5 x D	60	–	80	48	–	64	42	–	56	fz	0,041	0,048	0,059	0,069
K	3	0,75 x D	0,4 x D	0,5 x D	60	–	70	48	–	56	42	–	49	fz	0,034	0,040	0,048	0,055
	1	0,75 x D	0,5 x D	0,5 x D	120	–	150	108	–	135	108	–	135	fz	0,061	0,070	0,086	0,097
	2	0,75 x D	0,5 x D	0,5 x D	110	–	140	99	–	126	99	–	126	fz	0,051	0,060	0,074	0,086
H	3	0,75 x D	0,4 x D	0,5 x D	110	–	130	99	–	117	99	–	117	fz	0,041	0,048	0,059	0,069
	1	0,75 x D	0,2 x D	0,3 x D	80	–	140	64	–	112	48	–	84	fz	0,046	0,053	0,065	0,075

NOTE: These guidelines may require variations to achieve optimum results.
 Lower value of cutting speed is used for high stock removal applications or for higher hardness (machinability) within group.
 Higher value of cutting speed is used for finishing applications or for lower hardness (machinability) within group.
 Above parameters are based on ideal conditions. For smaller taper machining centers, please adjust parameters accordingly on diameters >12mm.
 For tools with reach > 3 x D, reduce fz by 20%.
 For tools with reach >5 x D, reduce fz by 30%.
 For tools with reach >10 x D, reduce Vc and fz by 30%.

DUO-LOCK™ • KenCut™ FF • Application Data • Metric



Material Group					straight short		conical medium			conical long			Recommended feed per tooth (fz = mm/th) for side milling (A). For slotting (B), reduce fz by 20%.					
	A		B		KCPM15		KCPM15			KCPM15			D1 – Diameter					
	ap	ae	ap		Cutting Speed – vc m/min		Cutting Speed – vc m/min			Cutting Speed – vc m/min			mm	10,0	12,0	16,0	20,0	
P	0	0,75 x D	0,5 x D	0,5 x D	150	–	200	135	–	180	135	–	180	fz	0,061	0,070	0,086	0,097
	1	0,75 x D	0,5 x D	0,5 x D	150	–	200	135	–	180	135	–	180	fz	0,061	0,070	0,086	0,097
	2	0,75 x D	0,5 x D	0,5 x D	140	–	190	126	–	171	126	–	171	fz	0,061	0,070	0,086	0,097
	3	0,75 x D	0,4 x D	0,5 x D	120	–	160	108	–	144	108	–	144	fz	0,051	0,060	0,074	0,086
	4	0,75 x D	0,3 x D	0,5 x D	90	–	150	81	–	135	81	–	135	fz	0,046	0,053	0,065	0,075
	5	0,75 x D	0,4 x D	0,5 x D	60	–	100	51	–	85	48	–	80	fz	0,041	0,048	0,059	0,069
M	6	0,75 x D	0,3 x D	0,5 x D	50	–	75	43	–	64	40	–	60	fz	0,034	0,040	0,048	0,055
	1	0,75 x D	0,4 x D	0,5 x D	90	–	115	72	–	92	63	–	81	fz	0,051	0,060	0,074	0,086
	2	0,75 x D	0,4 x D	0,5 x D	60	–	80	48	–	64	42	–	56	fz	0,041	0,048	0,059	0,069
K	3	0,75 x D	0,4 x D	0,5 x D	60	–	70	48	–	56	42	–	49	fz	0,034	0,040	0,048	0,055
	1	0,75 x D	0,5 x D	0,5 x D	120	–	150	108	–	135	108	–	135	fz	0,061	0,070	0,086	0,097
	2	0,75 x D	0,5 x D	0,5 x D	110	–	140	99	–	126	99	–	126	fz	0,051	0,060	0,074	0,086
S	3	0,75 x D	0,4 x D	0,5 x D	110	–	130	99	–	117	99	–	117	fz	0,041	0,048	0,059	0,069
	1	0,3 x D	0,3 x D	0,5 x D	50	–	90	40	–	72	30	–	54	fz	0,051	0,060	0,074	0,086
	2	0,3 x D	0,3 x D	0,5 x D	25	–	40	20	–	32	15	–	24	fz	0,027	0,032	0,039	0,046
	3	0,75 x D	0,3 x D	0,5 x D	25	–	40	20	–	32	15	–	24	fz	0,027	0,032	0,039	0,046
H	4	0,75 x D	0,3 x D	0,5 x D	50	–	60	40	–	48	30	–	36	fz	0,038	0,044	0,055	0,063
	1	0,75 x D	0,2 x D	0,3 x D	80	–	140	64	–	112	48	–	84	fz	0,046	0,053	0,065	0,075

NOTE: These guidelines may require variations to achieve optimum results.
 Lower value of cutting speed is used for high stock removal applications or for higher hardness (machinability) within group.
 Higher value of cutting speed is used for finishing applications or for lower hardness (machinability) within group.
 Above parameters are based on ideal conditions. For smaller taper machining centers, please adjust parameters accordingly on diameters >12mm.
 For tools with reach > 3 x D, reduce Fz by 20%.
 For tools with reach >5 x D, reduce Fz by 30%.
 For tools with reach >10 x D, reduce Vc and Fz by 30%.



DUO-LOCK™ • KenCut™ CM • Multi-Flute • Metric

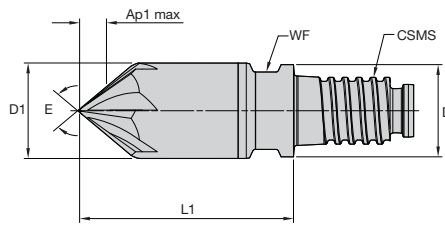

- first choice
- alternate choice

P	●
M	●
K	●
N	●
S	○
H	○

order number	catalogue number	D1	D	Ap1 max	L1	CSMS system size	WF	E	Z U	KCPM15
6127404	XADA1000X4CH45	10,00	9,60	2,00	22,60	DL10	8,00	90	4	●
6408009	XADA1000X4CH60	10,00	9,60	2,00	22,60	DL10	8,00	60	4	●
6127405	XADA1200X5CH45	12,00	11,50	3,00	27,20	DL12	9,50	90	5	●
6408010	XADA1200X5CH60	12,00	11,50	3,00	27,20	DL12	9,50	60	5	●
6127406	XADA1600X6CH45	16,00	15,50	4,00	36,25	DL16	13,00	90	6	●
6408041	XADA1600X6CH60	16,00	15,50	4,00	36,00	DL16	13,00	60	6	●

DUO-LOCK • KenCut CM • Multi-Flute • Metric

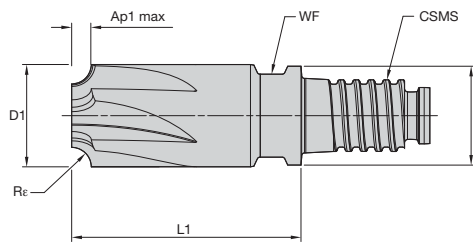

- first choice
- alternate choice

P	●
M	●
K	●
N	●
S	○
H	○

order number	catalogue number	D1	D	Ap1 max	L1	CSMS system size	WF	Re	Z U	KCPM15
6127382	XRDA1000X4CHJ	10,00	9,60	1,50	22,50	DL10	8,00	1,50	4	●
6127383	XRDA1000X4CRM	10,00	9,60	3,00	22,70	DL10	8,00	3,00	4	●
6127384	XRDA1200X5CRG	12,00	11,50	1,00	27,20	DL12	9,50	1,00	5	●
6127385	XRDA1200X5CRK	12,00	11,50	2,00	27,20	DL12	9,50	2,00	5	●
6127386	XRDA1200X5CRM	12,00	11,50	3,00	27,20	DL12	9,50	3,00	5	●
6127387	XRDA1600X6CRK	16,00	15,50	2,00	36,10	DL16	13,00	2,00	6	●
6127388	XRDA1600X6CRM	16,00	15,50	3,00	36,00	DL16	13,00	3,00	6	●
6127389	XRDA1600X6CRN	16,00	15,50	4,00	35,95	DL16	13,00	4,00	6	●

162-163	164	159-161	168

DUO-LOCK™ • Corner Machining • Application Data • Metric

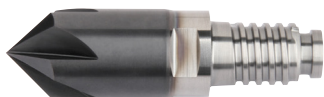

KenCut CM – XADA



KenCut CM – XRDA

Material Group			short			medium			long			Recommended feed per tooth (fz = mm/th) for side milling (A).				
	A		adapter reach									D1 – Diameter				
			KCPM15			KCPM15			KCPM15							
	ap	ae	Cutting Speed – vc m/min			Cutting Speed – vc m/min			Cutting Speed – vc m/min							
		min		max	min		max	min		max	mm	10,0	12,0	16,0		
P	0	0,35 x D	0,35 x D	150	–	200	135	–	180	135	–	180	fz	0,058	0,066	0,081
	1	0,35 x D	0,35 x D	150	–	200	135	–	180	135	–	180	fz	0,058	0,066	0,081
	2	0,35 x D	0,35 x D	140	–	190	126	–	171	126	–	171	fz	0,058	0,066	0,081
	3	0,35 x D	0,35 x D	120	–	160	108	–	144	108	–	144	fz	0,048	0,056	0,070
	4	0,35 x D	0,35 x D	90	–	150	81	–	135	81	–	135	fz	0,043	0,050	0,061
	5	0,35 x D	0,35 x D	60	–	100	51	–	85	48	–	80	fz	0,039	0,045	0,056
M	1	0,35 x D	0,35 x D	90	–	115	72	–	92	63	–	80,5	fz	0,048	0,056	0,070
	2	0,35 x D	0,35 x D	60	–	80	48	–	64	42	–	56	fz	0,039	0,045	0,056
K	3	0,35 x D	0,35 x D	60	–	70	48	–	56	42	–	49	fz	0,032	0,037	0,046
	1	0,35 x D	0,35 x D	120	–	150	108	–	135	108	–	135	fz	0,058	0,066	0,081
N	2	0,35 x D	0,35 x D	110	–	140	99	–	126	99	–	126	fz	0,048	0,056	0,070
	3	0,35 x D	0,35 x D	110	–	130	99	–	117	99	–	117	fz	0,039	0,045	0,056
	1	0,35 x D	0,35 x D	500	–	2000	400	–	1600	300	–	1200	fz	0,080	0,096	0,128
	2	0,35 x D	0,35 x D	500	–	1500	400	–	1200	300	–	900	fz	0,072	0,086	0,115
	3	0,35 x D	0,35 x D	500	–	1500	400	–	1200	300	–	900	fz	0,056	0,067	0,090
	4	0,35 x D	0,35 x D	400	–	750	320	–	600	240	–	450	fz	0,056	0,067	0,090
	5	0,35 x D	0,35 x D	250	–	1000	200	–	800	150	–	600	fz	0,072	0,086	0,115
S	6	0,35 x D	0,35 x D	100	–	750	80	–	600	60	–	450	fz	0,080	0,096	0,128
	7	0,35 x D	0,35 x D	100	–	750	80	–	600	60	–	450	fz	0,056	0,067	0,090
	1	0,35 x D	0,35 x D	50	–	90	40	–	72	30	–	54	fz	0,048	0,056	0,070
	2	0,35 x D	0,35 x D	25	–	40	20	–	32	15	–	24	fz	0,026	0,030	0,037
H	3	0,35 x D	0,35 x D	25	–	40	20	–	32	15	–	24	fz	0,026	0,030	0,037
	4	0,35 x D	0,35 x D	50	–	60	40	–	48	30	–	36	fz	0,036	0,041	0,051
	1	0,35 x D	0,35 x D	80	–	140	64	–	112	48	–	84	fz	0,043	0,050	0,061

NOTE: Lower value of cutting speed is used for high stock removal applications or for higher hardness (machinability) within group.
 Higher value of cutting speed is used for finishing applications or for lower hardness (machinability) within group.
 Above parameters are based on ideal conditions. For smaller taper machining centers, please adjust parameters accordingly on diameters >12mm.
 For side milling with Ap larger than 1 x D, reduce Fz by 20%.

DUO-LOCK™ • Intelligent Thread

The DUO-LOCK Intelligent Thread eliminates the force peaks all regular threads have in the first groove.

3 golden rules to success:

1. Clean both sides of the coupling. Thread needs to be free of any lubricant, such as oil, anti seize, grease, etc.
2. Apply recommended torque values.
3. When using DUO-LOCK cylindrical extensions, never clamp on the coupling.

Finite Element Analysis FEA

DUO-LOCK Intelligent Thread

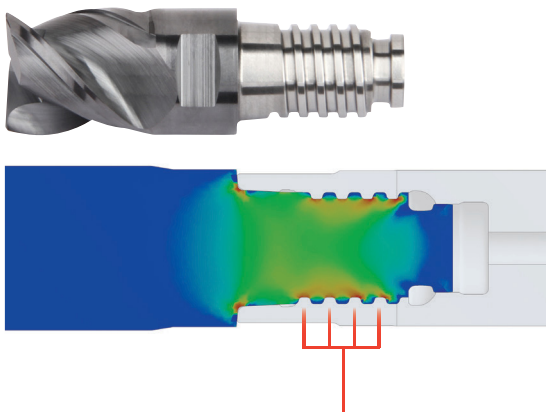

DUO-LOCK Intelligent Thread at maximum load.

The DUO-LOCK Intelligent Thread evenly distributes the forces across the entire length of the thread. This allows a greater than 25% torque transmission than known competitors.

Regular threads

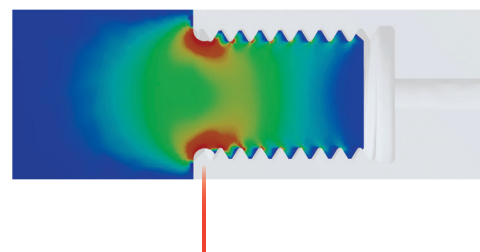

Typical for any regular thread at maximum load.

High force peak in the first groove, limiting the performance of the connection.

DUO-LOCK • Reconditioning

Wear and/or chipping determines to what extent and how often DUO-LOCK tips can be reconditioned. To ensure integrity of the wrench flats, the neck portion cannot be modified.

NOTE: The cutting diameter of reconditioned DUO-LOCK tips might be smaller than the neck diameter, and therefore may not have a clearance anymore. To prevent collisions, precautions need to be taken.

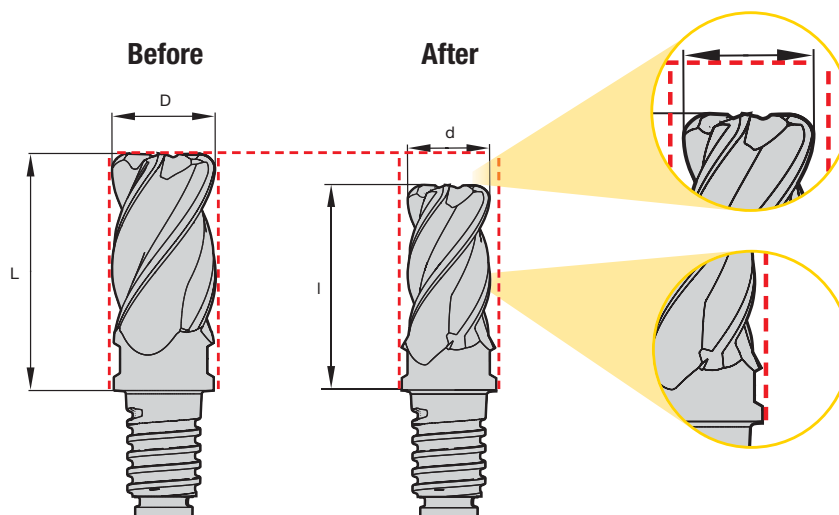

DUO-LOCK™ • Tool Clamping

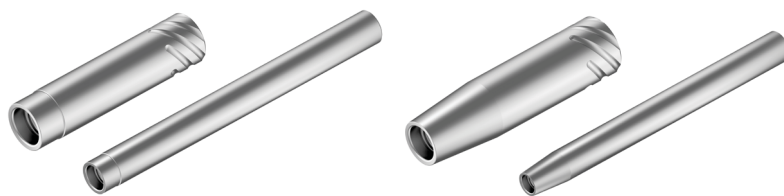

DUO-LOCK Extension Shank Diameter [D2]		10	12	16	20	25	32	12	16	20	25	32	40	50
HydroForce™		–	–	–	●	–	●	–	–	●	–	●	–	●
HydroForce with Sleeve		●	●	●	●	●	–	●	●	●	●	–	●	–
HydroForce with Safe-Lock™ Sleeve *		–	●	●	●	●	–	●	●	●	●	–	–	–
Shrink Fit		●	●	●	●	●	●	●	●	●	●	●	●	●
Safe-Lock™ Shrink Fit *		–	●	●	●	●	●	●	●	●	●	●	●	●
Milling Chuck		–	–	–	●	–	●	–	–	●	–	●	–	–
Milling Chuck with Sleeve		●	●	●	●	●	–	●	●	●	●	–	–	–
ER Collet Chuck		■	■	○	○	○	–	■	■	○	○	–	–	–
TG Collet Chuck		■	■	■	○	○	–	■	■	■	○	–	–	–

* Features Safe-Lock™ pullout protection

● Recommended

○ Not recommended

■ Suitable with limitations

– Not available

NOTE: DUO-LOCK™ steel extensions require high power shrinking units greater than 10KW.
All Safe-Lock™ extensions can be clamped in a cylindrical shank adapter.

DUO-LOCK™ • Steel Extension • Cylindrical • Safe-Lock™ • Metric

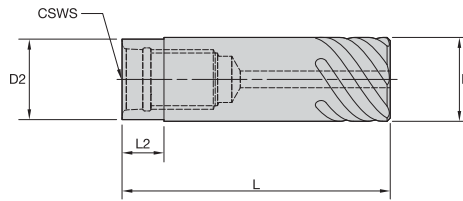

order number	catalogue number	CSWS	D	D2	L	L2	kg
6134889	SS10SLDL10055M	DL10	10	9,58	55	6	0,03
6135043	SS12SLDL12065M	DL12	12	11,50	65	7	0,05
6135049	SS16SLDL16070M	DL16	16	15,50	70	9	0,09
6135057	SS20SLDL20080M	DL20	20	19,30	80	11	0,16
6135063	SS25SLDL25090M	DL25	25	24,00	90	13	0,27
6135067	SS32SLDL32105M	DL32	32	31,00	105	17	0,52

NOTE: Cylindrical shanks not recommended for full slotting.

DUO-LOCK • Steel Extension • Conical • Safe-Lock • Metric

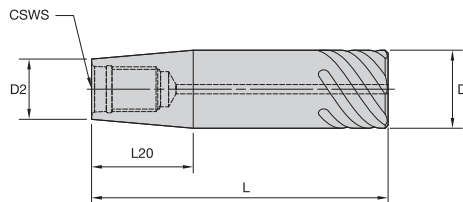

order number	catalogue number	CSWS	D	D2	L	L20	kg
6135041	SS12SLDL10065M	DL10	12	9,58	65	14	0,05
6135045	SS16SLDL10090M	DL10	16	9,58	90	37	0,11
6135051	SS20SLDL10115M	DL10	20	9,58	115	59	0,21
6135047	SS16SLDL12080M	DL12	16	11,50	80	26	0,11
6135053	SS20SLDL12105M	DL12	20	11,50	105	49	0,20
6135055	SS20SLDL16080M	DL16	20	15,50	80	26	0,16
6135059	SS25SLDL16115M	DL16	25	15,50	115	54	0,35
6135061	SS25SLDL20095M	DL20	25	19,30	95	33	0,30
6135065	SS32SLDL25105M	DL25	32	24,00	105	46	0,52
6135069	SS40SLDL32140M	DL32	40	31,00	140	51	1,13
6135081	SS50SLDL32200M	DL32	50	31,00	200	109	2,35

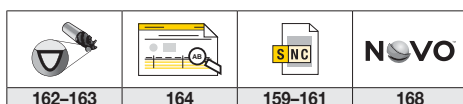

DUO-LOCK™ • Steel Extension • Cylindrical • Straight Shank • Metric

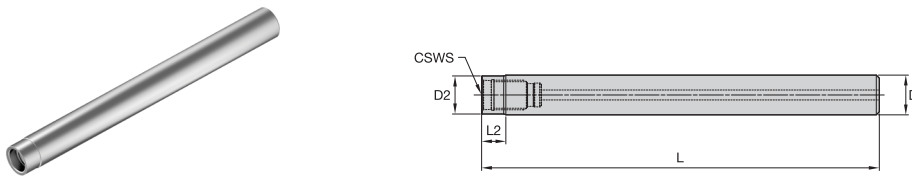

order number	catalogue number	CSWS	D	D2	L	L2	kg
6134890	SS10DL10100M	DL10	10	9,58	100	5	0,05
6135044	SS12DL12120M	DL12	12	11,50	120	6	0,09
6135050	SS16DL16160M	DL16	16	15,50	160	8	0,23
6135058	SS20DL20200M	DL20	20	19,30	200	10	0,45
6135064	SS25DL25250M	DL25	25	24,00	250	13	0,86
6135068	SS32DL32250M	DL32	32	31,00	250	16	1,41

NOTE: Standard catalog cutting data does not apply. Consult tooling application expert before use.

DUO-LOCK • Steel Extension • Conical • Straight Shank • Metric

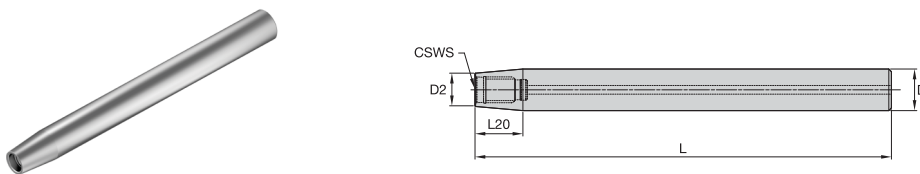

order number	catalogue number	CSWS	D	D2	L	L20	kg
6135042	SS12DL10120M	DL10	12	9,58	120	14	0,10
6135046	SS16DL10160M	DL10	16	9,58	160	37	0,22
6135052	SS20DL10200M	DL10	20	9,58	200	59	0,42
6135048	SS16DL12160M	DL12	16	11,50	160	26	0,23
6135054	SS20DL12200M	DL12	20	11,50	200	48	0,43
6135056	SS20DL16200M	DL16	20	15,50	200	26	0,45
6135060	SS25DL16250M	DL16	25	15,50	250	54	0,86
6135062	SS25DL20250M	DL20	25	19,30	250	32	0,89
6135066	SS32DL25250M	DL25	32	24,00	250	45	1,42
6135070	SS40DL32250M	DL32	40	31,00	250	51	2,20
6135082	SS50DL32250M	DL32	50	31,00	250	108	3,14

NOTE: Standard catalog cutting data does not apply. Consult tooling application expert before use.

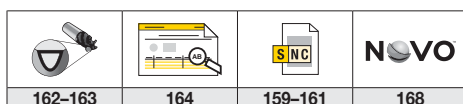

DUO-LOCK™ • Heavy Metal Extension • Cylindrical • Straight Shank • Metric

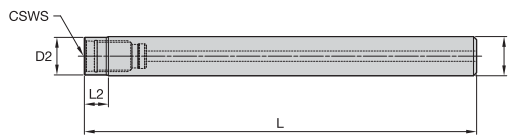
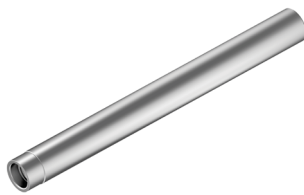

order number	catalogue number	CSWS	D	D2	L	L2	kg
6933541	HS10DL10N020070M	DL10	10	9,58	70	20	0,08
6933545	HS10DL10N040090M	DL10	10	9,58	90	40	0,10
6933542	HS12DL12N023080M	DL12	12	11,50	80	23	0,13
6933546	HS12DL12N047100M	DL12	12	11,50	100	47	0,17
6933543	HS16DL16N030090M	DL16	16	15,50	90	30	0,26
6933547	HS16DL16N062120M	DL16	16	15,50	120	62	0,16
6933544	HS20DL20N037100M	DL20	20	19,30	100	37	0,46
6933548	HS20DL20N077140M	DL20	20	19,30	140	77	0,65

DUO-LOCK • ER Solid Collets

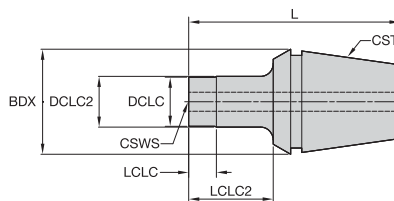



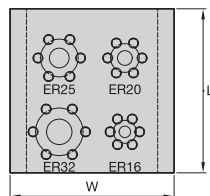
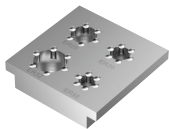

order number	catalogue number	CST	CSWS	BDX	L	DCLC	DCLC2	LCLC	LCLC2	kg	Nm
6612283	16ERDL10	ER16	DL10	17	32,8	9,6	—	5,3	—	0,03	20
6612284	20ERDL10	ER20	DL10	21	37,0	9,6	—	5,5	—	0,06	20
6612285	20ERDL12	ER20	DL12	21	38,0	11,5	—	6,5	—	0,06	30
6612286	25ERDL10	ER25	DL10	26	39,5	9,6	—	5,5	—	0,10	20
6612287	25ERDL12	ER25	DL12	26	40,5	11,5	—	6,5	—	0,10	30
6612288	25ERDL16	ER25	DL16	26	39,5	15,5	—	5,5	—	0,10	60
6612289	32ERDL10	ER32	DL10	33	66,5	9,6	10	5,0	26,5	0,21	20
6612290	32ERDL12	ER32	DL12	33	67,5	11,5	12	6,0	27,5	0,21	30
6612331	32ERDL16	ER32	DL16	33	66,5	15,5	16	8,0	26,5	0,22	60
6612332	32ERDL20	ER32	DL20	33	66,5	19,3	20	10,0	26,5	0,23	80

DUO-LOCK • ER Solid Collet Mounting Plate



order number	catalogue number	L	W	kg
6612333	DLCCDER	100	100	0,57

			
162-163	164	159-161	168

DUO-LOCK™ • Adapter • HSK63 Form A • Metric

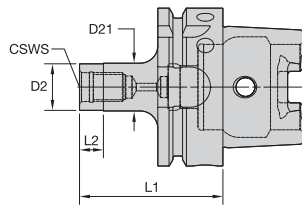
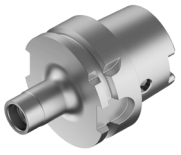

order number	catalogue number	CSWS	D2	D21	L1	L2	kg
6136949	HSK63ADL10048M	DL10	10	10	48	5	0,69
6136950	HSK63ADL12052M	DL12	12	12	52	6	0,69
6136951	HSK63ADL16057M	DL16	16	16	57	8	0,70
6136952	HSK63ADL20057M	DL20	19	20	57	10	0,72
6136953	HSK63ADL25061M	DL25	24	25	61	12	0,74
6136954	HSK63ADL32072M	DL32	31	32	72	16	0,83

DUO-LOCK • Adapter • HSK100 Form A • Metric

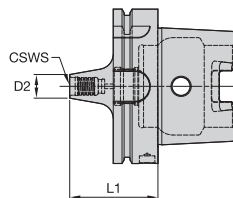
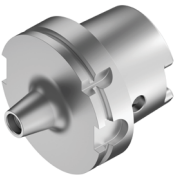



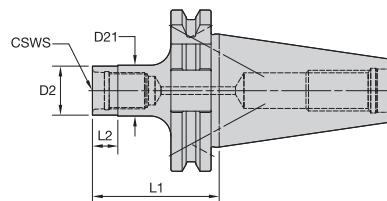
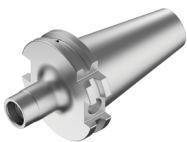

order number	catalogue number	CSWS	D2	L1	kg
6452503	HSK100ADL16060M	DL16	16	60	2,08
6452504	HSK100ADL20060M	DL20	19	60	2,12
6452505	HSK100ADL25065M	DL25	24	65	2,18
6452506	HSK100ADL32075M	DL32	31	75	2,40

DUO-LOCK • Adapter • DV40 • Metric



order number	catalogue number	CSWS	D2	D21	L1	L2	kg
6136993	DV40BDL10041M	DL10	10	10	41	5	0,82
6136994	DV40BDL12041M	DL12	12	12	41	6	0,81
6136995	DV40BDL16050M	DL16	16	16	50	8	0,83
6136996	DV40BDL20050M	DL20	19	20	50	10	0,84

			
162-163	164	159-161	168

DUO-LOCK™ • Adapter • DV50 • Metric

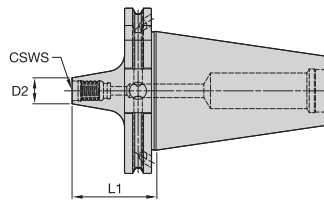
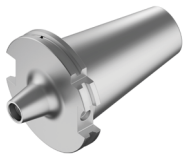

order number	catalogue number	CSWS	D2	L1	kg
6452419	DV50BDL16050M	DL16	16	50	2,68
6452420	DV50BDL20050M	DL20	19	50	2,73
6452501	DV50BDL25056M	DL25	24	56	2,79
6452502	DV50BDL32065M	DL32	31	65	3,01

DUO-LOCK • Adapter • BT40 • Metric

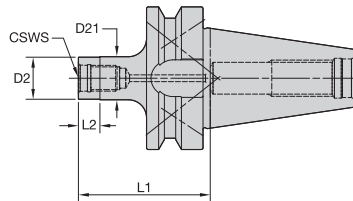
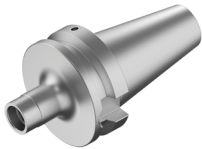

order number	catalogue number	CSWS	D2	D21	L1	L2	kg
6136977	BT40BDL10049M	DL10	10	10	49	5	0,98
6136978	BT40BDL12049M	DL12	12	12	49	6	0,97
6136979	BT40BDL16058M	DL16	16	16	58	8	1,00
6136980	BT40BDL20058M	DL20	19	20	58	10	1,00
6136991	BT40BDL25060M	DL25	24	25	60	12	1,02

DUO-LOCK • Adapter • PSC63 • Metric

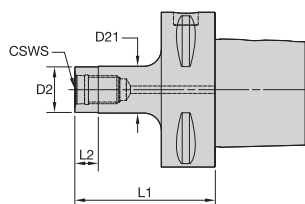
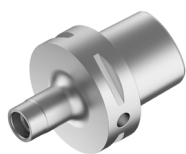

order number	catalogue number	CSWS	D2	D21	L1	L2	kg
6136956	PSC63DL12050M	DL12	12	12	50	6	0,77
6136958	PSC63DL20055M	DL20	19	20	55	10	0,80
6136959	PSC63DL25060M	DL25	24	25	60	12	0,83
6136960	PSC63DL32068M	DL32	31	32	68	16	0,91

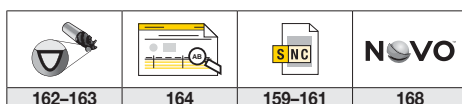

DUO-LOCK™ • Double-Handed Torque Wrench



order number	catalogue number	Description
6135413	TWDLTM	BASIC DUO LOCK WRENCH
6135414	TWTMINsertDL10	TORQUE WRENCH INSERT DL10
6135415	TWTMINsertDL12	TORQUE WRENCH INSERT DL12
6135416	TWTMINsertDL16	TORQUE WRENCH INSERT DL16
6135417	TWTMINsertDL20	TORQUE WRENCH INSERT DL20
6135418	TWTMINsertDL25	TORQUE WRENCH INSERT DL25
6135419	TWTMINsertDL32	TORQUE WRENCH INSERT DL32
6135422	TWTMEXT	TORQUE WRENCH EXTENSION HANDLE
6135423	TWTMBC	TORQUE WRENCH BOLT SET

NOTE: Combine basic DUO-LOCK wrench with selected torque wrench inserts needed.

DUO-LOCK • Torque Wrench • Double-Handed • Kit

1 ERICKSON™ Torque Master Wrench

2 Insert

3 Extension Handle



Order this

Get that

order number	catalogue number	Kit Description	DUO-LOCK Size	torque (Nm)
6342967	TWDL10TM	D-L WRENCH WITH DL10 INSERT AND HANDLES	DL 10	20
6342968	TWDL12TM	D-L WRENCH WITH DL12 INSERT AND HANDLES	DL 12	30
6342969	TWDL16TM	D-L WRENCH WITH DL16 INSERT AND HANDLES	DL 16	60
6342970	TWDL20TM	D-L WRENCH WITH DL20 INSERT AND HANDLES	DL 20	80
6343061	TWDL25TM	D-L WRENCH WITH DL25 INSERT AND HANDLES	DL 25	100
6343062	TWDL32TM	D-L WRENCH WITH DL32 INSERT AND HANDLES	DL 32	130

1+2+3

DUO-LOCK™ • Single-Handed Torque Wrench • Wrench



1

order number	catalogue number	description	DUO-LOCK Size	torque (Nm)
6411155	TWDL9X12	D-L SINGLE HAND TORQUE WRENCH	–	–

DUO-LOCK • Single-Handed Torque Wrench • Insert

2

order number	catalogue number	description	DUO-LOCK Size	torque (Nm)
6410950	TWSH9X12INSERTDL10	D-L TORQUE WRENCH SH INSERT	DL10	20
6411151	TWSH9X12INSERTDL12	D-L TORQUE WRENCH SH INSERT	DL12	30
6411152	TWSH9X12INSERTDL16	D-L TORQUE WRENCH SH INSERT	DL16	60
6411153	TWSH9X12INSERTDL20	D-L TORQUE WRENCH SH INSERT	DL20	80

DUO-LOCK • Single-Handed Torque Wrench • Adapter

3

order number	catalogue number	description	DUO-LOCK Size	torque (Nm)
6411154	TWDL9X12CA14X18	D-L ADAPTER 9X12 TO 14X18	–	–

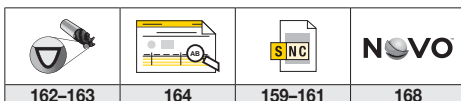

DUO-LOCK™ • Catalog Numbering System

Each character in our catalog number signifies a specific trait of that product. Use the following key columns and corresponding images to easily identify which attributes apply.

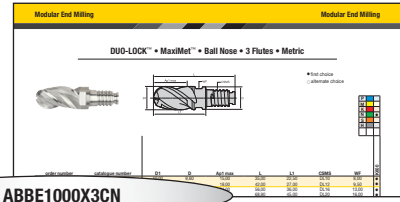

ABBE1000X3CN

AB	B	E	1000	X	3	C	N		
Series	End Mill Shape	Helix Angle	Diameter	Shank Style	Number of Flutes	Length-of-Cut	Shape/Feature	Corner Configuration	
AB = MaxiMet™ – Non-ferrous metals FG = Finisher general applications – Steels FM = Finisher multi-flute – Steels FS = RSM II™ multi-flute – High-temperature alloys KM = KenFeed™ – Medium steels RF = Rougher – Chipbreaker design RK = Rougher – Fine-pitch profile design RQ = Rougher – Coarse-pitch profile design UC = HARVI™ II – Stainless steels UD = HARVI II – High-temperature alloys UJ = HARVI III center cut & eccentric cut – High-temperature alloys UK = HARVI I asymmetric fluting – Stainless steels UL = HARVI I asymmetric fluting – High-temperature alloys XA = Chamfering tool XR = Corner rounding tool	B = Ball Nose D = Square End	A = 0–10 B = 11–20 D = 31–35 E = 36–40 F = 41–45 V = 37/39° variable		X = Metric – DUO-LOCK™ Y = Inch – DUO-LOCK	2 3 4 5 6 9 B = 11 F = 15 J = 19	A = 0,75 x D B = 1,0 x D C = 1,5 x D	H = Chamfer N = Necked Q = Necked & Radius R = Radius U = Necked + Sharp V = Necked + Chamfer	Metric D = Metric – 0,4mm E = Metric – 0,5mm F = Metric – 0,75mm H = Metric – 1,25mm J = Metric – 1,5mm N = Metric – 4,0mm S = Sharp X = Custom Inch A = Inch – .015" B = Inch – .030" C = Inch – .060" D = Inch – .090" E = Inch – .120" F = Inch – .250" S = Sharp X = Custom	

HARVI™ I TE DUO-LOCK • Catalog Numbering System

H1TE4SE1200S016HAM

H1TE	4	SE	1200	S	016	HA		M
Series	Number of Flutes	Front End Style	Cutting Diameter D1	Flute Section Style	Length of Cut Ap1 max	Shank Style	Radius	Standard
H1TE = HARVI I TE	4 = 4-Flute	SE = Sharp Edge CH = Chamfer RA = Radius	Metric = D1 in mm Inch = D1 in decimal inch	R = Regular Without Neck	Metric = Ap1 Max in mm Inch = Ap1 Max in decimal inch	DL = DUO-LOCK		M = Metric Blank = Inch

DUO-LOCK™ Extensions • Catalog Numbering System

Each character in our catalog number signifies a specific trait of that product. Use the following key columns and corresponding images to easily identify which attributes apply.

Order number	Configuration number	CSWS	System Size	D	SS	L	L2	SA
000000	000000	DL10	10	12.7	10	100	10	100
000000	000000	DL12	12	15.88	10	100	10	100
000000	000000	DL16	16	20.0	10	100	10	100
000000	000000	DL20	20	25.4	10	100	10	100
000000	000000	DL25	25	31.75	10	100	10	100
000000	000000	DL32	32	41.28	10	100	10	100

SS10SLDL10055M

SS	10	SL	DL10	055	M
Connection Style Machine Side (CSMS)	Shank Diameter D	Shank Style	Connection Style Workpiece Side (CSWS) System Size	Tool Length	Value
SS = Straight Shank	Metric = D in mm Inch = D in decimal inch	SL = Safe-Lock™ Blank = Plain	DL10 = DUO-LOCK size 10	Metric = L in mm Inch = L in decimal inch	Metric

DUO-LOCK Solid ER Collet • Catalog Numbering System

Each character in our catalog number signifies a specific trait of that product. Use the following key columns and corresponding images to easily identify which attributes apply.

Order number	Configuration number	CSWS	System Size	D	SS	L	L2	SA
000000	000000	DL10	10	12.7	10	100	10	100
000000	000000	DL12	12	15.88	10	100	10	100
000000	000000	DL16	16	20.0	10	100	10	100
000000	000000	DL20	20	25.4	10	100	10	100
000000	000000	DL25	25	31.75	10	100	10	100
000000	000000	DL32	32	41.28	10	100	10	100

32ERDL16

32	ER	DL16
Collet Size	Collet Type	DUO-LOCK Coupling Size
16 = ER16 20 = ER 20 25 = ER 25 32 = ER 32	ER	DL10 DL12 DL16 DL20

DUO-LOCK™ Adapters • Catalog Numbering System

Each character in our catalog number signifies a specific trait of that product. Use the following key columns and corresponding images to easily identify which attributes apply.

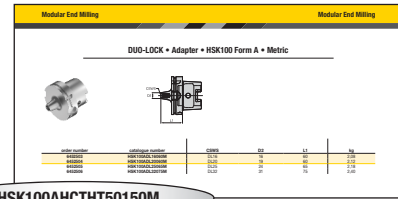

HSK	100	A	HCTHT	50	150	M
Connection Style Machine Side (CSMS)	Connection Size	System Flange Form	Hydraulic Chuck Type	Clamping Diameter	Tool Length	Value
KM™ KM4X™ HSK DV CV BT PSC	30 32 40 50 63 80 100 125	A = Form A C = Form C B = Coolant	HCTHT = HydroForce™ HCSL = Slim Line HCSTL = Slim Line T HC = High Performance DL = DUO-LOCK	50 = 50mm 075 = 3/4"	150 = 150mm 413 = 4.13"	M = Metric Blank = Inch

Grades and Grade Descriptions

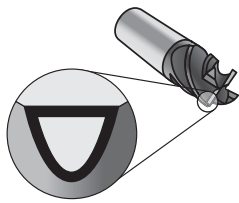

Coatings provide high-speed capability and are engineered for roughing to finishing.

P	Steel
M	Stainless Steel
K	Cast Iron
N	Non-Ferrous
S	High-Temp Alloys
H	Hardened Materials
C	CFRP Materials

wear resistance ← → toughness

Grade	Coating	Grade Description	Material Groups																						
				05	10	15	20	25	30	35	40	45													
K600		Composition: Uncoated, highly wear-resistant submicron grain carbide. Application: Very high toughness ensures a controlled wear rate. The micrograin structure enables extremely sharp edges. First choice for milling of non-ferrous materials.																							
			N																						
KC633M		Composition: Multilayered PVD TiN/TiAlN-coated submicron grain carbide. Application: This multi-purpose grade offers highest versatility and best reliability across recommended material groups at intermediate cutting conditions.																							
			P																						
			M																						
			K																						
			S																						
KC643M		Composition: Monolayer PVD AlTiN-coated submicron grain carbide. Application: This grade offers high hardness and excellent wear resistance for general application in steel, stainless steel, cast iron, and high-temperature alloys.																							
			P																						
			M																						
			K																						
			S																						
KCPM15		Composition: Monolayer PVD AlTiN-coated submicron grain carbide with smooth coating surface. Application: Proprietary coating with best-in-class tool life as well as performance consistency optimized for applications in steel, stainless steel, cast iron, and hard materials.																							
			P																						
			M																						
			K																						
			H																						
KCSM15		Composition: Monolayer PVD AlTiN-coated submicron grain carbide with smooth coating surface. Application: Proprietary coating with best-in-class tool life as well as performance consistency optimized for application in stainless steel and high-temperature alloys.																							
			M																						
			S																						



Grades and Grade Descriptions

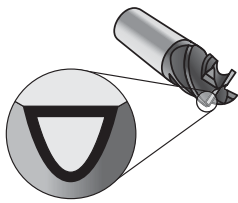

Coatings provide high-speed capability and are engineered for roughing to finishing.

P	Steel
M	Stainless Steel
K	Cast Iron
N	Non-Ferrous
S	High-Temp Alloys
H	Hardened Materials
C	CFRP Materials

wear resistance ← → toughness

Grade	Coating	Grade Description																					
			05	10	15	20	25	30	35	40	45												
KC639M		Composition: Monolayer PVD AlTiN-coated, ultra-fine grain carbide. Application: First choice for hardened steels > 55 HRC.																					
KCN05		Composition: CVD diamond-coated, fine-grain carbide. Application: First choice for machining carbon-fiber reinforced polymers (CFRP). The crystalline diamond-coated grade offers the highest degree of abrasive wear resistance.																					
KD1410		Composition: A polycrystalline diamond (PCD) tip brazed onto a carbide substrate. Application: Engineered for good abrasion resistance combined with excellent edge strength for demanding applications. An ideal choice for aluminum with high silicon content as well as CFRP.																					
KYS40		Composition: SiAlON solid ceramic. Application: SiAlON ceramic end mills take dry machining of nickel-based high-temperature alloys to a new level. The increased heat resistance of SiAlON ceramics enables cutting at highest velocities leading to best metal removal rates and productivity.																					

Key to Product Table Column Headings

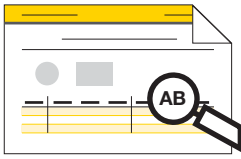

You may notice a slight change in the appearance of our product tables and specification charts. In this catalog, Kennametal introduces a set of short-name codes to improve the readability of tables and drawings. These codes replace full-text descriptions. The full list of codes and their definitions can be found below.

Short-Name Code	Full Text Description
Ap1 max	Maximum Cutting Depth
BCH	Corner Chamfer Width
BDX	Maximum Body Diameter
CSMS	Connection Style Machine Side
CST	Collet Series
CSWS	Connection Style Workpiece Side
D	Adapter/Shank Diameter
D1	Milling: Cutter Diameter
D2	Body Diameter 1 Workpiece Side
D21	Body Diameter 2 Workpiece Side
D3	Neck Diameter
DCLC	Boss Diameter
DCLC2	Boss Diameter 2
E	Profile Angle
ft. lbs.	Torque Foot Pounds
kg	Weight Kilograms
KRA	Lead Angle
L	Overall Length
L1	Milling: Gage Length
L1	Toolholder: Gage Length
L2	Milling: Head Length
L20	Beta Taper End Length
L3	Milling: Maximum Depth
lbs	Weight Pounds
LCLC	Boss Length
LCLC2	Boss Length 2
LS	Shank Length
Nm	Torque Newton Meters
R	Profile or Ball Nose Radii
R _c	Corner Radius
W	Overall Width
WF	Milling: Width of Flat
Z U	Number of Flutes

P	Steel
M	Stainless Steel
K	Cast Iron

N	Non-Ferrous
S	High-Temp Alloys

H	Hardened Materials
C	CFRP Materials

material group	description	content	tensile strength RM (MPa)*	hardness (HB)	hardness (HRC)	material number
P0	Low-Carbon Steels, Long Chipping	C <0,25%	<530	<125	-	-
P1	Low-Carbon Steels, Short Chipping, Free Machining	C <0,25%	<530	<125	-	C15, Ck22, ST37-2, S235JR, 9SMnPb28, GS38
P2	Medium- and High-Carbon Steels	C >0,25%	>530	<220	<25	ST52, S355JR, C35, GS60, Cf53
P3	Alloy Steels and Tool Steels	C >0,25%	600-850	<330	<35	16MnCr5, Ck45, 21CrMoV5-7, 38SMn28
P4	Alloy Steels and Tool Steels	C >0,25%	850-1400	340-450	35-48	100Cr6, 30CrNiMo8, 42CrMo4, C70W2, S6525, X120Mn12
P5	Ferritic, Martensitic, and PH Stainless Steels	-	600-900	<330	<35	100Cr6, 30CrNiMo8, 42CrMo4, C70W2, S6525, X120Mn12
P6	High-Strength Ferritic, Martensitic, and PH Stainless Steels	-	900-1350	350-450	35-48	X102CrMo17, G-X120Cr29
M1	Austenitic Stainless Steel	-	<600	130-200	-	X5CrNi 18 10, X2CrNiMo 17 13 2, G-X25CrNiSi18 9, X15CrNiSi 20 12
M2	High-Strength Austenitic Stainless and Cast Stainless Steels	-	600-800	150-230	<25	X2CrNiMo 13 4, X5NiCr 32 21, X5CrNiNb 18 10, G-X15CrNi 25-20
M3	Duplex Stainless Steel	-	<800	135-275	<30	X8CrNiMo27 5, X2CrNiMoN22 5 3, X20CrNiSi25 4, G-X40CrNiSi27 4
K1	Grey Cast Iron	-	125-500	120-290	<32	GG15, GG25, GG30, GG40, GTW40
K2	Low- and Medium-Strength Ductile Irons (Nodular Irons) and Compacted Graphite Irons (CGI)	-	<600	130-260	<28	GGG40, GTS35
K3	High-Strength Ductile Irons and Austempered Ductile Iron (ADI)	-	>600	180-350	<43	GGG60, GTW55, GTS65
N1	Wrought Aluminum	-	-	-	-	AlMg1, Al99.5, AlCuMg1, AlCuBiPb, AlMgSi1, AlMgSiPb
N2	Low-Silicon Aluminum Alloys and Magnesium Alloys	Si <12,2%	-	-	-	GAISiCu4, GDAISi10Mg
N3	High-Silicon Aluminum Alloys and Magnesium Alloys	Si >12,2%	-	-	-	G-ALSi12, G-ALSi17Cu4, G-ALSi21CuNiMg
N4	Copper-, Brass-, Zinc-Based on Machinability Index Range of 70-100	-	-	-	-	CuZn40, Ms60, G-CuSn5ZnPb, CuZn37, CuSi3Mn
N5	Nylon, Plastics, Rubbers, Phenolics, Resins, Fiberglass	-	-	-	-	LEXAN®, Hostalen™, Polystyrol®, MAKROLON®
N6	Carbon, Graphite Composites, CFRP	-	-	-	-	CFK, GFK
N7	Metal Matrix Composites (MMC)	-	-	-	-	-
S1	Iron-Based, Heat-Resistant Alloys	-	500-1200	160-260	25-48	X1NiCrMoCu32 28 7, X12NiCrSi36 16, X5NiCrAlTi31 20, X40CoCrNi20 20
S2	Cobalt-Based, Heat-Resistant Alloys	-	1000-1450	250-450	25-48	Haynes® 188, Stellite™ 6, 21, 31
S3	Nickel-Based, Heat-Resistant Alloys	-	600-1700	160-450	<48	INCONEL® 690, INCONEL 625, Hastelloy®, NIMONIC® 75
S4	Titanium and Titanium Alloys	-	900-1600	300-400	33-48	Ti1, TiAl5Sn2, TiAl6V4, TiAl4Mo4Sn2
H1	Hardened Materials	-	-	-	44-48	GX260NiCr42, GX330NiCr42, GX300CrNiSi952, GX300CrMo153, Hardox® 400
H2	Hardened Materials	-	-	-	48-55	-
H3	Hardened Materials	-	-	-	56-60	-
H4	Hardened Materials	-	-	-	>60	-
C1	CFRP, CFRP/CFRP	-	-	-	-	-
C2	CFRP/Non-Ferrous	-	-	-	-	-
C3	CFRP/High-Temp	-	-	-	-	-
C4	CFRP/Stainless Steel	-	-	-	-	-
C5	CFRP/Non-Ferrous/High-Temp	-	-	-	-	-



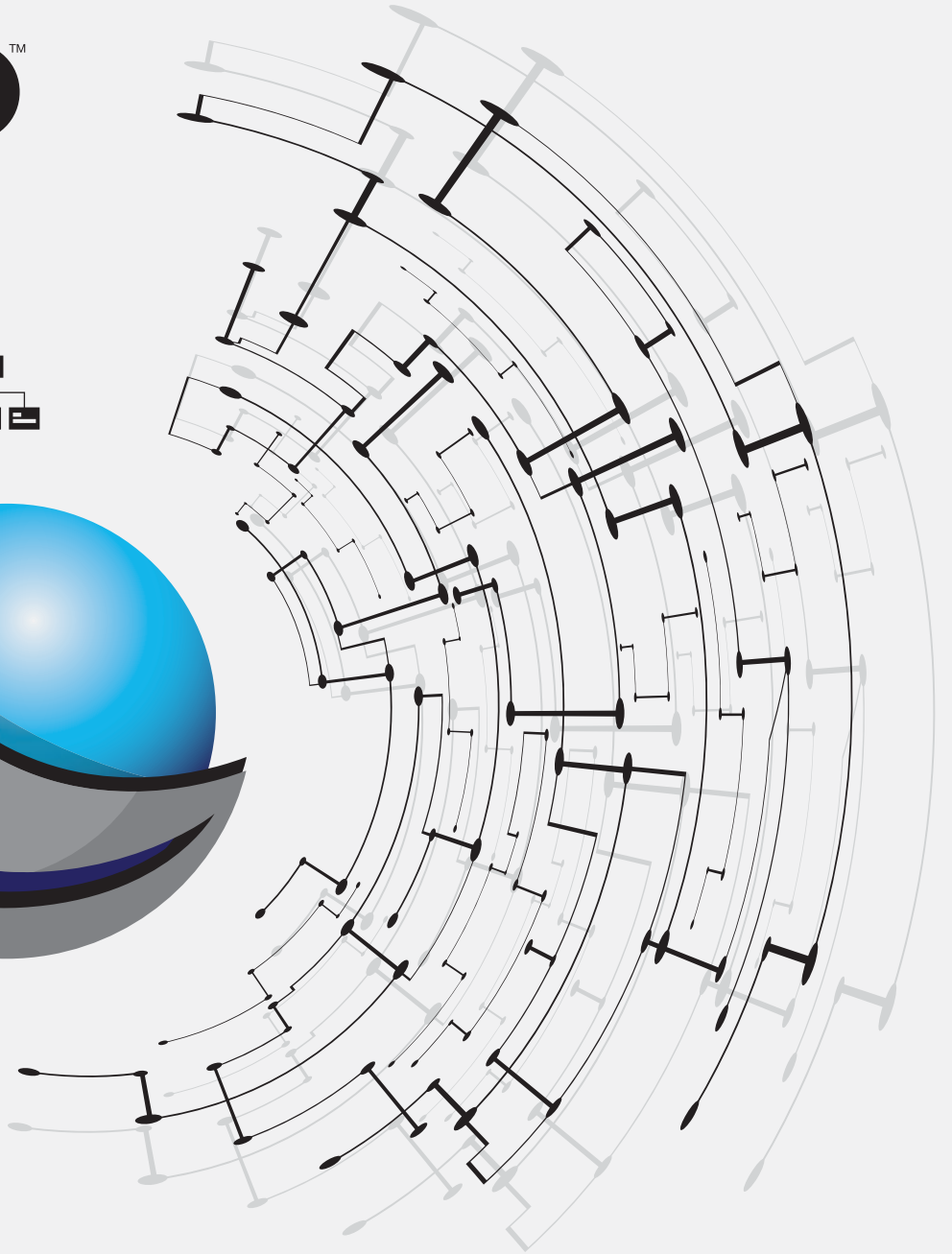
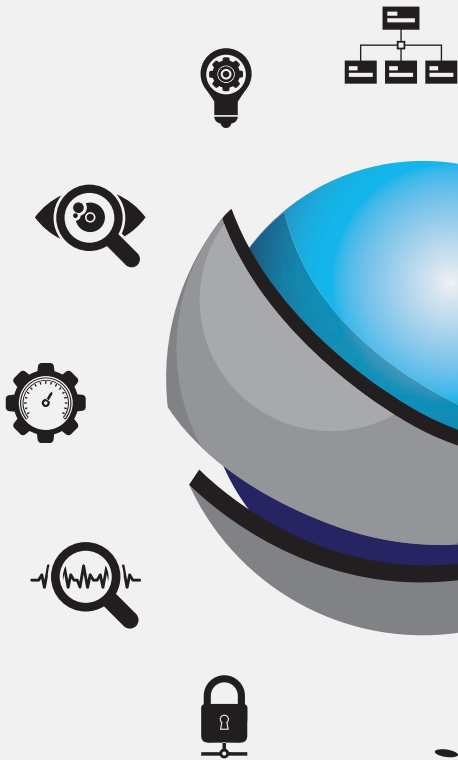

**Digitally access and leverage product data and knowledge
to connect systems and processes throughout
the entire manufacturing lifecycle.**

VISIT KENNAMETAL.COM/NOVO.

METALCUTTING SAFETY

IMPORTANT SAFETY INSTRUCTIONS

Read before using the tools in this catalog!

Projectile and Fragmentation Hazards:

Modern metalcutting operations involve high spindle and cutter speeds and high temperatures and cutting forces. Hot metal chips may fly off the workpiece during metalcutting. Although cutting tools are designed and manufactured to withstand high cutting forces and temperatures, they can sometimes fragment, particularly if they are subjected to over-stress, severe impact, or other abuse.

To avoid injury:

- Always wear appropriate personal protective equipment, including safety goggles, when operating metalcutting machines or working nearby.
- Always make sure all machine guards are in place.

Breathing and Skin Contact Hazards:

Grinding carbide or other advanced cutting tool materials produces dust or mist containing metallic particles. Breathing this dust or mist — especially over an extended period — can cause temporary or permanent lung disease or make existing medical conditions worse. Contact with this dust or mist can irritate eyes, skin, and mucous membranes and may make existing skin conditions worse.

To avoid injury:

- Always wear breathing protection and safety goggles when grinding.
- Provide ventilation control and collect and properly dispose of dust, mist, or sludge from grinding.
- Avoid skin contact with dust or mist.

For more information, read the applicable Material Safety Data Sheet provided by Kennametal and consult General Industry Safety and Health Regulations, Part 1910, Title 29 of the Code of Federal Regulations.

These safety instructions are general guidelines. Many variables affect machining operations. It is impossible to cover every specific situation. The technical information included in this catalog and recommendations on machining practices may not apply to your particular operation. For more information, consult the Kennametal Metalcutting Safety booklet, available free from Kennametal at 724 539 5747 or fax 724 539 5439. For specific product safety and environmental questions, contact our Corporate Environmental Health and Safety Office at 724 539 5066 or fax 724 539 5372.

Kennametal, the stylized K, DUO-LOCK, GOMILL, HARVI, HydroForce, KenCut, KenFeed, KOR, KOR5, KOR6, MaxiMet, NOVO, RSM II, and Stellite are trademarks of Kennametal, Inc. and are used as such herein. The absence of a product, service name, or logo from this list does not constitute a waiver of the Kennametal trademark or other intellectual property rights concerning that name or logo.

Android™ is a trademark of Google Inc.

App Store® is a registered trademark of Apple Inc., registered in the U.S. and other countries.

Google Play™ is a trademark of Google Inc.

Hardox® is a registered trademark of SSAB Technology AB Corporation.

Hastelloy® and Haynes® are registered trademarks of Haynes International, Inc. Corporation.

Hostalen™ is a trademark of Hoechst GmbH Corporation.

INCONEL® and NIMONIC® are registered trademarks of Special Metals Corporation.

LEXAN® is a registered trademark of Sabic Innovative Plastics IP B.V. Company.

MAKROLON® is a registered trademark of Covestro Deutschland AG.

Polystyrol® is a registered trademark of BASF SE.

SAFE-LOCK® is a registered trademark and Safe-Lock™ is a trademark of Haimer GmbH.

Weldon® is a registered trademark of Weldon Tool Company.

©2022 Kennametal Inc. All rights reserved.



MASTER CATALOG

WORLD HEADQUARTERS

Kennametal Inc.

525 William Penn Place | Suite 3300
Pittsburgh, PA 15219 USA
Tel: 1 800 446 7738
ftmill.service@kennametal.com

EUROPEAN HEADQUARTERS

Kennametal Europe GmbH

Rheingoldstrasse 50
CH 8212 Neuhausen am Rheinfall
Switzerland
Tel: +41 52 6750 100
neuhausen.info@kennametal.com

ASIA-PACIFIC HEADQUARTERS

Kennametal Singapore Pte. Ltd.

3A International Business Park
Unit #01-02/03/05, ICON@IBP
Singapore 609935
Tel: +65 6265 9222
k-sg.sales@kennametal.com

INDIA HEADQUARTERS

Kennametal India Limited

CIN: L27109KA1964PLC001546
8/9th Mile, Tumkur Road
Bangalore - 560073
Tel: +91 080 22198444 or +91 080 43281444
bangalore.information@kennametal.com



kennametal.com