

# CNC Product Catalogue

You Ji Machine Industrial Company Limited  
The Leader of CNC Machine Tools



# CNC Product Catalogue

The Leader of CNC Machine Tools







# Company Profile

<b>Founded</b>	1978
<b>Capital</b>	US\$23 million (NT\$700 million)
<b>Managing Director</b>	Mr. Wang, Cheng-Jen (Massa Wang)
<b>Floor Space</b>	155,000m <sup>2</sup>
<b>Employees</b>	460 people (Taiwan), 250 people (China)
<b>Subsidiary</b>	You Ji Machine (China) Industrial Co., Ltd.
<b>Business Contents</b>	Design, production, marketing and service for CNC machine tools

With almost 40 years experience, You Ji has obtained customers' support in design and quality of machine. There are many machines to meet customers' different needs. Table diameter from Ø200 to Ø8000 mm. You Ji is the first machine manufacturer to have passed CE and EMC and to have begun sales in the European market, and is the biggest vertical lathe and floor borer manufacturer in Taiwan.

The cooperation between You Ji and other advanced machine manufacturers helps to upgrade the quality of You Ji products and provide customers the best and fastest service in the business.



## Enterprise Concept

### Service

You Ji is a global leader in machine tools with a sales network spanning the globe, offering a wide range of integrated technologies and services and providing speedy solutions to different markets.

### Design

R&D and design of You Ji's products are market-oriented and customer demand-based. Edge-cutting advanced technology is developed and utilized to manufacture products of high quality.

### Production

With enhanced work efficiency and product quality that meet ISO-9001 standards and the reinforced, smooth and standardized production process, each machine is made according to the strictest and highest quality standards.

### Sales

You Ji boasts a complete product line that encompasses lathes, milling machines, and specialized machines to satisfy diversified industrial production and manufacturing needs.

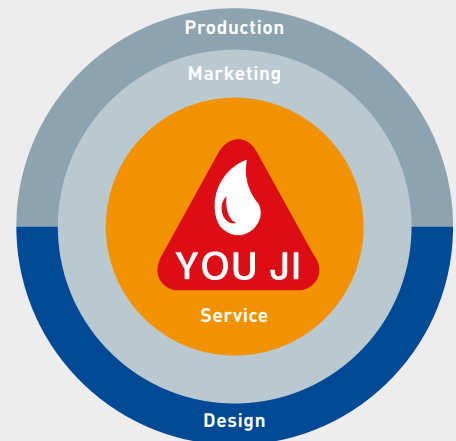

## Quality

Sincerity Responsibility Innovation



Quality Certification: ISO 9001:2008  
Standard: JIS,VDI/DGQ 3441, ISO-230



## Current Situation

- ✓ Ranked first on Taiwan Machine tools Industrial in 2009.
- ✓ Production capacity: 600 units of CNC Vertical Turning Lathes per year.  
Diameter of working table: Ø200mm~Ø8000mm
- ✓ Taiwan leading manufacturer of huge size Horizontal Machining Center.  
Size of working table: 2400mm×2600mm
- ✓ Taiwan leading manufacturer of huge size Horizontal Floor Type Boring and Milling Machine.  
X axis: 14m, Y axis: 6m

## International business scope

### Europe

WEBER / SOLVER / IRLAN Engineering / ABPLANALP / TDZ Turn, s.r.o. / TDZ Partners, s.r.o. JR-Machines Oy / MASKIN AB A. FRANSSON / FLEXTEK A/S / C DUGARD LTD / GIBAS NUMERIEK B.V. / TDZ Turn, s.r.o. / KOPP / WEMAS / TRANSTECHNIC / R.F.Celada S.p.a. / MAQUINSER / CSEPEL HOLDING Nyrt. / CMS MAKINE ve DANISMANLIK SANAYI VE TICARET LTD. STI. / RIMA CNC MASCHINEN AG / TECNO.team GmbH / PAM, LDA. / MAQUINSERtek Lda. /

### Africa

MACHINE TOOL PROMITIONS

### Asia

Rieckermann (Vietnam) Ltd. / P. PATTAKHET CO., LTD. / N-TECH MACHINERY CO., LTD. / PT. ADHIYAKSA DAYA SENTOSA / COSMOS IMPEX (INDIA) PVT.LTD / Advance Tech Machine Tools Sdn Bhd / Mixture Technology Sdn Bhd / JEP PRECISION ENGINEERING PTE LTD / HSIU FONG MACHINERY (S) PTE LTD / DYNAMIC TOOLING SERVICES / Trilogy Trading Corporation / NICKLAUS MACHINERY CORPORATION / NCM Ltd. / 株式会社オーマツト / 株式会社東陽

### North America And South America

ABSOLUTE MACHINE TOOLS INC. / CUBIC MACHINERY, INC. / AMERO PRECISION MACHINERY SA DE CV / EQUIPOS Y MAQUINARIA INDUSTRIAL / DEB'MAQ DO BRASIL / DW MAQUINARIA / TAI-MAX MACHINE TOOLS INC. / AVR TECNOLOGIA

### Taiwan

欣朋精機企業社 / 鉞鑫企業有限公司 / 睿華科技有限公司 / 松固機械五金有限公司 / 仲誼企業有限公司



# Company History

1978

Established at Bali township, Taipei, dedicated in manufacturing of single function machines, special purpose machines and boring machines.



1981

Headquarters moved to a new location at Lu-Zhu, Kaohsiung. Expanded production capacity.



1991

Developed medium-sized CNC vertical turning lathe YV series.



1992

Developed CNC horizontal turning lathe YH series. Added plant II to production facility lineup to produce YV and YH series. Export department established.



1993

Turnover was increased to NT\$50 millions.

1994

Established distributor networks in 20 countries.



1995

Capital increased to US\$3 million.

1996~7

Obtained CE and EMC certifications.



1998

Developed CNC vertical machining center VMC series.



1999

Developed CNC vertical turning lathe VTL series.



2000

Developed CNC reverse type turning lathe YR series.



2001

Developed the first multi-function vertical turning center in Taiwan.



2002

Developed twin spindle type vertical machining center VMC-1100-2S series.



2003

Developed twin spindle type vertical machining center VMC-1100-2S series.



2004

ISO9001 accreditation. Developed CNC horizontal machining center HMC series.



2005

Extended plant II, total acreage increased to 17,500m<sup>2</sup> (factory

2006

Developed APC system for VTL series. Cooperated with a world-famous bearing manufacturer to develop



2007

Developed Taiwan's largest heavy duty vertical turning center VTL-3000 and VTL-4000 series. Developed heavy duty flat-bed horizontal turning



2008

Developed heavy-load vertical turning center VTH series with high-end hydrostatic supporting technology. Developed multi-tasking gantry type machining center GMC series. Achieved US\$150 million in annual revenue.



2009

Ranked #1 in Taiwan's top 100 machine tools manufacturer and #576 of Taiwan's top 1000 enterprises. Developed floor type horizontal boring and milling machine HFB series



2010

Developed the largest vertical turning center in Taiwan - VTH-8000.



2011

Developed horizontal boring and milling machine HBM series.



2012

Headquarters moved to new site at Lu-Zhu, Kaohsiung.



2013

Award from Ministry of Economic Affairs, ROC for extraordinary contribution in overseas markets.

2014

Award from Ministry of Economic Affairs, ROC for extraordinary contribution in overseas markets.

2015

Developed side-head type vertical turning center VHL series, and received awards from The 12th Awards Ceremony of the Taiwan Machine Tool Industry Awards for excellence in research and innovation in TIMTOS 2015.



# YV Series

## Machine Definition

### YV1600ATC+C-APC

CNC Vertical Turning Lathe

Machine Model : 200, 250, 320, 420,  
500, 550, 600, 700, 800, 1000, 1200, 1600

A : Vertical Type Turret (250~1600)  
B : Gang Tool (200~320)  
C : Vertical Power Turret (320~500)  
E : Horizontal Type Turret (200~800)  
E+C : Horizontal VDI Power Turret (200~800)  
ATC : Automatic Tool Changer (500~1600)  
ATC+C : ATC + C-axis Function (500~1600)

APC : Automatic Pallet Changer (800~1600)



YV1000ATC+C



YV600AR/AL



YV320E



# Machine Specifications

		YV200	YV250	YV320	YV420	YV500	YV550	YV600	YV700	YV800
Chuck size	inch	Ø8"	Ø10"	Ø12"	Ø15"	Ø15"	Ø18"	Ø24"	Ø24"	Ø24"
Max. swing diameter	mm	Ø400	Ø500	Ø600	Ø700	Ø750	Ø800	Ø850	Ø900	Ø1000
Max. turning diameter	mm	Ø250	Ø350	Ø450	Ø500	Ø550	Ø650	Ø750	Ø800	Ø900
Max. turning height	mm	200	250	300	400	500	500	600	600	700
Max. loading weight	kg	200	300	500	500	1,200	1,200	1,800	1800	3,000
Spindle motor	kW	11/15	11/15	18.5/22	18.5/22	18.5/22	18.5/22	18.5/22	18.5/22	18.5/22
Spindle speed	rpm	50-3500	50-2500	50-2500	50-2500	50-2000	50-2000	20-1500	20-1500	10-600
Floor dimension	mm	2880x1530	2950x1530	2960x1770	2975x1935	3250x1900	3720x2330	4000x2330	4300x2450	3810x2590
Machine height	mm	2460	2480	2855	2845	3385	3395	4450	4120	4260

		YV200 ER/EL	YV250 AR/AL · ER/EL	YV320 AR/AL · ER/EL	YV500 AR/AL · ER/EL	YV600 AR/AL · ER/EL	YV800 AR/AL · ER/EL
Chuck size	inch	Ø8"	Ø10"	Ø12"	Ø15"	Ø24"	Ø24"
Max. swing diameter	mm	Ø400	Ø500	Ø600	Ø750	Ø850	Ø1000
Max. turning diameter	mm	Ø250	Ø350	Ø450	Ø550	Ø750	Ø900
Max. turning height	mm	200	250	300	500	600	700
Max. loading weight	kg	200	300	500	1200	1800	3000
Spindle motor	kW	11/15	11/15	18.5/22	18.5/22	18.5/22	18.5/22
Spindle speed	rpm	50-3500	50-2500	50-2500	50-2000	20-1500	10-600
Floor dimension	mm	2880x1480	2920x1480	2960x1770	3500x1900	4000x2350	3800x2590
Machine height	mm	2460	2600	2845	3385	4110	4200

## Tooling System



A type hex turret



B type gang tool



C type live tool turret



E type drum turret



ATC type



V.D.I turret

		YV1000	YV1200	YV1600
Chuck size	mm	Ø1000	Ø1250	Ø1600
Max. swing diameter	mm	Ø1350	Ø1600	Ø2000
Max. turning diameter	mm	Ø1100	Ø1350	Ø1800
Max. turning height	mm	900	1200	1200
Max. loading weight	kg	4,000	5,000	8,000
Spindle motor	kW	37/45	37/45	37/45
Spindle speed	rpm	1-600	1-350	1-250
Floor dimension	mm	4000x4800	4600x5200	5300x5500
Machine height	mm	4950	5400	5300

# TY Series

Machine Definition

## TY400H+C

CNC Vertical Turning Lathe

Machine Model : 400, 600,

H : Horizontal Turret

H+C : Horizontal BMT Power Turret



TY600H+C

CNC Vertical Turning Lathe

Space occupied  
30% less

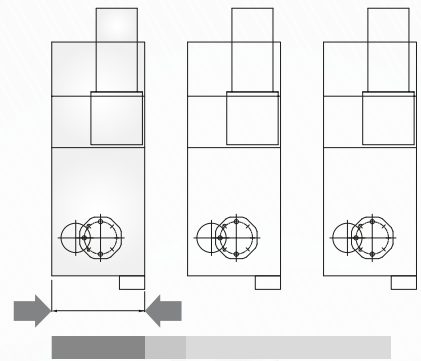

▲ The new TY model with 10" chuck

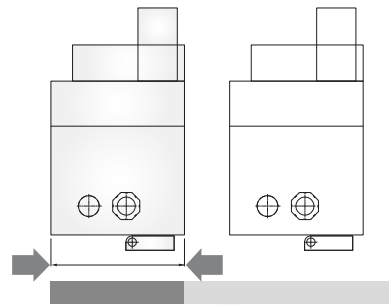

▲ Vertical lathe with 10" chuck

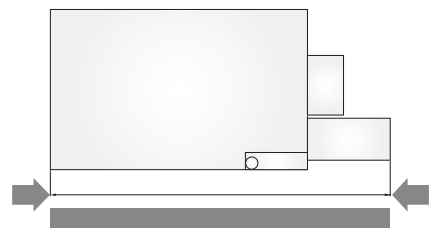

▲ Horizontal lathe with 10" chuck

## Machine Specifications

		TY400H	TY600H
Chuck size	inch	Ø10"	Ø12"
Max. swing diameter	mm	Ø400	Ø600
Max. turning diameter	mm	Ø250	Ø450
Max. turning height	mm	350	450
Max. loading weight	kg	300	500
Spindle motor	kW	18.5/22	18.5/30
Spindle speed	rpm	50~4000	50~3500
Floor dimension	mm	1030x3200	1300x3800
Machine height	mm	2600	3000

# CY Series

Machine Definition

## CY550H-APC

CNC Vertical Turning Lathe

Machine Model : 550

H : Horizontal Turret

APC : Automatic Pallet Changer



## Machine Specifications

		CY550H
Chuck size	inch	Ø15"
Max. swing diameter	mm	Ø700
Max. turning diameter	mm	Ø700
Max. turning height	mm	485
Spindle motor	kW	18.5/22
Spindle speed	rpm	50-2500
Floor dimension	mm	3300x2570
Machine height	mm	3200

CY550-APC



## Workpiece loading and unloading

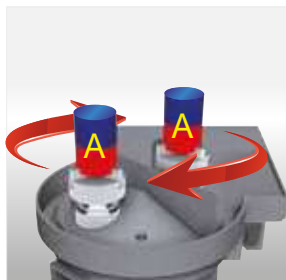

High production dual part set up

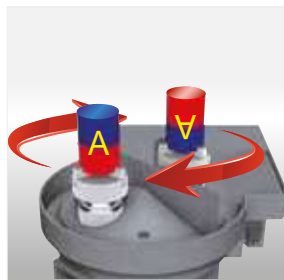

OP1 and OP2 parts set up

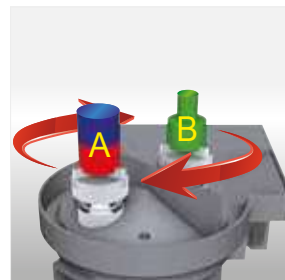

Mixed parts set up



# VTL Series

## Machine Definition

### VTL1600ATC+C-I-2R-APC

CNC Vertical Turning Lathe  
(Symmetric design for column & base)

Machine Model : 1000,1200,1600,2000,2500,3000,  
3500,4000,4500

ATC : Automatic Tool Changer

ATC+C : Automatic Tool Changer + C-axis Function

Column Height Increased : I, II

2R : Double RAM (1600 and upward)

APC : Automatic Pallet Changer (1000~2500)



VTL2500ATC+C



VTL4000ATC+C



VTL3000ATC+C-2R

## Machine Specifications

		VTL1000 ATC	VTL1200 ATC	VTL1600 ATC	VTL2000 ATC	VTL2500 ATC	VTL3000 ATC	VTL3500 ATC	VTL4000 ATC	VTL4500 ATC
Table diameter	mm	Ø1000	Ø1250	Ø1600	Ø2000	Ø2500	Ø3000	Ø3500	Ø4000	Ø4500
Max. swing diameter	mm	Ø1350	Ø1600	Ø2000	Ø2500	Ø3000	Ø3400	Ø4100	Ø4600	Ø5100
Max. turning diameter	mm	Ø1100	Ø1350	Ø1800	Ø2300	Ø2800	Ø3300	Ø3800	Ø4300	Ø4800
Max. turning height	mm	900	1200	1200	1600	1600	1700	1700	1600	1600
Max. loading weight	kg	4,000	5,000	8,000	10,000	15,000	20,000	20,000	30,000	30,000
Spindle motor	kW	37/45	37/45	37/45	60/75	60/75	60/75	60/75	100	100
Tool shank		BT-50	BT-50	BT-50	BT-50	BT-50	BT-50/BT-60	BT-50/BT-60	BT-50/BT-60	BT-50/BT-60
Spindle speed	rpm	1~600	1~350	1~250	1~200	1~160	1~120	1~120	1~60	1~60
Floor dimension	mm	4260x3850	5580x4260	5850x4510	6850x4650	7550x5130	11000x7000	12500x8500	12500x8500	13000x10500
Machine height	mm	4850	5400	5400	6270	6650	7400	7400	7400	7800

# VTS Series

## Machine Definition

### VTS1000ATC+C-2R-APC

CNC Vertical Turning Lathe(Fixed type cross-rail)

Machine Model : 1000, 1200, 1600, 2000, 2500, 3000,4000

ATC : Automatic Tool Changer

ATC+C : Automatic Tool Changer + C-axis Function

2R : Double RAM (1600 and upward)

APC : Automatic Pallet Changer (1000~2500)



VTS1600ATC+C

## Machine Specifications

		VTS1000 ATC	VTS1200 ATC	VTS1600 ATC	VTS2000 ATC	VTS2500 ATC	VTS3000 ATC	VTS4000 ATC
Table diameter	mm	Ø1000	Ø1250	Ø1600	Ø2000	Ø2500	Ø3000	Ø4000
Max. swing diameter	mm	Ø1350	Ø1600	Ø2000	Ø2500	Ø3000	Ø3600	Ø4800
Max. turning diameter	mm	Ø1100	Ø1400	Ø1800	Ø2300	Ø2800	Ø3400	Ø4500
Max. turning height	mm	800	800	800	800	800	1000	1000
Max. loading weight	kg	4,000	5,000	8,000	10,000	15,000	20,000	30,000
Spindle motor	kW	30/37	37/45	37/45	60/75	60/75	60/75	100
Tool shank		Capto C6	Capto C6	Capto C6	Capto C6	Capto C6	Capto C6	Capto C6
Spindle speed	rpm	1~600	1~350	1~250	1~200	1~160	1~120	1~60
Floor dimension	mm	7000x5230	7600x5330	8600x5500	9200x5600	9850x6035	11000x6500	11500x6900
Machine height	mm	5360	5550	5550	5930	5930	6800	6800

# VTH Series

Machine Definition

## VTH3000ATC+C-II-2R

CNC Vertical Turning Lathe(Hydrostatic table bearing)

Machine Model : 3000, 3500, 4000, 4500, 5000,  
6000, 7000, 8000

ATC : Automatic Tool Changer

ATC+C : Automatic Tool Changer + C-axis Function

Column Height Increased : I, II, III

2R : Double RAM



VTH4000ATC+C

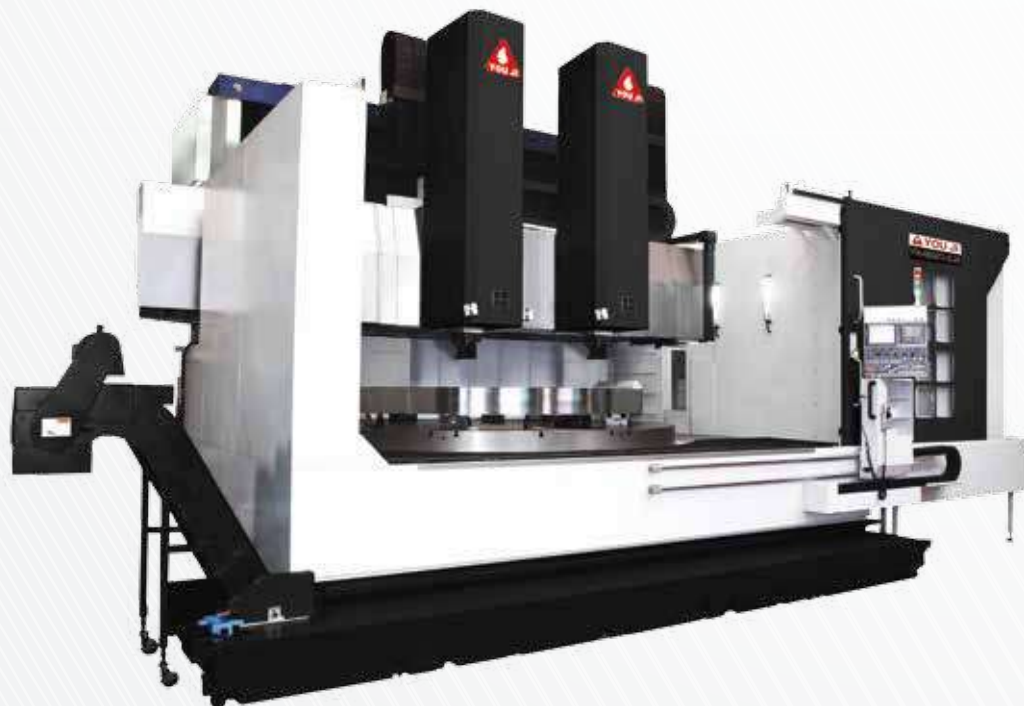

VTH4000ATC+C-2R



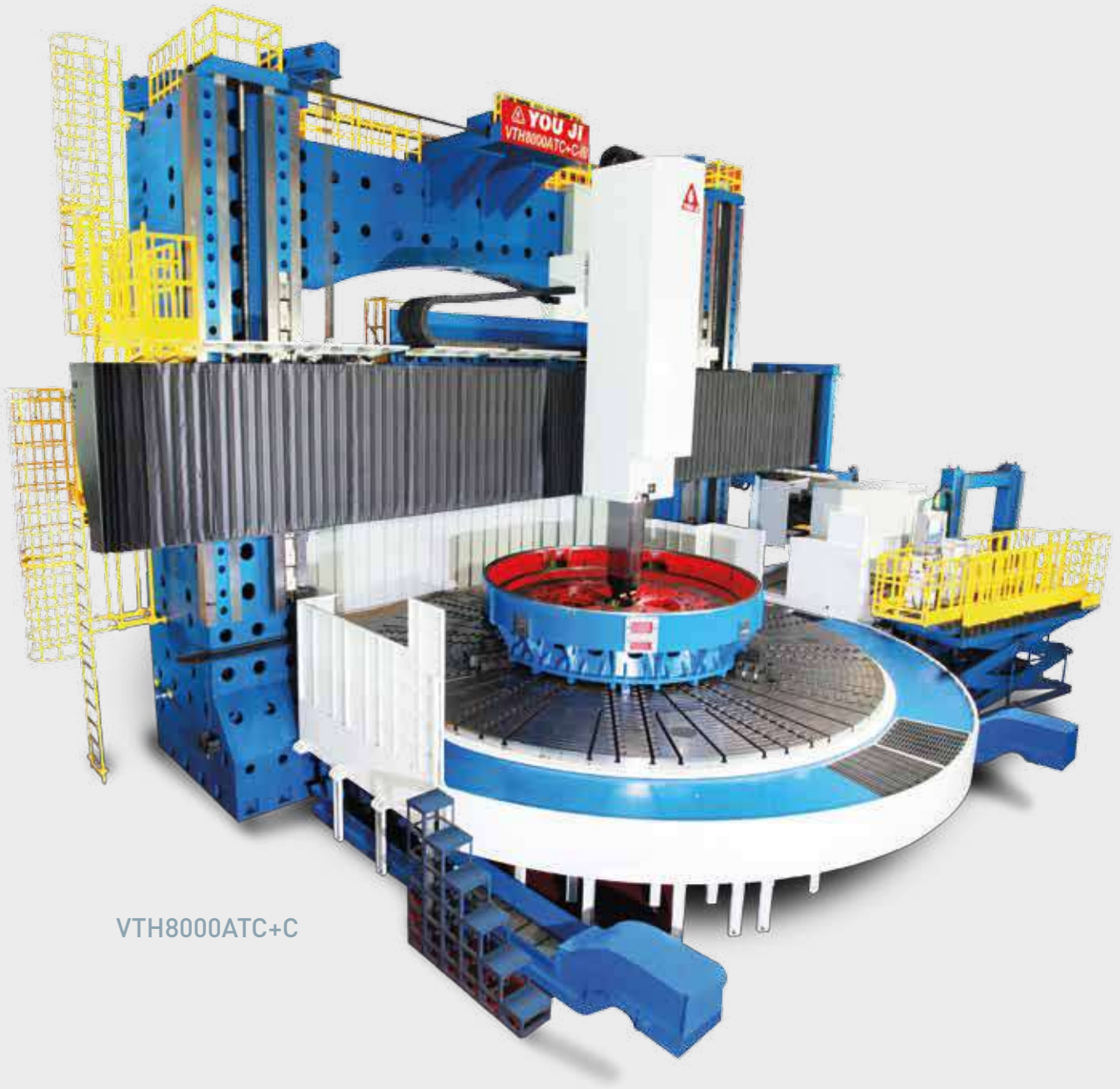

VTH8000ATC+C

## Machine Specifications

		VTH3000 ATC	VTH3500 ATC	VTH4000 ATC	VTH4500 ATC	VTH5000 ATC	VTH6000 ATC	VTH7000 ATC	VTH8000 ATC
Table diameter	mm	Ø3000	Ø3500	Ø4000	Ø4500	Ø5000	Ø6000	Ø7000	Ø8000
Max. swing diameter	mm	Ø3400	Ø4100	Ø4600	Ø5100	Ø6400	Ø7400	Ø9000	Ø9400
Max. turning diameter	mm	Ø3300	Ø3800	Ø4300	Ø4800	Ø5900	Ø6900	Ø8500	Ø8900
Max. turning height	mm	1700	1700	1600	1600	2100	2100	2600	2600
Max. loading weight	kg	45000	45000	60000	60000	100000	150000	250000	300000
Spindle motor	kW	60/84	60/84	100/140	100/140	60/84x2	60/84x2	100/140x2	100/140x2
Tool shank		BT-50/BT-60	BT-50/BT-60	BT-50/BT-60	BT-50/BT-60	BT-50/BT-60	BT-50/BT-60	BT-50/BT-60	BT-50/BT-60
Spindle speed	rpm	1~75	1~75	1~75	1~60	5~40	3~25	3~20	3~20
Floor dimension	mm	13000x8500	14500x9600	14500x9600	15000x10000	18000x11500	18000x12500	21000x15000	21000x15000
Machine height	mm	7400	7400	7400	7400	9700	9700	10400	10400

# VHL Series

## Machine Definition

### VHL1200ATC+C-II

CNC Vertical Turning Center  
With Side Head

Machine Model : 1200,1600,2000

ATC : Automatic Tool Changer  
ATC+C : Automatic Tool Changer  
+ C-axis Function

Column Height Increased : I, II



VHL1200ATC+C-II

## Machine Specifications

			VHL1200ATC	VHL1600ATC	VHL2000ATC
Main	Table diameter	mm	Ø1250	Ø1600	Ø2000
	Max. swing diameter	mm	Ø1600	Ø2000	Ø2500
	Max. turning diameter	mm	Ø1350	Ø1800	Ø2300
	Max. turning height	mm	1200	1200	1600
	X1-axis travel	mm	-600, +875	-600, +1050	-600, +1350
	Z1-axis travel	mm	900	900	950
	Vertical travel of crossrail	mm	800	800	1150
	Spindle motor	kW	37/45(α40i)	37/45(α40i)	60/75(α40i)
Side Head	X2-axis travel	mm	1720	1720	1720
	Z2-axis travel	mm	800	800	950
	Live spindle motor	kW	7.5/11(α8i)	7.5/11(α8i)	11/15(α12i)
Floor dimension		mm	10500x6000	12500x6200	14500x6500
Machine height		mm	5500	5500	6500

# HV Series

## Machine Definition

### HV320

CNC Vertical Turning Lathe  
and Inverted Spindle Lathe

Machine Model : 320



HV320

## Machine Specifications

		HV320 Inverted Spindle Lathe (OP1)	HV320 Vertical Turning Lathe(OP2)
Chuck size	inch	Ø15"	Ø15"
Max. swing diameter	mm	Ø600	Ø600
Max. turning diameter	mm	Ø450	Ø450
Max. turning height	mm	Ø300	Ø300
Spindle motor	kW	37/45	37/45
Turret type		10-st.[Capto C6]	10-st.[Capto C6]
Spindle nose		A2-11	A2-11
Spindle speed	rpm	50~1600	50~1600
Floor dimension	mm	5450x3800	
Machine height	mm	4400	



# YH Series

## Machine Definition

### YH36+C/200

CNC Horizontal Turning Lathe

Machine Model : 15, 21, 28, 36, 50

C : C-axis Function (YH21 and upward)

Max. Turning Length: 120~4000



YH36/200



YH15



YH21

## Machine Specifications

		YH15	YH21	YH28	YH36	YH50
Chuck size	inch	Ø6"	Ø8"	Ø10"	Ø15"	Ø18"
Max. swing diameter	mm	Ø250	Ø560	Ø680	Ø720	Ø800
Max. turning diameter	mm	Ø190	Ø416	Ø430	Ø600	Ø680
Max. Turning Length	mm	120	480	550 / 1050	750/1350/ 2000/3000	1500/2000/ 3000/4000
Bar capacity	mm	Ø42	Ø52	Ø74	Ø89	Ø114
Spindle motor	kW	7.5/11	9/11	18.5/22	37/45	37/45
Turret type		8-st.	10-st.	10-st.	10-st.	10-st.
Spindle nose		A2-5	A2-6	A2-8	A2-11	A2-11
Spindle speed	rpm	1~4000	1~4000	1~3000	1~2000	1~1500
Machine length	mm	2780	3525	3793~4180	5000~8010	5765~9320
Machine width	mm	1440	1680	1750~1940	2340~2510	2510
Machine height	mm	1685	1800	2010	2340	2340

# AH Series

## Machine Definition

### AH06/100

CNC Heavy Duty Horizontal Turning Lathe

Spindle Bore : 6",9",12"

Max. Turning Length: 1000, 2100, 3200



AH06/100

## 3-step gearbox

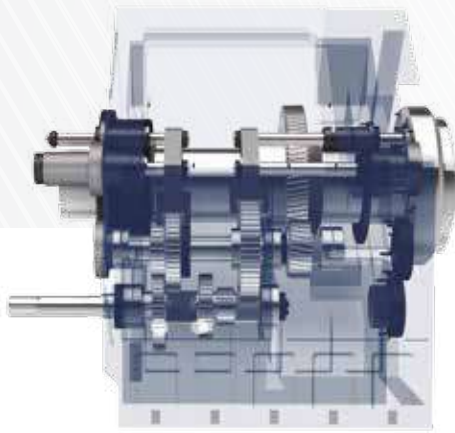

## Main structure

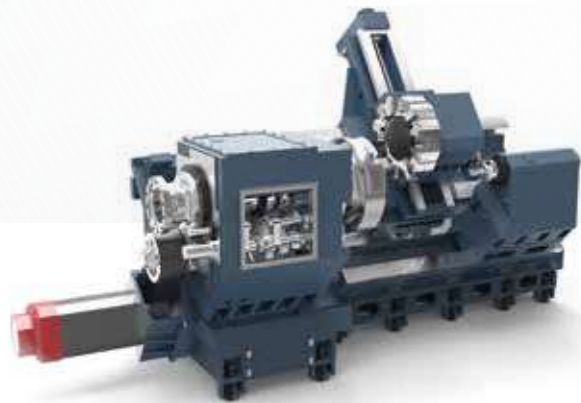

## Machine Specifications

		AH06						AH09						AH12					
		/100	/210	/320	/100M	/210M	/320M	/100	/210	/320	/100M	/210M	/320M	/100	/210	/320	/100M	/210M	/320M
Chuck size	mm	Ø690 Hydraulic						Option						Option					
Max. swing diameter	mm	Ø950						Ø950						Ø950					
Max. turning diameter	mm	Ø900		Ø800				Ø900		Ø800				Ø900		Ø800			
Max. Turning Length	mm	1000	2100	3200	1000	2100	3200	1000	2100	3200	1000	2100	3200	1000	2100	3200	1000	2100	3200
Bar capacity	mm	Ø153						Ø232 Manual / Ø205 Hydraulic						Ø306 Manual					
Spindle motor	kW	37/45						37/45						37/45					
Turret type		12-st.		12-st. (BMT75)				12-st.		12-st. (BMT75)				12-st.		12-st. (BMT75)			
Spindle nose		A2-15						A2-15						A2-20					
Spindle speed	rpm	1-230 / 230-620 / 620-1200						1-140 / 140-320 / 320-600						1-120 / 120-260 / 260-400					
Machine length	mm	5925	7025	8125	5925	7025	8125	5925	7025	8125	5925	7025	8125	5925	7025	8125	5925	7025	8125
Machine width	mm	2395						2395						2395					
Machine height	mm	2685						2685						2685					

# YB Series

## Machine Definition

### YB55 06/300HV

CNC Flat Bed Horizontal Turning Lathe

Max. Swing over Bed :

55" : 1400mm

63" : 1600mm

Spindle Bore:

06:6" (152.4mm) 20:20" (508mm)

14:14" (356mm) 32:32" (813mm)

Max. Turning Length:

300:3000mm 600:6000mm

400:4000mm 700:7000mm

500:5000mm 800:8000mm

HV: H8 Hydraulic Turret + V4 Hydraulic Turret

HL: H8 Hydraulic Turret

HLC: BMT Power Turret

VL: V4 Hydraulic Turret

H: H8 Hydraulic Turret

V: V4 Hydraulic Turret

YC: Y-axis Cross Slide + Capto Power Turret



YB55 06/400HV

## Selection of spindle and chuck

Unit: mm

No	Spindle diameter	Spindle speed		Spindle nose	Spindle bore	Option	
						4 jaws manual chuck	3 jaws hydraulic chuck
1	Ø220	1~1000	3 steps	A2-15	Ø152(6")	610(24")	610
						710(28")	800
						813(32")	-
2	Ø457.2	1~400	3 steps	A2-20	Ø356(14")	813(32")	-
						915(36")	-
						1000(40")	-
3	Ø580	1~250	3 steps	Ø600	Ø508(20")	1000(40")	-
						1250(49")	-
						1400(55")	-



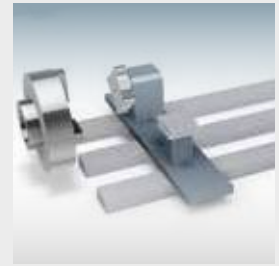

HV turret



HL(C) turret



VL turret

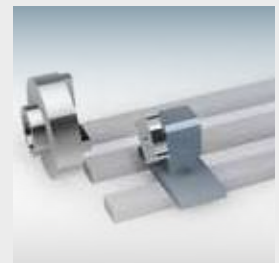

H turret

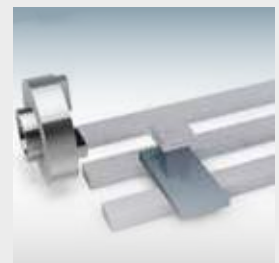

V turret



YC turret

## Machine Specifications

		YB55	YB63
Max. turning length	mm	3000/4000/5000/ 6000/7000/8000	3000/4000/5000/ 6000/7000/8000
Max. swing over cross slide	mm	Ø800	Ø1000
Max. swing over bed	mm	Ø1400	Ø1600
Max. turning over cross slide	mm	Ø800	Ø1000
Max. turning over bed	mm	Ø1100	Ø1300
Spindle motor	kW	37/45	37/45
Tailstock quill travel	mm	250	250
Machine length	mm	9380/10380/11380/ 12380/13380/14380	9380/10380/11380/ 12380/13380/14380
Machine width	mm	4000	4300
Machine height	mm	2950	3200

# VMC / VTM / VLM Series

## Machine Definition

### VMC850

CNC Vertical Machining Center

VMC : X/Y/Z-axis→Box Guide Way

VTM : X/Y-axis→Linear Guide Way, Z-axis→Box Guide Way

VLM : X/Y/Z-axis→Linear Guide Way

X-axis Travel: 850, 1100, 1350



VMC1100



VMC1350



## Machine Specifications

		VMC850	VMC1100	VMC1350	VTM850	VTM1100	VLM850	VLM1100
X-axis travel	mm	850	1100	1350	850	1100	850	1100
Y-axis travel	mm	600	600	700	600	600	600	600
Z-axis travel	mm	600	600	700	600	600	600	600
Spindle nose to table	mm	100-700		110-810	100-700		100-700	
Spindle speed	rpm	8000	8000	4500	8000	8000	8000	8000
Tool shank		BT-40	BT-40	BT-50	BT-40	BT-40	BT-40	BT-40
Table dimension	mm	1000x550	1260x550	1500x650	1000x550	1260x550	1000x550	1260x550
Floor dimension	mm	2450x3780	2450x4180	2950x4660	2450x3780	2450x4180	2450x3780	2450x4180
Machine height	mm	3030	3030	3300	3030	3030	3030	3030

# VM Series

## Machine Definition

### VM85-2S-APC

CNC Vertical Machining Center  
[X/Y/Z-axis → Box Guide Way]

X-axis Travel

2S : Double Spindle

APC : Automatic Pallet Changer



VM110-2S



VM110-2S-APC

## Machine Specifications

		VM85-2S	VM110-2S
X-axis travel	mm	460	620
Y-axis travel	mm	600	600
Z-axis travel	mm	600	600
Spindle nose to table	mm	100~700	100~700
Max. loading weight	kg	800	800
Spindle speed	rpm	6000	6000
Tool shank		BT-40	BT-40
Table dimension	mm	1000x550	1260x550
Floor dimension	mm	2450x3780	2450x4180
Machine height	mm	3030	3030



# TMV Series

## Machine Definition

### TMV600S

CNC Travelling Column Tapping Center

X-axis Travel : 600

T : Fixed Table

A : A-axis Rotary Table

A+B : A-axis + B-axis Rotary Table

S : Swing Table



TMV600S



Fixed Table



A-axis Rotary Table



A-axis + B-axis  
Rotary Table

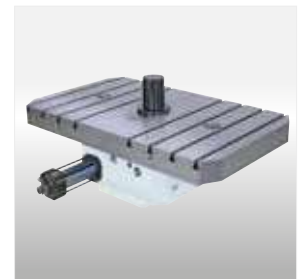

Swing Table

## Machine Specifications

### TMV600

		TMV600
X-axis travel	mm	600
Y-axis travel	mm	410
Z-axis travel	mm	460
Spindle nose to table	mm	220-680
Spindle speed	rpm	8000
Tool shank		BT-40
Table dimension	mm	700x450
Floor dimension	mm	2290x3170
Machine height	mm	2835

# GMC Series

## Machine Definition

### GMC1400A

CNC Gantry Type Machining Center

X-axis Travel : 1400

T : Fixed Table

S : Swing Table

A : A-axis Rotary Table

A+C : A-axis Rotary Table+C-axis Rotary Table



GMC1400A+C

CNC Gantry Type  
Machining Center

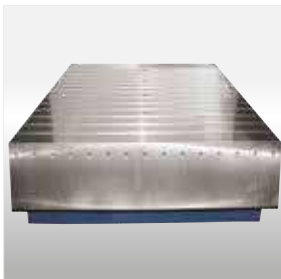

Fixed Table  
(1400x1500mm)

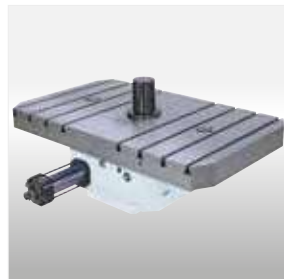

Swing Table  
(1200x1200mm)



A-axis Rotary Table  
(700x450mm)



A-axis + C-axis Rotary Table  
(Ø550mm)

## Machine Specifications

### GMC1400

Distance between columns	mm	2100
X-axis travel	mm	1400
Y-axis travel	mm	1400
Z-axis travel	mm	700
Spindle speed	rpm	10000
Max. loading weight	kg	5000
Floor dimension	mm	5100x3950
Machine height	mm	4300

# DCM Series

## Machine Definition

### DCM18/22

CNC Bridge Type Machining Center

Distance Between Columns:  
1800, 2500, 3000, 3500

Table Length: 2200~6000



DCM 18/22



DCM 25/60

## Machine Specifications

		DCM18	DCM25	DCM30	DCM35
Table dimension (LxW)	mm	2200 / 3200x1500	3000~6000x2000	3000~6000x2500	4000~6000x3000
Distance between columns	mm	1800	2500	3000	3500
X-axis travel	mm	2200/3200	3200/6200	3200/6200	4200/6200
Y-axis travel	mm	2000	2900	3860	3860
Z-axis travel (Opt.)	mm	750 (900)	750 (900)	900(1200)	900(1200)
Spindle speed (Opt.)	rpm	8,000 (10,000)	8,000 (10,000)	6000	6000
Max. loading weight	kg	8000 / 10000	13000/16000/18000/20000	16000/18000/20000/22000	18000/20000/22000



# MCR Series

## Machine Definition

### MCR25/40A

CNC Double Column 5-face Machining Center

Distance Between Columns:  
2500, 3000, 3500, 4000, 4500, 5000

Table Length: 3000~12000

W : Moveable Cross rail is driven by Servo Motor

A : Moveable Cross rail is driven by Hydraulic Motor

F : Fixed Cross rail



MCR25/40A

CNC Double Column 5-face Machining Center



Automatic Attachment Changer



High Rigidity Spindle

## Machine Specifications

		MCR25	MCR30	MCR35	MCR40	MCR45
Table dimension (LxW)	mm	3000-8000x2000	4000-8000x2500	5000-10000x3000	6000-12000x3500	6000-12000x4000
Distance between columns	mm	2500	3000	3500	4000	4500
X-axis travel	mm	3200-8200	4200-8200	5200-10200	6200-12200	6200-12200
Y-axis travel	mm	2900	3860	3860	5260	5260
Z-axis travel	mm	900(1200)	900(1200)	900(1200)	900(1200)	900(1200/1500)
W-axis travel (W/A type)	mm	780(1170/1560)	1170(1560/1950)	1170(1560/1950)	1170(1690/1950)	1560(1690/1950)
Spindle speed	rpm	3000(2500)	3000(2500)	3000(2500)	3000(2500)	3000(2500)
Max. loading weight	kg	13000-24000	16000-24000	20000-25000	22000-28000	30000-32000

# YM Series

## Machine Definition

### YM40H

CNC Horizontal Machining Center

40 : BT40

H : Fixture

A : A-axis Rotary Table

B : B-axis Rotary Table

A+B : A-axis Rotary Table + B-axis Rotary Table

BR : B-axis Rotary Table + Curved Coupling Orientation

BP : B-axis Rotary Table + Automatic Pallet Changer

BPR : B-axis Rotary Table + Automatic Pallet Changer

+ Curved Coupling Orientation

S : Swing Table



YM40



A : A-axis Rotary Table

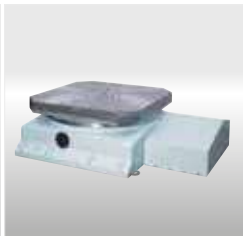

B : B-axis Rotary Table



A+B : A-axis + B-axis Rotary Table



BP : B-axis Rotary Table + Automatic Pallet Changer

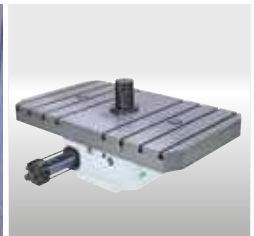

S : Swing Table

## Machine Specifications

### YM40

X-axis travel	mm	600
Y-axis travel	mm	500
Z-axis travel	mm	500
Spindle speed	rpm	10000
Number of tools	pcs	24
Max. tool length	mm	300
Tool shank		BT-40
Spindle motor	kW	7.5/11
Table dimension	mm	500x500
Floor dimension	mm	4758x1890
Machine height	mm	2770

# HMC Series

## Machine Definition

### HMC630B

CNC Horizontal Machining Center

Machine Model: 500, 630, 800, 1000, 1200, 1600, 2000, 2500

B : B-axis Rotary Table

BP : B-axis Rotary Table + Automatic Pallet Changer



HMC630BP

## Machine Specifications

		HMC500	HMC630	HMC800	HMC1000	HMC1200	HMC1600	HMC2000	HMC2500
X-axis travel	mm	800	1050	1300	1500	1800	2200	3000	3400
Y-axis travel	mm	750	750	1000	1000	1500	1500	1800	1800
Z-axis travel	mm	800	1000	1200	1200	1500	1500	1500	2000
W-axis travel	mm	N/A	N/A	N/A	600	700	700	700	700
Max. loading weight	kg	500	1,000	1,500	3,000	5,000	8,000	10,000	15,000
Spindle speed	rpm	8000	8000	6000	3500	3500	3500	3500	3500
Tool shank		BT-50	BT-50	BT-50	BT-50	BT-50	BT-50	BT-50	BT-50
Spindle motor	kW	15/18.5	15/18.5	22/26	22/26	22/26	30/37	30/37	30/37
Table dimension	mm	500x500	630x630	800x800	1200x1000	1400x1200	1600x1600	2200x1800	2600x2200
Floor dimension	mm	4000x3600	4500x3970	5250x4460	5600x4720	5870x5120	6830x5350	7000x6280	9670x6720
Machine height	mm	3100	3100	3660	3660	4560	4560	4660	4780



# HBM Series

## Machine Definition

### HBM130/3022

CNC Horizontal Boring and Milling Machine

Boring Spindle Diameter: 110, 130

X-axis Travel (30:3000mm)

Y-axis Travel (22:2200mm)



HBM110/2018

## Rotary Table

		HBM110	HBM130	HBM130	HBM130
Table Model		RT14/16	RT18/18	RT18/20 (Opt)	RT18/22 (Opt)
Table dimension	mm	1400x1600	1800x1800	1800x2000	1800x2200
Table swing diameter	mm	Ø2120	Ø2540	Ø2690	Ø2840
Work-piece swing diameter	mm	Ø2400	Ø2840	Ø3070	Ø3300
Max. table load	kg	10000	12000	12000	12000
T-Slot (size x pitch x No.)	mm	28x160x11	28x160x11	28x160x11	28x160x11
Rotation speed	rpm	2	2	2	2
X axis minimum travel (APC type)	mm	3000	3500	3500	3500



HBM130/2518



Manual Extension Milling Head



Manual 90° Extension Milling Head



Manual 90° Milling Head



Manual Universal Milling Head



Spindle Supporting Sleeve

## Machine Specifications

		HBM110	HBM130
Boring spindle diameter	mm	Ø110	Ø130
X-axis travel (Opt.)	mm	2000 (3000)	3000 (4000)
Y-axis travel (Opt.)	mm	1800	1800 (2300/2800)
Z-axis travel	mm	1250	1600
W-axis travel	mm	500	750
Spindle speed	rpm	3000	2500

# HFB Series

## Machine Definition

### HFB150/0530

CNC Horizontal Floor Type Boring and Milling Machine

Boring Spindle Diameter: 150

X-axis Travel (05:5000mm)

Y-axis Travel (30:3000mm)



## Floor Plate

FT25/20  
(HFB150 Series)

FT17/30  
(HFB180 Series)

		FT25/20 (HFB150 Series)	FT17/30 (HFB180 Series)
Table dimension	mm	2500x2000	1750x3000
Table thickness	mm	280	350

## Rotary and Traversable Table

		BR22/25	BR25/30	BR30/35	BR35/40	BR40/45
Table dimension	mm	2200x2500	2500x3000	3000x3500	3500x4000	4000x4500
Table swing diameter	mm	Ø3200	Ø3900	Ø4300	Ø5300	Ø6000
Max. loading weight	ton	25	40	60	80	100
V-axis travel	mm	1500	2000	2250	2500	2500

## Machine Specifications

		HFB150	HFB180
RAM cross section	mm	440x400	550x500
Spindle quill diameter	mm	Ø150	Ø180
X-axis travel	mm	4000/5000/6000/8000/10000/12000/14000	6000/8000/10000/12000
Y-axis travel	mm	3000/4000/5000	4000/5000/6000
Z-axis travel	mm	800	1100
W-axis travel	mm	750	900
Spindle speed	rpm	2500	2000



# DSM Series

## Machine Definition

### DSM480

CNC Double Sided Milling Machine

Machine Model: 480、630、800



DSM 800



DSM 480



C Frame DSM480

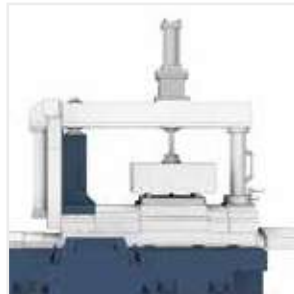

Gantry Type DSM630 / DSM800

## Machine Specifications

		DSM480	DSM630	DSM800
Width×Length of workpiece	mm	Ø20×20 ~Ø480×480	Ø30×30 ~Ø630×630	Ø40×40 ~Ø800×800
Max. thickness of workpiece	mm	150(cutter Ø160)	230 (cutter Ø250)	300 (cutter Ø315)
Table loading capacity	kg	1200	1500	2500
Travel of table X-axis	mm	600	1100	1300
Travel of head Z/Y-axis	mm	360	500	600
Clamping method		Hydraulic	Hydraulic	Hydraulic
Table Size	mm	400	520	650
Machine Weight	kg	10000	15000	18500
Machine Size W×L×H	mm	3410×3220×2330	4200×4300×2940	4300×5100×3000

# HW36

## Machine Specifications

HW36		
Chuck size	inch	Ø15
Max. swing diameter	mm	Ø740
Max. turning diameter	mm	Ø600
X-axis travel	mm	300+40
Z-axis travel	mm	760
Spindle speed	rpm	25-2500
Turret type		Horizontal
Floor dimension	mm	4800x2325
Machine height	mm	2200



HW36

# WHM500

## Machine Specifications

WHM500		
X-axis travel	mm	800
Y-axis travel	mm	700
W-axis travel	mm	500
Spindle speed	rpm	3500
Max. tool length	mm	260
Tool shank		BT-40
Floor dimension	mm	4560x2960
Machine height	mm	3345



WHM600

# WV Series



WV600E



WV600E2T

## Machine Specifications

		WV500E	WV550E	WV600E	WV500E2T	WV550E2T	WV600E2T	WV800E2T
Chuck size	inch	20"	22"	24"	20"	22"	24"	26"
Max. swing diameter	mm	Ø700	Ø750	Ø850	Ø700	Ø750	Ø850	Ø1000
Max. turning diameter	mm	Ø580	Ø605	Ø660	Ø580	Ø605	Ø660	Ø860
Max. turning height	mm	250	250	350	250	250	350	550
Spindle motor	kW	18.5/22	18.5/22	18.5/22	18.5/22	37/45	60/75	60/75
Turret type		Vertical	Vertical	Vertical	Vertical	Vertical	Vertical	Vertical
Spindle nose		A2-11	A2-11	A2-11	A2-11	A2-11	A2-11	A2-11
Spindle speed	rpm	20-2000	20-2000	20-1500	20-2000	20-2000	20-1500	50-1500
Floor dimension	mm	3300x2430	3300x2430	3350x2200	3300x2430	3900x2900	4350x3000	4350x3180
Machine height	mm	3600	3600	3600	3600	3600	3600	3600





*KEY to productivity*



**YOU JI**  
MACHINE IND. CO., LTD.



No.92, Huanqiu Rd., Zhuyuan Vil.,  
Luzhu Dist., Kaohsiung City 82142, Taiwan  
Tel: 886-7-695-2669  
Fax: 886-7-695-3301  
Email : youji@ms15.hinet.net

Distributor

