

# ***SPEEDIO***

**R450Xd1**

**R650Xd1**

Pallet Changing Compact Machining Center



# R

## Pallet changer model continues machining even during setup time

Equipped with a "QT table," Brother's original pallet changer that avoids lift-up motion, new CNC, and tool magazine with up to 40-tool capacity to improve productivity at every production site.

## Cutting Out the Waste *SPEEDIO*



R450Xd1



R650Xd1

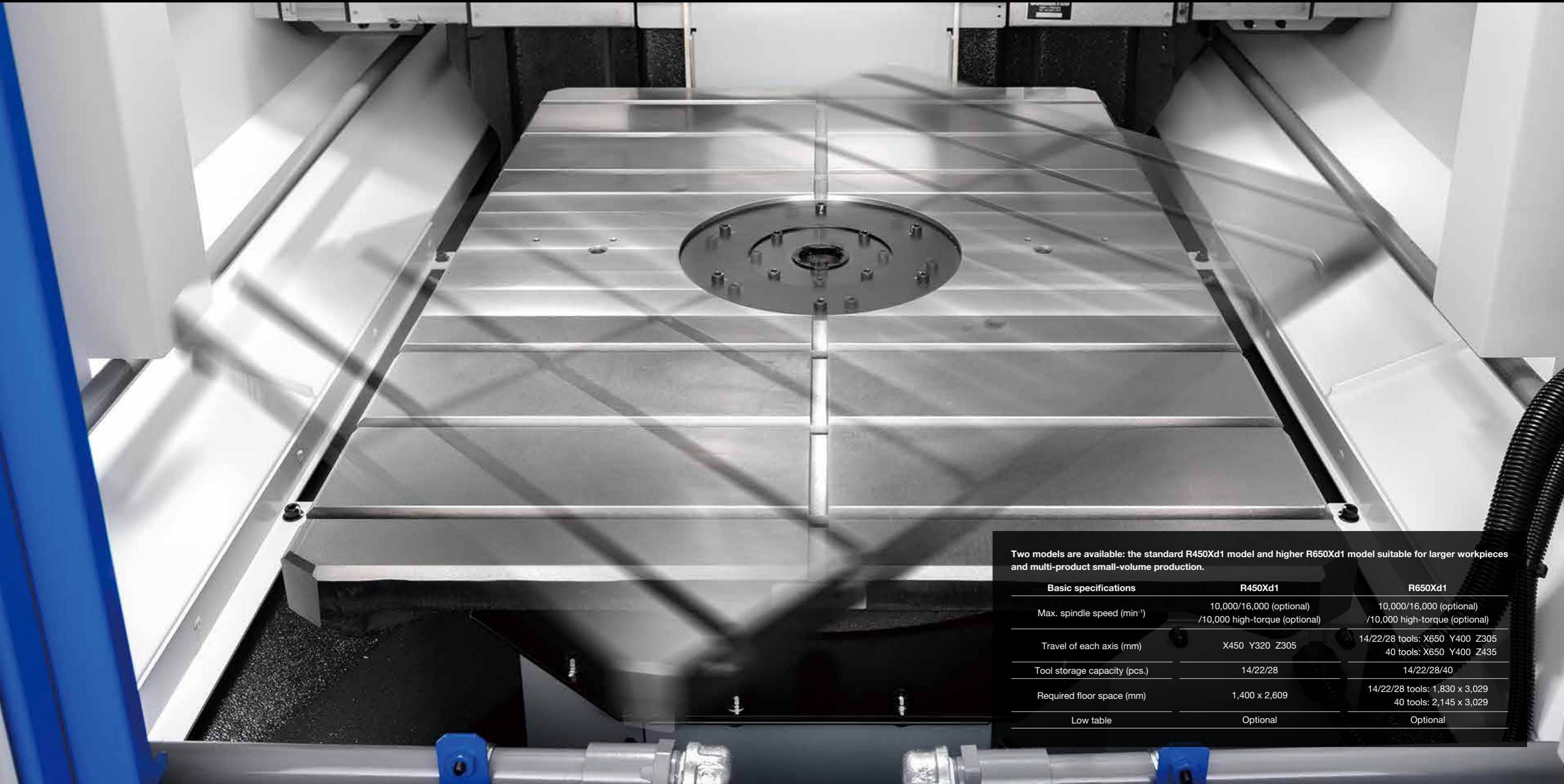

Two models are available: the standard R450Xd1 model and higher R650Xd1 model suitable for larger workpieces and multi-product small-volume production.

| Basic specifications                    | R450Xd1  | R650Xd1  |
|---|--|--|
| Max. spindle speed (min <sup>-1</sup> ) | 10,000/16,000 (optional)<br>/10,000 high-torque (optional) | 10,000/16,000 (optional)<br>/10,000 high-torque (optional) |
| Travel of each axis (mm)                | X450 Y320 Z305   | 14/22/28 tools: X650 Y400 Z305<br>40 tools: X650 Y400 Z435 |
| Tool storage capacity (pcs.)            | 14/22/28   | 14/22/28/40  |
| Required floor space (mm)               | 1,400 x 2,609  | 14/22/28 tools: 1,830 x 3,029<br>40 tools: 2,145 x 3,029   |
| Low table                               | Optional   | Optional   |

## Provides high productivity with a broad range of applications from mass production to multi-product small-volume production

While maintaining the SPEEDIO's high-speed performance and usability, extensive magazine specifications and a pallet changer provide high productivity for customers in various industries.

### Automobile



Aluminum wheel  
Aluminum alloy  
Size: ø550 x 200

### Precision equipment



Watch/clock plate  
Brass  
Size: ø25 x 2.6



L-shaped bracket  
Stainless steel  
Size: 95 x 85 x 35



Plate  
Stainless steel  
Size: 65 x 50 x 8



EV frame  
Aluminum alloy  
Size: 430 x 220 x 150



ABS valve housing  
Aluminum si<3%  
Size: 90 x 70 x 30

### Valve



Gas control valve  
Stainless steel  
Size: 75 x 35 x 35



Chemical control valve  
PFA resin  
Size: 200 x 55 x 75



Hot-water supply valve  
Brass  
Size: 150 x 120 x 90



Brake caliper  
Cast iron  
Size: 120 x 65 x 220



Yoke  
Carbon steel  
Size: 44 x 30 x 69

## QT table achieves high productivity, eliminating waste in workpiece change time

The QT table is Brother's original high-speed 2-face pallet changer.

With a wide jig area and a high degree of reliability, the QT table enables non-stop machining to achieve high productivity.

### High-speed pallet change

The QT (Quick Turn) table is a turntable type high-speed 2-face pallet changer. Optimized acceleration/deceleration control achieves much faster pallet change.

|                    |         |             |
|--------------------|---------|-------------|
| Pallet change time | R450Xd1 | 2.9s ▶ 2.7s |
|                    | R650Xd1 | 3.4s ▶ 3.1s |

### High reliability

To ensure high reliability, effects by chips etc. are minimized by a turntable that avoids lift-up motion and has a sealed structure, and positioning accuracy is maintained by the stopper mechanism.

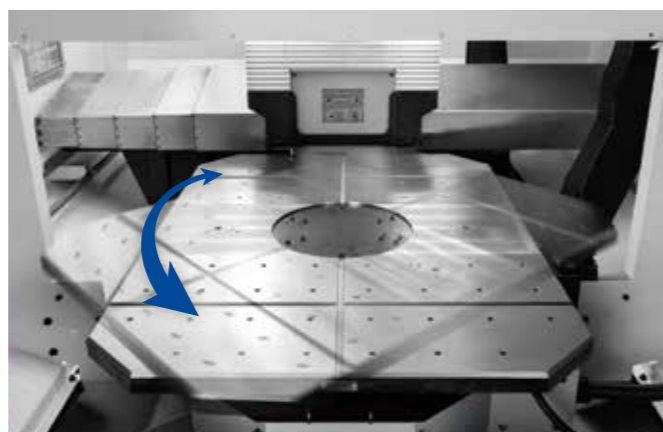

### Non-stop machining

Workpieces on one pallet can be changed while machining workpieces on the other pallet. Waste in workpiece change time is eliminated, enabling non-stop machining.

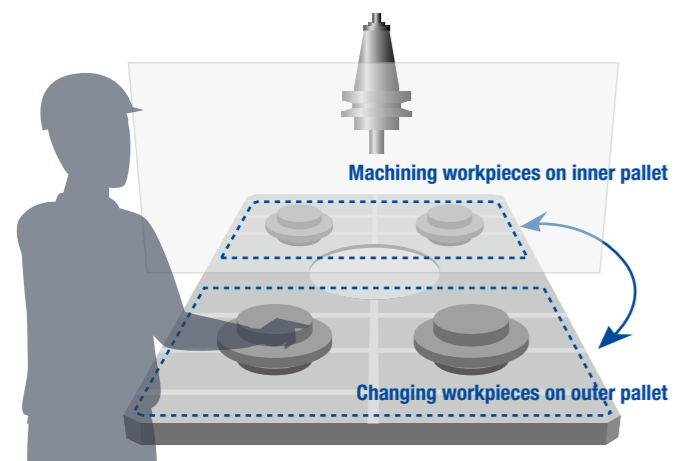
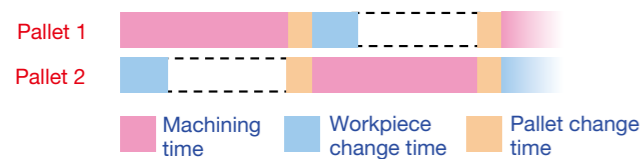

### Large jig area

Even if the jig protrudes from the table, it can be mounted as long as it is within the pallet turning diameter. The jig area can be further expanded by selecting a low table option that increases the jig height or a turning diameter enlargement option that increases the jig space.

### Low table (optional) increases jig height

|                 |         |           |         |           |
|-----------------|---------|-----------|---------|-----------|
| Max. jig height | R450Xd1 | 350 ▶ 380 | R650Xd1 | 420 ▶ 450 |
|-----------------|---------|-----------|---------|-----------|

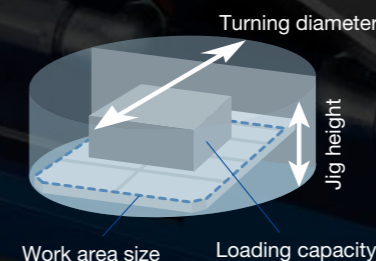
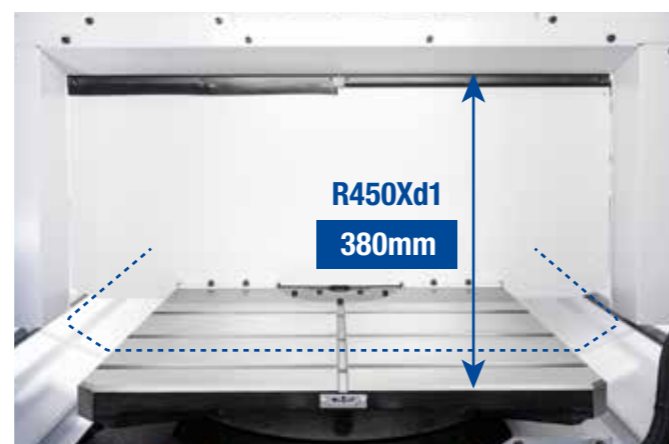

|                                    | R450Xd1     | R650Xd1     |
|------------------------------------|-------------|-------------|
| Work area size (mm)                | 600 x 300   | 800 x 400   |
| Max. turning diameter (mm) *1      | 1100 (1020) | 1300 (1250) |
| Max. jig height (mm) *2            | 380 (300)   | 450 (350)   |
| Max. loading capacity (kg/face) *3 | 200 (120)   | 300 (200)   |

\*1: When a turning diameter enlargement option is selected \*2: When a low table option is selected  
\*3: Parameter needs to be adjusted. \*4: Values in brackets ( ) indicate values for standard specifications.

## QT table achieves efficient production, utilizing advantages of pallet changer

The QT table eliminates various types of waste generated at production sites, achieving stable and efficient production. The QT table ensures both productivity and quality, and enables flexible automation.

### Advantages of QT table

#### 1. Stable production

As workpieces are changed while machining workpieces on the inner pallet, stable production volume can be secured without being affected by any fluctuation in workpiece change time.

#### 2. Interruptions to operation

Effects on production are minimized even if interruptions to operation occur during production, such as workpiece box replacement and chip cleaning.

#### 3. Handling multiple machines

One operator can change workpieces for multiple machines without suspending production. This means one operator can handle multiple machines easily, leading to streamlining of production sites.

#### Not affected by interruptions to operation



#### Able to easily handle multiple machines

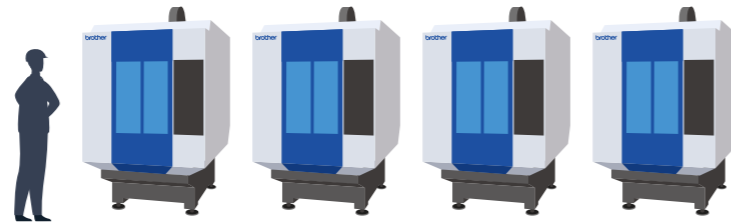

### Cases of streamlined production

#### Case 1: Long workpiece change time

High productivity can be maintained even when workpiece change takes time, such as in multi-part machining or when jig washing takes time to minimize effects of chips. Both the productivity and quality can be improved.

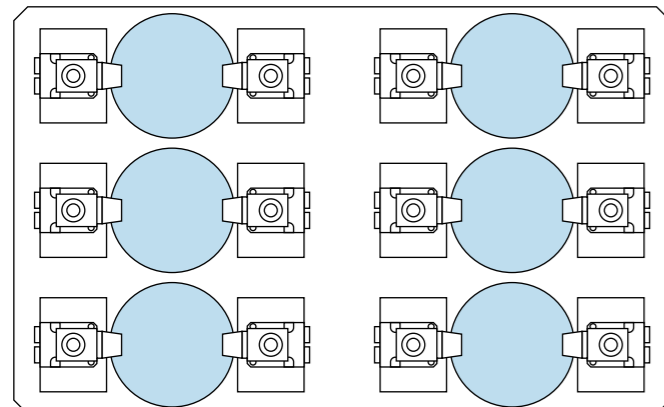

#### Case 2: Automation

Productivity is not affected even if workpiece setting or jig washing takes time. In addition, a flexible robot cycle, including peripheral equipment, can be configured.

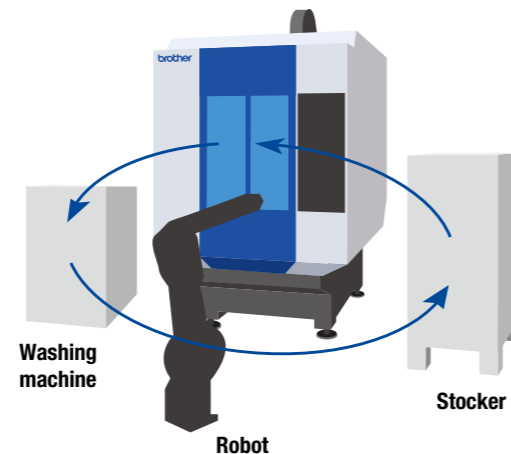

## Magazines with extensive variation

### Overwhelming high productivity through machine/controller integrated development

Including a newly developed 28-tool magazine, a 40-tool magazine with a maximum storage capacity is available in response to a variety of machining needs.

Overwhelming high productivity is achieved by utilizing advantages of machine/controller integrated development, including optimized and faster simultaneous operation and tool change operation.

#### 28-tool magazine

A new compact turret type 28-tool magazine has been developed with high-speed tool change performance maintained. This expands the range of target machining parts and promotes process integration.

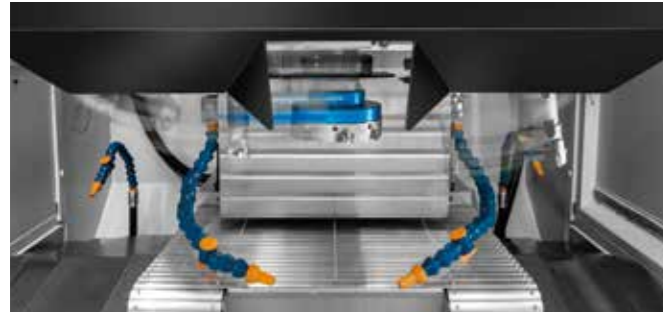

#### Simultaneous operation

Equipped with a simultaneous operation control that simultaneously performs tool change, QT table turn, and positioning of X/Y and additional axes. This avoids any wasted pallet change time.

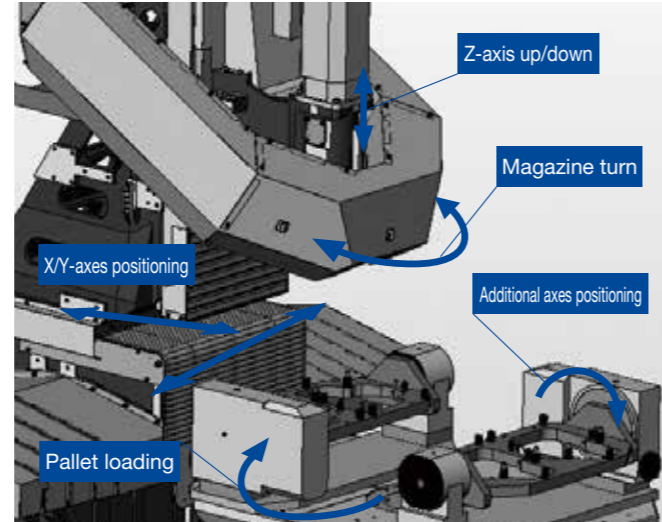

#### 40-tool magazine (R650Xd1)

In addition to 14/22/28-tool magazines, a 40-tool magazine is available. This promotes process integration, taking advantage of a 2-face pallet changer, and encourages productivity improvement.

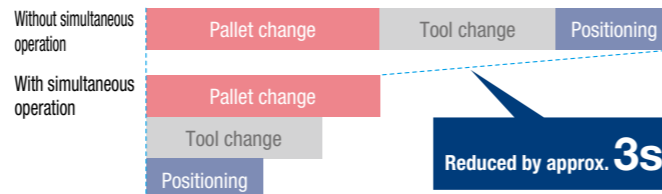

#### High acceleration/deceleration spindle

Using a low inertia and high acceleration/deceleration spindle motor enables the spindle to start or stop in an extremely short time.

**Spindle start/stop time 0.15s or less** \* High-torque specifications

For the 40-tool magazine, the machining room is separated from the tool stocker by a shutter type door. This prevents chips entering the magazine.



Pot shutter closed



Pot shutter open

#### High-speed tool change

Shorter tool change time has been achieved by faster and optimized spindle start/stop, Z-axis up/down, and magazine operation.

| Magazine capacity | Chip-Chip | Tool-Tool |
|-------------------|-----------|-----------|
| 14 tools (*1)     | 1.3s      | 0.6s      |
| 22/28 tools (*1)  | 1.5s      | 0.7s      |
| 40 tools (*2)     | 2.5s      | 0.9s      |

(\*1) Values for the R450Xd1 (\*2) Values for the R650Xd1

# Provides broad cutting performance from high-speed and highly efficient machining to heavy-duty machining

High rigidity based on a special design and use of a high-torque spindle motor achieves stable machining while demonstrating high machining capability.

## From heavy-duty machining to high-speed and highly efficient machining

A spindle motor with high torque in the medium- and high-speed range is used to achieve high-speed and highly efficient machining. In addition, the high-torque spec. (optional) machine greatly improves torque in the low-speed range. The machine provides excellent performance in heavy-duty machining of iron.

Motor torque characteristics

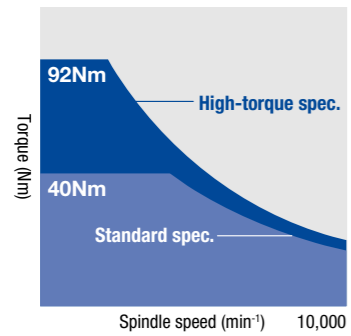

| High-torque spec. (optional) | Standard spec.            |
|------------------------------|---------------------------|
| Max. torque <b>92Nm</b>      | Max. torque <b>40Nm</b>   |
| Max. output <b>26.2kW</b>    | Max. output <b>18.9kW</b> |

## High-speed and highly accurate three-dimensional machining

In addition to the highly responsive servomotor, the servo processing speed and resolution have been greatly improved. Enhanced performance of original three-dimensional machining control, including a great increase in look-ahead blocks and improved surface quality by the smooth path offset function, achieves high-speed and highly accurate three-dimensional machining.

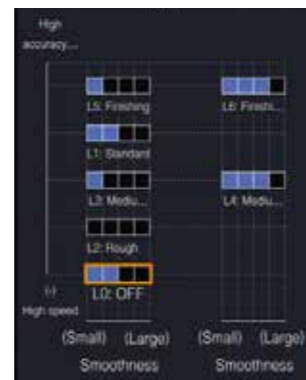

### Simple setting for high accuracy mode

Machining accuracy/surface quality parameters can be adjusted by simple operation. This helps achieve high-quality machining easily.

|                                   |                        |
|-----------------------------------|------------------------|
| High accuracy mode B1             | Look-ahead 160 blocks  |
| High accuracy mode BII (optional) | Look-ahead 1000 blocks |

## 7 MPa Coolant Through Spindle (CTS) (optional)

The CTS option can be selected from 3 MPa or 7 MPa. With this option, the machine can operate to its fullest potential in high-speed drilling or peck drilling.



## Highly rigid structure

Based on accumulated technical analysis data, a highly rigid machine structure with minimal vibration has been achieved to provide excellent cutting performance.

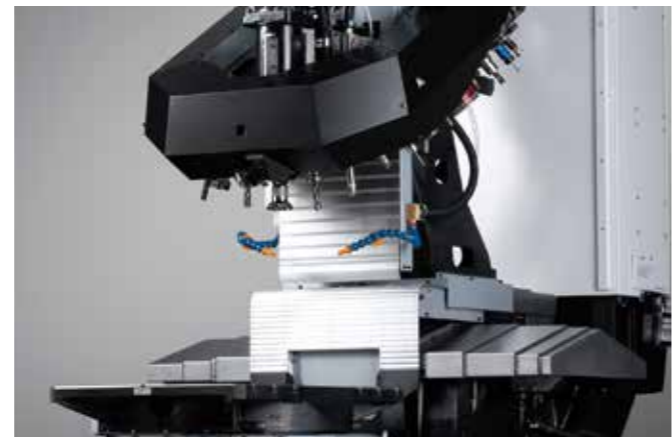

## Machining capability

|                 |                                      | ADC                      | Cast iron                 | Carbon steel              |
|-----------------|--------------------------------------|--------------------------|---------------------------|---------------------------|
| <b>Drilling</b> | 10,000min <sup>-1</sup>              | D32 × 0.2 (1.26 × 0.008) | D28 × 0.15 (1.1 × 0.006)  | D25 × 0.1 (0.98 × 0.004)  |
|                 | 10,000 min <sup>-1</sup> high-torque | D40 × 0.2 (1.57 × 0.008) | D34 × 0.15 (1.34 × 0.006) | D30 × 0.15 (1.18 × 0.006) |
|                 | 16,000min <sup>-1a</sup>             | D30 × 0.7 (1.18 × 0.03)  | D26 × 0.4 (1.02 × 0.02)   | D26 × 0.25 (1.02 × 0.01)  |
| <b>Tapping</b>  | 10,000min <sup>-1</sup>              | M27 × 3.0 (1-8UNC)       | M24 × 3.0 (7/8-9UNC)      | M16 × 2.0 (5/8-11UNC)     |
|                 | 10,000 min <sup>-1</sup> high-torque | M39 × 4.0 (1 1/2-6UNC)   | M33 × 3.5 (1 1/4-7UNC)    | M27 × 3.0 (1-8UNC)        |
|                 | 16,000min <sup>-1</sup>              | M22 × 2.5 (7/8-9UNC)     | M18 × 2.5 (5/8-11UNC)     | M14 × 2.0 (1/2-13UNC)     |
| <b>Facing</b>   | 10,000min <sup>-1</sup>              | 960 (58.6)               | 137 (8.4)                 | 81 (5.0)                  |
|                 | 10,000 min <sup>-1</sup> high-torque | 1,700 (102.4)            | 255 (15.6)                | 186 (11.4)                |
|                 | 16,000min <sup>-1</sup>              | 660 (40.3)               | 73 (4.5)                  | 48 (2.9)                  |

\* Data obtained from tests conducted by Brother.

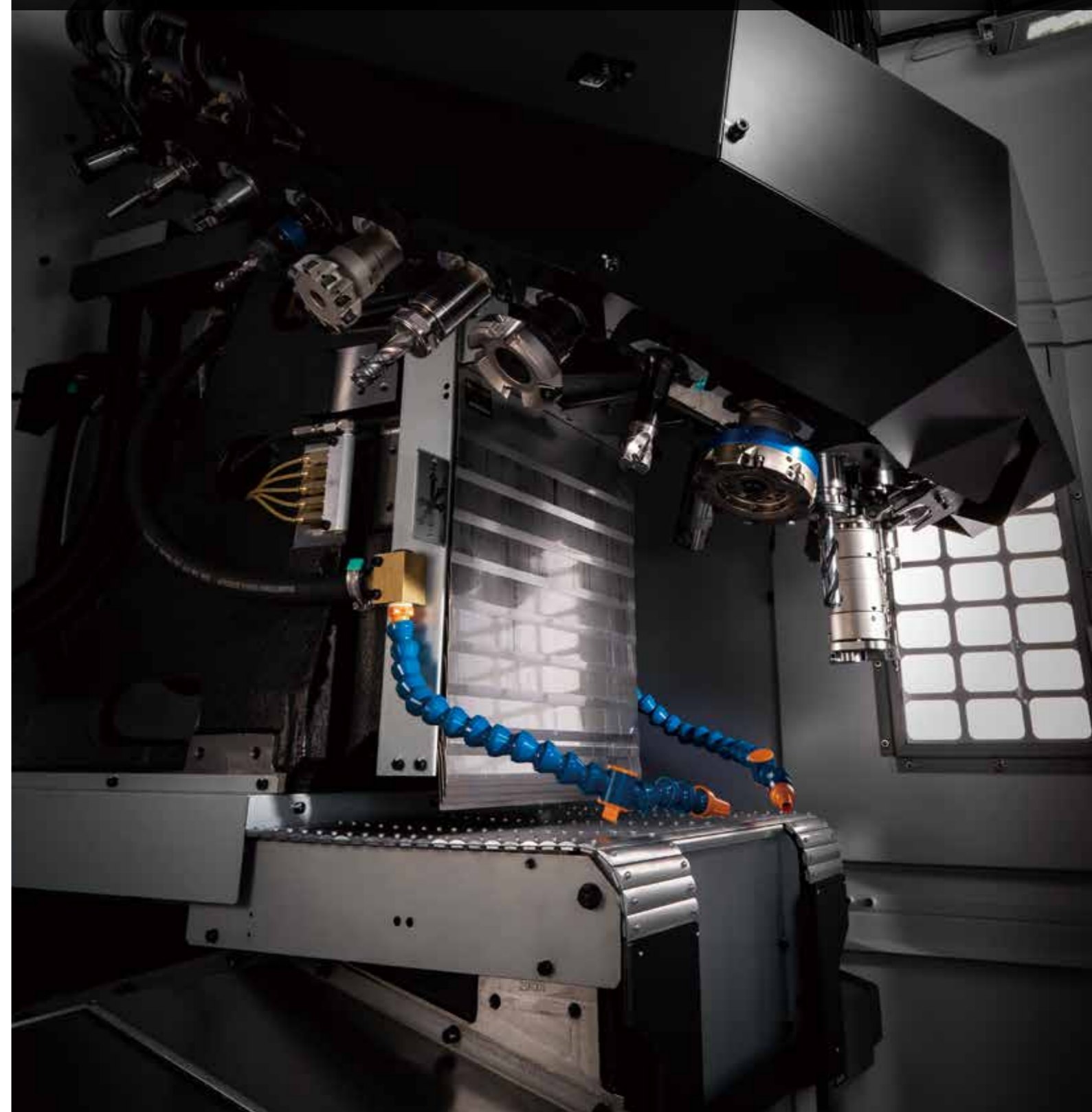

## Accessibility and operability have been enhanced to make pallet changer more access-friendly and setup easier

Accessibility and operability from the front and side of the machine have been enhanced so that operators can easily perform setup, such as workpiece change and tool change.

### Front setup accessibility

An access-friendly table is used so that operators can easily perform setup, including workpiece change.

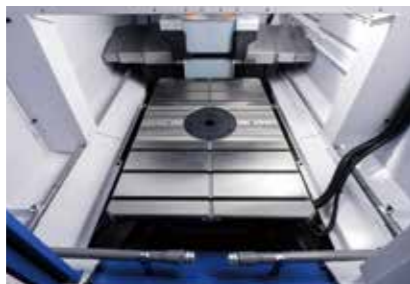

### Front wide opening width

A wide door opening width is secured to make workpiece change easier.



| Opening width |              |
|---------------|--------------|
| R650Xd1:      | <b>845mm</b> |
| R450Xd1:      | <b>655mm</b> |

### Side door for easy setup

The R450Xd1 (22/28 tools) and R650Xd1 are standard equipped with a side door.



### Column movement when changing tools

Equipped with a function that moves the column to a position where tools can be changed easily.



### Outside rotary table switch

The outside rotary table can be operated by this switch.

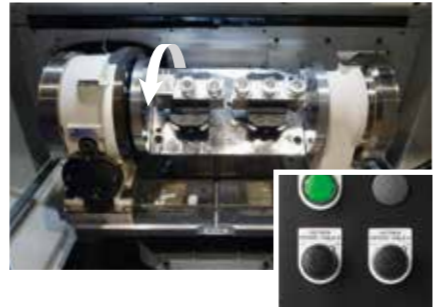

### Rotary table T-200Ad(optional)

Roller gear cam mechanism is used. A wider jig area can be secured due to the thin body. Using a support table (optional) enables a trunnion jig to be used.



#### Roller gear cam mechanism

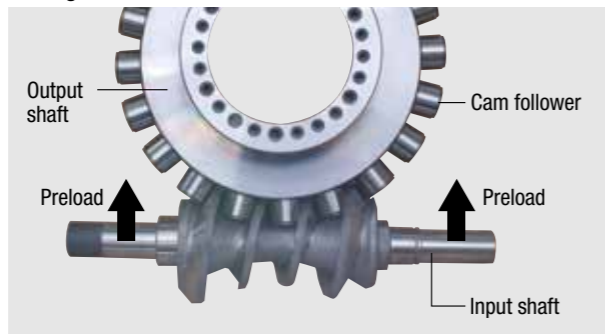

#### 0 to 180-deg. indexing time

|              |              |
|--------------|--------------|
| Clamp mode   | <b>1.02s</b> |
| Unclamp mode | <b>0.45s</b> |







# Equipped with new “CNC-D00” controller Enhanced usability with 15-inch LCD touch panel

Intuitive operation is possible with new apps and vertical touch panel screen. Relevant functions are grouped according to purpose, such as setup and machining, leading to efficient operation. Production and operation states are visualized, allowing faster understanding. Waste-free operation is possible in setup, machining adjustment, production, and recovery process, leading to improved work efficiency and operating rate.

### Home screen

Information required for production, such as workpiece counter and tool life, is collected on the home screen. Shortcut keys are provided for screens frequently used so you can open them by one touch.



Remaining/Elapsed machining time

Workpiece counter

Support apps/  
Shortcut keys

Screen keys

Program

Tool life

### New user interface

Usability has been greatly improved by grouping relevant functions, creating new support apps that are intuitive with improved operability and visibility, providing useful accessories (calculator, notebook, file viewer etc.), and making operation on conventional screens possible on the touch panel.



List of support apps



Conventional screen (position screen)

### Setup support

Equipped with functions to easily perform setup, such as an ATC tool app that enables all magazine tool settings to be performed on one screen, menu programming that enables you to create NC programs by following instructions on the screen, and an on-screen help function.



ATC tool app

### Machining adjustment support

Equipped with functions to easily perform optimal machining adjustment to improve productivity, such as a machining parameter adjustment app that enables you to easily adjust parameters according to machining details and a machining load waveform display/saving function.

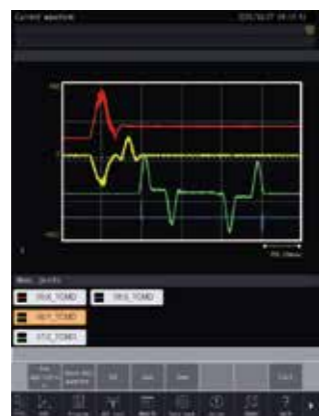

Waveform display app

### Production support

Equipped with functions to improve the operating rate, such as real time tool monitoring to eliminate defects, displaying production performance, power consumption etc. as a graph, and PLC/network functions to meet peripheral equipment and automation requirements.



Production performance app

### Recovery support

Equipped with functions to prevent failure or ensure quick recovery, such as maintenance time notice, displaying details when an alarm occurs, and guidance for recovery/check work.



Recovery support app

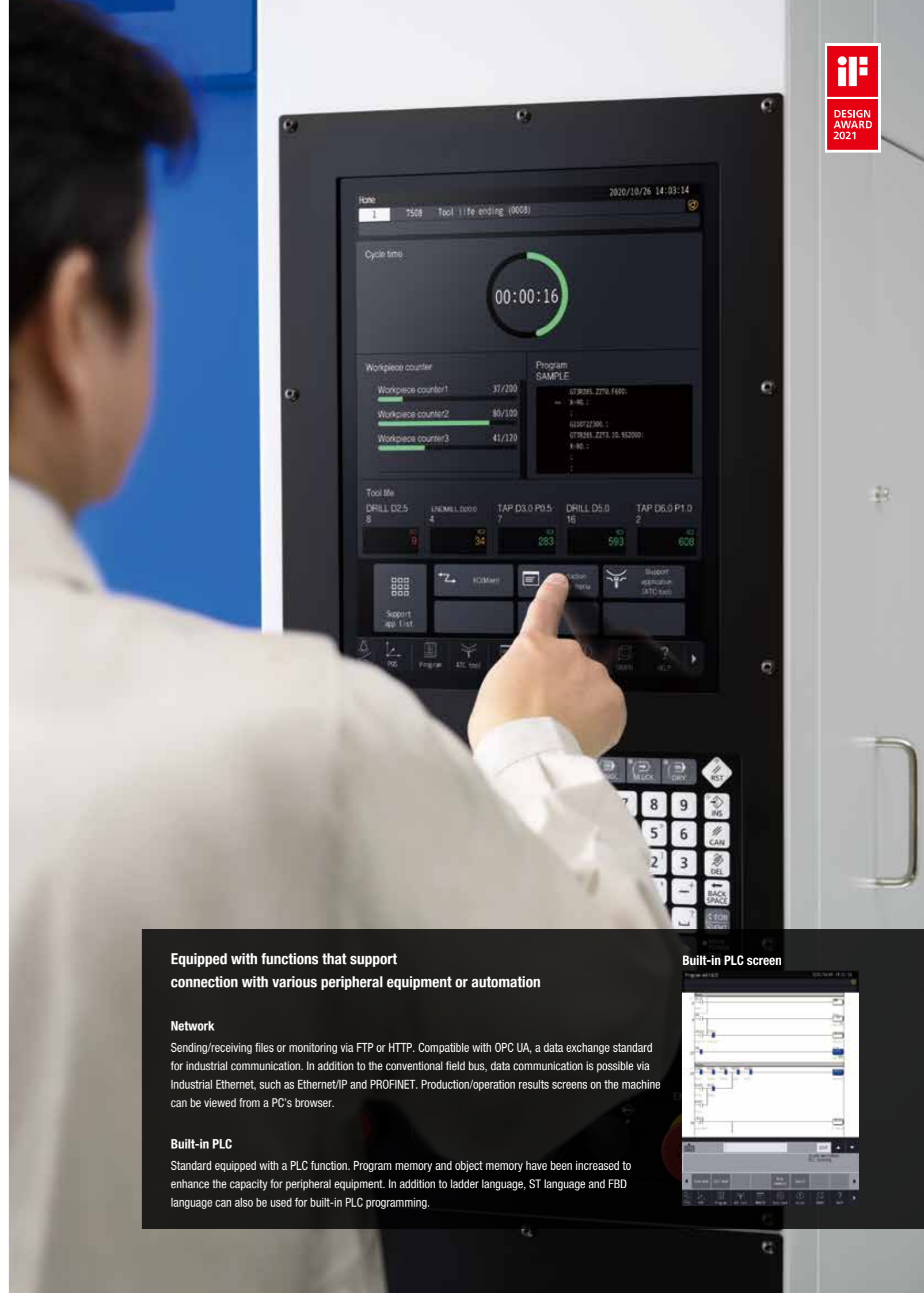

### Equipped with functions that support connection with various peripheral equipment or automation

#### Network

Sending/receiving files or monitoring via FTP or HTTP. Compatible with OPC UA, a data exchange standard for industrial communication. In addition to the conventional field bus, data communication is possible via Industrial Ethernet, such as Ethernet/IP and PROFINET. Production/operation results screens on the machine can be viewed from a PC's browser.

#### Built-in PLC

Standard equipped with a PLC function. Program memory and object memory have been increased to enhance the capacity for peripheral equipment. In addition to ladder language, ST language and FBD language can also be used for built-in PLC programming.

### Built-in PLC screen



## Reliability maintains high productivity

Measures for chips, including a center trough structure, and enhanced maintenance functions prevent machine failure.

Problem-free operation is ensured by reducing machining defects.

Avoiding machine stoppage maintains high productivity at production sites.

### Prevention of chip related problems

In response to increase in chips due to process integration, problems possibly caused by chips are prevented by thoroughly evacuating/removing chips, leading to improved reliability.

#### Center trough structure

A new center trough structure is used under the QT table. Chips slide down the inclined base and are discharged to the outside of the machine. Chip evacuation performance has been improved by almost two-fold.

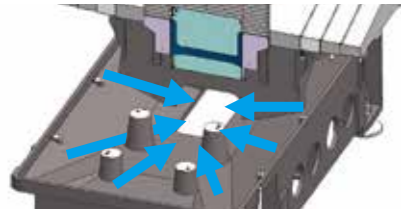

#### Chip conveyor tank, coolant tank with chute (optional)

Two types of coolant tanks are available: hinge and scraper type chip conveyor tank and coolant tank with chute where chips are flushed by coolant. Either can be selected depending on the purpose. Using these tanks can reduce chip cleaning frequency.



### Reliable maintenance functions

Equipped with a variety of maintenance functions to prevent defects that may occur at production sites or to assist recovery from problems.

#### ATC tool monitoring

The presence of a spindle tool, tool holder mis-clamp, tool key position deviation etc. are checked before and after tool change without using a sensor.



#### Machining load monitoring

Machining load applied to the spindle is monitored to issue an alarm when the load is not within the preset range.



#### Maintenance notice

Issues maintenance related notices in advance, such as greasing time.



#### Alarm log

Displays alarm log details to help identify the cause.



#### Chip shower (optional)

In response to a wide machining area, the R650Xd1 is equipped with two chip shower pumps to greatly increase the flow rate. Piping is added to the top face to improve chip evacuation performance.

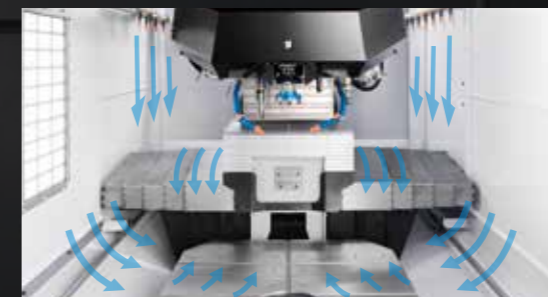

#### Tool washing, air-assisted type (optional)

Air-assisted high discharge pressure and discharge amount steadily remove chips attached to the tool taper. Stable washing power is achieved, without being affected by filter clogging. Expanding the pump capacity is not necessary, leading to higher energy saving.



## Striving to create earth-friendly machines

Our efforts to improve environmental performance and effects of high productivity greatly reduce power consumption, contributing to the carbon neutrality of plants.

### Low power consumption

In addition to the low inertia spindle and highly efficient spindle motor, the machine is equipped with various energy saving functions to lower power consumption.

#### Power regeneration system

Reuses the energy generated when the servomotor decelerates.

#### Power consumption app

Current and past power consumption can be checked.

#### Highly efficient spindle motor

#### Energy-saving pump

#### LED work light

#### Energy-saving NC functions

- Automatic coolant off
- Automatic work light off
- Standby mode
- Automatic power off



### Low air consumption

Air related functions have been reviewed and optimized to eliminate any waste, leading to reduction in air consumption.

#### Air purge

A highly airtight structure achieved through repeated flow rate analysis reduces the amount of air used.

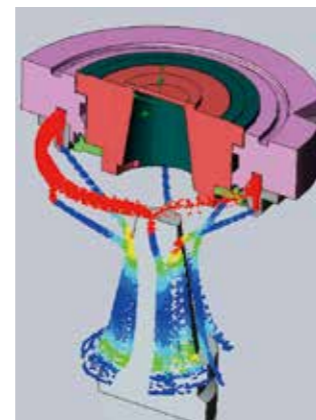

#### Spindle air blow

Amount of air used is reduced by discharging three times the conventional volume of air only when required.

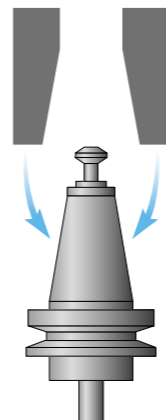

### Tank with cyclone filter and no consumables (special option for CTS)

Clean coolant is returned to the clean tank through another tank with a cyclone filter that removes fine chips. Coolant is kept clean this way to reduce the filter change frequency and extend the service life of the pump.

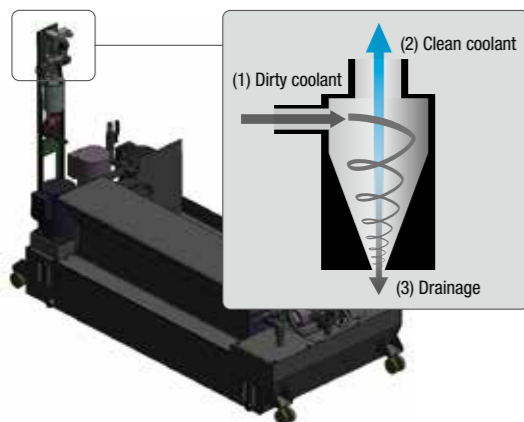

### Automatic oil/grease lubricator that optimizes consumption (optional)

Consumption amount and timing are optimized by the automatic oil/grease lubricator. Oil mixing with coolant can be minimized.

#### Automatic oil lubricator



#### Automatic grease lubricator



### Efforts for carbon neutrality

Brother will contribute to achieve a sustainable society through the development and sales of products with less environmental load and energy consumption.

#### Reduction in machining time

Compared to general M/Cs, machining time has been greatly reduced.

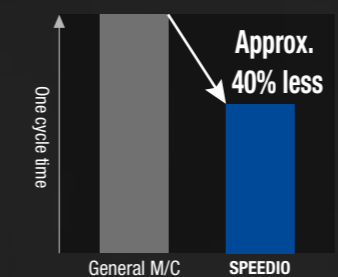

#### Reduction in power consumption

Compared to general M/Cs, power consumption has been greatly reduced.

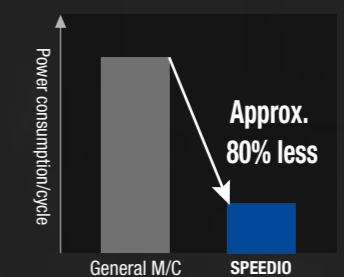

#### Reduction in air consumption

Compared to general M/Cs, air consumption has been greatly reduced.

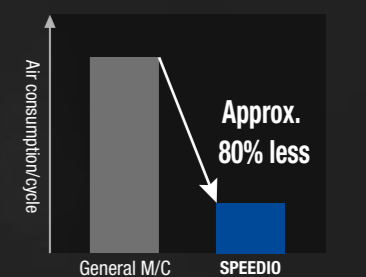



**Coolant tank**  
Two types are available: coolant tank with chute and hinge + scraper type chip conveyor tank. (The photo shows coolant tank with chute, 250L)



**Coolant Through Spindle (CTS)**  
Can be selected from 3.0 MPa or 7.0 MPa. Pump and tank are not included.



**Column coolant nozzle**  
Powerfully removes chips on and around the workpiece to prevent chips building up. \* Cannot be selected for the 40-tool magazine spec.

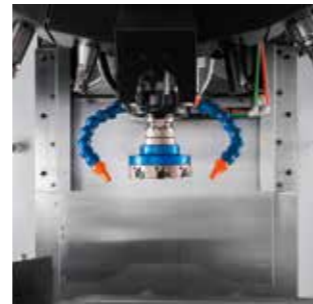

**Head coolant nozzle**  
Coolant can reliably be applied to the machining section as the tool and nozzles are set in place.



**Automatic oil lubricator**  
Regularly applies oil to all lubricating points on the tree axes.



**Automatic grease lubricator**  
Regularly applies grease to all lubricating points on the three axes. \*Manual greasing is required for the standard specification model.



**Automatic door with switch panel 10 holes**  
A motor-driven door is used, achieving smooth operation.



**Area sensor**  
Optical area sensors are used. Use area sensors to prevent operators being caught in the automatic door.



**Chip shower**  
Chip shower pipes are located at the upper section inside the machine for more efficient flow, and flexible shower nozzles can be directed to the side of the machine cover or sections where chips tend to accumulate.



**Tool washing, air-assisted type**  
High discharge pressure and flow rate efficiently remove chips attached to the holder. Equipped with a filter clog warning function.

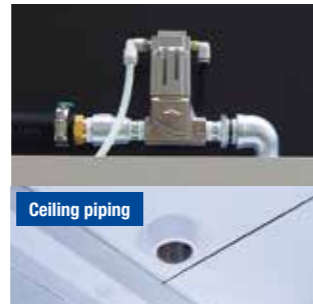

**Fixture shower valve unit**  
Consists of jig washing valves and pipes to the ceiling of the machine. Pipes from the machine to the required location must be prepared by customers.



**Cleaning gun**  
Helps clean the workpiece or chips inside the machine after machining.



**Switch panel (8 holes or 10 holes)**  
Various switches, such as automatic door open/close switches, are set in specific locations. The switch panel (8 holes) is also available so that the position of the manual pulse connector can be changed.



**Manual pulse generator**  
A cable is provided for the manual pulse generator, making setup easier. Equipped with emergency stop and enable switches.



**Tool breakage detector, touch type**  
A touch switch type tool breakage detector is available.

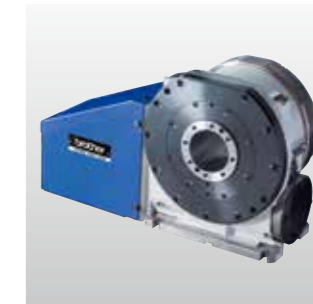

**Rotary table T-200Ad**  
Reduction in the body width secures a wider jig area. Use of the roller gear cam mechanism achieves high productivity, high accuracy, and extended service life.



**Hydraulic rotary joint (4 ports)**  
**Pneumatic relay box (12 ports)**  
12 pneumatic ports and 4 hydraulic ports have been prepared so that jigs that use pneumatic or hydraulic pressure can be mounted easily. \* For the R450Xd1, the Y-axis travel decreases when a hydraulic rotary joint is used.



**Turning diameter enlargement (R450Xd1: ø1,100, R650Xd1: ø1,300)**  
A wider jig area can be secured by enlarging the QT table turning diameter.

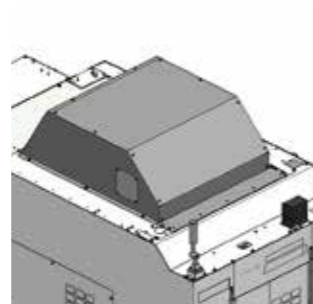

**Top cover**  
Shutting the opening on the top prevents coolant or chips splashing outside of the machine. A hole for the mist collector is provided.



**Side door with transparent window**  
Makes setup or tool change from the side easier. The machining room can be checked through the window. \* Standard for the R450Xd1 with 22/28-tool magazine and the R650Xd1.



**Spindle override**  
Spindle speed can be changed without changing the program.



**Outside rotary table switch**  
The outside rotary table can be operated by this switch. \* A switch panel (8 holes or 10 holes) is required separately.



**Master on circuit**  
Master on circuit and switch can be attached. \* A switch panel (8 holes or 10 holes) is required separately.

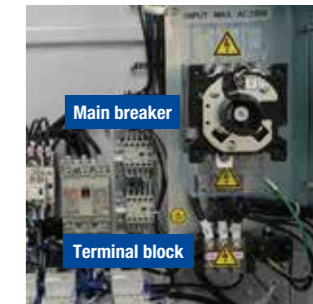

**Power supply expansion 50A**  
The capacity of the main breaker can be increased from 30A to 50A. The size of the relevant wiring increases accordingly. A terminal block for external equipment power supply is provided under the main breaker.



**Side cover with transparent window**  
External light is drawn in to make the inside of the machine brighter and improve visibility. \* For the R650Xd1, this option is installed on the right side when viewed from the front of the machine.



**Work light (1 or 2 lamps)**  
LED lamps are used to extend lamp life and save energy. \* For the R450Xd1, the 1st lamp is installed on the right side, and the 2nd lamp on the left side. For the R650Xd1, the 1st and 2nd lamps are both installed on the left side.



**Table light**  
Brightens the setup room. LED lamps are used to extend lamp life and save energy.



**Signal light (1, 2, or 3 lamps)**  
LED lamps are used. No maintenance required. Can be tilted to improve visibility.

- Coolant tank
- <R450Xd1>
- Coolant tank with chute, 150L
- Coolant tank with chute, 150L for 1.5 MPa CTS pump with cyclone filter
- Coolant tank with chute, 200L for 1.5 MPa CTS pump with cyclone filter
- <R650Xd1>
- Coolant tank with chute, 200L
- Coolant tank with chute, 200L for 1.5 MPa CTS pump with cyclone filter
- Coolant tank with chute, 250L
- Coolant tank with chute, 250L for 1.5 MPa CTS pump with cyclone filter
- <R450Xd1 and R650Xd1>
- Chip conveyor tank, 390L
- Chip conveyor tank, 390L for 1.5 MPa CTS pump with cyclone filter
- Coolant through spindle (CTS) piping, Max. 3.0 MPa
- Coolant through spindle (CTS) piping, Max. 7.0 MPa
- Column coolant nozzle
- Head coolant nozzle
- Chip shower
- Tool washing, air-assisted type
- Fixture shower valve unit
- Cleaning gun
- Mesh basket for collecting chips
- Hydraulic rotary joint (4 ports)

- Pneumatic relay box (12 ports)
- Turning diameter enlargement (R450Xd1: ø1,100, R650Xd1: ø1,300)
- Top cover
- Side door with transparent window, right side \* R450Xd1 only
- Side cover with transparent window (R450Xd1: Left side, R650Xd1: Right side)
- Work light (1 or 2 lamps)
- Table light
- Signal light (1, 2, or 3 lamps)
- Automatic oil lubricator
- Automatic grease lubricator
- Automatic door with switch panel 10 holes
- Area sensor
- Switch panel (8 holes or 10 holes)
- Front switch panel (10 holes) \* R650Xd1 only
- Manual pulse generator with enable switch
- Connector and hook for manual pulse generator with enable switch
- Tool breakage detector, touch type
- Rotary table T-200Ad
- Additional axis cable (for 1 axis, 2 axes, 3 axes, or 4 axes)
- RS232C 25-pin connector at control box
- Spindle override
- Outside rotary table switch (for 1 axis or 2 axes)
- Side magazine switch \* R450Xd1 only

- Outside start switch on the side \* R650Xd1 only
- Master on circuit
- Data protection switch, key type
- Grip cover for 14/21/28-tool magazine
- Folding door (two-door)
- Parts name sticker set
- Origin alignment mark
- Outlet in control box (100V)
- Power supply expansion 50A
- Transformer box
- Specified color
- EXIO board assembly
- 1) EXIO board, input 32/output 32, additional #1
- 2) EXIO board, input 32/output 32, additional #2
- PLC programming software for D00
- Industrial network
- 1) CC-Link, master station
- 2) CC-Link, remote device station
- 3) PROFIBUS DP, slave
- 4) DeviceNet, slave
- 5) PROFINET, slave
- 6) EtherNet/IP, slave
- Memory expansion 3 Gbytes

### Machine Specifications

| Item                 | R450Xd1/R450Xd1 RD *12  | R650Xd1/R650Xd1 RD *12   |  |
|----------------------|---|--|--|
|                      |   | 14/22/28 tool magazine   | 40-tool magazine   |
| CNC Unit             | CNC-D00   | CNC-D00  |  |
| Travels              | X axis mm(inch)   | 450 (17.7)   | 650 (25.6)   |
|                      | Y axis mm(inch)   | 320 (12.6) *7  | 400 (15.7)   |
|                      | Z axis mm(inch)   | 305 (12.0)   | 305 (12.0) 435 (17.1)  |
|                      | Distance between table top and spindle nose end mm(inch)                | 200~505 (7.9~19.9)[280~585 (11.0~23.0) *8]   | 250~555 (9.8~21.8) [350~655 (13.8~25.8) *8] 250~685 (9.8~27.0) [350~785 (13.8~30.9) *8]  |
| Table                | Work area size mm(inch)   | One face 600 x 300 (23.6 x 11.8)   | One face 800 x 400 (31.5 x 15.7)   |
|                      | Max. loading capacity (uniform load) kg(lbs)                            | One face 120 (265) [200(441) *6]   | One face 200 (441) [300 (661) *6]  |
|                      | Position time sec.  | 2.7 *11  | 3.1 *11 3.1 *11  |
| Spindle              | Spindle speed min <sup>-1</sup>   | 10,000min <sup>-1</sup> specifications: 1~10,000<br>16,000min <sup>-1</sup> specifications(optional): 1~16,000<br>10,000min <sup>-1</sup> high-torque specifications(optional): 1~10,000 | 10,000min <sup>-1</sup> specifications: 1~10,000<br>16,000min <sup>-1</sup> specifications(optional): 1~16,000<br>10,000min <sup>-1</sup> high-torque specifications(optional): 1~10,000 |
|                      | Speed during tapping min <sup>-1</sup>                                  | MAX. 6,000   | MAX. 6,000   |
|                      | Tapered hole  | 7/24 tapered No.30   | 7/24 tapered No.30   |
|                      | BT dual contact system(BIG-PLUS)  | Optional   | Optional   |
|                      | Coolant Through Spindle(CTS)  | Optional   | Optional   |
| Feed rate            | Rapid traverse rate(XYZ-area) m/min(inch/min)                           | 50 x 50 x 50 (1,969 x 1,969 x 1,969)   | 50 x 50 x 50 (1,969 x 1,969 x 1,969)   |
|                      | Cutting feed rate mm/min(inch/min)                                      | X, Y, Z axis : 1 *9 ~30,000 (0.04~1,181) *9  | X, Y, Z axis: 1~30,000 (0.04~1,181) *9   |
| ATC unit             | Tool shank type   | MAS-BT30   | MAS-BT30   |
|                      | Pull stad type *4   | MAS-P30T-2   | MAS-P30T-2   |
|                      | Tool storage capacity pcs.  | 14 / 22 / 28   | 14 / 22 / 28 40  |
|                      | Max. tool length mm(inch)   | 200 (7.9)  | 200 (7.9) 250 (9.8)  |
|                      | Max. tool diameter mm(inch)   | 80 (3.1)   | 80 (3.1) 55 (2.1) / 125 (4.9) No adjacent tool   |
|                      | Max. tool weight *1 kg(lbs)   | 3.0 (6.6) <total tool weight: 25 (55.1) for 14-tool, 40 (88.2) for 22/28 tool>   | 3.0 (6.6) <total tool weight: 25 (55.1) for 14-tool, 40 (88.2) for 22/28 tool> 4.0 (8.8) <total tool weight: 80 (176.3) >  |
|                      | Tool selection method   | Random short cut method  | Random short cut method Double arm method (random closet path)   |
| Tool change time     | Tool To Tool sec.   | 0.6 / 0.7 (14-tool / 22 or 28 tool)  | 0.6 / 0.8 (14-tool / 22 or 28 tool) 0.9  |
|                      | Chip To Chip sec.   | 1.3 / 1.5 (14-tool / 22 or 28 tool)  | 1.4 / 1.5 (14-tool / 22 or 28 tool) 2.5  |
| Electric motor       | Main spindle motor (10min/continuous) *2 kW                             | 10,000min <sup>-1</sup> specifications: 10.1 / 7.0<br>16,000min <sup>-1</sup> specifications: 7.4 / 5.1<br>10,000min <sup>-1</sup> high-torque specifications: 12.8 / 9.2                | 10,000min <sup>-1</sup> specifications: 10.1 / 7.0<br>16,000min <sup>-1</sup> specifications: 7.4 / 5.1<br>10,000min <sup>-1</sup> high-torque specifications: 12.8 / 9.2                |
|                      | Axis feed motor kW  | X, Y axis: 1.0 Z axis: 1.8   | X, Y axis: 1.0 Z axis: 1.8   |
| Power source         | Power supply  | AC 200 to 230 V±10%,3-phase, 50/60Hz±2%  | AC 200 to 230 V±10%,3-phase, 50/60Hz±2%  |
|                      | Power capacity (continuous) kVA   | 10,000min <sup>-1</sup> specifications: 9.5<br>16,000min <sup>-1</sup> specifications: 9.5<br>10,000min <sup>-1</sup> high-torque specifications: 10.4                                   | 10,000min <sup>-1</sup> specifications: 9.5<br>16,000min <sup>-1</sup> specifications: 9.5<br>10,000min <sup>-1</sup> high-torque specifications: 10.4                                   |
|                      | Air supply Regular air pressure MPa                                     | 0.4~0.6 (recommended value : 0.5MPa *10)   | 0.4~0.6 (recommended value: 0.5MPa *10)  |
|                      | Required flow L/min   | 45   | 45 100   |
| Machining dimensions | Height mm(inch)   | 2,584 (101.7)  | 2,704 (106.5)  |
|                      | Required floor space *13 (with control unit door open) mm(inch)         | 1,400 x 2,609 [3,448] (55.1 x 102.7 [135.7])   | 1,830 x 3,029 [3,868] (72.0 x 119.3 [152.3]) 2,145 x 3,029 [3,868] (84.4 x 119.3 [152.3])  |
|                      | Weight kg(lbs)  | 2,750 (6,063)  | 3,550 (7,826) 4,150 (9,149)  |
| Accuracy *3          | Accuracy of bidirectional axis positioning(S0230-2: 1988) mm(inch)      | 0.006~0.020 (0.00024~0.00079)  | 0.006~0.020 (0.00024~0.00079)  |
|                      | Repeatability of bidirectional axis positioning(S0230-2: 2014) mm(inch) | Less than 0.004 (0.00016)  | Less than 0.004 (0.00016)  |
| Front door           |   | 2doors   | 2doors   |
| Standard accessories |   | Instruction Manual (DVD 1 set), leveling bolts (4 pcs.) [R650Xd1: 5 pcs.], leveling plate (4 pcs.) [R650Xd1: 5 pcs.]   |  |

\*1 Actual tool weight differs depending on the configuration and center of gravity. The figures shown here are for reference only. \*2 Spindle motor output differs depending on the spindle speed. \*3 Measured in compliance with ISO standards and Brother standards. Please contact your local distributor for details. \*4 Brother specifications apply to the pull studs for CTS. \*5 Measured in compliance with JIS B6336-9 and MAS011-1987. \*6 Can be increased up to R450Xd1: 200kg, R650Xd1: 300kg (one face) by changing the parameter. Please consult us separately. \*7 When using the hydraulic rotary joint, the Y-axis travel becomes 290 mm. \*8 Values when the low-floor table is selected. \*9 When using high accuracy mode B. \*10 Regular air pressure varies depending on the machine specifications, machining program details, or use of peripheral equipment. Set the pressure higher than the recommend value. \*11 When table loading on one face is R450Xd1: 120kg, R650Xd1: 200kg. \*12 The machine needs to be equipped with a relocation detection device depending on the destination. Machines equipped with a relocation detection device come with "RD" at the end of the model name. \*13 The value does not include the coolant tank or chip conveyor. \*14 When the turning diameter enlargement option is selected.

### Quick turn table specifications

| Item                                      | R450Xd1   | R650Xd1   |
|---|---|---|
| Type                                      | 0 deg./180 deg. turntable system  | 0 deg./180 deg. turntable system  |
| Table dimension                           | One face 600 x 420 (23.6 x 16.5)  | One face 800 x 535 (31.5 x 21.1)  |
| Max. turning diameter                     | D1,020 (40.2) [D1,100 (43.3)] *14   | D1,250 (49.2) [D1,300 (51.2)] *14   |
| Max. jig height                           | 300 (11.8) [380 (15.0)] *8  | 350 (13.8) [450 (17.7)] *8  |
| Table work area size                      | One face 600 x 300 (23.6 x 11.8)  | One face 800 x 400 (31.5 x 15.7)  |
| Max. loading capacity                     | One face 120 (265) [200 (441)] *6   | One face 200 (441) [300 (661)] *6   |
| Rated table load inertia for turning axis | One face 14.2 [23.5] *6   | One face 35.8 [53.7] *6   |
| Table turning system                      | AC servo motor(1kW) Worm gear(total speed reduction ratio:1/50)                             | AC servo motor(0.82kW) Worm gear(total speed reduction ratio:1/60)                          |
| Table position time                       | 2.7 *11   | 3.1 *11   |
| Table change repeatability                | 0.005 (0.0002)<br>(in the X,Y, and Z axes directions 270(10.6) from the center of rotation) | 0.005 (0.0002)<br>(in the X,Y, and Z axes directions 335(13.2) from the center of rotation) |

\*Quick Turn table is a turntable type 2-face pallet changer.

### NC functions

|                              |  |  |                                   |   |
|------------------------------|--|--|-----------------------------------|---|
| Operation                    | Dry run<br>Machine lock<br>Program restart<br>Rapid traverse override<br>Cutting feed override<br>Background editing<br>Screen shot<br>Operation level<br>External input signal key<br>Shortcut keys<br><Optional><br>Spindle override | Tool life / Spare tool<br>Maintenance<br>Tap return function<br>Status log<br>Alarm log<br>Operation log<br>Maintenance notice<br>Motor insulation resistance measurement<br>Tool washing filter with filter clogging detection<br>Battery-free encoder<br>Brake load test | Accessories                       | File viewer<br>Notebook<br>Calculator<br>Register shortcut<br>Display off   |
| Programming                  | Absolute / Incremental<br>Inch / Metric<br>Coordinate system setting<br>Corner C / Corner R<br>Rotational transformation<br>Synchronized tap<br>Subprogram<br>Graphic display  | Automatic / Network<br>Computer remote<br>OPC UA<br>Auto notification<br>Built-in PLC (LD/ST/FBD)<br><Optional><br>CC-Link, master station<br>CC-Link, remote device station<br>PROFIBUS DP, slave<br>DeviceNet, slave<br>PROFINET, slave<br>EtherNet/IP, slave            | Functions limited to NC language  | Menu programming<br>Local coordinate system<br>Expanded workpiece coordinate system<br>One-way positioning<br>Inverse time feed<br>Programmable data input<br>Tool length compensation<br>Cutter compensation<br>Scaling<br>Mirror image<br>External sub program call<br>Macro<br>Operation in tape mode<br>Multiple skip function<br><Optional><br>Submicron command *2<br>Interrupt type macro<br>Rotary fixture offset<br>Feature coordinates setting *3<br>Involute interpolation |
| Measurement                  | Automatic workpiece measurement *1<br>Tool length measurement  | Energy saving<br>Automatic power off<br>Standby mode<br>Automatic coolant off<br>Automatic work light off<br>Chip shower off delay   | Functions limited to conversation | Operation program<br>Schedule program<br>Automatic tool selection<br>Automatic cutting condition setting<br>Automatic tool length compensation setting<br>Automatic cutter compensation setting<br>Automatic calculation of unknown number input<br>Machining order control   |
| High speed and high accuracy | Machining parameter adjustment<br>High-accuracy mode All<br>High-accuracy mode BI (look-ahead 160 blocks)<br>Backlash compensation<br><Optional><br>High accuracy mode BII (Look-ahead 1,000 blocks, smooth path offset)               | Support apps<br>Adjust machine parameters<br>ATC tool<br>Tool life<br>Waveform display<br>Production performance<br>Power consumption<br>Recovery support<br>Inspection<br>PLC   |                                   |   |
| Monitoring                   | Machining load monitoring<br>ATC monitoring<br>Overload prediction<br>Waveform display / Waveform output to memory card<br>Heat expansion compensation system II (X, Y, and Z axes)<br>Production performance display                  |  |                                   |   |

\*1. Measuring instrument needs to be prepared by users.  
\*2. When the submicron command is used, changing to the conversation program is disabled.  
\*3. There are some restrictions on axes configurations.

### NC unit specifications

|                                |  |
|--------------------------------|--|
| CNC model                      | CNC-D00  |
| Control axes                   | 7 axes (X, Y, Z, four additional axes)   |
| Simultaneously controlled axes | Positioning 5 axes (X, Y, Z, A, B)<br>Interpolation Linear: 4 axes (X, Y, Z, one additional axis)<br>Circular: 2 axes<br>Helical/Conical: 3 axes (X, Y, Z) |
| Least input increment          | 0.001 mm, 0.0001 inch, 0.001 deg.  |
| Max. programmable dimension    | ±999999.999 mm, ±99999.9999 inch   |
| Display                        | 15-inch color LCD touch display  |
| Memory capacity                | 500 Mbytes, 3 Gbytes (optional) (Total capacity of program and data bank)  |
| External communication         | USB memory interface, Ethernet, RS232C (optional)  |
| No. of registrable programs    | 4,000 (Total capacity of program and data bank)  |
| Program format                 | NC language, conversation (changed by parameter)<br>Conversion from conversation program to NC language program available                                  |

\*"Control axes" and "Simultaneously controlled axes" indicate the maximum number of axes, which will differ depending on the destination country and the machine specifications.  
\* Ethernet is a registered trademark of Xerox Corporation in the United States.

● Please read the instruction manuals and safety manuals before using Brother products for your own safety.  
When using oil-based coolant oil or when machining the materials which can cause a fire (ex. Magnesium, resin material), customers are requested to take thoroughgoing safety measures against fire.  
Depending on the types of cutting material, cutting tools, coolant oil, lubrication oil, it may have an influence on the machine lifecycle.  
Further questions, please contact our sales representative in charge.

● Leave 700 mm between machines as a maintenance space.

● When exporting our machine together with additional 1-axis rotary table or compound rotary table (including case that a rotary table is scheduled to be installed overseas), the machine is deemed to be included in the "applicable listed items" controlled by the Foreign Exchange and Foreign Trade Law of Japan. When exporting the machine, please obtain required permissions, including an export license, from the Ministry of Economy, Trade and Industry (METI) or Regional Bureaus of Economy, Trade and Industry before shipment. When re-selling or re-exporting the machine, you may need to obtain permissions from METI, and the government of the country where the machine is installed.

● When exporting our machine together with compound rotary table (including case that a rotary table is scheduled to be installed overseas), as a machine conforming to Row 2 of Appended Table 1 of Export Trade Control Order, a relocation detection device is installed on the machine depending on the destination country. After relocating the machine with the detection device, the machine is locked and any operation is temporarily impossible. Please inform your local distributor of machine relocation in advance and apply to perform the release operation of relocated machine.

● In order to operate our machine with an additional axis rotary table installed separately overseas after exporting the machine, the procedure to activate the axis of rotary table is needed. Please inform your local distributor of these processes in advance, because the predetermined procedure is required to perform the activation. In addition, for export to some countries and regions other than "Group A countries", it is not possible to install a compound rotary table separately overseas after exporting the machine. Please make sure to obtain the export license of the machine together with compound rotary table before shipment.

**R650Xd1** 14/22/28 tool specifications (Chute type)

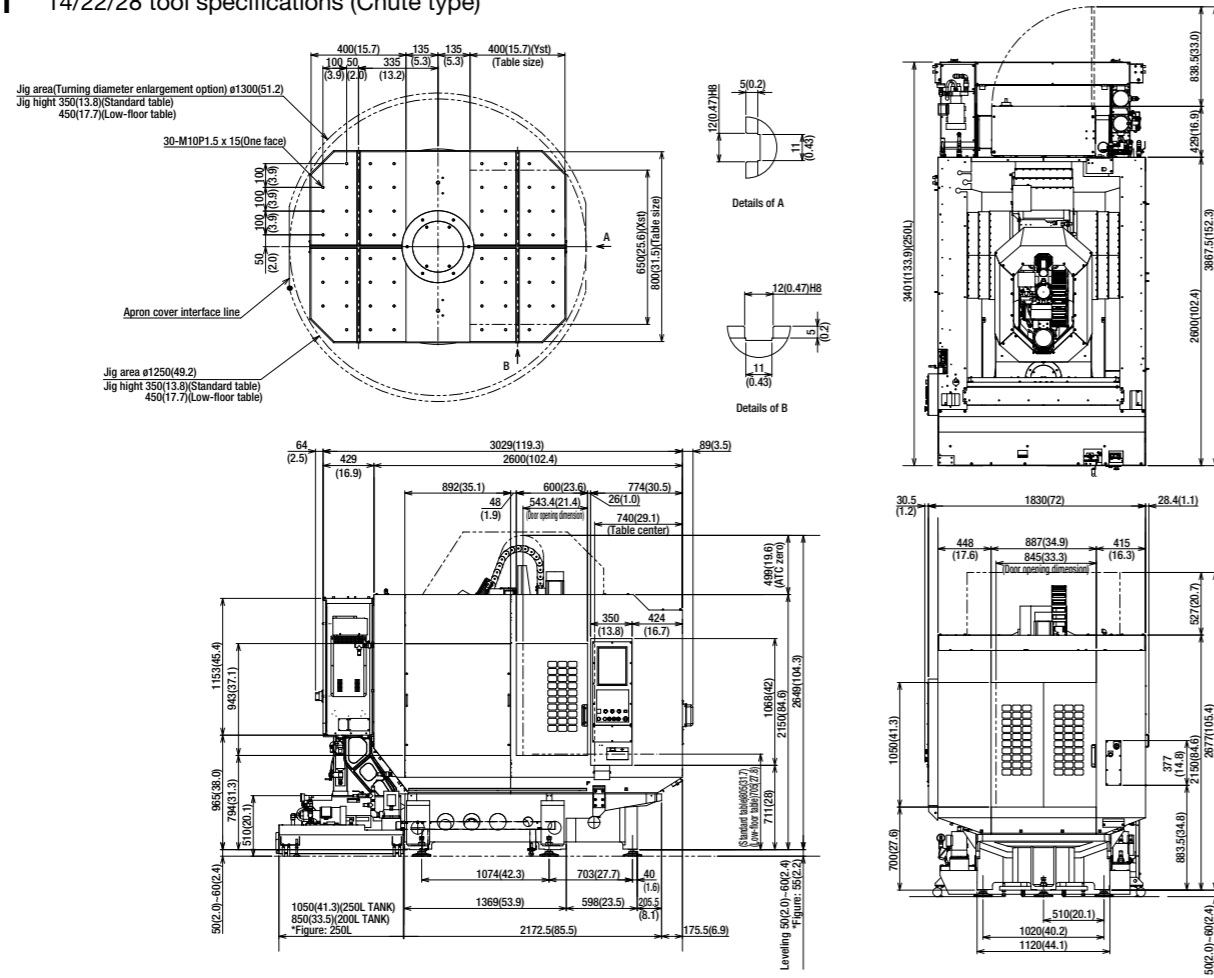

**R450Xd1** (Chute type)

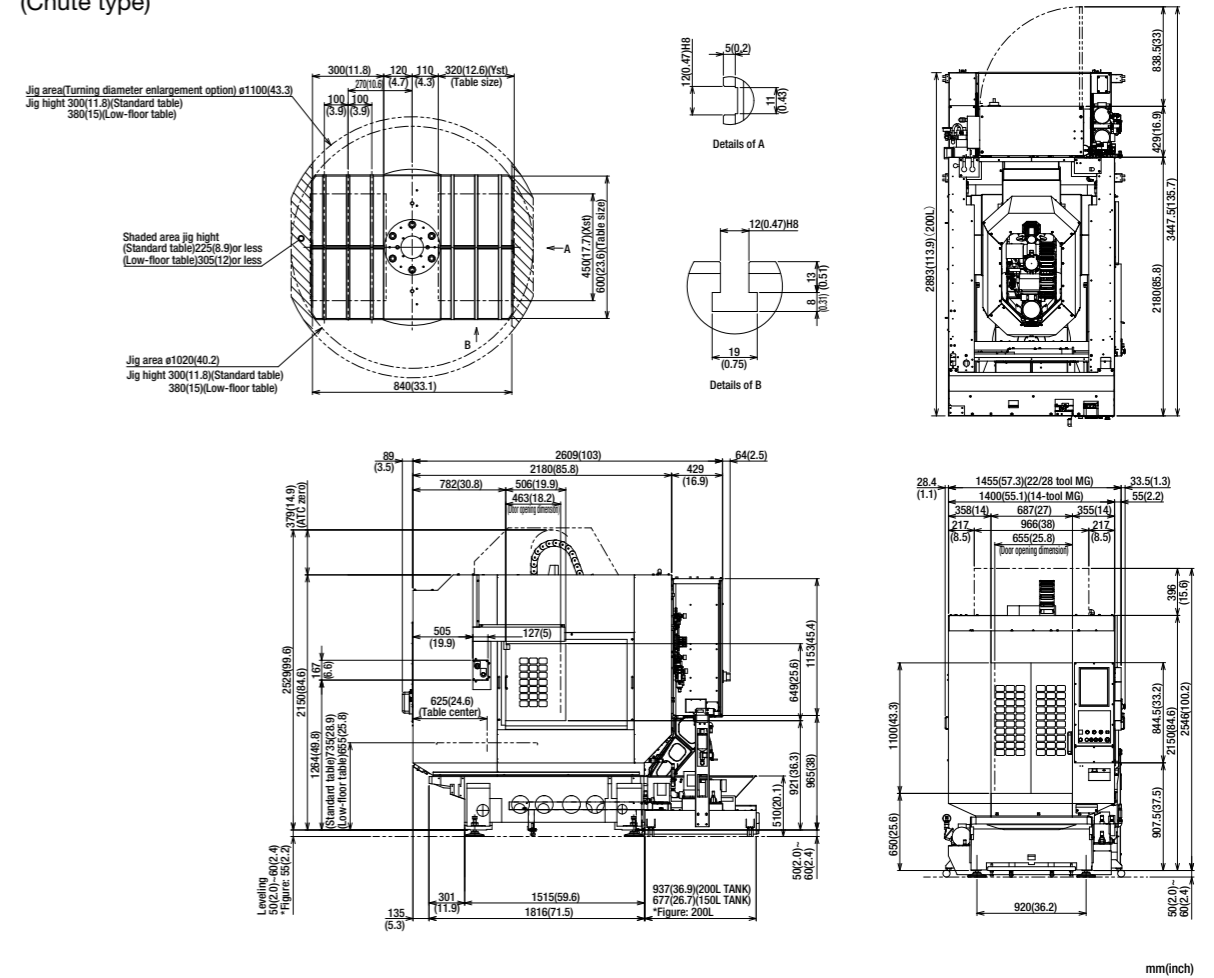

**R650Xd1** 40-tool specifications (Chip conveyor type)

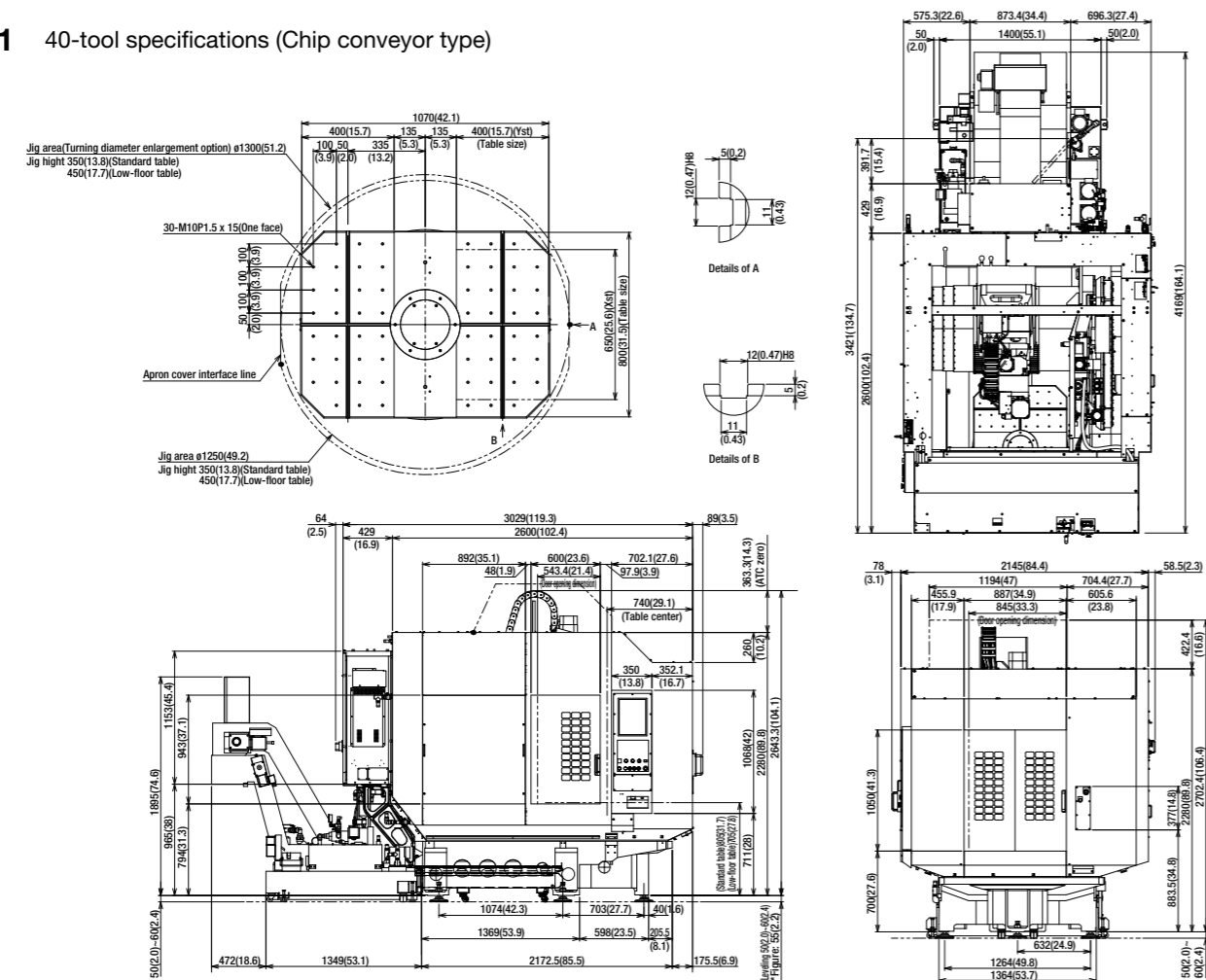

**Tool Dimensions**

14/22/28 tool specifications

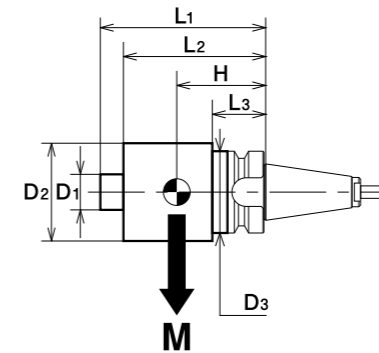

|                                   |   |   |
|-----------------------------------|---|---|
| Max Spindle Rotation Speed        | 10000min <sup>-1</sup> / 16000min <sup>-1</sup>   |   |
| Spindle Taper                     | 7 / 24 No.30  |   |
| Tool Shank                        | MAS-BT  |   |
| Retention Knob                    | MAS-P30T-2(30°)   |   |
| Total in Magazine                 | M total 25kg (14 Tools) / 40kg (22/28 Tools)  |   |
| Limitation of Tool                | D1 ≤ 40mm<br>L1 ≤ 200mm<br>D2 ≤ 80mm<br>L2 ≤ 160mm<br>D3 ≤ 46mm<br>L3 ≤ 30mm<br>M ≤ 3kg<br>MxH ≤ 180kg·mm | D1 ≤ 40mm<br>L1 ≤ 200mm<br>D2 ≤ 55mm<br>L2 ≤ 160mm<br>D3 ≤ 46mm<br>L3 ≤ 30mm<br>M ≤ 2kg<br>MxH ≤ 100kg·mm |
|                                   | Limitation of Tool Balance  | 100g·mm   |
| Limitation Spindle Rotation Speed | 10000min <sup>-1</sup>  | 16000min <sup>-1</sup>  |

40-tool specifications

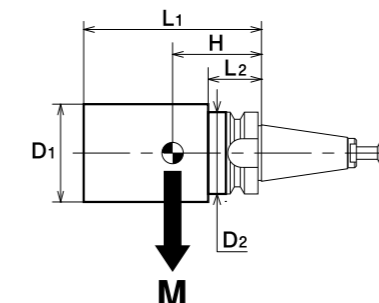

|                                   |   |  |
|-----------------------------------|---|--|
| Max Spindle Rotation Speed        | 10000min <sup>-1</sup> / 16000min <sup>-1</sup>                                 |  |
| Spindle Taper                     | 7 / 24 No.30  |  |
| Tool Shank                        | MAS-BT  |  |
| Retention Knob                    | MAS-P30T-2(30°)   |  |
| Total in Magazine                 | M total 80kg (40Tools)  |  |
| Limitation of Tool                | D1 ≤ 125mm<br>L1 ≤ 250mm<br>D2 ≤ 46mm<br>L2 ≤ 30mm<br>M ≤ 4kg<br>MxH ≤ 180kg·mm | D1 ≤ 55mm<br>L1 ≤ 250mm<br>D2 ≤ 46mm<br>L2 ≤ 30mm<br>M ≤ 2kg<br>MxH ≤ 100kg·mm |
|                                   | Limitation of Tool Balance  | 100g·mm  |
| Limitation Spindle Rotation Speed | 10000min <sup>-1</sup>  | 16000min <sup>-1</sup>   |

mm(inch)  
Secure 700 mm(27.6 inch) between machines as maintenance space.

**Brother Technology Center Chicago**

BROTHER INTERNATIONAL CORP.  
2200 North Stonington Avenue, Suite 270, Hoffman Estates, IL 60169, U.S.A.  
PHONE:(1)224-653-8415 FAX:(1)224-653-8821

**Brother Technology Center Frankfurt**

BROTHER INTERNATIONALE INDUSTRIEMASCHINEN GmbH  
Hoechst Str.94, 65835 Liederbach, Germany  
PHONE:(49)69-977-6708-0 FAX:(49)69-977-6708-80

**Brother Technology Center Bengaluru**

BROTHER MACHINERY INDIA PVT LTD.  
SB-111-112, 1st Stage, 2nd Cross, Peenya Indl Estate, Bengaluru - 560058 Karnataka, India  
PHONE:(91)80-43721645

**Brother Technology Center Shanghai**

BROTHER MACHINERY (SHANGHAI) LTD.  
Unit 01, 5/F., No.799, West Tianshan Rd., ChangNing District Shanghai 200335, China  
PHONE:(86)21-2225-6666 FAX:(86)21-2225-6688

**Brother Technology Center Chongqing**

BROTHER MACHINERY (SHANGHAI) LTD.  
Room 30, 31, NO.104 Cuibai Road, Dadukou District, Chongqing Province, 400084, China  
PHONE:(86)23-6865-5600 FAX:(86)23-6865-5560

**Nanjing Office**

BROTHER MACHINERY (SHANGHAI) LTD.  
503 Room, Building No.1, No.39, Dongcun Road, Jiangning District, Nanjing City, Jiangsu Province, China  
PHONE:(86)25-87185503

**Brother Technology Center Queretaro**

BROTHER INTERNATIONAL DE MÉXICO, S.A. DE C.V.  
Calle 1 No.310 Int 15, Zona Industrial Jurica, Parque Industrial Jurica,  
Queretaro, QRO C.P. 76100 México  
PHONE:(52)55-8503-8760 FAX:(52)442-483-2667

**Brother Technology Center Bangkok**

BROTHER COMMERCIAL (THAILAND) LTD.  
317 Pattanakarn Road, Pravet Sub-District, Pravet District, Bangkok 10250, Thailand  
PHONE:(66)2321-5910 FAX:(66)2321-5913

**Gurugram Service Center**

BROTHER MACHINERY INDIA PVT LTD.  
CE SERVICED OFFICES PVT. LTD., DLF CYBER HUB, Building No 10, Tower A, Level 1,  
Phase 3, DLF Cyber City, Gurugram - 122002 Haryana - India  
PHONE:(91)80-43721645

**Brother Technology Center Dongguan**

BROTHER MACHINERY (SHANGHAI) LTD.  
Room 103, Building 1, No.2 Nanbo Road,  
Songshan Lake District, Dongguan City, Guangdong Province, China  
PHONE:(86)769-2238-1505 FAX:(86)769-2238-1506

**Brother Technology Center Ningbo**

BROTHER MACHINERY (SHANGHAI) LTD.  
1F, Building 1, No. 102, Hongtang South Road West Section, Jiangbei District, Ningbo City,  
Zhejiang Province, China  
PHONE:(86)574-87781232 FAX:(86)574-88139792

Figures in brackets ( ) are the country codes.

Specifications may be subject to change without any notice.

**BROTHER INDUSTRIES, LTD.**

**Machinery Business Division**

1-5, Kitajizoyama, Noda-cho, Kariya-shi, Aichi-ken 448-0803, Japan  
<https://www.brother.co.jp>

