

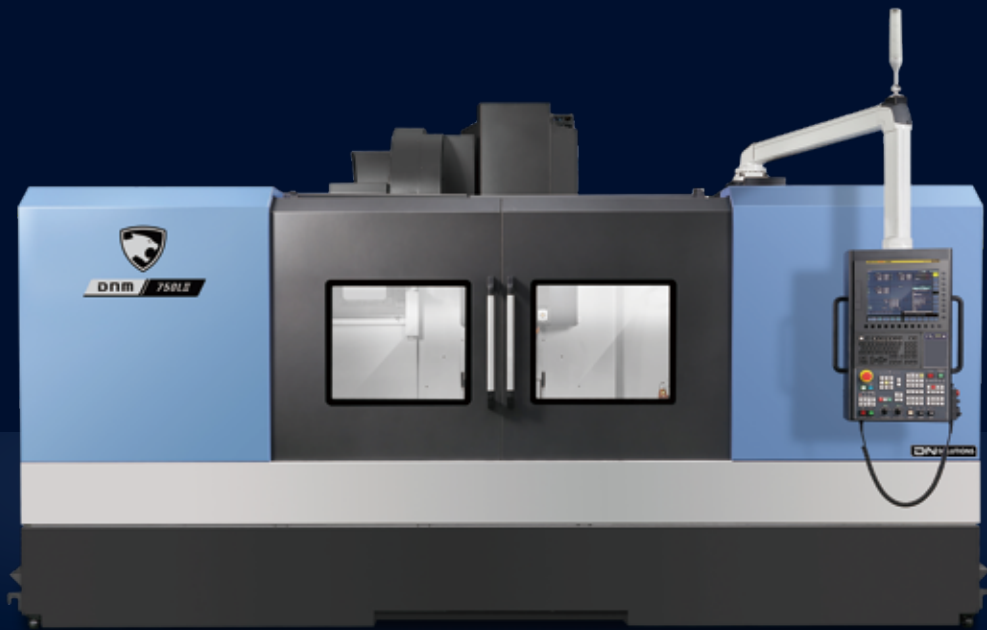

HIGH PRODUCTIVITY VERTICAL MACHINING CENTER

DNM

750 II • 750L II



DNM 750 II · DNM 750L II

Designed as high productivity vertical machining centers, the DNM 750 II and DNM 750L II have a rigid structure and are equipped with either directly-coupled, built-in or belt-driven spindles. An oil cooler system is supplied as a standard enabling the machines to be used continuously, at high speed, over long periods of time. The oil is cooled in the cooler system before being circulated around the spindle head and ball screw nut to minimize thermal displacement and deliver high-precision cutting. The Ez work functions in the machines' control systems ensure efficient and trouble-free job set ups and machining operations.

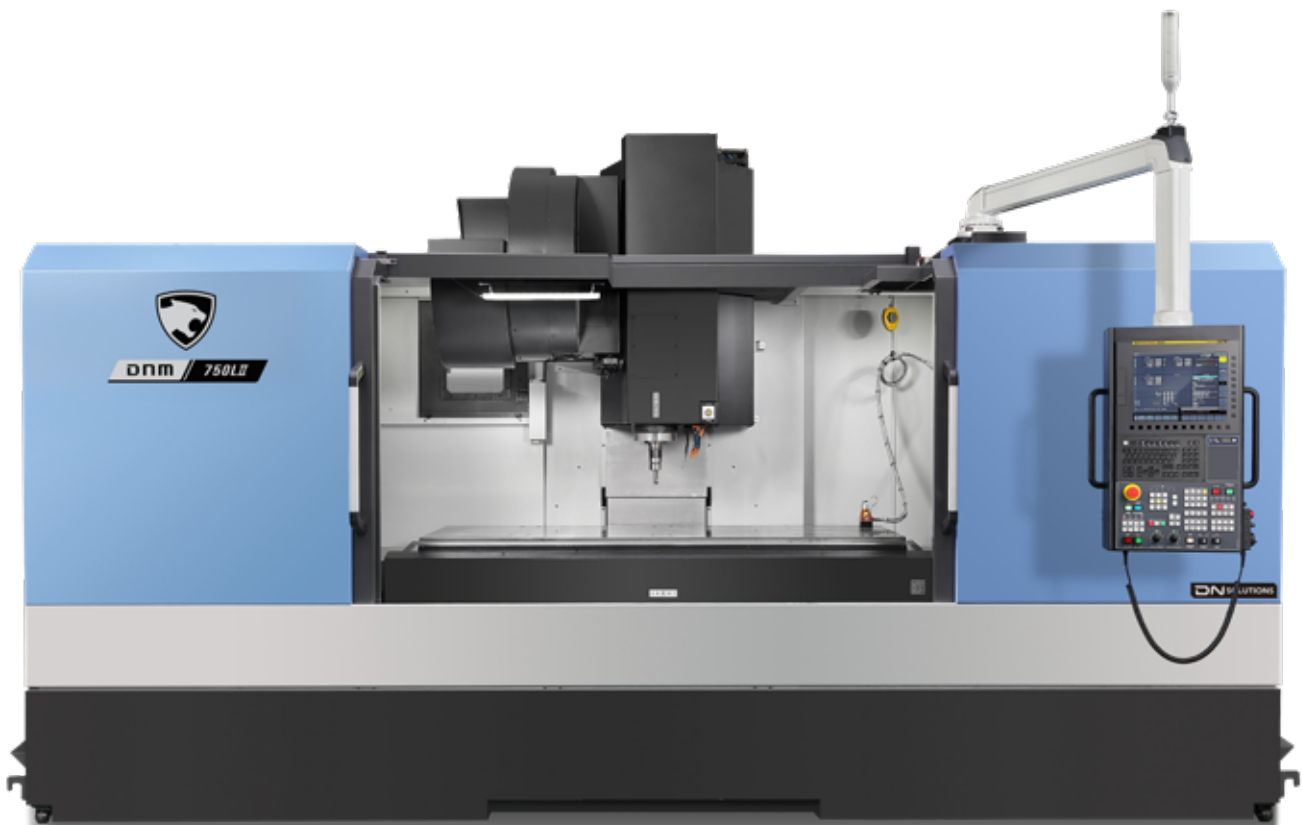

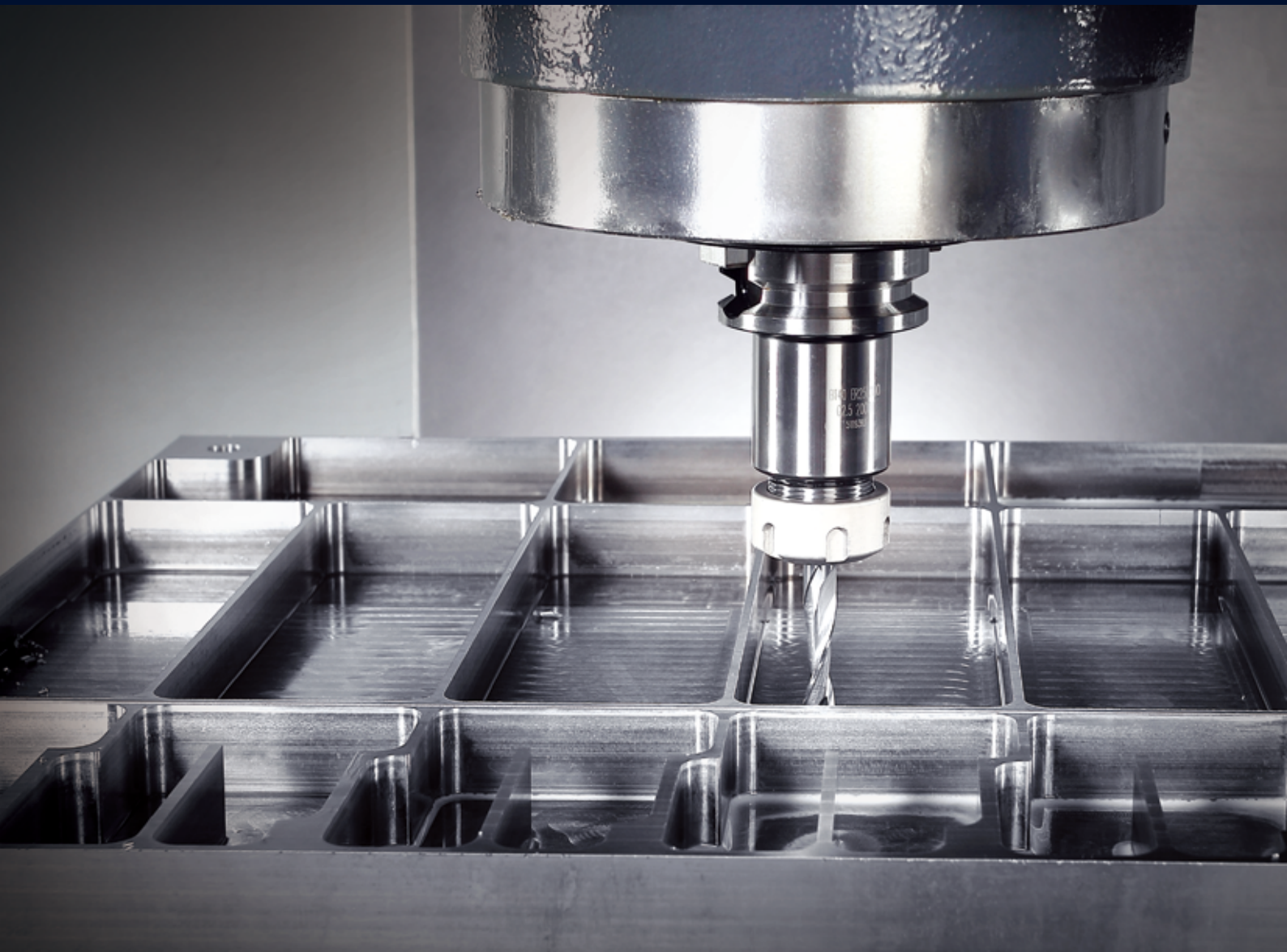

THE LARGEST CUTTING AREA IN THEIR CLASS

- The X-axis travel distance, table size and maximum table load have all been increased allowing larger and heavier workpieces to be machined.

HIGH PRODUCTIVITY MACHINES FOR HIGHLY STABLE MACHINING PERFORMANCE

- Spindle cooling and ball screw cooling systems are supplied as standard to ensure reliable and repeatable machining performance.

EASY OPERATION OF CNC SYSTEM

- Fast, efficient and error-free operation
- The Ez work functions are user friendly and are easy-to-use.

BASIC STRUCTURE | AXIS SYSTEM

Basic structure

The machines' rigid column design ensures highly-stable machining performance. Larger workpieces can be machined by extending the X-axis stroke.

Traver distance (X x Y x Z axis)

DNM 750 II

1630 / 762 / 650 mm

64.2 x 30.0 x 25.6 inch

DNM 750L II

2160 / 762 / 650 mm

85.0 x 30.0 x 25.6 inch

The DNM 750L II uses four-row Roller guideways in the Y-axis that eliminate overhang and provide optimum stability. (DNM 750 II has two-row Roller guideways).

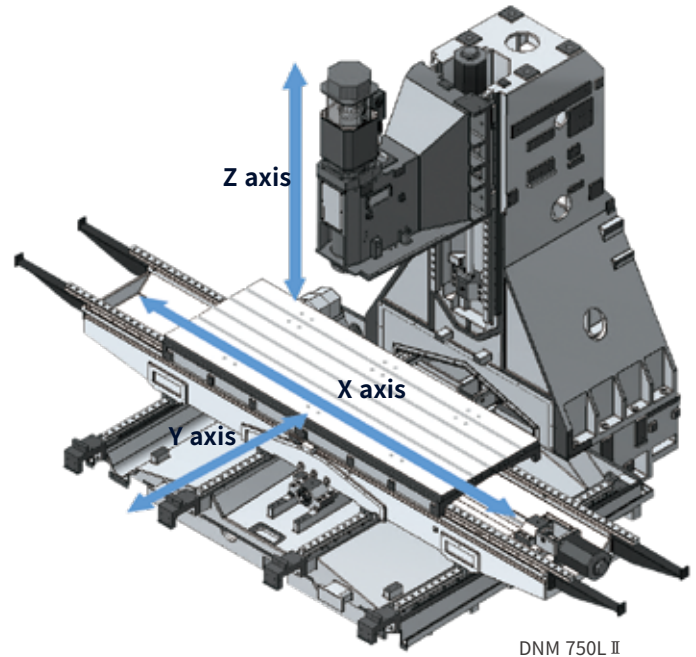

Axis system

Roller LM guideways are used as standard on all axes to improve rigidity.

Rapid traverse rate (X / Y / Z axis)

DNM 750 II

30 / 30 / 24 m/min

1181.1 / 1181.1 / 944.9 ipm

DNM 750L II

24 / 24 / 24 m/min

944.9 / 944.9 / 944.9 ipm

Roller LM guideway life is twice that of Ball LM guideways.

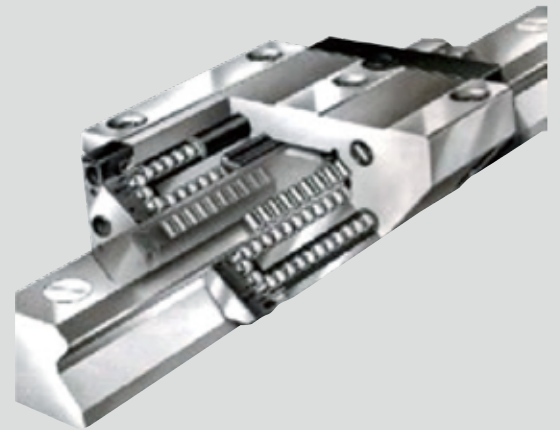

TABLE

The machines offer a wide range cutting capacities and capabilities, and can handle a range of large workpieces.

Table size (A x B)

DNM 750 II

1630 x 760 mm 64.2 x 29.9 inch

DNM 750L II

2160 x 760 mm 85.0 x 29.9 inch

Max. weight on table

DNM 750 II

1500 kg
3306.9 lb

DNM 750L II

1800 kg
3968.3 lb

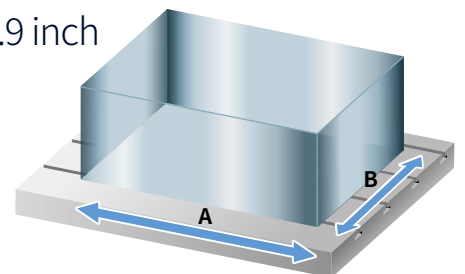

SPINDLE

Spindle

Directly-coupled spindles have been adopted as a standard feature to further reduce vibration and noise while enhancing productivity, the working environment and machining accuracy. The dual contact tool system is used as standard for extra rigidity and reliability.

Max. spindle speed

8000 r/min*

12000 r/min** option

Max. spindle motor power

18.5 kW 24.8 Hp

28 kW 37.5 Hp option

15.6 kW 20.9 Hp option

Max. spindle motor torque

118 N.m 87.1 ft-lbs

159.1 N.m 117.4 ft-lbs option

165.5 N.m 122.1 ft-lbs option

* Belt type ** Direct type

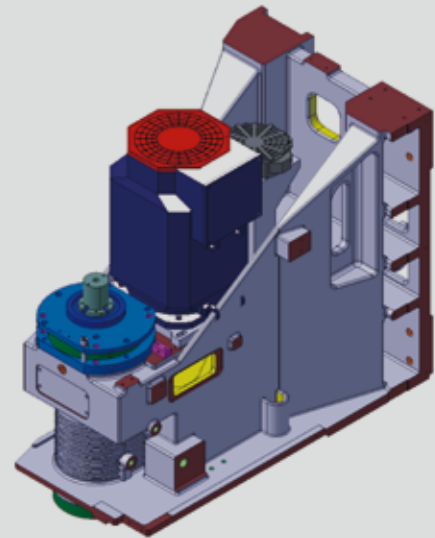

Belt

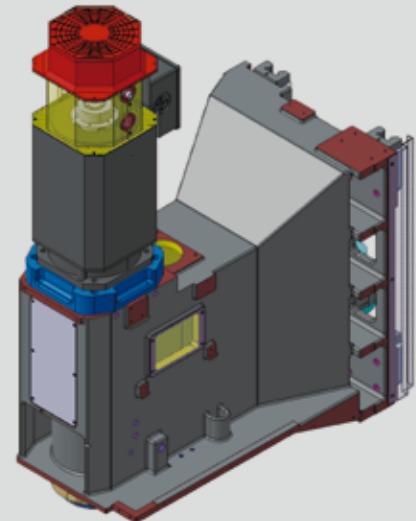

Direct

TOOL CHANGE SYSTEM

Higher productivity can be achieved with the CAM-type tool changer that has faster tool changing capability.

Tool storage capacity

30 ea / **40** ea option

Tool to Tool

1.3 sec

Chip-to-Chip*

3.7 sec

* The Chip-to-Chip time has been tested in accordance with DN Solutions's strict testing conditions, but may vary depending on the user's operating conditions.



MACHINING PERFORMANCE

To provide best cutting performance. Tool change time has been optimized to reduce non cutting time.

Cutting performance

Result of cutting test on DNM 750 II (12000r/min, Direct, 15.6/15.6kW (20.9/20.9 Hp))

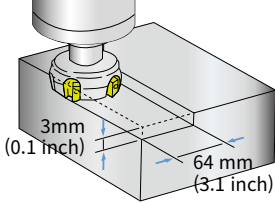
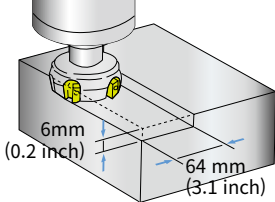
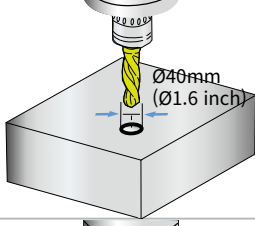
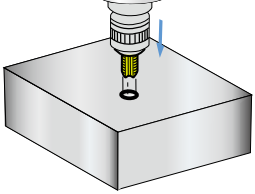
Face mill (ø80 mm (ø3.1 inch) Carbon steel (SM45C))			
Chip removal rate (cm ³ /min(inch ³ /min))	Spindle speed (r/min)	Feedrate (mm/min (ipm))	
806 (49.2)	1500	4200 (165.4)	
Face mill (ø80 mm (ø3.1 inch) Aluminium alloy (AL6061))			
Chip removal rate (cm ³ /min(inch ³ /min))	Spindle speed (r/min)	Feedrate (mm/min (ipm))	
1728 (105.4)	1500	4500 (177.2)	
U-Drill (ø40 mm (ø1.6 inch) Carbon steel (SM45C))			
Chip removal rate (cm ³ /min(inch ³ /min))	Spindle speed (r/min)	Feedrate (mm/min (ipm))	
251 (15.3)	1200	200 (7.9)	
Tap Carbon steel (SM45C)			
Tap size (mm)	Spindle speed (r/min)	Feedrate (mm/min (ipm))	
M30 x P3.5	200	700 (27.6)	

* The results, indicated in this catalogue are provides as example. They may not be obtained due to differences in cutting conditions and environmental conditions during measurement.

Cutting performance

Result of cutting test on DNM 750 II (12000r/min, Direct, 28/11kW (37.5/14.8 Hp))

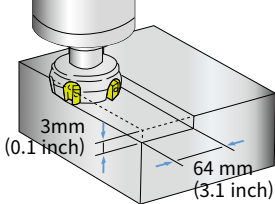
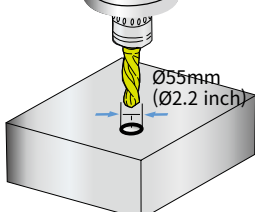
Face mill (ø80 mm (ø3.1 inch) Carbon steel (SM45C))			
Chip removal rate (cm ³ /min(inch ³ /min))	Spindle speed (r/min)	Feedrate (mm/min (ipm))	
864 (52.7)	1500	4500 (177.2)	
U-Drill (ø55 mm (ø2.2 inch) Carbon steel (SM45C))			
Chip removal rate (cm ³ /min(inch ³ /min))	Spindle speed (r/min)	Feedrate (mm/min (ipm))	
356 (21.7)	700	150 (5.9)	

* The results, indicated in this catalogue are provides as example. They may not be obtained due to differences in cutting conditions and environmental conditions during measurement.

STANDARD | OPTIONAL SPECIFICATIONS

Various optional features are available to meet customers' specific machining requirements and applications.

Description	Features				DNM 750 II DNM 750L II
Spindle	FANUC	8000 r/min	Belt	18.5/15 kW (24.8/20.1 Hp) (S3 60%/Cont.)	●
		12000 r/min	Direct	28/11 kW (37.5/14.8 Hp) (S3 15%/Cont.)	○
	HEIDENHAIN	8000 r/min	Belt	15.6/15.6 kW (20.9/20.9 Hp) (S3 40%/Cont.)	○
		12000 r/min	Direct	20/15 kW (26.8/20.1 Hp) (S6 60%/Cont.)	○
	SIEMENS	8000 r/min	Belt	21.8/16.3 kW (29.2/21.9 Hp) (S6 40%/Cont.)	○
		12000 r/min	Direct	16.5/11 kW (22.1/14.8 Hp) (S6 40%/Cont.)	○
Spindle cooling system	FANUC	8000 r/min	Belt	18.5/15 kW (24.8/20.1 Hp)	●
		12000 r/min	Direct	28/11 kW (37.5/14.8 Hp)	●
	HEIDENHAIN	8000 r/min	Belt	15.6/15.6 kW (20.9/20.9 Hp)	●
		12000 r/min	Direct	20/15 kW (26.8/20.1 Hp)	●
	SIEMENS	8000 r/min	Belt	20/15 kW (26.8/20. Hp)	●
		12000 r/min	Direct	21.8/16.3 kW (29.2/21.9 Hp)	●
		8000 r/min	Belt	16.5/11 kW (22.1/14.8 Hp)	●
		12000 r/min	Direct	16.5/11 kW (22.1/14.8 Hp)	●
Magazine	Tool storage capacity	30 ea		○	
		40 ea		○	
Tool shank type	BIG PLUS BT40				●
	BIG PLUS CAT40				○
	BIG PLUS DIN40				○
Coolant	FLOOD		0.15 Mpa, 0.4 kW (0.5 Hp)		●
			0.7 MPa, 1.8 kW (2.4 Hp)		○
	TSC		None		●
			2 MPa, 1.5kW (2.0 Hp)		○
			2 MPa, 4.0 kW (5.4 Hp)		○
			7 Mpa, 5.5 kW (7.4 Hp)		○
	SHOWER		0.1 MPa, 1.1 kW (1.5 Hp)		○
	Oil skimmer		Belt type		○
Chip disposal	MQL				○
	Chip pan				●
	Chip conveyor		Hinged type (Left / Right / Rear)		○
			Magnetic scraper type (Left / Right / Rear)		○
		Drum filter type (Rear)		○	
Precision machining option	Chip bucket				○
	Linear scale		X / Y / Z axis		●
	AICC II (200 block)				●
Measurement & Automation	Fine surface machining		Look-ahead block is Max.200		●
	Automatic tool measurement		-AI contour control II+ -Smooth tolerance control+ -Jerk control		○
	Automatic tool breakage detection		TS27R		○
	Automatic workpiece measurement		OTS		○
	Automatic front door with safety device		OMP60		○
Accessories	WORK LIGHT		LED LAMP		●
	SMART THERMAL CONTROL		SENSORLESS TYPE(ONLY SPINDLE)		●
	AIR BLOWER		-		○
	AUTO TOOL LENGTH MEASUREMENT		RENISHAW / TS27R		○
	AUTO TOOL BREAKAGE DETECTION		RENISHAW / OTS		○
	AUTO WORKPIECE MEASUREMENT		FAR-EAST MACHINE TOOL/FEM-1CP(NEEDLE TYPE IN CUTTING AREA)		○
	4TH AXIS PREPARATION CABLING FOR SERVO/1-PNEUMATIC PIPING		RENISHAW / OMP60		○
	AIR GUN		FACTORY READY MADE		○
	Coolant gun		-		○
	Mist collector		-		○
Customized Special Option	ANCHORING ⁽¹⁾		SIDE CLAMP & CHEMICAL ANCHOR BOLT		○
	COOLANT CHILLER ⁽²⁾		-		○
	TSA ⁽³⁾		0.54		○
	RAISING BLOCK		150mm		○
			200mm		○
			300mm		○
	CHIP CONVEYOR		HINGED PLATE TYPE LEFT SIDE		○
			MAGNETIC SCRAPER TYPE RIGHT SIDE		○
			MAGNETIC SCRAPER TYPE LEFT SIDE		○
			DRUM CHIP CONVEYOR WITH HINGED PLATE		○
			DRUM CHIP CONVEYOR WITH SCRAPER		○
			OUTLET DIRECTION - REAR SIDE TYPE		○
	20 BAR TSC with INVERTER		50Hz → 60Hz		○
	MAGAZINE TOOL STORAGE CAPACITY		60T(CHAIN ATC)		○
			30T		○
	SERVO MAGAZINE		40T		○
	AEROSPACE PACKAGE		30K SPINDLE(HSK-63A)		○
			IMPROVED CHIP EVACUATION		○
	SPINDLE HEAD TYPE		11/18.5(S3 15%), 15,000 rpm, DIRECT TYPE		○
	AUTO TOOL LENGTH MEASUREMENT		LTS		○
AUTO TOOL BREAKAGE DETECTION		MSC/BK9(NEEDLE TYPE ON MAGAZINE)		○	
AUTO DOOR WITH SAFETY EDGE		-		○	

* Please contact DN Solutions for detailed specification information.

● Standard ○ Optional X Not applicable

(1) Please refer to foundation drawing in relation to anchoring. If more detail information want, consult with DN Solutions service

(2) In case of using neat cutting oil, this device is highly recommended in order to reduce the change of accuracy by rising the coolant temperatures.

(3) In case of TSC is not required and only TSA is needed, this option can be selected.

 **Fire Safety Precautions** | There is a high risk of fire when using non-water-soluble cutting fluids, processing flammable materials, neglecting the controlled and careful use of coolants and modifying the machine without the consent of the manufacturer. Always check the SAFETY GUIDELINES carefully before using the machine.

PERIPHERAL EQUIPMENT

Spindle and ball screw nut cooling system

The machines' cooling system helps minimize thermal displacement of the spindle and axes and features oil, that is cooled and is then circulated around the spindle head and ball screw nuts.

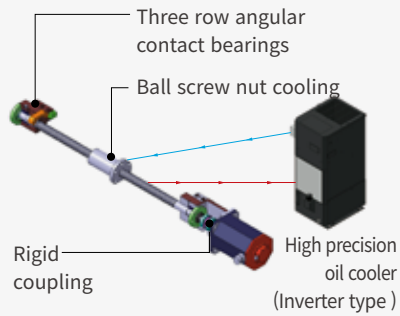

Chip conveyor option



Long



Short



Needle



Sludge

Material		Carbon steel			Cast iron		Aluminium		
		Long	Short	Needle	Short	Sludge	Long	Short	Needle
Chip conveyor type									
Hinged belt type		○	△	X	△	X	○	△	X
Scraper type	Normal	X	○	△	○	△	X	△	X
	Magnetic	X	○	○	○	○	—	—	—
Drum filter type	Hinged type	○	△	X	△	X	○	△	X
	Scraper	X	○	△	○	△	X	○	△

○ : Suitable, △ : Possible, X : Not suitable

Measurement & Automation option



Automatic tool measurement

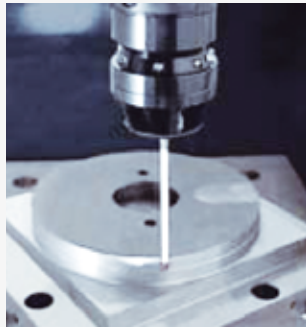

Automatic workpiece measurement

Raised block option

When the distance between the table top and the spindle nose needs to be extended, for example, to accommodate a fixture or rotary axis on the table, a raised block can be used.

Height **150** mm (5.9 inch)
200 mm (7.9 inch)
300 mm (11.8 inch)

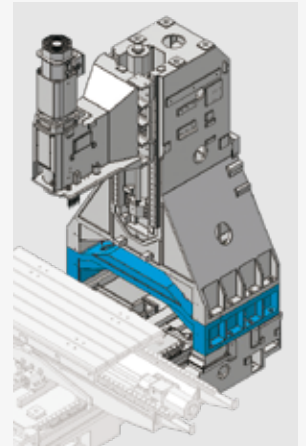

4th-axis auxiliary device interface option

Customers wishing to set up a rotary axis on the table to increase application flexibility are encouraged to contact DN Solutions in advance.

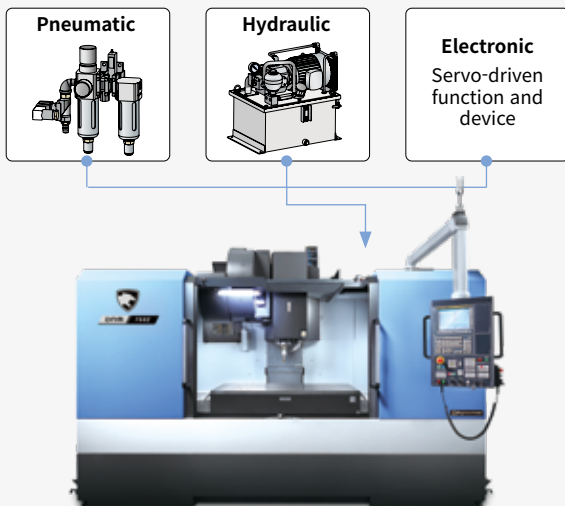

Hydraulic / Pneumatic fixture line option

Customers should prepare pipelines for hydraulic/pneumatic fixtures whose detailed specifications should be determined and agreed through discussions with DN Solutions.

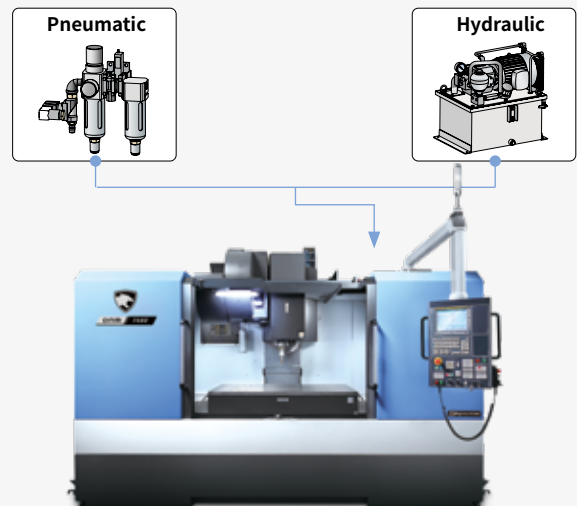

DN SOLUTIONS FANUC i PLUS

DN Solutions Fanuc i Plus is optimized for maximizing customer productivity and convenience.

15 inch screen + new operation panel

DN Solutions Fanuc i Plus' operation panel enhances operating convenience by incorporating common-design buttons and layout, and features the Qwerty keyboard for fast and easy operation.

DN Solutions Fanuc i Plus

- 15 inch color display
- Intuitive and user-friendly design

USB & PCMCIA card

QWERTY keyboard

- EZ-guide i standard
- Ergonomic operator panel
- 2MB Memory
- Hot key



iHMI touchscreen option

iHMI provides an intuitive interface that uses a touchscreen for quick and easy operation.

Range of applications

Providing various applications related to planning, machining, improvement and utility, for customer convenience.

NUMERIC CONTROL SPECIFICATIONS

FANUC

Item	Specifications	DN Solutions Fanuc i (0i Plus) DNM 4digit	
Controlled axis	Controlled axes	3 (X,Y,Z)	
	Simultaneously controlled axes	4 axes	
Data input/output	Additional controlled Axis	●	
	Fast data server	○	
	Memory card input/output	●	
	USB memory input/output	●	
	Large capacity memory(2GB)*2	○	
Interface function	Embedded Ethernet	●	
	Fast Ethernet	○	
	Enhanced Embedded Ethernet function	●	
Operation	DNC operation	Included in RS232C interface. ●	
	DNC operation with memory card	●	
Program input	Workpiece coordinate system	G52 - G59 ●	
	Addition of workpiece coordinate system	G54.1 P1 X 48 (48 pairs) ●	
	Tool number command	T4 digits	
	Tilted working plane indexing command	G68.2 TWP ○	
Feed function	AI contour control I	G5.1 Q_, 40 Blocks X	
	AI contour control II	G5.1 Q_, 200 Blocks ●	
	AI contour control II	G5.1 Q_, 600 Blocks X	
	AI contour control II	G5.1 Q_, 1000 Blocks *1) X	
	High smooth TCP	X	
Operation guidance function	EZ Guidei (Conversational Programming Solution)	●	
	iHMI with Machining Cycle	Only with 15" Touch LCD standard *2) X	
	EZ Operation package	●	
Setting and display	CNC screen dual display function	●	
	FANUC MTConnect	⊕	
Network	FANUC OPC UA	⊕	
Others	Display unit	10.4" color LCD	X
		15" color LCD	X
	Part program storage size & Number of registerable programs	15" color LCD with Touch Panel	●
		640M(256KB)_500 programs	X
		1280M(512KB)_1000 programs	X
		2560M(1MB)_1000 programs	X
		5120M(2MB)_1000 programs	●
		10240M(4MB)_1000 programs	X
		20480M(8MB)_1000 programs	X
		2560M(1MB)_2000 programs	X
		5120M(2MB)_4000 programs	X
		10240M(4MB)_4000 programs	X
		20480M(8MB)_4000 programs	X

*1) The number of look-ahead blocks may be changed or limited depending on the peripheral device or the configuration of the internal NC system.

*2) Available Option only with Fanuc i plus iHMI

● Standard ○ Optional X N/A ⊕ Available
Network: FANUC MT Connect and FANUC OPC UA available.

EZ WORK

The software developed by DN Solutions features numerous functions designed for convenience and ease of operation.

EZ work

The EZ work delivers speed and efficiency. This menu-driven innovation not only helps customers reduce setup times, but also simplifies common tasks and procedures, reducing the potential for errors. EZ work reduces operating time, protects machinery, enhances quality and speeds up maintenance interventions.



Thermal Compensation

A function to maintain high-precision machining quality by analyzing and correcting the amount of thermal displacement of a structure through a temperature sensor



M/G-Code List

Functional description of M code and G code



Tool Management

Function to manage tool information [Tool information / Tool No. / Tool condition (normal, large diameter, worn / damaged, used for the rst time, manual) / Tool name]



Operation Rate

Machine operation history management function by date based on load



Adaptive Feed Control

Function to control feedrate so that the cutting can be carried out at a constant load (To adapt to the spindle load set up with constant load feedrate control function)



Spindle Warm Up

A function that assists spindle warm-up for spindle life when the spindle has not been used for a certain period of time



ATC Recovery

Function to view detailed info with recommended actions and to perform step-by-step operation manually (when an alarm is triggered during an ATC operation)

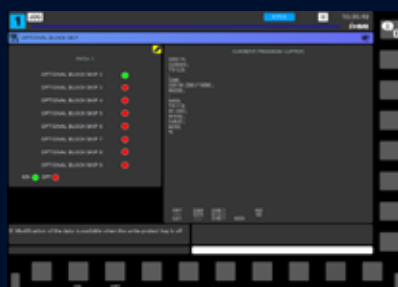

Addition of Optional Block Skip

In addition to the OPTIONAL BLOCK SKIP of the operation panel, the function to skip a specific block selected in the machining program

CONVENIENT OPERATION

HEIDENHAIN TNC620

Superior hardware specifications

The TNC 620 features optimized motion control, short block processing times and special control strategies. Together with its uniform digital design and its integrated digital drive control (including inverters), it enables you to achieve high machining speeds and the best possible contour accuracy.

- 15.6" display
- 21GB Storage memory
- 1024 look ahead blocks
- High user convenience with folder structure data management

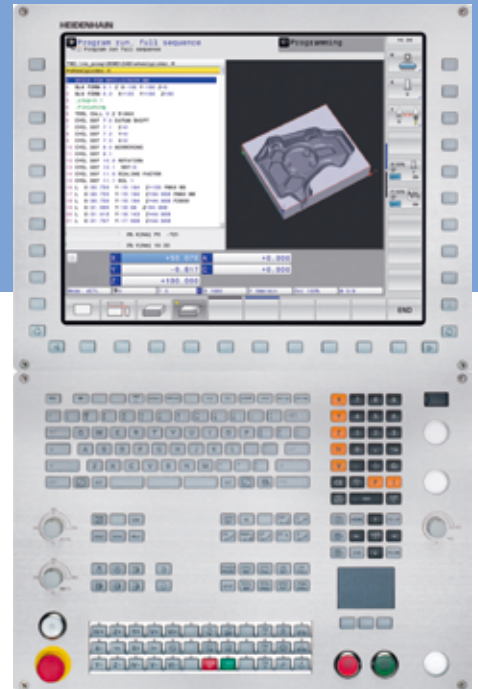

Conversational convenient function

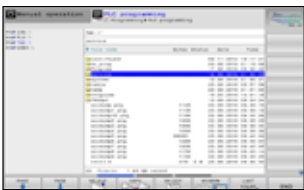

Data are controlled in the folder structure; convenient communication via USB devices



KinematicOpt & KinematicComp option
(Touch probe cycle for automatic measurement)

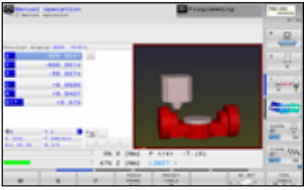

Collision protection system option

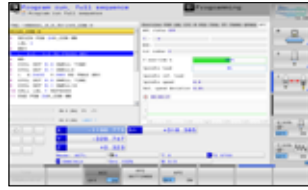

Adaptive feed control option



Various built-in pattern cycles for a wider scope of application (Software standard)

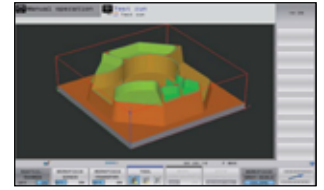

Graphic simulation

NUMERIC CONTROL SPECIFICATIONS



HEIDENHAIN

Item		Specifications	TNC620 DNM
Controlled axis	Controlled axis		3 (X,Y,Z)
	Simultaneously controlled axis		4 axis
Data input/output	USB memory input/output		●
Interface function	Embedded ethernet		●
Feed function	Look-ahead	5000 blocks	●
Axis compensation	KinematicsOpt	Automatic measurement and optimization of machine kinematics	○
Collision monitoring	Dynamic collision monitoring (DCM)		X
Network	MTConnect		⊕
Others	Display unit	15.1 inch TFT color flat panel	●
		15.1 inch TFT color with Touch Panel	○
		19 inch TFT color flat panel	○
		19 inch TFT color with Touch Panel	○
	Part program storage size & number of registerable programs	21GB 1.8GB	X ●

● Standard ○ Optional X Not Available ⊕ Available

CONVENIENT OPERATION

SIEMENS 828D

15.6" screen + new operation panel

The newly-designed operation panel improves the customer convenience by incorporating and using common-design buttons and layouts, and includes the familiar QWERTY keyboard for fast and easy operation.

- 15.6" display
- 10MB high capacity user memory
- USB & ethernet (standard)
- QWERTY keyboard (standard)
- High-speed calculation and simulation can be fulfilled by improved processor functionality



Conversational convenient function

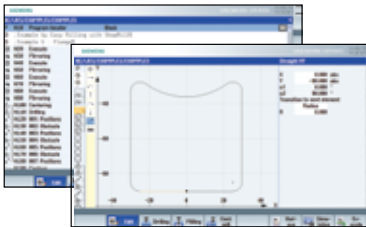

Shop Mill Part Programming

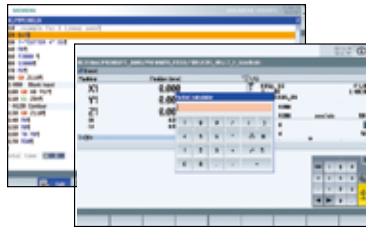

Smart function

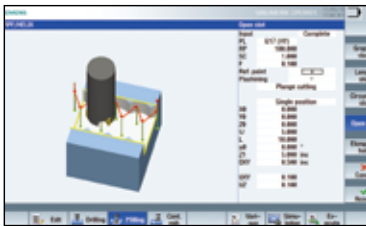

Advanced program language programGUIDE

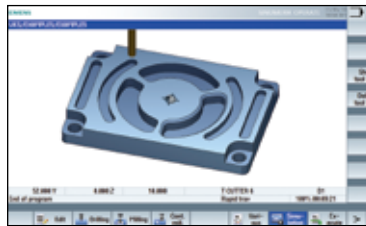

Simulation and machining contour monitoring

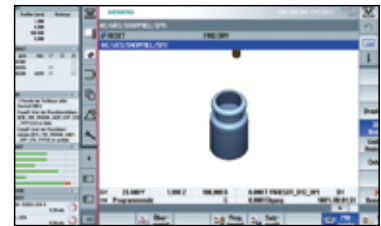

Side screen widget

NUMERIC CONTROL SPECIFICATIONS

SIEMENS

	Item	Specifications	S828D
			DNM
Controlled axis	Controlled axes (제어축수)	-	3축
	Simultaneously controlled axes (동시 제어축수)	-	3축
Data input/output	Memory card input/output	(Local drive)	X
	USB memory input/output		●
Interface function	Ethernet	(X130)	●
Operation	On network drive	(without EES option, Extcall)	○
	On USB storage medium, e.g. memory stick	(without EES option, Extcall)	●
Program input	Workpiece coordinate system	G54 - G57	●
	Addition of workpiece coordinate system	G505 - G599	●
Interpolation & Feed function	Advanced surface		●
	Top surface		○
Programming & Editing function	Look ahead number of block	S/W version 4.8	450
	3D simulation, finished part		●
	Simultaneous recording		●
	Measure kinematics		X
Operation Guidance Function	DXF Reader for PC integrated in SINUMERIK Operate		○
	ShopMill		●
Setting and display	EZ Work		●
	Operation via a VNC viewer		●
Network	MTConnect		⊕
	OPCUA		○
Etc. function	15.6" color display with touch screen		●
	19" color display without touch screen		X
	21.5" color display with touch screen		X
	CNC user memory	10 MB	●
	Expansion by increments	2 ~ 12 MB	○
	Collision avoidance		X
Collision avoidance ECO (machine, working area)		X	

● Standard ○ Optional X Not Available ⊕ Available

POWER | TORQUE

FANUC

FANUC 8000 r/min

8000 r/min

Max. spindle power: 18.5 kW (24.8 Hp)

Max. spindle torque: 118 N·m (87.1 ft-lbs)

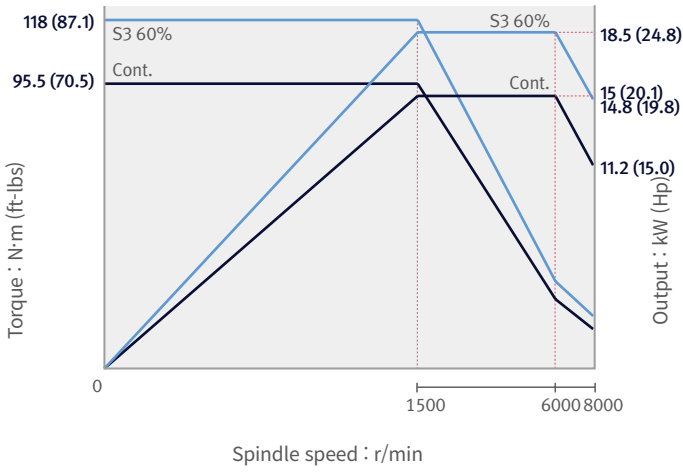

FANUC 30000 r/min option

30000 r/min

Max. spindle power: 91 kW (122.0 Hp)

Max. spindle torque: 62.9 N·m (46.4 ft-lbs)

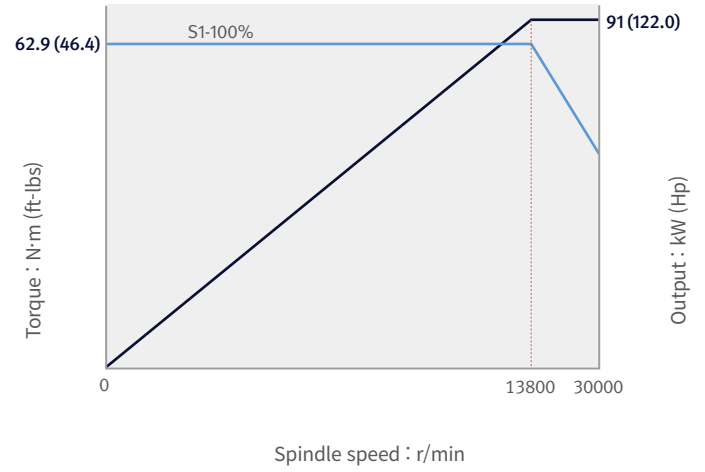

FANUC 12000 r/min option

12000 r/min

Max. spindle power: 28 kW (37.5 Hp)

Max. spindle torque: 159.1 N·m (117.4 ft-lbs)

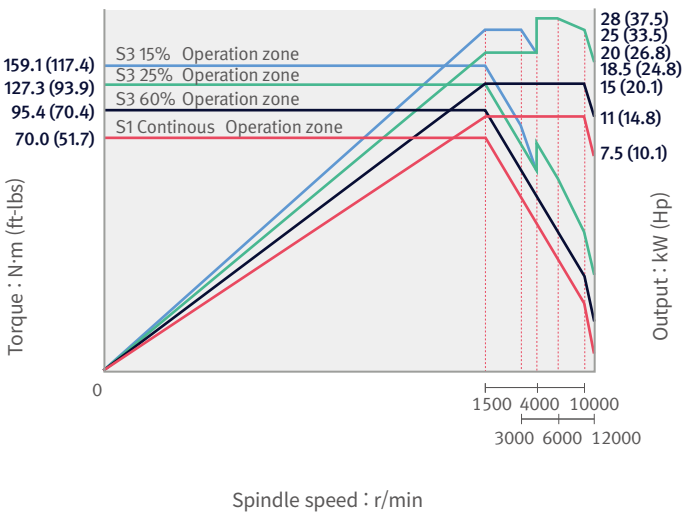

12000 r/min

Max. spindle power: 15.6 kW (20.9 Hp)

Max. spindle torque: 165.5 N·m (122.1 ft-lbs)

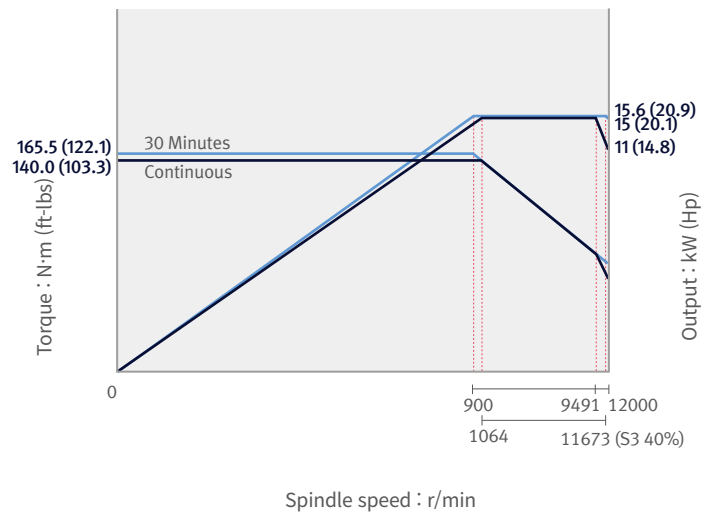

POWER | TORQUE

HEIDENHAIN | SIEMENS

HEIDENHAIN 8000 r/min

8000 r/min

Max. spindle power: 32 kW (42.9 Hp)

Max. spindle torque: 203.7 N·m (150.3 ft-lbs)

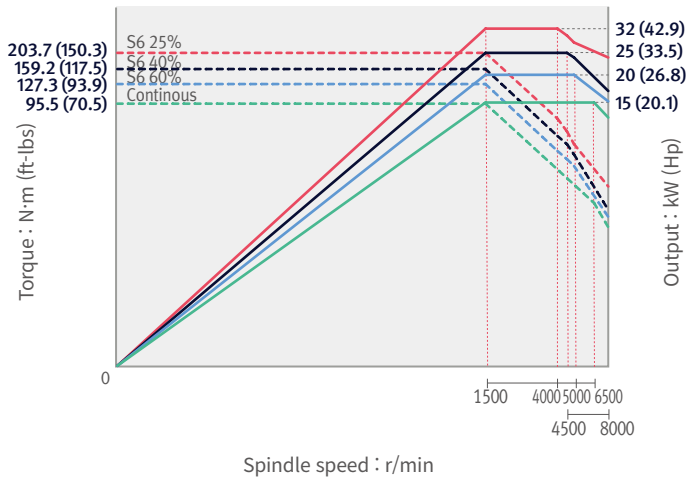

HEIDENHAIN 12000 r/min option

12000 r/min

Max. spindle power: 32 kW (42.9 Hp)

Max. spindle torque: 203.7 N·m (150.3 ft-lbs)

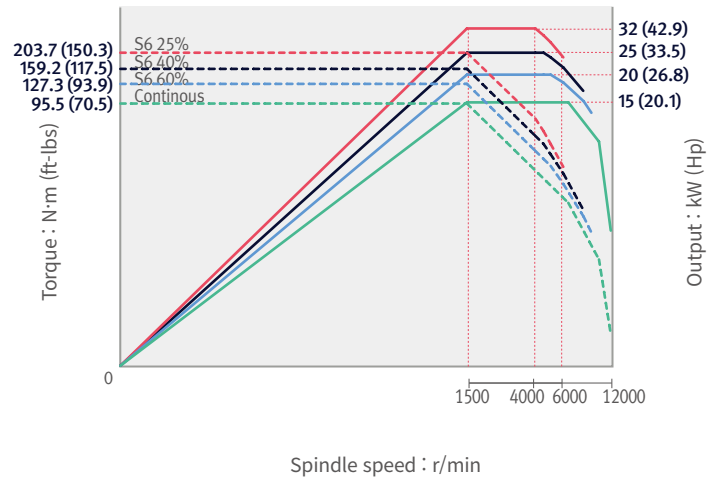

SIEMENS 8000 r/min

8000 r/min

Max. spindle power: 21.8 kW (29.2 Hp)

Max. spindle torque: 150.1 N·m (110.8 ft-lbs)

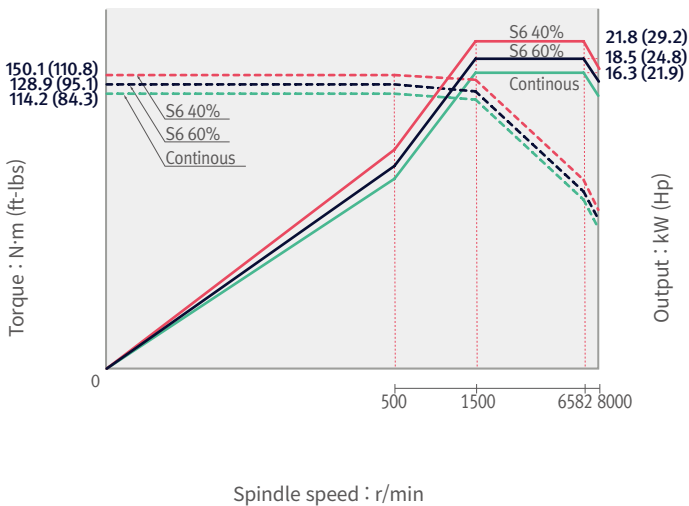

SIEMENS 12000 r/min option

12000 r/min

Max. spindle power: 16.5 kW (22.1 Hp)

Max. spindle torque: 141.3 N·m (104.3 ft-lbs)

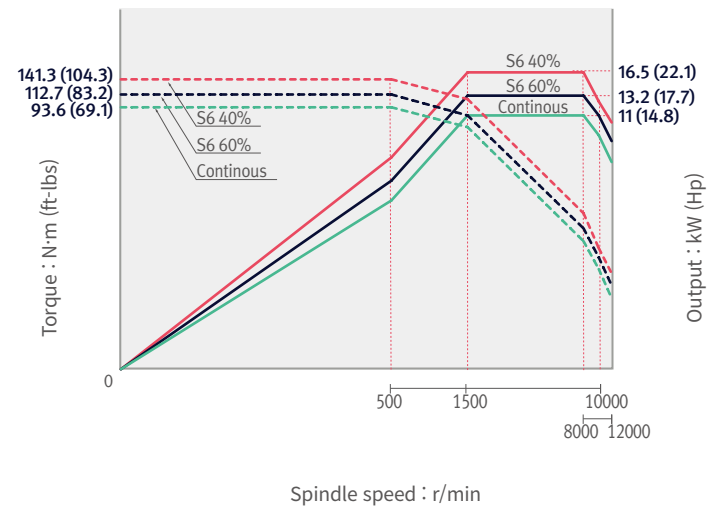

DIMENSIONS

Units : mm (inch)

TOP

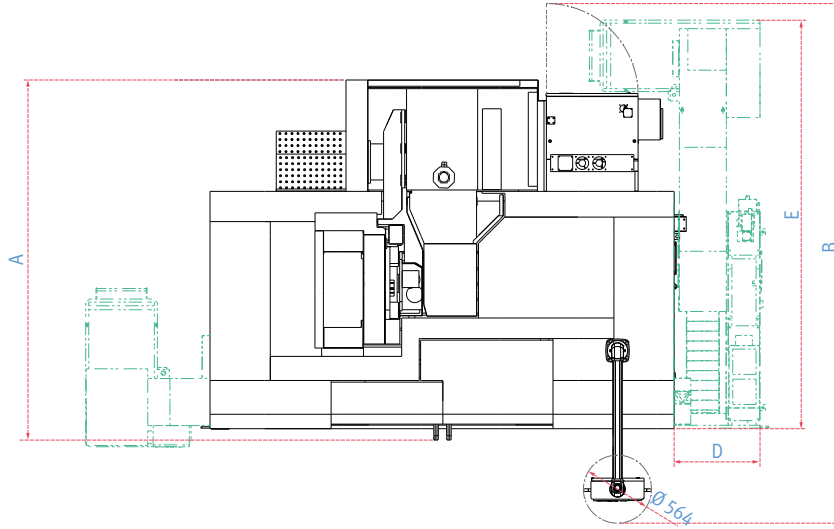

FRONT

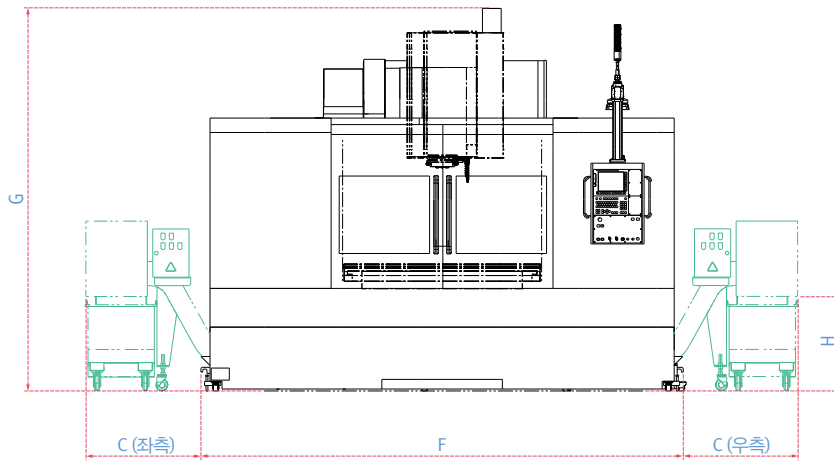

TABLE

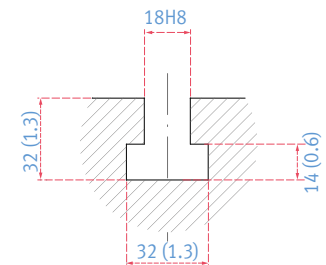
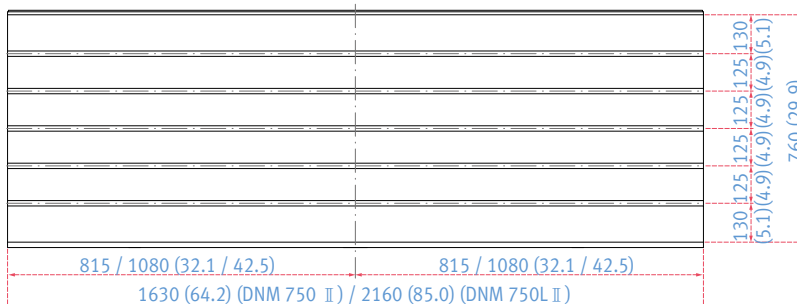

T-SLOT SECTION

Model	A (Length)	B (Max. machine length)	C (Additional width to accommodate the side chip conveyor)	D (Additional width to accommodate the rear chip conveyor)	E (Length to accommodate the rear chip conveyor)	F (Width)	G* (Height)	H (Height from the floor to the chip outlet)
DNM 750 II	2986 (117.6)	4309 (169.6)	Left & Right : 953 (37.5)	790 (31.1)	3390 (133.5)	4000 (157.5)	3170 / 3251 (124.8 / 128.0)	805 (31.7)
DNM 750L II	2986 (117.6)	4309 (169.6)	Left & Right : 953 (37.5)	790 (31.1)	3390 (133.5)	5050 (198.8)	3170 / 3251 (124.8 / 128.0)	805 (31.7)

* Some peripheral equipment can be placed in other places

* 8k spindle / 12k spindle

MACHINE SPECIFICATIONS

Description			Unit	DNM 750 II	DNM 750L II	
Travels	Travel distance	X axis	mm (inch)	1630 (64.2)	2160 (85.0)	
		Y axis	mm (inch)	762 (30.0)		
		Z axis	mm (inch)	650 (25.6)		
	Distance from spindle nose to table top		mm (inch)	150 ~ 800 (5.9 ~ 31.5)		
Table	Table size		mm (inch)	1630 x 760 (64.2 x 29.9)	2160 x 760 (85.0 x 29.9)	
	Table loading capacity		kg (lb)	1500 (3306.9)	1800 (3968.3)	
	Table surface type		mm (inch)	T-SLOT [5-125 (4.9) x 18 (0.7)H8]		
Spindle	Max. spindle speed	FANUC	Direct	r/min	8000	
				r/min	{12000}*	
				r/min	{12000}*	
		HEIDENHAIN	Belt	r/min	{30000}*	
				Direct	8000	
				Direct	{12000}*	
		SIEMENS	Belt	r/min	8000	
				Direct	{12000}*	
		Taper			-	ISO #40
	Spindle power	FANUC	Direct	kW (Hp)	18.5/15 (24.8/20.1)	
				kW (Hp)	{28/11 (37.5/14.8)}*	
				kW (Hp)	{15.6/15.6 (20.9/20.9)}*	
		HEIDENHAIN	Belt	kW (Hp)	32/15 (42.9/20.1)	
				Direct	{32/15 (42.9/20.1)}*	
		SIEMENS	Belt	kW (Hp)	21.8/16.3 (29.2/21.9)	
	Direct			{16.5/11 (22.1/14.8)}*		
	Max. spindle torque	FANUC	Direct	N · m (ft-lbs)	118 (87.1)	
N · m (ft-lbs)				{159.1 (117.4)}*		
N · m (ft-lbs)				{165.5 (122.1)}*		
HEIDENHAIN		Belt	N · m (ft-lbs)	203.7 (150.3)		
			Direct	{203.7 (150.3)}*		
SIEMENS		Belt	N · m (ft-lbs)	150.1 (110.8)		
	Direct		{141.3 (104.3)}*			
Feedrates	Rapid traverse rate	X axis	m/min (ipm)	30 (1181.1)	24 (944.9)	
		Y axis	m/min (ipm)	30 (1181.1)	24 (944.9)	
		Z axis	m/min (ipm)	24 (944.9)	24 (944.9)	
Automatic Tool Changer	Type of tool shank	Tool shank	-	BT 40 [CAT40/DIN40]*		
		Pull stud	-	PS806		
	Tool storage capa.		ea	30 {40}*		
	Max. tool diameter	Continuous	mm (inch)	80 (3.1) {76 (3.0)}*		
		Without Adjacent Tools	mm (inch)	125 (4.9)		
	Max. tool length		mm (inch)	300 (11.8)		
	Max. tool weight		kg (lb)	8 (17.6)		
	Max. tool moment		N · m (ft-lbs)	5.88 (4.3)		
	Tool selection		-	MEMORY RANDOM		
	Tool change time	Tool-to-tool	sec	1.3 1.6		
Chip-to-chip		sec	3.7 4.0			
Power source	Electric power supply (Rated capacity)		kVA	40.00 / 37.50 / 43.30		
	Compressed air supply		Mpa	0.54		
Tank capacity	Coolant tank capacity		L (gal)	520 (137.4)	590 (155.9)	
Machine Dimensions	Height		mm (inch)	3170 (124.8)		
	Length		mm (inch)	3480 (137.0)		
	Width		mm (inch)	3850 (151.6)	4900 (192.9)	
	Weight		kg (lb)	13500 (531.5)	15000 (590.6)	
Control	CNC system		-	DN Solutions Fanuc i Plus / SIEMENS S828D / HEIDENHAIN TNC620		

*{ } : Option

WHY DN SOLUTIONS

The DN Solutions promise, MACHINE GREATNESS, has two important meanings. The first is simple: DN Solutions makes great machines. The second is a challenge to our end-users. With a product line that is this comprehensive, accurate and reliable, we equip our customers to machine greatness. The big question: **Why should you choose DN Solutions over other options?**

Here's why...



**MACHINE
GREATNESS™**



WHAT YOU MAKE AND HOW YOU MAKE IT MATTERS—SO MAKE IT
GREAT WITH DN SOLUTIONS.

UNBEATABLE MACHINES

You won't find a more comprehensive range or a better combination of value, performance and reliability anywhere else.

ROBUST PRODUCT LINE

We offer an impressive range of machine models and hundreds of configurations. Whatever your machining needs and requirements, there's a DN Solutions for you.

READILY AVAILABLE - ANYWHERE IN THE WORLD

Machining centres (including 5-axis machines), lathes, multi-tasking turning centres and mill-turn machines, and horizontal borers with best-in-class specifications are all available...ready to install.

EXPERT SERVICE

Our dedicated, experienced and knowledgeable team is totally committed to improving your productivity, growth and success.

CUSTOMER SUPPORT AND SERVICES

We're there for you whenever you need us.

We help our customers operate at maximum efficiency by providing them with a range of tried, tested and trusted services - from pre-sales consultancy to post-sales support.

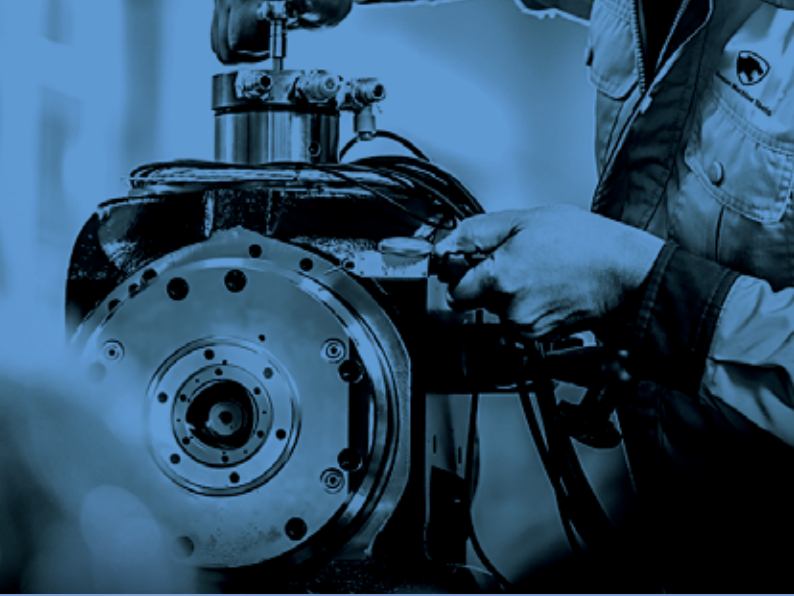

FIELD SERVICES

- On-site service
- Machine installation and testing
- Scheduled preventive maintenance
- Machine repair service



PARTS SUPPLY

- Supplying a wide range of original DN Solutions spare parts
- Parts repair service



TRAINING

- Programming, machine setup and operation
- Electrical and mechanical maintenance
- Applications engineering

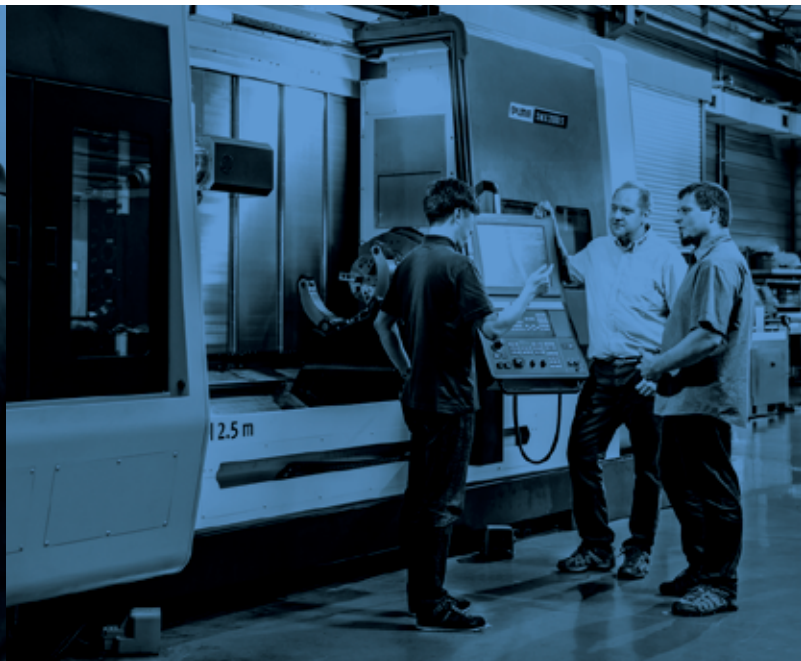

TECHNICAL SUPPORT

- Supports machining methods and technology
- Responds to technical queries
- Provides technical consultancy

RESPONDING TO CUSTOMERS ANYTIME, ANYWHERE

DN Solutions Global Network

DN Solutions provides systems-based professional support services, before and after the machine tool sale, by responding quickly and efficiently to customers. By supplying spare parts, product training, field service and technical support, we provide the expert care, attention and assistance our customers expect from a market leader.



Global sales and service support network

4	Corporations
155	Dealer networks
51	Technical centers Technical Center, Sales Support, Service Support, Parts Support
200	Service posts
3	Factories





dn-solutions.com

Head Office

22F T Tower, 30, Sowol-ro 2-gil
Jung-gu, Seoul, Korea, 04637

Tel: +82-2-6972-0370/0350
Fax: +82-2-6972-0400

DN Solutions America

19A Chapin Road, Pine Brook
New Jersey 07058, United States

Tel: +1-973-618-2500
Fax: +1-973-618-2501

DN Solutions Europe

Emdener Strasse 24, D-41540
Dormagen, Germany

Tel: +49-2133-5067-100
Fax: +49-2133-5067-111

DN Solutions India

No.82, Jakkuar Village
Yelahanka Hobli, Bangalore-560064

Tel: + 91-80-2205-6900
E-mail: india@dncompany.com

DN Solutions China

Room 101,201,301, Building 39 Xinzhuan
Highway No.258 Songjiang District
China Shanghai (201612)

Tel: +86 21-5445-1155
Fax: +86 21-6405-1472

Sales inquiry

sales@dncompany.com

* For more details, please contact DN Solutions.

* Specifications and information contained within this catalogue may be changed without prior notice.