

CATALOG & TECHNICAL GUIDE 2023.1

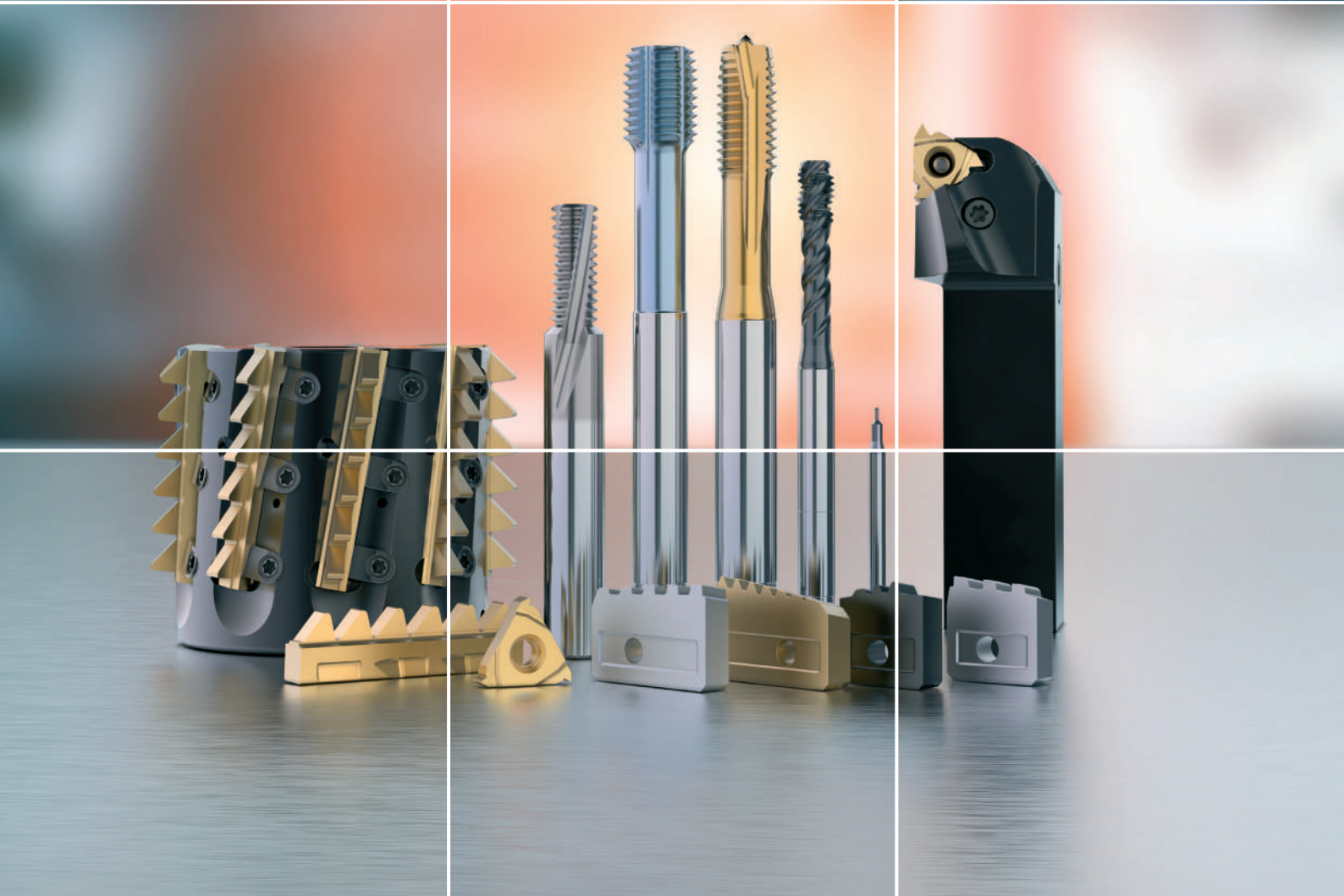

THREADING

>30,000

STANDARD PRODUCTS



>75

COUNTRIES



>4,100

DEDICATED EMPLOYEES



Headquartered in Fagersta, Sweden and present in more than 75 countries, Seco Tools is a leading global provider of metal cutting solutions for milling, stationary tools, holmaking and tooling systems.

For more than 80 years, the company has provided the technologies, processes and support that manufacturers depend on for maximum productivity and profitability. For more information on how Seco's innovative products and expert services bring success to manufacturers across all industry segments, please visit www.secotools.com.

Introduction

Alphanumeric index.....	2-5
Technical information	6-53

Thread turning

Jetstream Tooling® toolholders.....	54-59
External toolholders	60-69
Internal toolholders.....	70-78
Seco-Capto™ toolholders	79-95
Steadyline® GL-heads toolholders.....	96-98
Quick Change toolholders.....	99
Peeling toolholders.....	100-101
Pipe-facing toolholders.....	102-103
Seco-Capto™ Multi insert pocket toolholders.....	104-105
Chasers toolholders	106-113
Precision Grooves toolholders	114-123
Inserts.....	124-177
Chasers	178-179
Chipformers.....	180-182

Thread MDT

Toolholders.....	183-192
Inserts.....	193-195

Thread Mini-Shaft™

Toolholders.....	196-199
Inserts.....	200-206

Thread milling

Technical information	207-214
Threadmaster™	215-221
Cutting data	222-227
Code keys.....	228-229
Thread milling indexable	230-241
Thread milling shanks	242-248

Thread tapping

Threadmaster™ Taps technical information and overview	249-287
Threadmaster™ Taps	288-473

Annex

SMG Workpiece materials	474-485
Declaration of conformity	486-488

Thread turning	2		
	22NR/L*..RD	159	
Thread turning	3		
	335.14	243-244	
	335.14-ER	245	
MDT	A		
	A..CGGR/L	190	
	A..CGIR/L	189, 191	
	A..SGXN	197, 199	
	A..SGXN..R	197	
Mini-Shaft™	C		
	C..CER/L..X	108	
	C..CNR/L..X	108-110	
	C..CNR/L..C-X	111-112	
	C..CER/L	95	
	C..CER/L..CHD	81-82	
	C..CER/L..HD	79-80, 83, 94-95	
	C..CNR/L..CHD	91-93	
	C..CNR/L..HD	84-90	
	C..DSKNR/L-PCLNR/L	104	
	C..MSKNR/L-PCLNR/L	105	
	C..SNR	84-85	
	CEAR/L	115	
	CEAR/L..D	114	
	CEAR/L..HD	114	
	CEAR/L..QHD	114	
	CER/L	60	
	CER/L..D	123	
	CER/L..Q	120	
	CER/L..QHD	69, 122-123	
	CER/L..CQHD	67	
	CER/L..Q	61	
	CER/L..QHD	61, 64-65	
	CER/L..Q-S	68	
	CER/L..HD	60, 69	
	CER/L..Q	62-63	
	CER/L..QHD	60, 62-63	
	CER..X	106-107	
	CER..16HD	61	
	CER..CQHD	66	
	CFIR/L	184	
	CFIR/L..JET	188	
	CFMR/L	186	
	CFMR/L..JET	188	
	CFOR/L	187	
	CFSR/L	185	
	CFTR/L	187	
	CNR/L	119	
	CNR/L..A	118	
	CNR/L..AHD	78, 121	
	CNR/L..DA	118	
	CNR/L..H	119	
	CNR/L..AHD	73-76	
	CNR/L..APIHD	75-76	
	CNR/L..AHD	71-72	
	CNR/L..APIHD	71	
	CSXCR/L	100-101	
Thread tapping	D		
	DTM-M	220	
	DTM-MF	220	
	DTM-UNC	220	
	DTM-UNF	220	
	DTM-W	221	
Annex	E		
	E..SGXN	198-199	
	E..SGXN..R	198	
	G		
	GL..CNR/L	98	
	GL..CNR/L..X	113	
	GL..PNR/L	96-97	
	M		
	MF-V060-A	472	
	MF-V063-A	473	
	MSGNR/L	102-103	
	MTH-M003	435	
	MTH-M003-A	436	
	MTH-M004	437	
	MTH-M004-A	438	
	MTH-N001	439	
	MTH-N002	440	
	MTH-P001	425	
	MTH-P001-A	426	
	MTH-P002	427	
	MTH-P002-A	428	
	MTH-P003	429	
	MTH-P003-A	430	
	MTH-P004	431	
	MTH-P004-A	432	
	MTH-P011	433-434	
	MTH-S001	441	
	MTH-S002	442	
	MTH-S003	443	
	MTH-S004	444	
	MTH-S011	445	
	MTH-S012	446	
	MTH-S031	447	
	MTH-S032	448	
	MTH-S041	449	
	MTH-S042	450	
	MTH-S043	451	
	MTH-S044	452	
	MTH-S101	453	
	MTH-S102	454	
	MTH-S111	455	
	MTH-S112	456	
	MTH-S142	457	
	MTH-V015	458	
	MTH-V016	459	
	MTH-V048	460	
	MTH-V050	461	
	MTP-M003-A	411	
	MTP-M004	412	
	MTP-M004-A	413	
	MTP-N001	414	
	MTP-N001-A	415	
	MTP-N002	416	
	MTP-N002-A	417	
	MTP-P001	403	
	MTP-P002	404	
	MTP-P003	405	
	MTP-P003-A	406	
	MTP-P004	407	
	MTP-P004-A	408	
	MTP-P011	409-410	
	MTP-S001	418	
	MTP-S002	419	
	MTP-S011	420	
	MTP-S012	421	
	MTP-S013	422	
	MTP-S042	423	
	MTP-S043	424	
	MTS-K002	464	
	MTS-K002-A	465	
	MTS-K101	462	
	MTS-K101-A	463	
	MTS-K102	466	

MTS-K102-A	467	T34-PHB-micro, M	337-338
MTS-K111	468	T34-R45HC, G.	377
MTS-K121	469	T34-R45HC, M	360-361
MTS-K131	470	T34-R45HC, MF	366-367
MTS-K141	471	T34-R45HC, UNC	373-374
		T34-R45HC, UNF	375-376
P		T34-R45HC-micro, M	358-359
PER..QHDJETI	55-56	T34-R45HE, EGM	378-379
PNR/L..AHDJET	57-59	T34-R45HE, EGUNC.	380-381
		T34-R45HE, EGUNF.	382-383
Q		T34-R45HE, M.	362-363
QC...-PER/L...HDJET	99	T34-R45HE, MF	368-369
		TM-M	216-217
R		TM-MF	217
R396.18	231-232, 237	TM-MINI	219
R396.19	231-235, 237	TM-NPT	218
R396.20	236-237	TM-NPTF	218
		TM-UNC	217
		TM-UNF	218
		TM-W	218
S		V	
SNR/L70, 77, 116-117	V21-CMR/L	192
SNR...A	70		
T			
T32-PNB, G.	317		
T32-PNB, M.	301-305		
T32-PNB, M 6G.	306-307		
T32-PNB, MF.	310-312		
T32-PNB, M LH.	308-309		
T32-PNB, UNC	313-314		
T32-PNB, UNF	315-316		
T32-PNB-micro, M.	299-300		
T32-R40NC, G.	336		
T32-R40NC, M	320-324		
T32-R40NC, M 6G.	325		
T32-R40NC, MF	329-331		
T32-R40NC, M LH.	326-328		
T32-R40NC, UNC	332-333		
T32-R40NC, UNF	334-335		
T32-R40NC-micro, M	318-319		
T32-SNC, G.	298		
T32-SNC, M.	290-292		
T32-SNC, MF	295-297		
T32-SNC, M LH.	293-294		
T32-SNC-micro M	289		
T32-SNC-micro – M.	288		
T33A-FSCE, M	399		
T33B-FSCE, M	400		
T33-FNC, M.	384-385		
T33-FSCC, M	397		
T33-FSCC, MF	401-402		
T33-FSCE, M.	398		
T33-FSNC, G.	396		
T33-FSNC, M	386-387		
T33-FSNC, M 6G.	388-389		
T33-FSNC, MF	390-391		
T33-FSNC, UNC	392-393		
T33-FSNC, UNF	394-395		
T34A-R45HC, M	364-365		
T34A-R45HC, MF	370-371		
T34A-R45HE, MF	372		
T34B-PHB, M	341-342		
T34B-PHB, MF	345-346		
T34-PHB, EGM	352-353		
T34-PHB, EGUNC.	354-355		
T34-PHB, EGUNF.	356-357		
T34-PHB, G.	351		
T34-PHB, M.	339-340		
T34-PHB, MF	343-344		
T34-PHB, UNC	347-348		
T34-PHB, UNF	349-350		

Thread turning

09NR
 ..A55 126
 ..A60 129
 ..BSPT 153
 ..ISO 134-135
 ..NPT 155
 ..UN 141-142
 ..W 150-151

10-11..
 179

MDT

11NR/L
 ..A55 126
 ..A60 129
 ..ISO 134-136
 ..NPT 155
 ..UN 141-143
 ..W 150-151

11NR
 ..NPTF 157

13NMS
 238

13XMS
 238

Mini-Shaft™

16ER/L
 ..A55 125
 ..A60 127
 ..ACME 162
 ..AG55 125
 ..AG60 127
 ..APIRD 172
 ..BSPT 152
 ..BUT 166
 ..G55 125
 ..G60 127
 ..ISO 131-133
 ..MJ 146
 ..NPT 154
 ..NPTF 156
 ..RD 158
 ..STACME 164
 ..TR 160
 ..UN 138-142
 ..UNJ 144
 ..W 148-149

16ER
 ..STACME 164

Thread milling

16NR/L
 ..A55 126
 ..A60 129
 ..ACME 163
 ..AG55 126
 ..AG60 129-130
 ..API RD 173
 ..BSPT 153
 ..BUT 167
 ..G55 126
 ..G60 129-130
 ..ISO 134-136
 ..MJ 147
 ..NPT 155
 ..NPTF 157
 ..RD 159
 ..STACME 165
 ..TR 161

Thread tapping

..UN 141-143
 ..UNJ 145
 ..W 150-151
 ..NPTF 157

20ER
 ..ACME 162
 ..STACME 164
 ..TR 160

20NR
 ..ACME 163
 ..STACME 165
 ..TR 161

22ER/L
 ..ACME 162
 ..API 168
 ..API RD 172
 ..BUT 174, 176
 ..HEF 170
 ..ISO 131-135
 ..N55 125
 ..N60 127-128
 ..NPT 154
 ..PAC 170
 ..RD 158
 ..STACME 164
 ..TR 160
 ..UN 138-139
 ..W 148-149

22NR/L
 ..ACME 163
 ..API 169
 ..BUT 175, 177
 ..HEF 171
 ..ISO 134-137
 ..N55 126
 ..N60 129-130
 ..NPT 155
 ..PAC 171
 ..RD 159
 ..STACME 165
 ..TR 161
 ..UN 141-143
 ..W 150-151

26ER
 ..ACME 162
 ..K55 125-126
 ..K60 127, 129
 ..STACME 164
 ..TR 160

26NR
 ..ACME 163
 ..K55 125
 ..K60 127, 129
 ..TR 161

27ER/L
 ..ACME 162
 ..API 168
 ..H 170
 ..ISO 131-132
 ..PAC 170
 ..RD 158
 ..TR 160
 ..UN 138

Annex

27ER	
..API.....	172
..ISO.....	131-132
..NPT.....	155
..STACME.....	164
27NR/L	
..API.....	169
27NR	
..ACME.....	163
..API.....	169, 173
..H.....	171
..ISO.....	134, 136
..PAC.....	171
..RD.....	159
..STACME.....	165
..TR.....	161
..UN.....	141
5-11..	
.....	178
5-31..	
.....	178
5-31...	
.....	178
5-51..	
.....	178
8-11..	
.....	178
8-21..	
.....	178
8-41..	
.....	178
8-51..	
.....	178-179
C-..	
.....	180-182
LCEX	
.....	200-206
LCGN	
.....	193-195
R335.14...MNP	
.....	247
R335.14...UNNF	
.....	248
R335.14...WXF	
.....	246
S-41..	
.....	178
SCNN	
.....	124
TOOLSET	
16V55.....	125
16V60.....	127

Code keys

Toolholders



C	E	R	25	25	M	16	Q	HD
1	2	3	4	5	6	7	8	9

1. Insert clamping

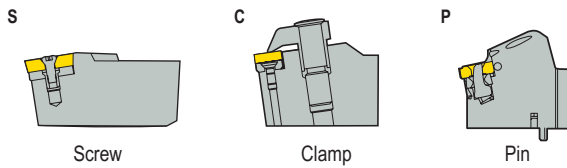

2. External/Internal

E = External
N = Internal

3. Cutting direction

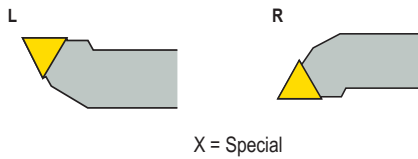

4. Shank height

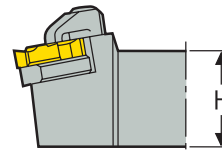

00 = Round toolholders S & C
25 = 25 mm (0.984")
32 = 32 mm (1.260")
etc.

5. Shank width/diameter

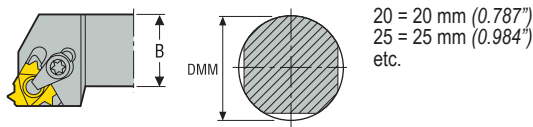

20 = 20 mm (0.787")
25 = 25 mm (0.984")
etc.

6. Tool length

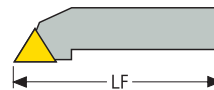

H = 100 mm (3.937")
K = 125 mm (4.921")
L = 140 mm (5.512")
M = 150 mm (5.906")
P = 170 mm (6.693")
Q = 180 mm (7.087")
R = 200 mm (7.874")
S = 250 mm (9.843")
T = 300 mm (11.811")
U = 350 mm (13.780")
V = 400 mm (15.748")

7. Cutting edge length

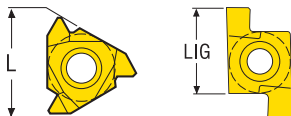

If the cutting edge length consists of only one digit, the designation should start with a 0.

Example:
Cutting edge length = 16,5 mm (0.650")
Symbol = 16
Cutting edge length = 9,525 mm (0.375")
Symbol = 09

8. Other information

A = Steel with coolant passage
Q = Toolholder/cranked
CQ = For mounting upside down

9. Other information

H = High density bar
HD = Heavy duty
JET = Jetstream Tooling®
JETI = Jetstream Tooling® Jeti

Code keys

Toolholders

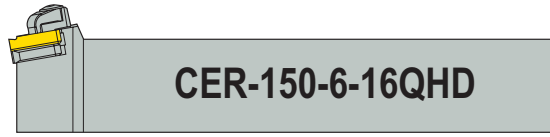

C	E	R		- 150	- 6	- 16	Q	HD
1	2	3	4	5	6	7	8	9

1. Insert clamping		2. External/Internal	
<p>S</p> <p>Screw</p>	<p>C</p> <p>Clamp</p>	<p>P</p> <p>Pin</p>	<p>E = External N = Internal</p>
3. Cutting direction		4. Shank definition	
<p>L</p>	<p>R</p>		<p>00 = Boring bars = Square shanks</p>
<p>X = Special</p>			
5. Square shank height/width and bar diameter		6. Tool length	
	<p>For square shank tools height and width in inches. For boring bars bar diameter in inches. 075 = 0.75 100 = 1.00 125 = 1.25 etc.</p>		<p>3 = 3 inches 4 = 4 inches 5 = 5 inches 6 = 6 inches</p>
7. Cutting edge length		8. Other information	
		<p>A = Steel with coolant passage Q = Qualified CQ = For mounting upside down</p>	
<p>If the cutting edge length consists of only one digit, the designation should start with a 0.</p>			
<p>Example: Cutting edge length = 16,5 mm (0.650") Symbol = 16 Cutting edge length = 9,525 mm (0.375") Symbol = 09</p>			
9. Other information			
		<p>H = High density bar HD = Heavy duty JET = Jetstream Tooling® JET1 = Jetstream Tooling® Jeti</p>	

Thread turning

MDT

Mini-Shaft™

Thread milling

Thread tapping

Annex

Code keys

Inserts

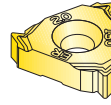

16	E	R	1.5	ISO	-	A1
1	2	3	4	5		6

1. Cutting edge length

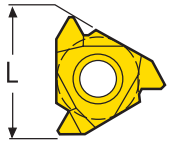

Example:
Cutting edge length = 16,5 mm (0.650")
Symbol = 16
Cutting edge length = 9,525 mm (0.375")
Symbol = 09

If the cutting edge length consists of only one digit, the designation should start with a 0.

2. External/Internal

E = External
N = Internal

3. Cutting direction



X = Special

4. Pitch

Full profile: (mm)	0,50	1,25	3,00	6,00	
	0,70	1,50	4,00	8,00	
	0,75	1,75	4,50	10,0	
	0,80	2,00	5,00	12,0	
	1,00	2,50	5,50	14,0	
Full profile: (TPI)	48	18	11	6,0	2,5
	40	16	10	5,0	2,0
	32	14	9	4,5	
	24	13	8	4,0	
	20	12	7	3,0	
Partial profile:	A	= 0,50-1,50 mm	48-16 TPI		
	AG	= 0,50-3,00 mm	48-8 TPI		
	G	= 1,75-3,00 mm	14-8 TPI		
	N	= 3,50-5,00 mm	7-5 TPI		
	K	= 5,50-10,00 mm	4,5-2,5 TPI		

5. Thread

Thread =	= V profile, 60°
60	= V profile, 55°
55	= ISO, Metric
ISO	= Am. UN
UN	= Am. Aerospace
UNJ	= Metr. Aerospace
MJ	= Whitworth, BSW
W	= Whitworth, Taper
BSPT	= Am. NPT
NPT	= Am. NPTF (Dryseal)
NPTF	= Round, DIN405
RD	= Trapezoidal, DIN103
TR	= Am. ACME-G
ACME	= Am. Stub-ACME
STACME	= API V 038R 1:4
API 384	= API V 038R 1:6
API 386	= API V 040 1:4
API 404	= API V 050 1:4
API 504	= API V 050 1:6
API 506	= API Round Casing
API RD	= Buttress, 1°47'
BUT 2.5	= Buttress, 2°23'
BUT 2.6	

6. Number of teeth per cutting edge/ Type of chipbreaker

2M = 2 teeth
3M = 3 teeth
TT = TWIN THREADER

A = Universal
A1 = Chipbreaker designation
A2 = Chipbreaker designation

Selection process

Seco Suggest

In order to simplify the selection of tools and cutting parameters Seco Tools introduce Suggest which eliminates complicated searching, programming and calculation. Suggest gives you the best suggestion of holder, insert and optimized parameters for your application and the possibility to download information to the CNC machine.

The application can be found at <https://www.secotools.com/dashboard/Suggest/Suggest>.

Use the selection process below to choose a suitable tool, insert, cutting data and production method.



1. Selection of production method, page 10.

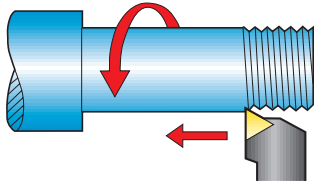

2. Selection of insert type, page 11.

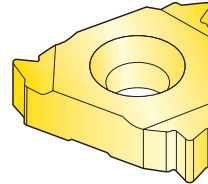

3. Selection of grade, page 12.

	ISO														
	P				M				K						
	P01	P10	P20	P30	P40	P50	M10	M20	M30	M40	K01	K10	K20	K30	K40
CP200															
CP300															
CP500															
H15															

4. Selection of toolholder, page 14.

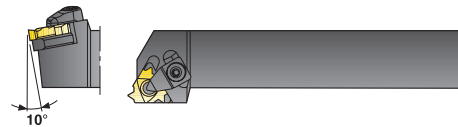

5. Selection of insert shim, pages 15-16.

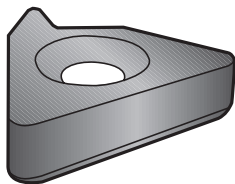

6. Selection of cutting speed, pages 17-21.

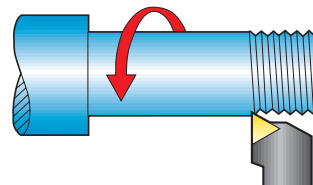

7. Selection of number of passes and infeed depths, pages 22-33.

Ph	6.0	5.5	5.0	4.5	4.0	3.5	3.0	2.5	2.0
a_p	3,82 (0.150)	3,52 (0.139)	3,19 (0.126)	2,87 (0.113)	2,53 (0.100)	2,23 (0.088)	1,92 (0.076)	1,60 (0.063)	1,25 (0.049)
1	0,46 (0.018)	0,43 (0.017)	0,41 (0.016)	0,37 (0.015)	0,34 (0.013)	0,34 (0.013)	0,28 (0.011)	0,27 (0.011)	0,24 (0.009)
2	0,43 (0.017)	0,40 (0.016)	0,39 (0.015)	0,34 (0.013)	0,32 (0.013)	0,31 (0.012)	0,26 (0.010)	0,24 (0.009)	0,22 (0.009)

8. Selection of infeed method, page 34.

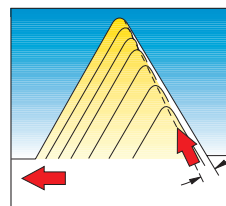

Production methods

Workpiece
-External or internal thread
-Right or left hand thread
Machine
-Right or left hand tool

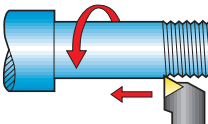
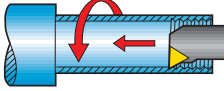
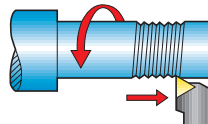
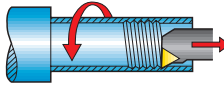
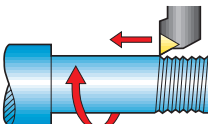
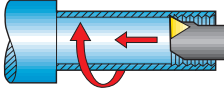
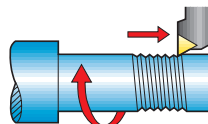
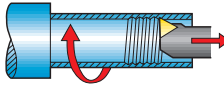
Threading towards the chuck		Threading away from the chuck*	
Benefit: <ul style="list-style-type: none"> • Best stability • Originally fitted insert shims can be used for most operations 	Note: <ul style="list-style-type: none"> • Chip build-up may occur during internal threading, particularly if there is little space between the threading bar and bore of the hole 	Benefit: <ul style="list-style-type: none"> • Chip flow is correctly directed during internal threading 	Note: <ul style="list-style-type: none"> • Secure clamping of the insert and mounting of the toolholder are necessary
Internal threading: <ul style="list-style-type: none"> • Use only CNR/L toolholders 			
Right-hand thread – Right-hand tool		Left-hand thread – Right-hand tool	
 ER	 NR	 ER	 NR
Left-hand thread – Left-hand tool		Right-hand thread – Left-hand tool	
 EL	 NL	 EL	 NL

*Notice that the insert shim must be changed when threading away from the chuck.

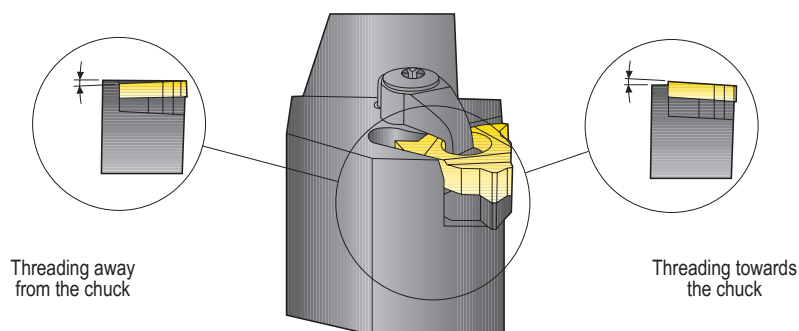

Thread turning

MDT

Mini-Shaft™

Thread milling

Thread tapping

Annex

Insert types

For single tooth inserts choose a full profile or partial profile design

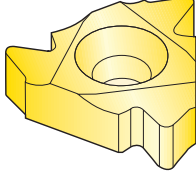
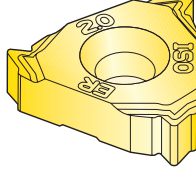
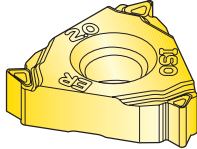
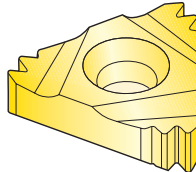
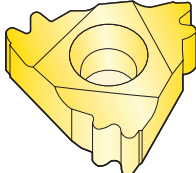
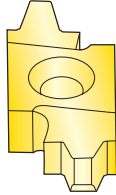
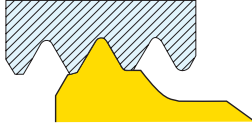
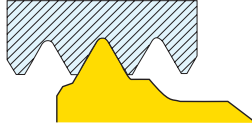
<p>Single-tooth insert (Type S) A or Original</p>	<p>Single-tooth insert (Type S) A1 chipbreaker</p>
<p>First choice, can be used for applications in a variety of materials. Low cutting forces.</p> 	<p>First choice for general applications in steel.</p> 
<p>Single-tooth insert (Type S) A2 chipbreaker</p>	<p>Multi-tooth insert (Type M)</p>
<p>First choice for general applications in stainless steel.</p> 	<p>First choice for mass production, since fewer passes are necessary. Only for radial infeed. 2M = 2 teeth version 3M = 3 teeth version</p> 
<p>Multi-tooth insert (TWIN THREADER, TT)</p>	<p>K insert (Type K)</p>
<p>Lower cutting forces than M type. Shorter undercut length than M type. Only for radial infeed. Use insert shim for 2M.</p> 	<p>First choice for large/coarse threads.</p> 
<p>Full profile</p>	<p>Partial profile</p>
<p>By topping the thread, the workpiece need not be pre-machined to the exact diameter and may be a little oversized for external threads and undersize for internal threads. The threading operation is simplified since only one tool is needed for the entire thread (no subsequent deburring is needed).</p> 	<p>Covers a wide range of thread pitches, which simplifies stock-keeping. Requires a correct workpiece diameter prior to threading. The nose radius of the insert is sized to suit the smallest profile within the pitch range of the insert.</p> 

Thread turning

MDT

Mini-Shaft™

Thread milling

Thread tapping

Annex

Insert grades

Thread turning – Insert grades

Continuous research and development of better materials, coatings and optimal geometries help fulfil customers requirements.

Our product strategy is to provide the market with versatile first choice tools and specific optimized solutions for threading.

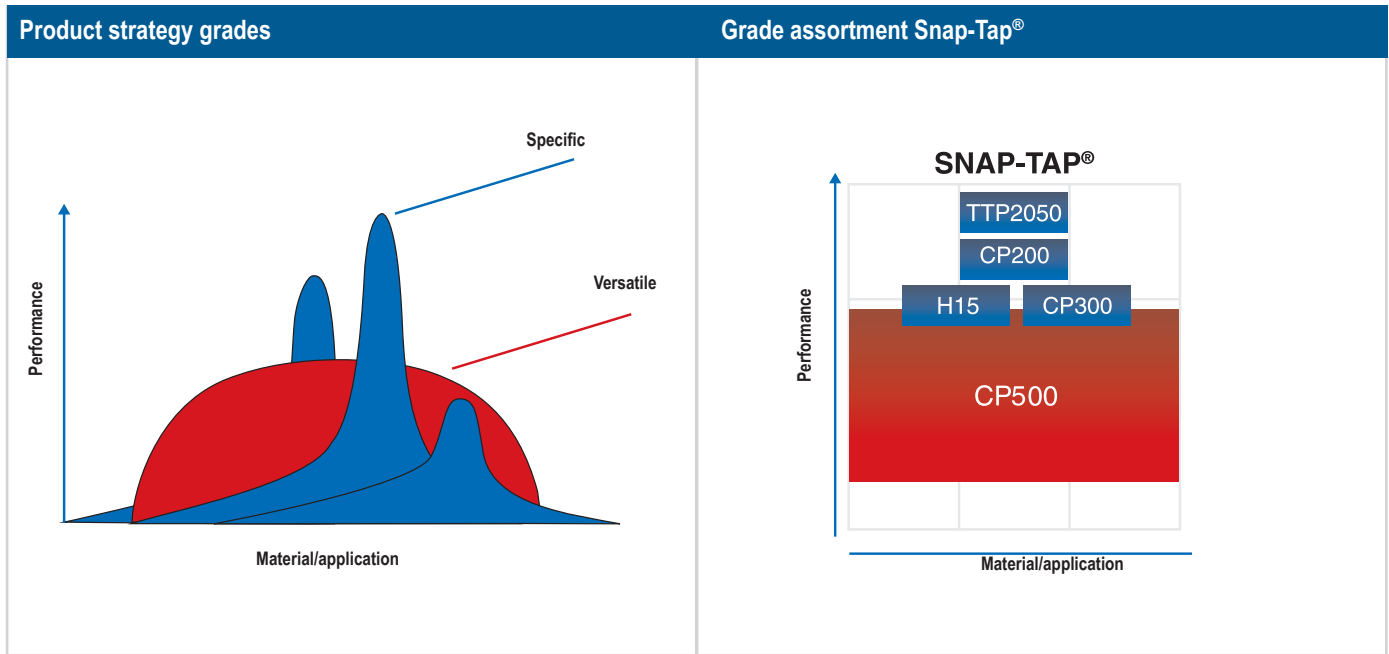

Thread turning

MDT

Mini-Shaft™

Thread milling

Thread tapping

Annex



Insert grades

Grades

The black areas in the chart indicate a grade's main ISO application groups and the white areas indicate other supplementary application groups.

	P					M				K				N				S			H						
	P01	P10	P20	P30	P40	P50	M01	M10	M20	M30	M40	K01	K10	K20	K30	K40	N01	N10	N20	N30	S01	S10	S20	S30	H01	H10	H20
CP200																											
CP300																											
CP500																											
TTP2050																											
H15																											

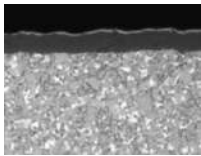
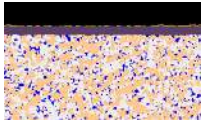
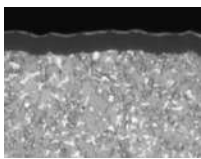
PVD coated grades

CP200		First choice for high-strength steel, martensitic stainless steel, cast iron with low hardness, superalloys and titanium alloys. First choice for high cutting speeds. Hard micrograin with sharp edge, highly resistant to plastic deformation. (Ti,Al)N + TiN
CP300		Wear-resistant grade which is principally intended for high cutting speeds. Optimizing grade in steel and stainless steel. (Ti,Al)N + TiN
CP500		Universal very tough micrograin grade for all types of threading in most materials. Excellent for stainless steel and difficult operations. (Ti,Al)N + TiN
TTP2050		Peak performance, wear resistant micrograin grade to be used in steel, stainless steel and cast iron. The nano-laminated coating increases the wear resistance of the grade. (TiAl)N/(TiSi)N
TTP1550		Fine grain wear resistant grade for optimized performance in carbon steels. (TiAl)N

Uncoated grades

H15		First choice for machining normal to hard cast iron. Also suitable for hard steel with a hardness in excess of 350 HB. Micrograin with excellent wear-resistance and sharp edge.
-----	---	--

Toolholders

Use the guidelines below to choose a suitable toolholder type.

External threading

Basic choice
 Type C (clamp)
 Type P (Pin)

CER/L, PER/L

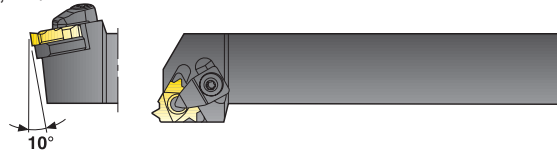

Insert size
 16, 20, 22, 26, 27
 With insert shim

Cx-CER/L

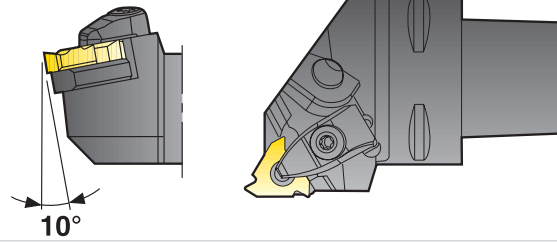

Internal threading

Basic choice
 Type C (clamp)
 Type P (Pin)

CNR/L, PNR/L

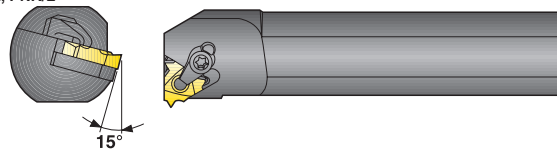

Insert size
 16, 20, 22, 26, 27
 With insert shim

Cx-CNR/L

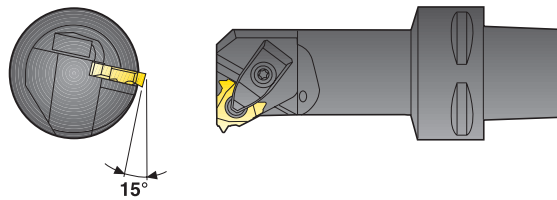

N.B. On 27 mm inserts this angle is 10°

For small holes
 Type-S (screw)

SNR/L

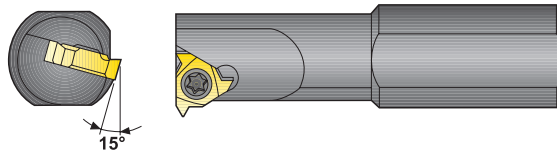

Insert sizes
 09, 11, 16, 22

(No insert shim. To be used only when
 threading towards the chuck)

Insert shim

Originally fitted insert shims

The table below shows the originally fitted insert shims. These insert shims are suitable for most operations when threading towards the chuck.

	Clamp		Screw	Jetstream Tooling®
Toolholders				
	External and internal threading		Internal threading	External and internal threading
Insert type	Single-tooth insert (Type S)		Single-tooth insert (Type S)	Single-tooth insert (Type S)
Insert shim			No insert shim ($\lambda=2^\circ$)	
Insert size	16 20 22 26 27	GX 16-1 KX 20-2 NX22-1 KX26-2 VX27-1		GXA16-1 NXA22-1 VXA27-1

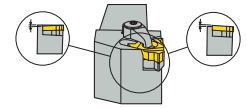

The helix angle can be selected from +5 to -2 by changing the insert shim. The same insert shims are used for both right and left hand toolholders. The centre height remains constant.

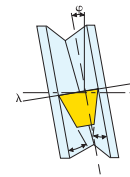

To receive the correct shape on the thread and uniform wear on the insert the cutting edge helix angle (λ) should be equal to the thread lead angle (ϕ).

The helix angle (λ) can also be calculated. See page 35 for formula.

SNR/L toolholders have no exchangeable insert shim and can therefore only be used for threading towards the chuck. The table below shows the available insert shim range.

Insert shim range

	Clamp					Jetstream Tooling® Thread turning		
Toolholders								
	External and internal threading					External and internal threading		
Insert type	Multi-tooth insert (Type M)	Single-tooth insert (Type S)			Single-tooth insert (Type K)	Multi-tooth insert (Type M)	Single-tooth insert (Type S)	
Insert shim								
	Threading towards the chuck	Threading towards the chuck	Threading away from the chuck	Threading towards the chuck	Threading away from the chuck	Threading towards the chuck	Threading towards the chuck	Threading away from the chuck
Insert size	16 20 22 26 27	MX16-1 NX22-1	GX16-0, -1, -2, -3, -4 NX22-0, -1, -2, -3, -4 VX27-0, -1, -2, -3, -4	GX16-0 -99 -98 NX22-0 -99 -98 VX27-0 -99 -98	KX20-0, -1, -2, -3, -4, -5 KX26-0, -1, -2, -3, -4, -5	KX20-0, -99 KX26-0, -99	MXA16-1 MXA22-1 MXA27-1	GXA16-0, -1, -2, -3, -4 NXA22-0, -1, -2, -3, -4 VXA22-0, -1, -2, -3, -4

SMG – Cutting data

In SMG classification of workpiece materials involves a specific material standard in a specific condition assigned as reference for easy and unambiguous adjustment of cutting data for any actual material compared to any Seco reference material. As examples the reference materials EN C45E for SMG P4 and EN 42 CrMo 4 for both SMG P5 and SMG H5 shown below in table 1 where the reference level material property is indicated. A more complete extract can be found on page(s) 474-485.

SMG	Description	Properties	Reference	SMG	Description	Properties	Reference
P4	Low-alloy general structural steels, 0.25% < C < 0.67%wt Low-alloy Quench & Temper steels	520 < R _m < 1200	C 45E R _m = 660 N/mm ²	H5	Quenched & Tempered steels	38 < HRC < 56	42 CrMo 4 50 HRC
P5	Structural steels, 0.25% < C < 0.67%wt Quench & Temper steels	550 < R _m < 1200	42 CrMo 4 R _m = 700 N/mm ²				

Focusing specifically on EN 42 CrMo 4 in annealed condition, the ultimate tensile strength R_m may typically vary between R_m = 630 N/mm² and R_m = 780 N/mm², which provide a reference level for SMG P5. In Quenched & Tempered condition, the ultimate tensile strength R_m may typically be between R_m = 900 N/mm² and R_m = 1100 N/mm² thus still belongs to SMG P5. However, if hardened above R_m = 1200 N/mm² it instead belongs to SMG H5.

SMG	EN	W.-Nr	AFNOR	BS	UNI	JIS	AISI / ASTM	GOST	Condition	R _{m, nom}	HRC _{nom}
P5	42 CrMo 4	1.1201	42 CD 4	708 M 40	42 CrMo 4	SCM 440 (H)	4142, 4140	38HM	Annealed	700	
	42 CrMo 4	1.1201	42 CD 4	708 M 40	42 CrMo 4	SCM 440 (H)	4142, 4140	38HM	Quenched & Tempered	1000	
H5	42 CrMo 4	1.1201	42 CD 4	708 M 40	42 CrMo 4	SCM 440 (H)	4142, 4140	38HM	Quenched & Tempered		45
	42 CrMo 4	1.1201	42 CD 4	708 M 40	42 CrMo 4	SCM 440 (H)	4142, 4140	38HM	Quenched & Tempered		50

The EN 42CrMo4 quench & tempered steel could be used to illustrate the machinability dependence of materials' condition.

The graphs below indicate how speed recommendations for a nominal material conditions may be adjusted for relative R_m (left diagram valid for ISO-P) and for relative HRC (valid for ISO-H).

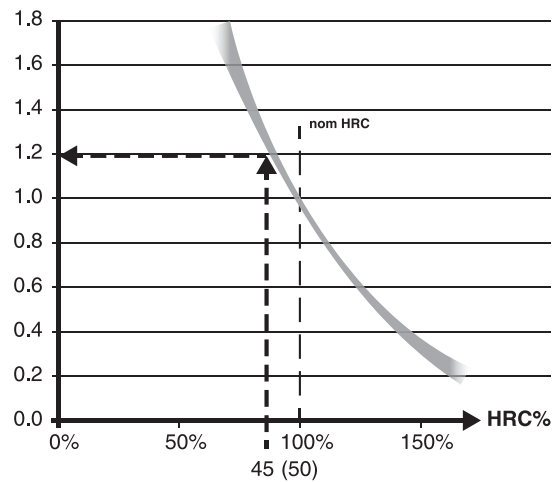
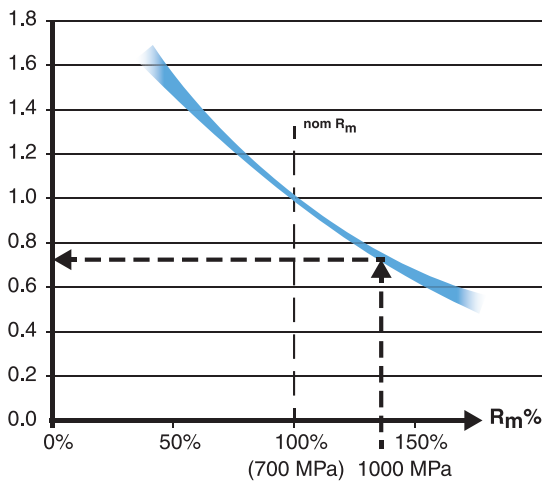

To further illustrate how the SMG P5 nominal v_c can be adjusted to a more accurate recommended v_c we need ultimate tensile strength R_m data and in this case we use the EN 42 CrMo 4 quenched & tempered to R_m = 1000 N/mm² according to above table (bold blue arrows).

Assume that we find that the SMG P5 nominal v_c = 280 m/min for a certain product and machining.

Then, actual recommended v_c = 280 m/min × 0,75 = 210 m/min.

Consequently in the SMG H5 the nominal v_c can be adjusted using the hardened EN 42 CrMo 4 at HRC 45 (smaller grey arrows).

Assume that the SMG H5 nominal v_c = 50 m/min for a certain product and machining using a coated cemented carbide tools then, actual recommended v_c = 50 m/min × 1,2 = 60 m/min.

For further workpiece material details please see page(s) 474-485 and suggested cutting data at applicable pages.

For more convenient cutting data handling we recommend applicable tools in My Pages – Suggest on www.secotools.com

Cutting speed metric (Inch)

SMG	V _c m/min SFM				
	CP200	CP300	CP500	H15	TTP2050
P1	—	275	205	—	205
	—	900	670	—	670
P2	—	270	200	—	200
	—	890	660	—	660
P3	—	230	170	—	170
	—	750	560	—	560
P4	—	205	150	—	150
	—	670	490	—	490
P5	—	195	145	—	145
	—	640	475	—	475
P6	—	220	165	—	165
	—	720	540	—	540
P7	—	205	155	—	155
	—	670	510	—	510
P8	—	195	145	—	145
	—	640	475	—	475
P11	—	200	150	—	150
	—	660	490	—	490
P12	—	120	90	—	90
	—	395	295	—	295
M1	150	—	135	100	135
	490	—	445	330	445
M2	120	—	110	80	110
	395	—	360	260	360
M3	90	—	85	60	85
	295	—	280	195	280
M4	70	—	65	—	65
	230	—	215	—	215
M5	55	—	50	—	50
	180	—	165	—	165
K1	130	—	120	105	120
	425	—	395	345	395
K2	110	—	105	95	105
	360	—	345	310	345
K3	95	—	90	80	90
	310	—	295	260	295
K4	90	—	85	75	85
	295	—	280	245	280
K5	55	—	50	—	50
	180	—	165	—	165
K6	80	—	75	—	75
	260	—	245	—	245
K7	70	—	65	—	65
	230	—	215	—	215
N1	—	—	—	255	—
	—	—	—	840	—
N2	—	—	—	165	—
	—	—	—	540	—
N3	—	—	—	110	—
	—	—	—	360	—
N11	—	—	100	150	100
	—	—	330	490	330
S1	20	—	20	—	20
	65	—	65	—	65
S2	15	—	15	—	15
	49	—	49	—	49
S3	15	—	15	—	15
	49	—	49	—	49
S11	45	—	39	—	39
	150	—	130	—	130
S12	35	—	30	—	30
	115	—	100	—	100
S13	27	—	23	—	23
	90	—	75	—	75

Use the SMG tables to classify the workpiece material. Use the table to choose cutting speed. Cutting speeds (v_c) in the table are recommendations for a start value. Due to machine, material and setup condition it is advisable to optimize cutting data. Recommended ranges to use for each grade is CP200, CP300, CP500, TTP2050 and H15 +/-15%

SMG=Seco Material Group
v_c = Cutting speed (m/min)

Note that there is a fixed relationship between rotational speed and feed rate in threading. Check that the chosen cutting speed does not result in a too high feed speed.

Number of passes and infeed depths

A thread cannot be made in one cut because of the relatively brittle cutting edge. The total cutting depth must be divided into several passes. Those passes should all have similar cutting forces (equal chip areas), see figures.

Use the tables on page 22-33 to find recommendations for number of passes and infeed depths. The tables give basic recommendations and are applicable on all geometries - Original, A, A1 and A2.

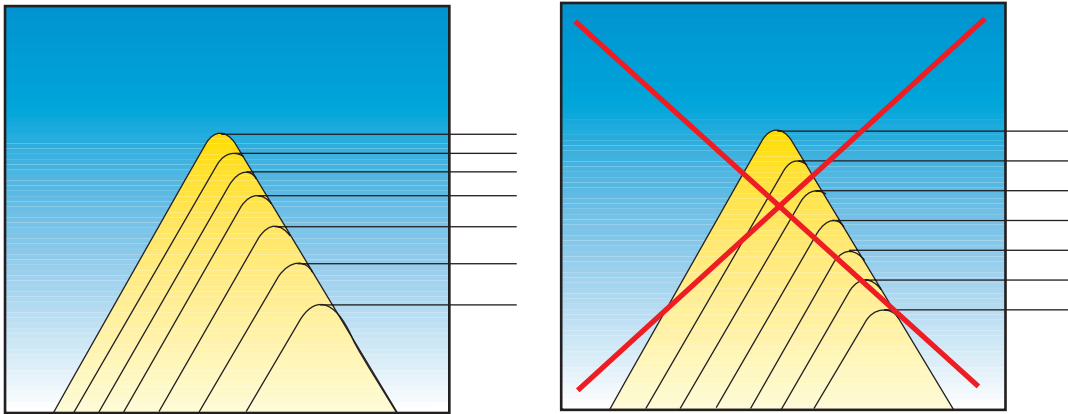

- The infeed series given is based on a good control of the OD/ID tolerances for the selected profile.
- If insert fracture should occur, the number of passes should be increased.
- The infeed depth should not be less than 0,05 mm (0.0020") /pass.
- On stainless steel, the infeed depth per pass should be greater than 0,08 mm (0.0031").
- The recommendations can also be used for part-profile inserts. The number of passes should then, in most cases, be increased.
- The threading insert nose radius is relatively small and can easily be damaged if it is overloaded.

Cutting speed – MDT metric (Inch)

SMG	v_c
	m/min SFM
	CP500
P1	155 510
P2	150 490
P3	130 425
P4	115 375
P5	110 360
P6	125 410
P7	115 375
P8	110 360
P11	115 375
P12	65 215
M1	135 445
M2	110 360
M3	85 280
M4	65 215
M5	50 165
K1	130 425
K2	110 360
K3	95 310
K4	90 295
K5	55 180
K6	80 260
K7	70 230
N1	—
N2	—
N3	—
N11	85 280
S1	21 70
S2	17 55
S3	15 49
S11	—
S12	—
S13	—

Use the SMG tables to classify the workpiece material. Use the table to choose cutting speed.
 SMG = Seco Material Group
 v_c = m/min
 Cutting speeds (v_c) in the table are recommendations for a start value.
 Due to machine, material and setup condition it is advisable to optimize cutting data. Recommended ranges to use for CP500 +/-15%

Cutting speed – Mini Shaft metric (Inch)

SMG	v _c m/min SFM	
	CP500	
P1	155	510
P2	150	490
P3	130	425
P4	115	375
P5	110	360
P6	125	410
P7	115	375
P8	110	360
P11	115	375
P12	65	215
M1	80	260
M2	65	215
M3	50	165
M4	37	120
M5	31	100
K1	150	490
K2	130	425
K3	110	360
K4	105	345
K5	65	215
K6	95	310
K7	80	260
N1	—	—
N2	—	—
N3	—	—
N11	95	310
S1	19	60
S2	15	49
S3	13	43
S11	—	—
S12	—	—
S13	—	—

Use the SMG tables to classify the workpiece material. Use the table to choose cutting speed.

SMG = Seco Material Group

v_c = m/min

Cutting speeds (v_c) in the table are recommendations for a start value.

Due to machine, material and setup condition it is advisable to optimize cutting data. Recommended ranges to use for CP500 +/-15%

Thread turning

MDT

Mini-Shaft™

Thread milling

Thread tapping

Annex

Number of passes and infeed depths

External ISO-metric threads, metric (Inch)

Ph	6.0	5.5	5.0	4.5	4.0	3.5	3.0	2.5	2.0	1.75	1.5	1.25	1.0	0.80	0.75	0.50
a_p	3,82 (0.150)	3,52 (0.139)	3,19 (0.126)	2,87 (0.113)	2,53 (0.100)	2,23 (0.088)	1,92 (0.076)	1,60 (0.063)	1,25 (0.049)	1,13 (0.044)	0,93 (0.037)	0,81 (0.032)	0,65 (0.026)	0,52 (0.020)	0,48 (0.019)	0,33 (0.013)
1	0,46 (0.018)	0,43 (0.017)	0,41 (0.016)	0,37 (0.015)	0,34 (0.013)	0,34 (0.013)	0,28 (0.011)	0,27 (0.011)	0,24 (0.009)	0,22 (0.009)	0,22 (0.009)	0,21 (0.008)	0,18 (0.007)	0,17 (0.007)	0,16 (0.006)	0,11 (0.004)
2	0,43 (0.017)	0,40 (0.016)	0,39 (0.015)	0,34 (0.013)	0,32 (0.013)	0,31 (0.012)	0,26 (0.010)	0,24 (0.009)	0,22 (0.009)	0,20 (0.008)	0,20 (0.008)	0,17 (0.007)	0,16 (0.006)	0,15 (0.006)	0,14 (0.006)	0,09 (0.004)
3	0,35 (0.014)	0,32 (0.013)	0,32 (0.013)	0,28 (0.011)	0,25 (0.010)	0,25 (0.010)	0,21 (0.008)	0,20 (0.008)	0,18 (0.007)	0,17 (0.007)	0,17 (0.007)	0,14 (0.006)	0,12 (0.005)	0,12 (0.005)	0,11 (0.004)	0,07 (0.003)
4	0,30 (0.012)	0,28 (0.011)	0,27 (0.011)	0,24 (0.009)	0,22 (0.009)	0,21 (0.008)	0,18 (0.007)	0,17 (0.007)	0,16 (0.006)	0,14 (0.006)	0,14 (0.006)	0,11 (0.004)	0,11 (0.004)	0,08 (0.003)	0,07 (0.003)	0,06 (0.002)
5	0,29 (0.011)	0,26 (0.010)	0,24 (0.009)	0,22 (0.009)	0,20 (0.008)	0,18 (0.007)	0,16 (0.006)	0,15 (0.006)	0,14 (0.006)	0,12 (0.005)	0,12 (0.005)	0,10 (0.004)	0,08 (0.003)	-	-	-
6	0,26 (0.010)	0,24 (0.009)	0,24 (0.009)	0,22 (0.009)	0,18 (0.007)	0,18 (0.007)	0,15 (0.006)	0,15 (0.006)	0,12 (0.005)	0,10 (0.004)	0,08 (0.003)	0,08 (0.003)	-	-	-	-
7	0,24 (0.009)	0,21 (0.008)	0,22 (0.009)	0,20 (0.008)	0,17 (0.007)	0,16 (0.006)	0,14 (0.006)	0,12 (0.005)	0,11 (0.004)	0,10 (0.004)	-	-	-	-	-	-
8	0,23 (0.009)	0,20 (0.008)	0,20 (0.008)	0,18 (0.007)	0,15 (0.006)	0,15 (0.006)	0,13 (0.005)	0,11 (0.004)	0,08 (0.003)	0,08 (0.003)	-	-	-	-	-	-
9	0,22 (0.009)	0,19 (0.007)	0,19 (0.007)	0,17 (0.007)	0,14 (0.006)	0,14 (0.006)	0,12 (0.005)	0,11 (0.004)	-	-	-	-	-	-	-	-
10	0,19 (0.007)	0,18 (0.007)	0,18 (0.007)	0,16 (0.006)	0,13 (0.005)	0,12 (0.005)	0,11 (0.004)	0,08 (0.003)	-	-	-	-	-	-	-	-
11	0,18 (0.007)	0,17 (0.007)	0,16 (0.006)	0,14 (0.006)	0,12 (0.005)	0,11 (0.004)	0,10 (0.004)	-	-	-	-	-	-	-	-	-
12	0,16 (0.006)	0,15 (0.006)	0,15 (0.006)	0,13 (0.005)	0,12 (0.005)	0,08 (0.003)	0,08 (0.003)	-	-	-	-	-	-	-	-	-
13	0,15 (0.006)	0,14 (0.006)	0,12 (0.005)	0,12 (0.005)	0,11 (0.004)	-	-	-	-	-	-	-	-	-	-	-
14	0,13 (0.005)	0,13 (0.005)	0,10 (0.004)	0,10 (0.004)	0,08 (0.003)	-	-	-	-	-	-	-	-	-	-	-
15	0,13 (0.005)	0,12 (0.005)	-	-	-	-	-	-	-	-	-	-	-	-	-	-
16	0,10 (0.004)	0,10 (0.004)	-	-	-	-	-	-	-	-	-	-	-	-	-	-

Ph = Lead
 a_p = Total infeed depth
 TPI = Threads per inch
 Recommendations are for steel with a hardness < 300 HB

Thread turning
MDT
Mini-Shaft™
Thread milling
Thread tapping
Annex

Internal ISO-metric threads, metric (Inch)

Ph	6.0	5.5	5.0	4.5	4.0	3.5	3.0	2.5	2.0	1.75	1.5	1.25	1.0	0.80	0.75	0.50
a_p	3,54 (0.139)	3,25 (0.128)	2,96 (0.117)	2,65 (0.104)	2,33 (0.092)	2,05 (0.081)	1,78 (0.070)	1,48 (0.058)	1,17 (0.046)	1,05 (0.041)	0,85 (0.033)	0,75 (0.030)	0,60 (0.024)	0,49 (0.019)	0,46 (0.018)	0,31 (0.012)
1	0,46 (0.018)	0,43 (0.017)	0,42 (0.017)	0,37 (0.015)	0,34 (0.013)	0,32 (0.013)	0,28 (0.011)	0,26 (0.010)	0,23 (0.009)	0,22 (0.009)	0,20 (0.008)	0,17 (0.007)	0,17 (0.007)	0,17 (0.007)	0,16 (0.006)	0,10 (0.004)
2	0,43 (0.017)	0,40 (0.016)	0,40 (0.016)	0,34 (0.013)	0,31 (0.012)	0,30 (0.012)	0,26 (0.010)	0,25 (0.010)	0,21 (0.008)	0,20 (0.008)	0,18 (0.007)	0,17 (0.007)	0,15 (0.006)	0,14 (0.006)	0,13 (0.005)	0,08 (0.003)
3	0,35 (0.014)	0,33 (0.013)	0,32 (0.013)	0,28 (0.011)	0,24 (0.009)	0,24 (0.009)	0,21 (0.008)	0,18 (0.007)	0,17 (0.007)	0,15 (0.006)	0,15 (0.006)	0,14 (0.006)	0,11 (0.004)	0,11 (0.004)	0,10 (0.004)	0,07 (0.003)
4	0,30 (0.012)	0,26 (0.010)	0,26 (0.010)	0,23 (0.009)	0,21 (0.008)	0,19 (0.007)	0,16 (0.006)	0,15 (0.006)	0,15 (0.006)	0,13 (0.005)	0,13 (0.005)	0,10 (0.004)	0,09 (0.004)	0,07 (0.003)	0,07 (0.003)	0,06 (0.002)
5	0,26 (0.010)	0,22 (0.009)	0,22 (0.009)	0,21 (0.008)	0,18 (0.007)	0,17 (0.007)	0,14 (0.006)	0,13 (0.005)	0,12 (0.005)	0,10 (0.004)	0,11 (0.004)	0,09 (0.004)	0,08 (0.003)	-	-	-
6	0,22 (0.009)	0,20 (0.008)	0,20 (0.008)	0,19 (0.007)	0,15 (0.006)	0,15 (0.006)	0,13 (0.005)	0,12 (0.005)	0,11 (0.004)	0,09 (0.004)	0,08 (0.003)	0,08 (0.003)	-	-	-	-
7	0,20 (0.008)	0,18 (0.007)	0,17 (0.007)	0,16 (0.006)	0,14 (0.006)	0,14 (0.006)	0,12 (0.005)	0,11 (0.004)	0,10 (0.004)	0,08 (0.003)	-	-	-	-	-	-
8	0,19 (0.007)	0,17 (0.007)	0,16 (0.006)	0,15 (0.006)	0,13 (0.005)	0,13 (0.005)	0,11 (0.004)	0,10 (0.004)	0,08 (0.003)	0,08 (0.003)	-	-	-	-	-	-
9	0,18 (0.007)	0,16 (0.006)	0,16 (0.006)	0,14 (0.006)	0,12 (0.005)	0,12 (0.005)	0,10 (0.004)	0,10 (0.004)	-	-	-	-	-	-	-	-
10	0,16 (0.006)	0,15 (0.006)	0,15 (0.006)	0,13 (0.005)	0,12 (0.005)	0,11 (0.004)	0,10 (0.004)	0,08 (0.003)	-	-	-	-	-	-	-	-
11	0,15 (0.006)	0,14 (0.006)	0,14 (0.006)	0,12 (0.005)	0,11 (0.004)	0,10 (0.004)	0,09 (0.004)	-	-	-	-	-	-	-	-	-
12	0,15 (0.006)	0,14 (0.006)	0,14 (0.006)	0,12 (0.005)	0,10 (0.004)	0,08 (0.003)	0,08 (0.003)	-	-	-	-	-	-	-	-	-
13	0,14 (0.006)	0,13 (0.005)	0,12 (0.005)	0,11 (0.004)	0,10 (0.004)	-	-	-	-	-	-	-	-	-	-	-
14	0,13 (0.005)	0,12 (0.005)	0,10 (0.004)	0,10 (0.004)	0,08 (0.003)	-	-	-	-	-	-	-	-	-	-	-
15	0,12 (0.005)	0,12 (0.005)	-	-	-	-	-	-	-	-	-	-	-	-	-	-
16	0,10 (0.004)	0,10 (0.004)	-	-	-	-	-	-	-	-	-	-	-	-	-	-

Ph = Lead

a_p = Total infeed depth

TPI = Threads per inch

Recommendations are for steel with a hardness < 300 HB

External/Internal Whitworth threads, metric (Inch)

TPI	4.0	4.5	5	6	7	8	9	10	11	12	14	16	18	19	20	26	28
a_p	4,29 (0.169)	3,82 (0.150)	3,44 (0.135)	2,90 (0.114)	2,50 (0.098)	2,17 (0.085)	1,93 (0.076)	1,76 (0.069)	1,58 (0.062)	1,45 (0.057)	1,20 (0.047)	1,13 (0.044)	1,01 (0.040)	0,96 (0.038)	0,92 (0.036)	0,72 (0.028)	0,69 (0.027)
1	0,49 (0.019)	0,46 (0.018)	0,45 (0.018)	0,38 (0.015)	0,37 (0.015)	0,32 (0.013)	0,30 (0.012)	0,29 (0.069)	0,28 (0.011)	0,28 (0.011)	0,24 (0.009)	0,24 (0.009)	0,23 (0.009)	0,22 (0.0090)	0,21 (0.008)	0,19 (0.007)	0,18 (0.007)
2	0,46 (0.018)	0,43 (0.017)	0,43 (0.017)	0,36 (0.014)	0,35 (0.014)	0,30 (0.012)	0,28 (0.011)	0,27 (0.011)	0,26 (0.010)	0,26 (0.010)	0,22 (0.009)	0,22 (0.009)	0,22 (0.009)	0,22 (0.009)	0,21 (0.008)	0,18 (0.007)	0,17 (0.007)
3	0,38 (0.015)	0,38 (0.015)	0,38 (0.015)	0,30 (0.012)	0,29 (0.011)	0,24 (0.009)	0,23 (0.009)	0,22 (0.009)	0,22 (0.009)	0,22 (0.009)	0,18 (0.007)	0,19 (0.007)	0,19 (0.007)	0,18 (0.007)	0,17 (0.007)	0,15 (0.006)	0,14 (0.006)
4	0,36 (0.014)	0,33 (0.013)	0,32 (0.013)	0,26 (0.010)	0,25 (0.010)	0,21 (0.008)	0,20 (0.008)	0,19 (0.007)	0,19 (0.007)	0,18 (0.007)	0,15 (0.006)	0,16 (0.006)	0,16 (0.006)	0,14 (0.006)	0,14 (0.006)	0,12 (0.005)	0,12 (0.005)
5	0,34 (0.013)	0,29 (0.011)	0,28 (0.011)	0,22 (0.009)	0,22 (0.009)	0,19 (0.007)	0,18 (0.007)	0,17 (0.007)	0,16 (0.006)	0,16 (0.006)	0,13 (0.005)	0,13 (0.005)	0,13 (0.005)	0,12 (0.005)	0,11 (0.004)	0,08 (0.003)	0,08 (0.003)
6	0,31 (0.012)	0,25 (0.010)	0,25 (0.010)	0,21 (0.008)	0,19 (0.007)	0,17 (0.007)	0,15 (0.006)	0,15 (0.006)	0,14 (0.006)	0,14 (0.006)	0,11 (0.004)	0,11 (0.004)	0,08 (0.003)	0,08 (0.003)	0,08 (0.003)	-	-
7	0,29 (0.011)	0,24 (0.009)	0,22 (0.009)	0,19 (0.007)	0,18 (0.007)	0,15 (0.006)	0,14 (0.006)	0,14 (0.006)	0,13 (0.005)	0,13 (0.005)	0,09 (0.004)	0,08 (0.003)	-	-	-	-	-
8	0,27 (0.011)	0,22 (0.009)	0,20 (0.008)	0,17 (0.007)	0,16 (0.006)	0,14 (0.006)	0,13 (0.005)	0,13 (0.005)	0,12 (0.005)	0,08 (0.003)	0,08 (0.003)	-	-	-	-	-	-
9	0,24 (0.009)	0,20 (0.008)	0,19 (0.007)	0,16 (0.006)	0,15 (0.006)	0,13 (0.005)	0,12 (0.005)	0,12 (0.005)	0,08 (0.003)	-	-	-	-	-	-	-	-
10	0,22 (0.009)	0,18 (0.007)	0,18 (0.007)	0,15 (0.006)	0,14 (0.006)	0,12 (0.005)	0,12 (0.005)	0,08 (0.003)	-	-	-	-	-	-	-	-	-
11	0,20 (0.008)	0,17 (0.007)	0,17 (0.007)	0,14 (0.006)	0,12 (0.005)	0,12 (0.005)	0,08 (0.003)	-	-	-	-	-	-	-	-	-	-
12	0,19 (0.007)	0,16 (0.006)	0,15 (0.006)	0,14 (0.006)	0,08 (0.003)	0,08 (0.003)	-	-	-	-	-	-	-	-	-	-	-
13	0,17 (0.007)	0,15 (0.006)	0,12 (0.005)	0,12 (0.005)	-	-	-	-	-	-	-	-	-	-	-	-	-
14	0,15 (0.006)	0,14 (0.006)	0,10 (0.004)	0,10 (0.004)	-	-	-	-	-	-	-	-	-	-	-	-	-
15	0,12 (0.005)	0,12 (0.005)	-	-	-	-	-	-	-	-	-	-	-	-	-	-	-
16	0,10 (0.004)	0,10 (0.004)	-	-	-	-	-	-	-	-	-	-	-	-	-	-	-

Ph = Lead
 a_p = Total infeed depth
 TPI = Threads per inch
 Recommendations are for steel with a hardness < 300 HB

Thread turning

MDT

Mini-Shaft™

Thread milling

Thread tapping

Annex

External UN threads, metric (Inch)

TPI	4.0	4.5	5	6	7	8	9	10	11	12	13	14	16	18	20	24	28	32
a_p	4,07 (0.160)	3,62 (0.143)	3,29 (0.130)	2,71 (0.107)	2,33 (0.092)	2,08 (0.082)	1,84 (0.072)	1,66 (0.065)	1,52 (0.060)	1,39 (0.055)	1,29 (0.051)	1,19 (0.047)	1,05 (0.041)	0,94 (0.037)	0,84 (0.033)	0,70 (0.028)	0,60 (0.024)	0,53 (0.021)
1	0,47 (0.019)	0,45 (0.018)	0,43 (0.017)	0,36 (0.014)	0,35 (0.014)	0,30 (0.012)	0,28 (0.011)	0,27 (0.011)	0,27 (0.011)	0,27 (0.011)	0,25 (0.010)	0,23 (0.009)	0,22 (0.009)	0,23 (0.009)	0,20 (0.008)	0,19 (0.007)	0,17 (0.007)	0,17 (0.007)
2	0,44 (0.017)	0,41 (0.016)	0,40 (0.016)	0,34 (0.013)	0,33 (0.013)	0,28 (0.011)	0,26 (0.010)	0,26 (0.010)	0,25 (0.010)	0,26 (0.010)	0,24 (0.009)	0,22 (0.009)	0,21 (0.008)	0,21 (0.008)	0,19 (0.007)	0,17 (0.007)	0,15 (0.006)	0,15 (0.006)
3	0,40 (0.016)	0,39 (0.015)	0,36 (0.014)	0,27 (0.011)	0,26 (0.010)	0,25 (0.010)	0,21 (0.008)	0,20 (0.008)	0,20 (0.008)	0,20 (0.008)	0,18 (0.007)	0,17 (0.007)	0,16 (0.006)	0,16 (0.006)	0,15 (0.006)	0,14 (0.006)	0,11 (0.004)	0,13 (0.005)
4	0,36 (0.014)	0,31 (0.012)	0,31 (0.012)	0,23 (0.009)	0,22 (0.009)	0,21 (0.008)	0,20 (0.008)	0,17 (0.007)	0,19 (0.007)	0,18 (0.007)	0,17 (0.007)	0,15 (0.006)	0,14 (0.006)	0,14 (0.006)	0,12 (0.005)	0,12 (0.005)	0,09 (0.004)	0,08 (0.003)
5	0,32 (0.013)	0,26 (0.010)	0,26 (0.010)	0,22 (0.009)	0,21 (0.008)	0,18 (0.007)	0,17 (0.007)	0,16 (0.006)	0,16 (0.006)	0,15 (0.006)	0,14 (0.006)	0,13 (0.005)	0,13 (0.005)	0,12 (0.005)	0,10 (0.004)	0,08 (0.003)	0,08 (0.003)	-
6	0,27 (0.011)	0,23 (0.009)	0,23 (0.009)	0,20 (0.008)	0,19 (0.007)	0,16 (0.006)	0,15 (0.006)	0,15 (0.006)	0,14 (0.006)	0,13 (0.005)	0,12 (0.005)	0,11 (0.004)	0,11 (0.004)	0,08 (0.003)	0,08 (0.003)	-	-	-
7	0,25 (0.010)	0,21 (0.008)	0,20 (0.008)	0,18 (0.007)	0,17 (0.007)	0,14 (0.006)	0,14 (0.006)	0,14 (0.006)	0,12 (0.005)	0,12 (0.005)	0,11 (0.004)	0,10 (0.004)	0,08 (0.003)	-	-	-	-	-
8	0,23 (0.009)	0,20 (0.008)	0,19 (0.007)	0,16 (0.006)	0,15 (0.006)	0,13 (0.005)	0,12 (0.005)	0,12 (0.005)	0,11 (0.004)	0,08 (0.003)	0,08 (0.003)	0,08 (0.003)	-	-	-	-	-	-
9	0,22 (0.009)	0,18 (0.007)	0,19 (0.007)	0,15 (0.006)	0,14 (0.006)	0,12 (0.005)	0,12 (0.005)	0,11 (0.004)	0,08 (0.003)	-	-	-	-	-	-	-	-	-
10	0,21 (0.008)	0,17 (0.007)	0,18 (0.007)	0,14 (0.006)	0,12 (0.005)	0,12 (0.005)	0,11 (0.004)	0,08 (0.003)	-	-	-	-	-	-	-	-	-	-
11	0,19 (0.007)	0,16 (0.006)	0,17 (0.007)	0,13 (0.005)	0,11 (0.004)	0,11 (0.004)	0,08 (0.003)	-	-	-	-	-	-	-	-	-	-	-
12	0,18 (0.007)	0,15 (0.006)	0,15 (0.006)	0,12 (0.005)	0,08 (0.003)	0,08 (0.003)	-	-	-	-	-	-	-	-	-	-	-	-
13	0,16 (0.006)	0,14 (0.006)	0,12 (0.005)	0,11 (0.004)	-	-	-	-	-	-	-	-	-	-	-	-	-	-
14	0,15 (0.006)	0,14 (0.006)	0,10 (0.004)	0,10 (0.004)	-	-	-	-	-	-	-	-	-	-	-	-	-	-
15	0,12 (0.005)	0,12 (0.005)	-	-	-	-	-	-	-	-	-	-	-	-	-	-	-	-
16	0,10 (0.004)	0,10 (0.004)	-	-	-	-	-	-	-	-	-	-	-	-	-	-	-	-

Ph = Lead

a_p = Total infeed depth

TPI = Threads per inch

Recommendations are for steel with a hardness < 300 HB

Internal UN threads, metric (Inch)

TPI	4	4.5	5	6	7	8	9	10	11	12	13	14	16	18	20	24	28	32
a_p	3,74 (0.147)	3,32 (0.131)	2,99 (0.118)	2,46 (0.097)	2,13 (0.084)	1,88 (0.074)	1,66 (0.065)	1,49 (0.059)	1,36 (0.054)	1,25 (0.049)	1,14 (0.045)	1,06 (0.042)	0,93 (0.037)	0,84 (0.033)	0,76 (0.030)	0,64 (0.025)	0,56 (0.022)	0,49 (0.019)
1	0,44 (0.017)	0,41 (0.016)	0,42 (0.017)	0,35 (0.014)	0,34 (0.013)	0,30 (0.012)	0,28 (0.011)	0,27 (0.011)	0,27 (0.011)	0,27 (0.011)	0,25 (0.010)	0,23 (0.009)	0,22 (0.009)	0,23 (0.009)	0,20 (0.008)	0,18 (0.007)	0,17 (0.007)	0,17 (0.007)
2	0,41 (0.016)	0,38 (0.015)	0,38 (0.015)	0,33 (0.013)	0,32 (0.013)	0,28 (0.011)	0,26 (0.010)	0,25 (0.010)	0,23 (0.009)	0,23 (0.009)	0,20 (0.008)	0,18 (0.007)	0,18 (0.007)	0,17 (0.007)	0,16 (0.006)	0,15 (0.006)	0,14 (0.006)	0,14 (0.006)
3	0,39 (0.015)	0,34 (0.013)	0,33 (0.013)	0,25 (0.010)	0,24 (0.009)	0,22 (0.009)	0,19 (0.007)	0,18 (0.007)	0,18 (0.007)	0,18 (0.007)	0,15 (0.006)	0,14 (0.006)	0,14 (0.006)	0,14 (0.006)	0,13 (0.005)	0,13 (0.005)	0,09 (0.004)	0,10 (0.004)
4	0,33 (0.013)	0,28 (0.011)	0,27 (0.011)	0,21 (0.008)	0,21 (0.008)	0,18 (0.007)	0,16 (0.006)	0,15 (0.006)	0,15 (0.006)	0,15 (0.006)	0,13 (0.005)	0,13 (0.005)	0,12 (0.005)	0,12 (0.005)	0,10 (0.004)	0,10 (0.004)	0,08 (0.003)	0,08 (0.003)
5	0,28 (0.011)	0,23 (0.009)	0,23 (0.009)	0,18 (0.007)	0,17 (0.007)	0,15 (0.006)	0,14 (0.006)	0,13 (0.005)	0,13 (0.005)	0,13 (0.005)	0,12 (0.005)	0,11 (0.004)	0,10 (0.004)	0,10 (0.004)	0,09 (0.004)	0,08 (0.003)	0,08 (0.003)	-
6	0,24 (0.009)	0,20 (0.008)	0,20 (0.008)	0,16 (0.006)	0,15 (0.006)	0,13 (0.005)	0,13 (0.005)	0,12 (0.005)	0,11 (0.004)	0,11 (0.004)	0,11 (0.004)	0,10 (0.004)	0,09 (0.004)	0,08 (0.003)	0,08 (0.003)	-	-	-
7	0,22 (0.009)	0,19 (0.007)	0,18 (0.007)	0,15 (0.006)	0,14 (0.006)	0,12 (0.005)	0,12 (0.005)	0,11 (0.004)	0,11 (0.004)	0,10 (0.004)	0,10 (0.004)	0,09 (0.004)	0,08 (0.003)	-	-	-	-	-
8	0,21 (0.008)	0,18 (0.007)	0,17 (0.007)	0,14 (0.006)	0,13 (0.005)	0,11 (0.004)	0,11 (0.004)	0,10 (0.004)	0,10 (0.004)	0,08 (0.003)	0,08 (0.003)	0,08 (0.003)	-	-	-	-	-	-
9	0,20 (0.008)	0,17 (0.007)	0,16 (0.006)	0,13 (0.005)	0,12 (0.005)	0,11 (0.004)	0,10 (0.004)	0,10 (0.004)	0,08 (0.003)	-	-	-	-	-	-	-	-	-
10	0,18 (0.007)	0,16 (0.006)	0,15 (0.006)	0,12 (0.005)	0,12 (0.005)	0,10 (0.004)	0,09 (0.004)	0,08 (0.003)	-	-	-	-	-	-	-	-	-	-
11	0,17 (0.007)	0,15 (0.006)	0,14 (0.006)	0,12 (0.005)	0,11 (0.004)	0,10 (0.004)	0,08 (0.003)	-	-	-	-	-	-	-	-	-	-	-
12	0,16 (0.006)	0,14 (0.006)	0,14 (0.006)	0,11 (0.004)	0,08 (0.003)	0,08 (0.003)	-	-	-	-	-	-	-	-	-	-	-	-
13	0,15 (0.006)	0,14 (0.006)	0,12 (0.005)	0,11 (0.004)	-	-	-	-	-	-	-	-	-	-	-	-	-	-
14	0,14 (0.006)	0,13 (0.005)	0,10 (0.004)	0,10 (0.004)	-	-	-	-	-	-	-	-	-	-	-	-	-	-
15	0,12 (0.005)	0,12 (0.005)	-	-	-	-	-	-	-	-	-	-	-	-	-	-	-	-
16	0,10 (0.004)	0,10 (0.004)	-	-	-	-	-	-	-	-	-	-	-	-	-	-	-	-

External multi-tooth inserts, metric (Inch)

Type	ISO Metric						UN				Whitworth	NPT				
	3M	2M	3M	2M	3M	2M	2M	3M	2M	3M	2M	2M	2M	3M	2M	
Ph mm	1,0	1,5	1,5	2,0	2,0	3,0	-	-	-	-	-	-	-	-	-	
TPI	-	-	-	-	-	-	16	16	12	12	8	11	11,5	11,5	8	
a_p mm (inch)	0,65 (0.026)	0,93 (0.037)	0,93 (0.037)	1,25 (0.049)	1,25 (0.049)	1,92 (0.076)	1,05 (0.041)	1,05 (0.041)	1,39 (0.055)	1,39 (0.055)	2,08 (0.082)	1,58 (0.062)	1,76 (0.069)	1,76 (0.069)	2,54 (0.100)	
Pass 1 mm (inch)	0,36 (0.026)	0,43 (0.017)	0,56 (0.022)	0,57 (0.022)	0,75 (0.030)	0,65 (0.026)	0,49 (0.019)	0,64 (0.025)	0,64 (0.025)	0,64 (0.025)	0,84 (0.033)	0,70 (0.028)	0,73 (0.029)	0,59 (0.023)	0,81 (0.032)	0,88 (0.035)
2	0,29 (0.011)	0,30 (0.012)	0,37 (0.015)	0,40 (0.016)	0,50 (0.020)	0,53 (0.021)	0,33 (0.013)	0,41 (0.016)	0,44 (0.017)	0,55 (0.022)	0,57 (0.022)	0,50 (0.020)	0,50 (0.020)	0,50 (0.020)	0,57 (0.022)	0,64 (0.025)
3	-	0,20 (0.008)	-	0,28 (0.011)	-	0,42 (0.017)	0,23 (0.009)	-	0,31 (0.012)	-	0,46 (0.018)	0,35 (0.014)	0,37 (0.015)	0,38 (0.015)	0,57 (0.022)	
4	-	-	-	-	-	0,32 (0.013)	-	-	-	-	0,35 (0.014)	-	0,30 (0.012)	-	0,45 (0.018)	

Ph = Lead

a_p = Total infeed depth

TPI = Threads per inch

Recommendations are for steel with a hardness < 300 HB

Thread turning

MDT

Mini-Shaft™

Thread milling

Thread tapping

Annex

Internal multi-tooth inserts, metric (Inch)

Type	ISO Metric						UN					Whitworth	NPT		
	3M	2M	3M	2M	3M	2M	2M	3M	2M	3M	2M	2M	2M	3M	2M
Ph mm	1,0	1,5	1,5	2,0	2,0	3,0	-	-	-	-	-	-	-	-	-
TPI	-	-	-	-	-	-	16	16	12	12	8	11	11,5	11,5	8
a _p mm (inch)	0,60 (0.024)	0,85 (0.033)	0,85 (0.033)	1,17 (0.046)	1,17 (0.046)	1,78 (0.070)	0,93 (0.037)	0,93 (0.037)	1,25 (0.049)	1,25 (0.049)	1,88 (0.074)	1,58 (0.062)	1,76 (0.069)	1,76 (0.069)	2,54 (0.100)
Pass 1 mm (inch)	0,33 (0.013)	0,38 (0.015)	0,51 (0.020)	0,51 (0.020)	0,70 (0.028)	0,55 (0.022)	0,42 (0.017)	0,56 (0.022)	0,56 (0.022)	0,75 (0.030)	0,58 (0.023)	0,73 (0.029)	0,59 (0.023)	0,81 (0.032)	0,88 (0.035)
2	0,27 (0.011)	0,27 (0.011)	0,34 (0.013)	0,38 (0.015)	0,47 (0.019)	0,49 (0.019)	0,30 (0.017)	0,37 (0.015)	0,40 (0.016)	0,50 (0.020)	0,51 (0.020)	0,50 (0.020)	0,50 (0.020)	0,57 (0.022)	0,64 (0.025)
3	-	0,20 (0.008)	-	0,28 (0.011)	-	0,42 (0.017)	0,21 (0.008)	-	0,29 (0.011)	-	0,44 (0.017)	0,35 (0.014)	0,37 (0.015)	0,38 (0.015)	0,57 (0.022)
4	-	-	-	-	-	0,32 (0.013)	-	-	-	-	0,35 (0.014)	-	0,30 (0.012)	-	0,45 (0.018)

External/Internal NPT threads, metric (Inch)

TPI	8	11,5	14	18	27
a _p	2,54 (0.100)	1,76 (0.069)	1,45 (0.057)	1,12 (0.044)	0,75 (0.030)
1	0,28 (0.011)	0,25 (0.010)	0,24 (0.009)	0,22 (0.009)	0,19 (0.007)
2	0,25 (0.010)	0,22 (0.009)	0,22 (0.009)	0,18 (0.007)	0,15 (0.006)
3	0,22 (0.009)	0,18 (0.007)	0,17 (0.007)	0,15 (0.006)	0,13 (0.005)
4	0,19 (0.007)	0,16 (0.006)	0,15 (0.006)	0,14 (0.006)	0,11 (0.004)
5	0,18 (0.007)	0,16 (0.006)	0,14 (0.006)	0,13 (0.005)	0,09 (0.004)
6	0,18 (0.007)	0,14 (0.006)	0,13 (0.005)	0,12 (0.005)	0,08 (0.003)
7	0,17 (0.007)	0,14 (0.006)	0,12 (0.005)	0,10 (0.004)	-
8	0,17 (0.007)	0,12 (0.005)	0,10 (0.004)	0,08 (0.003)	-
9	0,16 (0.006)	0,12 (0.005)	0,10 (0.004)	-	-
10	0,16 (0.006)	0,10 (0.004)	0,08 (0.003)	-	-
11	0,14 (0.006)	0,09 (0.004)	-	-	-
12	0,13 (0.005)	0,08 (0.003)	-	-	-
13	0,12 (0.005)	-	-	-	-
14	0,11 (0.004)	-	-	-	-
15	0,08 (0.003)	-	-	-	-

Ph = Lead

a_p = Total infeed depth

TPI = Threads per inch

Recommendations are for steel with a hardness < 300 HB

External Round DIN 405, metric (Inch)

TPI	4	6	8	10
a_p	3,43 (0.135)	2,23 (0.088)	1,73 (0.068)	1,40 (0.055)
1	0,44 (0.017)	0,33 (0.013)	0,29 (0.011)	0,26 (0.010)
2	0,40 (0.016)	0,29 (0.011)	0,26 (0.010)	0,25 (0.010)
3	0,34 (0.013)	0,25 (0.010)	0,21 (0.008)	0,23 (0.009)
4	0,32 (0.013)	0,23 (0.009)	0,19 (0.007)	0,20 (0.008)
5	0,28 (0.011)	0,20 (0.008)	0,18 (0.007)	0,16 (0.006)
6	0,26 (0.010)	0,18 (0.007)	0,16 (0.006)	0,12 (0.005)
7	0,24 (0.009)	0,16 (0.006)	0,14 (0.006)	0,10 (0.004)
8	0,22 (0.009)	0,15 (0.006)	0,12 (0.005)	0,08 (0.003)
9	0,20 (0.008)	0,14 (0.006)	0,10 (0.004)	-
10	0,19 (0.007)	0,12 (0.005)	0,08 (0.003)	-
11	0,17 (0.007)	0,10 (0.004)	-	-
12	0,15 (0.006)	0,08 (0.003)	-	-
13	0,12 (0.005)	-	-	-
14	0,10 (0.004)	-	-	-

Internal Round DIN 405, metric (Inch)

TPI	4	6	8	10
a_p	3,59 (0.141)	2,44 (0.096)	1,66 (0.065)	1,49 (0.059)
1	0,46 (0.018)	0,38 (0.015)	0,26 (0.010)	0,27 (0.011)
2	0,43 (0.017)	0,34 (0.013)	0,22 (0.009)	0,26 (0.010)
3	0,40 (0.016)	0,30 (0.012)	0,21 (0.009)	0,25 (0.010)
4	0,35 (0.014)	0,25 (0.010)	0,19 (0.007)	0,22 (0.009)
5	0,30 (0.012)	0,21 (0.008)	0,18 (0.007)	0,18 (0.007)
6	0,26 (0.010)	0,19 (0.007)	0,16 (0.006)	0,13 (0.005)
7	0,24 (0.009)	0,17 (0.007)	0,14 (0.006)	0,10 (0.004)
8	0,22 (0.009)	0,16 (0.006)	0,12 (0.005)	0,08 (0.003)
9	0,20 (0.008)	0,14 (0.006)	0,10 (0.004)	-
10	0,19 (0.007)	0,12 (0.005)	0,08 (0.003)	-
11	0,17 (0.007)	0,10 (0.004)	-	-
12	0,15 (0.006)	0,08 (0.003)	-	-
13	0,12 (0.005)	-	-	-
14	0,10 (0.004)	-	-	-

Ph = Lead
 a_p = Total infeed depth
 TPI = Threads per inch
 Recommendations are for steel with a hardness < 300 HB

External TR thread, metric

Ph	14.0	12.0	10.0	9.0	8.0	7.0	6.0	5.0	4.0	3.0	2.0	1.5
a_p	8,2	6,72	5,7	5,16	4,68	4,17	3,66	2,89	2,38	1,83	1,33	0,97
1	0,40	0,38	0,38	0,38	0,37	0,37	0,37	0,34	0,31	0,27	0,25	0,23
2	0,37	0,36	0,36	0,35	0,35	0,34	0,35	0,33	0,28	0,25	0,24	0,22
3	0,36	0,34	0,34	0,34	0,34	0,33	0,32	0,27	0,24	0,21	0,20	0,18
4	0,36	0,34	0,34	0,33	0,33	0,31	0,29	0,25	0,20	0,17	0,17	0,14
5	0,35	0,32	0,32	0,31	0,31	0,29	0,27	0,23	0,19	0,15	0,14	0,12
6	0,35	0,32	0,32	0,30	0,29	0,26	0,25	0,21	0,18	0,13	0,13	0,08
7	0,34	0,30	0,31	0,29	0,28	0,26	0,23	0,20	0,16	0,13	0,11	-
8	0,34	0,30	0,29	0,28	0,27	0,26	0,22	0,20	0,15	0,12	0,09	-
9	0,34	0,30	0,28	0,26	0,25	0,24	0,22	0,18	0,15	0,12	-	-
10	0,33	0,29	0,27	0,25	0,24	0,23	0,20	0,16	0,15	0,10	-	-
11	0,33	0,29	0,25	0,24	0,23	0,22	0,18	0,15	0,14	0,10	-	-
12	0,32	0,29	0,24	0,23	0,21	0,22	0,17	0,14	0,13	0,08	-	-
13	0,32	0,28	0,23	0,22	0,20	0,20	0,17	0,13	0,10	-	-	-
14	0,31	0,27	0,22	0,21	0,19	0,19	0,16	0,10	-	-	-	-
15	0,31	0,25	0,22	0,21	0,19	0,17	0,14	-	-	-	-	-
16	0,30	0,25	0,20	0,19	0,18	0,16	0,12	-	-	-	-	-
17	0,30	0,24	0,19	0,18	0,17	0,12	-	-	-	-	-	-
18	0,29	0,22	0,18	0,16	0,15	-	-	-	-	-	-	-
19	0,28	0,20	0,17	0,15	0,13	-	-	-	-	-	-	-
20	0,27	0,20	0,16	0,15	-	-	-	-	-	-	-	-
21	0,23	0,19	0,15	0,13	-	-	-	-	-	-	-	-
22	0,23	0,18	0,15	-	-	-	-	-	-	-	-	-
23	0,21	0,17	0,13	-	-	-	-	-	-	-	-	-
24	0,19	0,16	-	-	-	-	-	-	-	-	-	-
25	0,17	0,15	-	-	-	-	-	-	-	-	-	-
26	0,16	0,13	-	-	-	-	-	-	-	-	-	-
27	0,16	-	-	-	-	-	-	-	-	-	-	-
28	0,15	-	-	-	-	-	-	-	-	-	-	-
29	0,13	-	-	-	-	-	-	-	-	-	-	-

Ph = Lead
 a_p = Total infeed depth
 TPI = Threads per inch
 Recommendations are for steel with a hardness < 300 HB

Thread turning

MDT

Mini-Shaft™

Thread milling

Thread tapping

Annex

Internal TR threads, metric

Ph	14.0	12.0	10.0	9.0	8.0	7.0	6.0	5.0	4.0	3.0	2.0	1.5
a_p	8,47	6,71	5,7	5,19	4,68	4,17	3,65	2,89	2,38	1,85	1,34	0,98
1	0,40	0,38	0,38	0,38	0,37	0,37	0,37	0,34	0,31	0,27	0,25	0,23
2	0,37	0,36	0,36	0,35	0,35	0,34	0,34	0,33	0,28	0,25	0,24	0,22
3	0,36	0,34	0,34	0,34	0,34	0,33	0,32	0,27	0,24	0,22	0,21	0,19
4	0,36	0,34	0,34	0,33	0,33	0,31	0,29	0,25	0,20	0,17	0,17	0,14
5	0,35	0,32	0,32	0,31	0,31	0,29	0,27	0,23	0,19	0,15	0,14	0,12
6	0,35	0,32	0,32	0,31	0,29	0,26	0,25	0,21	0,18	0,14	0,13	0,08
7	0,34	0,30	0,31	0,29	0,28	0,26	0,23	0,20	0,16	0,13	0,11	-
8	0,34	0,30	0,29	0,29	0,27	0,26	0,22	0,20	0,15	0,12	0,09	-
9	0,34	0,30	0,28	0,26	0,25	0,24	0,22	0,18	0,15	0,12	-	-
10	0,33	0,29	0,27	0,25	0,24	0,23	0,20	0,16	0,15	0,10	-	-
11	0,33	0,29	0,25	0,24	0,23	0,22	0,18	0,15	0,14	0,10	-	-
12	0,32	0,28	0,24	0,23	0,21	0,22	0,17	0,14	0,13	0,08	-	-
13	0,32	0,28	0,23	0,22	0,20	0,20	0,17	0,13	0,10	-	-	-
14	0,31	0,27	0,22	0,21	0,19	0,19	0,16	0,10	-	-	-	-
15	0,31	0,25	0,22	0,21	0,19	0,17	0,14	-	-	-	-	-
16	0,30	0,25	0,20	0,19	0,18	0,16	0,12	-	-	-	-	-
17	0,30	0,24	0,19	0,18	0,17	0,12	-	-	-	-	-	-
18	0,29	0,22	0,18	0,16	0,15	-	-	-	-	-	-	-
19	0,28	0,20	0,17	0,15	0,13	-	-	-	-	-	-	-
20	0,27	0,20	0,16	0,15	-	-	-	-	-	-	-	-
21	0,23	0,19	0,15	0,13	-	-	-	-	-	-	-	-
22	0,23	0,18	0,15	-	-	-	-	-	-	-	-	-
23	0,21	0,17	0,13	-	-	-	-	-	-	-	-	-
24	0,19	0,16	-	-	-	-	-	-	-	-	-	-
25	0,17	0,15	-	-	-	-	-	-	-	-	-	-
26	0,16	0,13	-	-	-	-	-	-	-	-	-	-
27	0,16	-	-	-	-	-	-	-	-	-	-	-
28	0,15	-	-	-	-	-	-	-	-	-	-	-
29	0,13	-	-	-	-	-	-	-	-	-	-	-
30	0,13	-	-	-	-	-	-	-	-	-	-	-

Ph = Lead
 a_p = Total infeed depth
 TPI = Threads per inch
 Recommendations are for steel with a hardness < 300 HB

Thread turning

MDT

Mini-Shaft™

Thread milling

Thread tapping

Annex

External ACME, *Inch*

TPI	2	3	4	5	6	8	10	12	14	16
a_p	0.265	0.18	0.138	0.112	0.095	0.074	0.063	0.050	0.041	0.039
1	0.028	0.019	0.013	0.012	0.011	0.010	0.010	0.009	0.008	0.009
2	0.026	0.018	0.012	0.011	0.011	0.010	0.009	0.009	0.008	0.009
3	0.023	0.016	0.011	0.010	0.010	0.009	0.009	0.007	0.007	0.007
4	0.022	0.015	0.011	0.01	0.009	0.007	0.007	0.007	0.006	0.006
5	0.019	0.013	0.010	0.009	0.008	0.006	0.006	0.005	0.005	0.005
6	0.017	0.011	0.010	0.008	0.007	0.005	0.005	0.005	0.004	0.003
7	0.015	0.011	0.009	0.007	0.006	0.005	0.005	0.004	0.003	-
8	0.013	0.009	0.008	0.007	0.006	0.005	0.004	0.004	-	-
9	0.013	0.009	0.008	0.007	0.006	0.005	0.004	-	-	-
10	0.011	0.009	0.007	0.006	0.006	0.004	0.004	-	-	-
11	0.011	0.008	0.007	0.006	0.006	0.004	-	-	-	-
12	0.01	0.007	0.006	0.006	0.005	0.004	-	-	-	-
13	0.009	0.007	0.006	0.005	0.004	-	-	-	-	-
14	0.009	0.007	0.006	0.004	-	-	-	-	-	-
15	0.008	0.006	0.006	0.004	-	-	-	-	-	-
16	0.007	0.005	0.004	-	-	-	-	-	-	-
17	0.007	0.005	0.004	-	-	-	-	-	-	-
18	0.006	0.005	-	-	-	-	-	-	-	-
19	0.006	-	-	-	-	-	-	-	-	-
20	0.005	-	-	-	-	-	-	-	-	-

Internal ACME, *Inch*

TPI	2	3	4	5	6	8	10	12	14	16
a_p	0.265	0.182	0.142	0.114	0.098	0.078	0.065	0.049	0.042	0.040
1	0.028	0.020	0.013	0.012	0.012	0.011	0.010	0.009	0.009	0.009
2	0.026	0.018	0.012	0.012	0.011	0.011	0.010	0.009	0.008	0.009
3	0.023	0.016	0.012	0.011	0.011	0.009	0.009	0.007	0.007	0.008
4	0.022	0.015	0.011	0.010	0.009	0.007	0.007	0.006	0.006	0.006
5	0.019	0.013	0.011	0.009	0.008	0.006	0.006	0.005	0.005	0.005
6	0.017	0.011	0.010	0.008	0.007	0.006	0.006	0.005	0.004	0.003
7	0.015	0.011	0.009	0.007	0.007	0.005	0.005	0.004	0.003	-
8	0.013	0.009	0.008	0.007	0.006	0.005	0.004	0.004	-	-
9	0.013	0.009	0.008	0.007	0.006	0.005	0.004	-	-	-
10	0.011	0.009	0.007	0.006	0.006	0.005	0.004	-	-	-
11	0.011	0.008	0.007	0.006	0.006	0.004	-	-	-	-
12	0.010	0.007	0.006	0.006	0.005	0.004	-	-	-	-
13	0.009	0.007	0.006	0.005	0.004	-	-	-	-	-
14	0.009	0.007	0.006	0.004	-	-	-	-	-	-
15	0.008	0.006	0.006	0.004	-	-	-	-	-	-
16	0.007	0.005	0.005	-	-	-	-	-	-	-
17	0.007	0.005	0.005	-	-	-	-	-	-	-
18	0.006	0.005	-	-	-	-	-	-	-	-
19	0.006	-	-	-	-	-	-	-	-	-
20	0.005	-	-	-	-	-	-	-	-	-

Ph = Lead

a_p = Total infeed depth

TPI = Threads per inch

Recommendations are for steel with a hardness < 300 HB

Multi-tooth insert TWIN THREADER, TT
External 60° threads, metric (Inch)

Ph mm	2.0	1.5	1.0
a _p mm (inch)	1,25 (0.049)	0,93 (0.037)	0,65 (0.026)
Pass 1 mm (inch)	0,25 (0.010)	0,22 (0.009)	0,22 (0.009)
2	0,36 (0.014)	0,31 (0.012)	0,25 (0.010)
3	0,25 (0.010)	0,22 (0.009)	0,18 (0.007)
4	0,21 (0.008)	0,18 (0.007)	-
5	0,18 (0.007)	-	-

Internal 60° threads, metric (Inch)

Ph mm	2.0	1.5	1.0
a _p mm (inch)	1,17 (0.046)	0,85 (0.033)	0,60 (0.024)
Pass 1 mm (inch)	0,23 (0.009)	0,20 (0.008)	0,19 (0.007)
2	0,34 (0.013)	0,27 (0.011)	0,23 (0.009)
3	0,23 (0.009)	0,20 (0.008)	0,18 (0.007)
4	0,19 (0.007)	0,18 (0.007)	-
5	0,18 (0.007)	-	-

External and internal Whitworth and BSPT threads, metric (Inch)

TPI	11	14
a _p mm (inch)	1,58 (0.062)	1,20 (0.047)
Pass 1 mm (inch)	0,26 (0.010)	0,22 (0.009)
2	0,38 (0.015)	0,35 (0.014)
3	0,27 (0.011)	0,24 (0.009)
4	0,25 (0.010)	0,21 (0.008)
5	0,22 (0.009)	0,18 (0.007)
6	0,20 (0.008)	-

Ph = Lead

a_p = Total infeed depth

TPI = Threads per inch

Recommendations are for steel with a hardness < 300 HB

Thread turning

MDT

Mini-Shaft™

Thread milling

Thread tapping

Annex

External UN threads, metric (Inch)

TPI	12	16
a_p mm (inch)	1,39 (0.055)	1,05 (0.041)
Pass 1 mm (inch)	0,28 (0.011)	0,25 (0.010)
2	0,38 (0.015)	0,36 (0.014)
3	0,28 (0.011)	0,26 (0.010)
4	0,25 (0.010)	0,18 (0.007)
5	0,20 (0.008)	-

Internal UN threads, metric (Inch)

TPI	12	16
a_p mm (inch)	1,25 (0.049)	0,93 (0.037)
Pass 1 mm (inch)	0,24 (0.009)	0,21 (0.008)
2	0,35 (0.014)	0,32 (0.013)
3	0,25 (0.010)	0,22 (0.009)
4	0,22 (0.009)	0,18 (0.007)
5	0,19 (0.007)	-

Ph = Lead

a_p = Total infeed depth

TPI = Threads per inch

Recommendations are for steel with a hardness < 300 HB

Infeed method

The choice of infeed method is most important for long chipping materials to ensure good chip control.

Modified flank infeed

For CNC machines and conventional machines

First choice for CNC machines
The infeed angle should be 2,5–5% less than the flank angle

- Good chip control (important for internal threading)
- Good surface finish on thread
- Long tool life

Flank infeed

For CNC machines and conventional machines

Choose flank infeed when modified flank infeed cannot be used

- Good chip control
- Can result in bad surface on thread
- Not suitable for work hardening materials

Radial infeed

For conventional machines and multi-tooth inserts

Multitooth inserts demand radial infeed
First choice for work hardening materials

- Difficult to control the chip
- High cutting forces

Alternate flank infeed

For CNC machines

First choice for large coarse threads

- Long tool life
- Chipbreaking problems can arise

Nomenclature and formula

RPM	$n = \frac{v_c \cdot 1000}{\pi \cdot D_c} \quad (\text{rev/min})$
Cutting speed	$v_c = \frac{n \cdot \pi \cdot D_c}{1000} \quad (\text{m/min})$
Slide velocity/feed rate	$v_f = \frac{n \cdot P_h}{1000} \quad (\text{mm/min})$
Lead	$P_h = P \cdot \text{numbers of starts} \quad (\text{mm})$
Helix angle	$\lambda = \arctan \frac{P_h}{D_2 \cdot \pi} \quad (^\circ)$
Conversion of P to TPI	$\text{TPI} = \frac{25,4}{P}$

RPM	$n = \frac{v_c \cdot 3.82}{D} \quad (\text{rev/min})$
Cutting speed	$v_c = \frac{0.262 \cdot D \cdot n}{1000} \quad (\text{sf/min})$
Slide velocity/feed rate	$Sv = \frac{n \cdot P_h}{1000} \quad (\text{in/min})$
Lead	$P_h = P \cdot \text{numbers of starts} \quad (\text{inch})$
Helix angle	$\lambda = \arctan \frac{P_h}{D_2 \cdot \pi} \quad (^\circ)$
Conversion Pitch – TPI	$P = \frac{1}{\text{TPI}}$

D_c = Workpiece diameter (mm)
 D_2 = Pitch diameter (mean diameter) (mm)
 n = RPM (rev/min)
 P = Pitch (mm)
 P_h = Lead (mm)
 v_f = Slide velocity (feed rate) (m/min)
 TPI = Number of threads per inch
 v_c = Cutting speed (mm/min)
 λ = Helix angle ($^\circ$)

D = Workpiece diameter (inch)
 D_2 = Pitch diameter (effective diameter) (inch)
 n = RPM (r/min)
 P = Pitch (inch)
 P_h = Lead (inch)
 Sv = Slide velocity (in/min)
 TPI = Thread per inch
 v_c = Cutting speed (sf/min)
 λ = Helix angle ($^\circ$)

Toolholder modification to thread small ID

It is often necessary to cut internal threads which are too small to be made with a standard toolholder.

Several standard internal toolholders can be modified by a simple reworking so that threads can be cut in approximately 30% smaller bores. This modification work can be made on a lathe with a four-jaw chuck. In the dimension table DCINN at pages 'Toolholders Internal' you will find the dimensions required for the alteration.

On demand, these internal toolholders can also be supplied as special design.

For some holders it is possible to work inside smaller bores than indicated by the DCINN2 dimension, here it is necessary "to back off" the bottom corner of the insert (possibly also the insert shim).

Reference dimensions on insert

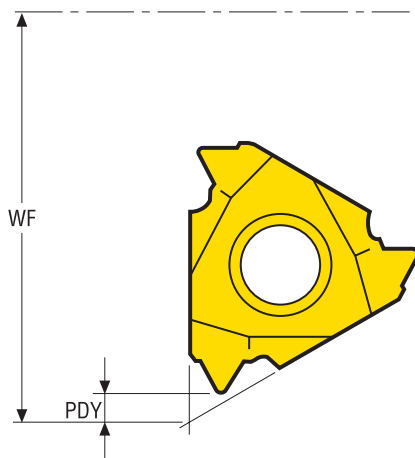

WF and PDY dimensions can be found on the pages for internal toolholders and threading inserts.

Reference dimensions on bar

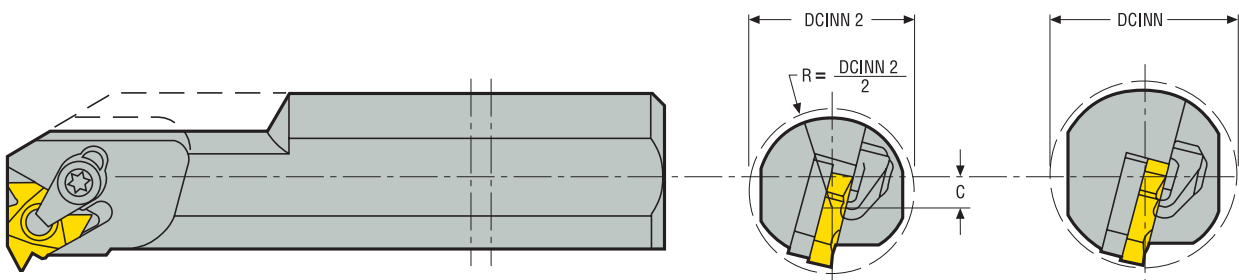

$$C = WF - PDY + R - DCINN2$$

C = Centre-point displacement when modifying the tool.
DCINN = Minimum bore diameter of standard tool.
DCINN2 = Minimum bore diameter with a modified tool.

Troubleshooting

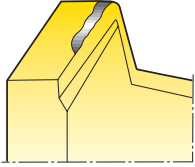
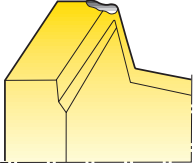
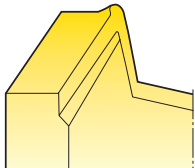
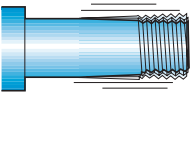
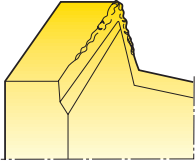
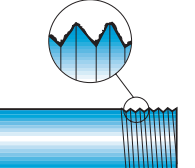
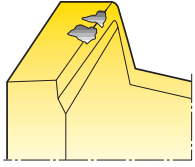
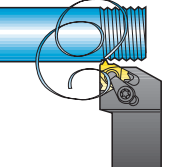
<p>Rapid flank wear</p> <ul style="list-style-type: none"> • Reduce the cutting speed • Increase the infeed per pass • Use modified flank infeed • Check that the correct insert shim has been selected • Select a more wear-resistant grade 	<p>Insert fracture</p> <ul style="list-style-type: none"> • Increase the number of passes • Check the workpiece mounting • Check the centre height of the cutting edge • Check for built-up edge • Select a tougher grade 
<p>Plastic deformation</p> <ul style="list-style-type: none"> • Select a grade with better resistance to plastic deformation • Reduce the cutting speed • Increase the number of passes • Increase the coolant supply • Check that the workpiece diameter is correct prior to cutting the thread 	<p>Vibrations</p> <ul style="list-style-type: none"> • Change the cutting speed • Reduce the overhang and use the most stable toolholder • Check the centre height of the cutting edge • Check that the workpiece diameter is correct 
<p>Build-up edge</p> <ul style="list-style-type: none"> • Increase the cutting speed • Do not use coolant 	<p>Poor finish</p> <ul style="list-style-type: none"> • Increase the cutting speed • Check that the correct insert shim has been selected • Use modified flank infeed or radial infeed 
<p>Edge chipping</p> <ul style="list-style-type: none"> • Check the workpiece mounting • Check the cutting speed • Use modified flank infeed • Select a tougher grade 	<p>Poor chip control</p> <ul style="list-style-type: none"> • Reduce the number of passes • Increase the cutting speed • Use modified flank infeed • Increase the coolant supply 

Optimisation

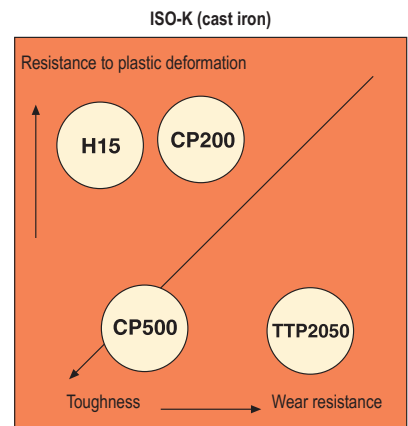
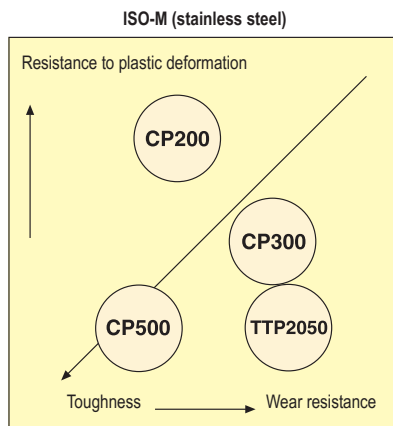
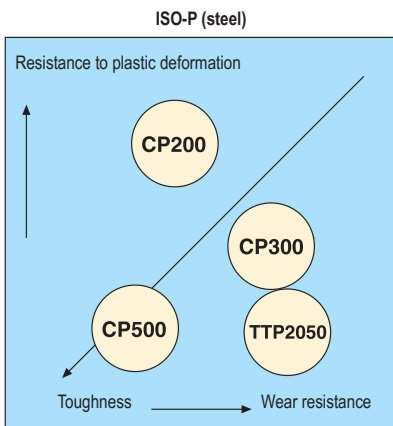

Torque values for clamping screws

Maximum Torque value for each screw is shown below

Screw designation	Torque Nm	Torque key
110.26-655	10,0	H00T-60100
117.26-655	5,0	H00T-3050
117.26-657	3,0	H00-2530
170.26-655	6,0	H00T-4060
C02205-T07P	0,9	T00-07P09
C02505-T07P	0,9	T00-07P09
C02506-T07P	0,9	T00-07P09
C03007-T09P	2,0	T00-09P20
C03508-T15P	3,0	T00-15P30
C03509-T15P	3,0	T00-15P30
C03510-T15P	3,0	T00-15P30
C03511-T09P	2,0	T00-09P20
C03512-T15P	3,0	T00-15P30
C04008-T15P	3,5	T00-15P35
C04010-T15P	3,5	T00-15P35
C04011-T15P	3,5	T00-15P35
C04014-T15P	3,5	T00-15P35
C04512-T15P	5,0	T00-15P50
C04518-T15P	5,0	T00-15P50
C05010-T20P	5,0	T00-20P50
C05012-T15P	5,0	T00-15P50
C05013-T20P	5,0	T00-20P50
C05018-T20P	5,0	T00-20P50
C11804-T06P	0,5	T00-06P05
C46017-T20P	6,0	T00T-20P60
C82204-T06P	0,5	T00-06P05
CC05	0,9	H00-1509
CC08P-V13	2,0	T00-09P20
CC09P-D11	2,0	T00-09P20
CC12P-S12	3,5	T00-15P35
CC14	6,0	H00T-4060
CC16	10,0	-
CC17P	10,0	-
CC17P-06	10,0	-
CC17P-09	10,0	-
CC20P	10,0	-
CC20P-V13	10,0	-
CD09-S09	2,0	T00-09P20
CD12-S12	3,5	T00-15P35
CD16-S16	5,0	T00-20P50
CD19-S19	5,0	T00-20P50
CD19-V16	5,0	T00-20P50
CSC8015-T20P	5,0	T00-20P50
CSC1015-T20P	5,0	T00-20P50
CSP16-T15P	2,0	T00-15P20
CSP22-T15P	3,0	T00-15P30
CSP27-T25P	6,0	T00T-25P60

Screw designation	Torque Nm	Torque key
L84017-T09P	2,0	T00-09P20
L85011-T15P	5,0	T00-15P50
L85012-T15P	5,0	T00-15P50
L85017-T09P	2,0	T00-09P20
L85020-T15P	3,5	T00-15P35
L85021-T15P	3,5	T00-15P35
L86015-T20P	6,0	T00T-20P60
L86025-T20P	6,0	T00T-20P60
LD1035-T25P	6,0	T00T-25P60
LD5020-T09P	2,0	T00-09P20
LD6020-T15P	3,0	T00-15P30
LD6021-T09P	2,0	T00-09P20
LD6024-T20P	3,0	T00-15P30
LD6025-T15P	3,0	T00-15P30
LD6026-T09P	2,0	T00-09P20
LD8025-T25P	6,0	T00T-25P60
LD8030-T25P	6,0	T00T-25P60
LS0512	2,5	-
LS0613	3,0	H00-2530
LS0616	3,0	H00-2530
LS0818	4,0	-
LS0822	4,0	-
MC6S4X14	3,5	-
MC6S4X18	3,5	-
MC6S5X14	5,0	H00T-4050
MC6S5X18	5,0	H00T-4050
MN0909L-T09P	2,0	T00-09P20
MN1215L-T15P	3,0	T00-15P30
MN1215R-T15P	3,0	T00-15P30
MN1215S-T15P	3,0	T00-15P30
MN1215T-T15P	3,0	T00-15P30
MN1515-T15P	3,0	T00-15P30
MN1515SL-T15P	3,0	T00-15P30
MN1520-T20P	6,0	T00T-20P60
MN1920-T20P	6,0	T00T-20P60
MN1925-T25P	5,0	T00T-25P50
MN2525-T25P	6,0	T00T-25P60
PL1403-T09P	2,5	T00-09P20
TCEI0409	3,5	-
TCEI0509	6,0	H00T-4060
TCEI0513	6,0	H00T-4060
TCEI0609	8,0	H00T-5080
TCEI0613	8,0	H00T-5080
TCEI0614	8,0	H00T-5080
TCEI0620	8,0	H00T-5080
TCEI0815	10,0	H00T-60100
TCEI0825	10,0	H00T-60100
TCEI1020	15,0	-
WS1620-T20P	3,5	T00-20P35
WS1920-T20P	3,5	T00-20P35
WS2325-T25P	5,0	T00T-25P50

For the Seco range of torque keys, please see next page

Thread turning

MDT

Mini-Shaft™

Thread milling

Thread tapping

Annex

Application overview, toolholders

External toolholders

PER/L...QHDJET PER/L...QHDJET	CER/L CER/L...HD	CER/L...Q CER/L...QHD	CER...CQHD	CER...HD CER/L...QHD
Page(s) 55-56	Page(s) 60	Page(s) 62, 63	Page(s) 66	Page(s) 69

Internal toolholders

PNR/L...AHDJET	SNR/L	CNR/L...AHD CNR/L...APIHD	CNR/L...AHD
Page(s) 57, 58-59	Page(s) 70	Page(s) 71, 72	Page(s) 78

Seco-Capto™

CER/L...HD...CHD Ext.	CER...HD Ext.	SNR Int.	CNR/L...HD Int.	CNR/L...CHD Int.
Page(s) 79, 80	Page(s) 83	Page(s) 84, 85	Page(s) 86, 87-90	Page(s) 91-93

Seco-Capto™ for MTM

CER...HD	CEL...HD
Page(s) 94	Page(s) 95

Steadyline® with GL connection

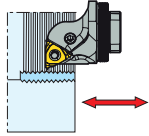
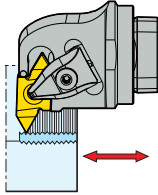
GL...PNR/L...AHDJET	GL50-CNR...26AHD
	
Page(s) 96, 97	Page(s) 98

Quick Change, Jetstream Tooling®, QC-heads, external

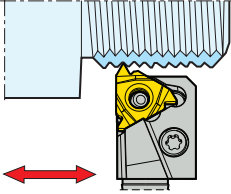
QC...PER/L-HDJET

Page(s) 99

Toolholders for peeling

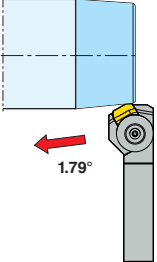
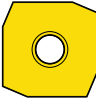
Inserts for peeling

CSXCR...	SCNN
	
Page(s) 100-101	Page(s) 124

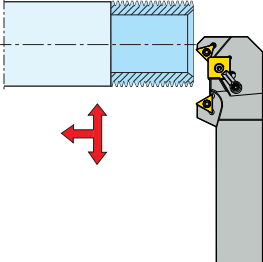
Toolholders for pipe-facing

MSGNR...

Page(s) 102-103

Thread turning
MDT
Mini-Shaft™
Thread milling
Thread tapping
Annex

Toolholders for inserts SNMA, SNMG, SNMM / CNMA, CNMG, CNMM

C.-DSKNR/L - CLNR/L 75°		C.-MSKNR/L - PCLNR/L 75°	
Page(s) 104		Page(s) 105	

Toolholders for chasers

External toolholders for chasers CER...X	Seco-Capto™ CER...X	Seco-Capto™ CNR/L...X	Seco-Capto™ CNL...C-X	Steadyline® GL... -CNR/L...-I/X
Page(s) 106-107	Page(s) 108	Page(s) 109-110	Page(s) 111-112	Page(s) 113

Toolholders for Precision Grooves

CEAR/L...	SNR/L...	CNR/L...	CER/L...
Page(s) 114	Page(s) 116	Page(s) 118	Page(s) 123

Thread turning

MDT

Mini-Shaft™

Thread milling

Thread tapping

Annex

Application overview, inserts

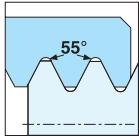
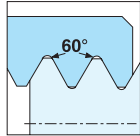
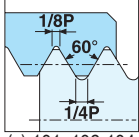
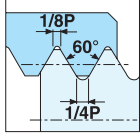
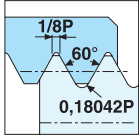
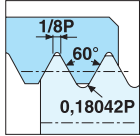
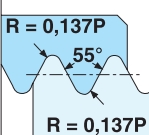
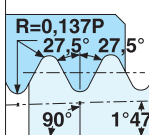
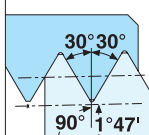
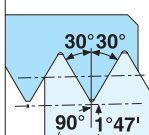
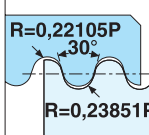
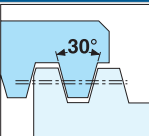
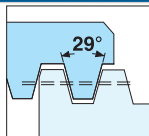
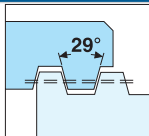
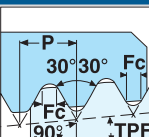
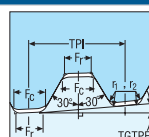
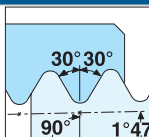
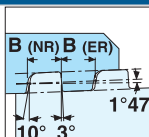
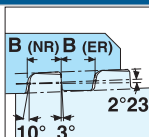
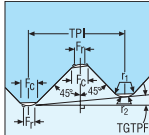
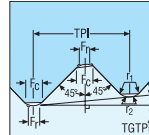
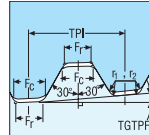
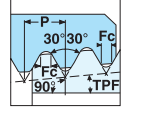
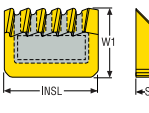
Partial profile inserts	55° V profile	60° V profile			
					
	Page(s) 125-126	Page(s) 127-129, 130			
Full profile inserts	ISO metric	UN			
Reusable threaded joints					
	Page(s) 131, 132-134, 135, 136	Page(s) 138, 139-141, 142			
Full profile inserts	UNJ	MJ			
Reusable threaded joints for the aerospace industry					
	Page(s) 144-145	Page(s) 146-147			
Full profile inserts	Whitworth, BSW	BSPT	NPT	NPTF	Round-DIN405
Permanent threaded joints for pipe mountings and couplings					
	Page(s) 148, 149-150, 151	Page(s) 152-153	Page(s) 154-155	Page(s) 156-157	Page(s) 158-159
Partial profile inserts	TR-DIN103	ACME	Stub-ACME	American Buttress	
Motion-transmitting threads					
	Page(s) 160-161	Page(s) 162-163	Page(s) 164-165	Page(s) 166-167	
Full profile inserts	API Rotary Drill Connection	Hughes Flush	API ROUND	API Buttress 1:16	API Buttress 1:12
Threads for the oil industry					
	Page(s) 168-169	Page(s) 170-171	Page(s) 172-173	Page(s) 174-175	Page(s) 176-177
Full profile inserts	Hughes H90	Hughes Slimline H90	P.A.C	Chasers API/Gost	Chipformers for chasers
Threads for the oil industry					
	Page(s) 170-171	Page(s) 170-171	Page(s) 170-171	Page(s) 178, 179	Page(s) 180, 181, 182

Rotary drilling connections

OCTG pipe and coupling illustration

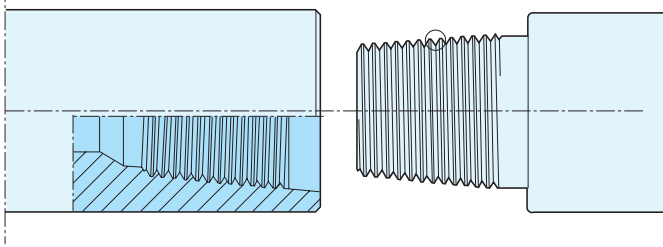

Connections	Pitch TPI	TGTPF	API code	Snap-Tap® code
API Number				
NC10 - NC16	6.0	1.5	V055	6API558
NC23 - NC50	4.0	2.0	V038R	4API386
NC56 - NC77	4.0	3.0	V038R	4API384
API Regular				
1 - 1 1/2 REG	6.0	1.5	V055	6API558
2 3/8 REG - 4 1/2 REG	5.0	3.0	V040	5API404
5 1/2 REG, 7 5/8 REG, 8 5/8 REG	4.0	3.0	V050	4API504
6 5/8 REG	4.0	2.0	V050	4API506
Internal Flush				
2 3/8 IF - 6 5/8 IF	4.0	2.0	V038R	4API386
Full Hole				
3 1/2 FH, 4 1/2 FH	5.0	3.0	V040	5API404
4 FH	4.0	2.0	V038R	4API386
5 1/2 FH, 6 5/8 FH	4.0	2.0	V050	4API506
Hughes External Flush				
2 3/8, 2 7/8	6.0	2.0	-	6HEF
3 1/2, 4 1/2	4.0	2.0	V038R	4API386
Hughes Xtra Hole				
2 7/8 - 5	4.0	2.0	V038R	4API386
Hughes Slim Hole				
2 3/8 - 4 1/2	4.0	2.0	V038R	4API386
Hughes Double Streamline				
3 1/2 - 5 1/2	4.0	2.0	V038R	4API386
Hughes H90				
3 1/2 - 6 5/8	3.5	2.0	90V050	3.5H906
7 - 8 5/8	3.5	3.0	90V050	3.5H904
Hughes Slimline H90				
2 3/8 - 3 1/2	3.0	1.25	90V050	3H90
Hughes ACME Regular				
2 3/8 - 6 5/8	4.0	3.373	-	4HACME
Hughes ACME Streamline				
2 3/8 - 5 1/2	4.0	3.373	-	4HACME
P.A.C.				
2 3/8 PAC - 3 1/2 PAC	4.0	1.5	V076	4PAC
Macaroni				
MT, AMT, AMMT	6.0	1.5	V055	6API558

Thread turning

MDT

Mini-Shaft™

Thread milling

Thread tapping

Annex

Rotary drilling connections

Connections

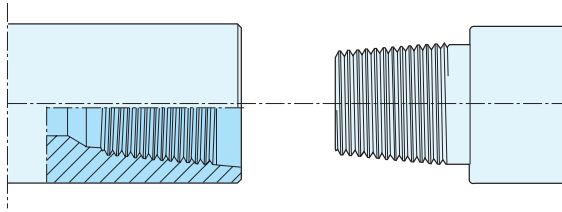

Insert dimensions

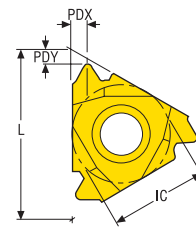

Connections							
Snap-Tap® code	API code	Pitch TPI	TGTPF <i>inch</i>	L mm	IC mm	PDX mm	PDY mm
6API558	V055	6.0	1.5	22,0	12,700	2,5	2,0
5API404	V040	5.0	3.0	22,0	12,700	2,5	2,0
5API404	V040	5.0	3.0	27,5	15,875	3,2	2,2
4API386	V038R	4.0	2.0	22,0	12,700	2,5	1,9
4API386	V038R	4.0	2.0	27,5	15,875	3,2	2,2
4API384	V038R	4.0	3.0	27,5	15,875	3,2	2,2
4API506	V050	4.0	2.0	27,5	15,875	3,2	2,2
4API504	V050	4.0	3.0	27,5	15,875	3,2	2,2
6HEF	–	6.0	2.0	22,0	12,700	2,5	2,0
4PAC	V076	4.0	1.5	27,5	15,875	3,2	2,2
3,5H906	90V050	3.5	2.0	27,5	15,875	3,2	2,2
3,5H904	90V050	3.5	3.0	27,5	15,875	3,2	2,2
3H90	90V050	3.0	1.25	27,5	15,875	3,2	2,2
4HACME	–	4.0	3.373	27,5	15,875	3,2	2,2

Thread profile

Profile	TPI	TGTPF	R/F _r mm (inch)	F _c mm (inch)	r ₁ mm (inch)	r ₂ mm (inch)	API code	Snap-Tap® code
	5.0	3.0	0,508 (0.200)	1,016 (0.0400)	0,381 (0.0150)	–	V040	5API404
	4.0	2.0	0,965 (0.0380)	1,651 (0.0650)	0,381 (0.0150)	–	V038R	4API386
	4.0	3.0	0,965 (0.0380)	1,651 (0.0650)	0,381 (0.0150)	–	V038R	4API384
	4.0	2.0	0,635 (0.0250)	1,270 (0.0500)	0,381 (0.0150)	–	V050	4API506
	4.0	3.0	0,635 (0.0250)	1,270 (0.0500)	0,381 (0.0150)	–	V050	4API504
	6.0	1.5	1,194 (0.0470)	1,397 (0.0550)	0,381 (0.0150)	0,381 (0.0150)	V055	6API558
	6.0	2.0	0,559 (0.0220)	0,813 (0.0320)	0,381 (0.0150)	0,381 (0.0150)	–	6HEF
	4.0	1.5	1,702 (0.0670)	1,930 (0.0760)	0,381 (0.0150)	0,381 (0.0150)	V076	4PAC
	3.5	2.0	0,864 (0.0340)	1,270 (0.0500)	0,381 (0.0150)	0,762	90V050	3.5H906
	3.5	3.0	0,864 (0.0340)	1,270 (0.0500)	0,381 (0.0150)	0,762	90V050	3.5H904
	3.0	1.25	1,727 (0.0680)	2,134 (0.0840)	0,381 (0.0150)	0,762	90V050	3H90
	4.0	3.373	2,253 (0.0887)	2,388 (0.0940)	0,787 (0.0310)	0,787 (0.0310)	–	4HACME

Thread turning

MDT

Mini-Shaft™

Thread milling

Thread tapping

Annex

Oil and gas threading

Seco Snap-Tap® Quality Assurance

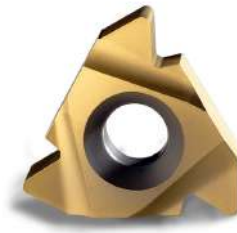

1. Metallurgical control of substrate

Check of substrate regarding Hc, MM and porosity.
Measured according to SPM.
Values stored in a database.

4. Dimension control after grinding

Profile and radius.
Measured according to SPM.

7. Final inspection

Visual Inspection.
Sampling in accordance to AQL.

2. Dimension check after sintering

Measuring of IC and thickness.
Measured according to SPM.
Values stored in a database.

5. Edge measuring

Edge radius checked during honing.
Measured according to SPM.
Values stored in a database.

8. Production management System

SGS (SPM1) - Control specifications.
LS - Production instructions.
Seco Act - System for preventive and corrective actions.
Approved to ISO 9001 and 14001 standard.

3. Dimension control after bottom grinding

Thickness and cutting edge height.
Flatness.
Measured according to SPM.

6. Measuring of coating

Coating, check of thickness and adhesion.
Measured according to SPM.
Values stored in a database.

9. Abbreviations

LS - Local management Systems - contains local process descriptions, routines, procedures and instructions.
SGS - Seco Global Standards - consists of instructions common for all Seco companies.
SPM - Seco Production Manual - Part of SGS is a collection of instructions and documents with the purpose to guide and maintain the quality level of Seco products.
AQL - Accepted Quality Level (Mil-std).
MM - Content of Tungsten in binder.
Hc - Coercivity, describing grainsize.

Oil and gas threading

Seco Chasers Quality Assurance



1. Metallurgical control of substrate

Check of substrate regarding Hc, MM and porosity.
Measured according to SPM.
Values stored in a database.

2. Dimension control after top and bottom grinding

Thickness.
Roughness Ra.
Flatness.
Measured according to SPM.

3. Measuring after periphery Grinding

Optical measuring.
Data stored in a database.

4. Dimension control after grinding

Profile and radius.
Measured according to SPM.

5. Edge measuring

Edge radius checked during honing.
Measured according to SPM.
Values stored in a database.

6. Measuring of coating

Coating (PVD), check of thickness and adhesion.
Measured according to SPM.
Values stored in a database.

7. Height classification

Optical measuring of height.
Graphic presentation of values.
Sorted and labelled with height classification.

8. Final inspection

Edge inspection 100%.
Profile check with tolerance drawing, sampling in accordance to AQL.

9. Traceability

Finished products from each order saved for future reference.
Saved 5 years from production date.
Finished product has full traceability.

10. Overlay drawings

Printer for overlays is calibrated with glass scale monthly.
Scaled master printout is saved according to SPM.

11. Production management System

SGS (SPM1) - Control specifications.
LS - Production instructions.
Seco Act - System for preventive and corrective actions.
Approved to ISO 9001 and 14001 standard.

12. Abbreviations

LS - Local management Systems - contains local process descriptions, routines, procedures and instructions.
SGS - Seco Global Standards - consists of instructions common for all Seco companies.
SPM - Seco Production Manual - Part of SGS is a collection of instructions and documents with the purpose to guide and maintain the quality level of Seco products.
AQL - Accepted Quality Level (Mil-std).
MM - Content of Tungsten in binder.
Hc - Coercivity, describing grainsize.

ISO attributes

ISO attribute	Explanation
AN	clearance angle major
B	shank width
BAWS	workpiece side body angle
BD	body diameter
BLQ	balance quality code
CDRX	cutting depth radial maximum
CDX	cutting depth maximum
CDXI	cutting depth maximum insert
CDXSH	cutting depth maximum shank
CF	spot chamfer
CNT	coolant entry thread size
CP	coolant pressure
CTMS	connection text machine side
CTWS	connection text workpiece side
CUTDIA	work piece parting diameter maximum
CW	cutting width
D1	fixing hole diameter
DCB	connection bore diameter
DCB1	connection bore diameter 1
DCB2	connection bore diameter 2
DCINN	cutting diameter internal minimum
DCINN2	cutting diameter internal minimum 2
DCINN3	cutting diameter internal minimum 3
DCP	data chip provision
DCSFMS	contact surface diameter machine side
DF	flange diameter
DIX	tool changer interference diameter maximum
DMM	shank diameter
EPSR	insert included angle
GAMO	rake angle orthogonal
H	shank height
HF	functional height
HRY	measure, Measure from ref. plane of mounting to bottom plane of unit in direction Y m
IC	inscribed circle diameter
INPLM	minimum initial plunge diameter
INPLX	initial plunge maximum
INSD	insert diameter
INSL	insert length
KCHL	corner chamfer angle left hand
KCHR	corner chamfer angle right hand
L	cutting edge length
LAMS	inclination angle
LB1	body length 1
LB2	body length 2
LCOG	length to center of gravity
LF	functional length
LF2	functional length_2
LFS	functional length secondary
LH	head length
LH2	head length 2
LIG	insert gauge length
LPR	protruding length

Thread turning

MDT

Mini-Shaft™

Thread milling

Thread tapping

Annex

ISO attributes

ISO attribute	Explanation
LS	shank length
LSC	clamping length
LU	usable length
OAH	overall height
OAL	overall length
OAW	overall width
PDX	profile distance ex
PSIRL	cutting edge angle major left hand
PHDR	recommended premachined hole diameter
PSIRR	cutting edge angle major right hand
RADH	radial body height
RADW	radial body width
RE	corner radius
RETL	flank radius left hand
RETR	flank radius right hand
RPMX	rotational speed maximum
S	insert thickness
TDZ	thread diameter size
TPI	threads per inch
W1	insert width
WF	functional width
WF2	functional width 2
WFS	functional width secondary

Thread turning

MDT

Mini-Shaft™

Thread milling

Thread tapping

Annex

Jetstream Tooling® Introduction

Seco Jetstream Tooling® is a revolutionary solution to the problem of delivering coolant precisely to the cutting zone.

It works by delivering a concentrated high pressure jet of coolant at high velocity straight to the optimum position precisely to the cutting edge.

The jet lifts the chips away from the rake face, improving chip control and tool life, enabling increased cutting data.

It has been proven to show improvements in nearly all material groups with a wide choice of coolant pressures.

Seco Jetstream Tooling® Duo holders, yet another innovation introduced to the market, features both a rake face and a flank face jet, that may provide even better chip control and significantly longer tool life.

For many years, Seco has been supporting the market with Jetstream Tooling® solutions for ISO-turning and grooving applications. Now the Jetstream Tooling® technique will also be available on holders for thread turning (Snap-Tap®).

Coolant can either be supplied to the toolholder externally through a coolant hose, which is attached to one of the inlet positions of the toolholder, or by the new JETI connection.

When it comes to boring bars, the coolant is supplied internally from the back end.

For internal applications, holders for Steadyline® bars are also available, designated GL-. Please see more information regarding Steadyline® in catalog Turning.

Square shank holders for external applications are designed with the Duo technique. They also have the option for coolant supply through JETI connection.

The JETI is developed with a compact assembly in mind, the tooling eliminates the need for any external piping and connections that would otherwise obstruct machine movements in tight workspaces. Coolant hole underneath the square shank holder make it possible for coolant to reach the cutting edge directly from the tool block.



Jetstream Tooling® Assembly instructions

Thread turning

MDT

Mini-Shaft™

Thread milling

Thread tapping

Annex

Description of parts

For personal safety, Jetstream Tooling® should only be used with the machine door in a fully closed position in accordance with general machine safety procedures.

Please ensure that the coolant hose is located correctly and fully tightened with all seals in position. The unused coolant hole should have a blanking plug fitted. Please note the maximum safe working pressures shown below.

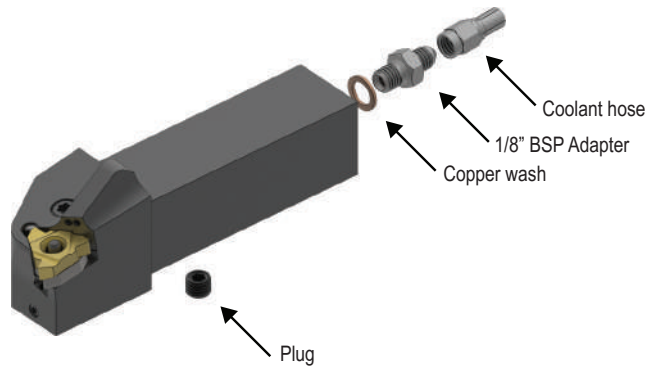

For accessories, see next page.

JETI Assembly instructions

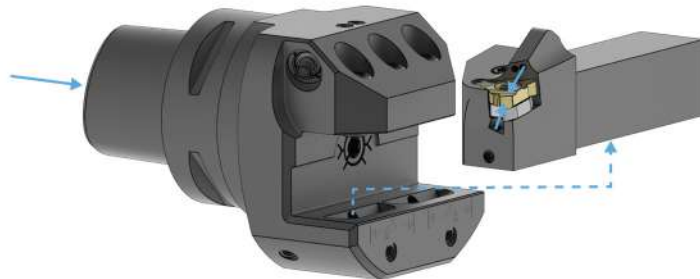

To use the benefits of a JETI-holder there is a need to use a basic holder designed for JETI-connections. Maximum coolant pressure when using this feature is 150 bar.

Note: The unused coolant hole (from the back) should have a blanking plug fitted.







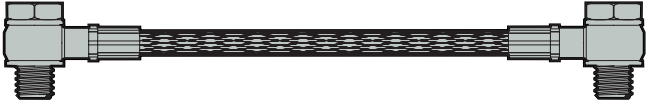





Accessories and spare parts

Hoses, Part No. ordering code includes spare parts

Connection type	Part No.	Length mm (inch)
Straight fitting 	JET-HOSE150SS	150 (5.906)
	JET-HOSE200SS	200 (7.874)
	JET-HOSE250SS	250 (9.843)
	JET-HOSE300SS	300 (11.811)
Banjo fitting 	JET-HOSE150BS	150 (5.906)
	JET-HOSE200BS	200 (7.874)
	JET-HOSE250BS	250 (9.843)
	JET-HOSE300BS	300 (11.811)
Banjo-to-Banjo fitting 	JET-HOSE150BB	150 (5.906)
	JET-HOSE200BB	200 (7.874)
	JET-HOSE250BB	250 (9.843)
	JET-HOSE300BB	300 (11.811)

All hoses are pressure rated to a maximum of 275 bar (3990 psi).

Spare Parts, Parts included in delivery

Part No.		...SS	...BS	...BB
JET-CFP1/8BSP		■	■	■
JET-CBP15		■	■	■
JET-AD1/8BSP		■	■	
JET-ADM10		■		
JET-BBM10			■	■
JET-BB1/8BSP			■	■
JET-C1/4-1/8BSP			■	■
JET-P1/8-5mm		■	■	■
JET-WM10*		■	■	■
JET-ORING10X1/**		■	■	■

Pack of 2, except *Pack of 20
 ** Not suitable for use in inducer
 For assembly instructions, see page(s) 52



Thread turning Toolholders

The innovative toolholders made for use with Snap-Tap® inserts offer the best possible holding power available for long tool life and high accuracy. They employ an Anti-Twist insert locking system that features a carbide pin in the back of the insert pocket that resists wear and prevents the insert from turning or twisting under pressure during machining.

- Anti-Twist Toolholders
- D-style clamp for securely pulls insert down and into the pocket

Jetstream Tooling® – Toolholders, external

For S-inserts, Snap-Tap®

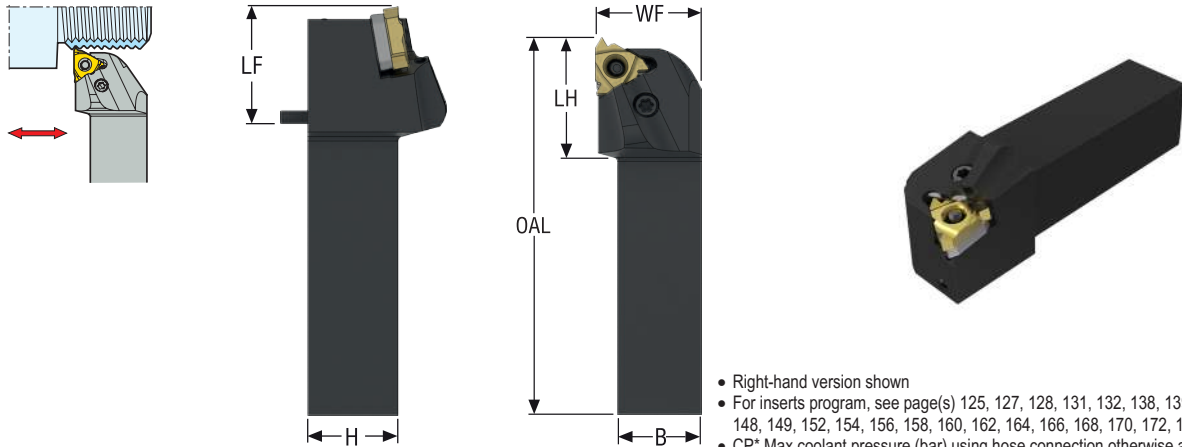

- Right-hand version shown
- For inserts program, see page(s) 125, 127, 128, 131, 132, 138, 139, 144, 146, 148, 149, 152, 154, 156, 158, 160, 162, 164, 166, 168, 170, 172, 174, 176
- CP* Max coolant pressure (bar) using hose connection otherwise according machine side adapter

Designation	Item number	H	B	LF	OAL	WF	LH	Weight	CP	CTWS
		mm	mm	mm	mm	mm	mm	kg	bar	
PER2020X16QHDJETI	03007228	20,0	20,0	27,0	91,0	25,0	30,0	0,5	275,0	16
PEL2020X16QHDJETI	03007229	20,0	20,0	27,0	91,0	25,0	30,0	0,4	275,0	16
PER2525X16QHDJETI	03007230	25,0	25,0	27,0	111,0	32,0	30,0	0,5	275,0	16
PEL2525X16QHDJETI	03007231	25,0	25,0	27,0	111,0	32,0	30,0	0,6	275,0	16
PER2525X22QHDJETI	03007241	25,0	25,0	41,0	125,0	32,0	44,0	0,7	275,0	22
PER2525X27QHDJETI	03007246	25,0	25,0	41,0	125,0	32,0	44,0	0,7	275,0	27

Spare Parts, included in delivery

For holders	Insert lever	Insert shim (S)	Lever screw	Locking key	Shim pin
...16QHD...	PP3712	GXA16-1	LS0612-T15P	T15P-7	AC4625
...22QHD...	PP4816	NXA22-1	LS0815-T25P	T25P-7	AC5035
...27QHD...	PP6019	VXA27-1	LS0820-T25P	T25P-7	AC6050

Accessories

For holders	Insert shim (M)	Insert shim (S)	Insert shim (S)	Insert shim (S)	Insert shim (S)	Insert shim (S)	Insert shim (S)	Insert shim (S)	Insert shim (S)	Insert shim (S)	Insert shim (S)	Insert shim (S)	Plug
...16QHD...	MXA16-1	GXA16-0	-	-	GXA16-2	GXA16-3	GXA16-4	GXA16-99	GXA16-98	-	-	-	P6SS4X8
...22QHD...	MXA22-1	NXA22-0	NXA22-98	NXA22-97.5	NXA22-0.5	NXA22-1.5	NXA22-2	NXA22-3	NXA22-4	NXA22-99.5	NXA22-99	NXA22-98.5	P6SS4X8
...27QHD...	MXA27-1	VXA27-0	VXA27-98	-	VXA27-0.5	VXA27-1.5	VXA27-2	VXA27-3	VXA27-4	VXA27-99.5	VXA27-99	VXA27-98.5	P6SS4X8

Jetstream Tooling® – Toolholders, external

For S-inserts, Snap-Tap®

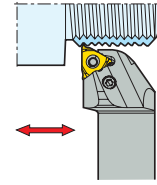
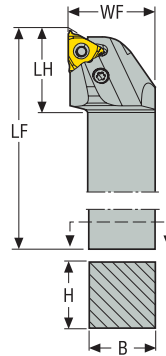

- Right-hand version shown
- For inserts program, see page(s) 125, 127, 128, 131, 132, 138, 139, 144, 146, 148, 149, 152, 154, 156, 158, 160, 162, 164, 166, 168, 170, 172, 174, 176
- CP* Max coolant pressure (bar) using hose connection otherwise according machine side adapter

Designation	Item number	H	B	LF	WF	LH	Weight	CP	CTWS
		<i>Inch</i>	<i>Inch</i>	<i>Inch</i>	<i>Inch</i>	<i>Inch</i>	<i>lbs</i>	<i>psi</i>	
PER075516QHDJET	03007234	0.750	0.750	5.000	0.970	1.181	0.880	10.827	16
PEL075516QHDJET	03007235	0.750	0.750	5.000	0.970	1.181	1.540	10.827	16
PER100616QHDJET	03007236	1.000	1.000	6.000	1.250	1.181	1.980	10.827	16
PEL100616QHDJET	03007237	1.000	1.000	6.000	1.250	1.181	1.980	10.827	16
PER125616QHDJET	03007238	1.250	1.250	6.000	1.500	1.181	2.650	10.827	16
PEL125616QHDJET	03007240	1.250	1.250	6.000	1.500	1.181	2.870	10.827	16
PER100622QHDJET	03007244	1.000	1.000	6.000	1.250	1.732	1.980	10.827	22
PER125622QHDJET	03007245	1.250	1.250	6.000	1.500	1.732	2.650	10.827	22
PER100627QHDJET	03007249	1.000	1.000	6.000	1.250	1.732	1.760	10.827	27
PER125627QHDJET	03007250	1.250	1.250	6.000	1.500	1.732	2.650	10.827	27

Spare Parts, included in delivery

For holders	Insert lever	Insert shim (S)	Lever screw	Locking key	Shim pin
..16QHJET	PP3712	GXA16-1	LS0612-T15P	T15P-7	AC4625
..22QHJET	PP4816	NXA22-1	LS0815-T25P	T25P-7	AC5035
..27QHJET	PP6019	VXA27-1	LS0820-T25P	T25P-7	AC6050

Accessories

For holders	Insert shim (M)	Insert shim (S)	Insert shim (S)	Insert shim (S)	Insert shim (S)	Insert shim (S)	Insert shim (S)	Insert shim (S)	Insert shim (S)	Insert shim (S)	Insert shim (S)	Insert shim (S)	Plug
..16QHJET	MXA16-1	GXA16-0	–	–	GXA16-2	GXA16-3	GXA16-4	GXA16-99	GXA16-98	–	–	–	P6SS4X8
..22QHJET	MXA22-1	NXA22-0	NXA22-98	NXA22-97.5	NXA22-0.5	NXA22-1.5	NXA22-2	NXA22-3	NXA22-4	NXA22-99.5	NXA22-99	NXA22-98.5	P6SS4X8
..27QHJET	MXA27-1	VXA27-0	VXA27-98	–	VXA27-0.5	VXA27-1.5	VXA27-2	VXA27-3	VXA27-4	VXA27-99.5	VXA27-99	VXA27-98.5	P6SS4X8

Thread turning

MDT

Mini-Shaft™

Thread milling

Thread tapping

Annex

Jetstream Tooling® – Toolholders, internal

For S-inserts, Snap-Tap®

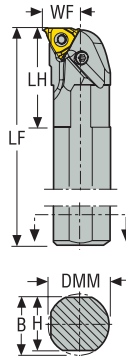
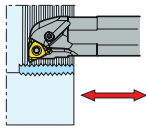





































- Right-hand version shown
- For inserts program, see page(s) 126, 129, 130, 134, 135, 136, 141, 142, 145, 147, 150, 151, 153, 155, 157, 159, 161, 163, 165, 173
- CP* Max coolant pressure (bar) using hose connection otherwise according machine side adapter

Designation	Item number	H	B	LF	WF	LH	DCINN	DMM	Weight	CP	CTWS
		mm	mm	mm	mm	mm	mm	mm	kg	bar	
PNR0020P16AHDJET	03006930	19,0	18,0	171,0	13,8	42,0	24,0	20,0	0,4	275,0	16
PNL0020P16AHDJET	03006931	19,0	18,0	171,0	13,8	42,0	24,0	20,0	0,5	275,0	16
PNR0025R16AHDJET	03006932	24,0	23,0	200,0	16,3	42,0	29,0	25,0	0,7	275,0	16
PNL0025R16AHDJET	03006933	24,0	23,0	200,0	16,3	42,0	29,0	25,0	0,6	275,0	16
PNR0032S16AHDJET	03006934	30,0	31,0	250,0	19,8	42,0	36,0	32,0	1,2	275,0	16
PNL0032S16AHDJET	03006935	30,0	31,0	250,0	19,8	42,0	36,0	32,0	1,5	275,0	16
PNR0040T16AHDJET	03006936	38,5	37,0	300,0	23,8	45,0	44,0	40,0	2,2	275,0	16
PNR0050U16AHDJET	03006937	47,0	48,5	350,0	28,8	52,0	54,0	50,0	4,5	275,0	16
PNR0025R22AHDJET	03006945	23,0	24,0	200,0	17,8	42,0	30,0	25,0	0,7	275,0	22
PNL0025R22AHDJET	03006946	23,0	24,0	200,0	17,8	42,0	30,0	25,0	0,7	275,0	22
PNR0032S22AHDJET	03006947	30,0	31,0	250,0	21,3	42,0	38,0	32,0	1,5	275,0	22
PNL0032S22AHDJET	03006948	30,0	31,0	250,0	21,3	42,0	38,0	32,0	1,5	275,0	22
PNR0040T22AHDJET	03006949	37,0	38,5	300,0	25,3	42,0	46,0	40,0	2,9	275,0	22
PNL0040T22AHDJET	03006950	37,0	38,5	300,0	25,3	42,0	46,0	40,0	2,6	275,0	22
PNR0050U22AHDJET	03006951	47,0	48,5	350,0	30,3	48,0	56,0	50,0	4,9	275,0	22
PNR0040T27AHDJET	03006955	37,0	38,5	300,0	26,8	62,0	48,0	40,0	2,8	275,0	27
PNR0050U27AHDJET	03006956	47,0	48,5	350,0	31,8	62,0	58,0	50,0	4,3	275,0	27
PNR0063V27AHDJET	03006957	60,0	61,5	400,0	38,3	62,0	70,0	63,0	8,9	275,0	27

Spare Parts, included in delivery

For holders	Insert lever	Insert shim (S)	Lever screw	Locking key	Shim pin
...20...	PP3712	GXA16-1	LS0610-T15P	T15P-7	AC4625
...25/32/40/50...	PP3712	GXA16-1	LS0612-T15P	T15P-7	AC4625
...22...	PP4816	NXA22-1	LS0815-T25P	T25P-7	AC5035
...27...	PP6019	VXA27-1	LS0820-T25P	T25P-7	AC6050

Accessories

For holders	Insert shim (M)	Insert shim (S)	Insert shim (S)	Insert shim (S)	Insert shim (S)	Insert shim (S)	Insert shim (S)	Insert shim (S)	Insert shim (S)	Insert shim (S)	Insert shim (S)	Insert shim (S)
...20...	 MXA16-1	 GXA16-0	-	-	 GXA16-2	 GXA16-3	 GXA16-4	 GXA16-99	 GXA16-98	-	-	-
...25/32/40/50...	 MXA16-1	 GXA16-0	-	-	 GXA16-2	 GXA16-3	 GXA16-4	 GXA16-99	 GXA16-98	-	-	-
...22...	 MXA22-1	 NXA22-0	 NXA22-98	 NXA22-97.5	 NXA22-0.5	 NXA22-1.5	 NXA22-2	 NXA22-3	 NXA22-4	 NXA22-99.5	 NXA22-99	 NXA22-98.5
...27...	 MXA27-1	 VXA27-0	 VXA27-98	-	 VXA27-0.5	 VXA27-1.5	 VXA27-2	 VXA27-3	 VXA27-4	 VXA27-99.5	 VXA27-99	 VXA27-98.5

Thread turning

MDT

Mini-Shaft™

Thread milling

Thread tapping

Annex

Jetstream Tooling® – Toolholders, internal

For S-inserts, Snap-Tap®

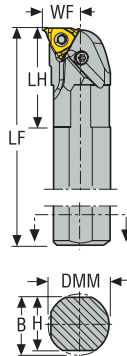
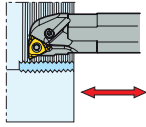

- Right-hand version shown
- For inserts program, see page(s) 126, 129, 130, 134, 135, 136, 141, 142, 145, 147, 150, 151, 153, 155, 157, 159, 161, 163, 165, 173
- CP* Max coolant pressure (bar) using hose connection otherwise according machine side adapter

Designation	Item number	H	B	LF	WF	LH	DCINN	DMM	Weight	CP	CTWS
		<i>Inch</i>	<i>Inch</i>	<i>Inch</i>	<i>Inch</i>	<i>Inch</i>	<i>Inch</i>	<i>Inch</i>	lbs	psi	
PNR00075716AHDJET	03006939	0.700	0.650	7.000	0.520	1.654	0.950	0.750	0.660	10.827	16
PNL00075716AHDJET	03006940	0.700	0.650	7.000	0.520	1.654	0.950	0.750	1.100	10.827	16
PNR00100816AHDJET	03006941	0.951	0.902	8.000	0.650	1.654	1.150	1.000	1.540	10.827	16
PNL00100816AHDJET	03006942	0.951	0.902	8.000	0.650	1.654	1.150	1.000	1.540	10.827	16
PNR001251016AHDJET	03006943	1.200	1.150	10.000	0.780	1.654	1.404	1.250	3.090	10.827	16
PNR001501216AHDJET	03006944	1.339	1.419	12.000	0.900	1.654	1.700	1.500	5.290	10.827	16
PNR00100822AHDJET	03006952	0.902	0.951	8.000	0.710	1.654	1.181	1.000	1.980	10.827	22
PNR001251022AHDJET	03006953	1.200	1.150	10.000	0.840	1.654	1.500	1.250	1.320	10.827	22
PNR001501222AHDJET	03006954	1.339	1.419	12.000	0.970	1.654	1.800	1.500	5.290	10.827	22
PNR001501227AHDJET	03006958	1.339	1.419	12.000	1.020	2.441	1.890	1.500	5.290	10.827	27

Spare Parts, included in delivery

For holders	Insert lever	Insert shim (S)	Lever screw	Locking key	Shim pin
PNR/L000757..	PP3712	GXA16-1	LS0610-T15P	T15P-7	AC4625
..16AHDJET	PP3712	GXA16-1	LS0612-T15P	T15P-7	AC4625
..22AHDJET	PP4816	NXA22-1	LS0815-T25P	T25P-7	AC5035
..27AHDJET	PP6019	VXA27-1	LS0820-T25P	T25P-7	AC6050

Accessories

For holders	Insert shim (M)	Insert shim (S)	Insert shim (S)	Insert shim (S)	Insert shim (S)	Insert shim (S)	Insert shim (S)	Insert shim (S)	Insert shim (S)	Insert shim (S)	Insert shim (S)	Insert shim (S)
PNR/L000757..	MXA16-1	GXA16-0	-	-	GXA16-2	GXA16-3	GXA16-4	GXA16-99	GXA16-98	-	-	-
..16AHDJET	MXA16-1	GXA16-0	-	-	GXA16-2	GXA16-3	GXA16-4	GXA16-99	GXA16-98	-	-	-
..22AHDJET	MXA22-1	NXA22-0	NXA22-98	NXA22-97.5	NXA22-0.5	NXA22-1.5	NXA22-2	NXA22-3	NXA22-4	NXA22-99.5	NXA22-99	NXA22-98.5
..27AHDJET	MXA27-1	VXA27-0	VXA27-98	-	VXA27-0.5	VXA27-1.5	VXA27-2	VXA27-3	VXA27-4	VXA27-99.5	VXA27-99	VXA27-98.5

Thread turning

MDT

Mini-Shaft™

Thread milling

Thread tapping

Annex

Toolholders, external

For S-inserts, Snap-Tap®

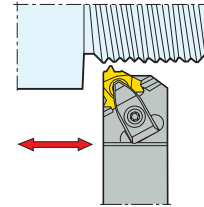
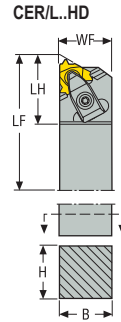
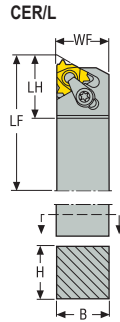

- Right-hand version shown
- For inserts program, see page(s) 125, 127, 128, 131, 132, 138, 139, 144, 146, 148, 149, 152, 154, 156, 158, 160, 162, 164, 166, 170

Designation	Item number	H	B	LF	WF	LH	Weight	CTWS
		mm	mm	mm	mm	mm	kg	
CER1616H16	02454783	16,0	16,0	100,0	16,0	22,0	0,2	16
CER2020K16HD	02475454	20,0	20,0	125,0	20,0	32,0	0,4	16
CER2525M16HD	02457882	25,0	25,0	150,0	25,0	32,0	0,8	16
CER4040R16HD	02853574	40,0	40,0	200,0	40,0	37,0	2,5	16
CEL1616H16	02454781	16,0	16,0	100,0	16,0	22,0	0,2	16
CEL2020K16HD	02475482	20,0	20,0	125,0	20,0	32,0	0,4	16
CEL2525M16HD	02457885	25,0	25,0	150,0	25,0	32,0	0,8	16
CER2525M22HD	02457888	25,0	25,0	150,0	25,0	38,0	0,8	22
CER4040R22HD	02853575	40,0	40,0	200,0	40,0	42,0	2,5	22
CEL2525M22HD	02457890	25,0	25,0	150,0	25,0	38,0	0,8	22
CER4040R27HD	02853576	40,0	40,0	200,0	40,0	48,0	2,5	27

Spare Parts, included in delivery

For holders	Cantilever clamp	Clamp key	Clamp kit	Clamp screw	Insert shim (S)	Shim screw	Spring
...16	-	T15P-2	CSP16-T15P	-	GX16-1	CS3507-T09P	-
...16HD	CHD16	T15P-7	-	L85020-T15P	GX16-1	CS3507-T09P	S6912
...22HD	CHD22	T20P-7L	-	L86025-T20P	NX22-1	CS4009-T15P	S7616
...27HD	CHD27	T20P-7L	-	L86025-T20P	VX27-1	C05012-T15P	S7616

Accessories

For holders	Insert shim (M)	Insert shim (S)	Insert shim (S)	Insert shim (S)	Insert shim (S)	Insert shim (S)	Insert shim (S)	Insert shim (S)	Insert shim (S)	Insert shim (S)	Insert shim (S)	Insert shim (S)	Shim key
...16	MX16-1	GX16-0	-	-	GX16-2	GX16-3	GX16-4	GX16-98	GX16-99	-	-	-	T09P-2
...16HD	MX16-1	GX16-0	-	-	GX16-2	GX16-3	GX16-4	GX16-98	GX16-99	-	-	-	T09P-2
...22HD	MX22-1	NX22-97.5	NX22-98	NX22-99	NX22-98.5	NX22-99.5	NX22-0.5	NX22-1.5	NX22-0	NX22-2	NX22-3	NX22-4	T15P-2
...27HD	MX27-1	VX27-98.5	VX27-2	-	VX27-99.5	VX27-0.5	VX27-1.5	VX27-98	VX27-99	VX27-3	VX27-4	VX27-0	T15P-2

Toolholders, external

For S-inserts, Snap-Tap®

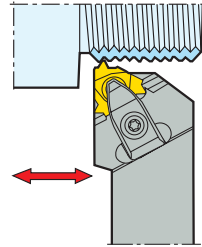
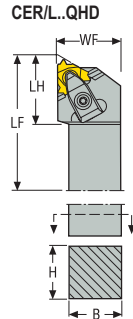
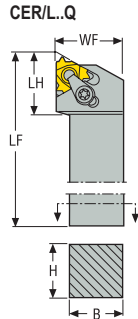

- Right-hand version shown
- For inserts program, see page(s) 125, 127, 128, 131, 132, 138, 139, 144, 146, 148, 149, 152, 154, 156, 158, 160, 162, 164, 166, 170

Designation	Item number	H	B	LF	WF	LH	Weight	CTWS
		<i>Inch</i>	<i>Inch</i>	<i>Inch</i>	<i>Inch</i>	<i>Inch</i>	lbs	
CER03753-16Q	00072538	0.375	0.375	3.000	0.375	0.900	0.440	16ER...
CER06254-16Q	00072498	0.625	0.625	4.000	0.750	0.900	0.660	16ER...
CEL06254-16Q	00072544	0.625	0.625	4.000	0.750	0.900	0.660	16EL...
CER0504-16Q	00072524	0.500	0.500	4.000	0.625	0.900	0.440	16ER...
CEL0504-16Q	00072466	0.500	0.500	4.000	0.625	0.900	0.440	16ER...
CEL0755-16HD	02483997	0.750	0.750	5.000	1.000	0.900	1.100	16EL...
CER0755-16HD	02483996	0.750	0.750	5.000	1.000	0.900	0.880	16ER...
CER1006-16QHD	02462821	1.000	1.000	6.000	1.250	1.100	1.980	16ER...
CEL1006-16QHD	02462852	1.000	1.000	6.000	1.250	1.100	1.980	16EL...
CER1256-16QHD	02462823	1.250	1.250	6.000	1.500	1.181	3.090	16ER...
CEL1256-16QHD	02462853	1.250	1.250	6.000	1.500	1.100	3.090	16EL...
CER1506-16QHD	02462825	1.500	1.500	6.000	1.750	1.100	3.970	16ER...

Spare Parts, included in delivery

For holders	Cantilever clamp	Clamp key	Clamp kit	Clamp screw	Insert shim (S)	Shim screw	Spring
CER/L 3753..0504..	-	T15P-2	CSP16-T15P	-	GX16-1	CS3507-T09P	-
CER 06254..	-	T15P-2	CSP16-T15P	-	GX16-1	CS3507-T09P	-
CEL 06254..	-	T15P-2	CSP16-T15P	-	GX16-1	CS3507-T09P	-
CER/L 0755..1006..	CHD16	T15P-7	-	L85020-T15P	GX16-1	CS3507-T09P	S6912
CER/L 1256..1506..	CHD16	T15P-7	-	L85020-T15P	GX16-1	CS3507-T09P	S6912

Accessories

For holders	Insert shim (K)	Insert shim (M)	Insert shim (S)	Insert shim (S)	Insert shim (S)	Insert shim (S)	Insert shim (S)	Insert shim (S)	Shim key
CER/L 3753..0504..	-	MX16-1	GX16-0	GX16-2	GX16-3	GX16-4	GX16-98	GX16-99	T09P-2
CER 06254..	GX16-2	MX16-1	GX16-0	-	GX16-3	GX16-4	GX16-98	GX16-99	T09P-2
CEL 06254..	-	MX16-1	GX16-0	GX16-2	GX16-3	GX16-4	GX16-98	GX16-99	T09P-2
CER/L 0755..1006..	-	MX16-1	GX16-0	GX16-2	GX16-3	GX16-4	GX16-98	GX16-99	T09P-2
CER/L 1256..1506..	-	MX16-1	GX16-0	GX16-2	GX16-3	GX16-4	GX16-98	GX16-99	T09P-2

Toolholders, external

For S-inserts, Snap-Tap®

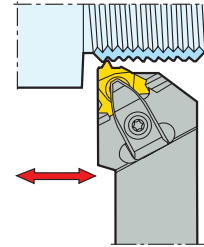
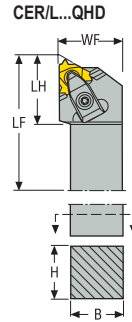
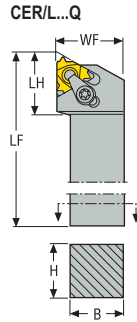

- Right-hand version shown
- For inserts program, see page(s) 125, 127, 128, 131, 132, 138, 139, 144, 146, 148, 149, 152, 154, 156, 158, 160, 162, 164, 166, 170

Designation	Item number	H	B	LF	WF	LH	Weight	CTWS
		mm	mm	mm	mm	mm	kg	
CER1212H16Q	75025274	12,0	12,0	100,0	16,0	22,0	0,2	16
CER1616H16Q	75025276	16,0	16,0	100,0	20,0	22,0	0,3	16
CER2020K16QHD	02475493	20,0	20,0	125,0	25,0	32,0	0,5	16
CER2525M16QHD	00016769	25,0	25,0	150,0	32,0	32,0	0,8	16
CER3225P16QHD	00016771	32,0	25,0	170,0	32,0	32,0	1,1	16
CER3232P16QHD	00016776	32,0	32,0	170,0	40,0	32,0	1,4	16
CEL1212H16Q	75025275	12,0	12,0	100,0	16,0	22,0	0,2	16
CEL1616H16Q	75025277	16,0	16,0	100,0	20,0	22,0	0,2	16
CEL2020K16QHD	02475514	20,0	20,0	125,0	25,0	32,0	0,5	16
CEL2525M16QHD	00016766	25,0	25,0	150,0	32,0	32,0	0,8	16
CEL3225P16QHD	00016770	32,0	25,0	170,0	32,0	32,0	1,1	16
CEL3232P16QHD	00016774	32,0	32,0	170,0	40,0	32,0	1,4	16
CER2525M22QHD	00016781	25,0	25,0	150,0	32,0	38,0	0,8	22
CER3225P22QHD	00016783	32,0	25,0	170,0	32,0	38,0	1,2	22
CER3232P22QHD	00016788	32,0	32,0	170,0	40,0	38,0	1,4	22
CEL2525M22QHD	00016777	25,0	25,0	150,0	32,0	38,0	0,8	22
CEL3225P22QHD	00016782	32,0	25,0	170,0	32,0	38,0	1,1	22
CEL3232P22QHD	00016785	32,0	32,0	170,0	40,0	38,0	1,4	22
CER2525M27QHD	00016800	25,0	25,0	150,0	32,0	46,0	0,8	27
CER3225P27QHD	00016857	32,0	25,0	170,0	32,0	46,0	1,2	27
CER3232P27QHD	00016878	32,0	32,0	170,0	40,0	46,0	1,5	27
CEL2525M27QHD	00016791	25,0	25,0	150,0	32,0	46,0	0,8	27
CEL3225P27QHD	00016830	32,0	25,0	170,0	32,0	46,0	1,2	27
CEL3232P27QHD	00016864	32,0	32,0	170,0	40,0	46,0	1,5	27

Spare Parts, included in delivery

For holders	Cantilever clamp	Clamp key	Clamp kit	Clamp screw	Insert shim (S)	Shim screw	Spring
...16Q	–	T15P-2	CSP16-T15P	–	GX16-1	CS3507-T09P	–
...16QHD	CHD16	T15P-7	–	L85020-T15P	GX16-1	CS3507-T09P	S6912
...22QHD	CHD22	T20P-7L	–	L86025-T20P	NX22-1	CS4009-T15P	S7616
...27QHD	CHD27	T20P-7L	–	L86025-T20P	VX27-1	C05012-T15P	S7616

Thread turning

MDT













Mini-Shaft™

Thread milling

Thread tapping

Annex

Accessories

For holders	Insert shim (M)	Insert shim (S)	Insert shim (S)	Insert shim (S)	Insert shim (S)	Insert shim (S)	Insert shim (S)	Insert shim (S)	Insert shim (S)	Insert shim (S)	Insert shim (S)	Insert shim (S)	Shim key
													
...16Q	MX16-1	GX16-0	-	-	GX16-2	GX16-3	GX16-4	GX16-98	GX16-99	-	-	-	T09P-2
...16QHD	MX16-1	GX16-0	-	-	GX16-2	GX16-3	GX16-4	GX16-98	GX16-99	-	-	-	T09P-2
...22QHD	MX22-1	NX22-97.5	NX22-98	NX22-99	NX22-98.5	NX22-99.5	NX22-0.5	NX22-1.5	NX22-0	NX22-2	NX22-3	NX22-4	T15P-2
...27QHD	MX27-1	VX27-98.5	VX27-2	-	VX27-99.5	VX27-0.5	VX27-1.5	VX27-98	VX27-99	VX27-3	VX27-4	VX27-0	T15P-2

Toolholders, external

For S-inserts, Snap-Tap®

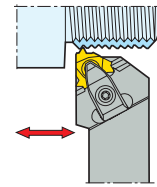
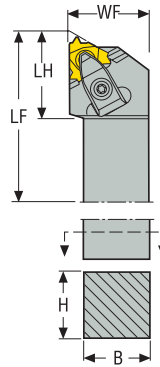

- Right-hand version shown
- For inserts program, see page(s) 125, 127, 128, 131, 132, 138, 139, 144, 146, 148, 149, 152, 154, 156, 158, 160, 162, 164, 166, 170

Designation	Item number	H	B	LF	WF	LH	Weight	CTWS
		<i>Inch</i>	<i>Inch</i>	<i>Inch</i>	<i>Inch</i>	<i>Inch</i>	lbs	
CER1005-22QHD	02462826	1.000	1.000	5.000	1.250	1.300	0.220	22ER...
CEL1005-22QHD	02462854	1.000	1.000	5.000	1.250	1.300	1.760	22EL...
CER1006-22QHD	02462827	1.000	1.000	6.000	1.250	1.300	1.980	22ER...
CEL1006-22QHD	02462856	1.000	1.000	6.000	1.250	1.300	2.200	22EL...
CER1256-22QHD	02462829	1.250	1.250	6.000	1.500	1.417	2.870	22ER...
CEL1256-22QHD	02462857	1.250	1.250	6.000	1.500	1.300	3.090	22EL...
CER1506-22QHD	02462831	1.500	1.500	6.000	1.750	1.300	4.190	22ER...

Spare Parts, included in delivery

For holders	Cantilever clamp	Clamp key	Clamp screw	Insert shim (S)	Shim screw	Spring
CER/L...22..	CHD22	T20P-7L	L86025-T20P	NX22-1	CS4009-T15P	S7616

Accessories

For holders	Insert shim (M)	Insert shim (S)	Insert shim (S)	Insert shim (S)	Insert shim (S)	Insert shim (S)	Insert shim (S)	Insert shim (S)	Insert shim (S)	Insert shim (S)	Insert shim (S)	Insert shim (S)	Shim key
CER/L...22..	MX22-1	NX22-97.5	NX22-98	NX22-99	NX22-98.5	NX22-99.5	NX22-0.5	NX22-1.5	NX22-0	NX22-2	NX22-3	NX22-4	T15P-2

Toolholders, external

For S-inserts, Snap-Tap®

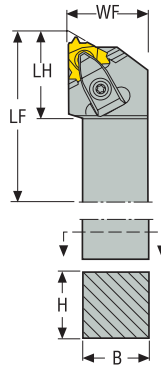
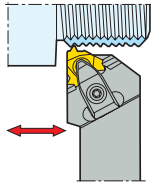

- Right-hand version shown
- For inserts program, see page(s) 125, 127, 128, 131, 132, 138, 139, 144, 146, 148, 149, 152, 154, 156, 158, 160, 162, 164, 166, 170

Designation	Item number	H	B	LF	WF	LH	Weight	CTWS
		<i>Inch</i>	<i>Inch</i>	<i>Inch</i>	<i>Inch</i>	<i>Inch</i>	lbs	
CER1006-27QHD	02462835	1.000	1.000	6.000	1.250	1.600	2.200	27ER...
CEL1006-27QHD	02462859	1.000	1.000	6.000	1.250	2.000	2.200	27EL...
CER1256-27QHD	02462837	1.250	1.250	6.000	1.500	1.732	3.090	27ER...
CEL1256-27QHD	02462861	1.250	1.250	6.000	1.500	1.600	2.870	27EL...
CER1506-27QHD	02462839	1.500	1.500	6.000	1.750	1.600	4.190	27ER...
CEL1506-27QHD	02462863	1.500	1.500	6.000	1.750	1.600	4.190	27EL...

Spare Parts, included in delivery

For holders	Cantilever clamp	Clamp key	Clamp screw	Insert shim (S)	Shim screw	Spring
CER 1006-27	CHD27	T20P-7L	L86025-T20P	VX27-1	C05012-T15P	S7616
CEL 1006-27..	CHD27	T20P-7L	L86025-T20P	VX27-1	C05012-T15P	S7616
CER/L 1256-27	CHD27	T20P-7L	L86025-T20P	VX27-1	C05012-T15P	S7616
CER 1506-27..	CHD27	T20P-7L	L86025-T20P	VX27-1	C05012-T15P	S7616
CEL 1506-27	CHD27	T20P-7L	L86025-T20P	VX27-1	C05012-T15P	S7616

Accessories

For holders	Insert shim (M)	Insert shim (S)	Insert shim (S)	Insert shim (S)	Insert shim (S)	Insert shim (S)	Insert shim (S)	Insert shim (S)	Insert shim (S)	Insert shim (S)	Insert shim (S)	Shim key
CER 1006-27	MX27-1	VX27-98.5	VX27-2	VX27-99.5	VX27-0.5	VX27-1.5	VX27-98	VX27-99	VX27-3	VX27-4	VX27-0	T15P-2
CEL 1006-27..	MX27-1	VX27-98.5	-	VX27-0.5	VX27-1.5	VX27-98	VX27-99	VX27-3	VX27-4	VX27-0	VX27-2	T15P-2
CER/L 1256-27	MX27-1	VX27-98.5	VX27-2	VX27-99.5	VX27-0.5	VX27-1.5	VX27-98	VX27-99	VX27-3	VX27-4	VX27-0	T15P-2
CER 1506-27..	MX27-1	VX27-99.5	VX27-2	-	VX27-0.5	VX27-1.5	VX27-98	VX27-99	VX27-3	VX27-4	VX27-0	T15P-2
CEL 1506-27	MX27-1	VX27-98.5	VX27-2	VX27-99.5	VX27-0.5	VX27-1.5	VX27-98	VX27-99	VX27-3	VX27-4	VX27-0	T15P-2

Toolholders, external

For S-inserts, Snap-Tap®

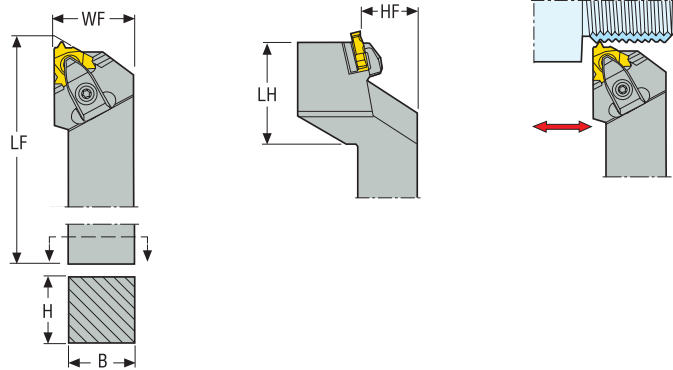

- Right-hand version shown
- For inserts program, see page(s) 125, 127, 128, 131, 132, 138, 139, 148, 149, 154, 156, 158, 160, 162, 164, 166, 168, 170, 172, 174, 176

Designation	Item number	H	B	LF	HF	WF	LH	Weight	CTWS
		mm	mm	mm	mm	mm	mm	kg	
CER2525M16CQHD	02457892	25,0	25,0	150,0	25,0	32,0	45,0	0,9	16
CER3232P16CQHD	02457893	32,0	32,0	170,0	32,0	40,0	45,0	1,5	16
CER2525M22CQHD	02457895	25,0	25,0	150,0	25,0	32,0	50,0	0,9	22
CER3232P22CQHD	02457897	32,0	32,0	170,0	32,0	40,0	50,0	1,5	22

Spare Parts, included in delivery

For holders	Cantilever clamp	Clamp key	Clamp screw	Insert shim (S)	Shim screw	Spring
..16CQHD	CHD16	T15P-7	L85020-T15P	GX16-1	CS3507-T09P	S6912
..22CQHD	CHD22	T20P-7L	L86025-T20P	NX22-1	CS4009-T15P	S7616

Accessories

For holders	Insert shim (M)	Insert shim (S)	Insert shim (S)	Insert shim (S)	Insert shim (S)	Insert shim (S)	Insert shim (S)	Shim key
..16CQHD	MX16-1	GX16-0	GX16-2	GX16-3	GX16-4	GX16-98	GX16-99	T09P-2
..22CQHD	MX22-1	NX22-0	NX22-2	NX22-3	NX22-4	NX22-98	NX22-99	T15P-2

Toolholders, external

For S-inserts, Snap-Tap®

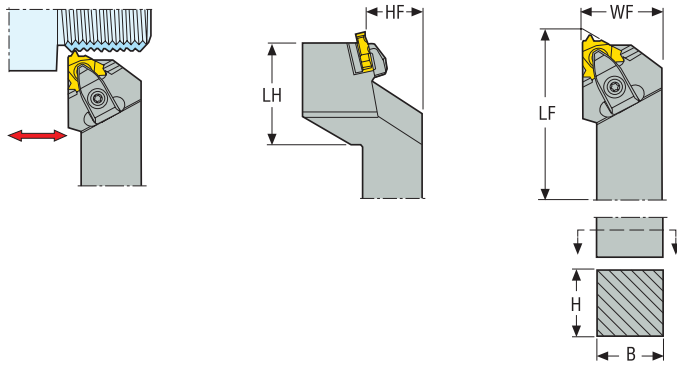

- Right-hand version shown
- For inserts program, see page(s) 125, 127, 128, 131, 132, 138, 139, 148, 149, 154, 156, 158, 160, 162, 164, 166, 168, 170, 172, 174, 176

Designation	Item number	H	B	LF	WF	LH	HF	Weight	CTWS
		<i>Inch</i>	<i>Inch</i>	<i>Inch</i>	<i>Inch</i>	<i>Inch</i>	<i>Inch</i>	lbs	
CER1006-16CQHD	02467118	1.000	1.000	6.000	1.250	2.000	1.000	1.540	16ER..
CEL1006-16CQHD	02462864	1.000	1.000	6.000	1.250	2.000	1.000	1.540	16EL..
CER1256-16CQHD	02462840	1.250	1.250	6.000	1.250	2.500	1.250	3.090	16ER..
CER1006-22CQHD	02462842	1.000	1.000	6.000	1.250	2.000	1.000	2.200	22ER..
CER1006-27CQHD	02462847	1.000	1.000	6.000	1.250	2.000	1.000	2.200	27ER..

Spare Parts, included in delivery

For holders	Cantilever clamp	Clamp key	Clamp screw	Insert shim (S)	Screw	Shim screw	Spring
CER 1006-16..	CHD16	T15P-7	L85020-T15P	GX16-1	–	CS3507-T09P	S6912
CEL 1006-16..	CHD16	T15P-7	L85020-T15P	GX16-1	–	CS3507-T09P	S6912
CER 1256-16..	CHD16	T15P-7	L85020-T15P	GX16-1	–	CS3507-T09P	S6912
..22CQHD	CHD22	T20P-7L	L86025-T20P	NX22-1	S7616	CS4009-T15P	–
..27CQHD	CHD27	T20P-7L	L86025-T20P	VX27-1	–	C05012-T15P	S7616

Accessories

For holders	Insert shim (M)	Insert shim (S)	Insert shim (S)	Insert shim (S)	Insert shim (S)	Insert shim (S)	Insert shim (S)	Insert shim (S)	Insert shim (S)	Insert shim (S)	Insert shim (S)	Insert shim (S)	Insert shim (S)	Shim key
CER 1006-16..	MX16-1	GX16-99	–	–	–	–	–	–	–	–	–	–	–	T09P-2
CEL 1006-16..	MX16-1	–	GX16-0	–	–	GX16-2	GX16-3	GX16-4	GX16-98	GX16-99	–	–	–	T09P-2
CER 1256-16..	MX16-1	–	GX16-0	–	–	GX16-2	GX16-3	GX16-4	GX16-98	GX16-99	–	–	–	T09P-2
..22CQHD	MX22-1	–	NX22-97.5	NX22-98	NX22-99	NX22-98.5	NX22-99.5	NX22-0.5	NX22-1.5	NX22-0	NX22-2	NX22-3	NX22-4	T15P-2
..27CQHD	MX27-1	–	VX27-98.5	VX27-2	–	VX27-99.5	VX27-0.5	VX27-1.5	VX27-98	VX27-99	VX27-3	VX27-4	VX27-0	T15P-2

Toolholders, external

For S-inserts, Snap-Tap®

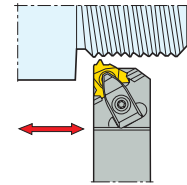
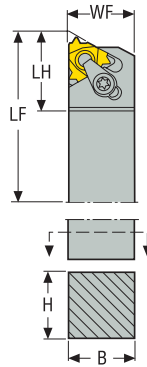

- Right-hand version shown
- For inserts program, see page(s) 125, 127, 128, 131, 132, 138, 139, 144, 146, 148, 149, 152, 154, 156, 158, 160, 162, 164, 166, 170

Designation	Item number	H	B	LF	WF	LH	Weight	CTWS
		<i>Inch</i>	<i>Inch</i>	<i>Inch</i>	<i>Inch</i>	<i>Inch</i>	lbs	
CER0505-16Q-S	02508066	0.500	0.500	5.000	0.630	0.840	0.440	16ER..
CER06255-16Q-S	02508068	0.625	0.625	5.000	0.750	0.840	0.880	16ER..

Spare Parts, included in delivery

For holders	Clamp key	Clamp kit	Insert shim (S)	Shim screw
..16Q-S	T15P-2	CSP16-T15P	GX16-1	CS3507-T09P

Accessories

For holders	Insert shim (M)	Insert shim (S)	Insert shim (S)	Insert shim (S)	Insert shim (S)	Insert shim (S)	Insert shim (S)	Shim key
..16Q-S	MX16-1	GX16-0	GX16-2	GX16-3	GX16-4	GX16-98	GX16-99	T09P-2

Thread turning

MDT

Mini-Shaft™

Thread milling

Thread tapping

Annex

Toolholders, external

For K-inserts, Snap-Tap®

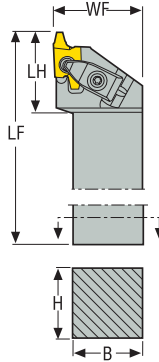
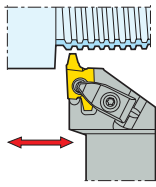

- Right-hand version shown
- For inserts program, see page(s) 160, 162, 164

Designation	Item number	H	B	LF	WF	LH	Weight	CTWS
		mm	mm	mm	mm	mm	kg	
CER2525M20QHD	02528502	25,0	25,0	150,0	32,0	34,0	0,8	20
CER3225P20QHD	02528504	32,0	25,0	170,0	32,0	34,0	1,1	20
CER3232P20QHD	02528507	32,0	32,0	170,0	40,0	34,0	1,4	20
CER4040R20HD	02853577	40,0	40,0	200,0	42,0	35,0	2,6	20
CEL2525M20QHD	02528503	25,0	25,0	150,0	32,0	34,0	0,8	20
CEL3225P20QHD	02528505	32,0	25,0	170,0	32,0	34,0	1,1	20
CEL3232P20QHD	02528508	32,0	32,0	170,0	40,0	34,0	1,4	20
CER2525M26QHD	02528509	25,0	25,0	150,0	40,0	44,0	0,9	26
CER3225P26QHD	02528512	32,0	25,0	170,0	40,0	44,0	1,2	26
CER3232P26QHD	02528516	32,0	32,0	170,0	40,0	44,0	1,4	26
CER4040R26HD	02853578	40,0	40,0	200,0	42,0	45,0	2,5	26
CEL2525M26QHD	02528511	25,0	25,0	150,0	40,0	44,0	0,9	26
CEL3225P26QHD	02528513	32,0	25,0	170,0	40,0	44,0	1,2	26
CEL3232P26QHD	02528517	32,0	32,0	170,0	40,0	44,0	1,4	26

Spare Parts, included in delivery

For holders	Cantilever clamp	Clamp key	Clamp screw	Insert shim (K)	Shim screw	Spring
..20	CHD22	T20P-7	L86025-T20P	KX20-2	CS4009-T15P	S7616
...20	CHD22	T20P-7	L86025-T20P	KX20-2	CS4009-T15P	S7616
..26	CHD27	T20P-7	L86025-T20P	KX26-2	C05012-T15P	S7616
...26	CHD27	T20P-7	L86025-T20P	KX26-2	C05012-T15P	S7616

Accessories

For holders	Insert shim (K)	Insert shim (K)	Insert shim (K)	Insert shim (K)	Insert shim (K)	Insert shim (K)	Shim key
..20	KX20-99	KX20-0	KX20-1	KX20-3	KX20-4	KX20-5	T15P-2
...20	KX20-99	KX20-0	KX20-1	KX20-3	KX20-4	KX20-5	T15P-2
..26	KX26-99	KX26-0	KX26-1	KX26-3	KX26-4	KX26-5	T15P-2
...26	KX26-99	KX26-0	KX26-1	KX26-3	KX26-4	KX26-5	T15P-2

Toolholders, internal

For S-inserts, Snap-Tap®

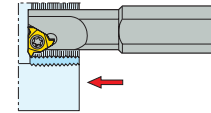
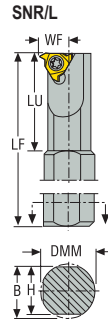
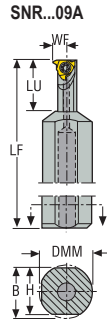

- Right-hand version shown
- For inserts program, see page(s) 126, 129, 130, 134, 135, 136, 141, 142, 145, 147, 150, 151, 153, 155, 157, 159, 161, 163, 165, 167, 169, 171, 173, 175, 177

Designation	Item number	H	B	LF	WF	LU	DCINN	DCINN2	Weight	CTWS
		mm	mm	mm	mm	mm	mm	mm	kg	
SNR0020L09A	75069222	18,0	19,0	140,0	5,1	20,0	10,2	–	0,3	09
SNR0010H11	75029184	–	9,5	100,0	7,5	–	13,0	11,0	0,1	11
SNR0010K11	75025251	14,0	15,5	125,0	6,5	30,0	12,0	11,0	0,2	11
SNR0013L11	75025249	14,0	15,5	140,0	8,0	32,0	15,0	13,0	0,2	11
SNL0010H11	75025415	–	9,5	100,0	7,5	–	13,0	11,0	0,1	11
SNL0010K11	75025250	14,0	15,5	125,0	6,5	30,0	12,0	11,0	0,2	11
SNL0013L11	75025248	14,0	15,5	140,0	8,0	32,0	15,0	13,0	0,2	11
SNR0016M16	75025244	14,0	15,5	150,0	10,3	40,0	19,0	16,0	0,3	16
SNL0016M16	75025243	14,0	15,5	150,0	10,3	40,0	19,0	16,0	0,3	16
SNR0020Q22	75025414	18,0	19,0	180,0	13,0	45,0	24,0	22,0	0,4	22
SNL0020Q22	75025416	18,0	19,0	180,0	13,0	45,0	24,0	22,0	0,4	22

Spare Parts, included in delivery

For holders	Insert key	Insert screw
...09A	 T07P-2	 C02205-T07P
...11	T07P-2	C02506-T07P
...16	T15P-2	C03508-T15P
...22	T15P-2	C04011-T15P

DCINN2, modified. Please see page 36

Toolholders, internal

For S-inserts, Snap-Tap®

CNR/L...AHD

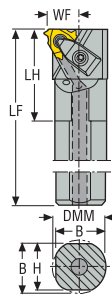

CNR/L...APIHD

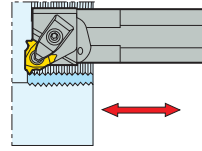
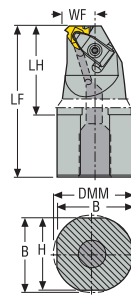

- Right-hand version shown
- For inserts program, see page(s) 126, 129, 130, 134, 135, 136, 141, 142, 145, 147, 150, 151, 153, 155, 157, 159, 161, 163, 165, 167, 169, 171, 173, 175, 177

Designation	Item number	H	B	LF	WF	LH	DMM	DCINN	DCINN2	Weight	CTWS
		mm	mm	mm	mm	mm	mm	mm	mm	kg	
CNR0020P16AHD	02555888	18,0	19,0	170,0	13,8	41,0	20,0	24,0	–	0,4	16..
CNR0025R16AHD	02555891	23,0	24,0	200,0	16,3	40,0	25,0	29,0	26,0	0,8	16..
CNR0032S16AHD	02555895	30,0	31,0	250,0	19,8	47,0	32,0	36,0	32,0	1,4	16..
CNR0040T16AHD	02555900	37,0	38,5	300,0	23,8	47,0	40,0	44,0	40,0	2,6	16..
CNR0050U16AHD	02555906	47,0	48,5	350,0	28,8	45,0	50,0	54,0	50,0	4,8	16..
CNL0020P16AHD	02555907	18,0	19,0	171,0	11,78	41,0	20,0	24,0	–	0,4	16..
CNL0025R16AHD	02555908	23,0	24,0	171,0	11,78	40,0	25,0	29,0	26,0	0,7	16..
CNL0032S16AHD	02555909	30,0	31,0	250,0	19,8	47,0	32,0	36,0	32,0	1,4	16..
CNL0040T16AHD	02555910	37,0	38,5	300,0	23,8	47,0	40,0	44,0	40,0	2,6	16..
CNR0025R22AHD	02555913	23,0	24,0	200,0	17,8	45,0	25,0	30,0	–	0,7	22..
CNR0032S22AHD	02555919	30,0	31,0	250,0	21,3	46,0	32,0	38,0	32,0	1,5	22..
CNR0040T22AHD	02556097	37,0	38,5	300,0	25,3	53,0	40,0	46,0	40,0	2,6	22..
CNR0050U22AHD	02556101	47,0	48,5	350,0	30,3	51,0	50,0	56,0	50,0	4,8	22..
CNR0063V22AHD	02556102	60,0	61,5	400,0	36,8	56,0	63,0	69,0	63,0	9,0	22..
CNL0025R22AHD	02556104	23,0	24,0	200,0	17,8	45,0	25,0	30,0	–	0,7	22..
CNL0032S22AHD	02556106	30,0	31,0	250,0	21,3	46,0	32,0	38,0	32,0	1,4	22..
CNL0040T22AHD	02556107	37,0	38,5	300,0	25,3	53,0	40,0	46,0	40,0	2,6	22..
CNL0050U22AHD	02556108	47,0	48,5	350,0	30,3	51,0	50,0	56,0	50,0	4,8	22..
CNR0050T22APIHD	02556244	47,0	48,5	300,0	20,5	114,0	50,0	49,0	–	3,7	22..
CNR0063T22APIHD	02817098	60,0	61,5	300,0	22,6	119,0	63,0	50,5	–	5,4	22..
CNL0063T22APIHD	02817100	60,0	61,5	300,0	22,6	119,0	63,0	50,5	–	5,4	22..
CNR0040T27AHD	02556109	37,0	38,5	300,0	26,8	62,0	40,0	48,0	44,0	2,6	27..
CNR0050U27AHD	02556110	47,0	48,5	350,0	31,8	61,0	50,0	58,0	50,0	4,8	27..
CNR0063V27AHD	02556120	60,0	61,5	400,0	38,3	70,0	63,0	70,0	63,0	8,9	27..
CNL0040T27AHD	02556122	37,0	38,5	300,0	26,8	62,0	40,0	48,0	44,0	2,6	27..
CNL0050U27AHD	02556130	47,0	48,5	350,0	31,8	61,0	50,0	58,0	50,0	4,8	27..
CNR0063T27APIHD	02817102	60,0	61,5	300,0	23,1	119,0	63,0	50,5	–	5,6	27..
CNL0063T27APIHD	02817105	60,0	61,5	300,0	23,1	119,0	63,0	50,5	–	5,4	27..

Spare Parts, included in delivery

For holders	Cantilever clamp	Clamp key	Clamp kit	Clamp screw	Insert shim (S)	Shim screw	Spring
..P, ..R16AHD	-	T15P-2	CSP16HD-T15P	-	GX16-1	CS3507-T09P	-
..S, ..T, ..U16AHD	CHD16	T15P-2	-	L85020-T15P	GX16-1	CS3507-T09P	S6912
...R22, ...S22	-	T15P-2	CSP22HD-T15P	-	NX22-1	CS4009-T15P	-
...T22, ...U22, ...V22	CHD22	T20P-7L	-	L86025-T20P	NX22-1	CS4009-T15P	S7616
..27...	CHD27	T20P-7L	-	L86025-T20P	VX27-1	C05012-T15P	S7616

Accessories

For holders	Insert shim (M)	Insert shim (S)	Insert shim (S)	Insert shim (S)	Insert shim (S)	Insert shim (S)	Insert shim (S)	Insert shim (S)	Insert shim (S)	Insert shim (S)	Insert shim (S)	Insert shim (S)	Shim key
..P, ..R16AHD	MX16-1	GX16-0	-	-	GX16-2	GX16-3	GX16-4	GX16-98	GX16-99	-	-	-	T09P-2
..S, ..T, ..U16AHD	MX16-1	GX16-0	-	-	GX16-2	GX16-3	GX16-4	GX16-98	GX16-99	-	-	-	T09P-2
...R22, ...S22	MX22-1	NX22-97.5	NX22-98	NX22-99	NX22-98.5	NX22-99.5	NX22-0.5	NX22-1.5	NX22-0	NX22-2	NX22-3	NX22-4	-
...T22, ...U22, ...V22	MX22-1	NX22-97.5	NX22-98	NX22-99	NX22-98.5	NX22-99.5	NX22-0.5	NX22-1.5	NX22-0	NX22-2	NX22-3	NX22-4	T15P-2
..27...	MX27-1	VX27-98.5	VX27-2	-	VX27-99.5	VX27-0.5	VX27-1.5	VX27-98	VX27-99	VX27-3	VX27-4	VX27-0	T15P-2

DCINN2, modified. Please see page 36

Thread turning

MDT

Mini-Shaft™

Thread milling

Thread tapping

Annex

Toolholders, internal

For S-inserts, Snap-Tap®

CNR/L...AHD

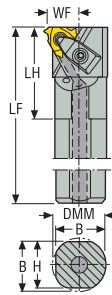

CNR/L...APIHD

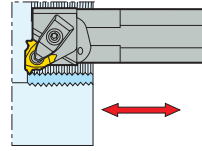
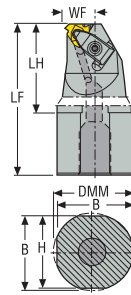

- Right-hand version shown
- For inserts program, see page(s) 126, 129, 130, 134, 135, 136, 141, 142, 145, 147, 150, 151, 153, 155, 157, 159, 161, 163, 165, 167, 169, 171, 173, 175, 177

Designation	Item number	DMM	H	B	LF	WF	LH	DCINN	DCINN2	Weight	CTWS
		<i>Inch</i>	<i>Inch</i>	<i>Inch</i>	<i>Inch</i>	<i>Inch</i>	<i>Inch</i>	<i>Inch</i>	<i>Inch</i>	lbs	
CNR000757-16AHD	02562574	0.750	0.650	0.707	6.693	0.520	1.181	0.950	0.800	0.880	16..
CNL000757-16AHD	02562790	0.750	0.650	0.707	6.693	0.520	1.181	0.950	0.800	0.880	16..
CNR001008-16AHD	02562785	1.000	0.902	0.957	7.874	0.650	2.126	1.150	1.000	1.540	16..
CNL001008-16AHD	02562791	1.000	0.902	0.957	7.874	0.650	2.126	1.150	1.000	1.540	16..
CNR0012510-16AHD	02562786	1.250	1.150	1.209	9.843	0.780	1.811	1.400	1.200	3.090	16..
CNL0012510-16AHD	02562792	1.250	1.150	1.209	9.843	0.780	1.811	1.400	1.200	3.090	16..
CNR0015012-16AHD	02562787	1.500	1.339	1.427	11.811	0.898	1.811	1.700	1.500	5.070	16..
CNL0015012-16AHD	02562793	1.500	1.339	1.427	11.811	0.898	1.811	1.700	1.500	5.070	16..
CNR0017514-16AHD	02562788	1.750	1.591	1.677	13.780	1.028	2.165	2.000	1.800	8.160	16..
CNL0017514-16AHD	02562794	1.750	1.591	1.677	13.780	1.028	2.165	2.000	1.800	8.160	16..
CNR0020014-16AHD	02562789	2.000	1.843	1.929	13.780	1.150	2.244	2.200	2.000	10.800	16..
CNL0020014-16AHD	02562795	2.000	1.843	1.929	13.780	1.150	2.244	2.200	2.000	10.800	16..

Spare Parts, included in delivery

For holders	Cantilever clamp	Clamp key	Clamp kit	Clamp screw	Insert shim (S)	Shim screw	Spring
CNR/L..0757..1008..	-	T15P-2	CSP16HD-T15P	-	GX16-1	CS3507-T09P	-
CNR..2510..	CHD16	T15P-7	-	L85020-T15P	GX16-1	CS3507-T09P	S6912
CNL..2510..	CHD16	T15P-2	-	L85020-T15P	GX16-1	CS3507-T09P	S6912
CNR..5012..	CHD16	T15P-2	-	L85020-T15P	GX16-1	CS3507-T09P	S6912
CNL..5012..	CHD16	T15P-2	-	L85020-T15P	GX16-1	CS3507-T09P	S6912
CNR..7514..	CHD16	-	-	L85020-T15P	GX16-1	CS3507-T09P	S6912
CNL..7514..	CHD16	T15P-2	-	L85020-T15P	GX16-1	CS3507-T09P	S6912
CNR/L..0014..	CHD16	T15P-2	-	L85020-T15P	GX16-1	CS3507-T09P	S6912

Accessories

For holders	Insert shim (M)	Insert shim (S)	Insert shim (S)	Insert shim (S)	Insert shim (S)	Insert shim (S)	Insert shim (S)	Shim key
CNR/L..0757..1008..	MX16-1	GX16-0	GX16-2	GX16-3	GX16-4	GX16-98	GX16-99	T09P-2
CNR..2510..	MX16-1	GX16-0	GX16-2	GX16-3	GX16-4	GX16-98	GX16-99	T09P-2
CNL..2510..	MX16-1	GX16-0	GX16-2	GX16-3	GX16-4	GX16-98	GX16-99	T09P-2
CNR..5012..	MX16-1	GX16-0	GX16-2	GX16-3	GX16-4	GX16-98	GX16-99	T09P-2
CNL..5012..	MX16-1	GX16-0	GX16-2	GX16-4	GX16-98	GX16-99	-	T09P-2
CNR..7514..	MX16-1	GX16-0	GX16-2	GX16-3	GX16-4	GX16-98	GX16-99	T09P-2
CNL..7514..	MX16-1	GX16-0	GX16-2	GX16-3	GX16-4	GX16-98	GX16-99	T09P-2
CNR/L..0014..	MX16-1	GX16-0	GX16-2	GX16-3	GX16-4	GX16-98	GX16-99	T09P-2

DCINN2, modified. Please see page 36

Thread turning

MDT

Mini-Shaft™

Thread milling

Thread tapping

Annex

Toolholders, internal

For S-inserts, Snap-Tap®

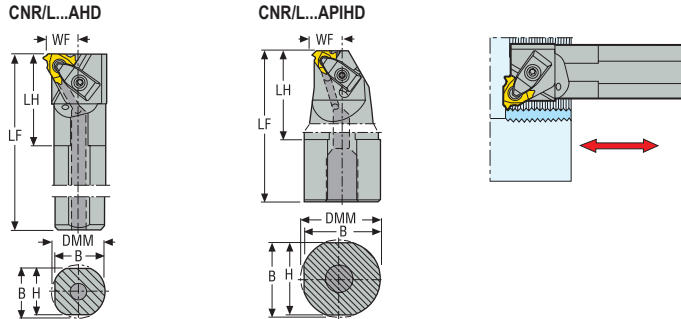

- Right-hand version shown
- For inserts program, see page(s) 126, 129, 130, 134, 135, 136, 141, 142, 145, 147, 150, 151, 153, 155, 157, 159, 161, 163, 165, 167, 169, 171, 173, 175, 177

Designation	Item number	DMM	H	B	LF	WF	LH	DCINN	DCINN2	Weight	CTWS
		<i>Inch</i>	<i>Inch</i>	<i>Inch</i>	<i>Inch</i>	<i>Inch</i>	<i>Inch</i>	<i>Inch</i>	<i>Inch</i>	lbs	
CNR001008-22AHD	02562797	1.000	0.902	0.957	7.917	0.709	1.736	1.200	1.000	2.870	22..
CNL001008-22AHD	02562803	1.000	0.902	0.957	7.917	0.709	1.736	1.200	1.000	1.760	22..
CNR0012510-22AHD	02562798	1.250	1.150	1.209	9.843	0.839	2.126	1.500	1.200	3.090	22..
CNL0012510-22AHD	02562804	1.250	1.150	1.209	9.843	0.839	2.126	1.500	1.200	3.090	22..
CNR0015012-22AHD	02562799	1.500	1.339	1.427	11.811	0.969	2.126	1.800	1.800	5.070	22..
CNL0015012-22AHD	02562805	1.500	1.339	1.427	11.811	1.183	2.126	1.800	1.800	5.290	22..
CNR0017514-22AHD	02562800	1.750	1.591	1.677	13.780	1.091	2.126	2.100	1.800	8.160	22..
CNL0017514-22AHD	02562806	1.750	1.591	1.677	13.780	1.091	2.126	2.100	1.800	8.380	22..
CNR0020014-22AHD	02562801	2.000	1.843	1.929	13.780	1.209	2.323	2.300	2.000	11.020	22..
CNL0020014-22AHD	02562807	2.000	1.843	1.929	13.780	1.209	2.323	2.300	2.000	11.020	22..
CNR0025016-22AHD	02562802	2.500	2.343	2.429	15.748	1.457	2.402	2.800	2.500	20.280	22..
CNL0025016-22AHD	02562808	2.500	2.343	2.429	15.748	1.457	2.402	2.800	2.500	20.060	22..
CNR00200T22APIHD	02562815	2.000	1.843	1.929	12.000	0.880	5.000	1.600	-	8.380	22..
CNR00250T22APIHD	02562816	2.500	2.343	2.429	12.000	0.880	5.000	1.600	-	11.900	22..

Spare Parts, included in delivery

For holders	Cantilever clamp	Clamp key	Clamp kit	Clamp screw	Insert shim (S)	Shim/clamp key	Shim screw	Spring
CNR..1008..2510..	-	-	CSP22HD-T15P	-	NX22-1	T15P-2	CS4009-T15P	-
CNL..1008..2510..	-	T15P-2	CSP22HD-T15P	-	NX22-1	-	CS4009-T15P	-
CNR/L..5012..5016..	CHD22	T20P-7L	-	L86025-T20P	NX22-1	-	CS4009-T15P	S7616
CNR..200..250T..	CHD22	T20P-7L	-	L86025-T20P	NX22-1	-	CS4009-T15P	S7616

Accessories

For holders	Insert shim (M)	Insert shim (S)	Insert shim (S)	Insert shim (S)	Insert shim (S)	Insert shim (S)	Insert shim (S)	Insert shim (S)	Insert shim (S)	Insert shim (S)	Insert shim (S)	Insert shim (S)	Shim key
CNR..1008..2510..	MX22-1	NX22-97.5	NX22-98	NX22-99	NX22-98.5	NX22-99.5	NX22-0.5	NX22-1.5	NX22-0	NX22-2	NX22-3	NX22-4	-
CNL..1008..2510..	MX22-1	NX22-97.5	NX22-98	NX22-99	NX22-98.5	NX22-99.5	NX22-0.5	NX22-1.5	NX22-0	NX22-2	NX22-3	NX22-4	-
CNR/L..5012..5016..	MX22-1	NX22-97.5	NX22-98	NX22-99	NX22-98.5	NX22-99.5	NX22-0.5	NX22-1.5	NX22-0	NX22-2	NX22-3	NX22-4	T15P-2
CNR..200..250T..	MX22-1	NX22-97.5	NX22-98	NX22-99	NX22-98.5	NX22-99.5	NX22-0.5	NX22-1.5	NX22-0	NX22-2	NX22-3	NX22-4	T15P-2

Toolholders, internal

For S-inserts, Snap-Tap®

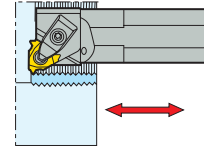
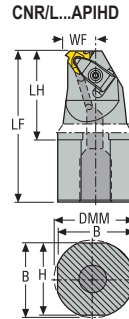
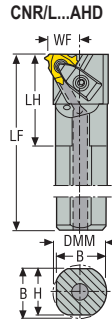

- Right-hand version shown
- For inserts program, see page(s) 126, 129, 130, 134, 135, 136, 141, 142, 145, 147, 150, 151, 153, 155, 157, 159, 161, 163, 165, 167, 169, 171, 173, 175, 177

Designation	Item number	DMM	H	B	LF	WF	LH	DCINN	DCINN2	Weight	CTWS
		<i>Inch</i>	<i>Inch</i>	<i>Inch</i>	<i>Inch</i>	<i>Inch</i>	<i>Inch</i>	<i>Inch</i>	<i>Inch</i>	<i>lbs</i>	
CNR0015012-27AHD	02562809	1.500	1.339	1.427	11.811	1.020	2.441	1.900	1.500	5.290	27..
CNL0015012-27AHD	02562812	1.500	1.339	1.427	11.811	1.020	2.441	1.900	1.500	5.290	27..
CNR0017514-27AHD	02562810	1.750	1.591	1.677	13.780	1.150	2.402	2.200	1.800	8.380	27..
CNL0017514-27AHD	02562813	1.750	1.591	1.677	13.780	1.150	2.402	2.200	1.800	8.380	27..
CNR0020014-27HD	02790281	2.000	1.843	1.929	13.780	1.346	2.283	2.362	2.000	11.460	27..
CNR0025016-27AHD	02562811	2.500	2.343	2.429	15.748	1.520	2.756	2.900	2.500	20.060	27..
CNL0025016-27AHD	02562814	2.500	2.343	2.429	15.748	1.520	2.756	2.900	2.500	20.280	27..
CNR00200T27APIHD	02562819	2.000	1.843	1.929	12.000	0.900	5.000	1.600	1.600	8.380	27...
CNR00250T27APIHD	02562820	2.500	2.343	2.429	12.000	0.900	5.000	1.600	1.600	12.130	27...

Spare Parts, included in delivery

For holders	Cantilever clamp	Clamp key	Clamp screw	Insert shim (S)	Shim screw	Spring
CNR/L...15012-25016..						
CNR...200...250T..	CHD27	T20P-7	L86025-T20P	VX27-1	C05012-T15P	S7616

Accessories

For holders	Insert shim (M)	Insert shim (S)	Insert shim (S)	Insert shim (S)	Insert shim (S)	Insert shim (S)	Insert shim (S)	Insert shim (S)	Insert shim (S)	Insert shim (S)	Insert shim (S)	Shim key
CNR/L...15012-25016..												
CNR...200...250T..	MX27-1	VX27-98.5	VX27-2	VX27-99.5	VX27-0.5	VX27-1.5	VX27-98	VX27-99	VX27-3	VX27-4	VX27-0	T15P-2

DCINN2, modified. Please see page 36

Toolholders, internal

For S-inserts, Snap-Tap®

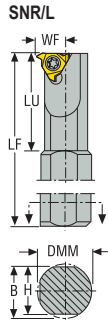
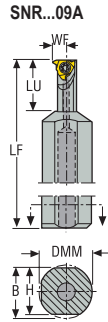

- Right-hand version shown
- For inserts program, see page(s) 126, 129, 130, 134, 135, 136, 141, 142, 145, 147, 150, 151, 153, 155, 157, 159, 161, 163, 165, 167, 169, 171, 173, 175, 177

Designation	Item number	DMM	H	B	LF	WF	LU	Weight	CTWS
		<i>Inch</i>	<i>Inch</i>	<i>Inch</i>	<i>Inch</i>	<i>Inch</i>	<i>Inch</i>	<i>lbs</i>	
SNR000750-55-09A	00086856	0.750	0.691	0.707	5.500	0.201	–	0.660	09NR..
SNR000375-40-11	00072380	0.375	0.336	0.350	4.000	0.285	–	0.220	11NR..
SNL00037540-11	00072403	0.375	0.336	0.350	4.000	0.285	–	0.220	11NL..
SNR00062555-11	00072332	0.625	0.441	0.470	5.500	0.315	1.250	0.660	11NR..
SNL00062555-11	00072405	0.625	0.441	0.470	5.500	0.315	–	0.660	11NL..
SNR000375-60-11H	00072376	0.375	0.336	0.350	6.000	0.285	–	0.440	11NR..
SNR000625-60-16	00072374	0.625	0.566	0.587	6.000	0.406	–	0.660	16NR..
SNL00062560-16	00072407	0.625	0.566	0.587	6.000	0.406	–	0.660	16NL..
SNR000625-80-16H	00072330	0.625	0.566	0.587	8.000	0.406	–	1.540	16NR..
SNR00075-70-22	00072314	0.750	0.691	0.707	7.000	0.492	–	1.100	22NR..
SNL0007570-22	00072411	0.750	0.691	0.707	7.000	0.492	–	0.880	22NL..
SNR000750-10-22H	00072370	0.750	0.691	0.707	10.000	0.492	–	2.650	22NR..

Spare Parts, included in delivery

For holders	Insert key	Insert screw
..09	T07P-2	C02205-T07P
..11	T07P-2	C02506-T07P
..16	T15P-2	C03508-T15P
..22	T15P-2	C04011-T15P

Toolholders, internal

For K-inserts, Snap-Tap®

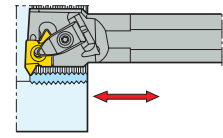
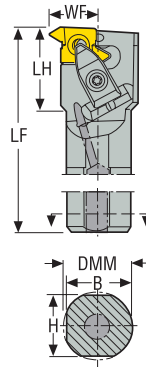

- Right-hand version shown
- For inserts program, see page(s) 126, 129, 130, 161, 163, 165

Designation	Item number	H	B	LF	WF	LH	DMM	DCINN	DCINN2	Weight	CTWS
		mm	mm	mm	mm	mm	mm	mm	mm	kg	
CNR0025R20AHD	02556131	23,0	24,0	200,0	20,5	50,0	25,0	38,0	–	0,7	20
CNR0032S20AHD	02556132	30,0	31,0	250,0	24,0	50,0	32,0	44,0	38,0	1,5	20
CNR0040T20AHD	02556133	37,0	38,5	300,0	28,0	50,0	40,0	51,0	40,0	2,6	20
CNL0025R20AHD	02556134	23,0	24,0	200,0	20,5	50,0	25,0	38,0	–	0,7	20
CNL0032S20AHD	02556135	30,0	31,0	250,0	24,0	50,0	32,0	44,0	38,0	1,4	20
CNR0032S26AHD	02556136	30,0	31,0	250,0	27,0	61,0	32,0	50,0	50,0	1,5	26
CNR0040T26AHD	02556137	37,0	38,5	300,0	31,0	60,0	40,0	55,0	50,0	2,6	26
CNR0050U26AHD	02556138	47,0	48,5	350,0	36,0	62,0	50,0	65,0	–	4,8	26
CNR0063V26AHD	02556139	60,0	61,5	400,0	42,5	64,0	63,0	80,0	63,0	8,9	26
CNL0040T26AHD	02556140	37,0	38,5	300,0	31,0	60,0	40,0	55,0	50,0	2,6	26

Spare Parts, included in delivery

For holders	Cantilever clamp	Clamp key	Clamp screw	Insert shim (K)	Shim screw	Spring
..20	CHD22	T20P-7L	L86025-T20P	KX20-2	CS4009-T15P	S7616
..26	CHD27	T20P-7L	L86025-T20P	KX26-2	C05012-T15P	S7616

Accessories

For holders	Insert shim (K)	Insert shim (K)	Insert shim (K)	Insert shim (K)	Insert shim (K)	Insert shim (K)	Shim key
..20	KX20-99	KX20-0	KX20-1	KX20-3	KX20-4	KX20-5	T15P-2
..26	KX26-99	KX26-0	KX26-1	KX26-3	KX26-4	KX26-5	T15P-2

DCINN2, modified. Please see page 36

Seco-Capto™ – Toolholders, external



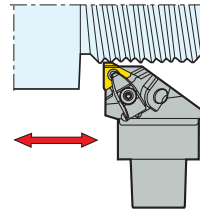
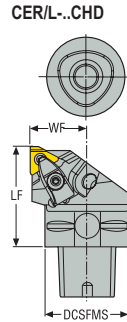
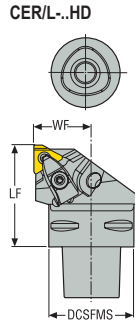











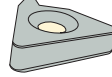





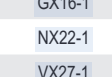





For S-inserts, Snap-Tap®







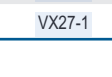







































- Right-hand version shown
- For inserts program, see page(s) 125, 127, 128, 131, 132, 138, 139, 144, 146, 148, 149, 152, 154, 156, 158, 160, 162, 164, 166, 168, 170, 172, 174, 176

Designation	Item number	DCSFMS		LF		WF		Weight	CTWS	
		mm	Inch	mm	Inch	mm	Inch			kg
C4-CER-27050-16HD	02484547	40,0	1.575	50,0	1.063	27,0	1.063	0,5	1.100	16..
C4-CEL-27050-16HD	02484655	40,0	1.575	50,0	1.063	27,0	1.063	0,5	1.100	16..
C4-CER-27050-22HD	02484649	40,0	1.575	50,0	1.063	27,0	1.063	0,5	1.100	22..
C4-CEL-27050-22HD	02484656	40,0	1.575	50,0	1.063	27,0	1.063	0,5	1.100	22..
C5-CER-35060-16HD	02484650	50,0	1.969	60,0	1.378	35,0	1.378	0,8	1.760	16..
C5-CEL-35060-16HD	02484657	50,0	1.969	60,0	1.378	35,0	1.378	0,8	1.760	16..
C5-CER-35060-22HD	02484652	50,0	1.969	60,0	1.378	35,0	1.378	0,8	1.760	22..
C5-CEL-35060-22HD	02484658	50,0	1.969	60,0	1.378	35,0	1.378	0,8	1.760	22..
C5-CER-35060-27HD	02844418	50,0	1.969	60,0	1.378	35,0	1.378	0,8	1.760	27..
C5-CEL-35060-27HD	02844420	50,0	1.969	60,0	1.378	35,0	1.378	0,8	1.760	27..
C6-CER-45065-16HD	02484653	63,0	2.480	65,0	1.772	45,0	1.772	1,3	2.870	16..
C6-CEL-45065-16HD	02484661	63,0	2.480	65,0	1.772	45,0	1.772	1,3	2.870	16..
C6-CER-45065-22HD	02484654	63,0	2.480	65,0	1.772	45,0	1.772	1,3	2.870	22..
C6-CEL-45065-22HD	02484663	63,0	2.480	65,0	1.772	45,0	1.772	1,3	2.870	22..
C6-CER-45065-27HD	02484848	63,0	2.480	65,0	1.772	45,0	1.772	1,3	2.870	27..
C6-CEL-45065-27HD	02484860	63,0	2.480	65,0	1.772	45,0	1.772	1,3	2.870	27..

Spare Parts, included in delivery

For holders	Cantilever clamp	Clamp key	Clamp screw	Coolant nozzle	Insert shim (S)	Shim screw	Spring
...16HD	 CHD16	 T15P-7	 L85020-T15P	 CN16	 GX16-1	 CS3507-T09P	 S6912
...22HD	 CHD22	 T20P-7L	 L86025-T20P	 CN16	 NX22-1	 CS4009-T15P	 S7616
...27HD	 CHD27	 T20P-7L	 L86025-T20P	 CN16	 VX27-1	 C05012-T15P	 S7616
...45065-27HD	 CHD27	 T20P-7L	 L86025-T20P	 CN16	 VX27-1	 C05012-T15P	 S7616

Accessories

For holders	Insert shim (M)	Insert shim (S)	Insert shim (S)	Insert shim (S)	Insert shim (S)	Insert shim (S)	Insert shim (S)	Insert shim (S)	Insert shim (S)	Insert shim (S)	Insert shim (S)	Insert shim (S)	Shim key
...16HD	 MX16-1	 GX16-0	-	-	 GX16-2	 GX16-3	 GX16-4	 GX16-98	 GX16-99	-	-	-	 T09P-2
...22HD	 MX22-1	 NX22-97.5	 NX22-98	 NX22-99	 NX22-98.5	 NX22-99.5	 NX22-0.5	 NX22-1.5	 NX22-0	 NX22-2	 NX22-3	 NX22-4	 T15P-2
...27HD	 MX27-1	 VX27-98.5	 VX27-2	-	 VX27-99.5	 VX27-0.5	 VX27-1.5	 VX27-98	 VX27-99	 VX27-3	 VX27-4	 VX27-0	 T15P-7
...45065-27HD	 MX27-1	 VX27-98.5	 VX27-2	-	 VX27-99.5	 VX27-0.5	 VX27-1.5	 VX27-98	 VX27-99	 VX27-3	 VX27-4	 VX27-0	 T15P-2

Thread turning

MDT

Mini-Shaft™

Thread milling

Thread tapping

Annex

Seco-Capto™ – Toolholders, external

For S-inserts, Snap-Tap®

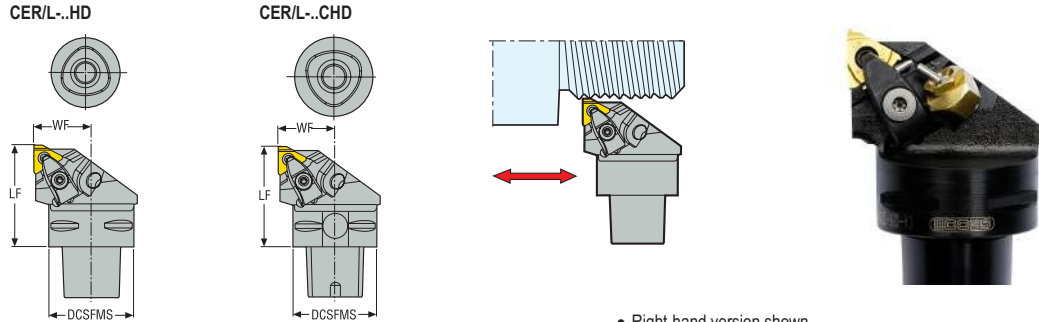































- Right-hand version shown
- For inserts program, see page(s) 125, 127, 128, 131, 132, 138, 139, 144, 146, 148, 149, 152, 154, 156, 158, 160, 162, 164, 166

Designation	Item number	DCSFMS		LF		WF		Weight	CTWS	
		mm	Inch	mm	Inch	mm	Inch			kg
C4-CER-27050-16CHD	02484668	40,0	1.575	50,0	1.063	27,0	1.063	0,5	1.100	16
C4-CEL-27050-16CHD	02484795	40,0	1.575	50,0	1.063	27,0	1.063	0,5	1.100	16
C5-CER-35060-16CHD	02484784	50,0	1.969	60,0	1.378	35,0	1.378	0,8	1.760	16
C5-CEL-35060-16CHD	02484802	50,0	1.969	60,0	1.378	35,0	1.378	0,8	1.760	16
C6-CER-45065-16CHD	02484786	63,0	2.480	65,0	1.772	45,0	1.772	1,3	2.870	16
C6-CEL-45065-16CHD	02484843	63,0	2.480	65,0	1.772	45,0	1.772	1,3	2.870	16
C4-CER-27050-22CHD	02484775	40,0	1.575	50,0	1.063	27,0	1.063	0,5	1.100	22
C4-CEL-27050-22CHD	02484800	40,0	1.575	50,0	1.063	27,0	1.063	0,5	1.100	22
C5-CER-35060-22CHD	02484785	50,0	1.969	60,0	1.378	35,0	1.378	0,8	1.760	22
C5-CEL-35060-22CHD	02484804	50,0	1.969	60,0	1.378	35,0	1.378	0,8	1.760	22
C6-CER-45065-22CHD	02484790	63,0	2.480	65,0	1.772	45,0	1.772	1,3	2.870	22
C6-CEL-45065-22CHD	02484845	63,0	2.480	65,0	1.772	45,0	1.772	1,3	2.870	22
C6-CER-45065-27CHD	02484854	63,0	2.480	65,0	1.772	45,0	1.772	1,3	2.870	27
C6-CEL-45065-27CHD	02484862	63,0	2.480	65,0	1.772	45,0	1.772	1,3	2.870	27

Spare Parts, included in delivery

For holders	Cantilever clamp	Clamp key	Clamp screw	Coolant nozzle	Insert shim (S)	Shim screw	Spring
...16CHD	CHD16	T15P-7	L85020-T15P	CN16	GX16-1	CS3507-T09P	S6912
...22CHD	CHD22	T20P-7L	L86025-T20P	CN16	NX22-1	CS4009-T15P	S7616
...27CHD	CHD27	T20P-7L	L86025-T20P	CN16	VX27-1	C05012-T15P	S7616

Accessories

For holders	Insert shim (M)	Insert shim (S)	Insert shim (S)	Insert shim (S)	Insert shim (S)	Insert shim (S)	Insert shim (S)	Insert shim (S)	Insert shim (S)	Insert shim (S)	Insert shim (S)	Insert shim (S)	Shim key
...16CHD			–	–						–	–	–	T09P-2
...22CHD													T15P-2
...27CHD				–									T15P-2

Thread turning

MDT

Mini-Shaft™

Thread milling

Thread tapping

Annex

Seco-Capto™ – Toolholders, external

For K-inserts, Snap-Tap®

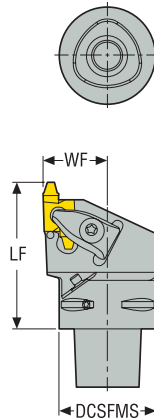
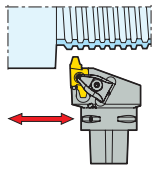

- Right-hand version shown
- For inserts program, see page(s) 125, 127, 128, 160, 162, 164

Designation	Item number	DCSFMS		LF		WF		Weight	CTWS	
		mm	Inch	mm	Inch	mm	Inch			kg
C4-CER-27060-20HD	02853589	40,0	1.575	60,0	1.063	27,0	1.063	0,6	1.320	20..
C4-CER-27065-26HD	02853590	40,0	1.575	65,0	1.063	27,0	1.063	0,6	1.320	26..
C5-CER-35060-20HD	02853591	50,0	1.969	60,0	1.378	35,0	1.378	0,8	1.760	20..
C5-CER-35065-26HD	02790776	50,0	1.969	65,0	1.378	35,0	1.378	0,8	1.760	26..
C6-CER-45065-20HD	02853587	63,0	2.480	65,0	1.772	45,0	1.772	1,3	2.870	20..
C6-CER-45070-26HD	02853595	63,0	2.480	70,0	1.772	45,0	1.772	1,5	3.310	26..

Spare Parts, included in delivery

For holders	Cantilever clamp	Clamp key	Clamp screw	Coolant nozzle	Insert shim (K)	Shim screw	Spring
...20HD	CHD22	T20P-7	L86025-T20P	CN6	KX20-2	CS4009-T15P	S7616
...26HD	CHD27	T20P-7	L86025-T20P	CN6	KX26-2	C05012-T15P	S7616

Accessories

For holders	Insert shim (K)	Insert shim (K)	Insert shim (K)	Insert shim (K)	Insert shim (K)	Insert shim (K)	Shim key
...20HD	KX20-99	KX20-0	KX20-1	KX20-3	KX20-4	KX20-5	T15P-2
...26HD	KX26-99	KX26-0	KX26-1	KX26-3	KX26-4	KX26-5	T15P-2

Seco-Capto™ – Toolholders, internal

For S-inserts, Snap-Tap®

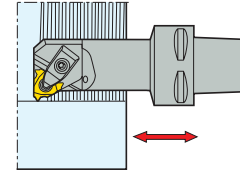
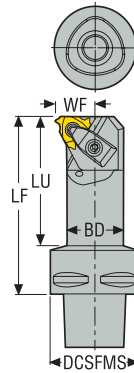
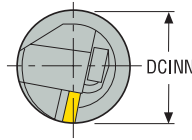













- Right-hand version shown
- For inserts program, see page(s) 126, 129, 130, 134, 135, 136, 141, 142, 145, 147, 150, 151, 153, 155, 157, 159, 161, 163, 165, 167, 169, 171, 173, 175, 177

Designation	Item number	BD	DCSFMS	LF	WF	DCINN	LU	Weight		CTWS
								mm	kg	
C4-SNR-10060-16	00008610	16,0 0.630	40,0 1.575	60,0 2.362	10,0 0.394	19,0 0.748	37,0 1.457	0,3 0.660	16..	
C4-CNR-14060-16HD	02555280	20,0 0.787	40,0 1.575	60,0 2.362	13,8 0.543	24,0 0.945	36,0 1.417	0,4 0.880	16..	
C4-CNR-17070-16HD	02555284	25,0 0.984	40,0 1.575	70,0 2.756	16,3 0.642	29,0 1.142	48,0 1.890	0,5 1.100	16..	
C4-CNR-20090-16HD	02555320	32,0 1.260	40,0 1.575	90,0 3.543	19,8 0.780	36,0 1.417	69,0 2.717	0,7 1.540	16..	
C4-CNL-14060-16HD	02555337	20,0 0.787	40,0 1.575	60,0 2.362	13,8 0.543	24,0 0.945	36,0 1.417	0,4 0.880	16..	
C4-CNL-17070-16HD	02555331	25,0 0.984	40,0 1.575	70,0 2.756	16,3 0.642	29,0 1.142	48,0 1.890	0,5 1.100	16..	
C4-CNL-20090-16HD	02555371	32,0 1.260	40,0 1.575	90,0 3.543	19,8 0.780	36,0 1.417	69,0 2.717	0,7 1.540	16..	
C4-CNR-22090-22HD	02555375	32,0 1.260	40,0 1.575	90,0 3.543	21,3 0.839	38,0 1.496	69,0 2.717	0,6 1.320	22..	
C4-CNL-22090-22HD	02555384	32,0 1.260	40,0 1.575	90,0 3.543	21,3 0.839	38,0 1.496	69,0 2.717	0,6 1.320	22..	

Spare Parts, included in delivery

For holders	Cantilever clamp	Clamp key	Clamp kit	Clamp screw	Insert key	Insert screw	Insert shim (S)	Shim screw	Spring
...10060-16	-	-	-	-	T15P-2	C03508-T15P	-	-	-
...14060, 17070-16HD	-	T15P-2	CSP16HD-T15P	-	-	-	GX16-1	CS3507-T09P	-
...20090-16HD	CHD16	T15P-2	-	L85020-T15P	-	-	GX16-1	CS3507-T09P	S6912
...22090-22HD	-	T15P-2	CSP22HD-T15P	-	-	-	NX22-1	CS4009-T15P	-

Accessories

For holders	Insert shim (M)	Insert shim (S)	Insert shim (S)	Insert shim (S)	Insert shim (S)	Insert shim (S)	Insert shim (S)	Insert shim (S)	Insert shim (S)	Insert shim (S)	Insert shim (S)	Insert shim (S)	Shim key
													
...10060-16	-	-	-	-	-	-	-	-	-	-	-	-	-
...14060, 17070-16HD	MX16-1	GX16-0	-	-	GX16-2	GX16-3	GX16-4	GX16-98	GX16-99	-	-	-	T09P-2
...20090-16HD	MX16-1	GX16-0	-	-	GX16-2	GX16-3	GX16-4	GX16-98	GX16-99	-	-	-	T09P-2
...22090-22HD	MX22-1	NX22-97.5	NX22-98	NX22-99	NX22-98.5	NX22-99.5	NX22-0.5	NX22-1.5	NX22-0	NX22-2	NX22-3	NX22-4	-

Seco-Capto™ – Toolholders, internal

For S-inserts, Snap-Tap®

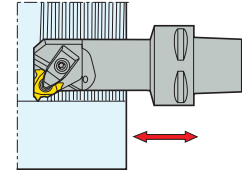
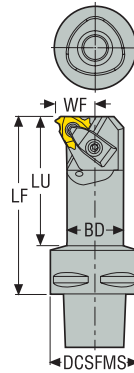
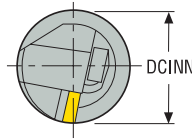













- Right-hand version shown
- For inserts program, see page(s) 126, 129, 130, 134, 135, 136, 141, 142, 145, 147, 150, 151, 153, 155, 157, 159, 161, 163, 165, 167, 169, 171, 173, 175, 177

Designation	Item number	BD	DCSFMS	LF	WF	DCINN	LU	Weight	CTWS
		mm Inch	mm Inch	mm Inch	mm Inch	mm Inch	mm Inch		
C5-CNR-14060-16HD	02555383	20,0 0.787	50,0 1.969	60,0 2.362	13,8 0.543	24,0 0.945	36,0 1.417	0,6 1.320	16..
C5-CNR-17070-16HD	02555388	25,0 0.984	50,0 1.969	70,0 2.756	16,3 0.642	29,0 1.142	47,0 1.850	0,6 1.320	16..
C5-CNR-20090-16HD	02555391	32,0 1.260	50,0 1.969	90,0 3.543	19,8 0.780	36,0 1.417	68,0 2.677	0,8 1.760	16..
C5-CNL-14060-16HD	02555739	20,0 0.787	50,0 1.969	60,0 2.362	13,8 0.543	24,0 0.945	36,0 1.417	0,6 1.320	16..
C5-CNL-17070-16HD	02555740	25,0 0.984	50,0 1.969	70,0 2.756	16,3 0.642	29,0 1.142	47,0 1.850	0,6 1.320	16..
C5-CNL-20090-16HD	02555741	32,0 1.260	50,0 1.969	90,0 3.543	19,8 0.780	36,0 1.417	68,0 2.677	0,8 1.760	16..
C5-CNR-18070-22HD	02555742	25,0 0.984	50,0 1.969	70,0 2.756	17,8 0.701	30,0 1.181	47,0 1.850	0,6 1.320	22..
C5-CNR-22090-22HD	02555743	32,0 1.260	50,0 1.969	90,0 3.543	21,3 0.839	38,0 1.496	68,0 2.677	0,8 1.760	22..
C5-CNL-18070-22HD	02555745	25,0 0.984	50,0 1.969	70,0 2.756	17,8 0.701	30,0 1.181	47,0 1.850	0,6 1.320	22..
C5-CNL-22090-22HD	02555747	32,0 1.260	50,0 1.969	90,0 3.543	21,3 0.839	38,0 1.496	68,0 2.677	0,8 1.760	22..
C5-CNR-26105-27HD	02823806	40,0 1.575	50,0 1.969	105,0 4.134	24,78 0.976	46,0 1.811	83,7 3.295	1,2 2.650	27..
C5-CNL-26105-27HD	02823807	40,0 1.575	50,0 1.969	105,0 4.134	24,78 0.976	46,0 1.811	83,7 3.295	1,2 2.650	27..

Spare Parts, included in delivery

For holders	Cantilever clamp	Clamp key	Clamp kit	Clamp screw	Insert shim (S)	Shim screw	Spring
...14060, 17070-16HD	–	T15P-2	CSP16HD-T15P	–	GX16-1	CS3507-T09P	–
...20090-16HD	CHD16	T15P-2	–	L85020-T15P	GX16-1	CS3507-T09P	S6912
...22HD	–	T15P-2	CSP22HD-T15P	–	NX22-1	CS4009-T15P	–
...27HD	CHD27	T20P-7	–	L86025-T20P	VX27-1	C05012-T15P	S7616

Accessories

For holders	Insert shim (M)	Insert shim (S)	Insert shim (S)	Insert shim (S)	Insert shim (S)	Insert shim (S)	Insert shim (S)	Insert shim (S)	Insert shim (S)	Insert shim (S)	Insert shim (S)	Insert shim (S)	Shim key
													
...14060, 17070-16HD	MX16-1	GX16-0	-	-	GX16-2	GX16-3	GX16-4	GX16-98	GX16-99	-	-	-	T09P-2
...20090-16HD	MX16-1	GX16-0	-	-	GX16-2	GX16-3	GX16-4	GX16-98	GX16-99	-	-	-	T09P-2
...22HD	MX22-1	NX22-97.5	NX22-98	NX22-99	NX22-98.5	NX22-99.5	NX22-0.5	NX22-1.5	NX22-0	NX22-2	NX22-3	NX22-4	T15P-2
...27HD	MX27-1	VX27-98.5	VX27-2	-	VX27-99.5	VX27-0.5	VX27-1.5	VX27-98	VX27-99	VX27-3	VX27-4	VX27-0	T15P-2

Seco-Capto™ – Toolholders, internal

For S-inserts, Snap-Tap®

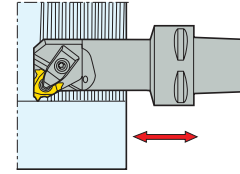
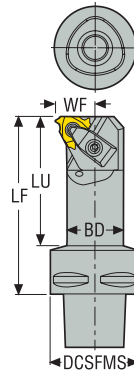
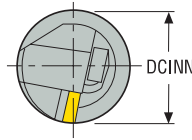

- Right-hand version shown
- For inserts program, see page(s) 126, 129, 130, 134, 135, 136, 141, 142, 145, 147, 150, 151, 153, 155, 157, 159, 161, 163, 165, 167, 173

Designation	Item number	BD	DCSFMS	LF	WF	DCINN	LU	Weight	CTWS
		mm Inch	mm Inch	mm Inch	mm Inch	mm Inch	mm Inch		
C6-CNR-17075-16HD	02555750	25,0 0.984	63,0 2.480	75,0 2.953	16,3 0.642	29,0 1.142	53,0 2.087	0,9 1.980	16
C6-CNR-20090-16HD	02555762	32,0 1.260	63,0 2.480	90,0 3.543	19,8 0.780	36,0 1.417	68,0 2.677	1,1 2.430	16
C6-CNR-24105-16HD	02555766	40,0 1.575	63,0 2.480	105,0 4.134	23,8 0.937	44,0 1.732	80,0 3.150	1,5 3.310	16
C6-CNL-17075-16HD	02555768	25,0 0.984	63,0 2.480	75,0 2.953	16,3 0.642	29,0 1.142	53,0 2.087	0,9 1.980	16
C6-CNL-20090-16HD	02555769	32,0 1.260	63,0 2.480	90,0 3.543	19,8 0.780	36,0 1.417	68,0 2.677	1,1 2.430	16
C6-CNL-24105-16HD	02555771	40,0 1.575	63,0 2.480	105,0 4.134	23,8 0.937	44,0 1.732	80,0 3.150	1,5 3.310	16

Spare Parts, included in delivery

For holders	Cantilever clamp	Clamp key	Clamp kit	Clamp screw	Insert shim (S)	Shim screw	Spring
...17075-16HD	-	T15P-2	CSP16HD-T15P	-	GX16-1	CS3507-T09P	-
...20090, 24105-16HD	CHD16	T15P-2	-	L85020-T15P	GX16-1	CS3507-T09P	S6912

Accessories

For holders	Insert shim (M)	Insert shim (S)	Insert shim (S)	Insert shim (S)	Insert shim (S)	Insert shim (S)	Insert shim (S)	Shim key
...17075-16HD	MX16-1	GX16-0	GX16-2	GX16-3	GX16-4	GX16-98	GX16-99	T09P-2
...20090, 24105-16HD	MX16-1	GX16-0	GX16-2	GX16-3	GX16-4	GX16-98	GX16-99	T09P-2

Seco-Capto™ – Toolholders, internal

For S-inserts, Snap-Tap®

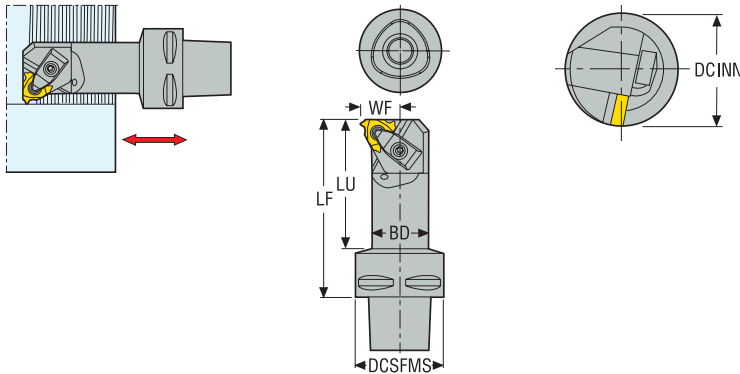

- Right-hand version shown
- For inserts program, see page(s) 126, 129, 130, 134, 135, 136, 141, 142, 145, 147, 150, 151, 155, 159, 161, 163, 165, 167, 169, 171, 175, 177

Designation	Item number	BD	DCSFMS	LF	WF	DCINN	LU	Weight	CTWS
		mm Inch	mm Inch	mm Inch	mm Inch	mm Inch	mm Inch		
C6-CNR-18075-22HD	02555772	25,0 0.984	63,0 2.480	75,0 2.953	17,8 0.701	30,0 1.181	53,0 2.087	0,9 1.980	22
C6-CNR-22090-22HD	02555773	32,0 1.260	63,0 2.480	90,0 3.543	21,3 0.839	38,0 1.496	68,0 2.677	1,1 2.430	22
C6-CNR-26105-22HD	02555776	40,0 1.575	63,0 2.480	105,0 4.134	25,3 0.996	46,0 1.811	80,0 3.150	1,5 3.310	22
C6-CNL-18075-22HD	02555777	25,0 0.984	63,0 2.480	75,0 2.953	17,8 0.701	30,0 1.181	53,0 2.087	0,9 1.980	22
C6-CNL-22090-22HD	02555832	32,0 1.260	63,0 2.480	90,0 3.543	21,3 0.839	38,0 1.496	68,0 2.677	1,1 2.430	22
C6-CNL-26105-22HD	02555833	40,0 1.575	63,0 2.480	105,0 4.134	25,3 0.996	46,0 1.811	80,0 3.150	1,5 3.310	22

Spare Parts, included in delivery

For holders	Cantilever clamp	Clamp key	Clamp kit	Clamp screw	Insert shim (S)	Shim screw	Spring
..18075, 22090..	–	T15P-2	CSP22HD-T15P	–	NX22-1	CS4009-T15P	–
..26105..	CHD22	T20P-7L	–	L86025-T20P	NX22-1	CS4009-T15P	S7616

Accessories

For holders	Insert shim (M)	Insert shim (S)	Insert shim (S)	Insert shim (S)	Insert shim (S)	Insert shim (S)	Insert shim (S)	Insert shim (S)	Insert shim (S)	Insert shim (S)	Insert shim (S)	Insert shim (S)	Shim key
..18075, 22090..	MX22-1	NX22-97.5	NX22-98	NX22-99	NX22-98.5	NX22-99.5	NX22-0.5	NX22-1.5	NX22-0	NX22-2	NX22-3	NX22-4	T15P-2
..26105..	MX22-1	NX22-97.5	NX22-98	NX22-99	NX22-98.5	NX22-99.5	NX22-0.5	NX22-1.5	NX22-0	NX22-2	NX22-3	NX22-4	T15P-2

Seco-Capto™ – Toolholders, internal

For S-inserts, Snap-Tap®

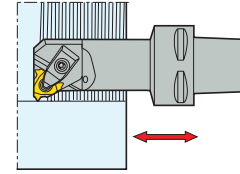
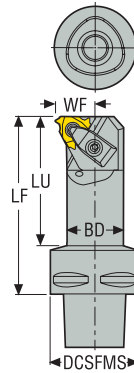
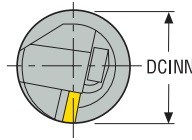

- Right-hand version shown
- For inserts program, see page(s) 134, 135, 136 141, 142, 159, 161, 163, 165, 167, 169, 171, 173

Designation	Item number	BD	DCSFMS	LF	WF	DCINN	LU	Weight	CTWS
C6-CNR-26105-27HD	02644670	40,0 1.575	63,0 2.480	105,0 4.134	25,3 0.996	46,0 1.811	77,0 3.031	1,6 3.530	27
C6-CNR-36182-27HD	02485584	63,0 2.480	63,0 2.480	182,0 7.165	36,0 1.417	70,0 2.756	–	4,1 9.040	27
C6-CNL-26105-27HD	02644672	40,0 1.575	63,0 2.480	105,0 4.134	25,3 0.996	46,0 1.811	77,0 3.031	1,6 3.530	27
C6-CNL-36182-27HD	02644681	63,0 2.480	63,0 2.480	182,0 7.165	36,0 1.417	70,0 2.756	–	4,1 9.040	27
C8-CNR-36190-27HD	02644684	54,0 2.126	80,0 3.150	190,0 7.480	36,0 1.417	70,0 2.756	160,0 6.299	4,2 9.260	27
C8-CNL-36190-27HD	02644685	54,0 2.126	80,0 3.150	190,0 7.480	36,0 1.417	70,0 2.756	160,0 6.299	4,2 9.260	27

Spare Parts, included in delivery

For holders	Cantilever clamp	Clamp key	Clamp screw	Coolant nozzle	Insert shim (S)	Shim screw	Spring
C6...	CHD27	T20P-7	L86025-T20P	–	VX27-1	C05012-T15P	S7616
C8...	CHD27	T20P-7	L86025-T20P	CN8	VX27-1	C05012-T15P	S7616

Accessories

For holders	Insert shim (M)	Insert shim (S)	Insert shim (S)	Insert shim (S)	Insert shim (S)	Insert shim (S)	Insert shim (S)	Insert shim (S)	Insert shim (S)	Insert shim (S)	Insert shim (S)	Shim key
C6...	MX27-1	VX27-98.5	VX27-2	VX27-99.5	VX27-0.5	VX27-1.5	VX27-98	VX27-99	VX27-3	VX27-4	VX27-0	T15P-2
C8...	MX27-1	VX27-98.5	VX27-2	VX27-99.5	VX27-0.5	VX27-1.5	VX27-98	VX27-99	VX27-3	VX27-4	VX27-0	T15P-2

Seco-Capto™ – Toolholders, internal

For S-inserts, Snap-Tap®

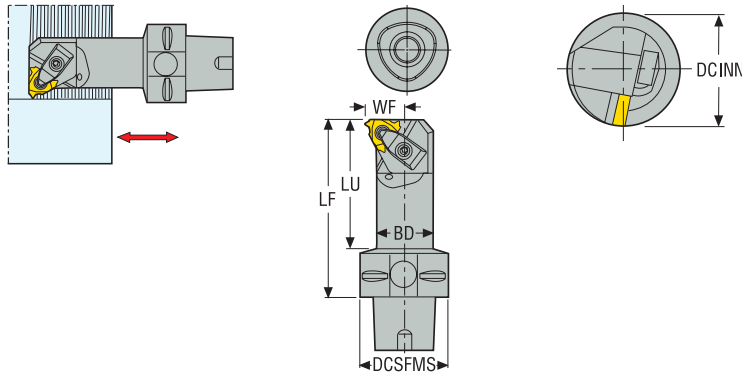

- Right-hand version shown
- For inserts program, see page(s) 126, 129, 130, 134, 135, 136, 141, 142, 145, 147, 150, 151, 153, 155, 157, 159, 161, 163, 165, 167, 169, 171, 173, 175, 177

Designation	Item number	BD	DCSFMS	LF	WF	DCINN	LU	Weight	CTWS
		mm Inch	mm Inch	mm Inch	mm Inch	mm Inch	mm Inch		
C4-CNR-14060-16CHD	02555834	20,0 0.787	40,0 1.575	60,0 2.362	13,8 0.543	24,0 0.945	36,0 1.417	0,4 0.880	16
C4-CNL-14060-16CHD	02555835	20,0 0.787	40,0 1.575	60,0 2.362	13,8 0.543	24,0 0.945	36,0 1.417	0,4 0.880	16
C5-CNR-17070-16CHD	02555836	25,0 0.984	50,0 1.969	70,0 2.756	16,3 0.642	29,0 1.142	47,0 1.850	0,6 1.320	16
C5-CNR-20090-16CHD	02555837	32,0 1.260	50,0 1.969	90,0 3.543	19,8 0.780	36,0 1.417	68,0 2.677	0,8 1.760	16
C5-CNL-17070-16CHD	02555839	25,0 0.984	50,0 1.969	70,0 2.756	16,3 0.642	29,0 1.142	47,0 1.850	0,6 1.320	16
C5-CNL-20090-16CHD	02555840	32,0 1.260	50,0 1.969	90,0 3.543	19,8 0.780	36,0 1.417	68,0 2.677	0,8 1.760	16
C5-CNR-18070-22CHD	02555841	25,0 0.984	50,0 1.969	70,0 2.756	17,8 0.701	30,0 1.181	47,0 1.850	0,6 1.320	22
C5-CNL-18070-22CHD	02555842	25,0 0.984	50,0 1.969	70,0 2.756	17,8 0.701	30,0 1.181	47,0 1.850	0,6 1.320	22

Spare Parts, included in delivery

For holders	Cantilever clamp	Clamp key	Clamp kit	Clamp screw	Insert shim (S)	Shim screw	Spring
...14060, ...17070-16CHD	-	T15P-2	CSP16HD-T15P	-	GX16-1	CS3507-T09P	-
...20090-16CHD	CHD16	T15P-2	-	L85020-T15P	GX16-1	CS3507-T09P	S6912
...18070-22CHD	-	T15P-2	CSP22HD-T15P	-	NX22-1	CS4009-T15P	-

Accessories

For holders	Insert shim (M)	Insert shim (S)	Insert shim (S)	Insert shim (S)	Insert shim (S)	Insert shim (S)	Insert shim (S)	Insert shim (S)	Insert shim (S)	Insert shim (S)	Insert shim (S)	Insert shim (S)	Shim key
...14060, ...17070-16CHD	MX16-1	GX16-0	-	-	GX16-2	GX16-3	GX16-4	GX16-98	GX16-99	-	-	-	T09P-2
...20090-16CHD	MX16-1	GX16-0	-	-	GX16-2	GX16-3	GX16-4	GX16-98	GX16-99	-	-	-	T09P-2
...18070-22CHD	MX22-1	NX22-97.5	NX22-98	NX22-99	NX22-98.5	NX22-99.5	NX22-0.5	NX22-1.5	NX22-0	NX22-2	NX22-3	NX22-4	-

Seco-Capto™ – Toolholders, internal

For S-inserts, Snap-Tap®

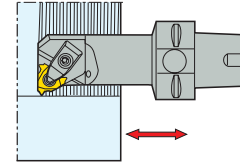
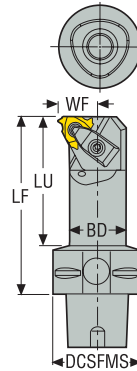
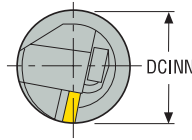

- Right-hand version shown
- For inserts program, see page(s) 126, 129, 130, 134, 135, 136, 141, 142, 145, 147, 150, 151, 153, 155, 157, 159, 161, 163, 165, 167, 169, 171, 173, 175, 177

Designation	Item number	BD	DCSFMS	LF	WF	DCINN	LU	Weight	CTWS
		mm Inch	mm Inch	mm Inch	mm Inch	mm Inch	mm Inch		
C6-CNR-20090-16CHD	02555843	32,0 1.260	63,0 2.480	90,0 3.543	19,8 0.780	36,0 1.417	68,0 2.677	1,1 2.430	16
C6-CNR-24105-16CHD	02555844	40,0 1.575	63,0 2.480	105,0 4.134	23,8 0.937	44,0 1.732	80,0 3.150	1,5 3.310	16
C6-CNL-20090-16CHD	02555845	32,0 1.260	63,0 2.480	90,0 3.543	19,8 0.780	36,0 1.417	68,0 2.677	1,1 2.430	16
C6-CNL-24105-16CHD	02555847	40,0 1.575	63,0 2.480	105,0 4.134	23,8 0.937	44,0 1.732	80,0 3.150	1,5 3.310	16
C6-CNR-22090-22CHD	02555848	32,0 1.260	63,0 2.480	90,0 3.543	21,3 0.839	38,0 1.496	68,0 2.677	1,1 2.430	22
C6-CNR-26105-22CHD	02555849	40,0 1.575	63,0 2.480	105,0 4.134	25,3 0.996	46,0 1.811	80,0 3.150	1,5 3.310	22
C6-CNL-22090-22CHD	02555850	32,0 1.260	63,0 2.480	90,0 3.543	21,3 0.839	38,0 1.496	68,0 2.677	1,1 2.430	22
C6-CNL-26105-22CHD	02555852	40,0 1.575	63,0 2.480	105,0 4.134	25,3 0.996	46,0 1.811	80,0 3.150	1,5 3.310	22

Spare Parts, included in delivery

For holders	Cantilever clamp	Clamp key	Clamp kit	Clamp screw	Insert shim (S)	Shim screw	Spring
...16CHD	CHD16	T15P-2	-	L85020-T15P	GX16-1	CS3507-T09P	S6912
...22090-22CHD	-	T15P-2	CSP22HD-T15P	-	NX22-1	CS4009-T15P	-
...26105-22CHD	CHD22	T20P-7L	-	L86025-T20P	NX22-1	CS4009-T15P	S7616

Accessories

For holders	Insert shim (M)	Insert shim (S)	Insert shim (S)	Insert shim (S)	Insert shim (S)	Insert shim (S)	Insert shim (S)	Insert shim (S)	Insert shim (S)	Insert shim (S)	Insert shim (S)	Insert shim (S)	Shim key
...16CHD	MX16-1	GX16-0	-	-	GX16-2	GX16-3	GX16-4	GX16-8	GX16-9	-	-	-	T09P-2
...22090-22CHD	MX22-1	NX22-97.5	NX22-98	NX22-99	NX22-98.5	NX22-99.5	NX22-0.5	NX22-1.5	NX22-0	NX22-2	NX22-3	NX22-4	T15P-2
...26105-22CHD	MX22-1	NX22-97.5	NX22-98	NX22-99	NX22-98.5	NX22-99.5	NX22-0.5	NX22-1.5	NX22-0	NX22-2	NX22-3	NX22-4	T15P-2

Thread turning

MDT

Mini-Shaft™

Thread milling

Thread tapping

Annex

Seco-Capto™ – Toolholders, internal

For S-inserts, Snap-Tap®

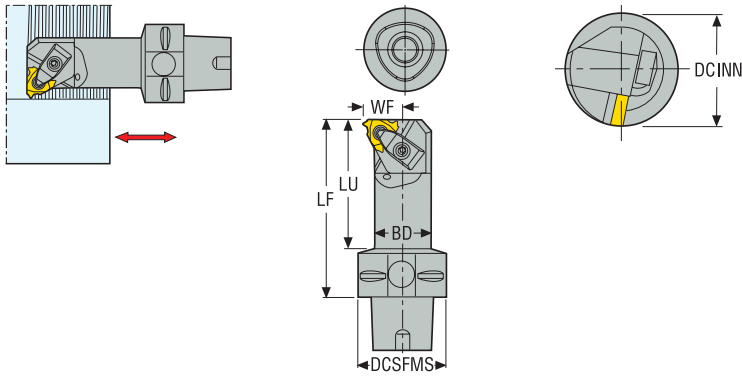

- Right-hand version shown
- For inserts program, see page(s) 134, 135, 136, 141, 142, 159, 161, 163, 165, 167, 169, 171, 173

Designation	Item number	BD	DCSFMS	LF	WF	DCINN	LU	Weight	CTWS
		mm Inch	mm Inch	mm Inch	mm Inch	mm Inch	mm Inch		
C6-CNR-26105-27CHD	02644674	40,0 1.575	63,0 2.480	105,0 4.134	25,3 0.996	46,0 1.811	80,0 3.150	1,5 3.310	27
C6-CNR-36182-27CHD	02644686	63,0 2.480	63,0 2.480	182,0 7.165	36,0 1.417	70,0 2.756	–	4,1 9.040	27
C6-CNL-26105-27CHD	02644677	40,0 1.575	63,0 2.480	105,0 4.134	25,3 0.996	46,0 1.811	80,0 3.150	1,5 3.310	27
C6-CNL-36182-27CHD	02644687	63,0 2.480	63,0 2.480	182,0 7.165	36,0 1.417	70,0 2.756	–	4,1 9.040	27

Spare Parts, included in delivery

For holders	Cantilever clamp	Clamp key	Clamp screw	Insert shim (S)	Shim screw	Spring
C6...						
	CHD27	T20P-7	L86025-T20P	VX27-1	C05012-T15P	S7616

Accessories

For holders	Insert shim (M)	Insert shim (S)	Insert shim (S)	Insert shim (S)	Insert shim (S)	Insert shim (S)	Insert shim (S)	Insert shim (S)	Insert shim (S)	Insert shim (S)	Insert shim (S)	Shim key
C6...												
	MX27-1	VX27-98.5	VX27-2	VX27-99.5	VX27-0.5	VX27-1.5	VX27-98	VX27-99	VX27-3	VX27-4	VX27-0	T15P-2

Seco-Capto™ – Toolholders for MTM

For S-inserts, Snap-Tap®

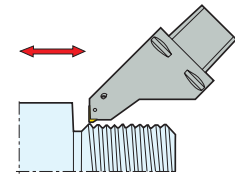
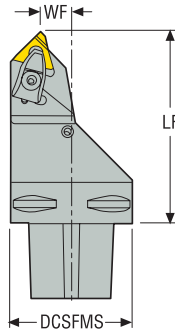

- Right-hand version shown
- For inserts program, see page(s) 125, 127, 128, 131, 132, 138, 139, 144, 146, 148, 149, 152, 154, 156, 158, 160, 162, 164, 166, 168, 170, 172, 174, 176

Designation	Item number	DCSFMS		LF		WF		Weight	CTWS	
		mm	Inch	mm	Inch	mm	Inch			kg
C6-CER-18100-16HD	02509302	63,0	2.480	100,0	3.937	18,0	0.709	1,6	3.530	16
C6-CER-16100-22HD	02509303	63,0	2.480	100,0	3.937	16,0	0.630	1,6	3.530	22
C6-CER-12100-27HD	02509304	63,0	2.480	100,0	3.937	12,0	0.472	1,6	3.530	27

Spare Parts, included in delivery

For holders	Cantilever clamp	Clamp key	Clamp screw	Coolant nozzle	Insert shim (S)	Shim screw	Spring
...16HD	CHD16	T15P-7	L85020-T15P	CN8	GX16-1	CS3507-T09P	S6912
...22HD	CHD22	T20P-7L	L86025-T20P	CN8	NX22-1	CS4009-T15P	S7616
...27HD	CHD27	T20P-7L	L86025-T20P	CN3	VX27-1	C05012-T15P	S7616

Accessories

For holders	Insert shim (M)	Insert shim (S)	Insert shim (S)	Insert shim (S)	Insert shim (S)	Insert shim (S)	Insert shim (S)	Insert shim (S)	Insert shim (S)	Insert shim (S)	Insert shim (S)	Insert shim (S)	Shim key
...16HD	MX16-1	GX16-0	-	-	GX16-2	GX16-3	GX16-4	GX16-98	GX16-99	-	-	-	T09P-2
...22HD	MX22-1	NX22-97.5	NX22-98	NX22-99	NX22-98.5	NX22-99.5	NX22-0.5	NX22-1.5	NX22-0	NX22-2	NX22-3	NX22-4	T15P-2
...27HD	MX27-1	VX27-98.5	VX27-2	-	VX27-99.5	VX27-0.5	VX27-1.5	VX27-98	VX27-99	VX27-3	VX27-4	VX27-0	T15P-2

Seco-Capto™ – Toolholders for MTM

For K-inserts, Snap-Tap®

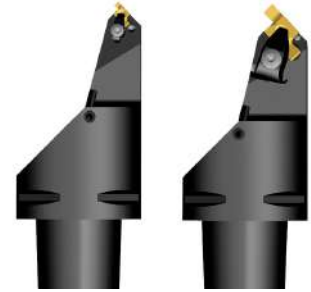
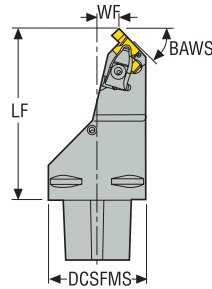
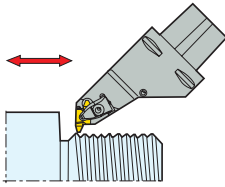

- Left-hand version shown
- For inserts program, see page(s) 125, 127, 128, 160, 162, 164

Designation	Item number	DCSFMS		LF	WF	Weight	BAWS°	CTWS			
		mm	Inch								
C6-CEL-14110-20HD	02509308	63,0	2.480	110,0	4.331	14,0	0.551	1,7	3.750	45	20..
C6-CEL-07110-26HD	02509309	63,0	2.480	110,0	4.331	7,0	0.276	1,7	3.750	45	26..
C6-CEL-18110-14	02509306	63,0	2.480	110,0	4.331	18,0	0.709	1,7	3.750	45	14..

Spare Parts, included in delivery

For holders	Cantilever clamp	Clamp key	Clamp kit	Clamp screw	Coolant nozzle	Insert shim (K)	Shim screw	Spring
-20	CHD22	T20P-7	–	L86025-T20P	CN8	KX20-2	CS4009-T15P	S7616
-26	CHD27	T20P-7	–	L86025-T20P	CN8	KX26-2	C05012-T15P	S7616
-14	–	T15P-2	CSP16-T15P	–	CN8	KX14-2	CS3507-T09P	–

Accessories

For holders	Insert shim (K)	Insert shim (K)	Insert shim (K)	Insert shim (K)	Insert shim (K)	Insert shim (K)	Shim key
-20	KX20-99	KX20-0	KX20-1	KX20-3	KX20-4	KX20-5	T15P-2
-26	KX26-99	KX26-0	KX26-1	KX26-3	KX26-4	KX26-5	T15P-2
-14	KX14-0	KX14-1	KX14-3	KX14-4	KX14-5	–	T09P-2

Steadyline[®], GL-heads, Jetstream Tooling[®]



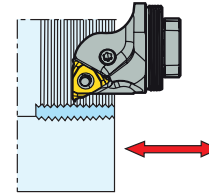
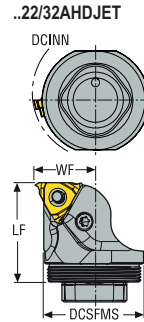
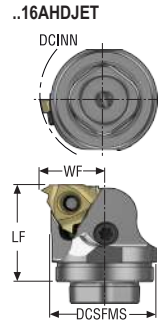











For S-inserts, Snap-Tap[®]

































- Right-hand version shown
- For inserts program, see page(s) 126, 129, 130, 134, 135, 136, 141, 142, 145, 147, 150, 151, 153, 155, 157, 159, 161, 163, 165, 173
- CP * Max coolant pressure

Designation	Item number	DCSFMS		LF		WF		DCINN	CP	Weight	CTWS
		mm Inch	mm Inch	mm Inch	mm Inch	mm Inch	mm Inch				
GL25-PNR-17025-16AHDJET	03212499	25,0 0.984	25,0 0.984	16,3 0.642	29,0 1.142	200,0 2900.8	0,1 0.220	16			
GL25-PNL-17025-16AHDJET	03212502	25,0 0.984	25,0 0.984	16,3 0.642	29,0 1.142	200,0 2900.8	0,1 0.220	16			
GL32-PNR-20032-16AHDJET	03007255	32,0 1.260	32,0 1.260	19,8 0.780	36,0 1.417	200,0 2900.8	0,2 0.440	16			
GL32-PNL-20032-16AHDJET	03007256	32,0 1.260	32,0 1.260	19,8 0.780	36,0 1.417	200,0 2900.8	0,2 0.440	16			
GL40-PNR-24032-16AHDJET	03007261	40,0 1.575	32,0 1.260	23,8 0.937	44,0 1.732	200,0 2900.8	0,4 0.880	16			
GL40-PNL-24032-16AHDJET	03007262	40,0 1.575	32,0 1.260	23,8 0.937	44,0 1.732	200,0 2900.8	0,3 0.660	16			
GL50-PNR-29032-16AHDJET	03007264	50,0 1.969	32,0 1.260	28,8 1.134	54,0 2.126	200,0 2900.8	0,5 1.100	16			
GL50-PNL-29032-16AHDJET	03007265	50,0 1.969	32,0 1.260	28,8 1.134	54,0 2.126	200,0 2900.8	0,5 1.100	16			
GL32-PNR-22032-22AHDJET	03007257	32,0 1.260	32,0 1.260	21,3 0.839	38,0 1.496	200,0 2900.8	0,2 0.440	22			
GL32-PNL-22032-22AHDJET	03007258	32,0 1.260	32,0 1.260	21,3 0.839	38,0 1.496	200,0 2900.8	0,1 0.220	22			
GL40-PNR-26032-22AHDJET	03007263	40,0 1.575	32,0 1.260	25,3 0.996	46,0 1.811	200,0 2900.8	0,3 0.660	22			
GL40-PNL-26032-22AHDJET	03007468	40,0 1.575	32,0 1.260	25,3 0.996	46,0 1.811	200,0 2900.8	0,3 0.660	22			
GL50-PNR-31032-22AHDJET	03007266	50,0 1.969	32,0 1.260	30,3 1.193	56,0 2.205	200,0 2900.8	0,4 0.880	22			
GL50-PNL-31032-22AHDJET	03007267	50,0 1.969	32,0 1.260	30,3 1.193	56,0 2.205	200,0 2900.8	0,5 1.100	22			
GL40-PNR-27037-27AHDJET	03007260	40,0 1.575	37,0 1.457	26,8 1.055	48,0 1.890	200,0 2900.8	0,3 0.660	27			
GL50-PNR-32037-27AHDJET	03007259	50,0 1.969	37,0 1.457	31,8 1.252	58,0 2.283	200,0 2900.8	0,3 0.660	27			

Spare Parts, included in delivery

For holders	Insert lever	Insert shim (S)	Lever screw	Locking key	Shim pin
..16..	 PP3712	 GXA16-1	 LS0612-T15P	 T15P-2	 AC4625
..22A..	 PP4816	 NXA22-1	 LS0815-T25P	 T25P-7	 AC5035
..27A..	 PP6019	 VXA27-1	 LS0820-T25P	 T25P-7	 AC6050

Accessories

For holders	Insert shim (M)	Insert shim (S)	Insert shim (S)	Insert shim (S)	Insert shim (S)	Insert shim (S)	Insert shim (S)	Insert shim (S)	Insert shim (S)	Insert shim (S)	Insert shim (S)	Insert shim (S)
..16..	 MXA16-1	 GXA16-0	-	-	 GXA16-2	 GXA16-3	 GXA16-4	 GXA16-99	 GXA16-98	-	-	-
..22A..	 MXA22-1	 NXA22-0	 NXA22-98	 NXA22-97.5	 NXA22-0.5	 NXA22-1.5	 NXA22-2	 NXA22-3	 NXA22-4	 NXA22-99.5	 NXA22-99	 NXA22-98.5
..27A..	 MXA27-1	 VXA27-0	 VXA27-98	-	 VXA27-0.5	 VXA27-1.5	 VXA27-2	 VXA27-3	 VXA27-4	 VXA27-99.5	 VXA27-99	 VXA27-98.5

Steadyline[®], GL-heads

For K-inserts, Snap-Tap[®]

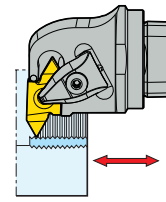
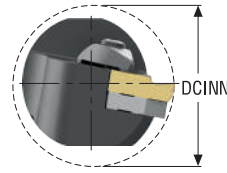
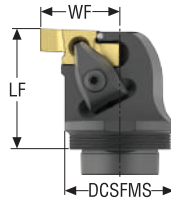

- Right-hand version shown
- For inserts program, see page(s)125, 126, 127, 127, 128, 129, 130, 161, 163, 165
- CP * Max coolant pressure

Designation	Item number	DCSFMS	LF	WF	DCINN	CP	Weight	CTWS
		mm Inch	mm Inch	mm Inch	mm Inch	bar psi	kg lbs	
GL50-CNR-36055-26AHD	03051391	50,0 1.969	55,0 2.165	36,0 1.417	65,0 2.559	200,0 2900.8	0,6 1.320	26 NR..

Spare Parts, included in delivery

For holders	Cantilever clamp	Clamp screw	Insert shim (K)	Key, clamp	Shim screw	Spring
GL50...						
	CHD27	L86025-T20P	KX26-2	T20P-2D	C05012-T15P	S7616

Accessories

For holders	Insert shim (K)	Insert shim (K)	Insert shim (K)	Insert shim (K)	Insert shim (K)	Insert shim (K)	Insert shim (K)	Shim key
GL50...								
	KX26-99	KX26-0	KX26-1	KX26-3	KX26-4	KX26-5	KX26-2	T15P-2

Thread turning

MDT

Mini-Shaft™

Thread milling

Thread tapping

Annex

Quick Change, Jetstream Tooling® QC-heads – External

For S-inserts, Snap-Tap®

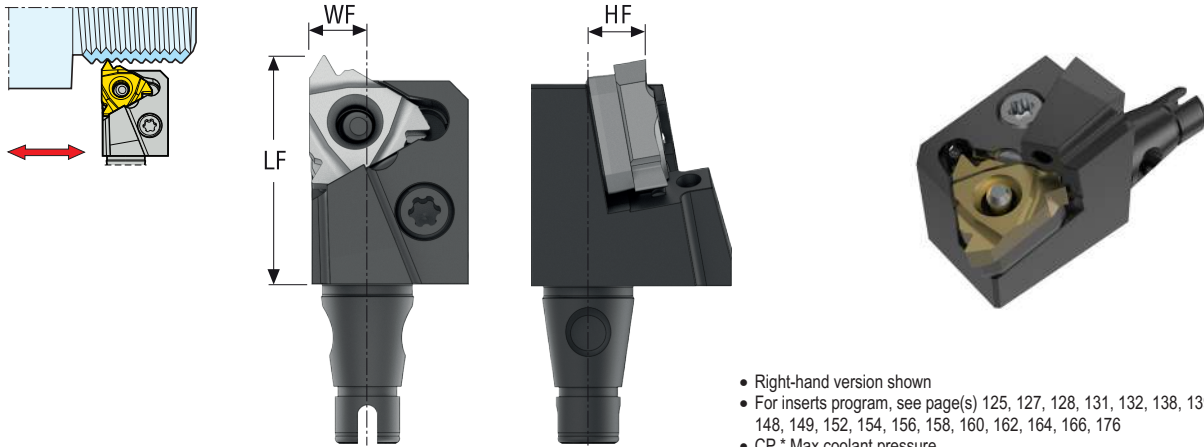

- Right-hand version shown
- For inserts program, see page(s) 125, 127, 128, 131, 132, 138, 139, 144, 146, 148, 149, 152, 154, 156, 158, 160, 162, 164, 166, 176
- CP * Max coolant pressure
- For Technical Guide, see catalog Turning

Designation	Item number	LF	WF	HF	CP	Weight	CTWS
		mm Inch	mm Inch	mm Inch	bar psi	kg lbs	
QC12-PER-16HDJET	03280772	25,0 0.984	6,0 0.236	5,975 0.235	200,0 7.9	0,1 0.220	16
QC12-PEL-16HDJET	03280773	25,0 0.984	6,0 0.236	5,975 0.235	200,0 7.9	0,3 0.660	16
QC16-PER-16HDJET	03280774	25,0 0.984	8,0 0.315	7,9 0.311	200,0 7.9	0,3 0.660	16
QC16-PEL-16HDJET	03280775	25,0 0.984	8,0 0.315	7,9 0.311	200,0 7.9	0,3 0.660	16

Spare Parts, included in delivery

For holders	Insert lever	Insert shim (S)	Lever key	Lever screw	Shim pin
QC12/16	PP3712	GXA16-1	T15P-2	LS0612-T15P	AC4625

Accessories

For holders	Insert clamping torque	Insert shim (M)	Insert shim (S)	Insert shim (S)	Insert shim (S)	Insert shim (S)	Insert shim (S)	Insert shim (S)	Insert shim (S)	Mounting fixture	Torque key
QC12/16	3.0NM	MXA16-1	GXA16-0	GXA16-2	GXA16-3	GXA16-4	GXA16-99	GXA16-98	SECO-MF7075-QC	T00-15P30	

Toolholder for peeling

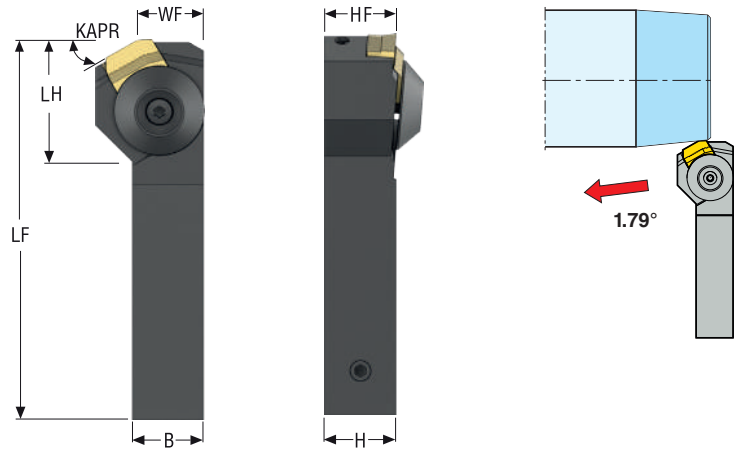

- Right-hand version shown
- For inserts program, see page(s) 124

Designation	Item number	KAPR°	B	H	LF	LH	WF	HF	Weight	CTWS
			mm	mm	mm	mm	mm	mm	kg	
CSXCR3232P25-R30	03120990	30	32,0	32,0	170,0	64,61	29,53	32,0	0,5	SCNN-R30

Spare Parts, included in delivery

For holders	Anvil screw	Chipbreaker	Insert screw	Key	Key (T-handle)	Plug	Shim
CSXCR...	CA4012	PS2518	W400820-T30P	H6B-T30PL	DOUBLE-T	JET-P1/8-5MM	SSN250630



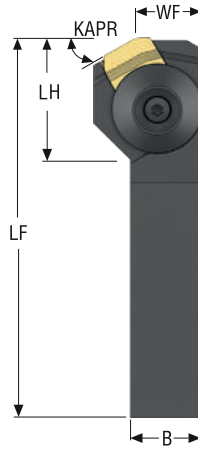
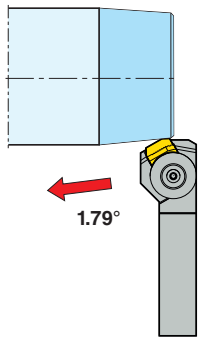



Toolholder for peeling

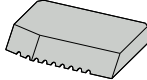

- Right-hand version shown
- For inserts program, see page(s) 124

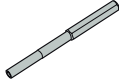
Designation	Item number	KAPR°	B	H	LF	LH	WF	HF	Weight	CTWS
			<i>Inch</i>	<i>Inch</i>	<i>Inch</i>	<i>Inch</i>	<i>Inch</i>	<i>Inch</i>	lbs	
CSXCR20-8D-R30	03120991	30	1.250	1.250	6.693	2.545	1.163	1.250	3.530	SCNN-R30

Spare Parts, included in delivery

For holders	Anvil screw	Chipbreaker	Insert screw	Key	Key (T-handle)	Plug	Shim
							
CSXCR...	CA4012	PS2518	W400820-T30P	H6B-T30PL	DOUBLE-T	JET-P1/8-5MM	SSN250630

Toolholder for pipe-facing

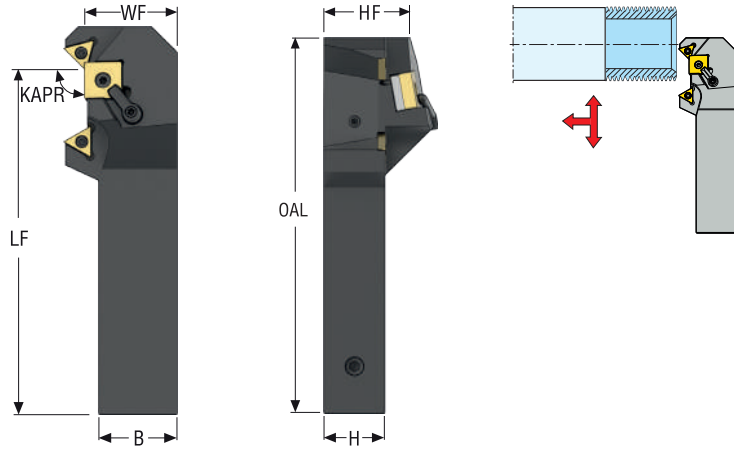

- Right-hand version shown
- For inserts program, see catalog Turning

Designation	Item number	KAPR°	B	H	LF	WF	HF	OAL	Weight	CTWS	CTWS
			mm	mm	mm	mm	mm	mm	kg		
MSGNR3240R19-TC-45-60	03120992	90,0	40,0	32,0	174,0	47,0	32,0	195,6	0,7	SN...1906... TCMT16T3...	SN...1906... TCMT16T3...

Spare Parts, included in delivery

For holders	Cantilever clamp	Clamp screw	Insert key	Insert screw	Insert shim	Key	Key (T-handle)	Plug	Shim pin
MSGNR...									
	MC22	LD6024-T20P	H4B-T15P	C03508-T15P	SSN190412	H6B-T20P	DOUBLE-T	JET-P1/8-5MM	MN1920-T20P

Thread turning

MDT

Mini-Shaft™

Thread milling



Thread tapping

Annex

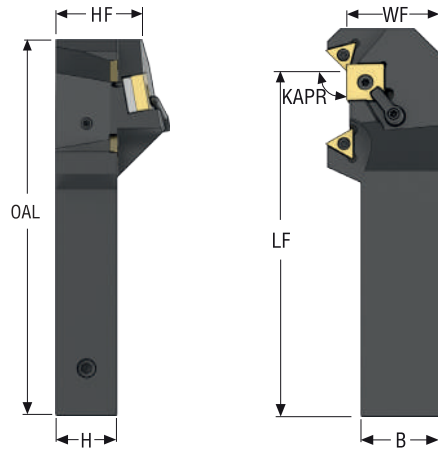
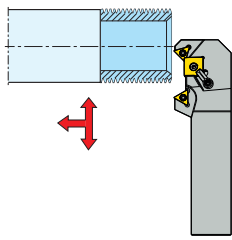







Toolholder for pipe-facing

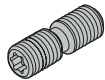

- Right-hand version shown
- For inserts program, see catalog Turning

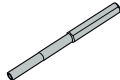
Designation	Item number	KAPR°	B	H	LF	WF	HF	OAL	Weight	CTWS	CTWS
			<i>Inch</i>	<i>Inch</i>	<i>Inch</i>	<i>Inch</i>	<i>Inch</i>	<i>Inch</i>	lbs		
MSGNR-125-6-TC-45-60	03120993	90	1.500	1.250	6.850	1.850	1.260	7.701	2.870	SN...1906... TCMT16T3...	SN...1906... TCMT16T3...

Spare Parts, included in delivery

For holders	Cantilever clamp	Clamp screw	Insert key	Insert screw	Insert shim	Key	Key (T-handle)	Plug	Shim pin
									
MSGNR...	MC22	LD6024-T20P	H4B-T15P	C03508-T15P	SSN190412	H6B-T20P	DOUBLE-T	JET-P1/8-5MM	MN1920-T20P

Seco-Capto™, Multi insert pocket tools, internal

Toolholders for inserts SNMA, SNMG, SNMM / CNMA, CNMG, CNMM

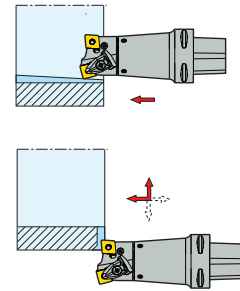
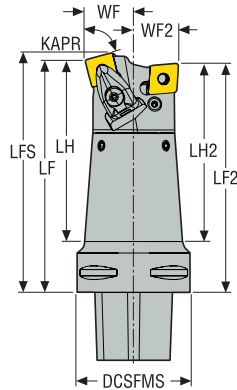

- Right-hand version shown
- For inserts program, see catalog Turning
- GAMO° = Rake angle, LAMS° = Inclination angle
- KAPR = 75°
- C-DSKNR/L - CLNR/L 75°

Designation	Item number	Seco-Capto size	GAMO°	LAMS°	DCSFMS	LF	LF2	LFS	LH	LH2	WF	WF2	Weight	CTWS	
						mm Inch	mm Inch	mm Inch	mm Inch	mm Inch	mm Inch	mm Inch		mm Inch	kg lbs
C6-DSKNR2713015-PCLNL2512816	03031406	C6	-5,0°	-10,0°	63,0 2.480	130,0 5.118	128,0 5.039	134,0 5.276	101,5 3.996	99,5 3.917	27,0 1.063	25,0 0.984	0,9 1.980	SN1506-CN1606/SN..54-CN..54	
C6-DSKNL2713015-PCLNR2512816C	03032390	C6	-5,0°	-10,0°	63,0 2.480	130,0 5.118	128,0 5.039	134,0 5.276	101,5 3.996	99,5 3.917	27,0 1.063	25,0 0.984	2,3 5.070	SN1506-CN1606/SN..54-CN..54	

Spare Parts, included in delivery

For holders	Clamp	Clamp pin	Clamp screw	Insert shim	Lever pin	Lever screw	Plug	Shim pin	Shim screw	Spring
C6	CD16-S	FP2012	L86026-T20P	PCN160412	PP6017	LS0820	P6SS6X5G	RP8286	C05010-T20P	S7010

Accessories

For holders	Clamp kit	Key	Lever key
C6	CD16-S16	T20P-7L	3SMS795

Thread turning

MDT

Mini-Shaft™

Thread milling

Thread tapping





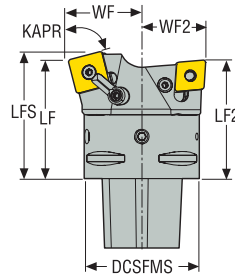
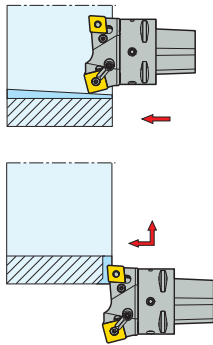



Annex

Seco-Capto™, Multi insert pocket tools, internal











KAPR = 75°
C.-DSKNR/L - CLNR/L 75°

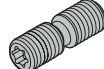

- Right-hand version shown
- For inserts program, see catalog Turning
- GAMO° = Rake angle, LAMS° = Inclination angle
- KAPR = 75°
- C.-DSKNR/L - CLNR/L 75°

Designation	Item number	Seco-Capto size	GAMO°	LAMS°	DCSFMS	LF	LF2	LFS	WF	WF2	Weight	CTWS	
												mm Inch	mm Inch
C6-MSKNR4006519-PCLNL3506516	03032391	C6	-5,0 °	-10,0 °	63,0 2.480	65,0 2.559	65,0 2.559	69,8 2.748	40,0 1.575	35,0 1.378	0,7 1.540		
C6-MSKNL4006519-PCLNR3506516C	03032405	C6	-5,0 °	-10,0 °	63,0 2.480	65,0 2.559	65,0 2.559	69,8 2.748	40,0 1.575	35,0 1.378	1,5 3.310		
C8-MSKNR4508019-PCLNL4508016	03032403	C8	-5,0 °	-10,0 °	80,0 3.150	80,0 3.150	80,0 3.150	85,0 3.346	45,0 1.772	45,0 1.772	3,3 7.280		
C8-MSKNL4508019-PCLNR4508016C	03031407	C8	-5,0 °	-10,0 °	80,0 3.150	80,0 3.150	80,0 3.150	85,0 3.346	45,0 1.772	45,0 1.772	3,1 6.830		

Spare Parts, included in delivery

For size	Clamp	Coolant nozzle	Insert shim	Lever pin	Lever screw	Pin	Plug	Screw	Shim pin
C6/C8	 MC22	 CN6	 SSN190412	 PP6017	 LS0820	 MN1920-T20P	 P6SS6X5G	 LD6024-T20P	 RP8286

Accessories

For holders	Key	Lever key
C6/C8	 T20P-7L	 3SMS795

Toolholders for chasers, External

Snap-Tap®

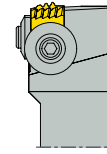
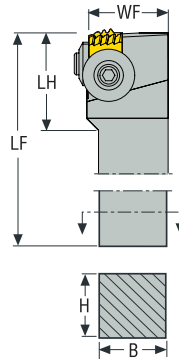

- Right-hand version shown
- For inserts program, see page(s) 178, 179

Designation	Item number	B	H	LF	WF	LH	Weight	CTWS
		mm	mm	mm	mm	mm	kg	
CER3232P1-X	03048363	32,0	32,0	170,24	37,25	47,54	1,4	15.875
CER3232P5-X	03048364	32,0	32,0	170,24	37,25	47,54	1,4	25.000

Spare Parts, included in delivery

For holders	Clamp kit side	Clamp kit top	Key, side clamp	Key, top clamp
CER	 W200613-T20P	 W240618-T25P	 T20P-7	 T25P-7

Thread turning

MDT

Mini-Shaft™

Thread milling

Thread tapping

Annex

Toolholders for chasers, External

Snap-Tap®

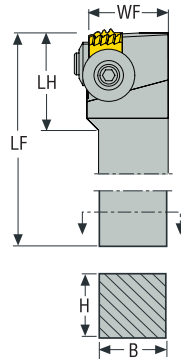
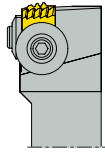

- Right-hand version shown
- For inserts program, see page(s) 178, 179

Designation	Item number	B	H	LF	WF	LH	Weight	CTWS
		<i>Inch</i>	<i>Inch</i>	<i>Inch</i>	<i>Inch</i>	<i>Inch</i>	lbs	
CER1256-1-X	03048365	1.250	1.250	6.702	1.467	1.872	3.090	15.875
CER1256-5-X	03048366	1.250	1.250	6.702	1.467	1.872	3.090	25.000

Spare Parts, included in delivery

For holders	Clamp kit side	Clamp kit top	Key, side clamp	Key, top clamp
CER	W200613-T20P	W240618-T25P	T20P-7	T25P-7

Thread turning

MDT

Mini-Shaft™

Thread milling

Thread tapping

Annex

Seco-Capto™ – Toolholders for chasers, external

Snap-Tap®

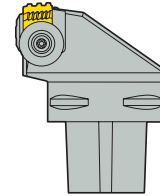
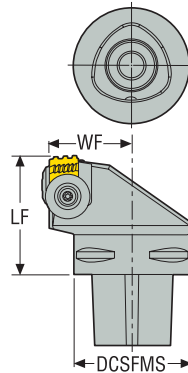

- Right-hand version shown
- For inserts program, see page(s) 178, 179

Designation	Item number	DCSFMS	LF	WF	Weight	CTWS
		mm	mm	mm	kg	
C6-CER-45065-1-X	02995827	63,0	65,0	45,0	1,3	15.875
C6-CER-45065-5-X	02995828	63,0	65,0	45,0	1,4	25.000
C8-CER-55080-1-X	02995821	80,0	80,0	55,0	2,7	15.875
C8-CER-55080-5-X	02995822	80,0	80,0	55,0	2,8	25.000

Spare Parts, included in delivery

For holders	Clamp kit side	Clamp kit top	Key, side clamp	Key, top clamp
C6/C8-X	 W200613-T20P	 W240618-T25P	 T20P-7	 T25P-7

Thread turning

MDT

Mini-Shaft™

Thread milling

Thread tapping

Annex

Seco-Capto™ – Toolholders for chasers, internal



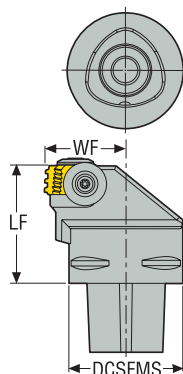
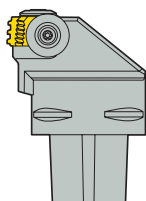

Snap-Tap®



- Right-hand version shown
- For inserts program, see page(s) 178, 179

Designation	Item number	DCSFMS	LF	WF	Weight	CTWS
		mm	mm	mm	kg	
C6-CNR-45065-1-X	02995829	63,0	65,0	45,0	1,4	15.875
C6-CNR-45065-5-X	02995831	63,0	65,0	45,0	1,4	25.000
C8-CNR-55080-1-X	02995823	80,0	80,0	55,0	2,9	15.875
C8-CNR-55080-5-X	02995825	80,0	80,0	55,0	2,9	25.000
C8-CNL-55080-1-X	03118011	80,0	80,0	55,0	1,9	15.875
C8-CNL-55080-5-X	03118015	80,0	80,0	55,0	1,7	25.000

Spare Parts, included in delivery

For holders	Clamp kit side	Clamp kit top	Coolant nozzle	Key, side clamp	Key, top clamp
...CNR...	 W200613-T20P	 W240618-T25P	 CN6	 T20P-7	 T25P-7
...CNL...	W200613-T20P	W240618-T25P	-	T20P-7	T25P-7

Seco-Capto™ – Toolholders for chasers, internal

Snap-Tap®

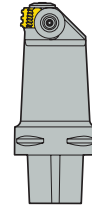
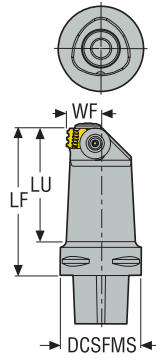

- Right-hand version shown
- For inserts program, see page(s) 178, 179

Designation	Item number	DCSFMS	LF	WF	LU	Weight	CTWS
		mm	mm	mm	mm	kg	
C6-CNR-27115-1-X	03003765	63,0	115,0	27,0	88,0	1,9	15.875
C6-CNR-27115-5-X	03010914	63,0	115,0	27,0	88,0	1,9	25.000

Spare Parts, included in delivery

For holders	Clamp kit side	Clamp kit top	Coolant nozzle	Key, side clamp	Key, top clamp
C6...	W200613-T20P	W240618-T25P	CN6	T20P-7	T25P-7

Thread turning

MDT

Mini-Shaft™

Thread milling

Thread tapping

Annex

Seco-Capto™ – Toolholders for chasers, internal



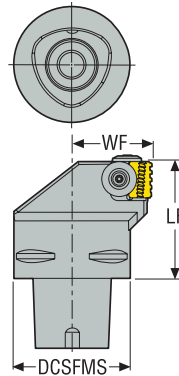
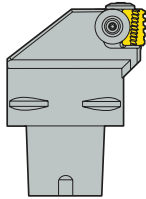

Snap-Tap®



- Left-hand version shown
- For inserts program, see page(s) 178, 179

Designation	Item number	DCSFMS	LF	WF	Weight	CTWS
		mm	mm	mm	kg	
C6-CNL-45065-1C-X	02995830	63,0	65,0	45,0	1,4	15.875
C6-CNL-45065-5C-X	02995832	63,0	65,0	45,0	1,4	25.000
C8-CNL-55080-1C-X	02995824	80,0	80,0	55,0	2,9	15.875
C8-CNL-55080-5C-X	02995826	80,0	80,0	55,0	2,9	25.000

Spare Parts, included in delivery

For holders	Clamp kit side	Clamp kit top	Coolant nozzle	Key, side clamp	Key, top clamp
C6/C8...	 W200613-T20P	 W240618-T25P	 CN6	 T20P-7	 T25P-7

Seco-Capto™ – Toolholders for chasers, internal

Snap-Tap®

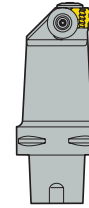
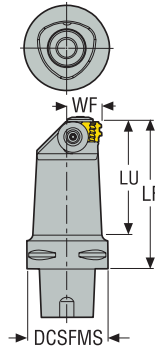

- Left-hand version shown
- For inserts program, see page(s) 178, 179

Designation	Item number	DCSFMS	LF	WF	LU	Weight	CTWS
		mm	mm	mm	mm	kg	
C6-CNL-27115-1C-X	03003766	63,0	115,0	27,0	88,0	1,9	15.875
C6-CNL-27115-5C-X	03010915	63,0	115,0	27,0	88,0	1,9	25.000

Spare Parts, included in delivery

For holders	Clamp kit side	Clamp kit top	Coolant nozzle	Key, side clamp	Key, top clamp
C6...	W200613-T20P	W240618-T25P	CN6	T20P-7	T25P-7

Thread turning

MDT

Mini-Shaft™

Thread milling

Thread tapping

Annex

Steadyline®, GL-heads – Toolholders for chasers, internal



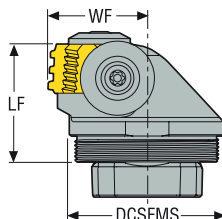
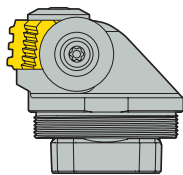







Snap-Tap®



- Right-hand version shown
- For inserts program, see page(s) 178, 179

Designation	Item number	DCSFMS	LF	WF	Weight	CTWS
		mm	mm	mm	kg	
GL50-CNR-32035-9-I	03011855	50,0	35,0	32,0	0,4	12.700
GL50-CNR-32038-1-X	03008525	50,0	38,0	32,0	0,4	15.875
GL50-CNR-32044-5-X	03008552	50,0	44,0	32,0	0,5	25.000
GL50-CNL-32035-9-I	03011856	50,0	35,0	32,0	0,5	12.700
GL50-CNL-32038-1-X	03008526	50,0	38,0	32,0	0,5	15.875
GL50-CNL-32044-5-X	03008553	50,0	44,0	32,0	0,5	25.000

Spare Parts, included in delivery

For holders	Clamp kit side	Clamp kit top	Key, clamp	Key, side clamp	Key, top clamp
...9-1	 W200613-T20P	 -	 T20P-2D	 -	 -
...1-X, ...5-X	 W200613-T20P	 W240618-T25P	 -	 T20P-2D	 T25P-7

Toolholders for Precision Axial Grooves

Snap-Tap®

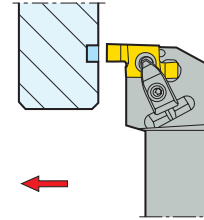
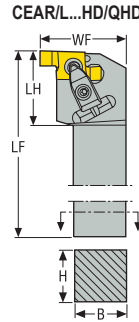
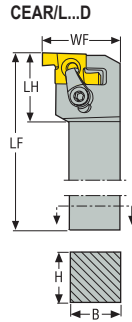

- Right-hand version shown
- For inserts program and INPLM, see catalog Turning

Designation	Item number	H	B	LF	WF 10../14../20..	WF2 12	LH 10../14..	INPLM 10../14../20..	INPLM2 12..	Weight	CTWS
		mm	mm	mm	mm	mm	mm	mm	mm	kg	
CEAR2525M10D	02411447	25,0	25,0	150,0	35,35	38,35	22,0	16,0	18,0	0,8	10../12..
CEAL2525M10D	02411448	25,0	25,0	150,0	35,35	38,35	22,0	16,0	18,0	0,8	10../12..
CEAR2525M14HD	02627517	25,0	25,0	150,0	36,85	–	31,0	22,0	–	0,8	14..
CEAL2525M14HD	02627516	25,0	25,0	150,0	36,85	–	31,0	22,0	–	0,8	14..
CEAR2525M20QHD	02528518	25,0	25,0	150,0	39,35	–	35,0	28,0	–	0,9	20..
CEAL2525M20QHD	02528519	25,0	25,0	150,0	39,35	–	35,0	28,0	–	0,9	20..

Spare Parts, included in delivery

For holders	Cantilever clamp	Clamp key	Clamp kit	Clamp screw	Insert shim (KL)	Insert shim (KR)	Shim screw	Spring
CEAR..10	–	T15P-2	CSP16-T15P	–	–	AKR10	CS2507-T07P	–
CEAL..10	–	T15P-2	CSP16-T15P	–	AKL10	–	CS2507-T07P	–
CEAR..14	CHD16	T15P-2	–	L85020-T15P	–	AKR14	CS3507-T09P	S6912
CEAL..14	CHD16	T15P-2	–	L85020-T15P	AKL14	–	CS3507-T09P	S6912
CEAR..20	CHD22	T20P-7	–	L86025-T20P	–	AKR20	CS4009-T15P	S7616
CEAL..20	CHD22	T20P-7	–	L86025-T20P	AKL20	–	CS4009-T15P	S7616

Accessories

For holders	Insert shim (K)	Shim key
CEAR..10	KX12-2	T07P-2
CEAL..10	KX12-2	T07P-2
CEAR..14	–	T09P-2
CEAL..14	–	T09P-2
CEAR..20	–	T15P-2
CEAL..20	–	T15P-2

Shim KX12-2 for insert 12..

Toolholders for Precision Axial Grooves

Snap-Tap®

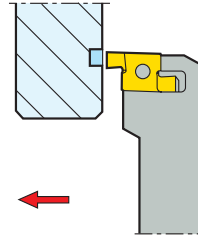
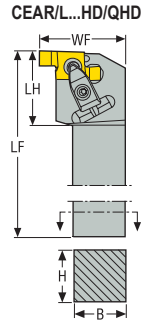
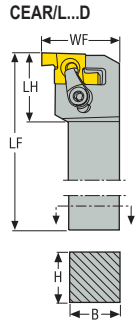

• For inserts program, see catalog Turning

Designation	Item number	H	B	LF	WF	LH	Weight	CTWS
		<i>Inch</i>	<i>Inch</i>	<i>Inch</i>	<i>Inch</i>	<i>Inch</i>	lbs	
CEAR1006-10	00072625	1.000	1.000	6.000	1.392	1.110	2.200	10 12EAR
CEAL1006-10	00072613	1.000	1.000	6.000	1.392	1.110	1.980	10 12EAL
CEAR1006-14	00072623	1.000	1.000	6.000	1.451	1.110	2.200	14EAR

Spare Parts, included in delivery

For size	Clamp key	Clamp kit	Insert shim	Insert shim (KL)	Insert shim (KR)	Shim key	Shim screw
CEAR...-10	T15P-2	CSP16-T15P	-	-	AKR10	-	CS2507-T07P
CEAL...-10	T15P-2	CSP16-T15P	-	AKL10	-	-	CS2507-T07P
CEAR...-14	T15P-2	CSP16-T15P	AKR14	-	-	T09P-2	CS3507-T09P

Accessories

For size	Insert shim (K)	Shim key
CEAR...-10	-	T07P-2
CEAL...-10	KX12-2	T07P-2
CEAR...-14	-	-

Toolholders for Precision Grooves

Snap-Tap®

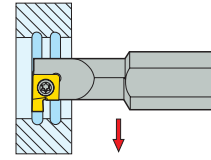
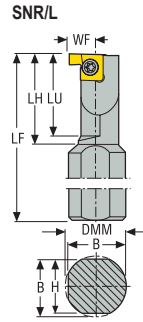
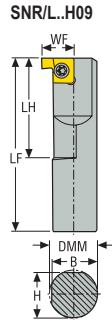

- Right-hand version shown
- For inserts program, see catalog Turning
- DCINN - minimum bore diameter

Designation	Item number	H	B	LF	WF	LH	LU	DMM	DCINN	Weight	CTWS
		mm	mm	mm	mm	mm	mm	mm	mm	kg	
SNR0010H9	75025330	9,5	9,5	100,0	7,5	20,0	-	10,0	14,0	0,1	9..
SNR0010K9	75025332	15,5	15,5	125,0	6,5	25,0	23,0	16,0	14,0	0,2	9..
SNR0013L9	75025334	15,5	15,5	140,0	8,0	32,0	30,0	16,0	17,0	0,2	9..
SNR0016M9	75025336	15,5	15,5	150,0	9,5	40,0	38,0	16,0	20,0	0,3	9..
SNL0010H9	75025331	9,5	9,5	100,0	7,5	20,0	-	10,0	14,0	0,1	9..
SNL0010K9	75025333	15,5	15,5	125,0	6,5	25,0	23,0	16,0	14,0	0,2	9..
SNL0013L9	75025335	15,5	15,5	140,0	8,0	32,0	30,0	16,0	17,0	0,2	9..
SNL0016M9	75025337	15,5	15,5	150,0	9,5	40,0	38,0	16,0	20,0	0,3	9..

Spare Parts, included in delivery

For holders	Insert key	Insert screw
..9	 T07P-2	 C02506-T07P

Thread turning

MDT

Mini-Shaft™

Thread milling

Thread tapping

Annex

Toolholders for Precision Grooves

Snap-Tap®

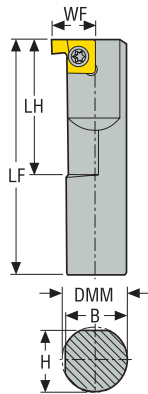
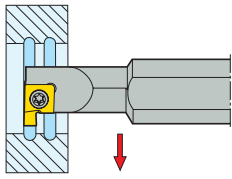

- Right-hand version shown
- For inserts program, see catalog Turning

Designation	Item number	H	B	DMM	LF	LH	WF	Weight	CTWS
		<i>Inch</i>	<i>Inch</i>	<i>Inch</i>	<i>Inch</i>	<i>Inch</i>	<i>Inch</i>	lbs	
SNR00037550-9	00072560	0.625	0.654	0.375	5.000	1.000	0.266	0.440	9..
SNR0005055-9	00072586	0.441	0.470	0.500	5.500	1.250	0.319	0.660	9..
SNR00062560-9	00072588	0.566	0.587	0.625	6.000	1.500	0.378	0.660	9..
SNL00037540-9	00072552	0.336	0.350	0.375	4.000	-	0.299	0.220	9..
SNL00037550-9	00072595	0.336	0.350	0.375	5.000	1.000	0.259	0.440	9..
SNR00037560-9-H	00072562	0.441	0.350	0.375	6.000	-	0.299	0.660	9..

Spare Parts, included in delivery

For size	Insert key	Insert screw
...9	 T07P-2	 C02506-T07P

Thread turning

MDT

Mini-Shaft™

Thread milling

Thread tapping

Annex

Toolholders for Precision Grooves

Snap-Tap®

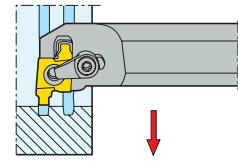
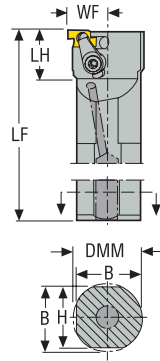

- Right-hand version shown
- For inserts program, see catalog Turning
- DCINN - minimum bore diameter
- WF (10../14../20../26..) = WF2 (12..)

Designation	Item number	H	B	LF	WF	WF2	LH	DMM	DCINN	DCINN2	Weight	CTWS
		mm	mm	mm	mm	mm	mm	mm	mm	mm	kg	
CNR0020P10DA	02411454	18,0	19,0	170,0	13,5	16,5	26,0	20,0	26,0	29,0	0,4	10../12..
CNR0025R10DA	02411459	23,0	24,0	200,0	16,0	19,0	28,0	25,0	31,0	34,0	0,7	10../12..
CNR0032S10DA	02411467	30,0	31,0	250,0	19,5	22,5	31,0	32,0	38,0	41,0	1,4	10../12..
CNL0020P10DA	02411456	18,0	19,0	170,0	13,5	16,5	26,0	20,0	26,0	29,0	0,4	10../12..
CNL0025R10DA	02411464	23,0	24,0	200,0	16,0	19,0	28,0	25,0	31,0	34,0	0,7	10../12..
CNL0032S10DA	02411468	30,0	31,0	250,0	19,5	22,5	31,0	32,0	38,0	41,0	1,4	10../12..
CNR0020P14A	00040041	18,0	19,0	170,0	15,0	-	32,0	20,0	30,0	-	0,4	14..
CNR0025R14A	00040042	23,0	24,0	200,0	17,5	-	45,0	25,0	34,0	-	0,7	14..
CNR0032S14A	00040043	30,0	31,0	250,0	21,0	-	48,0	32,0	40,0	-	1,4	14..
CNR0040T14A	00040044	37,0	38,5	300,0	25,0	-	50,0	40,0	48,0	-	2,6	14..
CNL0020P14A	00040045	18,0	19,0	170,0	15,0	-	32,0	20,0	30,0	-	0,4	14..
CNL0025R14A	00040046	23,0	24,0	200,0	17,5	-	45,0	25,0	34,0	-	0,7	14..
CNL0032S14A	00040047	30,0	31,0	250,0	21,0	-	48,0	32,0	40,0	-	1,4	14..

Spare Parts, included in delivery

For holders	Clamp key	Clamp kit	Insert shim (K)	Shim screw
..10	T15P-2	CSP16-T15P	KX10-2	CS2507-T07P
..14	T15P-2	CSP16-T15P	KX14-2	CS3507-T09P

Accessories

For holders	Insert shim (K)	Shim key
..10	KX12-2	T07P-2
..14	-	T09P-2

Shim KX12-2 for insert 12..

Toolholders for Precision Grooves

Snap-Tap®

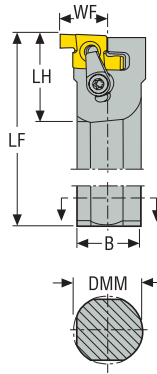
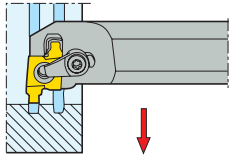

- Right-hand version shown
- For inserts program, see catalog Turning

Designation	Item number	H	B	LF	WF	LH	Weight	CTWS
		<i>Inch</i>	<i>Inch</i>	<i>Inch</i>	<i>Inch</i>	<i>Inch</i>	<i>lbs</i>	
CNR000757-10	00072573	0.691	0.707	7.000	0.490	1.480	1.100	10../12..
CNL000757-10	00072624	0.650	0.707	7.000	0.490	1.480	0.880	10../12..
CNR001008-10	00072569	0.921	0.957	8.000	0.618	2.500	1.760	10../12..
CNL001008-10	00072610	0.902	0.957	8.000	0.620	1.559	1.760	10../12..
CNR0012510-10	00072563	1.150	1.209	10.000	0.750	1.772	3.310	10../12..
CNR0015012-10	00072592	1.339	1.427	12.008	0.858	1.772	5.730	10../12..
CNR00075010-10-H	00072583	0.691	0.730	10.000	0.490	1.480	2.650	10../12..
CNR000757-14	00072571	0.691	0.707	7.000	0.570	1.693	0.880	14..
CNR001008-14	00072567	0.921	0.957	8.000	0.700	1.732	1.980	14..
CNL001008-14	00072582	1.000	0.961	8.000	0.704	-	1.760	14..
CNR0012510-14	00072561	1.150	1.209	10.000	0.831	1.969	3.530	-

Spare Parts, included in delivery

For size	Clamp key	Clamp kit	Insert shim (K)	Shim screw
..-10	T15P-2	CSP16-T15P	KX10-2	CS2507-T07P
..-10-10-H	T15P-2	CSP16-T15P	KX10-2	CS2507-T07P
..-14	T15P-2	CSP16-T15P	KX14-2	CS3507-T09P

Accessories

For size	Insert shim (K)	Shim key
..-10	KX12-2	T07P-2
..-10-10-H	-	T07P-2
..-14	-	-

Toolholders for Precision Grooves

Snap-Tap

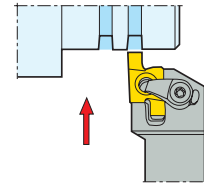
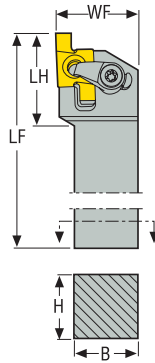

- Right-hand version shown
- For inserts program, see catalog Turning

Designation	Item number	H	B	LF	WF	LH	Weight	CTWS
		Inch	Inch	Inch	Inch	Inch		
CER0504-10Q	00072566	0.500	0.500	4.000	0.625	0.900	0.440	10../12..
CER0755-10Q	00072564	0.750	0.750	5.000	1.000	0.900	1.100	10../12..
CEL0755-10Q	00072559	0.750	0.750	5.000	1.000	0.900	1.100	10../12..
CER1006-10Q	00072600	1.000	1.000	6.000	1.250	0.900	1.980	10../12..
CEL1006-10Q	00072596	1.000	1.000	6.000	1.250	0.900	1.980	10../12..
CER1006-14Q	00072634	1.000	1.000	6.000	1.250	1.100	1.760	14..
CEL1006-14Q	00072628	1.000	1.000	6.000	1.250	1.100	1.980	14..

Spare Parts, included in delivery

For size	Clamp key	Clamp kit	Insert shim (K)	Shim screw
...				
...-10Q	T15P-2	CSP16-T15P	KX10-2	CS2507-T07P
R..-14Q	T15P-2	CSP16-T15P	KX14-2	CS3507-T09P
L..-14Q	T15P-2	CSP16-T15P	KX14-2	CS3507-T09P

Accessories

For size	Insert shim (K)	Shim key
...		
...-10Q	KX12-2	T07P-2
R..-14Q	-	T09P-2
L..-14Q	-	T09P-2

Thread turning

MDT

Mini-Shaft™

Thread milling

Thread tapping

Annex

Toolholders for Precision Grooves

Snap-Tap®

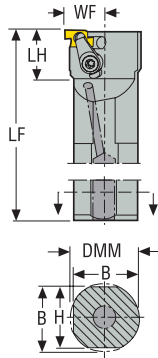
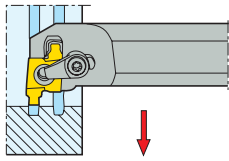

- Right-hand version shown
- For inserts program, see catalog Turning
- DCINN - minimum bore diameter
- WF (10../14../20../26..) = WF2 (12..)

Designation	Item number	DMM	H	B	LF	WF	LH	DCINN	DCINN2	Weight	CTWS
		Inch	Inch	Inch	Inch	Inch	Inch	Inch	Inch		
CNR001008-20AHD	02562823	1.000	0.902	0.957	7.992	0.705	1.969	1.400	-	1.540	20..
CNL001008-20AHD	02562826	1.000	0.902	0.957	7.992	0.705	1.969	1.400	-	1.540	20..
CNR0012510-20AHD	02562824	1.250	1.150	1.209	10.000	0.945	2.165	1.700	1.400	3.310	20..
CNL0012510-20AHD	02562827	1.250	1.150	1.209	10.000	0.945	2.165	1.700	1.400	3.310	20..
CNR0015012-20AHD	02562825	1.500	1.339	1.427	12.008	1.063	2.165	2.000	1.600	5.510	20..
CNL0015012-20AHD	02562828	1.500	1.339	1.427	12.008	1.063	2.165	2.000	1.600	5.510	20..
CNR0012510-26AHD	02562830	1.250	1.150	1.209	10.000	1.063	2.323	2.000	1.600	3.090	26..
CNL0012510-26AHD	02564043	1.250	1.150	1.209	10.000	1.063	2.323	2.000	1.600	3.090	26..
CNR0015012-26AHD	02562831	1.500	1.339	1.427	12.008	1.183	2.323	2.100	2.100	5.510	26..
CNL0015012-26AHD	02563555	1.500	1.339	1.427	12.008	1.177	2.323	2.100	2.100	5.510	26..
CNR0017514-26AHD	02562832	1.750	1.591	1.677	13.976	1.307	2.283	2.300	1.800	8.820	26..
CNL0017514-26AHD	02563563	1.750	1.591	1.677	13.976	1.307	2.283	2.300	1.800	8.820	26..
CNR0020014-26AHD	02562833	2.000	1.843	1.929	13.976	1.433	2.283	2.500	2.000	11.460	26..
CNR0025016-26AHD	02562834	2.500	2.343	2.429	15.984	1.683	2.283	3.000	2.500	20.720	26..
CNL0025016-26AHD	02563564	2.500	2.343	2.429	15.984	1.683	2.283	3.000	2.500	20.720	26..

Spare Parts, included in delivery

For holders	Cantilever clamp	Clamp key	Clamp screw	Insert shim (K)	Shim screw	Spring
..-20	CHD22	T20P-7	L86025-T20P	KX20-2	CS4009-T15P	S7616
..-26	CHD27	T20P-7	L86025-T20P	KX26-2	C05012-T15P	S7616

Accessories

For holders	Insert shim (K) 1	Insert shim (K) 2	Insert shim (K) 3	Insert shim (K) 4	Insert shim (K) 5	Insert shim (K) 6	Shim key
..-20	KX20-99	KX20-0	KX20-1	KX20-3	KX20-4	KX20-5	T15P-2
..-26	KX26-99	KX26-0	KX26-1	KX26-3	KX26-4	KX26-5	T15P-2

Thread turning

MDT

Mini-Shaft™

Thread milling

Thread tapping

Annex

Toolholders for Precision Grooves

Snap-Tap

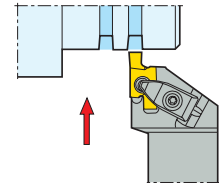
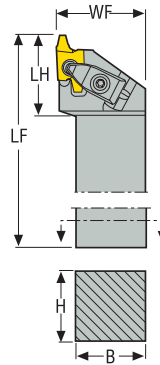

- Right-hand version shown
- For inserts program, see catalog Turning

Designation	Item number	H	B	LF	WF	LH	Weight	CTWS
		<i>Inch</i>	<i>Inch</i>	<i>Inch</i>	<i>Inch</i>	<i>Inch</i>	lbs	
CER1006-20QHD	02529045	1.000	1.000	6.000	1.250	1.300	1.980	20..
CEL1006-20QHD	02529053	1.000	1.000	6.000	1.250	1.300	1.980	20..
CER1256-20QHD	02529057	1.250	1.250	6.000	1.500	1.417	2.870	20..
CEL1256-20QHD	02529061	1.250	1.250	6.000	1.500	1.300	2.870	20..
CER1006-26QHD	02529063	1.000	1.000	6.000	1.250	1.800	2.200	26..
CEL1006-26QHD	02529064	1.000	1.000	6.000	1.250	1.800	2.200	26..
CER1256-26QHD	02529066	1.250	1.250	6.000	1.500	1.800	3.090	26..
CER1506-26QHD	02529069	1.500	1.500	6.000	1.750	1.800	3.970	26..

Spare Parts, included in delivery

For size	Cantilever clamp	Clamp key	Clamp screw	Insert shim (K)	Shim screw	Spring
...20Q	 CHD22	 T20P-7	 L86025-T20P	 KX20-2	 CS4009-T15P	 S7616
...26Q	 CHD27	 T20P-7	 L86025-T20P	 KX26-2	 C05012-T15P	 S7616

Accessories

For size	Insert shim (K) 1	Insert shim (K) 2	Insert shim (K) 3	Insert shim (K) 4	Insert shim (K) 5	Insert shim (K) 6	Shim key
...20	 KX20-99	 KX20-0	 KX20-1	 KX20-3	 KX20-4	 KX20-5	 T15P-2
...26	 KX26-99	 KX26-0	 KX26-1	 KX26-3	 KX26-4	 KX26-5	 T15P-2

Toolholders for Precision Grooves

Snap-Tap®

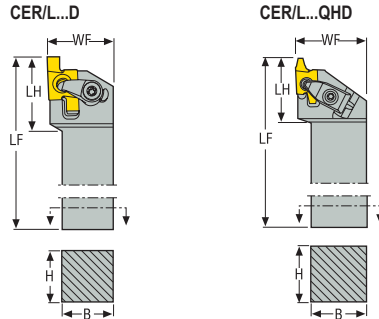

- Right-hand version shown
- For inserts program, see catalog Turning

Designation	Item number	H	B	LF 10../14..	LF2 12	WF	LH 10../14..	LH2 12	Weight	CTWS
		mm	mm	mm	mm	mm	mm	mm	kg	
CER1212M10D	02435850	12,0	12,0	150,0	153,0	16,0	21,5	24,5	0,2	10../12..
CER1616H10D	02411427	16,0	16,0	100,0	103,0	16,0	21,5	24,5	0,2	10../12..
CER2020K10D	02411428	20,0	20,0	125,0	128,0	25,0	21,5	24,5	0,4	10../12..
CER2525M10D	02411430	25,0	25,0	150,0	153,0	32,0	21,5	24,5	0,8	10../12..
CER3225P10D	02411432	32,0	25,0	170,0	173,0	32,0	22,5	25,5	1,1	10../12..
CEL1212M10D	02435852	12,0	12,0	150,0	153,0	16,0	21,5	24,5	0,2	10../12..
CEL1616H10D	02411436	16,0	16,0	100,0	103,0	16,0	21,5	24,5	0,2	10../12..
CEL2020K10D	02411437	20,0	20,0	125,0	128,0	25,0	21,5	24,5	0,4	10../12..
CEL2525M10D	02411438	25,0	25,0	150,0	153,0	32,0	21,5	24,5	0,8	10../12..
CEL3225P10D	02411440	32,0	25,0	170,0	173,0	32,0	22,5	25,5	1,1	10../12..
CER2525M14QHD	02538606	25,0	25,0	150,0	-	32,0	26,0	-	0,8	14..
CER3225P14QHD	02627519	32,0	25,0	170,0	-	32,0	26,0	-	1,1	14..
CER3232P14QHD	02627520	32,0	32,0	170,0	-	32,0	26,0	-	1,4	14..
CEL2525M14QHD	02627518	25,0	25,0	150,0	-	32,0	26,0	-	0,8	14..

Spare Parts, included in delivery

For holders	Cantilever clamp	Clamp key	Clamp kit	Clamp screw	Insert shim (K)	Shim screw	Spring
..10	-	T15P-2	CSP16-T15P	-	KX10-2	CS2507-T07P	-
..14	CHD16	T15P-2	-	L85020-T15P	KX14-2	CS3507-T09P	S6912

Accessories

For holders	Insert shim (K)	Insert shim (K) 1	Insert shim (K) 2	Insert shim (K) 3	Insert shim (K) 4	Insert shim (K) 5	Shim key
..10	KX12-2	-	-	-	-	-	T07P-2
..14	-	KX14-0	KX14-1	KX14-3	KX14-4	KX14-5	T09P-2

Shim KX12-2 for insert 12..

SCNN for peeling

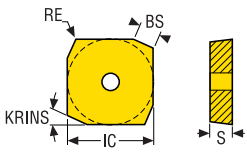

Designation	Note	RE	BS	IC	S	KRINS°	Grades Coated
		mm Inch	mm Inch	mm Inch	mm Inch		TP250T
SCNN250640-R25	*	4,0 0.157	6,2 0.244	25,0 0.984	6,35 0.250	23	■
SCNN250640-R30		4,0 0.157	6,6 0.260	25,0 0.984	6,35 0.250	28	■

* R25 for use in 25 degree pockets only - not the 30 degree - R30

■ Stock standard.

Thread turning

MDT

Mini-Shaft™

Thread milling

Thread tapping

Annex

Partial Profile 55° – External Threading

Snap-Tap®

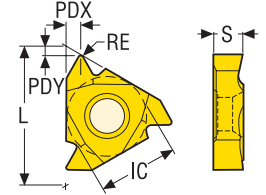
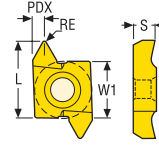
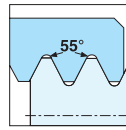

16ER..

16ER..A

16ER..A1

16ER..A2

16V55*

22ER..

26ER/26NR..



Insert Part No. Right	Pitch		RE	PDY	PDX	IC	W1	L	S	Grades				
										Coated				Uncoated
										CP200	CP300	CP500	TTP2050	
	mm	TPI	mm Inch	mm Inch	mm Inch	mm Inch	mm Inch	mm Inch	mm Inch					
16ERA55	0,5-1,5	48-16	0,08 0.003	0,6 0.024	0,8 0.031	9,525 0.375	–	16,5 0.650	3,47 0.137			■		
16ERAG55	0,5-3	48-8	0,08 0.003	1,1 0.043	1,5 0.059	9,525 0.375	–	16,5 0.650	3,47 0.137	■		■	■	■
16ERAG55-A	0,5-3	48-8	0,08 0.003	1,1 0.043	1,5 0.059	9,525 0.375	–	16,5 0.650	3,47 0.137			■	■	
16ERAG55-A1	0,5-3	48-8	0,08 0.003	1,1 0.043	1,5 0.059	9,525 0.375	–	16,5 0.650	3,47 0.137			■		
16ERAG55-A2	0,5-3	48-8	0,08 0.003	1,1 0.043	1,5 0.059	9,525 0.375	–	16,5 0.650	3,47 0.137			■		
16ERG55	1,75-3	14-8	0,2 0.008	1,1 0.043	1,5 0.059	9,525 0.375	–	16,5 0.650	3,47 0.137	■		■	■	
16ERG55-A	1,75-3	14-8	0,2 0.008	1,2 0.047	1,5 0.059	9,525 0.375	–	16,5 0.650	3,47 0.137			■	■	
16ERG55-A1	1,75-3	14-8	0,2 0.008	1,2 0.047	1,5 0.059	9,525 0.375	–	16,5 0.650	3,47 0.137			■		
16ERG55-A2	1,75-3	14-8	0,2 0.008	1,2 0.047	1,5 0.059	9,525 0.375	–	16,5 0.650	3,47 0.137			■		
22ERN55	3,5-5	7-5	0,4 0.016	1,8 0.071	2,5 0.098	12,7 0.500	–	22,0 0.866	4,71 0.185			■		■
26ERK55	5,5-10	4.5-2.5	0,7 0.028	–	5,0 0.197	–	15,875 0.625	26,0 1.024	7,88 0.310		■	■		
26NRK55	5,5-10	4.5-2.5	0,7 0.028	–	5,0 0.197	–	15,875 0.625	26,0 1.024	7,88 0.310			■		
16V55	–	–	–	–	–	–	–	–	–			■		

Insert Part No. Left	Pitch		RE	PDY	PDX	IC	W1	L	S	Grades				
										Coated				Uncoated
										CP200	CP300	CP500	TTP2050	
	mm	TPI	mm Inch	mm Inch	mm Inch	mm Inch	mm Inch	mm Inch	mm Inch					
16ELA55	0,5-1,5	48-16	0,08 0.003	0,6 0.024	0,8 0.031	9,525 0.375	–	16,5 0.650	3,47 0.137			■		
16ELAG55	0,5-3	48-8	0,08 0.003	1,1 0.043	1,5 0.059	9,525 0.375	–	16,5 0.650	3,47 0.137			■		
16ELG55	1,75-3	14-8	0,2 0.008	1,1 0.043	1,5 0.059	9,525 0.375	–	16,5 0.650	3,47 0.137			■		
22ELN55	3,5-5	7-5	0,4 0.016	1,8 0.071	2,5 0.098	12,7 0.500	–	22,0 0.866	4,71 0.185			■		

■ Stock standard.

* Toolset contents: 3 pcs 16ERG55, CP500, 3 pcs 16NRG55, CP500, 2 pcs 16ERA55, CP500 and 2 pcs 16NRA55, CP500

Thread turning

MDT

Mini-Shaft™

Thread milling

Thread tapping

Annex

Partial Profile 55° – Internal Threading

Snap-Tap®

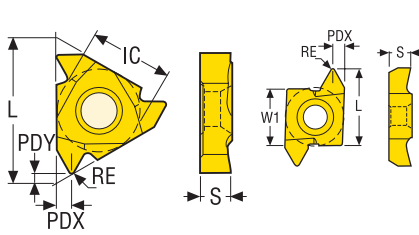

09NR/11Nx/16Nx/22Nx..



16NR..A



16NR..A1



16NR..A2



26ER/26NR..



Insert Part No. Right	Pitch		RE	PDY	PDX	IC	W1	L	S	Grades				
										Coated				Uncoated
										CP200	CP300	CP500	TTP2050	
	mm	TPI	mm Inch	mm Inch	mm Inch	mm Inch	mm Inch	mm Inch	mm Inch					
09NRA55	0,5-1,5	48-16	0,08 0.003	0,7 0.028	0,8 0.031	5,56 0.219	-	9,6 0.378	2,4 0.094			■		
11NRA55	0,5-1,5	48-16	0,08 0.003	0,6 0.024	0,8 0.031	6,35 0.250	-	11,0 0.433	3,0 0.118			■		■
16NRA55	0,5-1,5	48-16	0,08 0.003	0,6 0.024	0,8 0.031	9,525 0.375	-	16,5 0.650	3,47 0.137			■		■
16NRAG55	0,5-3	48-8	0,08 0.003	1,1 0.043	1,5 0.059	9,525 0.375	-	16,5 0.650	3,47 0.137	■		■	■	
16NRAG55-A	0,5-3	48-8	0,08 0.003	1,1 0.043	1,5 0.059	9,525 0.375	-	16,5 0.650	3,47 0.137			■	■	
16NRAG55-A1	0,5-3	48-8	0,08 0.003	1,1 0.043	1,5 0.059	9,525 0.375	-	16,5 0.650	3,47 0.137			■		
16NRAG55-A2	0,5-3	48-8	0,08 0.003	1,1 0.043	1,5 0.059	9,525 0.375	-	16,5 0.650	3,47 0.137			■		
16NRG55	1,75-3	14-8	0,2 0.008	1,1 0.043	1,5 0.059	9,525 0.375	-	16,5 0.650	3,47 0.137	■		■	■	
16NRG55-A	1,75-3	14-8	0,2 0.008	1,1 0.043	1,5 0.059	9,525 0.375	-	16,5 0.650	3,47 0.137			■	■	
16NRG55-A1	1,75-3	14-8	0,2 0.008	1,1 0.043	1,5 0.059	9,525 0.375	-	16,5 0.650	3,47 0.137			■		
16NRG55-A2	1,75-3	14-8	0,2 0.008	1,1 0.043	1,5 0.059	9,525 0.375	-	16,5 0.650	3,47 0.137			■		
22NRN55	3,5-5	7-5	0,4 0.016	1,8 0.071	2,5 0.098	12,7 0.500	-	22,0 0.866	4,71 0.185			■		■
26ERK55	5,5-10	4.5-2.5	0,7 0.028	-	5,0 0.197	-	15,875 0.625	26,0 1.024	7,88 0.310		■	■		

Insert Part No. Left	Pitch		RE	PDY	PDX	IC	W1	L	S	Grades				
										Coated				Uncoated
										CP200	CP300	CP500	TTP2050	
	mm	TPI	mm Inch	mm Inch	mm Inch	mm Inch	mm Inch	mm Inch	mm Inch					
11NLA55	0,5-1,5	48-16	0,08 0.003	0,6 0.024	0,8 0.031	6,35 0.250	-	11,0 0.433	3,0 0.118			■		
16NLA55	0,5-1,5	48-16	0,08 0.003	0,6 0.024	0,8 0.031	9,525 0.375	-	16,5 0.650	3,47 0.137			■		
16NLAG55	0,5-3	48-8	0,08 0.003	1,1 0.043	1,5 0.059	9,525 0.375	-	16,5 0.650	3,47 0.137			■		
16NLG55	1,75-3	14-8	0,2 0.008	1,1 0.043	1,5 0.059	9,525 0.375	-	16,5 0.650	3,47 0.137			■		
22NLN55	3,5-5	7-5	0,4 0.016	1,8 0.071	2,5 0.098	12,7 0.500	-	22,0 0.866	4,71 0.185			■		

■ Stock standard.

Partial Profile 60° – External Threading

Snap-Tap®

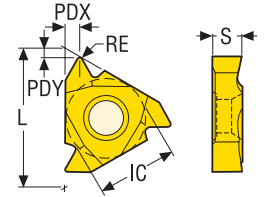
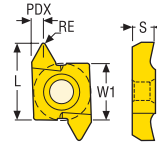
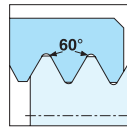

16ER..A



16ER..A1



16ER..A2



16Ex/22Ex..



16V60*



26ER/26NR



Insert Part No. Right	Pitch		RE	PDY	PDX	IC	W1	L	S	Grades				
										Coated				Uncoated
										CP200	CP300	CP500	TTP2050	H15
16ERA60	0,5-1,5	48-16	0,08 0.003	0,6 0.024	0,8 0.031	9,525 0.375	–	16,5 0.650	3,47 0.137	■		■	■	■
16ERA60-A	0,5-1,5	48-16	0,08 0.003	0,6 0.024	0,8 0.031	9,525 0.375	–	16,5 0.650	3,47 0.137			■	■	
16ERA60-A1	0,5-1,5	48-16	0,08 0.003	0,6 0.024	0,8 0.031	9,525 0.375	–	16,5 0.650	3,47 0.137			■		
16ERA60-A2	0,5-1,5	48-16	0,08 0.003	0,6 0.024	0,8 0.031	9,525 0.375	–	16,5 0.650	3,47 0.137			■		
16ERAG60-A	0,5-3	48-8	0,08 0.003	1,1 0.043	1,5 0.059	9,525 0.375	–	16,5 0.650	3,47 0.137			■	■	
16ERAG60-A1	0,5-3	48-8	0,08 0.003	1,1 0.043	1,5 0.059	9,525 0.375	–	16,5 0.650	3,47 0.137			■		
16ERAG60-A2	0,5-3	48-8	0,08 0.003	1,1 0.043	1,5 0.059	9,525 0.375	–	16,5 0.650	3,47 0.137			■		
16ERAG60	0,5-3	48-8	0,08 0.003	1,1 0.043	1,5 0.059	9,525 0.375	–	16,5 0.650	3,47 0.137	■		■	■	■
16ERG60	1,75-3	14-8	0,18 0.007	1,1 0.043	1,5 0.059	9,525 0.375	–	16,5 0.650	3,47 0.137	■		■	■	■
16ERG60-A	1,75-3	14-8	0,18 0.007	1,2 0.047	1,5 0.059	9,525 0.375	–	16,5 0.650	3,47 0.137			■	■	
16ERG60-A1	1,75-3	14-8	0,18 0.007	1,2 0.047	1,5 0.059	9,525 0.375	–	16,5 0.650	3,47 0.137			■		
16ERG60-A2	1,75-3	14-8	0,18 0.007	1,2 0.047	1,5 0.059	9,525 0.375	–	16,5 0.650	3,47 0.137			■		
22ERN60	3,5-5	7-5	0,4 0.016	1,8 0.071	2,5 0.098	12,7 0.500	–	22,0 0.866	4,71 0.185	■	■	■		■
26ERK60	5,5-10	4.5-2.5	0,4 0.016	–	5,0 0.197	–	15,875 0.625	26,0 1.024	7,88 0.310		■	■		
26NRK60	5,5-10	4.5-2.5	0,4 0.016	–	5,0 0.197	–	15,875 0.625	26,0 1.024	7,88 0.310		■	■		
16V60	–	–	–	–	–	–	–	–	–			■		

■ Stock standard.

* Toolset contents: 3 pcs 16ERG60, CP500, 3 pcs 16NRG60, CP500, 2 pcs 16ERA60, CP500 and 2 pcs 16NRA60, CP500

Insert Part No. Left	Pitch		RE	PDY	PDX	IC	W1	L	S	Grades				
										Coated				Uncoated
										CP200	CP300	CP500	TTP2050	H15
16ELA60	0,5-1,5	48-16	0,08 0.003	0,6 0.024	0,8 0.031	9,525 0.375	–	16,5 0.650	3,47 0.137			■		
16ELAG60	0,5-3	48-8	0,08 0.003	1,1 0.043	1,5 0.059	9,525 0.375	–	16,5 0.650	3,47 0.137			■		

Thread turning											Grades				
	Insert Part No. Left	Pitch		RE	PDY	PDX	IC	W1	L	S	Coated				Uncoated
		mm	TPI	mm Inch	mm Inch	mm Inch	mm Inch	mm Inch	mm Inch	mm Inch	CP200	CP300	CP500	TTP2050	H15
16ELG60	1,75-3	8-14	0,18 0.007	1,1 0.043	1,5 0.059	9,525 0.375	– –	16,5 0.650	3,47 0.137			■			
22ELN60	3,5-5	5-7	0,4 0.016	1,8 0.071	2,5 0.098	12,7 0.500	– –	22,0 0.866	4,71 0.185			■			

■ Stock standard.

MDT

Mini-Shaft™

Thread milling

Thread tapping

Annex

Partial Profile 60° – Internal Threading

Snap-Tap®

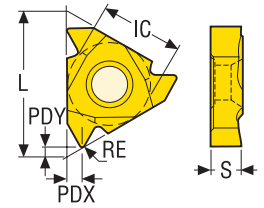
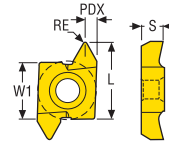
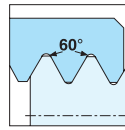

11NR/16NR..A



11NR/16NR..A1



11NR/16NR..A2



26ER/26NR



Insert Part No. Right	Pitch		RE	PDY	PDX	IC	W1	L	S	Grades				
										Coated				Uncoated
										CP200	CP300	CP500	TTP2050	H15
09NRA60	0,5-1,5	48-16	0,08 0.003	0,7 0.028	0,8 0.031	5,56 0.219	–	9,6 0.378	2,4 0.094			■		
11NRA60	0,5-1,5	48-16	0,08 0.003	0,7 0.028	0,8 0.031	6,35 0.250	–	11,0 0.433	3,0 0.118	■		■	■	■
16NRA60	0,5-1,5	48-16	0,08 0.003	0,7 0.028	0,8 0.031	9,525 0.375	–	16,5 0.650	3,47 0.137			■		■
11NRA60-A	0,5-1,5	48-16	0,08 0.003	0,7 0.028	0,8 0.031	6,35 0.250	–	11,0 0.433	3,0 0.118			■	■	
11NRA60-A1	0,5-1,5	48-16	0,08 0.003	0,7 0.028	0,8 0.031	6,35 0.250	–	11,0 0.433	3,0 0.118			■		
11NRA60-A2	0,5-1,5	48-16	0,08 0.003	0,7 0.028	0,8 0.031	6,35 0.250	–	11,0 0.433	3,0 0.118			■		
16NRAG60	0,5-3	48-8	0,08 0.003	1,1 0.043	1,5 0.059	9,525 0.375	–	16,5 0.650	3,47 0.137	■		■	■	■
16NRAG60-A	0,5-3	48-8	0,08 0.003	1,1 0.043	1,5 0.059	9,525 0.375	–	16,5 0.650	3,47 0.137			■	■	
16NRAG60-A1	0,5-3	48-8	0,08 0.003	1,1 0.043	1,5 0.059	9,525 0.375	–	16,5 0.650	3,47 0.137			■		
16NRAG60-A2	0,5-3	48-8	0,08 0.003	1,1 0.043	1,5 0.059	9,525 0.375	–	16,5 0.650	3,47 0.137			■		
16NRG60	1,75-3	14-8	0,12 0.005	1,1 0.043	1,5 0.059	9,525 0.375	–	16,5 0.650	3,47 0.137	■		■	■	■
16NRG60-A	1,75-3	14-8	0,12 0.005	1,2 0.047	1,5 0.059	9,525 0.375	–	16,5 0.650	3,47 0.137			■	■	
16NRG60-A1	1,75-3	14-8	0,12 0.005	1,2 0.047	1,5 0.059	9,525 0.375	–	16,5 0.650	3,47 0.137			■		
16NRG60-A2	1,75-3	14-8	0,12 0.005	1,2 0.047	1,5 0.059	9,525 0.375	–	16,5 0.650	3,47 0.137			■		
22NRN60	3,5-5	7-5	0,25 0.010	1,8 0.071	2,5 0.098	12,7 0.500	–	22,0 0.866	4,71 0.185	■	■	■		■
26NRK60	5,5-10	4.5-2.5	0,4 0.016	–	5,0 0.197	–	15,875 0.625	26,0 1.024	7,88 0.310		■	■		
26ERK60	5,5-10	4.5-2.5	0,4 0.016	–	5,0 0.197	–	15,875 0.625	26,0 1.024	7,88 0.310		■	■		

Insert Part No. Left	Pitch		RE	PDY	PDX	IC	W1	L	S	Grades				
										Coated				Uncoated
										CP200	CP300	CP500	TTP2050	H15
11NLA60	0,5-1,5	48-16	0,08 0.003	0,7 0.028	0,8 0.031	6,35 0.250	–	11,0 0.433	3,0 0.118			■		
16NLA60	0,5-1,5	48-16	0,08 0.003	0,7 0.028	0,8 0.031	9,525 0.375	–	16,5 0.650	3,47 0.137			■		

Thread turning
MDT
Mini-Shaft™
Thread milling
Thread tapping
Annex

Thread turning											Grades				
	Insert Part No. Left	Pitch		RE	PDY	PDX	IC	W1	L	S	Coated				Uncoated
		mm	TPI	mm Inch	mm Inch	mm Inch	mm Inch	mm Inch	mm Inch	mm Inch	CP200	CP300	CP500	TTP2050	H15
16NLAG60	0,5-3	48-8	0,08 0.003	1,1 0.043	1,5 0.059	9,525 0.375	-	16,5 0.650	3,47 0.137			■			
16NLG60	1,75-3	14-8	0,12 0.005	1,1 0.043	1,5 0.059	9,525 0.375	-	16,5 0.650	3,47 0.137			■			
22NLN60	3,5-5	7-5	0,25 0.010	1,8 0.071	2,5 0.098	12,7 0.500	-	22,0 0.866	4,71 0.185			■			

■ Stock standard.

MDT

Mini-Shaft™

Thread milling

Thread tapping

Annex

ISO Metric – External Threading

Snap-Tap®

ISO965/1 - 1980
3h/4h

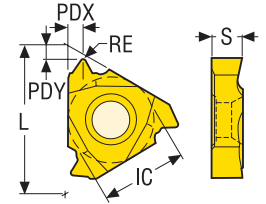
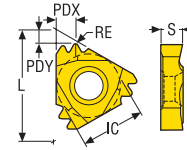
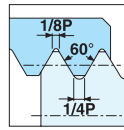

16ER/22ER/27ER..M



16ER..A



16ER..A1



16ER..A2



16ER..TT



16Ex/22Ex/27ER



Insert Part No. Right	Pitch	RE	PDY	PDX	IC	L	S	Grades					
								Coated				Uncoated	
								CP200	CP300	CP500	TTP2050	H15	
mm	TPI	mm Inch	mm Inch	mm Inch	mm Inch	mm Inch	mm Inch						
16ER0.5ISO	0,5	-	0,06 0.002	0,8 0.031	0,8 0.031	9,525 0.375	16,5 0.650	3,47 0.137			■		■
16ER0.75ISO	0,75	-	0,11 0.004	0,8 0.031	0,8 0.031	9,525 0.375	16,5 0.650	3,47 0.137			■		■
16ER0.8ISO	0,8	-	0,11 0.004	0,8 0.031	0,6 0.024	9,525 0.375	16,5 0.650	3,47 0.137			■		
16ER1.0ISO	1	-	0,14 0.006	0,8 0.031	0,8 0.031	9,525 0.375	16,5 0.650	3,47 0.137	■		■	■	■
16ER1.0ISO-A	1	-	0,14 0.006	0,8 0.031	0,8 0.031	9,525 0.375	16,5 0.650	3,47 0.137			■	■	
16ER1.0ISO-A1	1	-	0,14 0.006	0,8 0.031	0,8 0.031	9,525 0.375	16,5 0.650	3,47 0.137			■		
16ER1.0ISO-A2	1	-	0,14 0.006	0,8 0.031	0,8 0.031	9,525 0.375	16,5 0.650	3,47 0.137			■		
16ER1.0ISO-TT	1	-	0,14 0.006	1,3 0.051	1,3 0.051	9,525 0.375	16,5 0.650	3,47 0.137			■		
16ER1.0ISO3M	1	-	0,14 0.006	1,5 0.059	2,4 0.094	9,525 0.375	16,5 0.650	3,47 0.137			■		
16ER1.25ISO	1,25	-	0,17 0.007	0,8 0.031	0,8 0.031	9,525 0.375	16,5 0.650	3,47 0.137	■		■	■	■
16ER1.25ISO-A	1,25	-	0,17 0.007	0,8 0.031	0,8 0.031	9,525 0.375	16,5 0.650	3,47 0.137			■	■	
16ER1.25ISO-A1	1,25	-	0,17 0.007	0,8 0.031	0,8 0.031	9,525 0.375	16,5 0.650	3,47 0.137			■		
16ER1.25ISO-A2	1,25	-	0,17 0.007	0,8 0.031	0,8 0.031	9,525 0.375	16,5 0.650	3,47 0.137			■		
16ER1.5ISO	1,5	-	0,22 0.009	0,8 0.031	0,8 0.031	9,525 0.375	16,5 0.650	3,47 0.137	■		■	■	■
16ER1.5ISO-A	1,5	-	0,22 0.009	0,8 0.031	0,8 0.031	9,525 0.375	16,5 0.650	3,47 0.137			■	■	
16ER1.5ISO-A1	1,5	-	0,22 0.009	0,8 0.031	0,8 0.031	9,525 0.375	16,5 0.650	3,47 0.137			■		
16ER1.5ISO-A2	1,5	-	0,22 0.009	0,8 0.031	0,8 0.031	9,525 0.375	16,5 0.650	3,47 0.137			■		
16ER1.5ISO-TT	1,5	-	0,22 0.009	1,3 0.051	1,8 0.071	9,525 0.375	16,5 0.650	3,47 0.137			■		
16ER1.5ISO2M	1,5	-	0,22 0.009	1,5 0.059	2,2 0.087	9,525 0.375	16,5 0.650	3,47 0.137			■		
22ER1.5ISO3M	1,5	-	0,22 0.009	2,3 0.091	3,6 0.142	12,7 0.500	22,0 0.866	4,71 0.185			■		
16ER1.75ISO	1,75	-	0,25 0.010	1,2 0.047	1,5 0.059	9,525 0.375	16,5 0.650	3,47 0.137	■		■	■	■
16ER1.75ISO-A	1,75	-	0,25 0.010	1,2 0.047	1,5 0.059	9,525 0.375	16,5 0.650	3,47 0.137			■	■	

Thread turning

MDT

Mini-Shaft™

Thread milling

Thread tapping

Annex

	Insert Part No. Right									Grades				
	Pitch		RE	PDY	PDX	IC	L	S	Coated				Uncoated	
	mm	TPI	mm Inch	mm Inch	mm Inch	mm Inch	mm Inch	mm Inch	CP200	CP300	CP500	TTP2050	H15	
Thread turning	16ER1.75ISO-A1	1,75	-	0,25 0.010	1,2 0.047	1,5 0.059	9,525 0.375	16,5 0.650	3,47 0.137			■		
	16ER1.75ISO-A2	1,75	-	0,25 0.010	1,2 0.047	1,5 0.059	9,525 0.375	16,5 0.650	3,47 0.137			■		
MDT	16ER2.0ISO	2	-	0,29 0.011	1,2 0.047	1,5 0.059	9,525 0.375	16,5 0.650	3,47 0.137	■		■	■	■
	16ER2.0ISO-A	2	-	0,29 0.011	1,2 0.047	1,5 0.059	9,525 0.375	16,5 0.650	3,47 0.137			■	■	
	16ER2.0ISO-A1	2	-	0,29 0.011	1,2 0.047	1,5 0.059	9,525 0.375	16,5 0.650	3,47 0.137			■		
	16ER2.0ISO-A2	2	-	0,29 0.011	1,2 0.047	1,5 0.059	9,525 0.375	16,5 0.650	3,47 0.137			■		
	16ER2.0ISO-TT	2	-	0,29 0.011	1,6 0.063	2,4 0.094	9,525 0.375	16,5 0.650	3,47 0.137			■		
	22ER2.0ISO2M	2	-	0,29 0.011	2,0 0.079	2,9 0.114	12,7 0.500	22,0 0.866	4,71 0.185			■		
	22ER2.0ISO3M	2	-	0,29 0.011	3,0 0.118	4,8 0.189	12,7 0.500	22,0 0.866	4,71 0.185			■		
Mini-Shaft™	16ER2.5ISO	2,5	-	0,34 0.013	1,2 0.047	1,5 0.059	9,525 0.375	16,5 0.650	3,47 0.137	■		■	■	■
	16ER2.5ISO-A	2,5	-	0,34 0.013	1,2 0.047	1,5 0.059	9,525 0.375	16,5 0.650	3,47 0.137			■	■	
	16ER2.5ISO-A1	2,5	-	0,34 0.013	1,2 0.047	1,5 0.059	9,525 0.375	16,5 0.650	3,47 0.137			■		
	16ER2.5ISO-A2	2,5	-	0,34 0.013	1,2 0.047	1,5 0.059	9,525 0.375	16,5 0.650	3,47 0.137			■		
Thread milling	16ER3.0ISO	3	-	0,42 0.017	1,2 0.047	1,5 0.059	9,525 0.375	16,5 0.650	3,47 0.137	■		■	■	■
	16ER3.0ISO-A	3	-	0,42 0.017	1,2 0.047	1,5 0.059	9,525 0.375	16,5 0.650	3,47 0.137			■	■	
	16ER3.0ISO-A1	3	-	0,42 0.017	1,2 0.047	1,5 0.059	9,525 0.375	16,5 0.650	3,47 0.137			■		
	16ER3.0ISO-A2	3	-	0,42 0.017	1,2 0.047	1,5 0.059	9,525 0.375	16,5 0.650	3,47 0.137			■		
	27ER3.0ISO2M	3	-	0,42 0.017	2,8 0.110	4,3 0.169	15,875 0.625	27,0 1.063	6,15 0.242			■		
Thread tapping	22ER3.5ISO	3,5	-	0,47 0.019	1,8 0.071	2,5 0.098	12,7 0.500	22,0 0.866	4,71 0.185	■	■	■		■
	22ER4.0ISO	4	-	0,53 0.021	1,8 0.071	2,5 0.098	12,7 0.500	22,0 0.866	4,71 0.185	■	■	■		■
	22ER4.5ISO	4,5	-	0,59 0.023	1,8 0.071	2,5 0.098	12,7 0.500	22,0 0.866	4,71 0.185			■		■
	22ER5.0ISO	5	-	0,66 0.026	1,8 0.071	2,5 0.098	12,7 0.500	22,0 0.866	4,71 0.185	■		■		■
	27ER5.5ISO	5,5	-	0,72 0.028	2,2 0.087	3,2 0.126	15,875 0.625	27,0 1.063	6,15 0.242			■		
	27ER6.0ISO	6	-	0,79 0.031	2,2 0.087	3,2 0.126	15,875 0.625	27,0 1.063	6,15 0.242		■	■		
Annex	Insert Part No. Left									Grades				
	Pitch		RE	PDY	PDX	IC	L	S	Coated				Uncoated	
	mm	TPI	mm Inch	mm Inch	mm Inch	mm Inch	mm Inch	mm Inch	CP200	CP300	CP500	TTP2050	H15	
	16EL0.5ISO	0,5	-	0,06 0.002	0,8 0.031	0,8 0.031	9,525 0.375	16,5 0.650	3,47 0.137			■		
16EL0.75ISO	0,75	-	0,09 0.004	0,8 0.031	0,8 0.031	9,525 0.375	16,5 0.650	3,47 0.137			■			
16EL0.8ISO	0,8	-	0,11 0.004	0,8 0.031	0,8 0.031	9,525 0.375	16,5 0.650	3,47 0.137			■			

Insert Part No. Left	Pitch		RE	PDY	PDX	IC	L	S	Grades				
									Coated				Uncoated
									CP200	CP300	CP500	TTP2050	H15
mm	TPI	mm Inch	mm Inch	mm Inch	mm Inch	mm Inch	mm Inch						
16EL1.0ISO	1	-	0,12 0.005	0,8 0.031	0,8 0.031	9,525 0.375	16,5 0.650	3,47 0.137			■		
16EL1.25ISO	1,25	-	0,15 0.006	0,8 0.031	0,8 0.031	9,525 0.375	16,5 0.650	3,47 0.137			■		
16EL1.5ISO	1,5	-	0,22 0.009	0,8 0.031	0,8 0.031	9,525 0.375	16,5 0.650	3,47 0.137		■	■		
16EL1.75ISO	1,75	-	0,22 0.009	1,2 0.047	1,5 0.059	9,525 0.375	16,5 0.650	3,47 0.137			■		
16EL2.0ISO	2	-	0,29 0.011	1,2 0.047	1,5 0.059	9,525 0.375	16,5 0.650	3,47 0.137			■		
16EL2.5ISO	2,5	-	0,31 0.012	1,2 0.047	1,5 0.059	9,525 0.375	16,5 0.650	3,47 0.137			■		
16EL3.0ISO	3	-	0,42 0.017	1,2 0.047	1,5 0.059	9,525 0.375	16,5 0.650	3,47 0.137			■		
22EL3.5ISO	3,5	-	0,47 0.019	1,8 0.071	2,5 0.098	12,7 0.500	22,0 0.866	4,71 0.185			■		
22EL4.0ISO	4	-	0,53 0.021	1,8 0.071	2,5 0.098	12,7 0.500	22,0 0.866	4,71 0.185			■		
22EL4.5ISO	4,5	-	0,59 0.023	1,8 0.071	2,5 0.098	12,7 0.500	22,0 0.866	4,71 0.185			■		
22EL5.0ISO	5	-	0,66 0.026	1,8 0.071	2,5 0.098	12,7 0.500	22,0 0.866	4,71 0.185			■		

■ Stock standard.

Thread turning
MDT
Mini-Shaft™
Thread milling
Thread tapping
Annex

ISO Metric – Internal Threading

Snap-Tap®

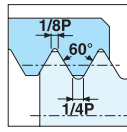
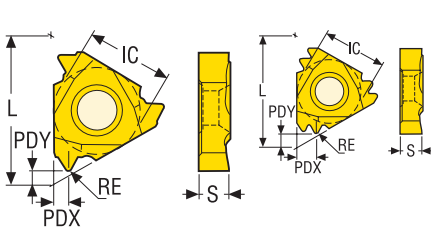

ISO965/1 - 1980
3h/4h

09NR/11Nx/16Nx/22Nx/27NR



11NR/16NR..A



11NR/16NR..A1



11NR/16NR..A2



16NR/22NR..M



16NR..TT



Insert Part No. Right	Pitch		RE	PDY	PDX	IC	L	S	Grades				
	mm	TPI							Coated				Uncoated
									CP200	CP300	CP500	TTP2050	
09NR0.5ISO	0,5	-	0,04 0.002	0,7 0.028	0,6 0.024	5,56 0.219	9,6 0.378	2,4 0.094			■		
11NR0.5ISO	0,5	-	0,03 0.001	0,8 0.031	0,8 0.031	6,35 0.250	11,0 0.433	3,0 0.118			■		■
16NR0.5ISO	0,5	-	0,03 0.001	0,8 0.031	0,8 0.031	9,525 0.375	16,5 0.650	3,47 0.137			■		■
11NR0.75ISO	0,75	-	0,04 0.002	0,8 0.031	0,8 0.031	6,35 0.250	11,0 0.433	3,0 0.118			■		■
16NR0.75ISO	0,75	-	0,04 0.002	0,8 0.031	0,8 0.031	9,525 0.375	16,5 0.650	3,47 0.137			■		■
09NR0.8ISO	0,8	-	0,07 0.003	0,7 0.028	0,6 0.024	5,56 0.219	9,6 0.378	2,4 0.094			■		
09NR1.0ISO	1	-	0,07 0.003	0,7 0.028	0,8 0.031	5,56 0.219	9,6 0.378	2,4 0.094			■		
11NR1.0ISO	1	-	0,08 0.003	0,8 0.031	0,8 0.031	6,35 0.250	11,0 0.433	3,0 0.118	■		■	■	■
16NR1.0ISO	1	-	0,08 0.003	0,8 0.031	0,8 0.031	9,525 0.375	16,5 0.650	3,47 0.137	■		■	■	■
11NR1.0ISO-A	1	-	0,08 0.003	0,8 0.031	0,8 0.031	6,35 0.250	11,0 0.433	3,0 0.118			■	■	
16NR1.0ISO-A	1	-	0,09 0.004	0,8 0.031	0,8 0.031	9,525 0.375	16,5 0.650	3,47 0.137			■	■	
11NR1.0ISO-A1	1	-	0,08 0.003	0,8 0.031	0,8 0.031	6,35 0.250	11,0 0.433	3,0 0.118			■		
16NR1.0ISO-A1	1	-	0,09 0.004	0,8 0.031	0,8 0.031	9,525 0.375	16,5 0.650	3,47 0.137			■		
11NR1.0ISO-A2	1	-	0,08 0.003	0,8 0.031	0,8 0.031	6,35 0.250	11,0 0.433	3,0 0.118			■		
16NR1.0ISO-A2	1	-	0,09 0.004	0,8 0.031	0,8 0.031	9,525 0.375	16,5 0.650	3,47 0.137			■		
16NR1.0ISO-TT	1	-	0,09 0.004	1,3 0.051	1,2 0.047	9,525 0.375	16,5 0.650	3,47 0.137			■		
16NR1.0ISO3M	1	-	0,08 0.003	1,5 0.059	2,4 0.094	9,525 0.375	16,5 0.650	3,47 0.137			■		
09NR1.25ISO	1,25	-	0,11 0.004	0,7 0.028	0,8 0.031	5,56 0.219	9,6 0.378	2,4 0.094			■		
11NR1.25ISO	1,25	-	0,09 0.004	0,8 0.031	0,8 0.031	6,35 0.250	11,0 0.433	3,0 0.118			■		■
16NR1.25ISO	1,25	-	0,09 0.004	0,8 0.031	0,8 0.031	9,525 0.375	16,5 0.650	3,47 0.137	■		■		■
09NR1.5ISO	1,5	-	0,12 0.005	0,7 0.028	0,8 0.031	5,56 0.219	9,6 0.378	2,4 0.094			■		

Thread turning

MDT

Mini-Shaft™

Thread milling

Thread tapping

Annex

Insert Part No. Right	Pitch		RE	PDY	PDX	IC	L	S	Grades					
									Coated				Uncoated	
									CP200	CP300	CP500	TTP2050	H15	
mm	TPI	mm Inch	mm Inch	mm Inch	mm Inch	mm Inch	mm Inch	mm Inch						
11NR1.5ISO	1,5	-	0,12 0.005	0,8 0.031	0,8 0.031	6,35 0.250	11,0 0.433	3,0 0.118	■		■	■	■	■
16NR1.5ISO	1,5	-	0,12 0.005	0,8 0.031	0,8 0.031	9,525 0.375	16,5 0.650	3,47 0.137	■		■	■	■	■
11NR1.5ISO-A	1,5	-	0,12 0.005	0,8 0.031	0,8 0.031	6,35 0.250	11,0 0.433	3,0 0.118			■	■		
16NR1.5ISO-A	1,5	-	0,12 0.005	0,8 0.031	0,8 0.031	9,525 0.375	16,5 0.650	3,47 0.137			■	■		
11NR1.5ISO-A1	1,5	-	0,12 0.005	0,8 0.031	0,8 0.031	6,35 0.250	11,0 0.433	3,0 0.118			■			
16NR1.5ISO-A1	1,5	-	0,12 0.005	0,8 0.031	0,8 0.031	9,525 0.375	16,5 0.650	3,47 0.137			■			
11NR1.5ISO-A2	1,5	-	0,12 0.005	0,8 0.031	0,8 0.031	6,35 0.250	11,0 0.433	3,0 0.118			■			
16NR1.5ISO-A2	1,5	-	0,12 0.005	0,8 0.031	0,8 0.031	9,525 0.375	16,5 0.650	3,47 0.137			■			
16NR1.5ISO-TT	1,5	-	0,12 0.005	1,3 0.051	1,8 0.071	9,525 0.375	16,5 0.650	3,47 0.137			■			
16NR1.5ISO2M	1,5	-	0,12 0.005	1,4 0.055	2,1 0.083	9,525 0.375	16,5 0.650	3,47 0.137			■			
22NR1.5ISO3M	1,5	-	0,12 0.005	2,3 0.091	3,6 0.142	12,7 0.500	22,0 0.866	4,71 0.185			■			
09NR1.75ISO	1,75	-	0,12 0.005	0,7 0.028	0,8 0.031	5,56 0.219	9,6 0.378	2,4 0.094			■			
11NR1.75ISO	1,75	-	0,12 0.005	0,8 0.031	0,8 0.031	6,35 0.250	11,0 0.433	3,0 0.118			■		■	
16NR1.75ISO	1,75	-	0,12 0.005	1,2 0.047	1,5 0.059	9,525 0.375	16,5 0.650	3,47 0.137			■		■	
09NR2.0ISO	2	-	0,17 0.007	0,7 0.028	0,9 0.035	5,56 0.219	9,6 0.378	2,4 0.094			■			
11NR2.0ISO	2	-	0,17 0.007	0,8 0.031	0,9 0.035	6,35 0.250	11,0 0.433	3,0 0.118	■		■	■	■	■
16NR2.0ISO	2	-	0,17 0.007	1,2 0.047	1,5 0.059	9,525 0.375	16,5 0.650	3,47 0.137	■		■	■	■	■
11NR2.0ISO-A	2	-	0,17 0.007	0,8 0.031	0,9 0.035	6,35 0.250	11,0 0.433	3,0 0.118			■	■		
16NR2.0ISO-A	2	-	0,16 0.006	1,2 0.047	1,5 0.059	9,525 0.375	16,5 0.650	3,47 0.137			■	■		
11NR2.0ISO-A1	2	-	0,17 0.007	0,8 0.031	0,9 0.035	6,35 0.250	11,0 0.433	3,0 0.118			■			
16NR2.0ISO-A1	2	-	0,16 0.006	1,2 0.047	1,5 0.059	9,525 0.375	16,5 0.650	3,47 0.137			■			
11NR2.0ISO-A2	2	-	0,17 0.007	0,8 0.031	0,9 0.035	6,35 0.250	11,0 0.433	3,0 0.118			■			
16NR2.0ISO-A2	2	-	0,16 0.006	1,2 0.047	1,5 0.059	9,525 0.375	16,5 0.650	3,47 0.137			■			
16NR2.0ISO-TT	2	-	0,18 0.007	1,6 0.063	2,4 0.094	9,525 0.375	16,5 0.650	3,47 0.137			■			
22NR2.0ISO2M	2	-	0,17 0.007	2,0 0.079	2,9 0.114	12,7 0.500	22,0 0.866	4,71 0.185			■			
22NR2.0ISO3M	2	-	0,17 0.007	3,0 0.118	4,8 0.189	12,7 0.500	22,0 0.866	4,71 0.185			■			
16NR2.5ISO	2,5	-	0,18 0.007	1,2 0.047	1,5 0.059	9,525 0.375	16,5 0.650	3,47 0.137	■		■	■	■	■
16NR2.5ISO-A	2,5	-	0,18 0.007	1,2 0.047	1,5 0.059	9,525 0.375	16,5 0.650	3,47 0.137			■	■		
16NR2.5ISO-A1	2,5	-	0,18 0.007	1,2 0.047	1,5 0.059	9,525 0.375	16,5 0.650	3,47 0.137			■			
16NR2.5ISO-A2	2,5	-	0,18 0.007	1,2 0.047	1,5 0.059	9,525 0.375	16,5 0.650	3,47 0.137			■			

Thread turning

MDT

Mini-Shaft™

Thread milling

Thread tapping

Annex

Thread turning

Insert Part No. Right	Pitch		RE	PDY	PDX	IC	L	S	Grades				
									Coated				Uncoated
									CP200	CP300	CP500	TTP2050	
mm	TPI	mm Inch	mm Inch	mm Inch	mm Inch	mm Inch	mm Inch	CP200	CP300	CP500	TTP2050	H15	
16NR3.0ISO	3	-	0,21 0.008	1,2 0.047	1,5 0.059	9,525 0.375	16,5 0.650	3,47 0.137	■		■	■	■
16NR3.0ISO-A	3	-	0,21 0.008	1,2 0.047	1,5 0.059	9,525 0.375	16,5 0.650	3,47 0.137			■	■	
16NR3.0ISO-A1	3	-	0,21 0.008	1,2 0.047	1,5 0.059	9,525 0.375	16,5 0.650	3,47 0.137			■		
16NR3.0ISO-A2	3	-	0,21 0.008	1,2 0.047	1,5 0.059	9,525 0.375	16,5 0.650	3,47 0.137			■		
27NR3.0ISO2M	3	-	0,21 0.008	2,8 0.110	4,3 0.169	15,875 0.625	27,0 1.063	6,15 0.242			■		
22NR3.5ISO	3,5	-	0,25 0.010	1,9 0.075	2,3 0.091	12,7 0.500	22,0 0.866	4,71 0.185	■		■		■
22NR4.0ISO	4	-	0,28 0.011	2,0 0.079	2,5 0.098	12,7 0.500	22,0 0.866	4,71 0.185	■	■	■		■
22NR4.5ISO	4,5	-	0,32 0.013	2,1 0.083	2,5 0.098	12,7 0.500	22,0 0.866	4,71 0.185			■		■
22NR5.0ISO	5	-	0,35 0.014	1,8 0.071	2,5 0.098	12,7 0.500	22,0 0.866	4,71 0.185	■		■		■
27NR5.5ISO	5,5	-	0,38 0.015	2,2 0.087	3,2 0.126	15,875 0.625	27,0 1.063	6,15 0.242			■		
27NR6.0ISO	6	-	0,42 0.017	2,2 0.087	3,2 0.126	15,875 0.625	27,0 1.063	6,15 0.242		■	■		

■ Stock standard.

MDT

Mini-Shaft™

Thread milling

Insert Part No. Left	Pitch		RE	PDY	PDX	IC	L	S	Grades				
									Coated				Uncoated
									CP200	CP300	CP500	TTP2050	
mm	TPI	mm Inch	mm Inch	mm Inch	mm Inch	mm Inch	mm Inch	CP200	CP300	CP500	TTP2050	H15	
11NL0.5ISO	0,5	-	0,03 0.001	0,8 0.031	0,8 0.031	6,35 0.250	11,0 0.433	3,0 0.118			■		
16NL0.5ISO	0,5	-	0,03 0.001	0,8 0.031	0,8 0.031	9,525 0.375	16,5 0.650	3,47 0.137			■		
11NL0.75ISO	0,75	-	0,04 0.002	0,8 0.031	0,8 0.031	6,35 0.250	11,0 0.433	3,0 0.118			■		
16NL0.75ISO	0,75	-	0,04 0.002	0,8 0.031	0,8 0.031	9,525 0.375	16,5 0.650	3,47 0.137			■		
11NL1.0ISO	1	-	0,07 0.003	0,8 0.031	0,8 0.031	6,35 0.250	11,0 0.433	3,0 0.118			■		
16NL1.0ISO	1	-	0,07 0.003	0,8 0.031	0,8 0.031	9,525 0.375	16,5 0.650	3,47 0.137	■		■		
11NL1.25ISO	1,25	-	0,09 0.004	0,8 0.031	0,8 0.031	6,35 0.250	11,0 0.433	3,0 0.118			■		
16NL1.25ISO	1,25	-	0,09 0.004	0,8 0.031	0,8 0.031	9,525 0.375	16,5 0.650	3,47 0.137			■		
11NL1.5ISO	1,5	-	0,12 0.005	0,8 0.031	0,8 0.031	6,35 0.250	11,0 0.433	3,0 0.118			■		
16NL1.5ISO	1,5	-	0,12 0.005	0,8 0.031	0,8 0.031	9,525 0.375	16,5 0.650	3,47 0.137	■		■		
16NL1.75ISO	1,75	-	0,12 0.005	1,2 0.047	1,5 0.059	9,525 0.375	16,5 0.650	3,47 0.137			■		
16NL2.0ISO	2	-	0,17 0.007	1,2 0.047	1,5 0.059	9,525 0.375	16,5 0.650	3,47 0.137			■		
16NL2.5ISO	2,5	-	0,18 0.007	1,2 0.047	1,5 0.059	9,525 0.375	16,5 0.650	3,47 0.137			■		
16NL3.0ISO	3	-	0,21 0.008	1,2 0.047	1,5 0.059	9,525 0.375	16,5 0.650	3,47 0.137			■		
22NL3.5ISO	3,5	-	0,25 0.010	1,9 0.075	2,3 0.091	12,7 0.500	22,0 0.866	4,71 0.185			■		

Thread tapping

Annex

Insert Part No. Left	Pitch		RE	PDY	PDX	IC	L	S	Grades				
									Coated				Uncoated
									CP200	CP300	CP500	TTP2050	
mm	TPI	mm <i>Inch</i>	mm <i>Inch</i>	mm <i>Inch</i>	mm <i>Inch</i>	mm <i>Inch</i>	mm <i>Inch</i>	mm <i>Inch</i>					
22NL4.0ISO	4	-	0,28 <i>0.011</i>	2,0 <i>0.079</i>	2,5 <i>0.098</i>	12,7 <i>0.500</i>	22,0 <i>0.866</i>	4,71 <i>0.185</i>			■		
22NL4.5ISO	4,5	-	0,32 <i>0.013</i>	2,1 <i>0.083</i>	2,5 <i>0.098</i>	12,7 <i>0.500</i>	22,0 <i>0.866</i>	4,71 <i>0.185</i>			■		
22NL5.0ISO	5	-	0,35 <i>0.014</i>	1,8 <i>0.071</i>	2,5 <i>0.098</i>	12,7 <i>0.500</i>	22,0 <i>0.866</i>	4,71 <i>0.185</i>			■		

■ Stock standard.

Thread turning

MDT

Mini-Shaft™

Thread milling

Thread tapping

Annex

UN – External Threading

Snap-Tap®

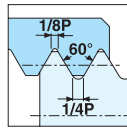
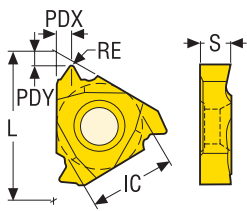

ANSI B1.1 - 1983
3A

16ER..A



16ER..A1



16ER..A2



16ER..TT



16Ex/22Ex/27ER



22ER..M



Insert Part No. Right	Pitch		RE	PDY	PDX	IC	L	S	Grades				
	mm	TPI							Coated				Uncoated
									mm Inch	mm Inch	mm Inch	mm Inch	mm Inch
27ER4UN	-	4	0,79 0.031	2,2 0.087	3,2 0.126	15,875 0.625	27,0 1.063	6,15 0.242			■		
22ER5UN	-	5	0,6 0.024	1,8 0.071	2,5 0.098	12,7 0.500	22,0 0.866	4,71 0.185			■		
22ER6UN	-	6	0,52 0.020	2,0 0.079	2,5 0.098	12,7 0.500	22,0 0.866	4,71 0.185			■		■
22ER7UN	-	7	0,47 0.019	1,8 0.071	2,5 0.098	12,7 0.500	22,0 0.866	4,71 0.185			■		■
16ER8UN	-	8	0,38 0.015	1,2 0.047	1,5 0.059	9,525 0.375	16,5 0.650	3,47 0.137	■		■	■	■
16ER8UN-A	-	8	0,43 0.017	1,2 0.047	1,5 0.059	9,525 0.375	16,5 0.650	3,47 0.137			■	■	
16ER8UN-A1	-	8	0,43 0.017	1,2 0.047	1,5 0.059	9,525 0.375	16,5 0.650	3,47 0.137			■		
16ER8UN-A2	-	8	0,43 0.017	1,2 0.047	1,5 0.059	9,525 0.375	16,5 0.650	3,47 0.137			■		
16ER9UN	-	9	0,34 0.013	1,2 0.047	1,5 0.059	9,525 0.375	16,5 0.650	3,47 0.137			■		■
16ER10UN	-	10	0,34 0.013	1,2 0.047	1,5 0.059	9,525 0.375	16,5 0.650	3,47 0.137			■		■
16ER11UN	-	11	0,28 0.011	1,2 0.047	1,5 0.059	9,525 0.375	16,5 0.650	3,47 0.137			■		■
16ER12UN	-	12	0,26 0.010	1,2 0.047	1,5 0.059	9,525 0.375	16,5 0.650	3,47 0.137	■		■	■	■
16ER12UN-A	-	12	0,29 0.011	1,2 0.047	1,5 0.059	9,525 0.375	16,5 0.650	3,47 0.137			■	■	
16ER12UN-A1	-	12	0,29 0.011	1,2 0.047	1,5 0.059	9,525 0.375	16,5 0.650	3,47 0.137			■		
16ER12UN-A2	-	12	0,29 0.011	1,2 0.047	1,5 0.059	9,525 0.375	16,5 0.650	3,47 0.137			■		
16ER12UN-TT	-	12	0,29 0.011	1,7 0.067	2,6 0.102	9,525 0.375	16,5 0.650	3,47 0.137			■		
22ER12UN2M	-	12	0,26 0.010	2,0 0.079	3,1 0.122	12,7 0.500	22,0 0.866	4,71 0.185			■		
16ER13UN	-	13	0,24 0.009	1,2 0.047	1,5 0.059	9,525 0.375	16,5 0.650	3,47 0.137			■		
16ER14UN	-	14	0,22 0.009	1,2 0.047	1,5 0.059	9,525 0.375	16,5 0.650	3,47 0.137	■		■	■	■
16ER14UN-A	-	14	0,22 0.009	1,2 0.047	1,5 0.059	9,525 0.375	16,5 0.650	3,47 0.137			■	■	
16ER14UN-A1	-	14	0,22 0.009	1,2 0.047	1,5 0.059	9,525 0.375	16,5 0.650	3,47 0.137			■		

Thread turning

MDT

Mini-Shaft™

Thread milling

Thread tapping

Annex

Insert Part No. Right	Pitch		RE	PDY	PDX	IC	L	S	Grades				
									Coated				Uncoated
									CP200	CP300	CP500	TTP2050	H15
16ER14UN-A2	-	14	0,22 0.009	1,2 0.047	1,5 0.059	9,525 0.375	16,5 0.650	3,47 0.137			■		
16ER16UN	-	16	0,22 0.009	1,2 0.047	0,8 0.031	9,525 0.375	16,5 0.650	3,47 0.137	■		■	■	■
16ER16UN-A	-	16	0,22 0.009	0,8 0.031	0,8 0.031	9,525 0.375	16,5 0.650	3,47 0.137			■	■	
16ER16UN-A1	-	16	0,22 0.009	0,8 0.031	0,8 0.031	9,525 0.375	16,5 0.650	3,47 0.137			■		
16ER16UN-A2	-	16	0,22 0.009	0,8 0.031	0,8 0.031	9,525 0.375	16,5 0.650	3,47 0.137			■		
16ER16UN-TT	-	16	0,21 0.008	1,4 0.055	1,9 0.075	9,525 0.375	16,5 0.650	3,47 0.137			■		
22ER16UN3M	-	16	0,21 0.008	2,5 0.098	4,0 0.157	12,7 0.500	22,0 0.866	4,71 0.185			■		
16ER18UN	-	18	0,18 0.007	1,2 0.047	0,8 0.031	9,525 0.375	16,5 0.650	3,47 0.137			■	■	■
16ER18UN-A	-	18	0,18 0.007	0,8 0.031	0,8 0.031	9,525 0.375	16,5 0.650	3,47 0.137			■	■	
16ER18UN-A1	-	18	0,18 0.007	0,8 0.031	0,8 0.031	9,525 0.375	16,5 0.650	3,47 0.137			■		
16ER18UN-A2	-	18	0,18 0.007	0,8 0.031	0,8 0.031	9,525 0.375	16,5 0.650	3,47 0.137			■		
16ER20UN	-	20	0,16 0.006	0,8 0.031	0,8 0.031	9,525 0.375	16,5 0.650	3,47 0.137			■	■	■
16ER20UN-A	-	20	0,16 0.006	0,8 0.031	0,8 0.031	9,525 0.375	16,5 0.650	3,47 0.137			■	■	
16ER20UN-A1	-	20	0,16 0.006	0,8 0.031	0,8 0.031	9,525 0.375	16,5 0.650	3,47 0.137			■		
16ER20UN-A2	-	20	0,16 0.006	0,8 0.031	0,8 0.031	9,525 0.375	16,5 0.650	3,47 0.137			■		
16ER20UN-TT	-	20	0,16 0.006	1,2 0.047	1,6 0.063	9,525 0.375	16,5 0.650	3,47 0.137			■		
16ER24UN	-	24	0,13 0.005	0,8 0.031	0,8 0.031	9,525 0.375	16,5 0.650	3,47 0.137		■	■		■
16ER28UN	-	28	0,11 0.004	0,8 0.031	0,8 0.031	9,525 0.375	16,5 0.650	3,47 0.137		■	■		■
16ER32UN	-	32	0,09 0.004	0,8 0.031	0,8 0.031	9,525 0.375	16,5 0.650	3,47 0.137			■		■
16ER40UN	-	40	0,08 0.003	1,2 0.047	0,5 0.020	9,525 0.375	16,5 0.650	3,47 0.137			■		

Insert Part No. Left	Pitch		RE	PDY	PDX	IC	L	S	Grades				
									Coated				Uncoated
									CP200	CP300	CP500	TTP2050	H15
22EL5UN	-	5	0,6 0.024	1,8 0.071	2,5 0.098	12,7 0.500	22,0 0.866	4,71 0.185			■		
22EL6UN	-	6	0,52 0.020	2,0 0.079	2,5 0.098	12,7 0.500	22,0 0.866	4,71 0.185			■		
22EL7UN	-	7	0,47 0.019	1,8 0.071	2,5 0.098	12,7 0.500	22,0 0.866	4,71 0.185			■		
16EL8UN	-	8	0,38 0.015	1,2 0.047	1,5 0.059	9,525 0.375	16,5 0.650	3,47 0.137			■		
16EL9UN	-	9	0,34 0.013	1,2 0.047	1,5 0.059	9,525 0.375	16,5 0.650	3,47 0.137			■		
16EL10UN	-	10	0,31 0.012	1,2 0.047	1,5 0.059	9,525 0.375	16,5 0.650	3,47 0.137			■		
16EL11UN	-	11	0,28 0.011	1,2 0.047	1,5 0.059	9,525 0.375	16,5 0.650	3,47 0.137			■		

Thread turning

MDT

Mini-Shaft™

Thread milling

Thread tapping

Annex

Thread turning	Insert Part No. Left	Pitch		RE	PDY	PDX	IC	L	S	Grades				
		mm	TPI							Coated				Uncoated
										CP200	CP300	CP500	TTP2050	
	16EL12UN	–	12	0,26 0.010	1,2 0.047	1,5 0.059	9,525 0.375	16,5 0.650	3,47 0.137			■		
	16EL14UN	–	14	0,22 0.009	1,2 0.047	1,5 0.059	9,525 0.375	16,5 0.650	3,47 0.137			■		
	16EL16UN	–	16	0,22 0.009	1,2 0.047	0,8 0.031	9,525 0.375	16,5 0.650	3,47 0.137			■		
	16EL18UN	–	18	0,18 0.007	1,2 0.047	0,8 0.031	9,525 0.375	16,5 0.650	3,47 0.137			■		
	16EL20UN	–	20	0,16 0.006	0,8 0.031	0,8 0.031	9,525 0.375	16,5 0.650	3,47 0.137			■		
	16EL24UN	–	24	0,13 0.005	0,8 0.031	0,8 0.031	9,525 0.375	16,5 0.650	3,47 0.137			■		
	16EL28UN	–	28	0,11 0.004	0,8 0.031	0,8 0.031	9,525 0.375	16,5 0.650	3,47 0.137			■		
	16EL32UN	–	32	0,09 0.004	0,8 0.031	0,8 0.031	9,525 0.375	16,5 0.650	3,47 0.137			■		

■ Stock standard.

Mini-Shaft™

Thread milling

Thread tapping

Annex

UN – Internal Threading

ANSI B1.1 - 1983
3B

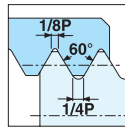

Snap-Tap®

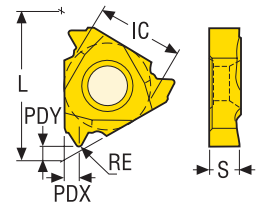

09NR/11Nx/16Nx/22Nx/27NR



16NR/22NR..M



16NR..A



16NR..A1



16NR..A2



16NR..TT



Insert Part No. Right	Pitch		RE	PDY	PDX	IC	L	S	Grades				
									Coated				Uncoated
									CP200	CP300	CP500	TTP2050	H15
27NR4UN	-	4	0,45 0.018	2,2 0.087	3,2 0.126	15,875 0.625	27,0 1.063	6,15 0.242			■		
22NR5UN	-	5	0,36 0.014	1,8 0.071	2,5 0.098	12,7 0.500	22,0 0.866	4,71 0.185			■		■
22NR6UN	-	6	0,3 0.012	2,2 0.087	2,5 0.098	12,7 0.500	22,0 0.866	4,71 0.185			■		■
22NR7UN	-	7	0,25 0.010	2,0 0.079	2,4 0.094	12,7 0.500	22,0 0.866	4,71 0.185			■		
16NR8UN	-	8	0,25 0.010	1,2 0.047	1,5 0.059	9,525 0.375	16,5 0.650	3,47 0.137	■		■	■	■
16NR8UN-A	-	8	0,25 0.010	1,2 0.047	1,5 0.059	9,525 0.375	16,5 0.650	3,47 0.137			■	■	
16NR8UN-A1	-	8	0,25 0.010	1,2 0.047	1,5 0.059	9,525 0.375	16,5 0.650	3,47 0.137			■		
16NR8UN-A2	-	8	0,25 0.010	1,2 0.047	1,5 0.059	9,525 0.375	16,5 0.650	3,47 0.137			■		
16NR9UN	-	9	0,19 0.007	1,2 0.047	1,5 0.059	9,525 0.375	16,5 0.650	3,47 0.137			■		
16NR10UN	-	10	0,18 0.007	1,2 0.047	1,5 0.059	9,525 0.375	16,5 0.650	3,47 0.137	■		■		■
16NR11UN	-	11	0,16 0.006	1,2 0.047	1,5 0.059	9,525 0.375	16,5 0.650	3,47 0.137			■		■
16NR12UN	-	12	0,15 0.006	1,2 0.047	1,5 0.059	9,525 0.375	16,5 0.650	3,47 0.137	■		■	■	■
16NR12UN-A	-	12	0,15 0.006	1,2 0.047	1,5 0.059	9,525 0.375	16,5 0.650	3,47 0.137			■	■	
16NR12UN-A1	-	12	0,15 0.006	1,2 0.047	1,5 0.059	9,525 0.375	16,5 0.650	3,47 0.137			■		
16NR12UN-A2	-	12	0,15 0.006	1,5 0.059	1,5 0.059	9,525 0.375	16,5 0.650	3,47 0.137			■		
16NR12UN-TT	-	12	0,16 0.006	1,65 0.065	2,45 0.096	9,525 0.375	16,5 0.650	3,47 0.137			■		
22NR12UN2M	-	12	0,15 0.006	2,0 0.079	3,0 0.118	12,7 0.500	22,0 0.866	4,71 0.185			■		
22NR12UN3M	-	12	0,15 0.006	3,0 0.118	5,0 0.197	12,7 0.500	22,0 0.866	4,71 0.185			■		
09NR13UN	-	13	0,15 0.006	0,7 0.028	0,9 0.035	5,56 0.219	9,6 0.378	2,4 0.094			■		
16NR13UN	-	13	0,15 0.006	1,2 0.047	1,5 0.059	9,525 0.375	16,5 0.650	3,47 0.137			■		
11NR14UN	-	14	0,14 0.006	0,8 0.031	0,9 0.035	6,35 0.250	11,0 0.433	3,0 0.118			■		■
16NR14UN	-	14	0,14 0.006	1,2 0.047	1,5 0.059	9,525 0.375	16,5 0.650	3,47 0.137	■		■	■	■

Thread turning

MDT

Mini-Shaft™

Thread milling

Thread tapping

Annex

	Insert Part No. Right								Grades					
	Pitch		RE	PDY	PDX	IC	L	S	Coated				Uncoated	
	mm	TPI	mm Inch	mm Inch	mm Inch	mm Inch	mm Inch	mm Inch	CP200	CP300	CP500	TTP2050	H15	
Thread turning	16NR14UN-A	-	14	0,14 0.006	1,2 0.047	1,3 0.051	9,525 0.375	16,5 0.650	3,47 0.137			■	■	
	16NR14UN-A1	-	14	0,14 0.006	1,2 0.047	1,3 0.051	9,525 0.375	16,5 0.650	3,47 0.137			■		
	16NR14UN-A2	-	14	0,14 0.006	1,2 0.047	1,3 0.051	9,525 0.375	16,5 0.650	3,47 0.137			■		
MDT	11NR16UN	-	16	0,13 0.005	0,8 0.031	0,8 0.031	6,35 0.250	11,0 0.433	3,0 0.118			■		■
	16NR16UN	-	16	0,13 0.005	0,8 0.031	0,8 0.031	9,525 0.375	16,5 0.650	3,47 0.137	■		■	■	■
	16NR16UN-A	-	16	0,12 0.005	0,8 0.031	0,8 0.031	9,525 0.375	16,5 0.650	3,47 0.137			■	■	
	16NR16UN-A1	-	16	0,12 0.005	0,8 0.031	0,8 0.031	9,525 0.375	16,5 0.650	3,47 0.137			■		
	16NR16UN-A2	-	16	0,12 0.005	0,8 0.031	0,8 0.031	9,525 0.375	16,5 0.650	3,47 0.137			■		
	16NR16UN-TT	-	16	0,13 0.005	1,4 0.055	1,9 0.075	9,525 0.375	16,5 0.650	3,47 0.137			■		
	16NR16UN2M	-	16	0,13 0.005	1,5 0.059	2,3 0.091	9,525 0.375	16,5 0.650	3,47 0.137			■		
	22NR16UN3M	-	16	0,13 0.005	2,4 0.094	3,8 0.150	12,7 0.500	22,0 0.866	4,71 0.185			■		
Mini-Shaft™	09NR18UN	-	18	0,1 0.004	0,7 0.028	0,8 0.031	5,56 0.219	9,6 0.378	2,4 0.094			■		
	11NR18UN	-	18	0,1 0.004	0,8 0.031	0,8 0.031	6,35 0.250	11,0 0.433	3,0 0.118			■		■
	16NR18UN	-	18	0,1 0.004	0,8 0.031	0,8 0.031	9,525 0.375	16,5 0.650	3,47 0.137	■		■	■	■
	16NR18UN-A	-	18	0,1 0.004	0,8 0.031	0,8 0.031	9,525 0.375	16,5 0.650	3,47 0.137			■	■	
	16NR18UN-A1	-	18	0,1 0.004	0,8 0.031	0,8 0.031	9,525 0.375	16,5 0.650	3,47 0.137			■		
	16NR18UN-A2	-	18	0,1 0.004	0,8 0.031	0,8 0.031	9,525 0.375	16,5 0.650	3,47 0.137			■		
	09NR20UN	-	20	0,09 0.004	0,7 0.028	0,8 0.031	5,56 0.219	9,6 0.378	2,4 0.094			■		
	11NR20UN	-	20	0,09 0.004	0,8 0.031	0,8 0.031	6,35 0.250	11,0 0.433	3,0 0.118			■		■
Thread milling	16NR20UN	-	20	0,09 0.004	0,8 0.031	0,8 0.031	9,525 0.375	16,5 0.650	3,47 0.137	■		■	■	■
	16NR20UN-A	-	20	0,09 0.004	0,8 0.031	0,8 0.031	9,525 0.375	16,5 0.650	3,47 0.137			■	■	
	16NR20UN-A1	-	20	0,09 0.004	0,8 0.031	0,8 0.031	9,525 0.375	16,5 0.650	3,47 0.137			■		
	16NR20UN-A2	-	20	0,09 0.004	0,8 0.031	0,8 0.031	9,525 0.375	16,5 0.650	3,47 0.137			■		
	11NR24UN	-	24	0,07 0.003	0,8 0.031	0,8 0.031	6,35 0.250	11,0 0.433	3,0 0.118			■		■
	16NR24UN	-	24	0,07 0.003	0,8 0.031	0,8 0.031	9,525 0.375	16,5 0.650	3,47 0.137	■		■		■
Thread tapping	11NR28UN	-	28	0,05 0.002	0,8 0.031	0,8 0.031	6,35 0.250	11,0 0.433	3,0 0.118			■		■
	16NR28UN	-	28	0,05 0.002	0,8 0.031	0,8 0.031	9,525 0.375	16,5 0.650	3,47 0.137	■		■		■
	11NR32UN	-	32	0,04 0.002	0,8 0.031	0,8 0.031	6,35 0.250	11,0 0.433	3,0 0.118			■		■
	16NR32UN	-	32	0,04 0.002	0,8 0.031	0,8 0.031	9,525 0.375	16,5 0.650	3,47 0.137	■		■		■
	16NR40UN	-	40	0,04 0.002	1,2 0.047	0,5 0.020	9,525 0.375	16,5 0.650	3,47 0.137			■		
	Annex													

Insert Part No. Left	Pitch		RE	PDY	PDX	IC	L	S	Grades				
									Coated				Uncoated
									mm	TPI	mm Inch	mm Inch	mm Inch
22NL6UN	-	6	0,3 0.012	2,2 0.087	2,5 0.098	12,7 0.500	22,0 0.866	4,71 0.185			■		
22NL7UN	-	7	0,25 0.010	2,0 0.079	2,4 0.094	12,7 0.500	22,0 0.866	4,71 0.185			■		
16NL8UN	-	8	0,25 0.010	1,2 0.047	1,5 0.059	9,525 0.375	16,5 0.650	3,47 0.137			■		
16NL10UN	-	10	0,18 0.007	1,2 0.047	1,5 0.059	9,525 0.375	16,5 0.650	3,47 0.137			■		
16NL11UN	-	11	0,16 0.006	1,2 0.047	1,5 0.059	9,525 0.375	16,5 0.650	3,47 0.137			■		
16NL12UN	-	12	0,15 0.006	1,2 0.047	1,5 0.059	9,525 0.375	16,5 0.650	3,47 0.137			■		
11NL14UN	-	14	0,14 0.006	0,8 0.031	0,9 0.035	6,35 0.250	11,0 0.433	3,0 0.118			■		
16NL14UN	-	14	0,14 0.006	1,2 0.047	1,5 0.059	9,525 0.375	16,5 0.650	3,47 0.137	■		■		
11NL16UN	-	16	0,13 0.005	0,8 0.031	0,8 0.031	6,35 0.250	11,0 0.433	3,0 0.118			■		
16NL16UN	-	16	0,13 0.005	0,8 0.031	0,8 0.031	9,525 0.375	16,5 0.650	3,47 0.137	■		■		
11NL18UN	-	18	0,1 0.004	0,8 0.031	0,8 0.031	6,35 0.250	11,0 0.433	3,0 0.118			■		
16NL18UN	-	18	0,1 0.004	0,8 0.031	0,8 0.031	9,525 0.375	16,5 0.650	3,47 0.137			■		
11NL20UN	-	20	0,09 0.004	0,8 0.031	0,8 0.031	6,35 0.250	11,0 0.433	3,0 0.118			■		
16NL20UN	-	20	0,09 0.004	0,8 0.031	0,8 0.031	9,525 0.375	16,5 0.650	3,47 0.137			■		
11NL24UN	-	24	0,07 0.003	0,8 0.031	0,8 0.031	6,35 0.250	11,0 0.433	3,0 0.118			■		
16NL24UN	-	24	0,07 0.003	0,8 0.031	0,8 0.031	9,525 0.375	16,5 0.650	3,47 0.137			■		
16NL28UN	-	28	0,05 0.002	0,8 0.031	0,8 0.031	9,525 0.375	16,5 0.650	3,47 0.137			■		
16NL32UN	-	32	0,04 0.002	0,8 0.031	0,8 0.031	9,525 0.375	16,5 0.650	3,47 0.137			■		

■ Stock standard.

Thread turning
MDT
Mini-Shaft™
Thread milling
Thread tapping
Annex

UNJ – External Threading

Snap-Tap®

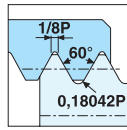
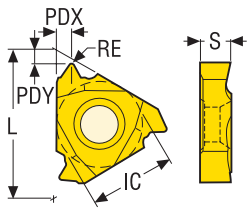

BS4084 - 1996
MIL-SPECS - 8879A
3A

16Ex



Insert Part No. Right	Pitch		RE	PDY	PDX	IC	L	S	Grades				
									Coated				Uncoated
									CP200	CP300	CP500	TTP2050	
mm	TPI	mm Inch	mm Inch	mm Inch	mm Inch	mm Inch	mm Inch	CP200	CP300	CP500	TTP2050	H15	
16ER8UNJ	-	8	0,5 0.020	1,2 0.047	1,5 0.059	9,525 0.375	16,5 0.650	3,47 0.137	■		■		
16ER10UNJ	-	10	0,405 0.016	1,2 0.047	1,5 0.059	9,525 0.375	16,5 0.650	3,47 0.137	■		■		
16ER12UNJ	-	12	0,34 0.013	1,2 0.047	1,5 0.059	9,525 0.375	16,5 0.650	3,47 0.137	■		■		■
16ER14UNJ	-	14	0,295 0.012	1,2 0.047	1,5 0.059	9,525 0.375	16,5 0.650	3,47 0.137	■		■		
16ER16UNJ	-	16	0,255 0.010	1,2 0.047	0,8 0.031	9,525 0.375	16,5 0.650	3,47 0.137	■		■		■
16ER18UNJ	-	18	0,23 0.009	1,2 0.047	0,8 0.031	9,525 0.375	16,5 0.650	3,47 0.137	■		■		
16ER20UNJ	-	20	0,208 0.008	0,8 0.031	0,8 0.031	9,525 0.375	16,5 0.650	3,47 0.137	■		■		■
16ER24UNJ	-	24	0,175 0.007	0,8 0.031	0,8 0.031	9,525 0.375	16,5 0.650	3,47 0.137	■		■		
16ER28UNJ	-	28	0,148 0.006	0,8 0.031	0,8 0.031	9,525 0.375	16,5 0.650	3,47 0.137	■		■		
16ER32UNJ	-	32	0,13 0.005	0,8 0.031	0,8 0.031	9,525 0.375	16,5 0.650	3,47 0.137	■		■		

Insert Part No. Left	Pitch		RE	PDY	PDX	IC	L	S	Grades				
									Coated				Uncoated
									CP200	CP300	CP500	TTP2050	
mm	TPI	mm Inch	mm Inch	mm Inch	mm Inch	mm Inch	mm Inch	CP200	CP300	CP500	TTP2050	H15	
16EL12UNJ	-	12	0,34 0.013	1,2 0.047	1,5 0.059	9,525 0.375	16,5 0.650	3,47 0.137	■				

■ Stock standard.

Thread turning

MDT

Mini-Shaft™

Thread milling

Thread tapping

Annex

UNJ – Internal Threading

BS4084 - 1996
MIL-SPECS - 8879A
3B

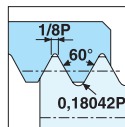

Snap-Tap®

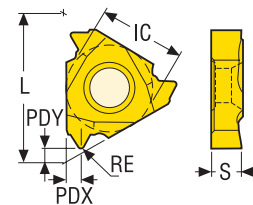

16Ex



Insert Part No. Right	Pitch		RE	PDY	PDX	IC	L	S	Grades					
									Coated				Uncoated	
									CP200	CP300	CP500	TTP2050	H15	
16NR8UNJ	–	8	0,22 0.009	1,2 0.047	1,2 0.047	9,525 0.375	16,5 0.650	3,47 0.137	■					
16NR10UNJ	–	10	0,17 0.007	1,2 0.047	1,0 0.039	9,525 0.375	16,5 0.650	3,47 0.137	■					
16NR12UNJ	–	12	0,12 0.005	1,2 0.047	0,8 0.031	9,525 0.375	16,5 0.650	3,47 0.137	■					
16NR14UNJ	–	14	0,11 0.004	1,2 0.047	0,7 0.028	9,525 0.375	16,5 0.650	3,47 0.137	■					
16NR16UNJ	–	16	0,1 0.004	1,2 0.047	0,6 0.024	9,525 0.375	16,5 0.650	3,47 0.137	■					
16NR18UNJ	–	18	0,09 0.004	1,2 0.047	0,6 0.024	9,525 0.375	16,5 0.650	3,47 0.137	■					
16NR20UNJ	–	20	0,08 0.003	1,2 0.047	0,5 0.020	9,525 0.375	16,5 0.650	3,47 0.137	■					
16NR24UNJ	–	24	0,06 0.002	1,2 0.047	0,5 0.020	9,525 0.375	16,5 0.650	3,47 0.137	■					
16NR28UNJ	–	28	0,04 0.002	1,2 0.047	0,4 0.016	9,525 0.375	16,5 0.650	3,47 0.137	■					
16NR32UNJ	–	32	0,03 0.001	1,2 0.047	0,4 0.016	9,525 0.375	16,5 0.650	3,47 0.137	■					

■ Stock standard.

Thread turning

MDT

Mini-Shaft™

Thread milling

Thread tapping

Annex

MJ – External Threading

Snap-Tap®

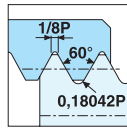
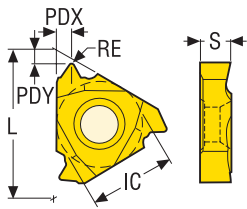

ISO5855 - 1983
4h/6h

16Ex



Insert Part No. Right	Pitch		RE	PDY	PDX	IC	L	S	Grades				
									Coated				Uncoated
									CP200	CP300	CP500	TTP2050	
16ER1.0MJ	1	–	0,16 0.006	0,8 0.031	0,8 0.031	9,525 0.375	16,5 0.650	3,47 0.137	■		■		■
16ER1.25MJ	1,25	–	0,21 0.008	0,8 0.031	0,8 0.031	9,525 0.375	16,5 0.650	3,47 0.137	■				
16ER1.5MJ	1,5	–	0,25 0.010	0,8 0.031	0,8 0.031	9,525 0.375	16,5 0.650	3,47 0.137	■		■		■
16ER2.0MJ	2	–	0,32 0.013	1,2 0.047	1,5 0.059	9,525 0.375	16,5 0.650	3,47 0.137	■				

Insert Part No. Left	Pitch		RE	PDY	PDX	IC	L	S	Grades				
									Coated				Uncoated
									CP200	CP300	CP500	TTP2050	
16EL1.0MJ	1	–	0,16 0.006	0,8 0.031	0,8 0.031	9,525 0.375	16,5 0.650	3,47 0.137	■				
16EL1.5MJ	1,5	–	0,25 0.010	0,8 0.031	0,8 0.031	9,525 0.375	16,5 0.650	3,47 0.137	■				

■ Stock standard.

Thread turning

MDT

Mini-Shaft™

Thread milling

Thread tapping

Annex

MJ – Internal Threading

ISO5855 - 1983
4H/5H

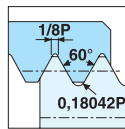

Snap-Tap®

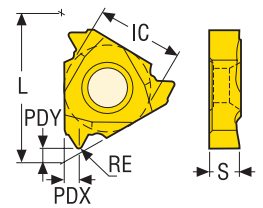

16Ex



Insert Part No. Right	Pitch		RE	PDY	PDX	IC	L	S	Grades				
									Coated				Uncoated
									CP200	CP300	CP500	TTP2050	
16NR1.0MJ	1	-	0,06 0.002	1,2 0.047	0,4 0.016	9,525 0.375	16,5 0.650	3,47 0.137	■				
16NR1.25MJ	1,25	-	0,08 0.003	1,2 0.047	0,5 0.020	9,525 0.375	16,5 0.650	3,47 0.137	■				
16NR1.5MJ	1,5	-	0,09 0.004	1,2 0.047	0,6 0.024	9,525 0.375	16,5 0.650	3,47 0.137	■				
16NR2.0MJ	2	-	0,12 0.005	1,2 0.047	0,8 0.031	9,525 0.375	16,5 0.650	3,47 0.137	■				

■ Stock standard.

Thread turning

MDT

Mini-Shaft™

Thread milling

Thread tapping

Annex

Whitworth, BSW – External Threading

Snap-Tap®

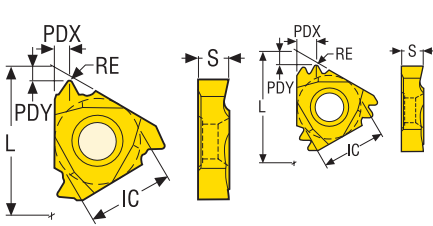

BS84 -1956
ISO228 - 1982
BS2779 - 1973

16ER..A



16ER..A1



16ER..A2



16ER..TT



16Ex/22Ex



22ER..M



Insert Part No. Right	Pitch		RE	PDY	PDX	IC	L	S	Grades				
	mm	TPI							Coated				Uncoated
									CP200	CP300	CP500	TTP2050	
22ER5W	-	5	0,63 0.025	1,7 0.067	2,5 0.098	12,7 0.500	22,0 0.866	4,71 0.185			■		■
22ER6W	-	6	0,5 0.020	1,8 0.071	2,5 0.098	12,7 0.500	22,0 0.866	4,71 0.185			■		■
22ER7W	-	7	0,43 0.017	1,8 0.071	2,5 0.098	12,7 0.500	22,0 0.866	4,71 0.185			■		■
16ER8W	-	8	0,42 0.017	1,2 0.047	1,5 0.059	9,525 0.375	16,5 0.650	3,47 0.137			■		■
16ER9W	-	9	0,31 0.012	1,2 0.047	1,5 0.059	9,525 0.375	16,5 0.650	3,47 0.137			■		
16ER10W	-	10	0,27 0.011	1,2 0.047	1,5 0.059	9,525 0.375	16,5 0.650	3,47 0.137			■		■
16ER11W	-	11	0,3 0.012	1,2 0.047	1,5 0.059	9,525 0.375	16,5 0.650	3,47 0.137	■		■	■	■
16ER11W-A	-	11	0,3 0.012	1,2 0.047	1,5 0.059	9,525 0.375	16,5 0.650	3,47 0.137			■	■	
16ER11W-A1	-	11	0,3 0.012	1,2 0.047	1,5 0.059	9,525 0.375	16,5 0.650	3,47 0.137			■		
16ER11W-A2	-	11	0,3 0.012	1,2 0.047	1,5 0.059	9,525 0.375	16,5 0.650	3,47 0.137			■		
16ER11W-TT	-	11	0,3 0.012	1,8 0.071	2,8 0.110	9,525 0.375	16,5 0.650	3,47 0.137			■		
22ER11W2M	-	11	0,3 0.012	2,3 0.091	3,5 0.138	12,7 0.500	22,0 0.866	4,71 0.185			■		
16ER12W	-	12	0,24 0.009	1,2 0.047	1,5 0.059	9,525 0.375	16,5 0.650	3,47 0.137			■		■
16ER14W	-	14	0,24 0.009	1,2 0.047	1,5 0.059	9,525 0.375	16,5 0.650	3,47 0.137	■		■	■	■
16ER14W-A	-	14	0,24 0.009	1,2 0.047	1,5 0.059	9,525 0.375	16,5 0.650	3,47 0.137			■	■	
16ER14W-A1	-	14	0,24 0.009	1,2 0.047	1,5 0.059	9,525 0.375	16,5 0.650	3,47 0.137			■		
16ER14W-A2	-	14	0,24 0.009	1,2 0.047	1,5 0.059	9,525 0.375	16,5 0.650	3,47 0.137			■		
16ER14W-TT	-	14	0,24 0.009	1,5 0.059	2,2 0.087	9,525 0.375	16,5 0.650	3,47 0.137			■		
16ER16W	-	16	0,2 0.008	0,8 0.031	0,8 0.031	9,525 0.375	16,5 0.650	3,47 0.137			■		■
16ER18W	-	18	0,16 0.006	0,8 0.031	0,8 0.031	9,525 0.375	16,5 0.650	3,47 0.137			■		
16ER19W	-	19	0,15 0.006	0,8 0.031	0,8 0.031	9,525 0.375	16,5 0.650	3,47 0.137	■		■	■	■

Thread turning

MDT

Mini-Shaft™

Thread milling

Thread tapping

Annex

Insert Part No. Right	Pitch		RE	PDY	PDX	IC	L	S	Grades				
									Coated				Uncoated
									CP200	CP300	CP500	TTP2050	H15
mm	TPI	mm Inch	mm Inch	mm Inch	mm Inch	mm Inch	mm Inch	mm Inch					
16ER19W-A	-	19	0,16 0.006	0,8 0.031	0,8 0.031	9,525 0.375	16,5 0.650	3,47 0.137			■	■	
16ER19W-A1	-	19	0,16 0.006	0,8 0.031	0,8 0.031	9,525 0.375	16,5 0.650	3,47 0.137			■		
16ER19W-A2	-	19	0,16 0.006	0,8 0.031	0,8 0.031	9,525 0.375	16,5 0.650	3,47 0.137			■		
16ER20W	-	20	0,14 0.006	0,8 0.031	0,8 0.031	9,525 0.375	16,5 0.650	3,47 0.137			■		■
16ER28W	-	28	0,09 0.004	0,8 0.031	0,8 0.031	9,525 0.375	16,5 0.650	3,47 0.137			■		■

Insert Part No. Left	Pitch		RE	PDY	PDX	IC	L	S	Grades				
									Coated				Uncoated
									CP200	CP300	CP500	TTP2050	H15
mm	TPI	mm Inch	mm Inch	mm Inch	mm Inch	mm Inch	mm Inch	mm Inch					
22EL5W	-	5	0,63 0.025	1,7 0.067	2,5 0.098	12,7 0.500	22,0 0.866	4,71 0.185			■		
22EL6W	-	6	0,5 0.020	1,8 0.071	2,5 0.098	12,7 0.500	22,0 0.866	4,71 0.185			■		
22EL7W	-	7	0,43 0.017	1,8 0.071	2,5 0.098	12,7 0.500	22,0 0.866	4,71 0.185			■		
16EL8W	-	8	0,42 0.017	1,2 0.047	1,5 0.059	9,525 0.375	16,5 0.650	3,47 0.137			■		
16EL9W	-	9	0,31 0.012	1,2 0.047	1,5 0.059	9,525 0.375	16,5 0.650	3,47 0.137			■		
16EL10W	-	10	0,27 0.011	1,2 0.047	1,5 0.059	9,525 0.375	16,5 0.650	3,47 0.137			■		
16EL11W	-	11	0,3 0.012	1,2 0.047	1,5 0.059	9,525 0.375	16,5 0.650	3,47 0.137			■		
16EL12W	-	12	0,24 0.009	1,2 0.047	1,5 0.059	9,525 0.375	16,5 0.650	3,47 0.137			■		
16EL14W	-	14	0,24 0.009	1,2 0.047	1,5 0.059	9,525 0.375	16,5 0.650	3,47 0.137			■		
16EL16W	-	16	0,2 0.008	0,8 0.031	0,8 0.031	9,525 0.375	16,5 0.650	3,47 0.137			■		
16EL19W	-	19	0,15 0.006	0,8 0.031	0,8 0.031	9,525 0.375	16,5 0.650	3,47 0.137			■		
16EL20W	-	20	0,14 0.006	0,8 0.031	0,8 0.031	9,525 0.375	16,5 0.650	3,47 0.137			■		
16EL28W	-	28	0,09 0.004	0,8 0.031	0,8 0.031	9,525 0.375	16,5 0.650	3,47 0.137			■		

■ Stock standard.

Thread turning

MDT

Mini-Shaft™

Thread milling

Thread tapping

Annex

Whitworth, BSW – Internal Threading

Snap-Tap®

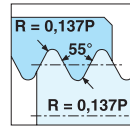
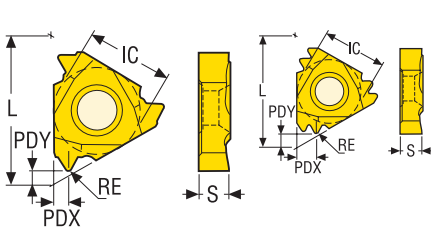

BS84 -1956
ISO228 - 1982
BS2779 - 1973

09NR/11Nx/16Nx/22Nx



11NR/16NR..A



11NR/16NR..A1



11NR/16NR..A2



16NR..TT



22NR..M



Insert Part No. Right	Pitch		RE	PDY	PDX	IC	L	S	Grades				
	mm	TPI							Coated				Uncoated
									CP200	CP300	CP500	TTP2050	
22NR5W	-	5	0,63 0.025	1,7 0.067	2,5 0.098	12,7 0.500	22,0 0.866	4,71 0.185			■		■
22NR6W	-	6	0,5 0.020	1,8 0.071	2,5 0.098	12,7 0.500	22,0 0.866	4,71 0.185			■		■
22NR7W	-	7	0,43 0.017	1,8 0.071	2,5 0.098	12,7 0.500	22,0 0.866	4,71 0.185			■		
16NR8W	-	8	0,42 0.017	1,2 0.047	1,5 0.059	9,525 0.375	16,5 0.650	3,47 0.137			■		■
16NR9W	-	9	0,31 0.012	1,2 0.047	1,5 0.059	9,525 0.375	16,5 0.650	3,47 0.137			■		■
16NR10W	-	10	0,27 0.011	1,2 0.047	1,5 0.059	9,525 0.375	16,5 0.650	3,47 0.137	■		■		■
16NR11W	-	11	0,3 0.012	1,2 0.047	1,5 0.059	9,525 0.375	16,5 0.650	3,47 0.137	■		■	■	■
16NR11W-A	-	11	0,3 0.012	1,2 0.047	1,5 0.059	9,525 0.375	16,5 0.650	3,47 0.137			■	■	
16NR11W-A1	-	11	0,3 0.012	1,2 0.047	1,5 0.059	9,525 0.375	16,5 0.650	3,47 0.137			■		
16NR11W-A2	-	11	0,3 0.012	1,2 0.047	1,5 0.059	9,525 0.375	16,5 0.650	3,47 0.137			■		
16NR11W-TT	-	11	0,31 0.012	1,8 0.071	2,8 0.110	9,525 0.375	16,5 0.650	3,47 0.137			■		
22NR11W2M	-	11	0,3 0.012	2,3 0.091	3,5 0.138	12,7 0.500	22,0 0.866	4,71 0.185			■		
16NR12W	-	12	0,24 0.009	1,2 0.047	1,5 0.059	9,525 0.375	16,5 0.650	3,47 0.137			■		■
16NR12W-TT	-	12	0,24 0.009	1,7 0.067	2,7 0.106	9,525 0.375	16,5 0.650	3,47 0.137			■		
09NR14W	-	14	0,24 0.009	0,7 0.028	0,9 0.035	5,56 0.219	9,6 0.378	2,4 0.094			■		
11NR14W	-	14	0,24 0.009	0,7 0.028	0,9 0.035	6,35 0.250	11,0 0.433	3,0 0.118	■		■	■	■
16NR14W	-	14	0,24 0.009	1,2 0.047	1,5 0.059	9,525 0.375	16,5 0.650	3,47 0.137	■		■	■	■
11NR14W-A	-	14	0,24 0.009	0,7 0.028	0,9 0.035	6,35 0.250	11,0 0.433	3,0 0.118			■	■	
16NR14W-A	-	14	0,23 0.009	1,2 0.047	1,1 0.043	9,525 0.375	16,5 0.650	3,47 0.137			■	■	
11NR14W-A1	-	14	0,24 0.009	0,7 0.028	0,9 0.035	6,35 0.250	11,0 0.433	3,0 0.118			■		
16NR14W-A1	-	14	0,23 0.009	1,2 0.047	1,1 0.043	9,525 0.375	16,5 0.650	3,47 0.137			■		
11NR14W-A2	-	14	0,24 0.009	0,7 0.028	0,9 0.035	6,35 0.250	11,0 0.433	3,0 0.118			■		

Thread turning

MDT

Mini-Shaft™

Thread milling

Thread tapping

Annex

Insert Part No. Right	Pitch		RE	PDY	PDX	IC	L	S	Grades				
									Coated				Uncoated
									CP200	CP300	CP500	TTP2050	H15
mm	TPI	mm Inch	mm Inch	mm Inch	mm Inch	mm Inch	mm Inch						
16NR14W-A2	-	14	0.23 0.009	1.2 0.047	1.1 0.043	9,525 0.375	16,5 0.650	3,47 0.137			■		
16NR14W-TT	-	14	0.23 0.009	1.5 0.059	2.2 0.087	9,525 0.375	16,5 0.650	3,47 0.137			■		
16NR16W	-	16	0.2 0.008	0.8 0.031	0.8 0.031	9,525 0.375	16,5 0.650	3,47 0.137			■		■
09NR19W	-	19	0.15 0.006	0.7 0.028	0.8 0.031	5,56 0.219	9,6 0.378	2,4 0.094			■		
11NR19W	-	19	0.15 0.006	0.8 0.031	0.8 0.031	6,35 0.250	11,0 0.433	3,0 0.118	■		■	■	■
16NR19W	-	19	0.15 0.006	0.8 0.031	0.8 0.031	9,525 0.375	16,5 0.650	3,47 0.137	■		■		■
11NR19W-A	-	19	0.15 0.006	0.8 0.031	0.8 0.031	6,35 0.250	11,0 0.433	3,0 0.118			■	■	
11NR19W-A1	-	19	0.15 0.006	0.8 0.031	0.8 0.031	6,35 0.250	11,0 0.433	3,0 0.118			■		
11NR19W-A2	-	19	0.15 0.006	0.8 0.031	0.8 0.031	6,35 0.250	11,0 0.433	3,0 0.118			■		
16NR20W	-	20	0.14 0.006	0.8 0.031	0.8 0.031	9,525 0.375	16,5 0.650	3,47 0.137			■		■
16NR28W	-	28	0.09 0.004	0.8 0.031	0.8 0.031	9,525 0.375	16,5 0.650	3,47 0.137			■		

Insert Part No. Left	Pitch		RE	PDY	PDX	IC	L	S	Grades				
									Coated				Uncoated
									CP200	CP300	CP500	TTP2050	H15
mm	TPI	mm Inch	mm Inch	mm Inch	mm Inch	mm Inch	mm Inch	mm Inch					
22NL5W	-	5	0.63 0.025	1.7 0.067	2.5 0.098	12,7 0.500	22,0 0.866	4,71 0.185			■		
22NL6W	-	6	0.5 0.020	1.8 0.071	2.5 0.098	12,7 0.500	22,0 0.866	4,71 0.185			■		
22NL7W	-	7	0.43 0.017	1.8 0.071	2.5 0.098	12,7 0.500	22,0 0.866	4,71 0.185			■		
16NL8W	-	8	0.42 0.017	1.2 0.047	1.5 0.059	9,525 0.375	16,5 0.650	3,47 0.137			■		
16NL9W	-	9	0.31 0.012	1.2 0.047	1.5 0.059	9,525 0.375	16,5 0.650	3,47 0.137			■		
16NL10W	-	10	0.27 0.011	1.2 0.047	1.5 0.059	9,525 0.375	16,5 0.650	3,47 0.137			■		
16NL11W	-	11	0.3 0.012	1.2 0.047	1.5 0.059	9,525 0.375	16,5 0.650	3,47 0.137			■		
16NL12W	-	12	0.24 0.009	1.2 0.047	1.5 0.059	9,525 0.375	16,5 0.650	3,47 0.137			■		
11NL14W	-	14	0.24 0.009	1.2 0.047	0.9 0.035	6,35 0.250	11,0 0.433	3,0 0.118			■		
16NL14W	-	14	0.24 0.009	1.2 0.047	1.5 0.059	9,525 0.375	16,5 0.650	3,47 0.137			■		
16NL16W	-	16	0.2 0.008	0.8 0.031	0.8 0.031	9,525 0.375	16,5 0.650	3,47 0.137			■		
11NL19W	-	19	0.15 0.006	0.8 0.031	0.8 0.031	6,35 0.250	11,0 0.433	3,0 0.118			■		
16NL19W	-	19	0.15 0.006	0.8 0.031	0.8 0.031	9,525 0.375	16,5 0.650	3,47 0.137			■		
16NL20W	-	20	0.14 0.006	0.8 0.031	0.8 0.031	9,525 0.375	16,5 0.650	3,47 0.137			■		
16NL28W	-	28	0.09 0.004	0.8 0.031	0.8 0.031	9,525 0.375	16,5 0.650	3,47 0.137			■		

■ Stock standard.

Thread turning

MDT

Mini-Shaft™

Thread milling

Thread tapping

Annex

BSPT – External Threading

Snap-Tap®

ISO228/1 35 21 1959 ISO7/1

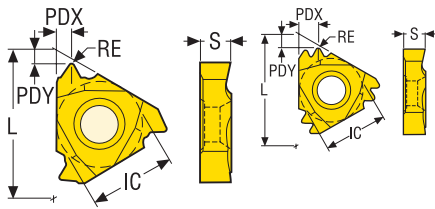

16ER..TT



Insert Part No. Right	Pitch	RE	PDY	PDX	IC	L	S	Grades				
								Coated				Uncoated
	mm TPI	mm Inch	mm Inch	mm Inch	mm Inch	mm Inch	mm Inch	CP200	CP300	CP500	TTP2050	H15
16ER11BSPT	– 11	0,3 0.012	1,2 0.047	1,5 0.059	9,525 0.375	16,5 0.650	3,47 0.137			■		
16ER11BSPT-TT	– 11	0,3 0.012	1,8 0.071	2,8 0.110	9,525 0.375	16,5 0.650	3,47 0.137			■		
16ER14BSPT	– 14	0,24 0.009	1,2 0.047	1,5 0.059	9,525 0.375	16,5 0.650	3,47 0.137			■		
16ER14BSPT-TT	– 14	0,24 0.009	1,5 0.059	2,2 0.087	9,525 0.375	16,5 0.650	3,47 0.137			■		
16ER19BSPT	– 19	0,15 0.006	0,8 0.031	0,8 0.031	9,525 0.375	16,5 0.650	3,47 0.137			■		
16ER28BSPT	– 28	0,08 0.003	0,7 0.028	0,8 0.031	9,525 0.375	16,5 0.650	3,47 0.137			■		

Insert Part No. Left	Pitch	RE	PDY	PDX	IC	L	S	Grades				
								Coated				Uncoated
	mm TPI	mm Inch	mm Inch	mm Inch	mm Inch	mm Inch	mm Inch	CP200	CP300	CP500	TTP2050	H15
16EL11BSPT	– 11	0,3 0.012	1,2 0.047	1,5 0.059	9,525 0.375	16,5 0.650	3,47 0.137			■		
16EL14BSPT	– 14	0,24 0.009	1,2 0.047	1,5 0.059	9,525 0.375	16,5 0.650	3,47 0.137			■		

■ Stock standard.

Thread turning

MDT

Mini-Shaft™

Thread milling

Thread tapping

Annex

BSPT – Internal Threading

ISO228/1 35 21 1959 ISO7/1

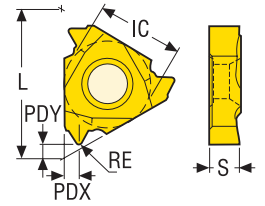
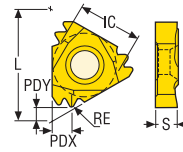
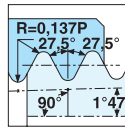

09NR/16Nx..



16NR..TT



Insert Part No. Right	Pitch		RE	PDY	PDX	IC	L	S	Grades				
									Coated				Uncoated
									CP200	CP300	CP500	TTP2050	
16NR11BSPT	–	11	0,3 0.012	1,2 0.047	1,5 0.059	9,525 0.375	16,5 0.650	3,47 0.137			■		
16NR11BSPT-TT	–	11	0,3 0.012	1,8 0.071	2,8 0.110	9,525 0.375	16,5 0.650	3,47 0.137			■		
16NR14BSPT	–	14	0,24 0.009	1,2 0.047	1,5 0.059	9,525 0.375	16,5 0.650	3,47 0.137			■		
16NR14BSPT-TT	–	14	0,24 0.009	1,5 0.059	2,2 0.087	9,525 0.375	16,5 0.650	3,47 0.137			■		
09NR19BSPT	–	19	0,15 0.006	0,8 0.031	0,8 0.031	5,56 0.219	9,6 0.378	2,4 0.094			■		

Insert Part No. Left	Pitch		RE	PDY	PDX	IC	L	S	Grades				
									Coated				Uncoated
									CP200	CP300	CP500	TTP2050	
16NL11BSPT	–	11	0,3 0.012	1,2 0.047	1,5 0.059	9,525 0.375	16,5 0.650	3,47 0.137			■		
16NL14BSPT	–	14	0,24 0.009	1,2 0.047	1,5 0.059	9,525 0.375	16,5 0.650	3,47 0.137			■		

■ Stock standard.

Thread turning

MDT

Mini-Shaft™

Thread milling

Thread tapping

Annex

NPT– External Threading

Snap-Tap®

ANSI B1.20.1 - 1983

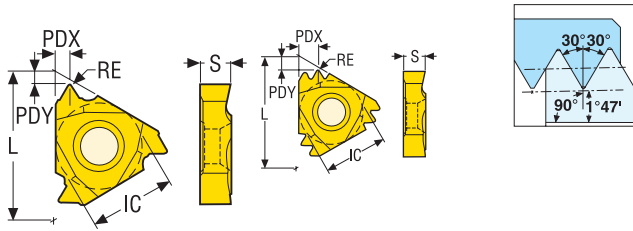

16ER..A1



16ER..A2



16Ex..



22ER/27ER..M



Insert Part No. Right	Pitch		RE	PDY	PDX	IC	L	S	Grades				
									Coated				Uncoated
									CP200	CP300	CP500	TTP2050	
	mm	TPI	mm Inch	mm Inch	mm Inch	mm Inch	mm Inch	mm Inch					
16ER8NPT	–	8	0,07 0.003	1,1 0.043	1,6 0.063	9,525 0.375	16,5 0.650	3,47 0.137			■		■
16ER11.5NPT	–	11.5	0,07 0.003	1,1 0.043	1,5 0.059	9,525 0.375	16,5 0.650	3,47 0.137			■		■
16ER11.5NPT-A1	–	11.5	0,09 0.004	1,1 0.043	1,5 0.059	9,525 0.375	16,5 0.650	3,47 0.137			■		
16ER11.5NPT-A2	–	11.5	0,09 0.004	1,1 0.043	1,5 0.059	9,525 0.375	16,5 0.650	3,47 0.137			■		
22ER11.5NPT2M	–	11.5	0,07 0.003	2,1 0.083	3,3 0.130	12,7 0.500	22,0 0.866	4,71 0.185			■		
16ER14NPT	–	14	0,07 0.003	1,1 0.043	1,5 0.059	9,525 0.375	16,5 0.650	3,47 0.137			■		■
16ER18NPT	–	18	0,06 0.002	0,7 0.028	0,8 0.031	9,525 0.375	16,5 0.650	3,47 0.137			■		■
16ER27NPT	–	27	0,04 0.002	0,7 0.028	0,8 0.031	9,525 0.375	16,5 0.650	3,47 0.137			■		

Insert Part No. Left	Pitch		RE	PDY	PDX	IC	L	S	Grades				
									Coated				Uncoated
									CP200	CP300	CP500	TTP2050	
	mm	TPI	mm Inch	mm Inch	mm Inch	mm Inch	mm Inch	mm Inch					
16EL8NPT	–	8	0,09 0.004	1,1 0.043	1,6 0.063	9,525 0.375	16,5 0.650	3,47 0.137			■		
16EL11.5NPT	–	11.5	0,07 0.003	1,1 0.043	1,5 0.059	9,525 0.375	16,5 0.650	3,47 0.137			■		
16EL14NPT	–	14	0,07 0.003	1,1 0.043	1,5 0.059	9,525 0.375	16,5 0.650	3,47 0.137			■		
16EL18NPT	–	18	0,06 0.002	0,7 0.028	0,8 0.031	9,525 0.375	16,5 0.650	3,47 0.137			■		

■ Stock standard.

Thread turning

MDT

Mini-Shaft™

Thread milling

Thread tapping

Annex

NPT – Internal Threading

Snap-Tap®

ANSI B1.20.1 - 1983

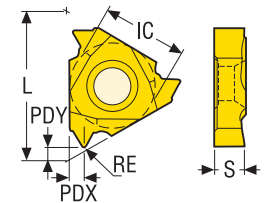
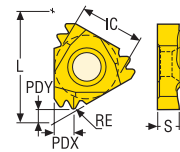
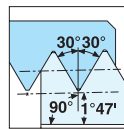

16NR..A1



16NR..A2



22NR..M



Insert Part No. Right	Pitch		RE	PDY	PDX	IC	L	S	Grades				
									Coated				Uncoated
									CP200	CP300	CP500	TTP2050	H15
	mm	TPI	mm Inch	mm Inch	mm Inch	mm Inch	mm Inch	mm Inch					
16NR8NPT	-	8	0,1 0.004	1,1 0.043	1,6 0.063	9,525 0.375	16,5 0.650	3,47 0.137			■		■
16NR8NPT-A2	-	8	0,12 0.005	1,1 0.043	1,6 0.063	9,525 0.375	16,5 0.650	3,47 0.137			■		
16NR11.5NPT	-	11.5	0,09 0.004	1,1 0.043	1,5 0.059	9,525 0.375	16,5 0.650	3,47 0.137			■		■
16NR11.5NPT-A1	-	11.5	0,1 0.004	1,1 0.043	1,5 0.059	9,525 0.375	16,5 0.650	3,47 0.137			■		
16NR11.5NPT-A2	-	11.5	0,1 0.004	1,1 0.043	1,5 0.059	9,525 0.375	16,5 0.650	3,47 0.137			■		
22NR11.5NPT2M	-	11.5	0,05 0.002	2,1 0.083	3,3 0.130	12,7 0.500	22,0 0.866	4,71 0.185			■		
11NR14NPT	-	14	0,07 0.003	0,7 0.028	1,0 0.039	6,35 0.250	11,0 0.433	3,0 0.118			■		
16NR14NPT	-	14	0,08 0.003	1,1 0.043	1,5 0.059	9,525 0.375	16,5 0.650	3,47 0.137			■		■
16NR14NPT-A2	-	14	0,08 0.003	1,1 0.043	1,5 0.059	9,525 0.375	16,5 0.650	3,47 0.137			■		
09NR18NPT	-	18	0,06 0.002	0,7 0.028	0,8 0.031	5,56 0.219	9,6 0.378	2,4 0.094			■		
11NR18NPT	-	18	0,06 0.002	0,7 0.028	0,8 0.031	6,35 0.250	11,0 0.433	3,0 0.118			■		
09NR27NPT	-	27	0,04 0.002	0,7 0.028	0,8 0.031	5,56 0.219	9,6 0.378	2,4 0.094			■		

Insert Part No. Left	Pitch		RE	PDY	PDX	IC	L	S	Grades				
									Coated				Uncoated
									CP200	CP300	CP500	TTP2050	H15
	mm	TPI	mm Inch	mm Inch	mm Inch	mm Inch	mm Inch	mm Inch					
16NL8NPT	-	8	0,1 0.004	1,2 0.047	1,6 0.063	9,525 0.375	16,5 0.650	3,47 0.137			■		
27ER8NPT2M	-	8	0,07 0.003	3,0 0.118	4,8 0.189	15,875 0.625	27,0 1.063	6,15 0.242			■		
16NL11.5NPT	-	11.5	0,09 0.004	1,1 0.043	1,5 0.059	9,525 0.375	16,5 0.650	3,47 0.137			■		
16NL14NPT	-	14	0,08 0.003	1,1 0.043	1,5 0.059	9,525 0.375	16,5 0.650	3,47 0.137			■		

■ Stock standard.

Thread turning

MDT

Mini-Shaft™

Thread milling

Thread tapping

Annex

NPTF- External Threading

Snap-Tap®

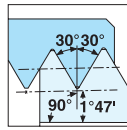
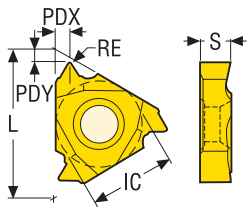

ANSI B1.4 - 1976
ANSI B1.20.3 - 1976

16ER..



Insert Part No. Right	Pitch		RE	PDY	PDX	IC	L	S	Grades				
									Coated				Uncoated
									CP200	CP300	CP500	TTP2050	H15
16ER11.5NPTF	mm	TPI	mm Inch	mm Inch	mm Inch	mm Inch	mm Inch	mm Inch			■		
16ER14NPTF	-	14	0,06 0.002	1,1 0.043	1,5 0.059	9,525 0.375	16,5 0.650	3,47 0.137			■		
16ER18NPTF	-	18	0,05 0.002	1,1 0.043	1,5 0.059	9,525 0.375	16,5 0.650	3,47 0.137			■		
16ER27NPTF	-	27	0,04 0.002	0,7 0.028	0,8 0.031	9,525 0.375	16,5 0.650	3,47 0.137			■		

■ Stock standard.

Thread turning

MDT

Mini-Shaft™

Thread milling

Thread tapping

Annex

NPTF – Internal Threading

ANSI B1.4 - 1976
ANSI B1.20.3 - 1976

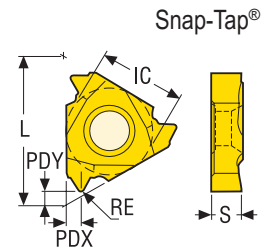
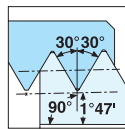

11NR/16Nx



Insert Part No. Right	Pitch		RE	PDY	PDX	IC	L	S	Grades				
									Coated				Uncoated
									CP200	CP300	CP500	TTP2050	
16NR11.5NPTF	–	11.5	0,06 0.002	1,1 0.043	1,5 0.059	9,525 0.375	16,5 0.650	3,47 0.137			■		
16NR14NPTF	–	14	0,05 0.002	1,1 0.043	1,5 0.059	9,525 0.375	16,5 0.650	3,47 0.137			■		
11NR18NPTF	–	18	0,04 0.002	0,7 0.028	0,8 0.031	6,35 0.250	11,0 0.433	3,0 0.118			■		

Insert Part No. Left	Pitch		RE	PDY	PDX	IC	L	S	Grades				
									Coated				Uncoated
									CP200	CP300	CP500	TTP2050	
16NL11.5NPTF	–	11.5	0,06 0.002	1,1 0.043	1,5 0.059	9,525 0.375	16,5 0.650	3,47 0.137			■		

■ Stock standard.

Thread turning

MDT

Mini-Shaft™

Thread milling

Thread tapping

Annex

Round-DIN405 – External Threading

Snap-Tap®

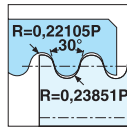
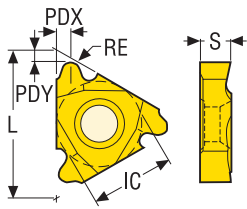

DIN405 - 1981
7h/6h

16ER/22Ex/27ER



Insert Part No. Right	Pitch		RE	PDY	PDX	IC	L	S	Grades				
									Coated				Uncoated
									CP200	CP300	CP500	TTP2050	
27ER4RD	–	4	1,46 0.057	2,2 0.087	3,2 0.126	15,875 0.625	27,0 1.063	6,15 0.242			■		
16ER6RD	–	6	0,97 0.038	1,3 0.051	1,8 0.071	9,525 0.375	16,5 0.650	3,47 0.137			■		
22ER6RD	–	6	0,97 0.038	2,0 0.079	2,5 0.098	12,7 0.500	22,0 0.866	4,71 0.185			■		
16ER8RD	–	8	0,73 0.029	1,3 0.051	1,5 0.059	9,525 0.375	16,5 0.650	3,47 0.137			■		
16ER10RD	–	10	0,58 0.023	1,3 0.051	1,5 0.059	9,525 0.375	16,5 0.650	3,47 0.137			■		

Insert Part No. Left	Pitch		RE	PDY	PDX	IC	L	S	Grades				
									Coated				Uncoated
									CP200	CP300	CP500	TTP2050	
22EL6RD	–	6	0,97 0.038	2,0 0.079	2,5 0.098	12,7 0.500	22,0 0.866	4,71 0.185			■		

■ Stock standard.

Thread turning

MDT

Mini-Shaft™

Thread milling

Thread tapping

Annex

Round-DIN405 – Internal Threading

DIN405 - 1981
7h/6h

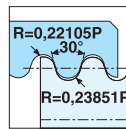

Snap-Tap®

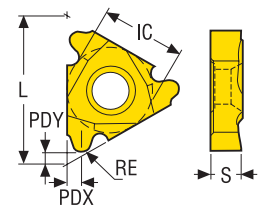

16NR/22Nx/27NR



Insert Part No. Right	Pitch		RE	PDY	PDX	IC	L	S	Grades					
									Coated				Uncoated	
									CP200	CP300	CP500	TTP2050		H15
mm	TPI	mm <i>Inch</i>	mm <i>Inch</i>	mm <i>Inch</i>	mm <i>Inch</i>	mm <i>Inch</i>	mm <i>Inch</i>	mm <i>Inch</i>						
27NR4RD	-	4	1,31 0.052	2,2 0.087	3,2 0.126	15,875 0.625	27,0 1.063	6,15 0.242			■			
16NR6RD	-	6	0,87 0.034	1,3 0.051	1,8 0.071	9,525 0.375	16,5 0.650	3,47 0.137			■			
22NR6RD	-	6	0,87 0.034	2,0 0.079	2,5 0.098	12,7 0.500	22,0 0.866	4,71 0.185			■			
16NR8RD	-	8	0,69 0.027	1,3 0.051	1,5 0.059	9,525 0.375	16,5 0.650	3,47 0.137			■			
16NR10RD	-	10	0,51 0.020	1,3 0.051	1,5 0.059	9,525 0.375	16,5 0.650	3,47 0.137			■			

Insert Part No. Left	Pitch		RE	PDY	PDX	IC	L	S	Grades					
									Coated				Uncoated	
									CP200	CP300	CP500	TTP2050		H15
mm	TPI	mm <i>Inch</i>	mm <i>Inch</i>	mm <i>Inch</i>	mm <i>Inch</i>	mm <i>Inch</i>	mm <i>Inch</i>	mm <i>Inch</i>						
22NL6RD	-	6	0,87 0.034	2,0 0.079	2,5 0.098	12,7 0.500	22,0 0.866	4,71 0.185			■			

■ Stock standard.

Thread turning

MDT

Mini-Shaft™

Thread milling

Thread tapping

Annex

TR-DIN103 – External Threading

Snap-Tap®

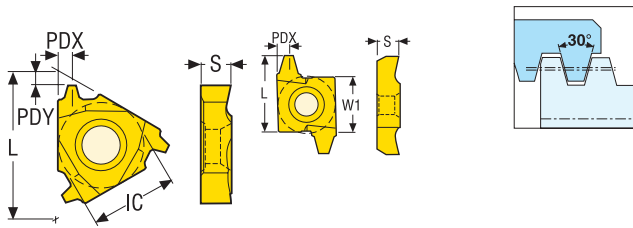

DIN103 - 1977
ISO2901/3 - 1977
7e

16Ex/22Ex27ER



20ER/26ER



Insert Part No. Right	Pitch		W1	PDY	PDX	IC	L	S	Grades					
									Coated				Uncoated	
									CP200	CP300	CP500	TTP2050		H15
	mm	TPI	mm Inch	mm Inch	mm Inch	mm Inch	mm Inch	mm Inch						
16ER1.5TR	1,5	-	-	0,9 0.035	0,8 0.031	9,525 0.375	16,5 0.650	3,47 0.137			■			
16ER2.0TR	2	-	-	1,3 0.051	1,5 0.059	9,525 0.375	16,5 0.650	3,47 0.137			■			
16ER3.0TR	3	-	-	1,3 0.051	1,6 0.063	9,525 0.375	16,5 0.650	3,47 0.137			■			
22ER4.0TR	4	-	-	2,0 0.079	2,5 0.098	12,7 0.500	22,0 0.866	4,71 0.185			■			
22ER5.0TR	5	-	-	2,0 0.079	2,3 0.091	12,7 0.500	22,0 0.866	4,71 0.185		■	■			
27ER6.0TR	6	-	-	2,5 0.098	3,2 0.126	15,875 0.625	27,0 1.063	6,15 0.242			■			
20ER7.0TR	7	-	12,7 0.500	-	3,2 0.126	-	20,0 0.787	6,3 0.248		■	■			
20ER8.0TR	8	-	12,7 0.500	-	3,2 0.126	-	20,0 0.787	6,3 0.248		■	■			
26ER9.0TR	9	-	15,875 0.625	-	5,0 0.197	-	26,0 1.024	7,88 0.310			■			
26ER10.0TR	10	-	15,875 0.625	-	5,0 0.197	-	26,0 1.024	7,88 0.310		■	■			
26ER12.0TR	12	-	15,875 0.625	-	5,0 0.197	-	26,0 1.024	7,88 0.310		■	■			
26ER14.0TR	14	-	15,875 0.625	-	5,1 0.201	-	26,0 1.024	7,88 0.310			■			

Insert Part No. Left	Pitch		W1	PDY	PDX	IC	L	S	Grades					
									Coated				Uncoated	
									CP200	CP300	CP500	TTP2050		H15
	mm	TPI	mm Inch	mm Inch	mm Inch	mm Inch	mm Inch	mm Inch						
16EL1.5TR	1,5	-	-	0,9 0.035	0,8 0.031	9,525 0.375	16,5 0.650	3,47 0.137			■			
16EL2.0TR	2	-	-	1,3 0.051	1,5 0.059	9,525 0.375	16,5 0.650	3,47 0.137			■			
16EL3.0TR	3	-	-	1,3 0.051	1,6 0.063	9,525 0.375	16,5 0.650	3,47 0.137			■			
22EL4.0TR	4	-	-	2,0 0.079	2,5 0.098	12,7 0.500	22,0 0.866	4,71 0.185			■			
22EL5.0TR	5	-	-	2,0 0.079	2,3 0.091	12,7 0.500	22,0 0.866	4,71 0.185			■			

■ Stock standard.

TR-DIN103 – Internal Threading

Snap-Tap®

DIN103 - 1977
ISO2901/3 - 1977
7H

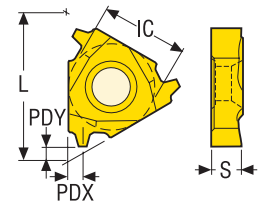
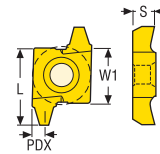
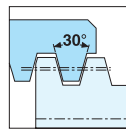

16Nx/22Nx/27NR



20NR/26NR



Insert Part No. Right	Pitch	W1	PDY	PDX	IC	L	S	Grades					
								Coated				Uncoated	
								CP200	CP300	CP500	TTP2050	H15	
mm	TPI	mm Inch	mm Inch	mm Inch	mm Inch	mm Inch	mm Inch						
16NR1.5TR	1,5	-	0,9 0.035	0,8 0.031	9,525 0.375	16,5 0.650	3,47 0.137			■			
16NR2.0TR	2	-	1,3 0.051	1,5 0.059	9,525 0.375	16,5 0.650	3,47 0.137			■			
16NR3.0TR	3	-	1,3 0.051	1,6 0.063	9,525 0.375	16,5 0.650	3,47 0.137			■			
22NR4.0TR	4	-	2,0 0.079	2,5 0.098	12,7 0.500	22,0 0.866	4,71 0.185			■			
22NR5.0TR	5	-	2,0 0.079	2,3 0.091	12,7 0.500	22,0 0.866	4,71 0.185			■			
27NR6.0TR	6	-	2,5 0.098	3,2 0.126	15,875 0.625	27,0 1.063	6,15 0.242			■			
20NR7.0TR	7	-	12,7 0.500	-	3,2 0.126	-	20,0 0.787	6,3 0.248		■	■		
20NR8.0TR	8	-	12,7 0.500	-	3,2 0.126	-	20,0 0.787	6,3 0.248		■	■		
26NR9.0TR	9	-	15,875 0.625	-	5,0 0.197	-	26,0 1.024	7,88 0.310			■		
26NR10.0TR	10	-	15,875 0.625	-	5,0 0.197	-	26,0 1.024	7,88 0.310		■	■		
26NR12.0TR	12	-	15,875 0.625	-	5,0 0.197	-	26,0 1.024	7,88 0.310		■	■		
26NR14.0TR	14	-	15,875 0.625	-	5,1 0.201	-	26,0 1.024	7,88 0.310			■		

Insert Part No. Left	Pitch	W1	PDY	PDX	IC	L	S	Grades					
								Coated				Uncoated	
								CP200	CP300	CP500	TTP2050	H15	
mm	TPI	mm Inch	mm Inch	mm Inch	mm Inch	mm Inch	mm Inch						
16NL1.5TR	1,5	-	0,9 0.035	0,8 0.031	9,525 0.375	16,5 0.650	3,47 0.137			■			
16NL2.0TR	2	-	1,3 0.051	1,5 0.059	9,525 0.375	16,5 0.650	3,47 0.137			■			
16NL3.0TR	3	-	1,3 0.051	1,6 0.063	9,525 0.375	16,5 0.650	3,47 0.137			■			
22NL4.0TR	4	-	2,0 0.079	2,5 0.098	12,7 0.500	22,0 0.866	4,71 0.185			■			
22NL5.0TR	5	-	2,0 0.079	2,3 0.091	12,7 0.500	22,0 0.866	4,71 0.185			■			

■ Stock standard.

Thread turning

MDT

Mini-Shaft™

Thread milling

Thread tapping

Annex

ACME – External Threading

Snap-Tap®

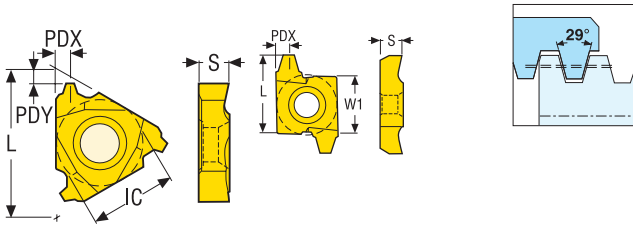

ANSI B1.5 - 1988
3G

16Ex/22Ex/27Ex



20ER/26ER



Insert Part No. Right	Pitch		RE	PDY	PDX	IC	L	S	Grades					
									Coated				Uncoated	
									CP200	CP300	CP500	TTP2050		H15
26ER2ACME	–	2	–	–	5,0 0.197	–	26,0 1.024	7,88 0.310		■	■			
20ER3ACME	–	3	–	–	3,2 0.126	–	20,0 0.787	6,3 0.248		■	■			
20ER3.5ACME	–	3.5	–	–	3,2 0.126	–	20,0 0.787	6,3 0.248			■			
27ER4ACME	–	4	–	2,5 0.098	3,0 0.118	15,875 0.625	27,0 1.063	6,15 0.242			■			
22ER5ACME	–	5	–	2,0 0.079	2,3 0.091	12,7 0.500	22,0 0.866	4,71 0.185			■			
22ER6ACME	–	6	–	2,0 0.079	2,5 0.098	12,7 0.500	22,0 0.866	4,71 0.185			■			
16ER8ACME	–	8	–	1,3 0.051	1,5 0.059	9,525 0.375	16,5 0.650	3,47 0.137			■			
16ER10ACME	–	10	–	1,4 0.055	1,5 0.059	9,525 0.375	16,5 0.650	3,47 0.137			■			
16ER12ACME	–	12	–	1,3 0.051	1,5 0.059	9,525 0.375	16,5 0.650	3,47 0.137			■			
16ER14ACME	–	14	–	1,3 0.051	1,5 0.059	9,525 0.375	16,5 0.650	3,47 0.137			■			
16ER16ACME	–	16	–	0,9 0.035	0,8 0.031	9,525 0.375	16,5 0.650	3,47 0.137			■			

Insert Part No. Left	Pitch		RE	PDY	PDX	IC	L	S	Grades					
									Coated				Uncoated	
									CP200	CP300	CP500	TTP2050		H15
27EL4ACME	–	4	–	2,5 0.098	3,0 0.118	15,875 0.625	27,0 1.063	6,15 0.242			■			
22EL5ACME	–	5	–	2,0 0.079	2,3 0.091	12,7 0.500	22,0 0.866	4,71 0.185			■			
22EL6ACME	–	6	–	2,0 0.079	2,5 0.098	12,7 0.500	22,0 0.866	4,71 0.185			■			
16EL8ACME	–	8	–	1,3 0.051	1,5 0.059	9,525 0.375	16,5 0.650	3,47 0.137			■			
16EL10ACME	–	10	–	1,4 0.055	1,5 0.059	9,525 0.375	16,5 0.650	3,47 0.137			■			

■ Stock standard.

Thread turning

MDT

Mini-Shaft™

Thread milling

Thread tapping

Annex

ACME – Internal Threading

ANSI B1.5 - 1988
3G

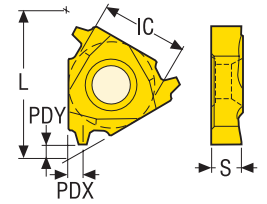
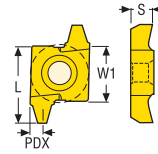
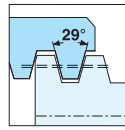

16NR/22Nx/27NR



20NR/26NR



Insert Part No. Right	Pitch		RE	PDY	PDX	IC	L	S	Grades					
									Coated				Uncoated	
									CP200	CP300	CP500	TTP2050		H15
mm	TPI	mm Inch	mm Inch	mm Inch	mm Inch	mm Inch	mm Inch							
26NR2ACME	-	2	-	-	5,0 0.197	-	26,0 1.024	7,88 0.310		■				
20NR3ACME	-	3	-	-	3,2 0.126	-	20,0 0.787	6,3 0.248		■	■			
20NR3.5ACME	-	3.5	-	-	3,2 0.126	-	20,0 0.787	6,3 0.248		■	■			
27NR4ACME	-	4	-	2,5 0.098	3,0 0.118	15,875 0.625	27,0 1.063	6,15 0.242		■	■			
22NR5ACME	-	5	-	2,0 0.079	2,3 0.091	12,7 0.500	22,0 0.866	4,71 0.185			■			
22NR6ACME	-	6	-	2,0 0.079	2,5 0.098	12,7 0.500	22,0 0.866	4,71 0.185		■	■			
16NR8ACME	-	8	-	1,3 0.051	1,5 0.059	9,525 0.375	16,5 0.650	3,47 0.137			■			
16NR10ACME	-	10	-	1,3 0.051	1,5 0.059	9,525 0.375	16,5 0.650	3,47 0.137			■			
16NR12ACME	-	12	-	1,3 0.051	1,5 0.059	9,525 0.375	16,5 0.650	3,47 0.137			■			
16NR16ACME	-	16	-	0,9 0.035	0,8 0.031	9,525 0.375	16,5 0.650	3,47 0.137			■			

Insert Part No. Left	Pitch		RE	PDY	PDX	IC	L	S	Grades					
									Coated				Uncoated	
									CP200	CP300	CP500	TTP2050		H15
mm	TPI	mm Inch	mm Inch	mm Inch	mm Inch	mm Inch	mm Inch	mm Inch						
22NL5ACME	-	5	-	2,0 0.079	2,3 0.091	12,7 0.500	22,0 0.866	4,71 0.185			■			

■ Stock standard.

Thread turning

MDT

Mini-Shaft™

Thread milling

Thread tapping

Annex

Stub-ACME – External Threading

Snap-Tap®

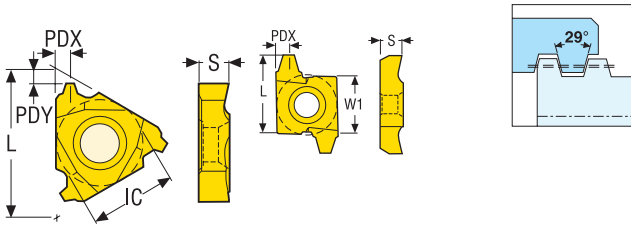

ANSI B1.8 - 1988
2G

16ER



16ER/22Ex/27ER



20ER/26ER



Insert Part No. Right	Pitch		RE	PDY	PDX	IC	L	S	Grades				
									Coated				Uncoated
									CP200	CP300	CP500	TTP2050	
mm	TPI	mm Inch	mm Inch	mm Inch	mm Inch	mm Inch	mm Inch	CP200	CP300	CP500	TTP2050	H15	
26ER2STACME	-	2	-	-	5,0 0.197	-	26,0 1.024	7,88 0.310			■		
20ER3STACME	-	3	-	-	3,2 0.126	-	20,0 0.787	6,3 0.248			■		
27ER4STACME	-	4	-	2,6 0.102	2,8 0.110	15,875 0.625	27,0 1.063	6,15 0.242		■	■		
22ER5STACME	-	5	-	2,0 0.079	2,1 0.083	12,7 0.500	22,0 0.866	4,71 0.185			■		
22ER6STACME	-	6	-	2,4 0.094	2,5 0.098	12,7 0.500	22,0 0.866	4,71 0.185			■		
16ER8STACME	-	8	-	1,8 0.071	1,5 0.059	9,525 0.375	16,5 0.650	3,47 0.137		■	■		
16ER10STACME	-	10	-	1,5 0.059	1,5 0.059	9,525 0.375	16,5 0.650	3,47 0.137			■		
16ER12STACME	-	12	-	1,5 0.059	1,5 0.059	9,525 0.375	16,5 0.650	3,47 0.137			■		
16ER14STACME	-	14	-	1,3 0.051	1,5 0.059	9,525 0.375	16,5 0.650	3,47 0.137			■		

Insert Part No. Left	Pitch		RE	PDY	PDX	IC	L	S	Grades				
									Coated				Uncoated
									CP200	CP300	CP500	TTP2050	
mm	TPI	mm Inch	mm Inch	mm Inch	mm Inch	mm Inch	mm Inch	CP200	CP300	CP500	TTP2050	H15	
22EL6STACME	-	6	-	2,4 0.094	2,5 0.098	12,7 0.500	22,0 0.866	4,71 0.185			■		

■ Stock standard.

Thread turning

MDT

Mini-Shaft™

Thread milling

Thread tapping

Annex

Stub-ACME – Internal Threading

ANSI B1.8 - 1988
2G

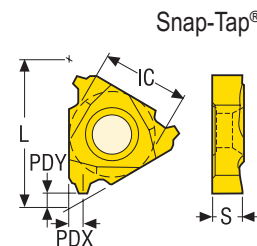
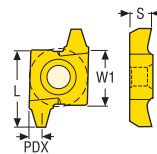
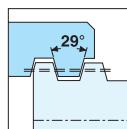

16NR



16NR/22NR/27NR



20NR



Insert Part No. Right	Pitch		RE	PDY	PDX	IC	L	S	Grades				
									Coated				Uncoated
									CP200	CP300	CP500	TTP2050	
20NR3STACME	-	3	-	-	3,2 0.126	-	20,0 0.787	6,3 0.248			■		
27NR4STACME	-	4	-	2,6 0.102	2,8 0.110	15,875 0.625	27,0 1.063	6,15 0.242		■	■		
22NR5STACME	-	5	-	2,0 0.079	2,1 0.083	12,7 0.500	22,0 0.866	4,71 0.185			■		
22NR6STACME	-	6	-	2,4 0.094	2,5 0.098	12,7 0.500	22,0 0.866	4,71 0.185			■		
16NR8STACME	-	8	-	1,8 0.071	1,5 0.059	9,525 0.375	16,5 0.650	3,47 0.137		■	■		
16NR10STACME	-	10	-	1,5 0.059	1,5 0.059	9,525 0.375	16,5 0.650	3,47 0.137			■		
16NR12STACME	-	12	-	1,5 0.059	1,5 0.059	9,525 0.375	16,5 0.650	3,47 0.137			■		
16NR14STACME	-	14	-	1,3 0.051	1,5 0.059	9,525 0.375	16,5 0.650	3,47 0.137			■		

■ Stock standard.

Thread turning

MDT

Mini-Shaft™

Thread milling

Thread tapping

Annex

AMERICAN BUTTRESS – External Threading

Snap-Tap®

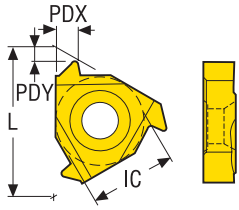

16ER



Insert Part No. Right	Pitch		PDY	PDX	IC	L	S	Grades						
								Coated				Uncoated		
								mm	TPI	mm <i>Inch</i>	mm <i>Inch</i>	mm <i>Inch</i>	mm <i>Inch</i>	mm <i>Inch</i>
16ER12BUT-S31217	-	12	2,0 <i>0.079</i>	1,3 <i>0.051</i>	9,525 <i>0.375</i>	16,5 <i>0.650</i>	3,47 <i>0.137</i>			■				

■ Stock standard.

Thread turning

MDT

Mini-Shaft™

Thread milling

Thread tapping

Annex

AMERICAN BUTTRESS – Internal Threading

Snap-Tap®

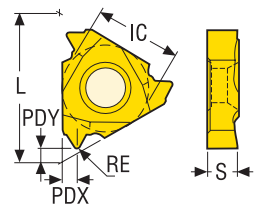

16NR



Insert Part No. Right	Pitch		PDY	PDX	IC	L	S	Grades				
								Coated				Uncoated
								CP200	CP300	CP500	TTP2050	H15
16NR12BUT-S31220	mm	TPI	mm <i>Inch</i>	mm <i>Inch</i>	mm <i>Inch</i>	mm <i>Inch</i>	mm <i>Inch</i>			■		
			2,0 0.079	1,3 0.051	9,525 0.375	16,5 0.650	3,47 0.137					

■ Stock standard.

Thread turning

MDT

Mini-Shaft™

Thread milling

Thread tapping

Annex

API Rotary Drilling connection - External threading

Snap-Tap®

API Spec 7-2 2017

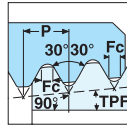
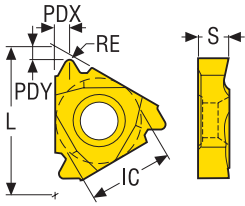

22ER/27ER



Insert Part No. Right	Pitch		RE	PDY	PDX	IC	L	S	APICODE	TGTPF	Grades				
											Coated				Uncoated
											CP200	CP300	CP500	TTP2050	
27ER4API384	mm	TPI	mm Inch	mm Inch	mm Inch	mm Inch	mm Inch	mm Inch			■		■		
22ER4API386	–	4	0,965 0.038	2,2 0.087	3,2 0.126	15,875 0.625	27,0 1.063	6,15 0.242	V038R	3		■	■		
27ER4API386	–	4	0,965 0.038	1,95 0.077	2,55 0.100	12,7 0.500	22,0 0.866	4,71 0.185	V038R	2		■	■		
27ER4API386	–	4	0,965 0.038	2,2 0.087	3,2 0.126	15,875 0.625	27,0 1.063	6,15 0.242	V038R	2	■	■	■		
27ER4API504	–	4	0,635 0.025	2,2 0.087	3,2 0.126	15,875 0.625	27,0 1.063	6,15 0.242	V050	3	■	■	■		
27ER4API506	–	4	0,635 0.025	2,2 0.087	3,2 0.126	15,875 0.625	27,0 1.063	6,15 0.242	V050	2	■	■	■		
22ER5API404	–	5	0,508 0.020	2,0 0.079	2,5 0.098	12,7 0.500	22,0 0.866	4,71 0.185	V040	3		■	■		
27ER5API404	–	5	0,508 0.020	2,2 0.087	3,2 0.126	15,875 0.625	27,0 1.063	6,15 0.242	V040	3		■	■		

■ Stock standard.

Thread turning

MDT

Mini-Shaft™

Thread milling

Thread tapping

Annex

API Rotary Drilling connection - Internal threading

API Spec 7-2 2017

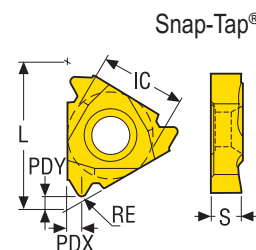
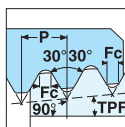

22NR/27NR



Insert Part No. Right	Pitch		RE	PDY	PDX	IC	L	S	APICODE	TGTPF	Grades				
											Coated				Uncoated
											CP200	CP300	CP500	TTP2050	
mm	TPI	mm <i>Inch</i>	mm <i>Inch</i>	mm <i>Inch</i>	mm <i>Inch</i>	mm <i>Inch</i>	mm <i>Inch</i>								
22NR4API386	-	4	0,965 <i>0.038</i>	1,9 <i>0.075</i>	2,5 <i>0.098</i>	12,7 <i>0.500</i>	22,0 <i>0.866</i>	4,71 <i>0.185</i>	V038R	2		■	■		■
27NR4API384	-	4	0,965 <i>0.038</i>	2,2 <i>0.087</i>	3,2 <i>0.126</i>	15,875 <i>0.625</i>	27,0 <i>1.063</i>	6,15 <i>0.242</i>	V038R	3	■		■		
27NR4API386	-	4	0,965 <i>0.038</i>	2,2 <i>0.087</i>	3,2 <i>0.126</i>	15,875 <i>0.625</i>	27,0 <i>1.063</i>	6,15 <i>0.242</i>	V038R	2	■	■	■		
27NR4API504	-	4	0,635 <i>0.025</i>	2,2 <i>0.087</i>	3,2 <i>0.126</i>	15,875 <i>0.625</i>	27,0 <i>1.063</i>	6,15 <i>0.242</i>	V050	3	■	■	■		
27NR4API506	-	4	0,635 <i>0.025</i>	2,2 <i>0.087</i>	3,2 <i>0.126</i>	15,875 <i>0.625</i>	27,0 <i>1.063</i>	6,15 <i>0.242</i>	V050	2	■	■	■		
22NR5API404	-	5	0,508 <i>0.020</i>	2,0 <i>0.079</i>	2,5 <i>0.098</i>	12,7 <i>0.500</i>	22,0 <i>0.866</i>	4,71 <i>0.185</i>	V040	3		■	■		
27NR5API404	-	5	0,508 <i>0.020</i>	2,2 <i>0.087</i>	3,2 <i>0.126</i>	15,875 <i>0.625</i>	27,0 <i>1.063</i>	6,15 <i>0.242</i>	V040	3		■			

■ Stock standard.

Thread turning

MDT

Mini-Shaft™

Thread milling

Thread tapping

Annex

Rotary drill connection - External threading

Snap-Tap®

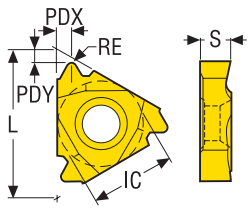

HEF = Hughes External Flush
904/906 = Hughes H90
H90 = Hughes Slimline H90
PAC = P.A.C.

904/906



HEF



PAC



Insert Part No. Right	Pitch		RE	PDY	PDX	IC	L	S	APICODE	TGTPF	Grades				
											Coated				Uncoated
											mm	TPI	mm Inch	mm Inch	mm Inch
27ER3H90	-	3	-	3,5 0.138	3,6 0.142	15,875 0.625	27,0 1.063	6,15 0.242	90V050	1,25			■		
27ER3.5H904	-	3.5	-	2,7 0.106	3,5 0.138	15,875 0.625	27,0 1.063	6,15 0.242	90V050	3			■		
27ER3.5H906	-	3.5	-	2,7 0.106	3,5 0.138	15,875 0.625	27,0 1.063	6,15 0.242	90V050	2			■		
22ER4PAC	-	4	-	2,4 0.094	2,63 0.104	12,7 0.500	22,0 0.866	4,71 0.185	V076	1,5			■		
27ER4PAC	-	4	-	2,75 0.108	3,2 0.126	15,875 0.625	27,0 1.063	6,15 0.242	V076	1,5			■		
22ER6HEF	-	6	0,382 0.015	2,0 0.079	2,5 0.098	12,7 0.500	22,0 0.866	4,71 0.185	-	2			■		

■ Stock standard.

Thread turning

MDT

Mini-Shaft™

Thread milling

Thread tapping

Annex

Rotary drill connection - Internal threading

HEF = Hughes External Flush
904/906 = Hughes H90
H90 = Hughes Slimline H90
PAC = P.A.C.

Snap-Tap®

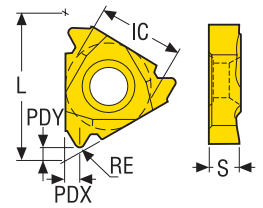

904/906



HEF



PAC



Insert Part No. Right	Pitch		RE	PDY	PDX	IC	L	S	APICODE	TGTPF	Grades				
											Coated			Uncoated	
											CP200	CP300	CP500	TTP2050	H15
27NR3H90	-	3	-	3,5 0.138	3,6 0.142	15,875 0.625	27,0 1.063	6,15 0.242	90V050	1,25			■		
27NR3.5H904	-	3.5	-	2,7 0.106	3,5 0.138	15,875 0.625	27,0 1.063	6,15 0.242	90V050	3			■		
27NR3.5H906	-	3.5	-	2,7 0.106	3,5 0.138	15,875 0.625	27,0 1.063	6,15 0.242	90V050	2			■		
22NR4PAC	-	4	-	2,4 0.094	2,6 0.102	12,7 0.500	22,0 0.866	4,71 0.185	V076	1,5			■		
27NR4PAC	-	4	-	2,75 0.108	3,2 0.126	15,875 0.625	27,0 1.063	6,15 0.242	V076	1,5			■		
22NR6HEF	-	6	0,381 0.015	2,0 0.079	2,5 0.098	12,7 0.500	22,0 0.866	4,71 0.185	-	2			■		

■ Stock standard.

Thread turning

MDT

Mini-Shaft™

Thread milling

Thread tapping

Annex

API Spec. 5B ROUND - External Threading

Snap-Tap®

API spec. 5B - 1988

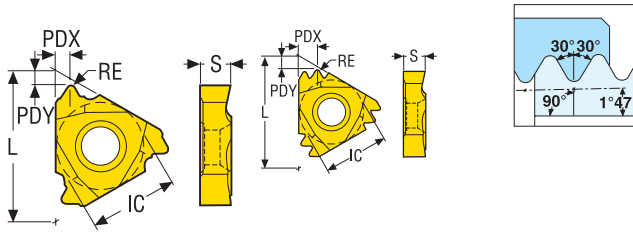

16ER



22ER/27ER..M



Insert Part No. Right	Pitch		RE	PDY	PDX	IC	L	S	Grades				
									Coated				Uncoated
									CP200	CP300	CP500	TTP2050	H15
	mm	TPI	mm Inch	mm Inch	mm Inch	mm Inch	mm Inch	mm Inch					
16ER8APIRD	-	8	0,46 0.018	1,5 0.059	1,5 0.059	9,525 0.375	16,5 0.650	3,47 0.137			■		
27ER8APIRD2M	-	8	0,46 0.018	2,9 0.114	4,5 0.177	15,875 0.625	27,0 1.063	6,15 0.242		■			
16ER10APIRD	-	10	0,38 0.015	1,5 0.059	1,5 0.059	9,525 0.375	16,5 0.650	3,47 0.137			■		
22ER10APIRD2M	-	10	0,38 0.015	2,4 0.094	3,7 0.146	12,7 0.500	22,0 0.866	4,71 0.185			■		

■ Stock standard.

Thread turning

MDT

Mini-Shaft™

Thread milling

Thread tapping

Annex

API Spec. 5B ROUND - Internal Threading

API spec. 5B - 1988

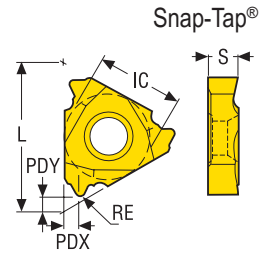
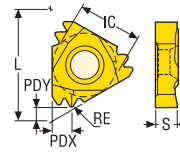
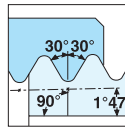

16NR



27NR..M



Insert Part No. Right	Pitch		RE	PDY	PDX	IC	L	S	Grades				
									Coated				Uncoated
									CP200	CP300	CP500	TTP2050	
16NR8APIRD	-	8	0,46 0.018	1,5 0.059	1,5 0.059	9,525 0.375	16,5 0.650	3,47 0.137			■		
27NR8APIRD2M	-	8	0,46 0.018	2,9 0.114	4,5 0.177	15,875 0.625	27,0 1.063	6,15 0.242		■			
16NR10APIRD	-	10	0,38 0.015	1,5 0.059	1,5 0.059	9,525 0.375	16,5 0.650	3,47 0.137			■		

■ Stock standard.

Thread turning

MDT

Mini-Shaft™

Thread milling

Thread tapping

Annex

API 5B BUTTRESS, 1:16 Taper – External Threading

Snap-Tap®

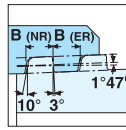
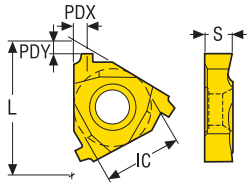

Vallourec ST-D453.02
API spec. 5B - 1988

Crest and root are parallel to taper

22ER



Insert Part No. Right	Pitch	PDY	PDX	IC	L	S	TGTPF	Grades					
								Coated				Uncoated	
	mm	TPI	mm <i>Inch</i>	mm <i>Inch</i>	mm <i>Inch</i>	mm <i>Inch</i>	mm <i>Inch</i>	CP200	CP300	CP500	TTP2050	H15	
22ER5BUT2.5	-	5	2,2 <i>0.087</i>	2,5 <i>0.098</i>	12,7 <i>0.500</i>	22,0 <i>0.866</i>	4,71 <i>0.185</i>	3/4"			■		

■ Stock standard.

Thread turning

MDT

Mini-Shaft™

Thread milling

Thread tapping

Annex

API 5B BUTTRESS, 1:16 Taper - Internal Threading

Vallourec ST-D453.02
API spec. 5B - 1988
Crest and root are parallel to taper

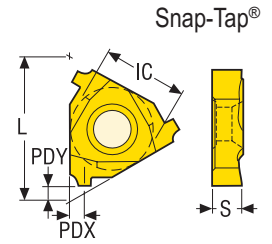
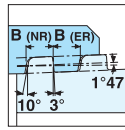

22NR



Insert Part No. Right	Pitch		PDY	PDX	IC	L	S	TGTPF	Grades				
									Coated				Uncoated
									CP200	CP300	CP500	TTP2050	H15
22NR5BUT2.5	mm	TPI	mm <i>Inch</i>	mm <i>Inch</i>	mm <i>Inch</i>	mm <i>Inch</i>	mm <i>Inch</i>	3/4"		■	■		

■ Stock standard.

Thread turning

MDT

Mini-Shaft™

Thread milling

Thread tapping

Annex

API BUTTRESS 1:12 Taper - External Threading

Snap-Tap®

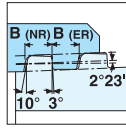
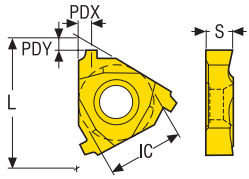

API spec. 5B - 1988
Crest and root are parallel to axis

22ER



Insert Part No. Right	Pitch	PDY	PDX	IC	L	S	TGTPF	Grades					
								Coated				Uncoated	
	mm	TPI	mm Inch	mm Inch	mm Inch	mm Inch		CP200	CP300	CP500	TTP2050	H15	
22ER5BUT2.6	-	5	2,2 0.087	2,5 0.098	12,7 0.500	22,0 0.866	4,71 0.185	1			■		

■ Stock standard.

Thread turning

MDT

Mini-Shaft™

Thread milling

Thread tapping

Annex

API BUTTRESS 1:12 Taper - Internal Threading

API spec. 5B - 1988
Crest and root are parallel to axis

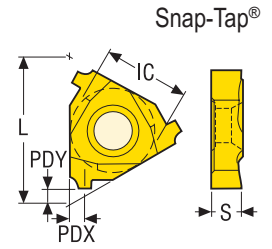
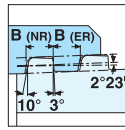

22NR



Insert Part No. Right	Pitch		PDY	PDX	IC	L	S	TGTPF	Grades					
									Coated				Uncoated	
									CP200	CP300	CP500	TTP2050		
22NR5BUT2.6	mm	TPI	mm <i>Inch</i>	mm <i>Inch</i>	mm <i>Inch</i>	mm <i>Inch</i>	mm <i>Inch</i>							
	-	5	2,0 0.079	2,1 0.083	12,7 0.500	22,0 0.866	4,71 0.185	1			■			

■ Stock standard.

Thread turning

MDT

Mini-Shaft™

Thread milling

Thread tapping

Annex

Chasers

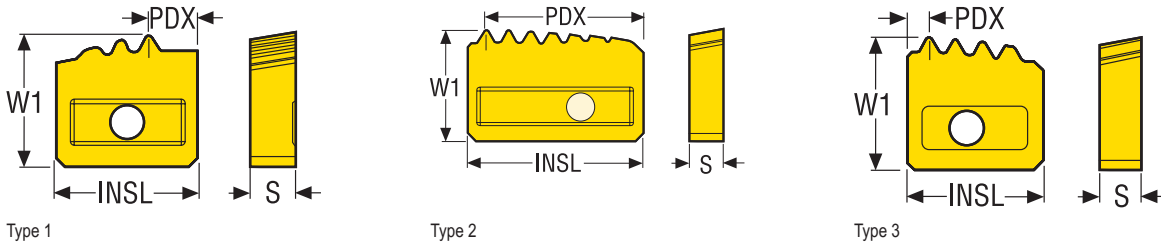

Designation	Pitch	Thread Form Product	INSL	W1	PDX	S	NT	Int./Ext.	Type	CHF1	Grades				
											Coated				
											CP250T	CP500T	TP150T	TTP1550	
	TPI		mm Inch	mm Inch	mm Inch	mm Inch									
5-1102	5,0	API_BUTTRESS_5TPI_1/16_EXT	15,875 0.625	15,875 0.625	2,1 0.083	4,76 0.187	3	External	1	C-1004-4	■				
5-5102	5,0	API_BUTTRESS_5TPI_1/16_EXT,	25,0 0.984	15,875 0.625	2,0 0.079	5,0 0.197	5	External	1	C-5003-4	■		■	■	
5-1113	5,0	API_BUTTRESS_5TPI_1/16_INT,	15,875 0.625	15,875 0.625	2,5 0.098	4,76 0.187	3	Internal	3	C-1018-96	■				
5-5112-C	5,0	API_BUTTRESS_5TPI_1/16_INT	25,0 0.984	15,875 0.625	1,964 0.077	5,0 0.197	5	Internal	3	C-5003-96	■	■			
5-5108	5,0	API_BUTTRESS_5TPI_1/16_INT	25,0 0.984	15,875 0.625	2,5 0.098	5,0 0.197	5	Internal	3	C-5003-96	■				
5-1134	5,0	API_BUTT_5TPI_CAS_1/16_INTPUL	15,875 0.625	15,875 0.625	13,375 0.527	4,76 0.187	3	Internal	2	C-1018-96	■				■
5-5110	5,0	API_BUTT_5TPI_1/16_INTPULLING	25,0 0.984	15,875 0.625	22,5 0.886	5,0 0.197	5	Internal	2	C-5003-96	■				
5-4131-1	5,0	API_BUTTRESS_1/16_5TPI_EXT_1	20,0 0.787	15,692 0.618	4,84 0.191	4,76 0.187	3	External	1	C-4001-4	■				
5-4131-2	5,0	API_BUTTRESS_1/16_5TPI_EXT_2	20,0 0.787	15,875 0.625	2,3 0.091	4,76 0.187	4	External	1	C-4001-4	■				
5-3105-1	5,0	API_BUTTRESS_5TPI_1/16_PMC_1	17,0 0.669	14,57 0.574	5,552 0.219	5,2 0.205	3	External	1	C-3901-1	■				
5-3105-2	5,0	API_BUTTRESS_5TPI_1/16_PMC_2	17,0 0.669	14,825 0.584	3,858 0.152	5,2 0.205	3	External	1	C-3901-2	■				
5-3105-3	5,0	API_BUTTRESS_5TPI_1/16_PMC_3	17,0 0.669	14,98 0.590	2,165 0.085	5,2 0.205	3	External	1	C-3901-3	■				
8-1116	8,0	API_RD_CAS_8TPI_EXT,	15,875 0.625	15,875 0.625	5,6 0.220	4,76 0.187	3	External	1	C-1005-4	■				
8-1128	8,0	API_RD_8TPI_INT,	15,875 0.625	15,875 0.625	2,5 0.098	4,76 0.187	4	Internal	3	C-1002-96	■				
8-5111	8,0	API_RD_8TPI_INT	25,0 0.984	15,875 0.625	2,5 0.098	5,0 0.197	7	Internal	3	C-5002-96	■				
8-4133-1	8,0	API_RD_8TPI_EXT_CASING_1	20,0 0.787	15,875 0.625	10,19 0.401	4,76 0.187	3	External	1	C-4003-4	■				
8-4133-2	8,0	API_RD_8TPI_EXT_CASING_2	20,0 0.787	15,875 0.625	8,6 0.339	4,76 0.187	3	External	1	C-4003-4	■				
8-2115-1	8,0	API_RD_8TPI_CAS_3/4_TPF_PMC_1	16,0 0.630	14,62 0.576	7,697 0.303	5,2 0.205	3	External	1	-	■				
8-2115-2	8,0	API_RD_8TPI_CAS_3/4_TPF_PMC_2	16,0 0.630	14,87 0.585	6,638 0.261	5,2 0.205	3	External	1	-	■				
8-2115-3	8,0	API_RD_8TPI_CAS_3/4_TPF_PMC_3	16,0 0.630	15,0 0.591	5,58 0.220	5,2 0.205	3	External	1	-	■				
8-1117	8,0	API_RD_TUBING_8TPI_EXT,	15,875 0.625	15,875 0.625	5,6 0.220	4,76 0.187	3	External	1	C-1005-4	■				
8-2118-1	8,0	API_RD_8TPI_TUB_3/4_TPF_PMC_1	16,0 0.630	14,62 0.576	7,697 0.303	5,2 0.205	3	External	1	-	■				
8-2118-2	8,0	API_RD_8TPI_TUB_3/4_TPF_PMC_2	16,0 0.630	14,87 0.585	6,638 0.261	5,2 0.205	3	External	1	-	■				
8-2118-3	8,0	API_RD_8TPI_TUB_3/4_TPF_PMC_3	16,0 0.630	15,0 0.591	5,58 0.220	5,2 0.205	3	External	1	-	■				

Designation	Pitch	Thread Form Product	INSL	W1	PDX	S	NT	Int./Ext.	Type	CHF1	Grades			
											Coated			
	TPI		mm Inch	mm Inch	mm Inch	mm Inch					CP250T	CP500T	TP150T	TTP1550
8-5114	8,0	API_RD_8TPI_INTPULLING	25,0 0.984	15,875 0.625	22,5 0.886	5,0 0.197	7	Internal	2	C-5002-96	■			
10-1120	10,0	API_RD_10TPI_TUB_INT	15,875 0.625	15,875 0.625	5,0 0.197	4,76 0.187	4	Internal	3	C-1001-96	■			
10-1133-2	10,0	API_RD_10TPI_TUB_EXT_2	15,875 0.625	15,875 0.625	4,4 0.173	4,76 0.187	3	External	1	C-1001-4	■			

Thread turning

MDT

Mini-Shaft™

Thread milling

Thread tapping

Annex

Chipformers

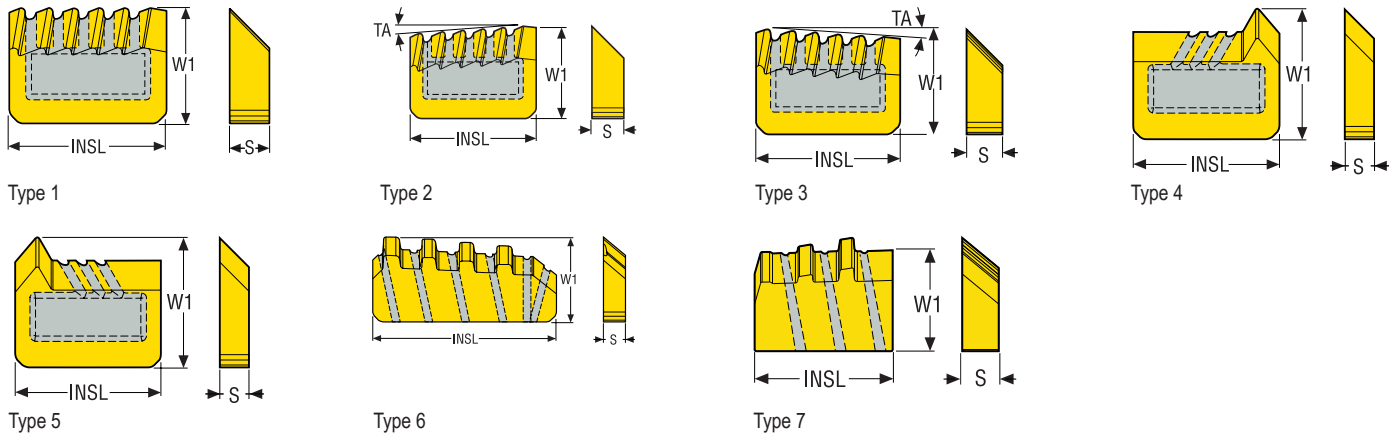

Designation	Type	INSL		W1		S	
		mm	Inch	mm	Inch	mm	Inch
C-1001	1	15,7	0.618	11,5	0.453	3,97	0.156
C-1001-4	2	15,7	0.618	11,5	0.453	3,97	0.156
C-1001-96	3	15,7	0.618	11,5	0.453	3,97	0.156
C-1002	1	15,7	0.618	11,5	0.453	3,97	0.156
C-1002-4	2	15,7	0.618	11,5	0.453	3,97	0.156
C-1002-96	3	15,7	0.618	11,5	0.453	3,97	0.156
C-1003	1	15,7	0.618	11,5	0.453	3,97	0.156
C-1004	1	15,7	0.618	11,5	0.453	3,97	0.156
C-1004-4	2	15,7	0.618	11,5	0.453	3,97	0.156
C-1004-96	3	15,7	0.618	11,5	0.453	3,97	0.156
C-1005-4	2	15,7	0.618	11,5	0.453	3,97	0.156
C-1005-96	3	15,7	0.618	11,5	0.453	3,97	0.156
C-1006-4	2	15,7	0.618	11,5	0.453	3,97	0.156
C-1009	1	15,7	0.618	11,5	0.453	3,97	0.156
C-1009-4	1	15,7	0.618	11,5	0.453	3,97	0.156
C-1009-96	3	15,7	0.618	11,5	0.453	3,97	0.156
C-1010	1	15,7	0.618	11,5	0.453	3,97	0.156
C-1010-4	2	15,7	0.618	11,5	0.453	3,97	0.156
C-1010-96	3	15,7	0.618	11,5	0.453	3,97	0.156
C-1013-96	3	15,7	0.618	11,5	0.453	3,97	0.156
C-1018	1	15,7	0.618	11,5	0.453	3,97	0.156

Designation	Type	INSL		W1		S	
		mm	Inch	mm	Inch	mm	Inch
C-1018-96	3	15,7	0.618	11,5	0.453	3,97	0.156
C-1021-96	3	15,7	0.618	11,5	0.453	3,97	0.156
C-1022	4	15,7	0.618	11,5	0.453	3,18	0.125
C-1023	5	15,7	0.618	11,5	0.453	3,18	0.125
C-1024	4	15,7	0.618	11,5	0.453	3,97	0.156
C-1025	5	15,7	0.618	11,5	0.453	3,97	0.156
C-1032	5	15,7	0.618	11,5	0.453	3,18	0.125
C-1033	4	15,7	0.618	11,5	0.453	3,18	0.125
C-1034	5	15,7	0.618	11,5	0.453	3,18	0.125
C-1035	4	15,7	0.618	11,5	0.453	3,18	0.125
C-1601-96	3	15,7	0.618	12,5	0.492	3,97	0.156
C-1604-4	2	15,7	0.618	12,5	0.492	3,97	0.156
C-1X37-I-145	4	15,7	0.618	14,5	0.571	3,18	0.125
C-1X38-I-145	5	15,7	0.618	14,5	0.571	3,18	0.125
C-1X39-I-145	4	15,7	0.618	14,5	0.571	3,18	0.125
C-1X40-I-145	5	15,7	0.618	14,5	0.571	3,18	0.125
C-1X41-I-145	4	15,7	0.618	14,5	0.571	3,18	0.125
C-1X42-I-145	5	15,7	0.618	14,5	0.571	3,18	0.125
C-3901-1	7	16,9	0.665	13,9	0.547	4,47	0.176
C-3901-2	7	16,9	0.665	14,0	0.551	4,47	0.176
C-3901-3	7	16,9	0.665	14,2	0.559	4,47	0.176
C-4001-4	2	19,8	0.780	11,5	0.453	3,97	0.156
C-4003-4	2	19,8	0.780	11,5	0.453	3,97	0.156
C-5001-4	2	24,8	0.976	11,5	0.453	3,97	0.156
C-5001-96	3	24,8	0.976	11,5	0.453	3,97	0.156
C-5002-4	2	24,8	0.976	11,5	0.453	3,97	0.156
C-5002-96	3	24,8	0.976	11,5	0.453	3,97	0.156
C-5003	1	24,8	0.976	11,5	0.453	3,97	0.156
C-5003-4	2	24,8	0.976	11,5	0.453	3,97	0.156
C-5003-96	3	24,8	0.976	11,5	0.453	3,97	0.156
C-5005	1	24,8	0.976	11,5	0.453	3,0	0.118

Thread turning

MDT

Mini-Shaft™

Thread milling

Thread tapping

Annex

	Designation	Type	INSL		W1		S	
			mm <i>Inch</i>		mm <i>Inch</i>		mm <i>Inch</i>	
Thread turning	C-5006	1	24,8 <i>0.976</i>		11,5 <i>0.453</i>		3,0 <i>0.118</i>	
	C-5705-G	6	24,8 <i>0.976</i>		13,0 <i>0.512</i>		3,0 <i>0.118</i>	
	C-5803-4	6	24,8 <i>0.976</i>		13,5 <i>0.531</i>		3,97 <i>0.156</i>	
	C-5805-G	6	24,8 <i>0.976</i>		13,5 <i>0.531</i>		3,0 <i>0.118</i>	
	C-5905-G	6	24,8 <i>0.976</i>		14,0 <i>0.551</i>		3,0 <i>0.118</i>	
	C-9001-I	4	12,6 <i>0.496</i>		11,5 <i>0.453</i>		3,18 <i>0.125</i>	
MDT								
Mini-Shaft™								
Thread milling								
Thread tapping								
Annex								



Thread turning MDT

The highly stable and reliable Seco MDT (Multi-Directional Turning) system consists of holders and inserts that offers excellent performance in thread-turning operations. Products are available for both external and internal threads. Its unique clamping method is a combination of V-shaped top clamp and serrated contact surfaces between the underside of the insert and toolholder, resulting in superb stability.

- External and Internal threads
- Unique clamping method
- V-shaped top clamp secure stability

MDT Toolholders, external

Toolholders for inserts LCGN

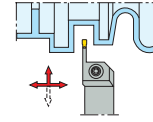
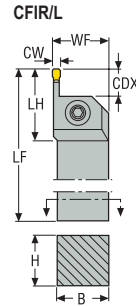
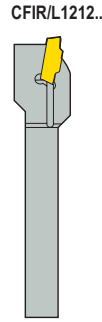
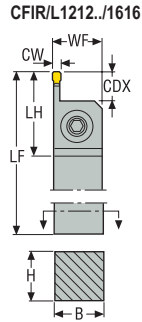

- Right-hand version shown
- For inserts program, see page(s) 193-195
- $a_r = 3 \times a_p$
- CW = indicative Cutting Width, may vary depending on the chosen insert

Designation	Item number	H	B	LF	CW	WF	LH	CDX	Weight	CTWS
		mm	mm	mm	mm	mm	mm	mm	kg	
CFIR1212M03	02435854	12,0	12,0	150,0	3,0	12,0	31,0	9,0	0,2	LC..1603..
CFIR1616H03	00091799	16,0	16,0	100,0	3,0	16,0	28,0	9,0	0,2	LC..1603..
CFIR2020K03	00068771	20,0	20,0	125,0	3,0	21,5	28,0	9,0	0,4	LC..1603..
CFIR2525M03	00068773	25,0	25,0	150,0	3,0	26,5	28,0	9,0	0,7	LC..1603..
CFIR3225P03	00013453	32,0	25,0	170,0	3,0	26,5	28,0	9,0	1,0	LC..1603..
CFIL1212M03	02435855	12,0	12,0	150,0	3,0	12,0	31,0	9,0	0,2	LC..1603..
CFIL1616H03	00091798	16,0	16,0	100,0	3,0	16,0	28,0	9,0	0,2	LC..1603..
CFIL2020K03	00068770	20,0	20,0	125,0	3,0	21,5	28,0	9,0	0,4	LC..1603..
CFIL2525M03	00068772	25,0	25,0	150,0	3,0	26,5	28,0	9,0	0,7	LC..1603..
CFIL3225P03	00013452	32,0	25,0	170,0	3,0	26,5	28,0	9,0	1,0	LC..1603..

Spare Parts, included in delivery

For holders	Clamp key	Clamp screw
..1212M03	3SMS795	TCEI0409
..1616H03	4SMS795	TCEI0509
..2020K03	4SMS795	TCEI0513
..2525M03	4SMS795	TCEI0513
..3225P03	4SMS795	TCEI0513

Thread turning

MDT

Mini-Shaft™

Thread milling

Thread tapping

Annex

MDT Toolholders, external

Toolholders for inserts LCGF, LCGN, LCMF and LCMR

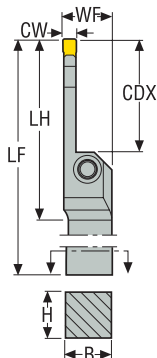
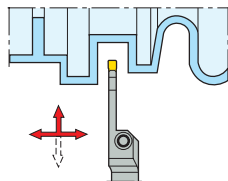



CDX = 8 x CW

- Right-hand version shown
- For inserts program, see page(s) 193-195
- DCINN3 - minimum bore diameter for internal application, see catalog Turning
- CDX – Max depth of cut for LCGF/LCMF16.. = 14 mm, LCGF/LCMF30.. = 28
- CW = indicative Cutting Width, may vary depending on the chosen insert

Designation	Item number	H	B	LF	CW	WF	LH	CDX	DCINN3	Weight	CTWS
		mm	mm	mm	mm	mm	mm	mm	mm	kg	
CFSR2525M03	02703367	25,0	25,0	150,0	3,0	26,5	46,0	24,0	195,0	0,7	LC..1603..
CFSR3225P03	02703375	32,0	25,0	170,0	3,0	26,1	46,0	24,0	195,0	1,0	LC..1603..
CFSL2525M03	02703363	25,0	25,0	150,0	3,0	26,5	46,0	24,0	195,0	0,7	LC..1603..
CFSL3225P03	02703371	32,0	25,0	170,0	3,0	26,1	46,0	24,0	195,0	1,0	LC..1603..

Spare Parts, included in delivery

For holders	Clamp key	Clamp screw
		
CFSR/L...03	4SMS795	TCEI0513

MDT Toolholders, external

Toolholders for inserts LCGF, LCGN, LCMF and LCMR

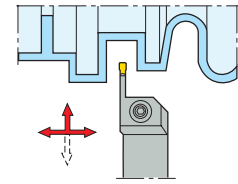
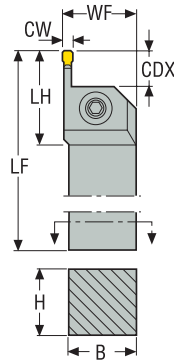

- Right-hand version shown
- For inserts program, see page(s) 193-195
- DCINN3 - minimum bore diameter for internal application, see catalog Turning
- CDX – Max depth of cut for LCGF/LCMF16.. = 14 mm
- CW = indicative Cutting Width, may vary depending on the chosen insert

$$CDX = 5 \times CW$$

Designation	Item number	H	B	LF	CW	WF	LH	CDX	DCINN3	Weight	CTWS
		mm	mm	mm	mm	mm	mm	mm	mm	kg	
CFMR2020K03	00068777	20,0	20,0	125,0	3,0	21,5	36,0	15,0	–	0,4	LC..1603..
CFMR2525M03	00068779	25,0	25,0	150,0	3,0	26,5	36,0	15,0	195,0	0,7	LC..1603..
CFMR3225P03	00013460	32,0	25,0	170,0	3,0	26,5	36,0	15,0	195,0	1,0	LC..1603..
CFML2020K03	00068776	20,0	20,0	125,0	3,0	21,5	36,0	15,0	–	0,4	LC..1603..
CFML2525M03	00068778	25,0	25,0	150,0	3,0	26,5	36,0	15,0	195,0	0,7	LC..1603..
CFML3225P03	00013459	32,0	25,0	170,0	3,0	26,5	36,0	15,0	195,0	1,0	LC..1603..

Spare Parts, included in delivery

For holders	Clamp key	Clamp screw
CFMR/L...03	4SMS795	TCEI0513

Thread turning

MDT

Mini-Shaft™

Thread milling

Thread tapping

Annex

MDT Toolholders, external

Toolholders for inserts LCGN and LCMR

CF..1212, 1616

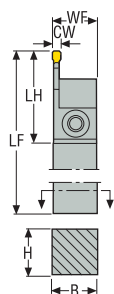

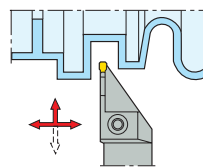
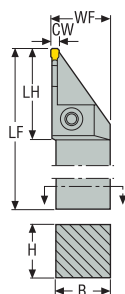

CF..2020, 2525



- Right-hand version shown
- For inserts program, see page(s) 193-195
- CUTDIA – Due to the design, grooving depth is limited, see catalog Turning
- CW = indicative Cutting Width, may vary depending on the chosen insert

Designation	Item number	H	B	LF	WF	LH	CW	CUTDIA	Weight	CTWS
		mm	mm	mm	mm	mm	mm	mm	kg	
CFOR1212M03	00053367	12,0	12,0	150,0	12,0	32,1	3,0	37,0	0,2	LC..1603..
CFOL1212M03	00053357	12,0	12,0	150,0	12,0	32,1	3,0	37,0	0,2	LC..1603..
CFTR1616M03	00054058	16,0	16,0	150,0	16,0	42,0	3,0	50,0	0,3	LC..1603..
CFTR2020K03	00054060	20,0	20,0	125,0	21,5	43,0	3,0	50,0	0,4	LC..1603..
CFTR2525M03	00054066	25,0	25,0	150,0	26,5	42,5	3,0	50,0	0,7	LC..1603..
CFTL1616M03	00054057	16,0	16,0	150,0	16,0	42,0	3,0	50,0	0,3	LC..1603..
CFTL2020K03	00054059	20,0	20,0	125,0	21,5	43,0	3,0	50,0	0,4	LC..1603..
CFTL2525M03	00054063	25,0	25,0	150,0	26,5	42,5	3,0	50,0	0,7	LC..1603..

Spare Parts, included in delivery

For holders	Clamp key	Clamp screw
		
CFOR/L...-03	3SMS795	TCEI0409
CFTR/L...-03	4SMS795	TCEI0513

MDT Toolholders, external

Toolholders for inserts LCGF, LCGN, LCMF and LCMR

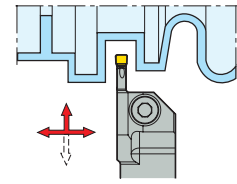
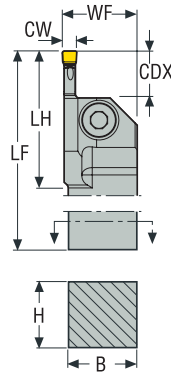

- Right-hand version shown
- For inserts program, see page(s) 193-195
- CDX – Max depth of cut for LCGF/LCMF16.. = 14 mm, LCGF/LCMF30.. = 28
- CP – Max coolant pressure (bar) using hose connection
- CW = indicative Cutting Width, may vary depending on the chosen insert

CFIR/L CDX = 3 x CW
CFMR/L CDX = 5 x CW

Designation	Item number	H	B	LF	WF	LH	CDX	CW	CP	Weight	CTWS
		mm	mm	mm	mm	mm	mm	mm	mm	kg	
CFIR3225P03JET	02599873	32,0	25,0	170,0	26,5	33,0	9,0	3,0	275,0	1,0	LC..1603..
CFIL3225P03JET	02599874	32,0	25,0	170,0	26,5	33,0	9,0	3,0	275,0	1,0	LC..1603..
CFMR3225P03JET	02702825	32,0	25,0	170,0	26,5	41,0	15,0	3,0	275,0	1,0	LC..1603..
CFML3225P03JET	02702829	32,0	25,0	170,0	26,5	41,0	15,0	3,0	275,0	1,0	LC..1603..

Spare Parts, included in delivery

For holders	Clamp key	Clamp screw	Plug
CFIR/L..-03	4SMS795	TCEI0513	JET-P1/8-5MM
CFMR/L..-03	4SMS795	TCEI0513	JET-P1/8-5MM

Thread turning

MDT

Mini-Shaft™

Thread milling

Thread tapping

Annex

MDT Toolholders, internal

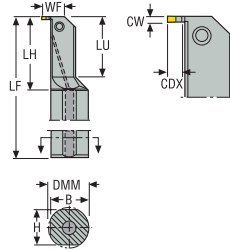
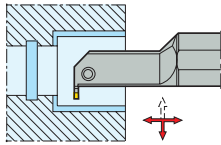

Toolholders for inserts LCGF, LCGN, LCMF and LCMR



- Right-hand version shown
- For inserts program, see page(s) 193-195
- DCINN - minimum bore diameter
- CW = indicative Cutting Width, may vary depending on the chosen insert

Designation	Item number	H	B	LF	CW	WF	LH	CDX	DCINN	Weight	CTWS
		mm	mm	mm	mm	mm	mm	mm	mm	kg	
A32T-CGIR1603	02717661	30,0	31,0	300,0	3,0	24,0	60,0	9,0	32,0	1,6	LC..1603..
A32T-CGIL1603	02718385	30,0	31,0	300,0	3,0	24,0	60,0	9,0	32,0	1,6	LC..1603..

Spare Parts, included in delivery

For holders	Clamp key	Clamp screw
		
CG.R/L..03	T15P-7	L85011-T15P

MDT Toolholders, internal

Toolholders for inserts LCGF, LCGN, LCMF and LCMR

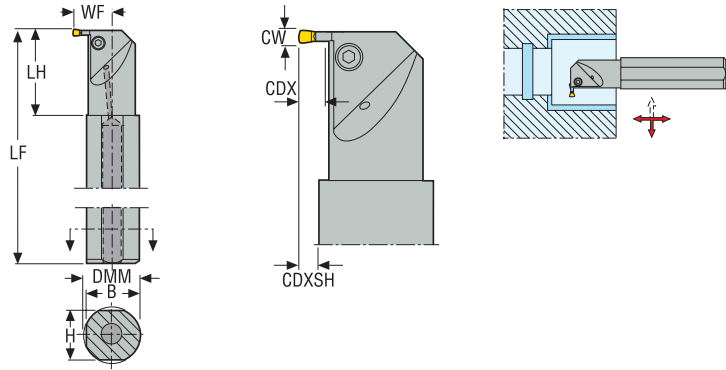

- Right-hand version shown
- For inserts program, see page(s) 193-195
- DCINN - minimum bore diameter
- CDXSH - If toolholder enters bore more than LH
- CW = indicative Cutting Width, may vary depending on the chosen insert

$$CDX = 2 \times CW$$

Designation	Item number	H	B	LF	CW	WF	LH	CDX	DCINN	CDXSH	DMM	Weight	CTWS
		mm	mm	mm	mm	mm	mm	mm	mm	mm	mm	kg	
A40T-CGGR03	00093896	37,0	38,5	300,0	3,0	26,0	60,0	6,0	45,0	5,5	40,0	2,5	LC..1603..
A40T-CGGL03	00093897	37,0	38,5	300,0	3,0	26,0	60,0	6,0	45,0	5,5	40,0	2,5	LC..1603..

Spare Parts, included in delivery

For holders	Clamp key	Clamp screw
-.03	3SMS795	MC6S4X14

Thread turning

MDT

Mini-Shaft™

Thread milling

Thread tapping

Annex

MDT Toolholders, internal

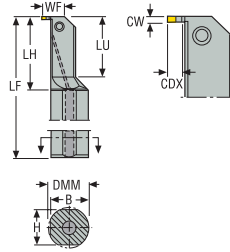
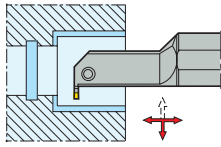

Toolholders for inserts LCGF, LCGN, LCMF and LCMR



- Right-hand version shown
- For inserts program, see page(s) 193-195
- DCINN - minimum bore diameter
- CW = indicative Cutting Width, may vary depending on the chosen insert

Designation	Item number	B	H	LF	LH	WF	LU	DCINN	CW	CDX	Weight	CTWS
		<i>Inch</i>	<i>Inch</i>	<i>Inch</i>	<i>Inch</i>	<i>Inch</i>	<i>Inch</i>	<i>Inch</i>	<i>Inch</i>	<i>Inch</i>	<i>lbs</i>	
A20-CGIR03	02717401	1.211	1.171	12.000	2.362	0.929	1.969	1.260	0.118	0.354	3.530	LC..1603..
A20-CGIL03	02718392	1.211	1.171	12.000	2.362	0.929	1.969	1.260	0.118	0.354	3.530	LC..1603..

Spare Parts, included in delivery

For holders	Clamp key	Clamp screw
		
..03	T15P-7	L85011-T15P

MDT Blades modular

Blades for inserts LCGF, LCGN, LCMF and LCMR

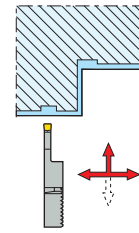
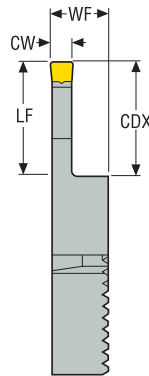

- Right-hand version shown
- For inserts program, see page(s) 193-195
- CDX – Max depth of cut for LCGF/LCMF13.. = 11 mm, LCGF/LCMF16.. = 14 mm
- CW = indicative Cutting Width, may vary depending on the chosen insert

Designation	Item number	LF	WF	CW	CDX	Weight	CTWS
		mm	mm	mm	mm	kg	
V21-CMR1603	00030310	16,2	9,2	3,0	15,0	0,1	LC..1603..
V21-CML1603	02719038	16,2	9,2	3,0	15,0	0,1	LC..1603..

Thread turning

MDT

Mini-Shaft™

Thread milling

Thread tapping

Annex

MDT Inserts LCGN – Partial profile 55°

Tolerances:
LIG = ±0,025
RE = ±0,025
Helix angle not to exceed $\lambda + 2^\circ$

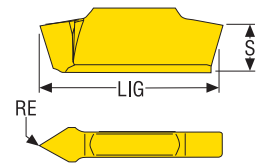
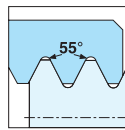

Designation	Pitch		RE	LIG	S	Grades				
						Coated				Uncoated
						mm	TPI	mm <i>Inch</i>	mm <i>Inch</i>	mm <i>Inch</i>
LCGN1603-A55	0,5-1,5	48-16	0,08 <i>0.003</i>	16,6 <i>0.654</i>	4,5 <i>0.177</i>			■		
LCGN1603-G55	1,75-3	14-8	0,18 <i>0.007</i>	16,6 <i>0.654</i>	4,5 <i>0.177</i>			■		

■ Stock standard.

Thread turning

MDT

Mini-Shaft™

Thread milling

Thread tapping

Annex

MDT Inserts LCGN – Partial profile 60°

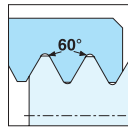
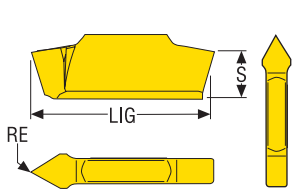

Tolerances:
LIG = $\pm 0,025$
RE = $\pm 0,025$
Helix angle not to exceed $\lambda + 2^\circ$

Designation	Pitch		RE	LIG	S	Grades				
	mm	TPI				Coated				Uncoated
	mm	TPI	mm <i>Inch</i>	mm <i>Inch</i>	mm <i>Inch</i>	CP200	CP300	CP500	TTP2050	H15
LCGN1603-A60	0,5-1,5	48-16	0,08 <i>0.003</i>	16,6 <i>0.654</i>	4,5 <i>0.177</i>			■		
LCGN1603-G60	1,75-3	14-8	0,18 <i>0.007</i>	16,6 <i>0.654</i>	4,5 <i>0.177</i>			■		

■ Stock standard.

Thread turning

MDT

Mini-Shaft™

Thread milling

Thread tapping

Annex

MDT Inserts – LCGN – ISO Metric

Tolerances:
LIG = ±0,025
Helix angle not to exceed λ +2°

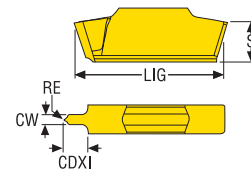
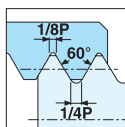

Designation	Note	Pitch		RE	LIG	S	CW	CDXI	Grades				
									Coated				Uncoated
									mm	TPI	mm Inch	mm Inch	mm Inch
LCGN1603-E0.5ISO	*	0,5	–	0,07 0.003	16,6 0.654	4,5 0.177	0,75 0.030	1,9 0.075			■		
LCGN1603-E0.8ISO	*	0,8	–	0,11 0.004	16,6 0.654	4,5 0.177	1,2 0.047	3,0 0.118			■		
LCGN1603-E1.0ISO	*	1,0	–	0,13 0.005	16,6 0.654	4,5 0.177	1,5 0.059	3,75 0.148			■		
LCGN1603-E1.25ISO	*	1,25	–	0,17 0.007	16,6 0.654	4,5 0.177	1,88 0.074	4,2 0.165			■		
LCGN1603-E1.5ISO	–	1,5	–	0,21 0.008	16,6 0.654	4,5 0.177	2,4 0.094	0,92 0.036			■		

*Toolholders have to be modified
■ Stock standard.

Thread turning

MDT

Mini-Shaft™

Thread milling

Thread tapping

Annex



Thread turning Mini-Shaft™

The highly versatile Mini-Shaft™ consists of inserts and holders providing stable, high-precision internal threading operations. Mini-Shaft™ features a special double-serrated joint that creates a secure connection point for its exchangeable inserts and toolholders, resulting in a repeatability of +/- 0.02 mm (+/- .0008 inch).

- All toolholders can accommodate R- and L-handed inserts
- Through coolant possibility
- Use in holes as small as 8 mm (0.315 inch)

Mini-Shaft™ Holders

Toolholders for inserts LCEX

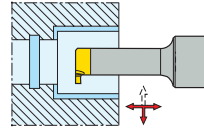
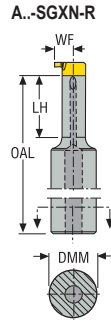
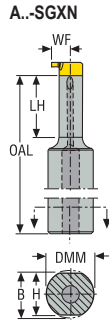

- Right-hand version shown
- For inserts program, see page(s)200-206

Designation	Item number	H	B	OAL	WF	LH	DMM	DCINN	Weight	CTWS
		mm	mm	mm	mm	mm	mm	mm	kg	
A12G-SGXN08-20	02411140	11	12	86,5	4,8	16,5	12,0	8,0	0,1	LCEX08..
A12G-SGXN08-20-R	02511871	–	–	86,5	4,8	16,5	12,0	8,0	0,1	LCEX08..
A16H-SGXN11-25	02411142	15	16	96,0	6,7	21,0	16,0	11,0	0,2	LCEX11..
A16H-SGXN11-25-R	02511872	–	–	96,0	6,7	21,0	16,0	11,0	0,2	LCEX11..

Spare Parts, included in delivery

For holders	Insert key	Insert screw
A12G-..	 T08P-2	 C02506-T08P
A16H-..	 T10P-2	 C03509-T10P

Thread turning

MDT

Mini-Shaft™

Thread milling

Thread tapping

Annex

Mini-Shaft™ Holders

Toolholders for inserts LCEX

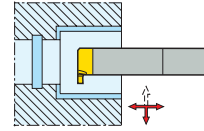
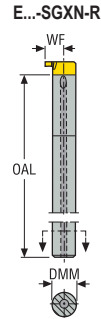
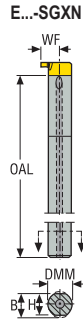

- Right-hand version shown
- For inserts program, see page(s)200-206

Designation	Item number	H	B	OAL	WF	DMM	DCINN	Weight	CTWS
		mm	mm	mm	mm	mm	mm	kg	
E06G-SGXN08	02411141	6	6	86,5	4,8	6,0	8,0	0,1	LCEX08..
E06G-SGXN08-R	02513692	–	–	86,5	4,8	6,0	8,0	0,1	LCEX08..
E08H-SGXN11	02411143	7	8	96,0	6,7	8,0	11,0	0,1	LCEX11..
E08H-SGXN11-R	02513696	–	–	96,0	6,7	8,0	11,0	0,1	LCEX11..

Spare Parts, included in delivery

For holders	Insert key	Insert screw
E06G-..	 T08P-2	 C02506-T08P
E08H-..	 T10P-2	 C03509-T10P

Thread turning

MDT

Mini-Shaft™

Thread milling

Thread tapping

Annex

SGXN Mini-Shaft™ Holders

Toolholders for inserts LCEX

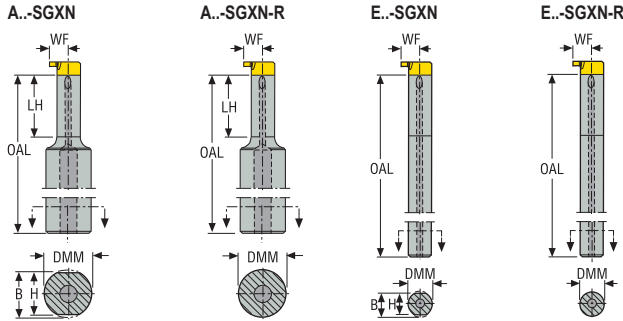

- Right-hand version shown
- For inserts program, see page(s)200-206

Designation	Item number	B	H	OAL	LH	WF	DCINN	DMM	Weight	CTWS
		<i>Inch</i>	<i>Inch</i>	<i>Inch</i>	<i>Inch</i>	<i>Inch</i>	<i>Inch</i>	<i>Inch</i>	<i>lbs</i>	
A10G-SGXN08-078	02450441	0.605	0.586	3.406	0.650	0.188	0.315	0.625	0.220	LCEX08..
E04G-SGXN08	02450442	0.233	0.217	3.406	-	0.189	0.315	0.250	0.220	LCEX08..
A10H-SGXN11-098	02450443	0.605	0.586	3.780	0.827	0.264	0.433	0.625	0.440	LCEX11..
E05H-SGXN11	02450445	0.300	0.287	3.780	-	0.264	0.433	0.312	0.220	LCEX11..
A10G-SGXN08-078-R	02511873	-	-	3.406	0.650	0.188	0.315	0.625	0.220	LCEX08..
A10H-SGXN11-098-R	02511874	-	-	3.780	0.827	0.264	0.433	0.625	0.440	LCEX11..
E04G-SGXN08-R	02513700	-	-	3.406	-	0.189	0.315	0.250	0.220	LCEX08..
E05H-SGXN11-R	02513704	-	-	3.780	-	0.264	0.433	0.312	0.220	LCEX11..

Spare Parts, included in delivery

For holders	Insert key	Insert screw
A10G-../E04G-..	T08P-2	C02506-T08P
A10H-../E05H-..	T10P-2	C03509-T10P

Thread turning

MDT

Mini-Shaft™

Thread milling

Thread tapping

Annex

Mini-Shaft™ Inserts

Partial profile 60°

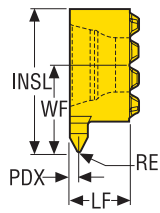

Designation	Pitch		RE	PDX	WF	INSL	LF	Grades					
								Coated				Uncoated	
								CP200	CP300	CP500	TTP2050	H15	
	mm	TPI	mm <i>Inch</i>	mm <i>Inch</i>	mm <i>Inch</i>	mm <i>Inch</i>	mm <i>Inch</i>						
LCEX0804-A60R	0,5-0,75	48-36	0,03 <i>0.001</i>	0,48 <i>0.019</i>	4,78 <i>0.188</i>	7,78 <i>0.306</i>	3,3 <i>0.130</i>			■			
LCEX0804-A60L	0,5-0,75	48-36	0,03 <i>0.001</i>	0,48 <i>0.019</i>	4,78 <i>0.188</i>	7,78 <i>0.306</i>	3,3 <i>0.130</i>			■			
LCEX1105-A60R	0,5-0,75	48-36	0,03 <i>0.001</i>	0,48 <i>0.019</i>	6,7 <i>0.264</i>	10,7 <i>0.421</i>	4,0 <i>0.157</i>			■			
LCEX1105-A60L	0,5-0,75	48-36	0,03 <i>0.001</i>	0,48 <i>0.019</i>	6,7 <i>0.264</i>	10,7 <i>0.421</i>	4,0 <i>0.157</i>			■			
LCEX0804-AG60R	0,75-1,25	36-20	0,07 <i>0.003</i>	0,73 <i>0.029</i>	4,78 <i>0.188</i>	7,78 <i>0.306</i>	3,3 <i>0.130</i>			■			
LCEX0804-AG60L	0,75-1,25	36-20	0,07 <i>0.003</i>	0,73 <i>0.029</i>	4,78 <i>0.188</i>	7,78 <i>0.306</i>	3,3 <i>0.130</i>			■			
LCEX1105-AG60R	0,75-1,25	36-20	0,07 <i>0.003</i>	0,73 <i>0.029</i>	6,7 <i>0.264</i>	10,7 <i>0.421</i>	4,0 <i>0.157</i>			■			
LCEX1105-AG60L	0,75-1,25	36-20	0,07 <i>0.003</i>	0,73 <i>0.029</i>	6,7 <i>0.264</i>	10,7 <i>0.421</i>	4,0 <i>0.157</i>			■			
LCEX0804-G60R	1,25-1,75	20-16	0,12 <i>0.005</i>	0,98 <i>0.039</i>	4,78 <i>0.188</i>	7,78 <i>0.306</i>	3,3 <i>0.130</i>			■			
LCEX0804-G60L	1,25-1,75	20-16	0,12 <i>0.005</i>	0,98 <i>0.039</i>	4,78 <i>0.188</i>	7,78 <i>0.306</i>	3,3 <i>0.130</i>			■			
LCEX1105-G60R	1,25-1,75	16-20	0,12 <i>0.005</i>	0,98 <i>0.039</i>	6,7 <i>0.264</i>	10,7 <i>0.421</i>	4,0 <i>0.157</i>			■			
LCEX1105-G60L	1,25-1,75	20-16	0,12 <i>0.005</i>	0,98 <i>0.039</i>	6,7 <i>0.264</i>	10,7 <i>0.421</i>	4,0 <i>0.157</i>			■			

■ Stock standard.

Thread turning

MDT

Mini-Shaft™

Thread milling

Thread tapping

Annex

Mini-Shaft™ Inserts

ISO Metric

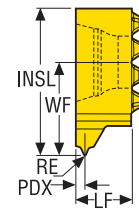

Designation	Pitch		RE	PDX	WF	INSL	LF	Grades				
								Coated				Uncoated
								CP200	CP300	CP500	TTP2050	H15
LCEX1105-1.0ISOR	1	–	0,07 0.003	0,6 0.024	6,7 0.264	10,7 0.421	4,0 0.157			■		
LCEX1105-1.0ISOL	1	–	0,07 0.003	0,6 0.024	6,7 0.264	10,7 0.421	4,0 0.157			■		
LCEX1105-1.5ISOR	1,5	–	0,12 0.005	0,85 0.033	6,7 0.264	10,7 0.421	4,0 0.157			■		
LCEX1105-1.5ISOL	1,5	–	0,12 0.005	0,8 0.031	6,7 0.264	10,7 0.421	4,0 0.157			■		
LCEX1105-2.0ISOR	2	–	0,17 0.007	1,1 0.043	6,7 0.264	10,7 0.421	4,0 0.157			■		
LCEX1105-2.0ISOL	2	–	0,17 0.007	1,1 0.043	6,7 0.264	10,7 0.421	4,0 0.157			■		
LCEX1105-2.5ISOR	2,5	–	0,18 0.007	1,35 0.053	6,7 0.264	10,7 0.421	4,0 0.157			■		
LCEX1105-2.5ISOL	2,5	–	0,18 0.007	1,35 0.053	6,7 0.264	10,7 0.421	4,0 0.157			■		
LCEX1105-3.0ISOR	3	–	0,21 0.008	1,6 0.063	6,7 0.264	10,7 0.421	4,0 0.157			■		
LCEX1105-3.0ISOL	3	–	0,21 0.008	1,6 0.063	6,7 0.264	10,7 0.421	4,0 0.157			■		

■ Stock standard.

Thread turning

MDT

Mini-Shaft™

Thread milling

Thread tapping

Annex

Mini-Shaft™ Inserts

Whitworth, BSW

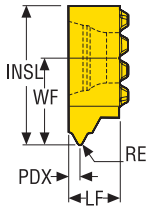

..L



..R



Designation	Pitch		RE	PDX	WF	INSL	LF	Grades				
								Coated				Uncoated
								CP200	CP300	CP500	TTP2050	H15
LCEX1105-14WR	–	14	0,24 0.009	1,0 0.039	6,7 0.264	10,7 0.421	4,0 0.157			■		
LCEX1105-14WL	–	14	0,24 0.009	1,0 0.039	6,7 0.264	10,7 0.421	4,0 0.157			■		
LCEX1105-19WR	–	19	0,15 0.006	0,77 0.030	6,7 0.264	10,7 0.421	4,0 0.157			■		
LCEX1105-19WL	–	19	0,15 0.006	0,77 0.030	6,7 0.264	10,7 0.421	4,0 0.157			■		

■ Stock standard.

Thread turning

MDT

Mini-Shaft™

Thread milling

Thread tapping

Annex

Mini-Shaft™ Inserts

TR-DIN103

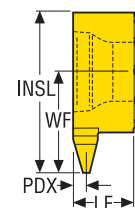

..RL



..RR



Designation	Pitch		RE	PDX	WF	INSL	LF	Grades				
								Coated				Uncoated
								CP200	CP300	CP500	TTP2050	
LCEX1105-1.5TRR	1,5	–	0,1 <i>0.004</i>	0,8 <i>0.031</i>	6,7 <i>0.264</i>	10,7 <i>0.421</i>	4,0 <i>0.157</i>			■		
LCEX1105-1.5TRL	1,5	–	0,1 <i>0.004</i>	0,8 <i>0.031</i>	6,7 <i>0.264</i>	10,7 <i>0.421</i>	4,0 <i>0.157</i>			■		
LCEX1105-2.0TRR	2	–	0,15 <i>0.006</i>	1,1 <i>0.043</i>	6,7 <i>0.264</i>	10,7 <i>0.421</i>	4,0 <i>0.157</i>			■		
LCEX1105-2.0TRL	2	–	0,15 <i>0.006</i>	1,1 <i>0.043</i>	6,7 <i>0.264</i>	10,7 <i>0.421</i>	4,0 <i>0.157</i>			■		
LCEX1105-3.0TRR	3	–	0,15 <i>0.006</i>	1,6 <i>0.063</i>	6,7 <i>0.264</i>	10,7 <i>0.421</i>	4,0 <i>0.157</i>			■		
LCEX1105-3.0TRL	3	–	0,15 <i>0.006</i>	1,6 <i>0.063</i>	6,7 <i>0.264</i>	10,7 <i>0.421</i>	4,0 <i>0.157</i>			■		

■ Stock standard.

Thread turning

MDT

Mini-Shaft™

Thread milling

Thread tapping

Annex

Mini-Shaft™ Inserts

UN

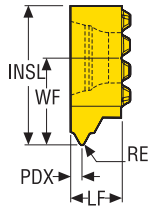

..L



..R



Designation	Pitch		RE	PDX	WF	INSL	LF	Grades				
								Coated				Uncoated
								CP200	CP300	CP500	TTP2050	H15
LCEX0804-16UNR	–	16	0,13 0.005	0,9 0.035	4,78 0.188	7,78 0.306	3,3 0.130			■		
LCEX0804-16UNL	–	16	0,13 0.005	0,9 0.035	4,78 0.188	7,78 0.306	3,3 0.130			■		
LCEX0804-20UNR	–	20	0,09 0.004	0,7 0.028	4,78 0.188	7,78 0.306	3,3 0.130			■		
LCEX0804-20UNL	–	20	0,09 0.004	0,7 0.028	4,78 0.188	7,78 0.306	3,3 0.130			■		
LCEX0804-24UNR	–	24	0,07 0.003	0,6 0.024	4,78 0.188	7,78 0.306	3,3 0.130			■		
LCEX0804-24UNL	–	24	0,07 0.003	0,6 0.024	4,78 0.188	7,78 0.306	3,3 0.130			■		
LCEX0804-32UNR	–	32	0,04 0.002	0,5 0.020	4,78 0.188	7,78 0.306	3,3 0.130			■		
LCEX0804-32UNL	–	32	0,04 0.002	0,5 0.020	4,78 0.188	7,78 0.306	3,3 0.130			■		

■ Stock standard.

Thread turning

MDT

Mini-Shaft™

Thread milling

Thread tapping

Annex

Mini-Shaft™ Inserts

NPT

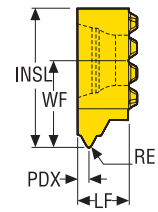

..R



Designation	Pitch		RE	PDX	WF	INSL	LF	Grades				
								Coated				Uncoated
								CP200	CP300	CP500	TTP2050	H15
LCEX0804-27NPTR	mm	TPI	mm <i>Inch</i>	mm <i>Inch</i>	mm <i>Inch</i>	mm <i>Inch</i>	mm <i>Inch</i>			■		
	-	27	0,03 <i>0.001</i>	0,57 <i>0.022</i>	4,78 <i>0.188</i>	7,78 <i>0.306</i>	3,3 <i>0.130</i>					

■ Stock standard.

Thread turning

MDT

Mini-Shaft™

Thread milling

Thread tapping

Annex

Mini-Shaft™ Inserts

NPTF

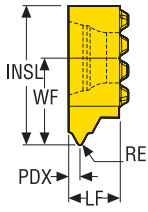

Designation	Pitch		RE	PDX	WF	INSL	LF	Grades				
								Coated				Uncoated
								CP200	CP300	CP500	TTP2050	H15
LCEX0804-27NPTFR	–	27	0,04 0.002	0,57 0.022	4,78 0.188	7,78 0.306	3,3 0.130			■		
LCEX0804-27NPTFL	–	27	0,04 0.002	0,57 0.022	4,78 0.188	7,78 0.306	3,3 0.130			■		

■ Stock standard.

Thread turning

MDT





Mini-Shaft™

Thread milling

Thread tapping

Annex

Range overview

Threading	Ø Range	Length
<p>Threadmaster™</p>  <p>216, 217-220, 221</p>	<p>M1-M20</p>	<p>~ 1,5-2 x D</p>
<p>R396.18/19/20</p>  <p>231-236</p>	<p>14 ≤</p>	<p>~ 2 - 3.5 x D</p>
<p>R335.14</p>  <p>243-245</p>	<p>12 <</p>	<p>~1xD <</p>
<p>Threadmaster™ Taps</p>  <p>260-473</p>	<p>M1-M64</p>	<p>~ 1,5-3,5 x D</p>

Thread turning

MDT

Mini-Shaft™

Thread milling

Thread tapping

Annex

Versatile & Specific

Thread milling and Tapping – Choice of tool

Continuous research and development of better materials, coatings and optimal geometries help fulfil customer's requirements.

Our product strategy is to provide the market with versatile first choice tools and specific optimized solutions for threading.

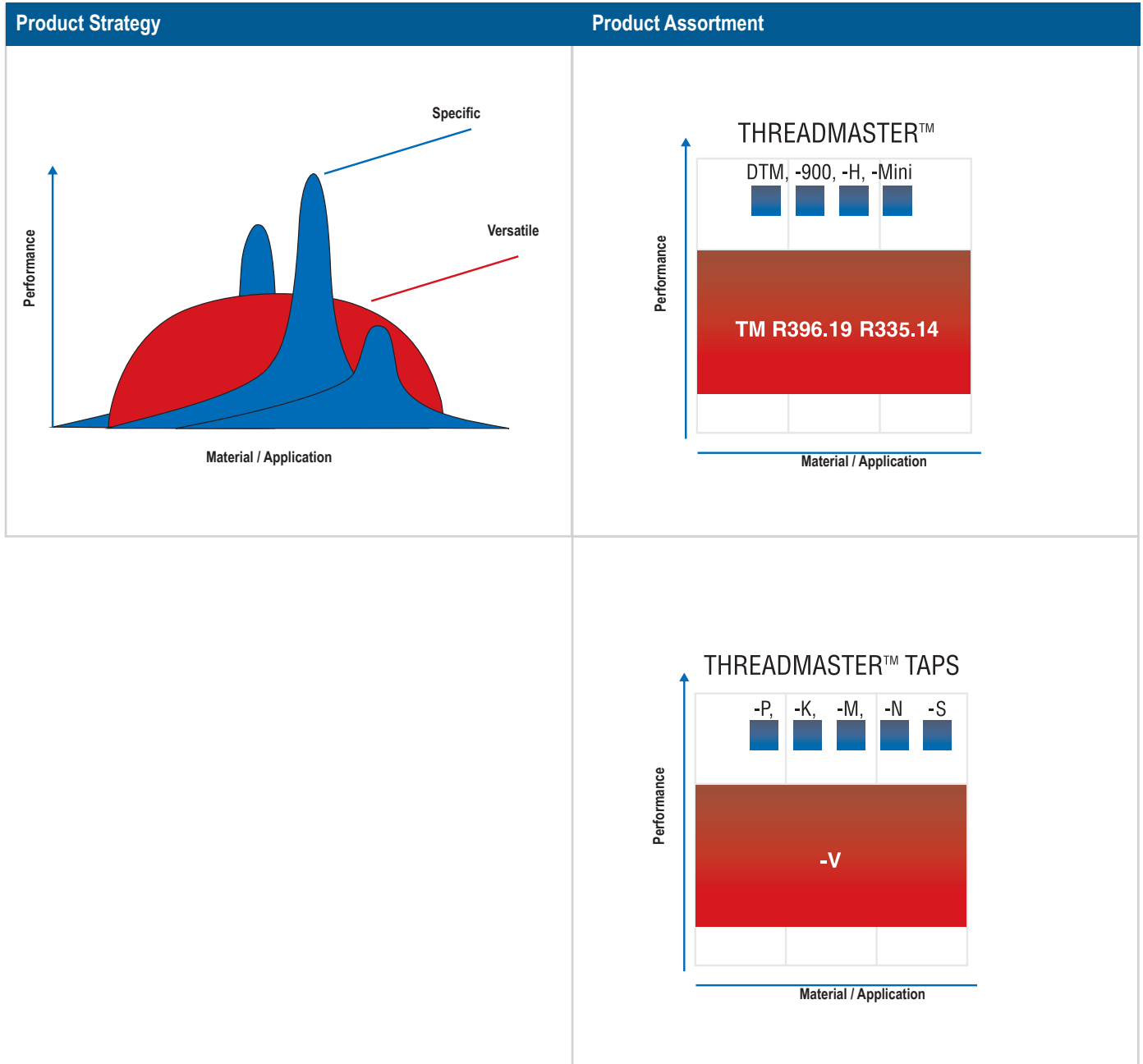

Thread turning

MDT

Mini-Shaft™

Thread milling

Thread tapping

Annex

Thread milling – Choice of cutter, inserts and cutting data

Solid carbide cutter – Threadmaster™

1. General

The same cutter can be used for machining both right and left hand threads. Metric and UN versions are only for internal threading. The remaining of the range can be used for both external and internal threading.

- The cutters are regrindable

2. Select cutter diameter

- Look up the pages with the Threadmaster programmes
- Look up the column for the required thread type
- Look up the required pitch
- When more alternatives are available note that:
 - Smaller cutter diameter allows smaller threading diameter (minimum thread diameter is found in the designation).
 - Larger cutter diameter allows larger threading depth (maximum threading depth is 2 x cutter diameter, D_c).

3. Selection of cutter

- TM: Basic choice
- TM...-900: Choice for steel and stainless steel with tensile strength > 900 N/mm²
- TM...-H: Choice for hardened steel with hardness 45-60 HRC
- DTM: Drill, thread and chamfer with same tool. To be used in aluminium and cast iron

4. Select cutting data

- Use the tables beginning on page 474 to classify the workpiece material into a SMG (Seco Material Group)
- Cutting speed recommendations are found on the cutting data page for Threadmaster
- Feed per tooth (= flute) recommendations are found on the cutting data page for Threadmaster
- Formulae for cutting data calculation are on page 211
- For best suggestion and performance use Seco Suggest <https://www.secotools.com/dashboard/Suggest/Suggest>.

5. Machining methods

- Helical interpolation must be used to create the pitch
- Clockwise or counterclockwise feed direction can be used depending on thread type and machining method (right or left hand), external or internal thread
- Climb milling is recommended
- Coolant supply is recommended. Except when threading hardened material
- Special machining recommendations for certain workpiece materials are found on the cutting data page for Threadmaster

Feed recommendations

Threadmaster™

- Feed recommendations for TM-M4X0.7ISO-6R1 except for TM-Mini, that recommendation is for TM-M1.0X0.25ISO-3R1-H and only a start value
- For best suggestion and performance use Seco Suggest <https://www.secotools.com/dashboard/Suggest/Suggest>
- All feed are related to the centre of the cutter and not the periphery
- In the entrance loop reduce feed by 50%. In the exit loop increase feed by 50%
- In the entrance and exit loop feed the cutter 15% of the pitch axially
- For free cutting steel, low alloy and ferritic steel, quench & temper steel, low to medium alloy stainless steels and austenitic cast irons, leave 0,05 mm in a_p for a finishing cut
- For high strength steels, martensitic and high alloy stainless steels, Ni-based superalloys and titanium alloys remove 2/3 of a_p in the first cut and the remaining 1/3 in the second cut
- For hardened steels remove 1/3 of a_p in the first cut, 1/3 of a_p in the second cut and the remaining 1/3 in the third cut
- For NPT and NPTF threads take the whole a_p in one cut
- Coolant is recommended (except when using -H in hardened materials)
- The Metric and UN thread mills are only for internal threads

TM-Mini:

- Left-hand cutting (M4)
- Do the entrance loop before entering into the workpiece

DTM:

- Use peck drilling

Choice of cutter, inserts and cutting data

1. General

- The same cutter can be used for machining external and internal, right-hand and left-hand threads

2. Select cutter diameter

- Look up the pages for thread milling cutters and choose a suitable diameter in the tool data table
- The insert size varies with the cutter diameters. Check the available insert programme for the different sizes before deciding cutter diameter
- For internal thread milling check the 'minimum thread diameter' table before deciding cutter diameter. This table shows the relation between the cutter diameter and the smallest thread diameter to be machined

3. Select insert

- Look up the thread milling inserts pages and choose the required thread type in the correct insert size for the cutter. Choose the grade F30M/CP500 for general machining

4. Select cutting data

Radial cutting depth

- Use the formulae to calculate the radial cutting depth (a_e). (See figures)

Feed rate

- Divide the radial cutting depth with the cutter diameter to get the actual cutter engagement percentage ($a_e/D_c\%$). Use the cutting data table to get a feed per tooth recommendation, see page(s) 222 - 227.

Cutting speed

- Use the tables beginning at page 474 to classify the workpiece material into a Seco Material Group.
- Cutting speed recommendations (for 10% engagement) are in the basic cutting speed table in the catalogue
- For safety reasons, maximum rpm that should never be exceeded
- Formulae for cutting data calculation are found on page 211

5. Machining methods

- Helical interpolation must be used to create the pitch
- Clockwise or counterclockwise feed direction can be used depending on thread type and machining method (right or left hand, external or internal thread)
- Climb milling and coolant is recommended. Coolant supply is recommended except when threading hardened material

Internal

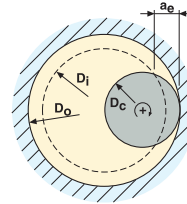
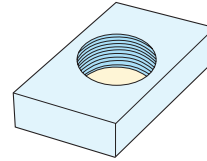

$$D_i = D_o - 2h$$

Thread	
ISO	0,60 x p
UN	0,60 x p
W	0,69 x p
BSPT	0,69 x p
NPT	0,78 x p

Radial infeed value a_e :

$$a_e = \frac{D_o^2 - D_i^2}{4 (D_o - D_c)}$$

p = pitch (mm)
h = depth of thread

D_c = Cutter dia
 D_o = Major dia
 D_i = Minor dia

External

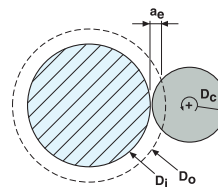
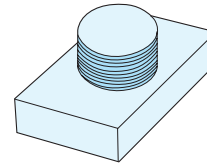

$$D_i = D_o - 2h$$

Thread	
ISO	0,65 x p
UN	0,65 x p
W	0,69 x p
BSPT	0,69 x p
NPT	0,78 x p

Radial infeed value a_e :

$$a_e = \frac{D_o^2 - D_i^2}{4 (D_i + D_c)}$$

p = pitch (mm)
h = depth of thread

D_c = Cutter dia
 D_o = Major dia
 D_i = Minor dia

Choice of cutter, inserts and cutting data

RPM	
$n = \frac{v_c \cdot 1000}{\pi \cdot D_c}$	(rev/min)
Cutting speed	
$v_c = \frac{n \cdot \pi \cdot D_c}{1000}$	(m/min)
Feed speed	
$v_f = n \cdot Z_n \cdot f_z$	(mm/min)
$v_f = n \cdot Z_c \cdot f_z$	(mm/min)
Feed per revolution	
$f = Z_n \cdot f_z$	(mm/rev)
$f = Z_c \cdot f_z$	(mm/rev)

RPM	
$n = \frac{v_c \cdot 3.82}{D_c}$	(rev/min)
Cutting speed	
$v_c = \frac{n \cdot D_c}{3.82}$	(sf/min)
Feed speed	
$v_f = n \cdot Z_n \cdot f_z$	(in/min)
$v_f = n \cdot Z_c \cdot f_z$	(in/min)
Feed per revolution	
$f = Z_n \cdot f_z$	(in/rev)
$f = Z_c \cdot f_z$	(in/rev)

D_c	= Cutter diameter (mm)
f	= Feed per revolution (mm)
f_z	= Feed per tooth (mm/tooth)
Z_c	= Effective No. of teeth for calculation of feed speed or feed per rev
n	= RPM (rev/min)
v_c	= Cutting speed (m/min)
v_f	= Feed speed (mm/min)
Z_n	= No. of teeth

D_c	= Cutter diameter (inch)
f	= Feed per revolution (inch)
f_z	= Feed per tooth (in/tooth)
Z_c	= Effective No. of teeth for calculation of feed speed or feed per rev
n	= RPM (rev/min)
v_c	= Cutting speed (sf/min)
v_f	= Feed speed (sf/min)
Z_n	= No. of teeth

Disc Milling cutter 335.14

Thread turning

MDT

Mini-Shaft™

Thread milling

Thread tapping

Annex

Disc milling cutter with exchangeable carbide head from diameter 9,7 mm (0.382")

A broad range of heads and shanks available for all your disc milling operation by circular interpolation or linear slotting.



Strong, reliable and precise connection between the head and the cutter body.



Cover all type of material with universal M geometry and F32M grade.

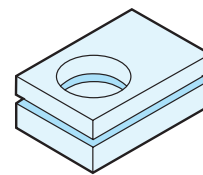

Threading:
Head from dia 11,7 to 27,7 mm (0.461 to 1.091") for partial metric threads with pitch 1-6 mm (0.039-0.236") and full profile whitworth threads with pitch 19 to 11 tpi and UN threads with pitch 24 to 6 tpi.



Deviation from standard thread profile

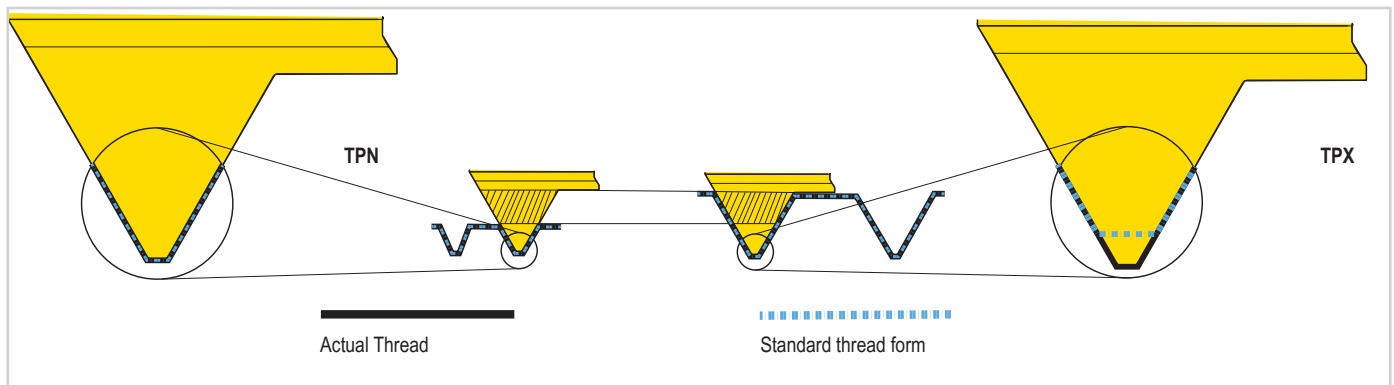

Thread milling by circular interpolation can cause thread profile violation when using insert designed for partial thread. Keep this in mind while selecting a tool. The tool diameter needs to be small enough compared to the hole diameter. The pitch also needs to be considered.

Insert with partial profile for Metric ISO-Threads are multi tools. That means that each insert could machine different pitches. The insert is designed to meet the minimum pitch size (TPN); Machining this pitch will result in a thread form that conforms to the standard.

The recommended maximum pitch size (TPX) can also be machined with this insert at the expense of standard conformity: The result will be a slightly deeper thread than the standard. The deeper thread is normally accepted, but the application and use needs to be evaluated.

Following table is a recommendation over maximum tool diameter in relation to the thread size and pitch:

ISO-Thread, partial profile											
Pitch	M12	M16	M20	M24	M27	M30	M36	M42	M48	M56	M60
1	10	14	18	22	25	28	34	40	45	53	57
1,5	8	12	16	20	24	26	32	37	43	51	55
2	7	10	14	18	22	24	30	35	40	48	52
2,5	6	8	12	16	20	22	28	32	37	45	48
3		6	10	14	18	20	26	30	36	43	47
3,5				12	16	18	24	29	35	42	46
4							22	27	32	39	43
4,5								24	30	37	40
5								22	27	34	37
5,5								20	25	31	35
6								19	23	29	32

Code key Threading insert

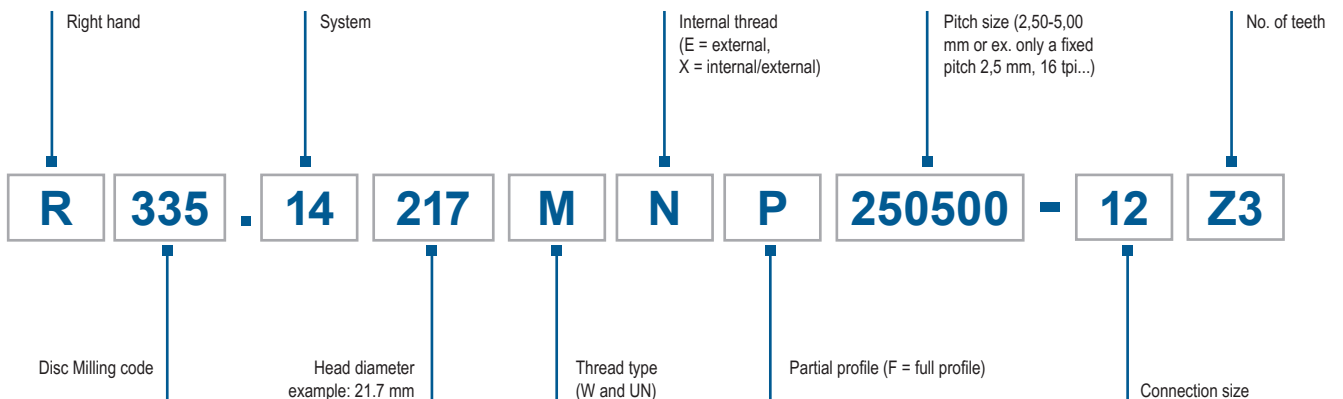

Application overview milling cutters

Solid carbide

Threadmaster™	
	
TM - Thread size M1-M20 Solid carbide thread milling cutters	
216, 217-220, 221	

Cutter with inserts

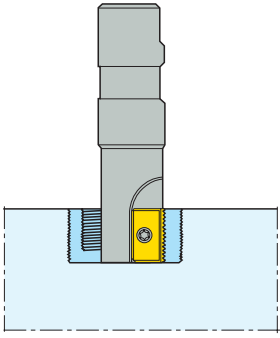
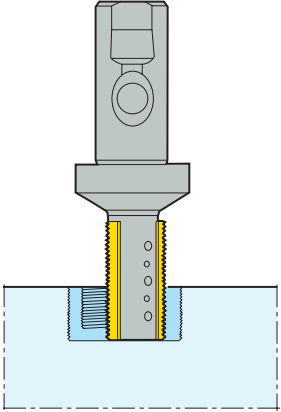
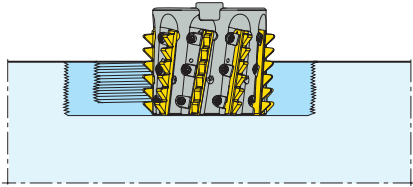
396.18	396.19	396.20
		
Ø 12 mm (0.472") Thread milling cutters with indexable insert	Ø 17-58 mm (0.669-2.283") Thread milling cutters with indexable inserts	Ø 63 mm (2.480") Thread milling cutters with indexable inserts
231-232	231-234	236

Cutter with changeable head

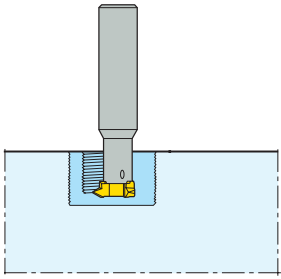
335.14

Ø 11,7-27,7 mm (0.461-1.091") Thread milling cutters with changeable head
243



Threadmaster™

Threadmaster™ thread mills provide high thread quality at low cost per hole. Machining up to 100 percent depth, Threadmasters have high helix angles that reduce cutting forces and eliminate chatter. They feature an excellent carbide substrate and TiCN-coating (TM and TM-900) or TiAlN-coating (TM-H and DTM) for high toughness and wear resistance milling aluminum, steel, stainless steel and cast iron.

Drilling Threadmaster is a multi-tool producing a thread by drilling and chamfering in a single pass for high thread quality at a low cost per hole.

- Some versions with through-coolant holes
- Threads range from M4 to M20
- Mini thread mills for thread sizes from M1 - M2.5

Threadmaster™

Solid carbide thread milling cutters

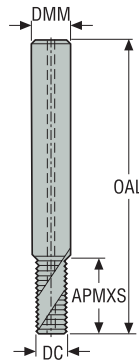

- For cutting data see page(s) 222
- TM; 2 x D
- Chamfer angle STA = 45°

- * = Metric coarse, for Internal Threading
- ** = Metric fine, for Internal Threading
- *** = UNC, for Internal Threading

Designation	Item number	TDZ	Pitch		Thread profile	DC	DMM	OAL	APMXS	NOF	Through coolant
			TPX	TPIX							
TM-M4X0.7ISO-6R1	02827408	M4	0,7	–	*	3,15 0.124	6,0 0.236	49,0 1.929	8,0 0.315	3	–
TM-M4X0.7ISO-6R1-900	02827358	M4	0,7	–	*	3,15 0.124	6,0 0.236	49,0 1.929	8,0 0.315	3	–
TM-M4X0.7ISO-6R1-H	02827349	M4	0,7	–	*	3,15 0.124	6,0 0.236	46,0 1.811	6,3 0.248	4	–
TM-M5X0.8ISO-6R1	02827407	M5	0,8	–	*	3,95 0.156	6,0 0.236	49,0 1.929	10,0 0.394	3	–
TM-M5X0.8ISO-6R1-900	02827359	M5	0,8	–	*	3,95 0.156	6,0 0.236	49,0 1.929	10,0 0.394	3	–
TM-M5X0.8ISO-6R1-H	02827350	M5	0,8	–	*	3,95 0.156	6,0 0.236	47,0 1.850	7,2 0.283	4	–
TM-M6X1.0ISO-6R1	02827406	M6	1,0	–	*	4,7 0.185	6,0 0.236	55,0 2.165	12,5 0.492	3	–
TM-M6X1.0ISO-6R1-900	02827360	M6	1,0	–	*	4,7 0.185	6,0 0.236	55,0 2.165	12,5 0.492	3	–
TM-M6X1.0ISO-6R1-H	02827351	M6	1,0	–	*	4,7 0.185	6,0 0.236	52,0 2.047	8,5 0.335	4	–
TM-M8X1.25ISO-8R1	02827405	M8	1,25	–	*	6,2 0.244	8,0 0.315	62,0 2.441	16,9 0.665	3	✓
TM-M8X1.25ISO-8R1-900	02827361	M8	1,25	–	*	6,2 0.244	8,0 0.315	62,0 2.441	16,9 0.665	3	✓
TM-M8X1.25ISO-8R1-H	02827352	M8	1,25	–	*	6,2 0.244	8,0 0.315	57,0 2.244	12,5 0.492	4	–
TM-M10X1.5ISO-10R1	02827404	M10	1,5	–	*	7,8 0.307	10,0 0.394	74,0 2.913	20,3 0.799	3	✓
TM-M10X1.5ISO-10R1-900	02827362	M10	1,5	–	*	7,8 0.307	10,0 0.394	74,0 2.913	20,3 0.799	3	✓
TM-M10X1.5ISO-10R1-H	02827353	M10	1,5	–	*	7,8 0.307	10,0 0.394	66,0 2.598	15,0 0.591	5	–
TM-M12X1.75ISO-12R1	02827403	M12	1,75	–	*	9,4 0.370	12,0 0.472	79,0 3.110	25,4 1.000	3	✓
TM-M12X1.75ISO-12R1-900	02827363	M12	1,75	–	*	9,4 0.370	12,0 0.472	79,0 3.110	25,4 1.000	3	✓
TM-M12X1.75ISO-12R1-H	02827354	M12	1,75	–	*	9,4 0.370	12,0 0.472	76,0 2.992	17,5 0.689	5	–
TM-M14X2.0ISO-14R1	02827402	M14	2,0	–	*	10,9 0.429	14,0 0.551	89,0 3.504	29,0 1.142	4	✓
TM-M14X2.0ISO-14R1-900	02827364	M14	2,0	–	*	10,9 0.429	14,0 0.551	89,0 3.504	29,0 1.142	4	✓

Designation	Item number	TDZ	Pitch		Thread profile	DC	DMM	OAL	APMXS	NOF	Through coolant
			TPX	TPIX							
						mm Inch	mm Inch	mm Inch	mm Inch		
TM-M20X2.5ISO-20R1	02827348	M20	2,5	-	*	15,83 0.623	20,0 0.787	108,0 4.252	40,0 1.575	4	✓
TM-MF4X0.5ISO-6R1	02827392	M4	0,5	-	**	3,15 0.124	6,0 0.236	49,0 1.929	8,3 0.327	3	-
TM-MF5X0.5ISO-6R1	02827430	M5	0,5	-	**	3,95 0.156	6,0 0.236	49,0 1.929	10,3 0.406	3	-
TM-MF6X0.75ISO-6R1	02827429	M6	0,75	-	**	4,7 0.185	6,0 0.236	55,0 2.165	12,4 0.488	3	-
TM-MF10X1.0ISO-10R1	02827401	M10	1,0	-	**	7,8 0.307	10,0 0.394	74,0 2.913	20,5 0.807	3	✓
TM-MF12X1.5ISO-12R1	02827400	M12	1,5	-	**	9,4 0.370	12,0 0.472	79,0 3.110	24,8 0.976	3	✓
TM-MF12X1.5ISO-12R1-900	02827365	M12	1,5	-	**	9,4 0.370	12,0 0.472	79,0 3.110	24,8 0.976	3	✓
TM-MF12X1.5ISO-12R1-H	02827355	M12	1,5	-	**	9,4 0.370	12,0 0.472	76,0 2.992	17,9 0.705	5	-
TM-MF14X1.5ISO-14R1-H	02827356	M14	1,5	-	**	10,92 0.430	14,0 0.551	82,0 3.228	21,4 0.843	5	-
TM-MF16X1.5ISO-16R1-H	02827357	M16	1,5	-	**	12,82 0.505	16,0 0.630	94,0 3.701	23,9 0.941	5	-
TM-NR.10X24UNC-6R1	02827491	No.10	-	24.0	***	3,7 0.146	6,0 0.236	49,0 1.929	10,1 0.398	3	-
TM-1/4X20UNC-6R1	02827511	1/4	-	20.0	***	4,7 0.185	6,0 0.236	55,0 2.165	14,6 0.575	3	-
TM-5/16X18UNC-8R1	02827495	5/16	-	18.0	***	6,2 0.244	8,0 0.315	62,0 2.441	16,2 0.638	3	✓
TM-3/8X16UNC-10R1	02827399	3/8	-	16.0	***	7,35 0.289	10,0 0.394	74,0 2.913	19,8 0.780	3	✓
TM-7/16X14UNC-12R1	02827398	7/16	-	14.0	***	8,55 0.337	12,0 0.472	79,0 3.110	22,7 0.894	3	✓
TM-1/2X13UNC-12R1	02827494	1/2	-	13.0	***	9,4 0.370	12,0 0.472	79,0 3.110	26,4 1.039	3	✓
TM-9/16X12UNC-14R1	02827493	9/16	-	12.0	***	10,9 0.429	14,0 0.551	89,0 3.504	30,7 1.209	4	✓

Thread turning

MDT

Mini-Shaft™

Thread milling

Thread tapping

Annex

Threadmaster™

Solid carbide thread milling cutters

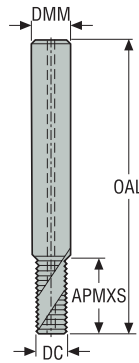

- For cutting data see page(s) 222
- TM; 2 x D
- Chamfer angle = 45°

- * = UNF, for Internal Threading
- ** = NPT, for Internal and External Threading
- *** = NPTF, for Internal and External Threading
- **** = BSP, for Internal and External Threading

Designation	Item number	TDZ	Pitch		Thread profile	DC	DMM	OAL	APMXS	NOF	Through coolant
			TPX	TPIX							
TM-NR.10X32UNF-6R1	02827397	No.10	-	32.0	*	3,95 0.156	6,0 0.236	49,0 1.929	9,9 0.390	3	-
TM-1/4X28UNF-6R1	02827396	1/4	-	28.0	*	4,7 0.185	6,0 0.236	55,0 2.165	14,1 0.555	3	-
TM-5/16X24UNF-8R1	02765298	5/16	-	24.0	*	6,2 0.244	8,0 0.315	62,0 2.441	16,4 0.646	3	✓
TM-3/8X24UNF-10R1	02827395	3/8	-	24.0	*	7,8 0.307	10,0 0.394	74,0 2.913	19,6 0.772	3	✓
TM-7/16X20UNF-12R1	02827394	7/16	-	20.0	*	9,32 0.367	12,0 0.472	79,0 3.110	22,2 0.874	3	✓
TM-1/2X20UNF-12R1	02827393	1/2	-	20.0	*	9,4 0.370	12,0 0.472	79,0 3.110	26,0 1.024	3	✓
TM-9/16X18UNF-14R1	02827492	9/16	-	18.0	*	10,9 0.429	14,0 0.551	89,0 3.504	28,9 1.138	4	✓
TM-1/8X27NPT-12R1	02827435	1/8	-	27.0	**	7,8 0.307	12,0 0.472	70,0 2.756	8,9 0.350	3	✓
TM-1/4X18NPT-16R1	02827434	1/4	-	18.0	**	10,05 0.396	16,0 0.630	81,0 3.189	13,4 0.528	4	✓
TM-3/8X18NPT-18R1	02827409	3/8	-	18.0	**	13,45 0.530	18,0 0.709	81,0 3.189	13,4 0.528	4	✓
TM-1/8X27NPTF-12R1	02827433	1/8	-	27.0	***	7,7 0.303	12,0 0.472	70,0 2.756	8,9 0.350	3	✓
TM-1/4X18NPTF-16R1	02827432	1/4	-	18.0	***	10,0 0.394	16,0 0.630	81,0 3.189	13,4 0.528	4	✓
TM-3/8X18NPTF-18R1	02827410	3/8	-	18.0	***	13,4 0.528	18,0 0.709	81,0 3.189	13,4 0.528	4	✓
TM-1/8X28W-10R1	02827431	1/8	-	28.0	****	7,8 0.307	10,0 0.394	74,0 2.913	20,4 0.803	3	✓
TM-1/4X19W-14R1	02543519	1/4	-	19.0	****	10,9 0.429	14,0 0.551	89,0 3.504	27,4 1.079	4	✓
TM-3/8X19W-18R1	02765294	3/8	-	19.0	****	13,9 0.547	18,0 0.709	102,0 4.016	35,4 1.394	4	✓

Thread turning

MDT

Mini-Shaft™

Thread milling

Thread tapping

Annex

Threadmaster™ – TM-Mini

Solid carbide thread milling cutters

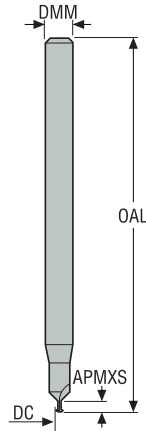

- Left-hand cutter
- For cutting data see page(s) 222
- TM : 1.5 x D
- Chamfer angle = 90°

* = Metric coarse, for Internal Threading

Designation	Item number	TDZ	Pitch		Thread profile	DC	DMM	OAL	APMXS	NOF	Through coolant
			TPX	TPIX							
						mm Inch	mm Inch	mm Inch	mm Inch		
TM-M1.0X0.25ISO-3R1-H	02807939	M1.0	0,25	-	*	0,7 0.028	3,0 0.118	40,0 1.575	2,05 0.081	2	-
TM-M1.4X0.30ISO-3R1-H	02807940	M1.4	0,3	-	*	0,97 0.038	3,0 0.118	40,0 1.575	2,63 0.104	2	-
TM-M1.6X0.35ISO-3R1-H	02807941	M1.6	0,35	-	*	1,15 0.045	3,0 0.118	40,0 1.575	3,07 0.121	2	-
TM-M2.0X0.40ISO-3R1-H	02807942	M2.0	0,4	-	*	1,56 0.061	3,0 0.118	40,0 1.575	3,74 0.147	2	-
TM-M2.2X0.45ISO-3R1-H	02807943	M2.2	0,45	-	*	1,71 0.067	3,0 0.118	40,0 1.575	3,9 0.154	2	-
TM-M2.5X0.45ISO-3R1-H	02807944	M2.5	0,45	-	*	2,01 0.079	3,0 0.118	40,0 1.575	4,45 0.175	3	-

Drilling Threadmaster™

Solid carbide thread milling cutters

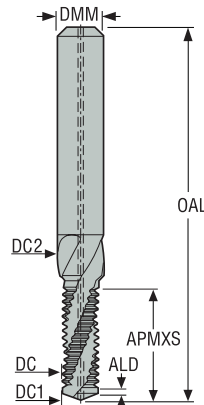

- For cutting data see page(s) 224
- DTM; 2 x D
- Chamfer angle = 90°
- Drill Point = 140°

- * = Metric coarse
- ** = Metric fine
- *** = UNC
- **** = UNF
- ***** = BSP

Designation	Item number	TDZ	Pitch		Thread profile	DC	DC1	DC2	DMM	ALD	OAL	APMXS	NOF	Through coolant
			TPX	TPIX										
DTM-M4X0.7ISO-6R1	02827366	M4	0,7	-	*	3,24 0.128	3,3 0.130	4,3 0.169	6,0 0.236	0,7 0.028	49,0 1.929	9,42 0.371	2	✓
DTM-M5X0.8ISO-6R1	02827367	M5	0,8	-	*	4,1 0.161	4,2 0.165	5,3 0.209	6,0 0.236	0,8 0.031	55,0 2.165	11,65 0.459	2	✓
DTM-M6X1.0ISO-8R1	02827368	M6	1,0	-	*	4,85 0.191	5,0 0.197	6,3 0.248	8,0 0.315	1,0 0.039	62,0 2.441	14,49 0.570	2	✓
DTM-M8X1.25ISO-10R1	02827369	M8	1,25	-	*	6,45 0.254	6,75 0.266	8,3 0.327	10,0 0.394	1,2 0.047	74,0 2.913	18,17 0.715	2	✓
DTM-M10X1.5ISO-12R1	02827370	M10	1,5	-	*	8,08 0.318	8,5 0.335	10,3 0.406	12,0 0.472	1,5 0.059	79,0 3.110	23,37 0.920	2	✓
DTM-M12X1.75ISO-14R1	02827371	M12	1,75	-	*	9,74 0.383	10,25 0.404	12,3 0.484	14,0 0.551	1,5 0.059	89,0 3.504	27,06 1.065	2	✓
DTM-M14X2.0ISO-16R1	02827372	M14	2,0	-	*	11,36 0.447	12,0 0.472	14,3 0.563	16,0 0.630	1,5 0.059	102,0 4.016	32,77 1.290	2	✓
DTM-M16X2.0ISO-18R1	02827373	M16	2,0	-	*	13,28 0.523	14,0 0.551	16,3 0.642	18,0 0.709	1,5 0.059	102,0 4.016	37,12 1.461	2	✓
DTM-MF8X1.0ISO-10R1	02827374	M8	1,0	-	**	6,79 0.267	7,0 0.276	8,3 0.327	10,0 0.394	1,0 0.039	74,0 2.913	18,8 0.740	2	✓
DTM-MF10X1.0ISO-12R1	02827375	M10	1,0	-	**	8,75 0.344	9,0 0.354	10,3 0.406	12,0 0.472	1,5 0.059	79,0 3.110	23,18 0.913	2	✓
DTM-MF12X1.5ISO-14R1	02827376	M12	1,5	-	**	10,06 0.396	10,5 0.413	12,3 0.484	14,0 0.551	1,5 0.059	89,0 3.504	28,19 1.110	2	✓
DTM-1/4X20UNC-8R1	02827377	1/4	-	20.0	***	4,7 0.185	5,08 0.200	6,65 0.262	8,0 0.315	1,2 0.047	62,0 2.441	15,71 0.619	2	✓
DTM-5/16X18UNC-10R1	02827378	5/16	-	18.0	***	6,01 0.237	6,53 0.257	8,24 0.324	10,0 0.394	1,4 0.055	74,0 2.913	19,0 0.748	2	✓
DTM-3/8X16UNC-12R1	02827379	3/8	-	16.0	***	7,36 0.290	7,94 0.313	9,83 0.387	12,0 0.472	1,5 0.059	79,0 3.110	22,97 0.904	2	✓
DTM-1/2X13UNC-14R1	02827380	1/2	-	13.0	***	9,87 0.389	10,75 0.423	13,0 0.512	14,0 0.551	1,5 0.059	89,0 3.504	30,07 1.184	2	✓
DTM-1/4X28UNF-8R1	02827381	1/4	-	28.0	****	5,17 0.204	5,44 0.214	6,65 0.262	8,0 0.315	0,9 0.035	62,0 2.441	15,16 0.597	2	✓
DTM-5/16X24UNF-10R1	02827382	5/16	-	24.0	****	6,51 0.256	6,88 0.271	8,24 0.324	10,0 0.394	1,1 0.043	74,0 2.913	18,83 0.741	2	✓
DTM-3/8X24UNF-12R1	02827383	3/8	-	24.0	****	8,07 0.318	8,47 0.333	9,83 0.387	12,0 0.472	1,1 0.043	79,0 3.110	21,2 0.835	2	✓
DTM-1/2X20UNF-14R1	02827384	1/2	-	20.0	****	10,88 0.428	11,43 0.450	13,0 0.512	14,0 0.551	1,3 0.051	89,0 3.504	28,19 1.110	2	✓

Thread turning

MDT

Mini-Shaft™

Thread milling

Thread tapping

Annex

Designation	Item number	TDZ	Pitch		Thread profile	DC	DC1	DC2	DMM	ALD	OAL	APMXS	NOF	Through coolant
			TPX	TPIX		mm <i>Inch</i>	mm <i>Inch</i>	mm <i>Inch</i>	mm <i>Inch</i>	mm <i>Inch</i>	mm <i>Inch</i>	mm <i>Inch</i>		
DTM-1/8X28W-12R1	02827385	1/8	–	28.0	*****	8,4 <i>0.331</i>	8,71 <i>0.343</i>	10,03 <i>0.395</i>	12,0 <i>0.472</i>	0,9 <i>0.035</i>	79,0 <i>3.110</i>	22,03 <i>0.867</i>	2	✓
DTM-1/4X19W-16R1	02827386	1/4	–	19.0	*****	11,44 <i>0.450</i>	11,67 <i>0.459</i>	13,46 <i>0.530</i>	16,0 <i>0.630</i>	1,3 <i>0.051</i>	102,0 <i>4.016</i>	29,45 <i>1.159</i>	2	✓

Thread turning

MDT

Mini-Shaft™

Thread milling

Thread tapping

Annex

Threadmaster™ – Cutting data metric Inch

SMG	TM		TM-900		TM-H		TM-MINI	
	f _z	v _c	f _z	v _c	f _z	v _c	f _z	v _c
P1	0,010	145	—	—	—	—	—	—
	0.00040	475	—	—	—	—	—	—
P2	0,010	140	—	—	—	—	—	—
	0.00040	460	—	—	—	—	—	—
P3	0,0095	120	—	—	—	—	—	—
	0.00038	395	—	—	—	—	—	—
P4	0,0095	105	0,0040	105	—	—	—	—
	0.00038	345	0.00016	345	—	—	—	—
P5	0,0090	100	0,0040	100	—	—	—	—
	0.00036	330	0.00016	330	—	—	—	—
P6	0,0090	115	0,0040	115	—	—	—	—
	0.00036	375	0.00016	375	—	—	—	—
P7	0,0090	110	0,0040	110	—	—	—	—
	0.00036	360	0.00016	360	—	—	—	—
P8	0,0095	100	0,0042	100	—	—	—	—
	0.00038	330	0.00017	330	—	—	—	—
P11	0,0090	105	0,0040	105	—	—	—	—
	0.00036	345	0.00016	345	—	—	—	—
P12	0,0060	60	0,0028	60	—	—	—	—
	0.00024	195	0.00011	195	—	—	—	—
M1	0,010	100	0,0044	100	—	—	—	—
	0.00040	330	0.00017	330	—	—	—	—
M2	0,0090	80	0,0040	80	—	—	—	—
	0.00036	260	0.00016	260	—	—	—	—
M3	0,0075	60	0,0032	60	—	—	—	—
	0.00030	195	0.00013	195	—	—	—	—
M4	0,0065	47	0,0028	47	—	—	—	—
	0.00026	155	0.00011	155	—	—	—	—
M5	0,0065	39	0,0028	39	—	—	—	—
	0.00026	130	0.00011	130	—	—	—	—
K1	0,010	145	0,0044	100	—	—	—	—
	0.00040	475	0.00017	330	—	—	—	—
K2	0,0090	125	0,0040	90	—	—	—	—
	0.00036	410	0.00016	295	—	—	—	—
K3	0,0090	105	0,0040	75	—	—	—	—
	0.00036	345	0.00016	245	—	—	—	—
K4	0,0090	100	0,0040	70	—	—	—	—
	0.00036	330	0.00016	230	—	—	—	—
K5	0,0080	60	0,0036	42	—	—	—	—
	0.00032	195	0.00014	140	—	—	—	—
K6	0,0090	90	0,0040	65	—	—	—	—
	0.00036	295	0.00016	215	—	—	—	—
K7	0,0080	80	0,0036	55	—	—	—	—
	0.00032	260	0.00014	180	—	—	—	—
N1	0,013	395	0,0055	335	—	—	—	—
	0.00050	1300	0.00022	1100	—	—	—	—
N2	0,013	255	0,0055	215	—	—	—	—
	0.00050	840	0.00022	710	—	—	—	—
N3	0,013	170	0,0055	145	—	—	—	—
	0.00050	560	0.00022	475	—	—	—	—
N11	0,013	225	0,0055	195	—	—	—	—
	0.00050	740	0.00022	640	—	—	—	—
S1	0,0065	50	0,0028	20	—	—	—	—
	0.00026	165	0.00011	65	—	—	—	—
S2	0,0065	41	0,0028	15	—	—	—	—
	0.00026	135	0.00011	49	—	—	—	—
S3	0,0060	20	0,0026	10	—	—	—	—
	0.00024	65	0.00010	33	—	—	—	—
S11	0,0075	105	0,0032	40	—	—	—	—
	0.00030	345	0.00013	130	—	—	—	—
S12	0,0075	80	0,0032	31	—	—	—	—
	0.00030	260	0.00013	100	—	—	—	—
S13	0,0065	65	0,0028	24	—	—	—	—
	0.00026	215	0.00011	80	—	—	—	—
H3	—	—	—	—	0,0016	19	0,0022	11
	—	—	—	—	0.000065	60	0.000085	36
H5	—	—	—	—	0,0025	36	0,0032	21
	—	—	—	—	0.00010	120	0.00013	70
H7	—	—	—	—	0,0016	19	0,0022	11
	—	—	—	—	0.000065	60	0.000085	36
H8	—	—	—	—	0,0019	36	0,0025	21
	—	—	—	—	0.000075	120	0.00010	70
H11	—	—	—	—	0,0025	45	0,0032	26
	—	—	—	—	0.00010	150	0.00013	85

SMG	TM		TM-900		TM-H		TM-MINI	
	f_z	v_c	f_z	v_c	f_z	v_c	f_z	v_c
H12	—	—	—	—	0.0019	41	0.0025	24
	—	—	—	—	0.000075	135	0.00010	80
H21	—	—	—	—	0.0019	36	0.0025	21
	—	—	—	—	0.000075	120	0.00010	70
H31	—	—	—	—	—	—	—	—

SMG = Seco Material Group
 f_z = mm/tooth (mm/flute)
 v_c = m/min
 All cutting data are start values

All feed are related to the centre of the cutter and not the periphery.

Drilling Threadmaster™ – Cutting data, threadmilling metric *inch*

SMG	DTM	
	f_z	v_c
K1	0,0065	175
	0.00026	570
K2	0,0060	155
	0.00024	510
K3	0,0060	130
	0.00024	425
K4	0,0060	125
	0.00024	410
K5	0,0055	75
	0.00022	245
K6	0,0060	110
	0.00024	360
K7	0,0055	95
	0.00022	310
N1	0,0085	400
	0.00034	1300
N2	0,0085	255
	0.00034	840
N3	0,0085	170
	0.00034	560
N11	0,0085	225
	0.00034	740

Drilling Threadmaster™ – Cutting data, drilling metric *inch*

SMG	f						v_c
	Ø 3.01-5.0	Ø 5.01-7.0	Ø 7.01-9.0	Ø 9.01-11.0	Ø 11.01-13.0	Ø 13.01-15.0	
	Ø 0.118-0.196	Ø 0.197-0.275	Ø 0.276-0.354	Ø 0.355-0.433	Ø 0.434-0.511	Ø 0.512-0.590	
K1	0,12	0,15	0,18	0,19	0,22	0,25	170
	0.0048	0.0060	0.0070	0.0075	0.0085	0.010	560
K2	0,11	0,13	0,16	0,17	0,20	0,22	150
	0.0044	0.0050	0.0065	0.0065	0.0080	0.0085	490
K3	0,11	0,13	0,16	0,17	0,20	0,22	125
	0.0044	0.0050	0.0065	0.0065	0.0080	0.0085	410
K4	0,11	0,13	0,16	0,17	0,20	0,22	120
	0.0044	0.0050	0.0065	0.0065	0.0080	0.0085	395
K5	0,095	0,12	0,14	0,16	0,18	0,20	70
	0.0038	0.0048	0.0055	0.0065	0.0070	0.0080	230
K6	0,11	0,13	0,16	0,17	0,20	0,22	105
	0.0044	0.0050	0.0065	0.0065	0.0080	0.0085	345
K7	0,095	0,12	0,14	0,16	0,18	0,20	90
	0.0038	0.0048	0.0055	0.0065	0.0070	0.0080	295
N1	0,15	0,19	0,22	0,24	0,28	0,32	390
	0.0060	0.0075	0.0085	0.0095	0.011	0.013	1275
N2	0,15	0,19	0,22	0,24	0,28	0,32	250
	0.0060	0.0075	0.0085	0.0095	0.011	0.013	820
N3	0,15	0,19	0,22	0,24	0,28	0,32	165
	0.0060	0.0075	0.0085	0.0095	0.011	0.013	540
N11	0,15	0,19	0,22	0,24	0,28	0,32	220
	0.0060	0.0075	0.0085	0.0095	0.011	0.013	720

SMG = Seco Material Group
 f_z = mm/tooth (mm/flute)
 f = mm/rev
 v_c = m/min
 All cutting data are start values

Feed are related to the centre of the cutter and not the periphery.

Thread Milling 396.18/19/20 Cutting data metric inch

SMG	CP500		F30M		H15	
	f _z	V _c	f _z	V _c	f _z	V _c
P1	0,050	385	0,050	385	—	—
	0.0020	1275	0.0020	1275	—	—
P2	0,055	375	0,055	375	—	—
	0.0022	1225	0.0022	1225	—	—
P3	0,050	325	0,050	325	—	—
	0.0020	1075	0.0020	1075	—	—
P4	0,050	285	0,050	285	—	—
	0.0020	940	0.0020	940	—	—
P5	0,048	275	0,048	275	—	—
	0.0019	900	0.0019	900	—	—
P6	0,048	305	0,048	305	—	—
	0.0019	1000	0.0019	1000	—	—
P7	0,048	290	0,048	290	—	—
	0.0019	950	0.0019	950	—	—
P8	0,050	275	0,050	275	—	—
	0.0020	900	0.0020	900	—	—
P11	0,048	280	0,048	280	—	—
	0.0019	920	0.0019	920	—	—
P12	0,032	165	0,032	165	—	—
	0.0013	540	0.0013	540	—	—
M1	0,055	285	0,055	285	—	—
	0.0022	940	0.0022	940	—	—
M2	0,048	230	0,048	230	—	—
	0.0019	750	0.0019	750	—	—
M3	0,038	175	0,038	175	—	—
	0.0015	570	0.0015	570	—	—
M4	0,034	130	0,034	130	—	—
	0.0013	425	0.0013	425	—	—
M5	0,034	110	0,034	110	—	—
	0.0013	360	0.0013	360	—	—
K1	0,055	300	0,055	300	0,040	270
	0.0022	980	0.0022	980	0.0016	890
K2	0,048	260	0,048	260	0,038	235
	0.0019	850	0.0019	850	0.0015	770
K3	0,048	220	0,048	220	0,038	200
	0.0019	720	0.0019	720	0.0015	660
K4	0,048	210	0,048	210	0,038	190
	0.0019	690	0.0019	690	0.0015	620
K5	0,044	125	0,044	125	0,034	115
	0.0017	410	0.0017	410	0.0013	375
K6	0,048	185	0,048	185	0,038	170
	0.0019	610	0.0019	610	0.0015	560
K7	0,044	160	0,044	160	0,034	145
	0.0017	520	0.0017	520	0.0013	475
N1	0,070	1375	0,070	1375	0,050	1375
	0.0028	4500	0.0028	4500	0.0020	4500
N2	0,070	890	0,070	890	0,050	890
	0.0028	2925	0.0028	2925	0.0020	2925
N3	0,070	590	0,070	590	0,050	590
	0.0028	1925	0.0028	1925	0.0020	1925
N11	0,070	780	0,070	780	—	—
	0.0028	2550	0.0028	2550	—	—

SMG = Seco Material Group
 f_z = mm/tooth (mm/flute)
 v_c = m/min (for holder types -065AM, -079AM and -080AM use factor 0,75 on vc)
 All cutting data are start values

All feed are related to the centre of the cutter and not the periphery.

Thread turning

MDT

Mini-Shaft™

Thread milling

Thread tapping

Annex

Feed related to the centre of the cutter

When calculating feed and feed/tooth from average chip thickness using circular interpolation or helical interpolation ramping in an operation, the feed and feed/tooth are always related to the centre and not to the periphery of the cutter.

Tolerance on the machined component.

The tolerance on the thread diameter is 6H when using a cutter with more than one tooth. With a single cutting insert the tolerance is 4H. If a multi-tooth milling cutter is used with one cutting insert, the other insert seat(s) must be equipped with non-cutting blank insert(s) to stabilise the milling cutter during the cutting process.

As all 396.19 inserts are double sided, it is important that all inserts are mounted in the same position to achieve best possible tolerance. It must be done by indexing the identification dots in the same position. See figure.

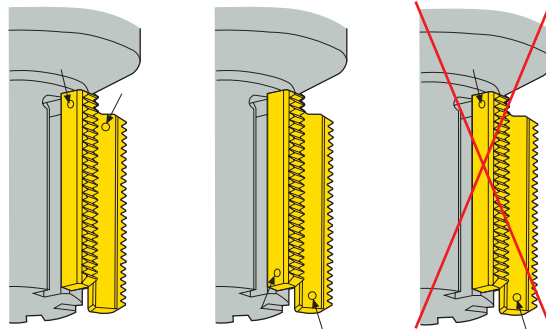

Cutting speed Thread milling 335.14 metric inch

SMG	R335.14	
	f_z	v_c
P1	0,070	275
	0.0028	900
P2	0,070	270
	0.0028	890
P3	0,070	230
	0.0028	750
P4	0,065	205
	0.0026	670
P5	0,065	195
	0.0026	640
P6	0,065	215
	0.0026	710
P7	0,065	205
	0.0026	670
P8	0,070	195
	0.0028	640
P11	0,065	200
	0.0026	660
P12	0,044	120
	0.0017	395
M1	0,070	215
	0.0028	710
M2	0,065	175
	0.0026	570
M3	0,050	130
	0.0020	425
M4	0,046	100
	0.0018	330
M5	0,046	80
	0.0018	260
K1	0,070	210
	0.0028	690
K2	0,065	185
	0.0026	610
K3	0,065	180
	0.0026	590
K4	0,065	150
	0.0026	490
K5	0,060	90
	0.0024	295
K6	0,065	130
	0.0026	425
K7	0,060	115
	0.0024	375
N1	0,090	970
	0.0036	3175
N2	0,090	620
	0.0036	2025
N3	0,090	415
	0.0036	1350
N11	0,090	475
	0.0036	1550
S1	0,046	50
	0.0018	165
S2	0,046	41
	0.0018	135
S3	0,042	35
	0.0017	115
S11	0,050	65
	0.0020	215
S12	0,050	50
	0.0020	165
S13	0,046	39
	0.0018	130
H5	0,044	43
	0.0017	140
H8	0,034	45
	0.0013	150
H11	0,044	60
	0.0017	195
H12	0,034	55
	0.0013	180
H21	0,034	45
	0.0013	150

Thread turning

MDT

Mini-Shaft™

Thread milling

Thread tapping

Annex

Code keys

Threadmaster™

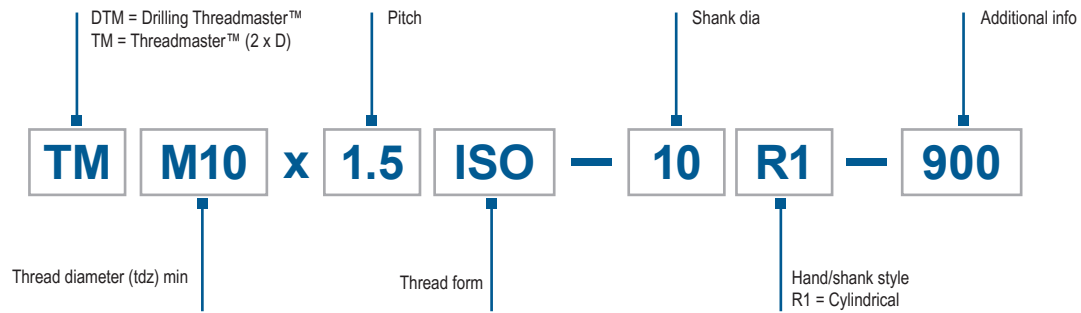

R396.18/19/20

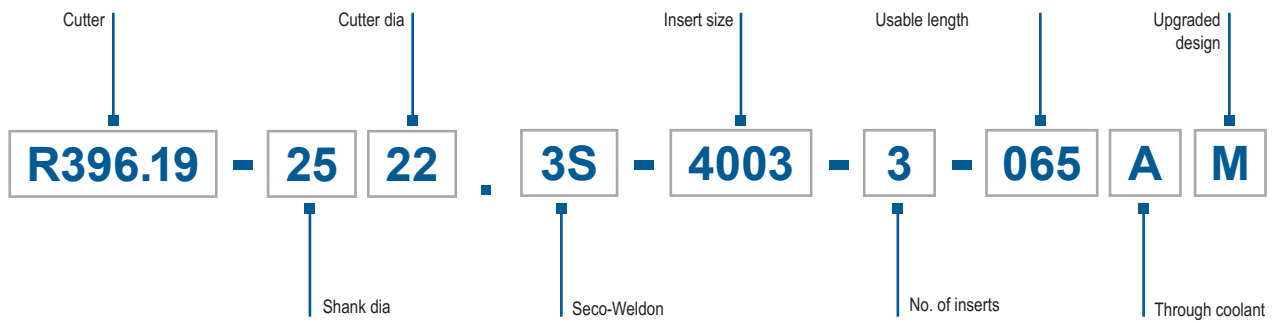

Insert 396.19/20

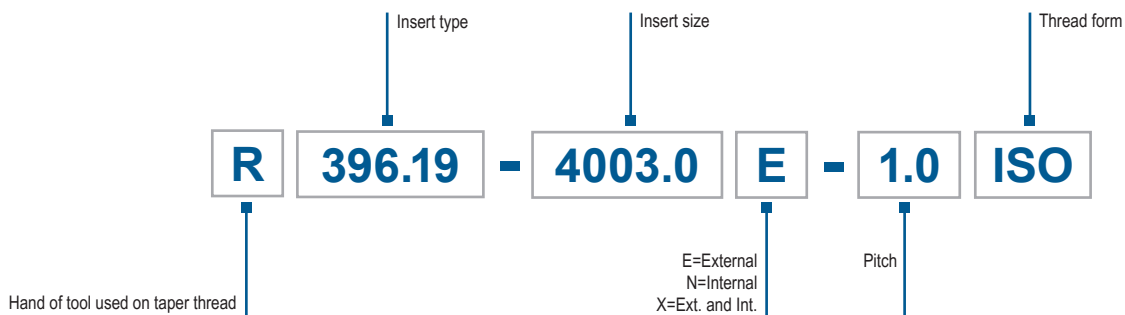

Thread turning

MDT

Mini-Shaft™

Thread milling

Thread tapping

Annex

Code keys

Disc Milling cutter 335.14



2 types of shanks available: cylindrical available both in steel and carbide, or ER collet chuck system

Mini disc

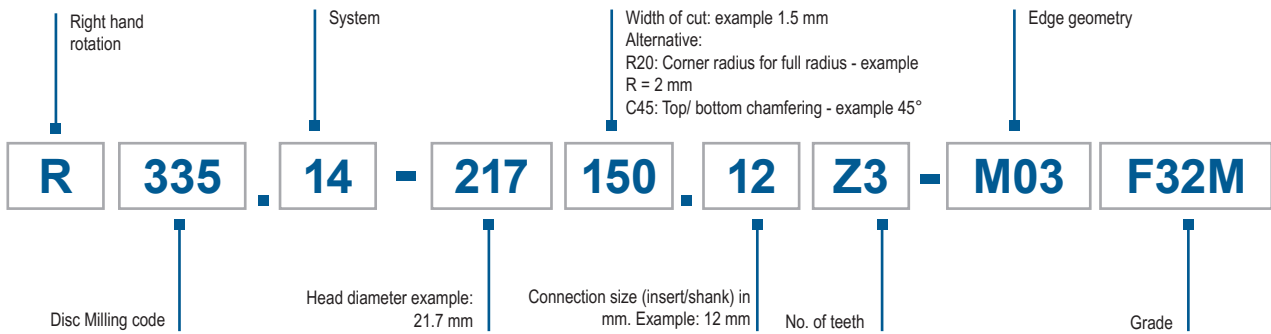

Cylindrical shank

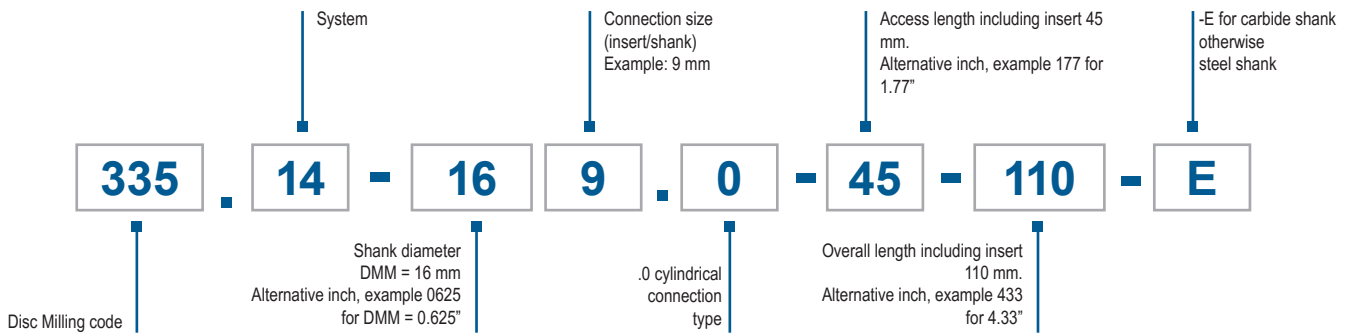

Collet chuck

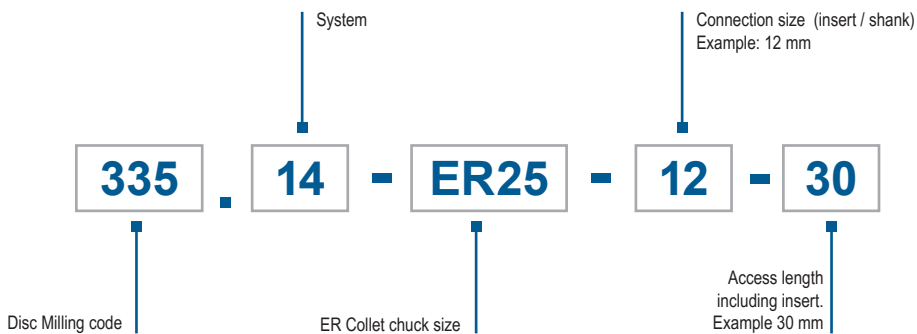



Thread milling Indexable

Seco 396.18/19/20 thread mills are versatile, cost-effective process tools for anyone facing a variety of threads, parts and workpiece materials on the same machine. Multi-tooth indexable insert cutters use a double sided multi-tooth insert usable above $\text{Ø}14$ mm for both internal and external threads.

- Inserts available with different thread profiles and pitches
- Multi-tooth cutters for high productivity
- Arbor, Weldon and SecoWeldon shanktypes

R396.18/R396.19

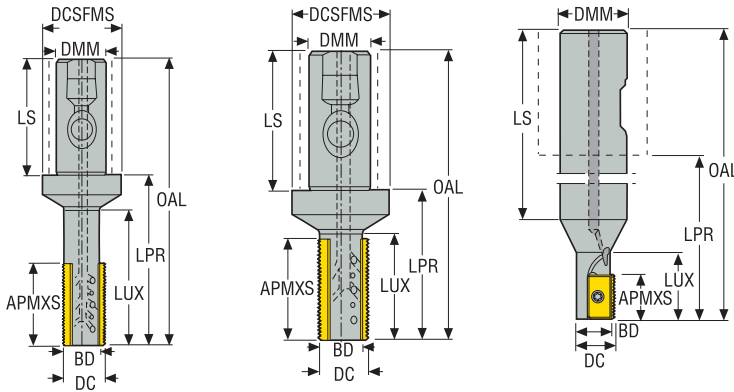

Tool angle:
GAMO= -15°
GAMP= 0°
GAMF= -15°

- For cutting data see page(s) 225
- For insert information see page(s) 238-240
- Min thread diameter, see page(s) 237
- Note: Type of mounting * = Weldon
- Note: Type of mounting ** = Seco-Weldon



Designation	Item number	DC	DMM	OAL	APMXS	BD	DCSFMS	LPR	LUX	LS	Weight	NOF	RPMX	Note	Insert
		mm	mm	mm	mm	mm	mm	mm	mm	mm	kg				
R396.18-2012.3-13A	75036662	12,0	20,0	105,0	13,0	10,0	-	38,0	20,0	67,0	0,2	1	30000	*	-
R396.19-2517.3S-4003-2AM	02534461	17,0	25,0	116,0	25,0	13,0	40,0	60,0	26,0	56,0	0,5	2	22400	**	-
R396.19-2522.3S-4003-3AM	02514532	22,0	25,0	116,0	40,0	17,6	40,0	60,0	43,0	56,0	0,4	3	20000	**	-
R396.19-2522.3S-4003-3-065AM	02546918	22,0	25,0	140,0	40,0	17,6	40,0	84,0	65,0	56,0	0,5	3	20000	**	-
R396.19-2525.3S-4005-2AM	02544660	25,0	25,0	116,0	40,0	19,0	40,0	60,0	43,0	56,0	0,4	2	13600	**	-
R396.19-2530.3S-4005-3AM	02546916	30,0	25,0	116,0	40,0	23,0	40,0	60,0	43,0	56,0	0,5	3	12000	**	-
R396.19-2530.3S-4005-3-080AM	02544662	30,0	25,0	154,0	40,0	22,2	40,0	98,0	80,0	56,0	0,6	3	12000	**	-
R396.19-3232.3S-4003-6AM	02546915	32,0	32,0	120,0	40,0	27,4	50,0	60,0	43,0	60,0	0,7	6	16800	**	-
R396.19-3236.3S-4005-6AM	02546917	36,0	32,0	120,0	40,0	28,2	50,0	60,0	42,0	60,0	0,7	6	11200	**	-

Spare Parts, included in delivery

For holders	Fastening screw	Insert key	Insert screw	Key (T-handle)
R396.18	-	H4B-T07P	C02506-T07P	DOUBLE-T
R396.19	P6SS4X4-T09P	T09P-2	-	-

Note! When milling threads to smaller diameters than indicated for a certain pitch/cutter combination, an incorrect thread form will result.
Note! R396.19-2525.3S-4005-2AM Max pitch size 4,5 ISO/6 TPI can be used.
 *Torque key T00-07P09, T00-09P20.

R396.18/R396.19

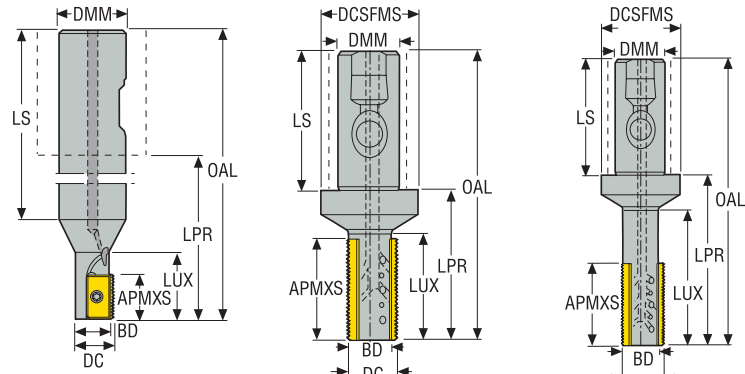

- For cutting data see page(s) 225
- For insert information see page(s) 238-240
- Min thread diameter, see page(s) 237
- Note: Type of mounting + = Weldon
- Note: Type of mounting ** = Seco-Weldon

Tool angle:
GAMO= -15°
GAMP= 0°
GAMF= -15°

Designation	Item number	DC	DMM	OAL	APMXS	BD	DCSFMS	LPR	LUX	LS	Weight	NOF	RPMX	Note	Insert
		Inch	Inch	Inch	Inch	Inch	Inch	Inch	Inch	Inch	lbs				
R396.18-00.39-3-13AT	00087568	0.390	0.750	4.140	0.510	0.310	-	-	0.530	3.610	0.440	1	30000	*	-
R396.18-00.50-3-13A	75054862	0.472	0.750	4.140	0.510	0.390	-	-	0.780	3.360	0.660	1	30000	*	-
R396.18-00.50-3-13AT	00074293	0.509	0.750	4.134	0.512	0.310	-	-	0.746	2.997	0.440	1	30000	*	-
R396.19-00.58-3S-1AM	02546957	0.591	1.000	4.803	1.102	0.450	1.575	2.362	1.024	2.441	1.100	1	22400	**	-
R396.19-00.67-3S-4003-2AM	02546937	0.669	1.000	4.547	0.984	0.512	1.575	2.362	1.024	2.185	1.100	2	22000	**	-
R396.19-00.87-3S-4003-3AM	02546938	0.866	1.000	4.547	1.575	0.709	1.575	2.362	1.693	2.185	1.100	3	20000	**	-
R396.19-00.87-3S-4003-LAM	02546950	0.866	1.000	5.512	1.575	0.709	1.575	3.307	2.559	2.185	1.100	3	20000	**	-
R396.19-01.00-3S-4005-2AM	02546944	0.984	1.000	4.547	1.575	0.748	1.575	2.362	1.693	2.185	1.100	2	13600	**	-
R396.19-01.18-3S-4005-3AM	02546946	1.181	1.000	4.547	1.575	0.906	1.575	2.362	1.693	2.185	1.100	3	12000	**	-
R396.19-01.18-3S-4005-LAM	02546954	1.181	1.000	6.043	1.575	0.906	1.575	3.858	3.150	2.185	1.320	3	12000	**	-
R396.19-01.25-3S-4003-6AM	02546941	1.260	1.250	4.547	1.575	1.102	1.969	2.362	1.654	2.343	1.540	6	16800	**	-
R396.19-01.42-3S-4005-6AM	02546947	1.417	1.250	4.705	1.575	1.142	1.969	2.362	1.654	2.343	1.540	6	11200	**	-

Spare Parts, included in delivery

For holders	Fastening screw	Insert key	Insert screw	Key (T-handle)	Screw
..18-00.39..					
..18-00.39..	-	H4B-T07P	-	DOUBLE-T	C02505-T07P
..18-00.50..A	-	H4B-T07P	C02506-T07P	DOUBLE-T	-
..18-00.50..AT	-	H4B-T07P	C02505-T07P	DOUBLE-T	-
..19-00.58...-..19-01.42..	P6SS4X4-T09P	T09P-2	-	-	-

Note! When milling threads to smaller diameters than indicated for a certain pitch/cutter combination, an incorrect thread form will result.

Note! R396.19-2525.3S-4005-2AM Max pitch size 4,5 ISO/6 TPI can be used.

*Torque key T00-07P09, T00-09P20.

R396.19

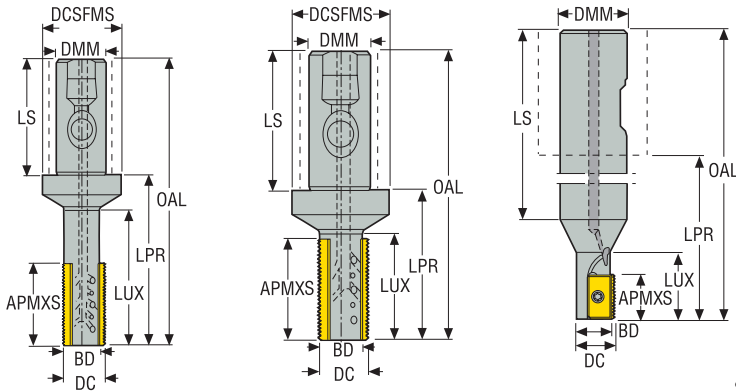

Tool angle:
GAMO= -15°
GAMP= 0°
GAMF= -15°

- For cutting data see page(s) 225
- For insert information see page(s) 238-240
- Min thread diameter, see page(s) 237
- Note: Type of mounting ** = Seco-Weldon



Designation	Item number	DC	DMM	OAL	APMXS	BD	DCSFMS	LPR	LUX	LS	Weight	NOF	RPMX	Note	Insert
		mm	mm	mm	mm	mm	mm	mm	mm	mm	kg				
R396.19-3232.3S-4003-3-079AM	02963138	32,0	32,0	156,0	40,0	27,4	50,0	96,0	79,57	60,0	0,9	3	20000	**	-
R396.19-3232.3S-4005-3-079AM	02963139	32,0	32,0	156,0	40,0	24,2	50,0	96,0	79,0	60,0	0,9	3	11200	**	-

Spare Parts, included in delivery

For holders	Fastening screw	Insert key
R396.19	P6SS4X4-T09P	T09P-2

Note! When milling threads to smaller diameters than indicated for a certain pitch/cutter combination, an incorrect thread form will result.
Note! R396.19-2525.3S-4005-2AM Max pitch size 4,5 ISO/6 TPI can be used.
 *Torque key T00-07P09, T00-09P20.

R396.19

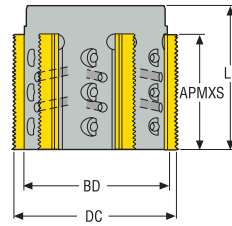

- For cutting data see page(s) 225
- For insert information see page(s) 238-240
- Min thread diameter, see page(s) 237

Tool angle:
GAMO= -15°
GAMP= 0°
GAMF= -15°

Designation	Item number	DC	APMXS	BD	LF	Weight	NOF	RPMX	Insert
		mm	mm	mm	mm	kg			
R396.19-0058-4003-6AM	02546921	58,0	40,0	53,0	50,0	0,7	6	8600	-
R396.19-0058-4005-6AM	02546920	58,0	40,0	50,0	50,0	0,6	6	8600	-

Spare Parts, included in delivery

For holders	Arbor screw	Fastening screw	Insert key
...6AM	MC6S12X40	P6SS4X4-T09P	T09P-2

*Torque values 2 Nm. Torque key, T00-09P20.

Thread turning

MDT

Mini-Shaft™

Thread milling

Thread tapping

Annex

R396.19

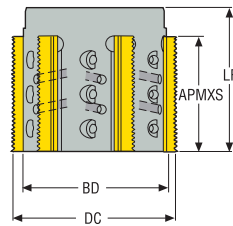



- For cutting data see page(s) 225
- For insert information see page(s) 238-240
- Min thread diameter, see page(s) 237

Tool angle:
GAMO= -15°
GAMP= 0°
GAMF= -15°

Designation	Item number	DC	APMXS	BD	LF	Weight	NOF	RPMX	Insert
		<i>Inch</i>	<i>Inch</i>	<i>Inch</i>	<i>Inch</i>	<i>lbs</i>			
R396.19-02.28-4003-6AM	02546955	2.283	1.575	2.087	1.969	1.760	6	8600	-
R396.19-02.28-4005-6AM	02546956	2.283	1.575	1.969	1.969	1.540	6	8600	-

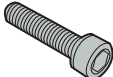
Spare Parts, included in delivery

For holders	Arbor screw	Fastening screw	Insert key
			
	UC6S1/2UNFX1-1/4	P6SS4X4-T09P	T09P-2

*Torque values 2 Nm. Torque key, T00-09P20.

R396.20

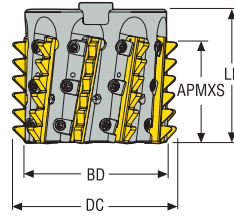

- For cutting data see page(s) 225
- For insert information see page(s) 241
- Min thread diameter, see page(s) 237

Tool angle:
GAMO= -15°
GAMP= -15°
GAMF= -15°

Designation	Item number	DC	APMXS	BD	LF	Weight	NOF	RPMX	Insert
		<i>Inch</i>	<i>Inch</i>	<i>Inch</i>	<i>Inch</i>	<i>lbs</i>			
R396.20-02.478-4005-9AW	03013869	2.478	1.575	2.106	1.992	1.320	9	8600	-

Spare Parts, included in delivery

For holders	Arbor screw	Key	Key (T-handle)	Wedge clamp	Wedge screw
R396.20	UC6S1/2UNFX1-1/2	H4B-T08P	DOUBLE-T	CW0405M	LD4012-T08P

*Torque values 2 Nm. Torque key, T00-09P20.

Thread turning

MDT

Mini-Shaft™

Thread milling

Thread tapping

Annex

Min thread diameter (major dia), for different pitch and cutter combinations

R396.18/R396.19/R396.20

For cutter	Pitch mm TPI										
	1 24	1,5 16	2 12	2,5 10	3 8	3,5 7	4 6	4,5	5 5	5,5	6 4
R396.18-2012.3-13A	14	15	16	–	–	–	–	–	–	–	–
R396.19-2517.3S-4003-2AM	19	20	21	22	24	–	–	–	–	–	–
R396.19-2522.3S-4003-3AM	24	25	26	27	27	–	–	–	–	–	–
R396.19-2522.3S-4003-3-065AM	24	25	26	27	27	–	–	–	–	–	–
R396.19-3232.3S-4003-6AM	34	35	36	39	40	–	–	–	–	–	–
R396.19-2525.3S-4005-2AM	–	–	–	–	30	33	35	37	–	–	–
R396.19-2530.3S-4005-3AM	–	–	–	–	38	40	42	44	45	47	48
R396.19-2530.3S-4005-3-080AM	–	–	–	–	38	40	42	44	45	47	48
R396.19-3236.3S-4005-6AM	–	–	–	–	43	45	47	47	48	50	53
R396.19-0058-4003-6AM	62	63	65	66	67	–	–	–	–	–	–
R396.19-0058-4005-6AM	–	–	–	–	67	69	70	71	72	73	74
R396.19-3232.3S-4003-3-079AM	34	35	36	39	40	–	–	–	–	–	–
R396.19-3232.3S-4005-3-079AM	–	–	–	–	39	41	43	45	46	48	49
R396.20-02.478-4005-9AW	–	–	–	–	80	–	84	–	–	–	89

Note! When milling threads to smaller diameters than indicated for a certain pitch/cutter combination, an incorrect thread form will result.

Dimensions of mounting

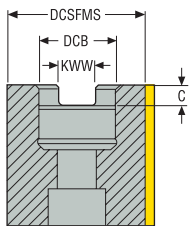

For cutter	Item number	DCB	DCSFMS	KWW	C	For arbor
		mm	mm	mm	mm	
R396.19-0058-4003-6AM	02546921	27,0	53,0	12,4	7,0	27
R396.19-0058-4005-6AM	02546920	27,0	50,0	12,4	7,0	27
R396.20-02.478-4005-9AW	03013869	25,4	53,5	9,7	5,7	25,4

13NMS/XMS

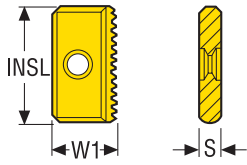

Tolerances:
INSL = ± 0,012 mm
HC = ± 0,012 mm
S = ± 0,025 mm

Designation	Insert	INSL		S				
		mm	Inch	mm	Inch	Grades		
						CP500	F30M	H15
13NMS1.0ISO	For internal threading	13,0	0.512	2,5	0.098	■		
13NMS1.5ISO	For internal threading	13,0	0.512	2,5	0.098	■		
13NMS2.0ISO	For internal threading	13,0	0.512	2,5	0.098	■		
13NMS24UN	For internal threading	13,0	0.512	2,5	0.098	■		
13NMS20UN	For internal threading	13,0	0.512	2,5	0.098	■		
13NMS16UN	For internal threading	13,0	0.512	2,5	0.098	■		
13XMS19W	For external and internal threading	13,0	0.512	2,5	0.098	■		
13XMS14W	For external and internal threading	13,0	0.512	2,5	0.098	■		

■ Stock standard.

Thread turning

MDT

Mini-Shaft™

Thread milling

Thread tapping

Annex

396.19-4003

Tolerances:
INSL = ± 0,007 mm
HC = ± 0,012 mm
S = ± 0,05 mm

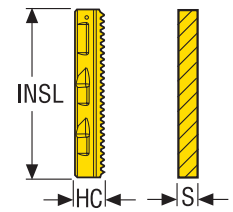

Designation	Insert	INSL	S	Grades		
				CP500	F30M	H15
		mm <i>Inch</i>	mm <i>Inch</i>			
396.19-4003.0E1.0ISO	For external threading	40,0 1.575	3,5 0.138		■	
396.19-4003.0E1.5ISO	For external threading	40,0 1.575	3,5 0.138		■	
396.19-4003.0E2.0ISO	For external threading	40,0 1.575	3,5 0.138		■	
396.19-4003.0E18UN	For external threading	40,0 1.575	3,5 0.138		■	
396.19-4003.0E16UN	For external threading	40,0 1.575	3,5 0.138		■	
396.19-4003.0E14UN	For external threading	40,0 1.575	3,5 0.138		■	
396.19-4003.0E12UN	For external threading	40,0 1.575	3,5 0.138		■	
396.19-4003.0N1.0ISO	For internal threading	40,0 1.575	3,5 0.138		■	■
396.19-4003.0N1.5ISO	For internal threading	40,0 1.575	3,5 0.138		■	■
396.19-4003.0N2.0ISO	For internal threading	40,0 1.575	3,5 0.138		■	■
396.19-4003.0N2.5ISO	For internal threading	40,0 1.575	3,5 0.138		■	
396.19-4003.0N3.0ISO	For internal threading	40,0 1.575	3,5 0.138		■	
396.19-4003.0N20UN	For internal threading	40,0 1.575	3,5 0.138		■	
396.19-4003.0N18UN	For internal threading	40,0 1.575	3,5 0.138		■	
396.19-4003.0N16UN	For internal threading	40,0 1.575	3,5 0.138		■	■
396.19-4003.0N14UN	For internal threading	40,0 1.575	3,5 0.138		■	■
396.19-4003.0N12UN	For internal threading	40,0 1.575	3,5 0.138		■	■
396.19-4003.0N10UN	For internal threading	40,0 1.575	3,5 0.138		■	
396.19-4003.0N9UN	For internal threading	40,0 1.575	3,5 0.138		■	
396.19-4003.0N8UN	For internal threading	40,0 1.575	3,5 0.138		■	
396.19-4003.0X16W	For external and internal threading	40,0 1.575	3,5 0.138		■	
396.19-4003.0X14W	For external and internal threading	40,0 1.575	3,5 0.138		■	
396.19-4003.0X12W	For external and internal threading	40,0 1.575	3,5 0.138		■	
396.19-4003.0X11W	For external and internal threading	40,0 1.575	3,5 0.138		■	

■ Stock standard.

Thread turning

MDT

Mini-Shaft™

Thread milling

Thread tapping

Annex

396.19-4003/4005

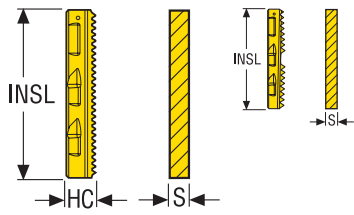

Designation	Insert	INSL		S	Grades		
		mm	Inch		CP500	F30M	H15
396.19-4005.0N3.5ISO	For internal threading	40,0	1.575	4,85		■	
396.19-4005.0N4.0ISO	For internal threading	40,0	1.575	4,85		■	
396.19-4005.0N4.5ISO	For internal threading	40,0	1.575	4,85		■	
396.19-4005.0N5.0ISO	For internal threading	40,0	1.575	4,85		■	
396.19-4005.0N5.5ISO	For internal threading	40,0	1.575	4,85		■	
396.19-4005.0N6.0ISO	For internal threading	40,0	1.575	4,85		■	
396.19-4005.0N7UN	For internal threading	40,0	1.575	4,85		■	
396.19-4005.0N6UN	For internal threading	40,0	1.575	4,85		■	
396.19-4005.0N5UN	For internal threading	40,0	1.575	4,85		■	
396.19-4005.0N4.5UN	For internal threading	40,0	1.575	4,85		■	
396.19-4005.0N4UN	For internal threading	40,0	1.575	4,85		■	
396.19-4005.0X8W	For external and internal threading	40,0	1.575	4,85		■	
R396.19-4003.0X14NPT	For external and internal threading	40,0	1.575	3,5		■	
R396.19-4003.0X11.5NPT	For external and internal threading	40,0	1.575	3,5		■	
R396.19-4005.0X8NPT	For external and internal threading	40,0	1.575	4,85		■	
R396.19-4003.0X14NPTF	For external and internal threading	40,0	1.575	3,5		■	
R396.19-4003.0X11.5NPTF	For external and internal threading	40,0	1.575	3,5		■	
R396.19-4003.0X14BSPT	For external and internal threading	40,0	1.575	3,5		■	
R396.19-4003.0X11BSPT	For external and internal threading	40,0	1.575	3,5		■	
396.19-4003XX	Non cutting blank	40,0	1.575	3,5			■
396.19-4005XX	Non cutting blank	40,0	1.575	4,85			■

■ Stock standard.

Thread turning

MDT

Mini-Shaft™

Thread milling

Thread tapping

Annex

396.20-4005

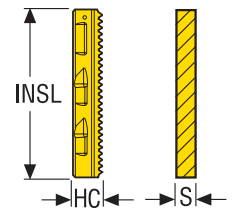

Designation	Insert	INSL		S		Grades		
		mm	Inch	mm	Inch	CP500	F30M	H15
396.20-4005.0N3ACME	For internal threading	40,0	1.575	4,9	0.193		■	
396.20-4005.0N4ACME	For internal threading	40,0	1.575	4,9	0.193		■	
396.20-4005.0N8ACME	For internal threading	40,0	1.575	4,9	0.193		■	
396.20-4005.0N4BUT	For internal threading	40,0	1.575	4,85	0.191		■	

■ Stock standard.



Thread milling Shanks

Generate precision threads in holes as deep as 106 mm with Seco's new single raw Disc Mill 335.14 interchangeable threading heads and matching holder shanks. You will also be able to boost processing speed and versatility, as each head performs both chamfering and threading operations. Additionally, performing two operations with the same tool helps reduce required tooling inventories.

- Both carbide and steel shank types
- Internal coolant capability
- Over 31 different carbide-coated heads

335.14 Shank - Cylindrical version

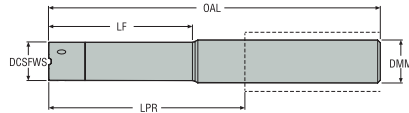

- For cutting data see page(s) 227
- Technical information, see page 213
- -E = Carbide shank with DMM tolerance = h6
- Steel shank: DMM tolerance = g6
- Max RPM = 30 000 rev/min

Designation	Item number	DCSFWS	DMM	LF	OAL	LPR	Weight	Through coolant	Insert
		mm	mm	mm	mm	mm	kg		
335.14-1006.0-015-060	03042024	6,0	10,0	11,5	56,5	16,5	0,1	–	R335.14...06Z..
335.14-1206.0-021-080-E	03042025	6,0	12,0	17,5	76,5	31,5	0,1	✓	R335.14...06Z..
335.14-1206.0-030-090-E	03042026	6,0	12,0	26,5	86,5	41,5	0,1	✓	R335.14...06Z..
335.14-1206.0-042-100-E	03042027	6,0	12,0	38,5	96,5	51,5	0,2	✓	R335.14...06Z..
335.14-1008.0-017-060	03042040	8,0	10,0	12,5	55,5	15,5	0,1	–	R335.14...08Z..
335.14-1208.0-029-095-E	03042041	8,0	12,0	24,5	90,5	45,5	0,2	✓	R335.14...08Z..
335.14-1208.0-042-110-E	03042042	8,0	12,0	37,5	105,5	60,5	0,2	✓	R335.14...08Z..
335.14-1208.0-056-120-E	03042043	8,0	12,0	51,5	115,5	70,5	0,2	✓	R335.14...08Z..
335.14-1609.0-018-080	03042028	9,0	16,0	12,2	74,2	26,2	0,1	✓	R335.14...09Z..
335.14-1609.0-032-100-E	03042029	9,0	16,0	26,2	94,2	46,2	0,3	✓	R335.14...09Z..
335.14-1609.0-045-110-E	03042030	9,0	16,0	39,2	104,2	56,2	0,2	✓	R335.14...09Z..
335.14-1609.0-064-130-E	03042031	9,0	16,0	58,2	124,2	76,2	0,3	✓	R335.14...09Z..
335.14-1612.0-024-080	03042032	12,0	16,0	18,3	74,3	26,3	0,1	✓	R335.14...12Z..
335.14-1612.0-042-100-E	03042033	12,0	16,0	36,3	94,3	46,3	0,2	✓	R335.14...12Z..
335.14-1612.0-060-130-E	03042034	12,0	16,0	54,3	124,3	76,3	0,3	✓	R335.14...12Z..
335.14-1612.0-085-160-E	03042035	12,0	16,0	76,3	154,3	106,3	0,4	✓	R335.14...12Z..
335.14-1614.0-042-100-E	03042036	14,3	16,0	35,5	93,5	45,5	0,3	✓	R335.14...14Z..
335.14-1614.0-060-130-E	03042037	14,3	16,0	53,5	123,5	75,5	0,3	✓	R335.14...14Z..
335.14-1614.0-085-160-E	03042038	14,3	16,0	78,5	153,5	105,5	0,4	✓	R335.14...14Z..
335.14-2014.0-036-100	03042039	14,0	20,0	29,2	93,5	43,5	0,2	✓	R335.14...14Z..

Spare Parts, included in delivery

For cutter	Insert key	Insert screw	Key (T-handle)
335.14...06	H4B-T08P	C92608-T08P	DOUBLE-T
335.14...08	H4B-T10P	C93510-T10P	DOUBLE-T
335.14...09	H4B-T15P	C94012-T15P	DOUBLE-T
335.14...12/14	H6B-T20P	C95012-T20P	DOUBLE-T

335.14 Shank - Cylindrical version

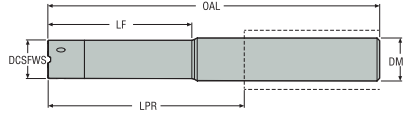

- For cutting data see page(s) 227
- Technical information, see page 213
- -E = Carbide shank with DMM tolerance = h6
- Steel shank: DMM tolerance = g6
- Max RPM = 30 000 rev/min

Designation	Item number	DCSFWS	DMM	LF	OAL	LPR	Weight	Through coolant	Insert
		<i>Inch</i>	<i>Inch</i>	<i>Inch</i>	<i>Inch</i>	<i>Inch</i>	<i>lbs</i>		
335.14-050006.0-083-315-E	03042121	0.236	0.500	0.689	3.012	1.240	0.220	✓	R334.14...06Z..
335.14-050006.0-118-354-E	03042122	0.236	0.500	1.043	3.406	1.634	0.440	✓	R334.14...06Z..
335.14-050006.0-165-394-E	03042107	0.236	0.500	1.516	3.799	2.028	0.440	✓	R334.14...06Z..
335.14-050008.0-114-374-E	03042123	0.315	0.500	0.965	3.563	1.791	0.440	✓	R334.14...08Z..
335.14-050008.0-165-433-E	03042124	0.315	0.500	1.476	4.154	2.382	0.440	✓	R334.14...08Z..
335.14-050008.0-220-472-E	03042119	0.315	0.500	2.028	4.547	2.776	0.440	✓	R334.14...08Z..
335.14-062509.0-071-315	03042108	0.354	0.625	0.480	2.921	1.031	0.220	✓	R334.14...09Z..
335.14-062509.0-126-394-E	03042109	0.354	0.625	1.031	3.709	1.819	0.440	✓	R334.14...09Z..
335.14-062509.0-177-433-E	03042110	0.354	0.625	1.543	4.102	2.213	0.440	✓	R334.14...09Z..
335.14-062509.0-252-512-E	03042111	0.354	0.625	2.291	4.890	3.000	0.660	✓	R334.14...09Z..
335.14-062512.0-094-315	03042112	0.472	0.625	0.720	2.925	1.035	0.220	✓	R334.14...12Z..
335.14-062512.0-165-394-E	03042113	0.472	0.625	1.429	3.713	1.823	0.440	✓	R334.14...12Z..
335.14-062512.0-236-512-E	03042114	0.472	0.625	2.138	4.894	3.004	0.660	✓	R334.14...12Z..
335.14-062512.0-335-630-E	03042115	0.472	0.625	3.122	6.075	4.185	0.660	✓	R334.14...12Z..
335.14-062514.0-165-394-E	03042116	0.551	0.625	1.398	3.681	1.791	0.440	✓	R334.14...14Z..
335.14-062514.0-236-512-E	03042117	0.551	0.625	2.106	4.862	2.972	0.880	✓	R334.14...14Z..
335.14-062514.0-335-630-E	03042118	0.551	0.625	3.091	6.043	4.154	0.880	✓	R334.14...14Z..

Spare Parts, included in delivery

For cutter	Insert key	Insert screw	Key (T-handle)
335.14-..06	H4B-T08P	C92608-T08P	DOUBLE-T
335.14-..08	H4B-T10P	C93510-T10P	DOUBLE-T
335.14-..09	H4B-T15P	C94012-T15P	DOUBLE-T
335.14-..12/14	H6B-T20P	C95012-T20P	DOUBLE-T

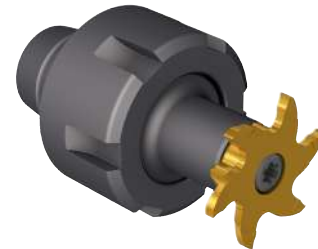
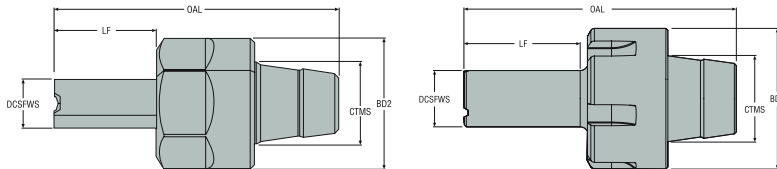

335.14 Shank with ER collet



- For cutting data see page(s) 227
- Technical information, see page 213

Designation	Item number	DCSFWS	BD2	LF	OAL	CTMS	Weight	Through coolant	Insert
		mm	mm	mm	mm	mm	kg		
335.14-ER11-06-016	03042072	6,0	16,0	12,5	34,9	ER 11	0,1	–	R335.14...06Z..
335.14-ER11-08-016	03042085	8,0	16,0	11,5	33,8	ER 11	0,1	–	R335.14...08Z..
335.14-ER16-08-022	03042086	8,0	32,0	17,5	49,6	ER 16	0,2	–	R335.14...08Z..
335.14-ER11-09-022	03042073	9,0	16,0	16,2	38,5	ER 11	0,1	–	R335.14...09Z..
335.14-ER16-09-022	03042074	9,0	32,0	16,2	48,3	ER 16	0,2	–	R335.14...09Z..
335.14-ER25-09-022	03042075	9,0	35,0	16,2	55,3	ER 25	0,2	–	R335.14...09Z..
335.14-ER16-12-030	03042076	12,0	32,0	24,3	56,4	ER 16	0,2	–	R335.14...12Z..
335.14-ER25-12-030	03042078	12,0	35,0	24,3	63,4	ER 25	0,2	–	R335.14...12Z..
335.14-ER32-12-030	03042079	12,0	50,0	24,3	69,4	ER 32	0,4	–	R335.14...12Z..
335.14-ER25-14-019	03042080	14,0	35,0	12,5	52,3	ER 25	0,2	–	R335.14...14Z..
335.14-ER25-14-035	03042081	14,0	35,0	28,5	67,6	ER 25	0,2	–	R335.14...14Z..
335.14-ER32-14-019	03042082	14,0	50,0	12,5	58,3	ER 32	0,5	–	R335.14...14Z..
335.14-ER32-14-035	03042083	14,0	50,0	28,5	73,6	ER 32	0,4	–	R335.14...14Z..

Spare Parts, included in delivery

For cutter	Insert key	Insert screw	Key (T-handle)
			
335.14-ER...06	H4B-T08P	C92608-T08P	DOUBLE-T
335.14-ER...08	H4B-T10P	C93510-T10P	DOUBLE-T
335.14-ER...09	H4B-T15P	C94012-T15P	DOUBLE-T
335.14-ER...12/14	H6B-T20P	C95012-T20P	DOUBLE-T

335.14 Inserts

Thread profile Whitworth - Metric

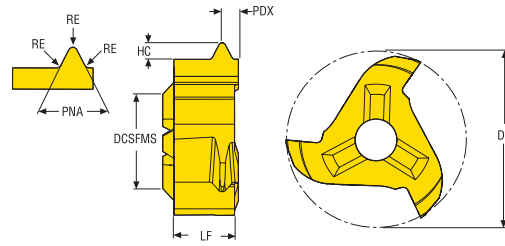

- For cutting data see page(s) 227
- Technical information, see page 213

Designation	Pitch		DC	RE	DCSFMS	HC	LF	PDX	PNA	ZEFP	Grades
	mm	TPIX									mm Inch
R335.14-117WXF11.06Z3	-	11	11,7 0.461	0,31 0.012	6,0 0.236	1,48 0.058	3,6 0.142	1,6 0.063	55,0 2.165	3	F32M
R335.14-117WXF14.06Z3	-	14	11,7 0.461	0,24 0.009	6,0 0.236	1,16 0.046	3,6 0.142	1,3 0.051	55,0 2.165	3	F32M
R335.14-117WXF19.06Z3	-	19	11,7 0.461	0,18 0.007	6,0 0.236	0,86 0.034	3,6 0.142	1,1 0.043	55,0 2.165	3	F32M
R335.14-157WXF14.08Z3	-	14	15,7 0.618	0,24 0.009	8,0 0.315	1,17 0.046	4,6 0.181	1,5 0.059	55,0 2.165	3	F32M
R335.14-177WXF11.09Z3	-	11	17,7 0.697	0,31 0.012	9,0 0.354	1,48 0.058	5,85 0.230	1,45 0.057	55,0 2.165	3	F32M
R335.14-177WXF14.09Z3	-	14	17,7 0.697	0,24 0.009	9,0 0.354	1,16 0.046	5,85 0.230	1,25 0.049	55,0 2.165	3	F32M
R335.14-177WXF19.09Z3	-	19	17,7 0.697	0,18 0.007	9,0 0.354	0,856 0.034	5,85 0.230	0,95 0.037	55,0 2.165	3	F32M

■ Stock standard.

Thread turning

MDT

Mini-Shaft™

Thread milling

Thread tapping

Annex

335.14 Inserts

Thread profile Partial Metric

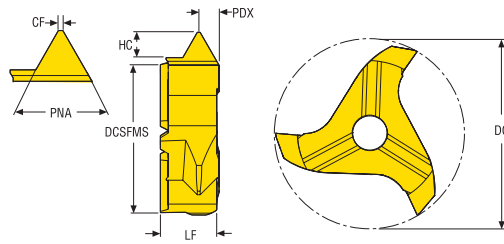

- For cutting data see page(s) 227
- Technical information, see page 213

Designation	Pitch		DC	CF	DCSFMS	HC	LF	PDX	PNA	ZEFP	Grades	
	mm	TPI									Coated	F32M
R335.14-117MNP100200.06Z3	1,0-2,0	0.039-0.079	11,7 0.461	0.13 0.005	6,0 0.236	1,25 0.049	3,6 0.142	0,8 0.031	60,0 2.362	3	■	
R335.14-117MNP200300.06Z3	2,0-3,0	0.079-0.118	11,7 0.461	0.25 0.010	6,0 0.236	1,78 0.070	3,6 0.142	1,2 0.047	60,0 2.362	3	■	
R335.14-157MNP150275.08Z3	1,5-2,75	0.059-0.108	15,7 0.618	0.19 0.007	8,0 0.315	1,67 0.066	4,6 0.181	1,1 0.043	60,0 2.362	3	■	
R335.14-157MNP250300.08Z3	2,5-3,0	0.098-0.118	15,7 0.618	0.31 0.012	8,0 0.315	1,78 0.070	4,6 0.181	1,2 0.047	60,0 2.362	3	■	
R335.14-177MNP100200.09Z3	1,0-2,0	0.039-0.079	17,7 0.697	0.12 0.005	9,0 0.354	1,19 0.047	5,85 0.230	1,15 0.045	60,0 2.362	3	■	
R335.14-177MNP150275.09Z3	1,5-2,75	0.059-0.108	17,7 0.697	0.19 0.007	9,0 0.354	1,62 0.064	5,85 0.230	1,25 0.049	60,0 2.362	3	■	
R335.14-177MNP200375.09Z3	2,0-3,75	0.079-0.148	17,7 0.697	0.25 0.010	9,0 0.354	2,22 0.087	5,85 0.230	1,65 0.065	60,0 2.362	3	■	
R335.14-177MNP300550.09Z3	3,0-5,5	0.118-0.217	17,7 0.697	0.38 0.015	9,0 0.354	3,25 0.128	5,85 0.230	2,25 0.089	60,0 2.362	3	■	
R335.14-217MNP100200.12Z3	1,0-2,0	0.039-0.079	21,7 0.854	0.12 0.005	12,0 0.472	1,19 0.047	5,85 0.230	1,25 0.049	60,0 2.362	3	■	
R335.14-217MNP200375.12Z3	2,0-3,75	0.079-0.148	21,7 0.854	0.25 0.010	12,0 0.472	2,22 0.087	5,85 0.230	1,65 0.065	60,0 2.362	3	■	
R335.14-217MNP250450.12Z3	2,5-4,5	0.098-0.177	21,7 0.854	0.25 0.010	12,0 0.472	2,7 0.106	5,85 0.230	2,15 0.085	60,0 2.362	3	■	
R335.14-217MNP350600.12Z3	3,5-6,0	0.138-0.236	21,7 0.854	0.44 0.017	12,0 0.472	3,84 0.151	5,85 0.230	2,65 0.104	60,0 2.362	3	■	
R335.14-277MNP250500.14Z3	2,5-5,0	0.098-0.197	27,7 1.091	0.37 0.015	14,0 0.551	2,93 0.115	6,6 0.260	2,6 0.102	60,0 2.362	3	■	
R335.14-277MNP400600.14Z3	4,0-6,0	0.157-0.236	27,7 1.091	0.5 0.020	14,0 0.551	4,6 0.181	6,6 0.260	3,0 0.118	60,0 2.362	3	■	

■ Stock standard.

Thread turning

MDT

Mini-Shaft™

Thread milling

Thread tapping

Annex

335.14 Inserts

Thread profile UN - Metric

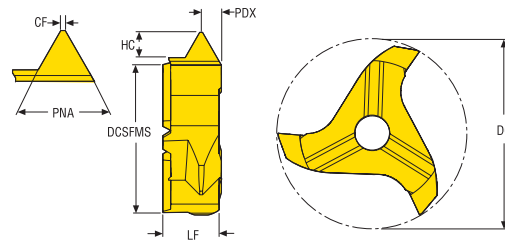

- For cutting data see page(s) 227
- Technical information, see page 213

Designation	Pitch		DC	CF	DCSFMS	HC	LF	PDX	PNA	ZEFP	Grades
	mm	TPIX									mm Inch
R335.14-177UNNF10.09Z3	-	10	17,7 0.697	0,32 0.013	9,0 0.354	1,375 0.054	5,85 0.230	1,25 0.049	60,0 2.362	3	■
R335.14-177UNNF11.09Z3	-	11	17,7 0.697	0,29 0.011	9,0 0.354	1,249 0.049	5,85 0.230	1,05 0.041	60,0 2.362	3	■
R335.14-177UNNF12.09Z3	-	12	17,7 0.697	0,27 0.011	9,0 0.354	1,146 0.045	5,85 0.230	1,05 0.041	60,0 2.362	3	■
R335.14-177UNNF14.09Z3	-	14	17,7 0.697	0,23 0.009	9,0 0.354	0,982 0.039	5,85 0.230	0,85 0.033	60,0 2.362	3	■
R335.14-177UNNF16.09Z3	-	16	17,7 0.697	0,2 0.008	9,0 0.354	0,859 0.034	5,85 0.230	0,85 0.033	60,0 2.362	3	■
R335.14-177UNNF18.09Z3	-	18	17,7 0.697	0,18 0.007	9,0 0.354	0,763 0.030	5,85 0.230	0,85 0.033	60,0 2.362	3	■
R335.14-177UNNF20.09Z3	-	20	17,7 0.697	0,16 0.006	9,0 0.354	0,687 0.027	5,85 0.230	0,65 0.026	60,0 2.362	3	■
R335.14-177UNNF24.09Z3	-	24	17,7 0.697	0,13 0.005	9,0 0.354	0,572 0.023	5,85 0.230	0,65 0.026	60,0 2.362	3	■
R335.14-177UNNF6.09Z3	-	6	17,7 0.697	0,53 0.021	9,0 0.354	2,291 0.090	5,85 0.230	1,65 0.065	60,0 2.362	3	■
R335.14-177UNNF8.09Z3	-	8	17,7 0.697	0,4 0.016	9,0 0.354	1,718 0.068	5,85 0.230	1,45 0.057	60,0 2.362	3	■

■ Stock standard.

Thread turning

MDT

Mini-Shaft™

Thread milling

Thread tapping

Annex



Threadmaster™ Taps

Designed to be universal in application, the high-speed steel Threadmaster Tap effectively threads holes in a wide range of workpiece types and materials. The tool features an advanced coating technology that enables it to achieve higher cutting data and output in steel up to 350 HB, stainless steels and cast irons when compared to the uncoated solutions typically found in this product area.

- Features spiral helixes for blind holes and spiral points for through holes.
- Straight flutes accommodate for short chipping materials
- Advanced coatings for faster tapping

Introduction to taps

What are you looking for in a thread?

Cutting a thread vs forming a thread

There are two way of making a thread, cutting or forming. Cutting is to be used in most materials, while forming is to be used in steel, stainless steel and aluminium.

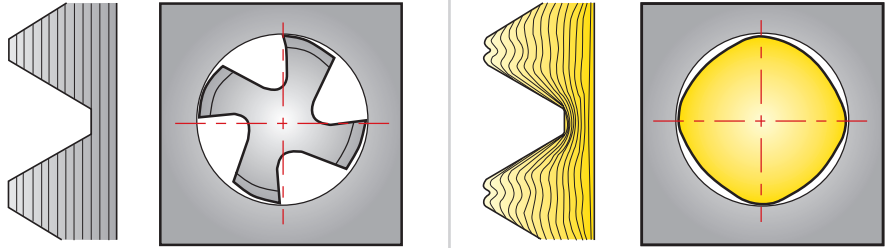

Through hole, blind hole

Taps have different designs. Depending on application (through or blind hole).

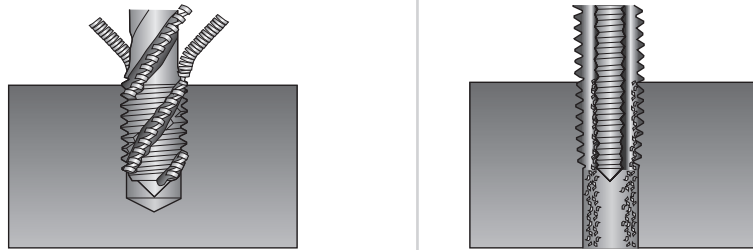

Hole size

Dimension of the hole differs between cutting and forming the thread.

Cutting tap
 $D = TD - PTH$

Forming tap
 $D = TD - PTH/2$
 $(D = D_{nom} - 0.0068 \times PTH \times 65)$

D = Hole diameter
 TD = Major thread diameter
 PTH = Thread pitch



Thread turning

MDT

Mini-Shaft™

Thread milling

Thread tapping

Annex

Introduction to taps – Tool guide

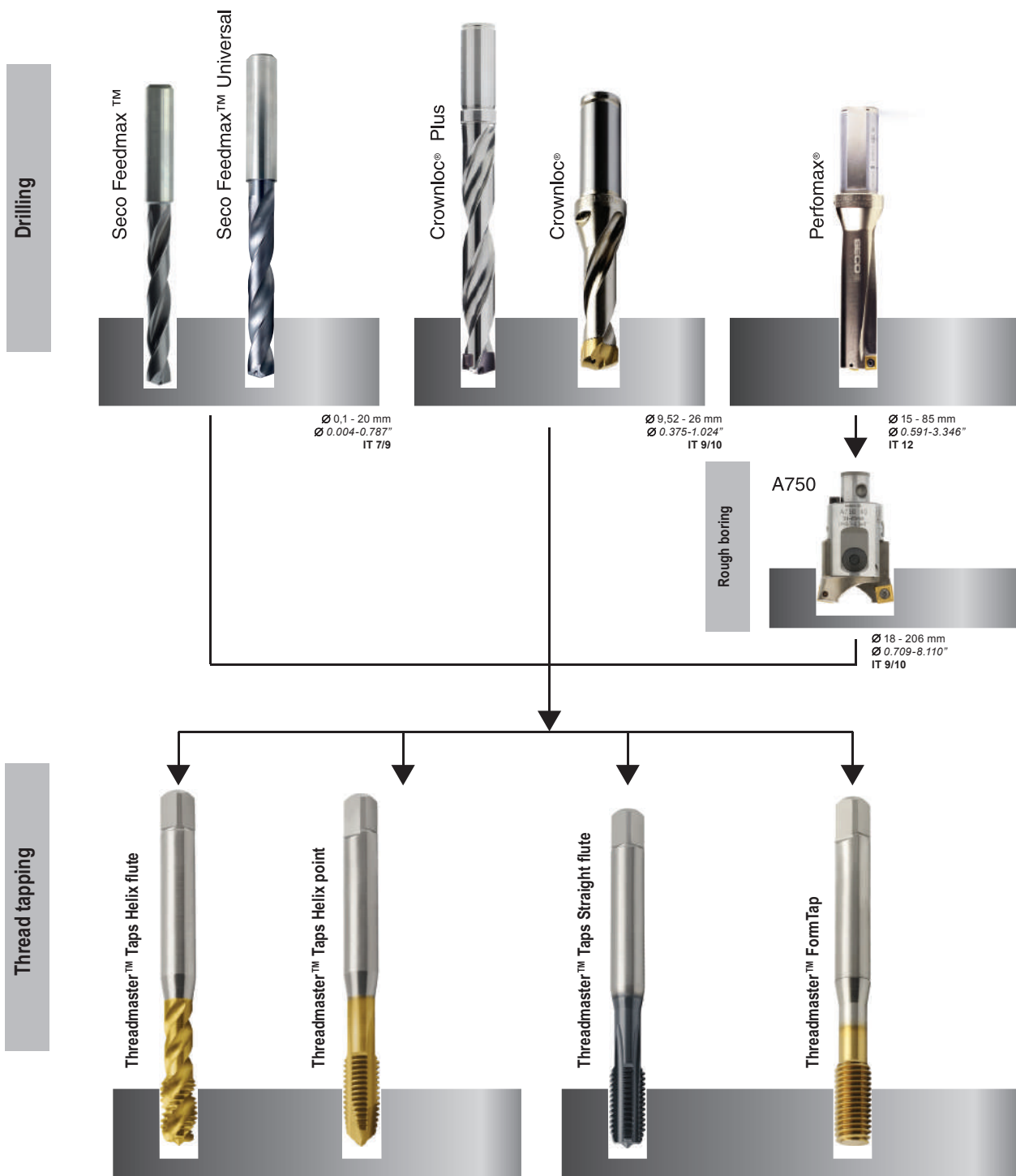

Thread turning

MDT

Mini-Shaft™

Thread milling

Thread tapping

Annex

Taps – Choice of Tap tolerance

The Threadmaster™ Taps from Seco are available for threads with different tolerances 6H and 6G, as well in 6HX and 6GX.

Normal standard tolerance is H.

Tolerance GX/HX and BX is to be used when risk of oversize is limited, this also increases tool life of the tap.

Taps for UNC/UNF are designed for tolerance 2B.

Tolerance class for G and NPT/NPTF is normal.

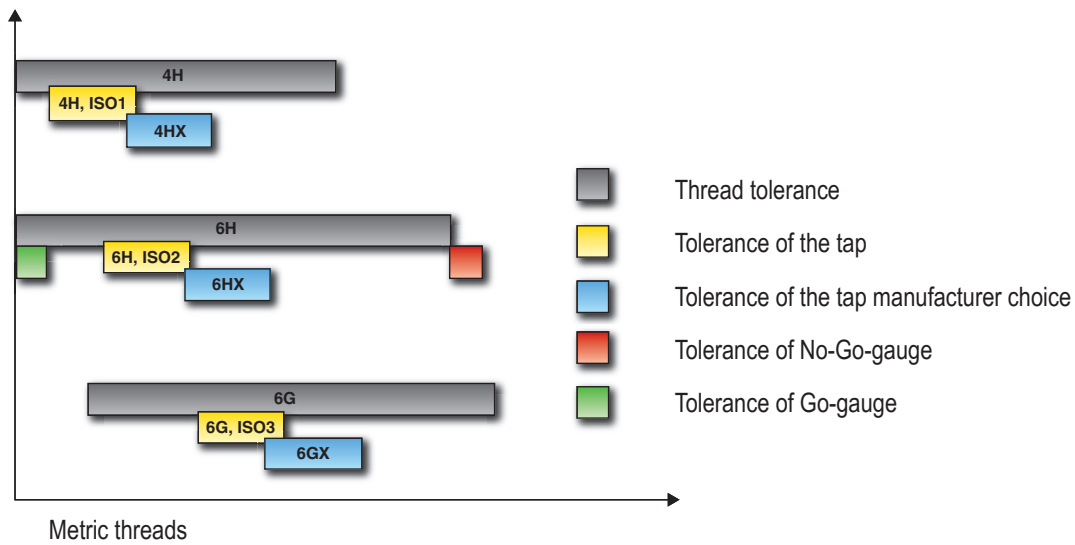

Thread turning

MDT

Mini-Shaft™

Thread milling

Thread tapping

Annex

Code key – Taps T34, T33 and T32

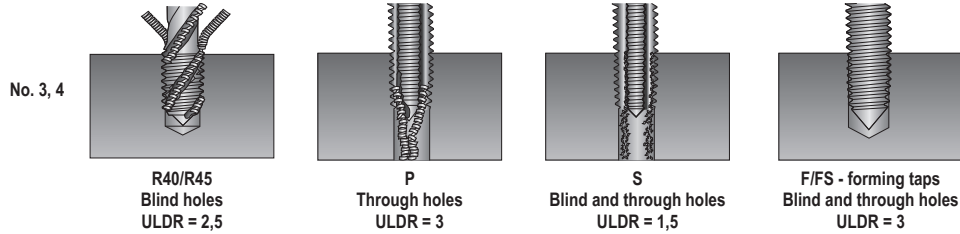

ULDR = Usable length diameter ratio

Description	
1	Family T34 – High performance versatile cutting taps T33 – Forming taps T32 – Versatile cutting taps
2	Internal coolant [Blank] – Without coolant A – Axial B – Radial
3	Design P – Helix Point S – Straight Flutes R – Right hand spiral flutes L – Left hand flute F – Forming tap FS – Forming tap with oil grooves
4	Flute angle 40 45 Used for Design R and L
5	Coating C – TiN + TiCN H – TiAlN + WC/C N – TiAlN + TiN
6	Thread Type 01 – M 02 – MF 04 – EGM - taps for Helicoil/STI threads 08 – UNC 09 – UNF 16 – EGUNC - taps for Helicoil/STI threads 17 – EGUNF - taps for Helicoil/STI threads 21 – G
7	Type of chamfer B = Cutting chamfer 3,5-5 threads C = Cutting chamfer 2-3 threads E = Cutting chamfer 1,5-2 threads
8	Standard 03 – DIN371 - with reinforced shank 04 – DIN371/EL - extra-long with reinforced shank 05 – DIN374 - reduced shank (for fine threads) 06 – DIN376 - reduced shank (for coarse threads) 07 – DIN376/EL - extra-long with reduced shank 09 – DIN5156 - reduced shank (for pipe threads)
9	Thread size
10	Pitch
11	Tolerance M threads: 41 – 4H 61 – 6G 62 – 6GX 63 – 6H 64 – 6H mod (for EG M) 65 – 6HX For UNC and UNF threads 21 – 2B 22 – 2BX For G threads: 11 – Normal 12 – Normal X
12	Hand R - Right L - Left

Code key – Taps MTH, MTS, MF and MTP

MTS	-	M10	X	1.5ISO	6H	-	B	C	-	V	0	01	-	A
1		2		3	4		5	6		7	8	9		10

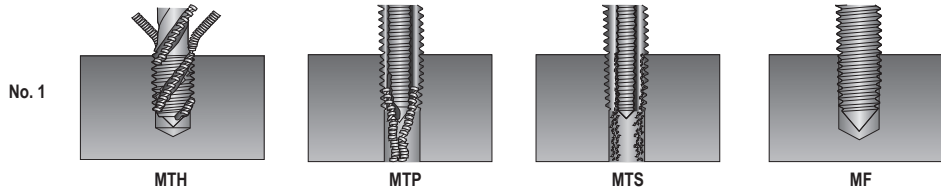

Description	
1	MTH = Threadmaster™ Tap Helix flute MTP = Threadmaster™ Tap Helix point MTS = Threadmaster™ Tap Straight flute tap MF = Threadmaster™ FormTap
2	Thread type and size
3	Pitch and thread form
4	Tolerance (tctr) 4H, 6H, 6HX, 6G, 6GX metric and 2B, 2BX, 3B, 3BX, Normal, NormalX inch
5	Operation B = Blind hole T = Through hole X = Blind and Through hole
6	Entering Chamfer (THCHT) B = Entering chamfer 3,5 - 5 threads C = Entering chamfer 2 - 3 threads E = Entering chamfer 1,5 - 2 threads
7	V = Versatile P = Steel M = Stainless Steel K = Cast Iron N = Non ferrous metals S = Superalloys and titanium
8	Release No. = 0 (2014)
9	Tool type No. = 01, 02, 03, 04 etc
10	A = Through coolant

Thread turning

MDT

Mini-Shaft™

Thread milling

Thread tapping

Annex

Taps – Entering chamfer THCHT

B-type	
<p>Length 3.5 – 5 threads High torque Best surface finish Thin chip thickness Low pressure at the chamfer Long tool life Most common for through holes (Helix point)</p>	
C-type	
<p>Length 2 - 3 threads Medium torque Good surface finish Normal chip thickness Normal pressure at the chamfer Normal tool life Most common design Standard for blind holes Most common for blind holes (Helix flute)</p>	
E-type	
<p>Length 1.5 – 2 threads Low torque Good surface finish Thick chip thickness High pressure at the chamfer Shorter tool life When limited space in the bottom of a hole</p>	

Thread turning

MDT

Mini-Shaft™

Thread milling

Thread tapping

Annex

Definitions for T32, T33 and T34

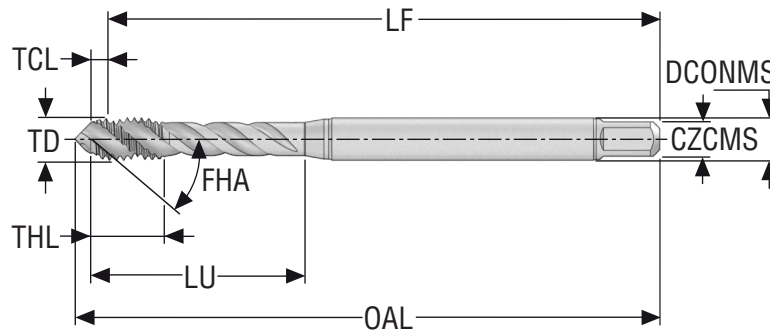

Definitions Seco Threadmaster™

BSG	= Basic standard group
TD	= Thread diameter
TDZ	= Thread diameter size
THCHT	= Threading chamfer type
TCL	= Thread chamfer length
THL	= Thread length
LU	= Usable length
LF	= Functional length
OAL	= Overall length
FHA	= Flute Helix angle
DCONS	= Connection diameter machine side
CZCMS	= Connection size code machine side
NOF	= Flute count
PHDR	= Recommended premachined hole diameter
PHDX	= Maximum premachined hole diameter
TCTR	= Thread tolerance class
TPI	= Threads per inch
ULDR	= Usable length diameter ratio

Definitions for -P, -M, -K, -N, -S, -V and MF

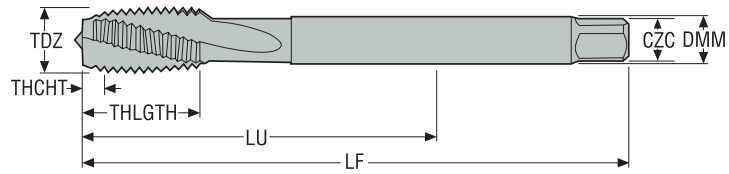

Definitions Seco Threadmaster™	
BSG	= Basic standard group
CZC	= Connection size code
DMM	= Shank diameter
FHA	= Flute helix angle
LF	= Functional length
LU	= Usable length
NOF	= Number of flutes
PHDR	= Recommended premachined hole diameter
PHDX	= Maximum premachined hole diameter
TCTR	= Thread tolerance class
TD	= Thread diameter
TDZ	= Thread diameter size
THCHT	= Thread chamfer type
THFT	= Thread form type ISO, Withworth, UN...
THLGTH	= Thread length
TPIX	= Threads per inch maximum
TTP	= Thread type internal/external/both
TPX	= Thread pitch maximum
ULDR	= Usable length diameter ratio

Taps - Choice of toolholder

The tool holder choice is made according to the machine spindle, with or without synchronization.

Modern CNC machine with synchronization:

The modern CNC machines can synchronize the spindle feed rate and rotation in order to make a rigid tapping operation. The TCER – tapping chucks with micro-compensation is the most suitable for synchronized tapping.

TCER Tapping chucks with micro-compensation, for synchronized tapping:



TCER for synchronized tapping has a micro-compensation system to avoid the small discrepancies and axial forces during rigid tapping machining. The taps are mounted in specific ER collets with square drive.

Note: These ER collets with square drive can also be mounted in ER collet chucks, but then without micro-compensation.







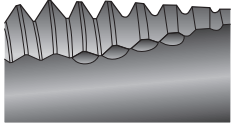
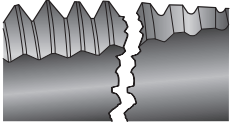
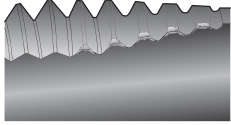
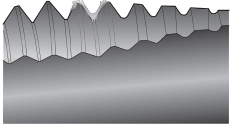











TCER

Troubleshooting

<p>Oversized thread</p> <p>Wrong tap for application - Refer to application charts</p> <p>Incorrect axial feed - Ensure feed rate is controlled - If possible, use tool holder for synchronized tapping</p> <p>Wrong cutting speed - Refer to recommendations</p> <p>Wrong tolerance - Choose tap with lower tolerance</p> 	<p>Undersized thread</p> <p>Tap worn out - Replace tap</p> <p>Tap drill hole too small - Check drilling recommendations</p> <p>Material closing after tapping - Increase drill diameter</p> <p>Wrong tolerance on tap - Choose tap with higher tolerance</p> 
<p>Chipping</p> <p>Wrong tap for the application - Check for tool selection</p> <p>Incorrect or lack of lubricant - Use appropriate emulsion or oil</p> <p>Tap hitting bottom of hole - Increase drill depth or reduce thread depth</p> <p>Trapped chip - Check tool selection</p> <p>Surface hardening in drilled hole - Check drilling recommendations</p> 	<p>Breakage</p> <p>Too high torque - Use tap holder with torque settings</p> <p>Tap worn out - Replace tap</p> <p>Incorrect or lack of lubricant - Use appropriate emulsion or oil</p> <p>Tap hitting bottom of hole - Increase drill depth or reduce thread depth</p> <p>Wrong cutting speed - Refer to recommendations</p> <p>"Birdnest" around tool - Check tool selection</p> <p>Tap drill hole too small - Check drilling recommendations</p> 
<p>Rapid wear</p> <p>Wrong type of tap for application - Refer to tap choice</p> <p>Incorrect or lack of lubricant - Use appropriate emulsion or oil</p> <p>Too high cutting speed - Refer to recommendations</p> <p>Work (surface) hardening in drilled hole - Check drilling recommendations - Drill worn out</p> <p>Tap drill hole too small - Check drilling recommendations</p> 	<p>Built-up edge</p> <p>Incorrect or lack of lubricant - Use appropriate emulsion or oil</p> <p>Tap worn out - Replace tap</p> <p>Wrong cutting speed - Refer to recommendations</p> <p>Wrong type of tap for application - Refer to tap choice</p> 

Taps Selection T32

Type of tap	T32-SNC-micro	T32-SNC	T32-PNB-micro	T32-PNB	T32-PNB	T32-R40NC-micro	T32-R40NC	T32-R40NC	
	TDZ< M3 		TDZ< M3 			TDZ< M3 			
Type of hole									
Chamfer form	C	C	B	B	B	C	C	C	
Coolant	External	External	External	External	External	External	External	External	
Substrate:	HSS-PM	HSSE	HSS-PM	HSSE	HSSE	HSS-PM	HSSE	HSSE	
ULDR	1,5	1,5	3	3	3	2,5	2,5	2,5	
FHA	-	-	-	-	-	40°	40°	40°	
Page(s)	M	288, 289	290, 291, 292	299, 300	301, 302, 303	304, 305	318, 319	320, 321, 322	323, 324
	M 6G				306, 307			325, 326	
	M LH		293, 294		308, 309			327, 328	
	MF		295, 296, 297		310, 311, 312			329, 330, 331	
	UNC				313, 314			332, 333	
	UNF				315, 316			334, 335	
	G		298		317			336	
	EG M								
	EG UNC								
EG UNF									

For cutting data, see next page

Thread turning

MDT

Mini-Shaft™

Thread milling

Thread tapping

Annex

Cutting data T32

SMG	v _c					
	T32-SNC-micro	T32-SNC	T32-PNB-micro	T32-PNB	T32-R40NC-micro	T32-R40NC
P1	20	20	20	20	20	20
	65	65	65	65	65	65
P2	20	20	20	20	20	20
	65	65	65	65	65	65
P3	17	17	17	17	17	17
	55	55	55	55	55	55
P4	15	15	15	15	15	15
	49	49	49	49	49	49
P5	14	14	14	14	14	14
	46	46	46	46	46	46
P6	16	16	16	16	16	16
	50	50	50	50	50	50
P7	15	15	15	15	15	15
	49	49	49	49	49	49
P8	14	14	14	14	14	14
	46	46	46	46	46	46
P11	15	15	15	15	15	15
	49	49	49	49	49	49
P12	8,7	8,7	8,7	8,7	8,7	8,7
	29	29	29	29	29	29
M1	12	12	12	12	12	12
	39	39	39	39	39	39
M2	10	10	10	10	10	10
	33	33	33	33	33	33
M3	7,6	7,6	7,6	7,6	7,6	7,6
	25	25	25	25	25	25
M4	5,7	5,7	5,7	5,7	5,7	5,7
	19	19	19	19	19	19
M5	4,8	4,8	4,8	4,8	4,8	4,8
	16	16	16	16	16	16
K1	17	17	17	17	—	—
	55	55	55	55	—	—
K2	15	15	15	15	—	—
	49	49	49	49	—	—
K3	13	13	13	13	13	13
	43	43	43	43	43	43
K4	12	12	12	12	12	12
	39	39	39	39	39	39
K5	—	—	—	—	—	—
	—	—	—	—	—	—
K6	—	—	—	—	—	—
	—	—	—	—	—	—
K7	—	—	—	—	—	—
	—	—	—	—	—	—
N1	23	23	23	23	23	23
	75	75	75	75	75	75
N2	15	15	15	15	15	15
	49	49	49	49	49	49
N3	10	10	10	10	10	10
	33	33	33	33	33	33
N11	13	13	13	13	13	13
	43	43	43	43	43	43
S1	—	—	—	—	—	—
	—	—	—	—	—	—
S2	—	—	—	—	—	—
	—	—	—	—	—	—
S3	—	—	—	—	—	—
	—	—	—	—	—	—
S11	—	—	—	—	—	—
	—	—	—	—	—	—
S12	—	—	—	—	—	—
	—	—	—	—	—	—
S13	—	—	—	—	—	—
	—	—	—	—	—	—

SMG = Seco material group
v_c = m/min (sf/min)

Cutting speeds (v_c) in the table are recommendations for a start value.

For more detailed information on cuttingdata, please visit MyPages or Seco Suggest on secotools.com

Thread turning

MDT

















Mini-Shaft™

Thread milling

Thread tapping

Annex

Taps Selection T34

Type of tap	T34-PHB-micro	T34-PHB	T34B-PHB	T34-R45HC-micro	T34-R45HC	T34A-R45HC	T34-R45HE	T34A-R45HE	
	TDZ< M3			TDZ< M3					
									
Type of hole									
Chamfer form	B	B	B	C	C	C	E	E	
Coolant	External	External	Internal	External	External	Internal	External	Internal	
Substrate:	HSS-PM	HSSE-PM	HSSE-PM	HSS-PM	HSSE-PM	HSSE-PM	HSSE-PM	HSSE-PM	
ULDR	3	3	3	2,5	2,5	2,5	2,5	2,5	
FHA	–	–	–	45°	45°	45°	45°	45°	
Page(s)	M	337, 338	339, 340	341, 342	358, 359	360, 361	364, 365	362, 363	
	M 6G								
	M LH								
	MF		343, 344	345, 346		366, 367	370, 371	368, 369	372
	UNC		347, 348			373, 374			
	UNF		349, 350			375, 376			
	G		351			377			
	EG M		352, 353					378, 379	
	EG UNC		354, 355					380, 381	
	EG UNF		356, 357					382, 383	

For cutting data, see next page

Thread turning

MDT

Mini-Shaft™

Thread milling

Thread tapping

Annex

Cutting data T34

SMG	v _c							
	T34-PHB-micro	T34-PHB	T34B-PHB	T34-R45HC-micro	T34-R45HC	T34A-R45HC	T34-R45HE	T34A-R45HE
P1	28	28	43	28	28	43	28	43
	90	90	140	90	90	140	90	140
P2	28	28	41	28	28	41	28	41
	90	90	135	90	90	135	90	135
P3	24	24	36	24	24	36	24	36
	80	80	120	80	80	120	80	120
P4	21	21	31	21	21	31	21	31
	70	70	100	70	70	100	70	100
P5	20	20	30	20	20	30	20	30
	65	65	100	65	65	100	65	100
P6	22	22	34	22	22	34	22	34
	70	70	110	70	70	110	70	110
P7	21	21	32	21	21	32	21	32
	70	70	105	70	70	105	70	105
P8	20	20	30	20	20	30	20	30
	65	65	100	65	65	100	65	100
P11	21	21	31	21	21	31	21	31
	70	70	100	70	70	100	70	100
P12	12	12	18	12	12	18	12	18
	39	39	60	39	39	60	39	60
M1	15	15	21	15	15	21	15	21
	49	49	70	49	49	70	49	70
M2	12	12	17	12	12	17	12	17
	39	39	55	39	39	55	39	55
M3	9,1	9,1	13	9,1	9,1	13	9,1	13
	30	30	43	30	30	43	30	43
M4	6,9	6,9	9,7	6,9	6,9	9,7	6,9	9,7
	23	23	32	23	23	32	23	32
M5	5,7	5,7	8,1	5,7	5,7	8,1	5,7	8,1
	19	19	27	19	19	27	19	27
K1	24	24	36	24	24	36	24	36
	80	80	120	80	80	120	80	120
K2	21	21	31	21	21	31	21	31
	70	70	100	70	70	100	70	100
K3	18	18	26	18	18	26	18	26
	60	60	85	60	60	85	60	85
K4	17	17	25	17	17	25	17	25
	55	55	80	55	55	80	55	80
K5	—	10	15	—	10	15	10	15
	—	33	49	—	33	49	33	49
K6	15	15	22	15	15	22	15	22
	49	49	70	49	49	70	49	70
K7	13	13	19	13	13	19	13	19
	43	43	60	43	43	60	43	60
N1	26	26	39	26	26	39	26	39
	85	85	130	85	85	130	85	130
N2	17	17	25	17	17	25	17	25
	55	55	80	55	55	80	55	80
N3	11	11	17	11	11	17	11	17
	36	36	55	36	36	55	36	55
N11	15	15	22	15	15	22	15	22
	49	49	70	49	49	70	49	70
S1	—	4,0	4,0	—	4,0	4,0	4,0	4,0
	—	13	13	—	13	13	13	13
S2	—	—	—	—	—	—	—	—
	—	—	—	—	—	—	—	—
S3	—	—	—	—	—	—	—	—
	—	—	—	—	—	—	—	—
S11	—	4,0	4,0	—	4,0	4,0	4,0	4,0
	—	13	13	—	13	13	13	13
S12	—	—	—	—	—	—	—	—
	—	—	—	—	—	—	—	—
S13	—	—	—	—	—	—	—	—
	—	—	—	—	—	—	—	—

SMG = Seco material group
v_c = m/min (sf/min)

Cutting speeds (v_c) in the table are recommendations for a start value.

For more detailed information on cutting data, please visit MyPages or Seco Suggest on secotools.com

Thread turning

MDT









Mini-Shaft™

Thread milling

Thread tapping

Annex

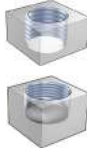
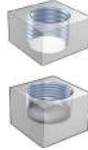
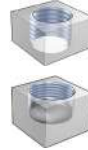
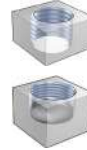
Taps Selection T33

Type of tap	T33-FNC	T33-FSNC	T33-FSCC	T33-FSCE	T33B-FSCE	T33A-FSCE	
							
Type of hole							
Chamfer form	C	C	C	E	E	E	
Coolant	External	External	External	External	Internal	Internal	
Substrate:	HSSE-PM	HSSE-PM	HSSE-PM	HSSE-PM	HSSE-PM	HSSE-PM	
ULDR	3	3	3	3	3	3	
Page(s)	M	384, 385	386, 387	397	398	400	399
	M 6G		388, 389				
	M LH						
	MF		390, 391	401, 402			
	UNC		392, 393				
	UNF		394, 395				
	G		396				
	EG M						
	EG UNC						
	EG UNF						

For cutting data, see next page

Thread turning

MDT

Mini-Shaft™

Thread milling

Thread tapping

Annex

Cutting data T33

SMG	v _c					
	T33-FNC	T33-FSNC	T33-FSCC	T33-FSCE	T33A-FSCE	T33B-FSCE
P1	21	21	21	21	28	28
	70	70	70	70	90	90
P2	21	21	21	21	28	28
	70	70	70	70	90	90
P3	18	18	18	18	24	24
	60	60	60	60	80	80
P4	16	16	16	16	21	21
	50	50	50	50	70	70
P5	15	15	15	15	20	20
	49	49	49	49	65	65
P6	17	17	17	17	22	22
	55	55	55	55	70	70
P7	16	16	16	16	21	21
	50	50	50	50	70	70
P8	—	—	—	—	—	—
	—	—	—	—	—	—
P11	—	—	—	—	—	—
	—	—	—	—	—	—
P12	—	—	—	—	—	—
	—	—	—	—	—	—
M1	19	19	19	19	19	19
	60	60	60	60	60	60
M2	15	15	15	15	15	15
	49	49	49	49	49	49
M3	11	11	11	11	11	11
	36	36	36	36	36	36
M4	—	—	8,6	8,6	8,6	8,6
	—	—	28	28	28	28
M5	—	—	—	—	—	—
	—	—	—	—	—	—
K1	—	—	—	—	—	—
	—	—	—	—	—	—
K2	—	—	—	—	—	—
	—	—	—	—	—	—
K3	—	—	—	—	—	—
	—	—	—	—	—	—
K4	—	—	—	—	—	—
	—	—	—	—	—	—
K5	—	—	—	—	—	—
	—	—	—	—	—	—
K6	—	—	—	—	—	—
	—	—	—	—	—	—
K7	—	—	—	—	—	—
	—	—	—	—	—	—
N1	31	31	47	47	47	47
	100	100	155	155	155	155
N2	20	20	30	30	30	30
	65	65	100	100	100	100
N3	—	—	20	20	20	20
	—	—	65	65	65	65
N11	—	—	27	27	27	27
	—	—	90	90	90	90
S1	—	—	—	—	—	—
	—	—	—	—	—	—
S2	—	—	—	—	—	—
	—	—	—	—	—	—
S3	—	—	—	—	—	—
	—	—	—	—	—	—
S11	—	—	—	—	—	—
	—	—	—	—	—	—
S12	—	—	—	—	—	—
	—	—	—	—	—	—
S13	—	—	—	—	—	—
	—	—	—	—	—	—

SMG = Seco material group
v_c = m/min (sf/min)

Cutting speeds (v_c) in the table are recommendations for a start value.

For more detailed information on cuttingdata, please visit MyPages or Seco Suggest on secotools.com

Thread turning

MDT

Mini-Shaft™

Thread milling

Thread tapping

Annex

Taps Selection MTH-P001 (-A) – MTH-P011

Tool type	MTH-P001 30-48 HRC	MTH-P001-A 30-48 HRC	MTH-P002 30-48 HRC	MTH-P002-A 30-48 HRC	MTH-P003	MTH-P003-A	MTH-P004	MTH-P004-A	MTH-P011
Thread type	M	M	M	M	M	M	M	M	MF
TCTR	6H	6H	6H	6H	6HX	6HX	6HX	6HX	6HX
ULDR	1.5	1.5	1.5	1.5	3	3	3	3	3
THCHT	C	C	C	C	C	C	C	C	C
BSG	SECO-DIN	SECO-DIN	DIN376	DIN376	DIN371	DIN371	DIN376	DIN376	DIN374
Thread size	M3 - M10	M4 - M10	M12 - M20	M12 - M20	M1.6 - M10	M4 - M10	M5 - M30	M12 - M30	MF 4X0.5 - MF 30X2.0
FHA	15°	15°	15°	15°	48°	48°	48°	48°	48°
									
Coolant	No	Yes	No	Yes	No	Yes	No	Yes	No
Page(s)	425	426	427	428	429	430	431	432	433, 434

For cutting data, see next page

Thread turning

MDT

Mini-Shaft™

Thread milling

Thread tapping

Annex

Cutting data MTH-P001 (-A) – P011

SMG	v _c								
	MTH- P001	MTH- P001-A	MTH- P002	MTH- P002-A	MTH- P003	MTH- P003-A	MTH- P004	MTH- P004-A	MTH- P011
P1	—	—	—	—	55	55	55	55	55
	—	—	—	—	180	180	180	180	180
P2	—	—	—	—	55	55	55	55	55
	—	—	—	—	180	180	180	180	180
P3	—	—	—	—	45	45	45	45	45
	—	—	—	—	150	150	150	150	150
P4	—	—	—	—	40	40	40	40	40
	—	—	—	—	130	130	130	130	130
P5	—	—	—	—	38	38	38	38	38
	—	—	—	—	125	125	125	125	125
P6	—	—	—	—	43	43	43	43	43
	—	—	—	—	140	140	140	140	140
P7	—	—	—	—	40	40	40	40	40
	—	—	—	—	130	130	130	130	130
P8	—	—	—	—	38	38	38	38	38
	—	—	—	—	125	125	125	125	125
P11	—	—	—	—	39	39	39	39	39
	—	—	—	—	130	130	130	130	130
P12	—	—	—	—	23	23	23	23	23
	—	—	—	—	75	75	75	75	75
M1	—	—	—	—	—	—	—	—	—
	—	—	—	—	—	—	—	—	—
M2	—	—	—	—	—	—	—	—	—
	—	—	—	—	—	—	—	—	—
M3	—	—	—	—	—	—	—	—	—
	—	—	—	—	—	—	—	—	—
M4	—	—	—	—	—	—	—	—	—
	—	—	—	—	—	—	—	—	—
M5	—	—	—	—	—	—	—	—	—
	—	—	—	—	—	—	—	—	—
K1	—	—	—	—	—	—	—	—	—
	—	—	—	—	—	—	—	—	—
K2	—	—	—	—	—	—	—	—	—
	—	—	—	—	—	—	—	—	—
K3	—	—	—	—	—	—	—	—	—
	—	—	—	—	—	—	—	—	—
K4	—	—	—	—	—	—	—	—	—
	—	—	—	—	—	—	—	—	—
K5	—	—	—	—	—	—	—	—	—
	—	—	—	—	—	—	—	—	—
K6	—	—	—	—	—	—	—	—	—
	—	—	—	—	—	—	—	—	—
K7	—	—	—	—	—	—	—	—	—
	—	—	—	—	—	—	—	—	—
N1	—	—	—	—	—	—	—	—	—
	—	—	—	—	—	—	—	—	—
N2	—	—	—	—	—	—	—	—	—
	—	—	—	—	—	—	—	—	—
N3	—	—	—	—	—	—	—	—	—
	—	—	—	—	—	—	—	—	—
N11	—	—	—	—	—	—	—	—	—
	—	—	—	—	—	—	—	—	—
H5	17	17	17	17	—	—	—	—	—
	55	55	55	55	—	—	—	—	—
H8	17	17	17	17	—	—	—	—	—
	55	55	55	55	—	—	—	—	—

SMG = Seco material group, v_c = m/min (sf/min)

Cutting speeds (v_c) in the table are recommendations for a start value and calculated when running in 2xD, except for V048, V050 and MTH-S (001, 002, 003, 004, 011, 012, 031, 032, 041, 042 and 044) that are calculated from 1,5xD.

When running in 1,5xD increase speed by 20% and at 2,5 x D reduce speed by 20%. At 3 x D reduce by 30%. Due to machine, material and setup condition it is advisable also to optimize cutting data.

Recommended ranges to use for each type of tap: K001-K002: +25% / -25%, V015-V016: +15% / -15%, V001-V045: +15% / -15%, V048-V050: +35% / -35%, V053-V063: +15% / -15%

Thread turning

MDT

Mini-Shaft™

Thread milling

Thread tapping

Annex

Taps Selection MTP-P001 – MTP-P011

Tool type	MTP-P001 30-48 HRC	MTP-P002 30-48 HRC	MTP-P003	MTP-P003-A	MTP-P004	MTP-P004-A	MTP-P011
Thread type	M	M	M	M	M	M	MF
TCTR	6H	6H	5HX/6HX	6HX	6HX	6HX	6HX
ULDR	2.5	2.5	3	3	3	3	3
THCHT	B	B	B	B	B	B	B
BSG	SECO-DIN	DIN376	DIN371	DIN371	DIN376	DIN376	DIN374
Thread size	M3 - M10	M12 - M20	M1 - M10	M4 - M10	M4 - M30	M12 - M30	MF 4X0.5 - MF 30X2.0
							
Coolant	No	No	No	Yes	No	Yes	No
Page(s)	403	404	405	406	407	408	409, 410

For cutting data, see next page

Thread turning

MDT

Mini-Shaft™

Thread milling

Thread tapping

Annex

Cutting data MTP-P001 – P011

SMG	v _c						
	MTP- P001	MTP- P002	MTP- P003	MTP- P003-A	MTP- P004	MTP- P004-A	MTP- P011
P1	—	—	60	60	60	60	60
	—	—	195	195	195	195	195
P2	—	—	60	60	60	60	60
	—	—	195	195	195	195	195
P3	—	—	50	50	50	50	50
	—	—	165	165	165	165	165
P4	—	—	45	45	45	45	45
	—	—	150	150	150	150	150
P5	—	—	43	43	43	43	43
	—	—	140	140	140	140	140
P6	—	—	48	48	48	48	48
	—	—	155	155	155	155	155
P7	—	—	46	46	46	46	46
	—	—	150	150	150	150	150
P8	—	—	43	43	43	43	43
	—	—	140	140	140	140	140
P11	—	—	44	44	44	44	44
	—	—	145	145	145	145	145
P12	—	—	26	26	26	26	26
	—	—	85	85	85	85	85
M1	—	—	—	—	—	—	—
	—	—	—	—	—	—	—
M2	—	—	—	—	—	—	—
	—	—	—	—	—	—	—
M3	—	—	—	—	—	—	—
	—	—	—	—	—	—	—
M4	—	—	—	—	—	—	—
	—	—	—	—	—	—	—
M5	—	—	—	—	—	—	—
	—	—	—	—	—	—	—
K1	—	—	—	—	—	—	—
	—	—	—	—	—	—	—
K2	—	—	—	—	—	—	—
	—	—	—	—	—	—	—
K3	—	—	—	—	—	—	—
	—	—	—	—	—	—	—
K4	—	—	—	—	—	—	—
	—	—	—	—	—	—	—
K5	—	—	—	—	—	—	—
	—	—	—	—	—	—	—
K6	—	—	—	—	—	—	—
	—	—	—	—	—	—	—
K7	—	—	—	—	—	—	—
	—	—	—	—	—	—	—
N1	—	—	—	—	—	—	—
	—	—	—	—	—	—	—
N2	—	—	—	—	—	—	—
	—	—	—	—	—	—	—
N3	—	—	—	—	—	—	—
	—	—	—	—	—	—	—
N11	—	—	—	—	—	—	—
	—	—	—	—	—	—	—
H5	17	17	—	—	—	—	—
	55	55	—	—	—	—	—
H8	17	17	—	—	—	—	—
	55	55	—	—	—	—	—

SMG = Seco material group, v_c = m/min (sf/min)

Cutting speeds (v_c) in the table are recommendations for a start value and calculated when running in 2xD, except for V048, V050 and MTH-S (001, 002, 003, 004, 011, 012, 031, 032, 041, 042 and 044) that are calculated from 1,5xD.

When running in 1,5xD increase speed by 20% and at 2,5 x D reduce speed by 20%. At 3 x D reduce by 30%. Due to machine, material and setup condition it is advisable also to optimize cutting data.

Recommended ranges to use for each type of tap: K001-K002: +25% / -25%, V015-V016: +15% / -15%, V001-V045: +15% / -15%, V048-V050: +35% / -35%, V053-V063: +15% / -15%

Thread turning

MDT

Mini-Shaft™

Thread milling

Thread tapping

Annex

Taps Selection MTH-M003 (-A) – MTP-M004 (-A)

Tool type	MTH-M003	MTH-M003-A	MTH-M004	MTH-M004-A	MTP-M003-A	MTP-M004	MTP-M004-A
Thread type	M	M	M	M	M	M	M
TCTR	6H	6H	6H	6H	6H	6H	6H
ULDR	2.5	2.5	2.5	2.5	2.5	2.5	2.5
THCHT	C	C	C	C	B	B	B
BSG	DIN371	DIN371	DIN376	DIN376	DIN371	DIN376	DIN376
Thread size	M1.6 - M10	M4 - M10	M12 - M20	M12 - M20	M4 - M10	M12 - M20	M12 - M24
FHA	48°	48°	48°	48°	-	-	-
							
Coolant	No	Yes	No	Yes	Yes	No	Yes
Page(s)	435	436	437	438	411	412	413

For cutting data, see next page

Cutting data MTH-M003 (-A) – M004 (-A)

SMG	v _c						
	MTH- M003	MTH- M003-A	MTH- M004	MTH- M004-A	MTP- M003-A	MTP- M004	MTP- M004-A
P1	—	—	—	—	—	—	—
P2	—	—	—	—	—	—	—
P3	—	—	—	—	—	—	—
P4	—	—	—	—	—	—	—
P5	—	—	—	—	—	—	—
P6	—	—	—	—	—	—	—
P7	—	—	—	—	—	—	—
P8	—	—	—	—	—	—	—
P11	—	—	—	—	—	—	—
P12	—	—	—	—	—	—	—
M1	12 39	12 39	12 39	12 39	12 39	12 39	12 39
M2	10 33	10 33	10 33	10 33	10 33	10 33	10 33
M3	8 26	8 26	8 26	8 26	8 26	8 26	8 26
M4	6 20	6 20	6 20	6 20	6 20	6 20	6 20
M5	5 16	5 16	5 16	5 16	5 16	5 16	5 16
K1	—	—	—	—	—	—	—
K2	—	—	—	—	—	—	—
K3	—	—	—	—	—	—	—
K4	—	—	—	—	—	—	—
K5	—	—	—	—	—	—	—
K6	—	—	—	—	—	—	—
K7	—	—	—	—	—	—	—
N1	—	—	—	—	—	—	—
N2	—	—	—	—	—	—	—
N3	—	—	—	—	—	—	—
N11	—	—	—	—	—	—	—
H5	—	—	—	—	—	—	—
H8	—	—	—	—	—	—	—

SMG = Seco material group, v_c = m/min (sf/min)

Cutting speeds (v_c) in the table are recommendations for a start value and calculated when running in 2xD, except for V048, V050 and MTH-S (001, 002, 003, 004, 011, 012, 031, 032, 041, 042 and 044) that are calculated from 1,5xD.

When running in 1,5xD increase speed by 20% and at 2,5 x D reduce speed by 20%. At 3 x D reduce by 30%. Due to machine, material and setup condition it is advisable also to optimize cutting data.

Recommended ranges to use for each type of tap: K001-K002: +25% / -25%, V015-V016: +15% / -15%, V001-V045: +15% / -15%, V048-V050: +35% / -35%, V053-V063: +15% / -15%

Thread turning

MDT





Mini-Shaft™

Thread milling

Thread tapping

Annex

Taps Selection MTH-N001 – MTP-N002 (-A)

Tool type	MTH-N001	MTH-N002	MTP-N001	MTP-N001-A	MTP-N002	MTP-N002-A
Thread type	M	M	M	M	M	M
TCTR	6H	6H	6H	6H	6H	6H
ULDR	1.5	1.5	3	3	3	3
THCHT	C	C	B	B	B	B
BSG	DIN371	DIN376	DIN371	DIN371	DIN376	DIN376
Thread size	M3 - M10	M12 - M16	M3 - M10	M4 - M10	M12 - M16	M12 - M16
FHA	15°	15°	-	-	-	-
						
Coolant	No	No	No	Yes	No	Yes
Page(s)	439	440	414	415	416	417

For cutting data, see next page

Thread turning

MDT

Mini-Shaft™

Thread milling

Thread tapping

Annex

Cutting data MTH-N001 – N002 (-A)

SMG	v _c					
	MTH- N001	MTH- N002	MTP- N001	MTP- N001-A	MTP- N002	MTP- N002-A
P1	—	—	—	—	—	—
P2	—	—	—	—	—	—
P3	—	—	—	—	—	—
P4	—	—	—	—	—	—
P5	—	—	—	—	—	—
P6	—	—	—	—	—	—
P7	—	—	—	—	—	—
P8	—	—	—	—	—	—
P11	—	—	—	—	—	—
P12	—	—	—	—	—	—
M1	—	—	—	—	—	—
M2	—	—	—	—	—	—
M3	—	—	—	—	—	—
M4	—	—	—	—	—	—
M5	—	—	—	—	—	—
K1	—	—	—	—	—	—
K2	—	—	—	—	—	—
K3	—	—	—	—	—	—
K4	—	—	—	—	—	—
K5	—	—	—	—	—	—
K6	—	—	—	—	—	—
K7	—	—	—	—	—	—
N1	55 180	55 180	55 180	55 180	55 180	55 180
N2	35 115	35 115	35 115	35 115	35 115	35 115
N3	23 75	23 75	23 75	23 75	23 75	23 75
N11	31 100	31 100	31 100	31 100	31 100	31 100
H5	—	—	—	—	—	—
H8	—	—	—	—	—	—

SMG = Seco material group, v_c = m/min (sf/min)

Cutting speeds (v_c) in the table are recommendations for a start value and calculated when running in 2xD, except for V048, V050 and MTH-S (001, 002, 003, 004, 011, 012, 031, 032, 041, 042 and 044) that are calculated from 1,5xD.

When running in 1,5xD increase speed by 20% and at 2,5 x D reduce speed by 20%. At 3 x D reduce by 30%. Due to machine, material and setup condition it is advisable also to optimize cutting data.

Recommended ranges to use for each type of tap: K001-K002: +25% / -25%, V015-V016: +15% / -15%, V001-V045: +15% / -15%, V048-V050: +35% / -35%, V053-V063: +15% / -15%

Thread turning

MDT





Mini-Shaft™

Thread milling

Thread tapping

Annex

Taps Selection MTH-S001 – MTH-S032

Tool type	MTH-S001	MTH-S002	MTH-S003	MTH-S004	MTH-S011	MTH-S012	MTH-S031	MTH-S032
Thread type	M	M	M	M	MF	MJ	UNC	UNJC
TCTR	6HX	6HX	6HX	6HX	6HX	4H	2B	3B
ULDR	1.5	1.5	1.5	1.5	1.5	1.5	1.5	1.5
THCHT	C	C	C	C	C	C	C	C
BSG	DIN371	DIN371	DIN371	DIN371	DIN371	DIN371	DIN2184-1	DIN2184-1
Thread size	M3-M10	M12-M16	M3-M10	M12-M16	MF8X1-MF12X1,5	MJ3-MJ6	UNC2-56-UNC3/8-16	UNJC4-40-UNJC3/8-16
FHA	10°	10°	10°	10°	10°	10°	25°	10°
								
Coolant	No	No	No	No	No	No	No	No
Page(s)	441	442	443	444	445	446	447	448

For cutting data, see next page

Thread turning

MDT

Mini-Shaft™

Thread milling

Thread tapping

Annex

Cutting data MTH-S001 – S032

SMG	v _c							
	MTH-S001	MTH-S002	MTH-S003	MTH-S004	MTH-S011	MTH-S012	MTH-S031	MTH-S032
P1	—	—	—	—	—	—	—	—
P2	—	—	—	—	—	—	—	—
P3	—	—	—	—	—	—	—	—
P4	—	—	—	—	—	—	—	—
P5	—	—	—	—	—	—	—	—
P6	3 10	3 10	7 23	7 23	3 10	3 10	3 10	3 10
P7	3 10	3 10	7 23	7 23	3 10	3 10	3 10	3 10
P8	—	—	—	—	—	—	—	—
P11	3 10	3 10	6 20	6 20	3 10	3 10	3 10	3 10
P12	2 7	2 7	4 13	4 13	2 7	2 7	2 7	2 7
M1	—	—	—	—	—	—	—	—
M2	—	—	—	—	—	—	—	—
M3	—	—	—	—	—	—	—	—
M4	—	—	—	—	—	—	2 7	—
M5	—	—	—	—	—	—	2 7	—
K1	—	—	—	—	—	—	—	—
K2	—	—	—	—	—	—	—	—
K3	—	—	—	—	—	—	—	—
K4	—	—	—	—	—	—	—	—
K5	—	—	—	—	—	—	—	—
K6	—	—	—	—	—	—	—	—
K7	—	—	—	—	—	—	—	—
N1	—	—	—	—	—	—	—	—
N2	—	—	—	—	—	—	—	—
N3	16 50	16 50	25 80	25 80	16 50	16 50	—	16 50
N11	—	—	—	—	—	—	—	—
S1	2 7	2 7	4 13	4 13	2 7	2 7	2 7	2 7
S2	2 7	2 7	3 10	3 10	2 7	2 7	2 7	2 7
S3	2 7	2 7	3 10	3 10	2 7	2 7	2 7	2 7
S11	—	—	—	—	—	—	—	—
S12	—	—	—	—	—	—	—	—
S13	—	—	—	—	—	—	—	—
H5	—	—	—	—	—	—	—	—
H8	—	—	—	—	—	—	—	—

SMG = Seco material group, v_c = m/min (sf/min)

Cutting speeds (v_c) in the table are recommendations for a start value and calculated when running in 2xD, except for V048, V050 and MTH-S (001, 002, 003, 004, 011, 012, 031, 032, 041, 042 and 044) that are calculated from 1,5xD. When running in 1,5xD increase speed by 20% and at 2,5 x D reduce speed by 20%. At 3 x D reduce by 30%. Due to machine, material and setup condition it is advisable also to optimize cutting data.

Recommended ranges to use for each type of tap: K001-K002: +25% / -25%, V015-V016: +15% / -15%, V001-V045: +15% / -15%, V048-V050: +35% / -35%, V053-V063: +15% / -15%

Thread turning

MDT









Mini-Shaft™

Thread milling

Thread tapping

Annex

Taps Selection MTH-S041 – MTH-S142

Tool type	MTH-S041	MTH-S042	MTH-S043	MTH-S044	MTH-S101	MTH-S102	MTH-S111	MTH-S112	MTH-S142
Thread type	UNF	UNJF	EGUNF	EGUNF	M	M	MF	MJ	UNJF
TCTR	3B	3B	3B	3B	6HX	6HX	6HX	4H	3B
ULDR	1.5	1.5	2.0	1.5	2.0	2.0	2.0	2.0	2.0
THCHT	C	C	C	C	C	C	C	C	C
BSG	DIN2184-1	DIN2184-1	DIN2184-1	DIN2184-1	DIN371	DIN376	DIN376	DIN371	DIN2184-1
Thread size	UNF6-40-UNF3/8-24	UNJF6-40-UNJF3/8-24	EGUNF6-40-EGUNF3/8-24	EGUNF6-40-EGUNF3/8-24	M2-M10	M12-M20	MF6X0,75-MF14X1,5	MJ3-MJ10	UNJF10-32-UNJF3/8-24
FHA	25°	10°	15°	10°	15°	15°	15°	15°	15°
									
Coolant	No	No	No	No	No	No	No	No	No
Page(s)	449	450	451	452	453	454	455	456	457

For cutting data, see next page

Cutting data MTH-S041 – S142

SMG	v _c								
	MTH-S041	MTH-S042	MTH-S043	MTH-S044	MTH-S101	MTH-S102	MTH-S111	MTH-S112	MTH-S142
P1	—	—	—	—	—	—	—	—	—
P2	—	—	—	—	—	—	—	—	—
P3	—	—	—	—	—	—	—	—	—
P4	—	—	—	—	—	—	—	—	—
P5	—	—	—	—	—	—	—	—	—
P6	3 10	3 10	7 23	3 10	7 23	7 23	7 23	7 23	7 23
P7	3 10	3 10	7 23	3 10	7 23	7 23	7 23	7 23	7 23
P8	—	—	—	—	—	—	—	—	—
P11	3 10	3 10	6 20	3 10	6 20	6 20	6 20	6 20	6 20
P12	2 7	2 7	4 13	2 7	4 13	4 13	4 13	4 13	4 13
M1	—	—	—	—	—	—	—	—	—
M2	—	—	—	—	—	—	—	—	—
M3	—	—	—	—	—	—	—	—	—
M4	2 7	—	6 20	—	6 20	6 20	6 20	6 20	6 20
M5	2 7	—	5 16	—	5 16	5 16	5 16	5 16	5 16
K1	—	—	—	—	—	—	—	—	—
K2	—	—	—	—	—	—	—	—	—
K3	—	—	—	—	—	—	—	—	—
K4	—	—	—	—	—	—	—	—	—
K5	—	—	—	—	—	—	—	—	—
K6	—	—	—	—	—	—	—	—	—
K7	—	—	—	—	—	—	—	—	—
N1	—	—	—	—	—	—	—	—	—
N2	—	—	—	—	—	—	—	—	—
N3	—	16 50	25 80	16 50	25 80	25 80	25 80	25 80	25 80
N11	—	—	—	—	—	—	—	—	—
S1	2 7	2 7	—	2 7	—	—	—	—	—
S2	2 7	2 7	—	2 7	—	—	—	—	—
S3	2 7	2 7	—	2 7	—	—	—	—	—
S11	—	—	5 16	—	5 16	5 16	5 16	5 16	5 16
S12	—	—	4 13	—	4 13	4 13	4 13	4 13	4 13
S13	—	—	3 10	—	3 10	3 10	3 10	3 10	3 10
H5	—	—	—	—	—	—	—	—	—
H8	—	—	—	—	—	—	—	—	—

SMG = Seco material group, v_c = m/min (sf/min)

Cutting speeds (v_c) in the table are recommendations for a start value and calculated when running in 2xD, except for V048, V050 and MTH-S (001, 002, 003, 004, 011, 012, 031, 032, 041, 042 and 044) that are calculated from 1,5xD. When running in 1,5xD increase speed by 20% and at 2,5 x D reduce speed by 20%. At 3 x D reduce by 30%. Due to machine, material and setup condition it is advisable also to optimize cutting data.

Recommended ranges to use for each type of tap: K001-K002: +25% / -25%, V015-V016: +15% / -15%, V001-V045: +15% / -15%, V048-V050: +35% / -35%, V053-V063: +15% / -15%

Thread turning

MDT







Mini-Shaft™

Thread milling

Thread tapping

Annex

Taps Selection MTP-S001 – MTP-S043

Tool type	MTP-S001	MTP-S002	MTP-S011	MTP-S012	MTP-S013	MTP-S042	MTP-S043
Thread type	M	M	MF	MJ	EGM	UNFJ	EGUNF
TCTR	6HX	6HX	6HX	4H	4H	3B	3B
ULDR	2.0	2.0	2.0	2.0	2.0	2.0	2.0
THCHT	B	B	B	B	B	B	B
BSG	DIN371	DIN376	DIN371	DIN371	DIN40435	DIN2184-1	DIN2184-1
Thread size	M2-M10	M12-M20	MF6X0,75-MF14X1,5	MJ4-MJ8	EGM4-EGM8	UNFJ10-32-UNFJ3/8-24	EGUNF10-32-EGUNF3/8-24
FHA	-	-	-	-	-	-	-
							
Coolant	No	No	No	No	No	No	No
Page(s)	418	419	420	421	422	423	424

For cutting data, see next page

Cutting data MTP-S001 – S043

SMG	v _c						
	MTP-S001	MTP-S002	MTP-S011	MTP-S012	MTP-S013	MTP-S042	MTP-S043
P1	—	—	—	—	—	—	—
P2	—	—	—	—	—	—	—
P3	—	—	—	—	—	—	—
P4	—	—	—	—	—	—	—
P5	—	—	—	—	—	—	—
P6	—	—	—	—	—	—	—
P7	—	—	—	—	—	—	—
P8	—	—	—	—	—	—	—
P11	—	—	—	—	—	—	—
P12	—	—	—	—	—	—	—
M1	—	—	—	—	—	—	—
M2	—	—	—	—	—	—	—
M3	—	—	—	—	—	—	—
M4	6 20	6 20	6 20	6 20	2 7	6 20	2 7
M5	5 16	5 16	5 16	5 16	2 7	5 16	2 7
K1	—	—	—	—	—	—	—
K2	—	—	—	—	—	—	—
K3	—	—	—	—	—	—	—
K4	—	—	—	—	—	—	—
K5	—	—	—	—	—	—	—
K6	—	—	—	—	—	—	—
K7	—	—	—	—	—	—	—
N1	—	—	—	—	—	—	—
N2	—	—	—	—	—	—	—
N3	25 80	25 80	25 80	25 80	16 50	25 80	16 50
N11	—	—	—	—	—	—	—
S1	4 13 3	4 13 3	4 13 3	4 13 3	4 13 3	4 13 3	4 13 3
S2	10	10	10	10	10	10	10
S3	3 10	3 10	3 10	3 10	3 10	3 10	3 10
S11	5 16	5 16	5 16	5 16	4 13	5 16	4 13
S12	4 13	4 13	4 13	4 13	3 10	4 13	3 10
S13	3 10	3 10	3 10	3 10	2 7	3 10	2 7
H5	—	—	—	—	—	—	—
H8	—	—	—	—	—	—	—

SMG = Seco material group, v_c = m/min (sf/min)

Cutting speeds (v_c) in the table are recommendations for a start value and calculated when running in 2xD, except for V048, V050 and MTH-S (001, 002, 003, 004, 011, 012, 031, 032, 041, 042 and 044) that are calculated from 1,5xD. When running in 1,5xD increase speed by 20% and at 2,5 x D reduce speed by 20%. At 3 x D reduce by 30%. Due to machine, material and setup condition it is advisable also to optimize cutting data.

Recommended ranges to use for each type of tap: K001-K002: +25% / -25%, V015-V016: +15% / -15%, V001-V045: +15% / -15%, V048-V050: +35% / -35%, V053-V063: +15% / -15%

Thread turning

MDT

Mini-Shaft™

Thread milling

Thread tapping

Annex

Taps Selection MTS-K101 (-A) – MTS-K141

Tool type	MTS-K101	MTS-K101-A	MTS-K002	MTS-K002-A	MTS-K102	MTS-K102-A	MTS-K111	MTS-K121	MTS-K131	MTS-K141
Thread type	M	M	M	M	M	M	MF	G	UNC	UNF
TCTR	6HX	6HX	6HX	6HX	6HX	6HX	6HX	NORMAL-X	2BX	2BX
ULDR	2.5	2.5	2	2.5	2.5	2.5	2.5	2.5	2.5	2.5
THCHT	C	C/E	C	C/E	C	C/E	C	C	C	C
BSG	DIN371	DIN371	DIN376	DIN376	DIN376	DIN376	DIN374	DIN5156	DIN2184-1	DIN2184-1
Thread size	M3 - M10	M4 - M10	M27 - M42	M27 - M42	M8 - M24	M12 - M24	MF 10X1 - MF 20X1.5	G1/8-28 - G1-11	UNC 1/4-20 - UNC 7/8-9	UNF 1/4-28 - UNF 7/8-14
FHA	-	-	-	-	-	-	-	-	-	-
										
Coolant	No	Yes	No	Yes	No	Yes	No	No	No	No
Page(s)	462	463	464	465	466	467	468	469	470	471

For cutting data, see next page

Thread turning

MDT

Mini-Shaft™

Thread milling

Thread tapping

Annex

Cutting data MTS-K101 – MTS-K141

SMG	v _c							
	MTS- K101	MTS- K101-A	MTS- K102	MTS- K102-A	MTS- K111	MTS- K121	MTS- K131	MTS- K141
P1	—	—	—	—	—	—	—	—
P2	—	—	—	—	—	—	—	—
P3	—	—	—	—	—	—	—	—
P4	—	—	—	—	—	—	—	—
P5	—	—	—	—	—	—	—	—
P6	—	—	—	—	—	—	—	—
P7	—	—	—	—	—	—	—	—
P8	—	—	—	—	—	—	—	—
P11	—	—	—	—	—	—	—	—
P12	—	—	—	—	—	—	—	—
M1	—	—	—	—	—	—	—	—
M2	—	—	—	—	—	—	—	—
M3	—	—	—	—	—	—	—	—
M4	—	—	—	—	—	—	—	—
M5	—	—	—	—	—	—	—	—
K1	85 280	85 280	85 280	85 280	85 280	85 280	85 280	85 280
K2	75 245	75 245	75 245	75 245	75 245	75 245	75 245	75 245
K3	65 215	65 215	65 215	65 215	65 215	65 215	65 215	65 215
K4	60 195	60 195	60 195	60 195	60 195	60 195	60 195	60 195
K5	36 120	36 120	36 120	36 120	36 120	36 120	36 120	36 120
K6	55 180	55 180	55 180	55 180	55 180	55 180	55 180	55 180
K7	46 150	46 150	46 150	46 150	46 150	46 150	46 150	46 150
N1	—	—	—	—	—	—	—	—
N2	—	—	—	—	—	—	—	—
N3	—	—	—	—	—	—	—	—
N11	—	—	—	—	—	—	—	—
H5	—	—	—	—	—	—	—	—
H8	—	—	—	—	—	—	—	—

SMG = Seco material group, v_c = m/min (sf/min)

Cutting speeds (v_c) in the table are recommendations for a start value and calculated when running in 2xD, except for V048, V050 and MTH-S (001, 002, 003, 004, 011, 012, 031, 032, 041, 042 and 044) that are calculated from 1,5xD.

When running in 1,5xD increase speed by 20% and at 2,5 x D reduce speed by 20%. At 3 x D reduce by 30%. Due to machine, material and setup condition it is advisable also to optimize cutting data.

Recommended ranges to use for each type of tap: K001-K002: +25% / -25%, V015-V016: +15% / -15%, V001-V045: +15% / -15%, V048-V050: +35% / -35%, V053-V063: +15% / -15%

Thread turning

MDT



Mini-Shaft™

Thread milling

Thread tapping

Annex

Taps Selection MTH-V015 – MTH-V016

Tool type	MTH-V015	MTH-V016
Thread type	M	M
TCTR	6H	6H
ULDR	2	2
THCHT	C	C
BSG	DIN371	DIN376
Thread size	M3 - M10	M12 - M36
FHA	15°	15°
		
Coolant	No	No
Page(s)	458	459

For cutting data, see next page

Thread turning

MDT

Mini-Shaft™

Thread milling

Thread tapping

Annex

Cutting data MTH-V011 – MTH-V030 (-A)

SMG	v _c							
	MTH- V011	MTH- V015	MTH- V016	MTH- V025	MTH- V026	MTH- V029	MTH- V030	MTH- V030-A
P1	40	40	40	40	40	40	40	40
	130	130	130	130	130	130	130	130
P2	39	39	39	39	39	39	39	39
	130	130	130	130	130	130	130	130
P3	33	33	33	33	33	33	33	33
	110	110	110	110	110	110	110	110
P4	29	29	29	29	29	29	29	29
	95	95	95	95	95	95	95	95
P5	28	28	28	28	28	28	28	28
	90	90	90	90	90	90	90	90
P6	31	31	31	31	31	31	31	31
	100	100	100	100	100	100	100	100
P7	30	30	30	30	30	30	30	30
	100	100	100	100	100	100	100	100
P8	28	28	28	28	28	28	28	28
	90	90	90	90	90	90	90	90
P11	29	29	29	29	29	29	29	29
	95	95	95	95	95	95	95	95
P12	17	17	17	17	17	17	17	17
	55	55	55	55	55	55	55	55
M1	9	9	9	9	9	9	9	9
	30	30	30	30	30	30	30	30
M2	7	7	7	7	7	7	7	7
	23	23	23	23	23	23	23	23
M3	5	5	5	5	5	5	5	5
	16	16	16	16	16	16	16	16
M4	4	4	4	4	4	4	4	4
	13	13	13	13	13	13	13	13
M5	3	3	3	3	3	3	3	3
	10	10	10	10	10	10	10	10
K1	—	—	—	—	—	—	—	—
	—	—	—	—	—	—	—	—
K2	—	—	—	—	—	—	—	—
	—	—	—	—	—	—	—	—
K3	—	—	—	—	—	—	—	—
	—	—	—	—	—	—	—	—
K4	—	—	—	—	—	—	—	—
	—	—	—	—	—	—	—	—
K5	—	—	—	—	—	—	—	—
	—	—	—	—	—	—	—	—
K6	—	—	—	—	—	—	—	—
	—	—	—	—	—	—	—	—
K7	—	—	—	—	—	—	—	—
	—	—	—	—	—	—	—	—
N1	37	37	37	37	37	37	37	37
	120	120	120	120	120	120	120	120
N2	24	24	24	24	24	24	24	24
	80	80	80	80	80	80	80	80
N3	16	16	16	16	16	16	16	16
	50	50	50	50	50	50	50	50
N11	21	21	21	21	21	21	21	21
	70	70	70	70	70	70	70	70
H5	—	—	—	—	—	—	—	—
	—	—	—	—	—	—	—	—
H8	—	—	—	—	—	—	—	—
	—	—	—	—	—	—	—	—

SMG = Seco material group, v_c = m/min (sf/min)

Cutting speeds (v_c) in the table are recommendations for a start value and calculated when running in 2xD, except for V048, V050 and MTH-S (001, 002, 003, 004, 011, 012, 031, 032, 041, 042 and 044) that are calculated from 1,5xD.

When running in 1,5xD increase speed by 20% and at 2,5 x D reduce speed by 20%. At 3 x D reduce by 30%. Due to machine, material and setup condition it is advisable also to optimize cutting data.

Recommended ranges to use for each type of tap: K001-K002: +25% / -25%, V015-V016: +15% / -15%, V001-V045: +15% / -15%, V048-V050: +35% / -35%, V053-V063: +15% / -15%

Taps Selection MTH-V048 – MTH-V050

Tool type	MTH-V048	MTH-V050
Thread type	NPT	NPTF
TCTR	NORMAL	NORMAL
ULDR	1.5	1.5
THCHT	C	C
BSG	DIN/ANSI	DIN/ANSI
Thread size	NPT 1/16-27 NPT 1-11.5	NPTF 1/16-27 NPTF 3/4-14
FHA	15°	15°
		
Coolant	No	No
Page(s)	460	461

For cutting data, see next page

Thread turning

MDT

Mini-Shaft™

Thread milling

Thread tapping

Annex

Cutting data MTH-V048 – V050

SMG	v _c	
	MTH- V048	MTH- V050
P1	11	11
	36	36
P2	11	11
	36	36
P3	10	10
	33	33
P4	8	8
	26	26
P5	8	8
	26	26
P6	9	9
	30	30
P7	8	8
	26	26
P8	8	8
	26	26
P11	8	8
	26	26
P12	5	5
	16	16
M1	9	9
	30	30
M2	7	7
	23	23
M3	5	5
	16	16
M4	4	4
	13	13
M5	3	3
	10	10
K1	14	14
	46	46
K2	12	12
	39	39
K3	10	10
	33	33
K4	10	10
	33	33
K5	6	6
	20	20
K6	9	9
	30	30
K7	8	8
	26	26
N1	23	23
	75	75
N2	15	15
	49	49
N3	10	10
	33	33
N11	13	13
	43	43
H5	—	—
H8	—	—

SMG = Seco material group, v_c = m/min (sf/min)

Cutting speeds (v_c) in the table are recommendations for a start value and calculated when running in 2xD, except for V048, V050 and MTH-S (001, 002, 003, 004, 011, 012, 031, 032, 041, 042 and 044) that are calculated from 1,5xD.

When running in 1,5xD increase speed by 20% and at 2,5 x D reduce speed by 20%. At 3 x D reduce by 30%. Due to machine, material and setup condition it is advisable also to optimize cutting data.

Recommended ranges to use for each type of tap: K001-K002: +25% / -25%, V015-V016: +15% / -15%, V001-V045: +15% / -15%, V048-V050: +35% / -35%, V053-V063: +15% / -15%

Thread turning

MDT



Mini-Shaft™

Thread milling

Thread tapping

Annex

Taps Selection MF-V060-A – MF-V063-A

Tool type	MF-V060-A	MF-V063-A
Thread type	M	MF
TCTR	6HX	6HX
ULDR	3	3
THCHT	C	C
BSG	DIN2174	DIN2174
Thread size	M12 - M24	MF12x1.25 - MF16x1.5
FHA	-	-
		
Coolant	Yes	Yes
Page(s)	472	473

For cutting data, see next page

Thread turning

MDT

Mini-Shaft™

Thread milling

Thread tapping

Annex

Cutting data MF-V053 – MF-V063 (-A)

SMG	v _c							
	MF- V054	MF- V055	MF- V056	MF- V057	MF- V058	MF- V060	MF- V063	MF- V063-A
P1	55	55	55	55	55	55	55	55
	180	180	180	180	180	180	180	180
P2	55	55	55	55	55	55	55	55
	180	180	180	180	180	180	180	180
P3	48	48	48	48	48	48	48	48
	155	155	155	155	155	155	155	155
P4	42	42	42	42	42	42	42	42
	140	140	140	140	140	140	140	140
P5	40	40	40	40	40	40	40	40
	130	130	130	130	130	130	130	130
P6	45	45	45	45	45	45	45	45
	150	150	150	150	150	150	150	150
P7	42	42	42	42	42	42	42	42
	140	140	140	140	140	140	140	140
P8	40	40	40	40	40	40	40	40
	130	130	130	130	130	130	130	130
P11	41	41	41	41	41	41	41	41
	135	135	135	135	135	135	135	135
P12	24	24	24	24	24	24	24	24
	80	80	80	80	80	80	80	80
M1	17	17	17	17	17	17	17	17
	55	55	55	55	55	55	55	55
M2	14	14	14	14	14	14	14	14
	46	46	46	46	46	46	46	46
M3	11	11	11	11	11	11	11	11
	36	36	36	36	36	36	36	36
M4	8	8	8	8	8	8	8	8
	26	26	26	26	26	26	26	26
M5	7	7	7	7	7	7	7	7
	23	23	23	23	23	23	23	23
K1	—	—	—	—	—	—	—	—
	—	—	—	—	—	—	—	—
K2	—	—	—	—	—	—	—	—
	—	—	—	—	—	—	—	—
K3	—	—	—	—	—	—	—	—
	—	—	—	—	—	—	—	—
K4	—	—	—	—	—	—	—	—
	—	—	—	—	—	—	—	—
K5	—	—	—	—	—	—	—	—
	—	—	—	—	—	—	—	—
K6	—	—	—	—	—	—	—	—
	—	—	—	—	—	—	—	—
K7	—	—	—	—	—	—	—	—
	—	—	—	—	—	—	—	—
N1	55	55	55	55	55	55	55	55
	180	180	180	180	180	180	180	180
N2	35	35	35	35	35	35	35	35
	115	115	115	115	115	115	115	115
N3	23	23	23	23	23	23	23	23
	75	75	75	75	75	75	75	75
N11	31	31	31	31	31	31	31	31
	100	100	100	100	100	100	100	100
H5	—	—	—	—	—	—	—	—
	—	—	—	—	—	—	—	—
H8	—	—	—	—	—	—	—	—
	—	—	—	—	—	—	—	—

SMG = Seco material group, v_c = m/min (sf/min)

Cutting speeds (v_c) in the table are recommendations for a start value and calculated when running in 2xD, except for V048, V050 and MTH-S (001, 002, 003, 004, 011, 012, 031, 032, 041, 042 and 044) that are calculated from 1,5xD.

When running in 1,5xD increase speed by 20% and at 2,5 x D reduce speed by 20%. At 3 x D reduce by 30%. Due to machine, material and setup condition it is advisable also to optimize cutting data.

Recommended ranges to use for each type of tap: K001-K002: +25% / -25%, V015-V016: +15% / -15%, V001-V045: +15% / -15%, V048-V050: +35% / -35%, V053-V063: +15% / -15%

T32-SNC-micro

Blind and through holes – Metric coarse threads

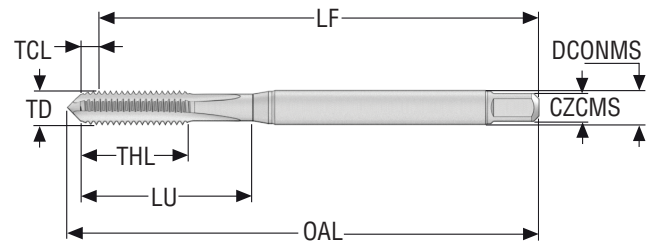

- Substrate: HSS-PM
- Coating: TiAlN + TiN
- Standard: DIN371
- Thread tolerance class: 4H
- For cutting data see page(s) 261

Designation	Item number	TDZ	Pitch	TCL	THL	LU	LF	OAL	DCONMS	CZCMS	PHDR Ø	NOF	THCHT
			mm	mm <i>Inch</i>	mm <i>Inch</i>	mm <i>Inch</i>	mm <i>Inch</i>	mm <i>Inch</i>	mm <i>Inch</i>		mm <i>Inch</i>		
T32-SN01C03-1X0.25-41R	10139661	M1	0,25	0,68 <i>0.027</i>	6,0 <i>0.236</i>	13 <i>0.512</i>	39,32 <i>1.548</i>	40,9 <i>1.610</i>	2,5 <i>0.098</i>	2.50X2.10	0,75 <i>0.030</i>	2	C
T32-SN01C03-1.1X0.25-41R	10139662	M1.1	0,25	0,68 <i>0.027</i>	6,0 <i>0.236</i>	13 <i>0.512</i>	39,32 <i>1.548</i>	41,0 <i>1.614</i>	2,5 <i>0.098</i>	2.50X2.10	0,85 <i>0.033</i>	2	C
T32-SN01C03-1.2X0.25-41R	10139663	M1.2	0,25	0,68 <i>0.027</i>	6,0 <i>0.236</i>	13 <i>0.512</i>	39,32 <i>1.548</i>	41,1 <i>1.618</i>	2,5 <i>0.098</i>	2.50X2.10	0,95 <i>0.037</i>	2	C
T32-SN01C03-1.4X0.3-41R	10139664	M1.4	0,3	0,79 <i>0.031</i>	7,0 <i>0.276</i>	13 <i>0.512</i>	39,21 <i>1.544</i>	41,3 <i>1.626</i>	2,5 <i>0.098</i>	2.50X2.10	1,1 <i>0.043</i>	2	C

T32-SNC-micro

Blind and through holes – Metric coarse threads

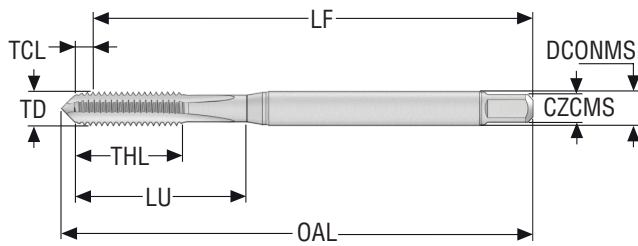

- Substrate: HSS-PM
- Coating: TiAlN + TiN
- Standard: DIN371
- Thread tolerance class: 6H
- For cutting data see page(s) 261

Designation	Item number	TDZ	Pitch	TCL	THL	LU	LF	OAL	DCONMS	CZCMS	PHDR Ø	NOF	THCHT
			mm	mm <i>Inch</i>	mm <i>Inch</i>	mm <i>Inch</i>	mm <i>Inch</i>	mm <i>Inch</i>	mm <i>Inch</i>	mm <i>Inch</i>	mm <i>Inch</i>		
T32-SN01C03-1.6X0.35-63R	10139665	M1.6	0,35	0,92 <i>0.036</i>	8,0 <i>0.315</i>	13 <i>0.512</i>	39,08 <i>1.539</i>	41,4 <i>1.630</i>	2,5 <i>0.098</i>	2.50X2.10	1,25 <i>0.049</i>	2	C
T32-SN01C03-1.7X0.35-63R	10139666	M1.7	0,35	0,92 <i>0.036</i>	8,0 <i>0.315</i>	13 <i>0.512</i>	39,08 <i>1.539</i>	41,5 <i>1.634</i>	2,5 <i>0.098</i>	2.50X2.10	1,35 <i>0.053</i>	2	C
T32-SN01C03-1.8X0.35-63R	10139667	M1.8	0,35	0,92 <i>0.036</i>	8,0 <i>0.315</i>	13 <i>0.512</i>	39,08 <i>1.539</i>	41,6 <i>1.638</i>	2,5 <i>0.098</i>	2.50X2.10	1,45 <i>0.057</i>	2	C
T32-SN01C03-2X0.4-63R	10139668	M2	0,4	1,13 <i>0.044</i>	10,0 <i>0.394</i>	13 <i>0.512</i>	43,87 <i>1.727</i>	46,3 <i>1.823</i>	2,8 <i>0.110</i>	2.80X2.10	1,6 <i>0.063</i>	2	C
T32-SN01C03-2.2X0.45-63R	10139669	M2.2	0,45	1,24 <i>0.049</i>	10,0 <i>0.394</i>	13 <i>0.512</i>	43,76 <i>1.723</i>	46,3 <i>1.823</i>	2,8 <i>0.110</i>	2.80X2.10	1,75 <i>0.069</i>	2	C
T32-SN01C03-2.3X0.4-63R	10139670	M2.3	0,4	1,13 <i>0.044</i>	10,0 <i>0.394</i>	13 <i>0.512</i>	43,87 <i>1.727</i>	46,3 <i>1.823</i>	2,8 <i>0.110</i>	2.80X2.10	1,9 <i>0.075</i>	2	C
T32-SN01C03-2.5X0.45-63R	10139672	M2.5	0,45	1,24 <i>0.049</i>	9,0 <i>0.354</i>	14 <i>0.551</i>	48,76 <i>1.920</i>	51,7 <i>2.035</i>	2,8 <i>0.110</i>	2.80X2.10	2,05 <i>0.081</i>	2	C
T32-SN01C03-2.6X0.45-63R	10139673	M2.6	0,45	1,24 <i>0.049</i>	9,0 <i>0.354</i>	14 <i>0.551</i>	48,76 <i>1.920</i>	51,7 <i>2.035</i>	2,8 <i>0.110</i>	2.80X2.10	2,15 <i>0.085</i>	2	C

T32-SNC

Blind and through holes – Metric coarse threads

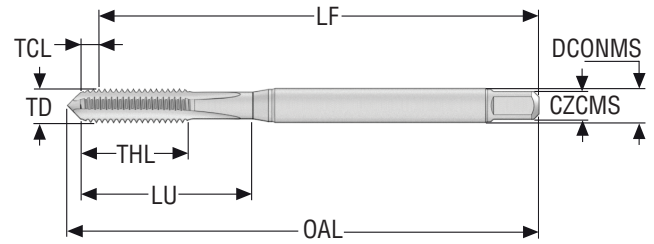

- Substrate: HSSE
- Coating: TiAlN + TiN
- Standard: DIN371
- Thread tolerance class: 6H
- For cutting data see page(s) 261

Designation	Item number	TDZ	Pitch	TCL	THL	LU	LF	OAL	DCONMS	CZCMS	PHDR Ø	NOF	THCHT
			mm	mm <i>Inch</i>	mm <i>Inch</i>	mm <i>Inch</i>	mm <i>Inch</i>	mm <i>Inch</i>	mm <i>Inch</i>	mm <i>Inch</i>	mm <i>Inch</i>		
T32-SN01C03-3X0.5-63R	10139674	M3	0,5	1,1 <i>0.043</i>	10,0 <i>0.394</i>	18 <i>0.709</i>	54,9 <i>2.161</i>	57,2 <i>2.252</i>	3,5 <i>0.138</i>	3.50X2.70	2,5 <i>0.098</i>	3	C
T32-SN01C03-3.5X0.6-63R	10139675	M3.5	0,6	1,28 <i>0.050</i>	12,0 <i>0.472</i>	20 <i>0.787</i>	54,72 <i>2.154</i>	57,4 <i>2.260</i>	4,0 <i>0.157</i>	4.00X3.00	2,9 <i>0.114</i>	3	C
T32-SN01C03-4X0.7-63R	10139676	M4	0,7	1,61 <i>0.063</i>	12,0 <i>0.472</i>	21 <i>0.827</i>	61,39 <i>2.417</i>	64,6 <i>2.543</i>	4,5 <i>0.177</i>	4.50X3.40	3,3 <i>0.130</i>	3	C
T32-SN01C03-4.5X0.75-63R	10139677	M4.5	0,75	1,61 <i>0.063</i>	14,0 <i>0.551</i>	25 <i>0.984</i>	68,39 <i>2.693</i>	71,8 <i>2.827</i>	6,0 <i>0.236</i>	6.00X4.90	3,8 <i>0.150</i>	3	C
T32-SN01C03-5X0.8-63R	10139678	M5	0,8	1,78 <i>0.070</i>	14,0 <i>0.551</i>	25 <i>0.984</i>	68,22 <i>2.686</i>	72,0 <i>2.835</i>	6,0 <i>0.236</i>	6.00X4.90	4,2 <i>0.165</i>	3	C
T32-SN01C03-6X1-63R	10139679	M6	1,0	2,14 <i>0.084</i>	18,0 <i>0.709</i>	30 <i>1.181</i>	77,86 <i>3.065</i>	82,4 <i>3.244</i>	6,0 <i>0.236</i>	6.00X4.90	5,0 <i>0.197</i>	3	C
T32-SN01C03-7X1-63R	10139680	M7	1,0	2,14 <i>0.084</i>	18,0 <i>0.709</i>	30 <i>1.181</i>	77,86 <i>3.065</i>	82,9 <i>3.264</i>	7,0 <i>0.276</i>	7.00X5.50	6,0 <i>0.236</i>	3	C
T32-SN01C03-8X1.25-63R	10139681	M8	1,25	2,94 <i>0.116</i>	20,0 <i>0.787</i>	35 <i>1.378</i>	87,06 <i>3.428</i>	93,3 <i>3.673</i>	8,0 <i>0.315</i>	8.00X6.20	6,8 <i>0.268</i>	3	C
T32-SN01C03-9X1.25-63R	10139682	M9	1,25	2,94 <i>0.116</i>	20,0 <i>0.787</i>	35 <i>1.378</i>	87,06 <i>3.428</i>	91,7 <i>3.610</i>	9,0 <i>0.354</i>	9.00X7.00	7,8 <i>0.307</i>	3	C
T32-SN01C03-10X1.5-63R	10139683	M10	1,5	3,55 <i>0.140</i>	20,0 <i>0.787</i>	39 <i>1.535</i>	96,45 <i>3.797</i>	101,8 <i>4.008</i>	10,0 <i>0.394</i>	10.00X8.00	8,5 <i>0.335</i>	3	C

Thread turning

MDT

Mini-Shaft™

Thread milling

Thread tapping

Annex

T32-SNC

Blind and through holes – Metric coarse threads

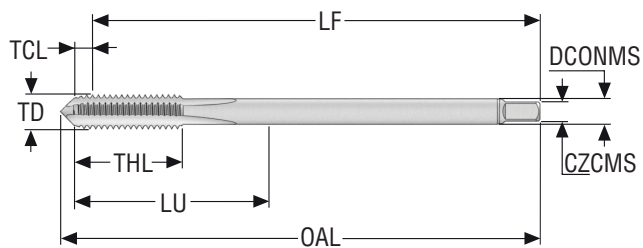

- Substrate: HSSE
- Coating: TiAlN + TiN
- Standard: DIN376
- Thread tolerance class: 6H
- For cutting data see page(s) 261

Designation	Item number	TDZ	Pitch	TCL	THL	LU	LF	OAL	DCONMS	CZCMS	PHDR Ø	NOF	THCHT
				mm	mm	mm	mm	mm	mm	mm			
T32-SN01C06-3X0.5-63R	10139694	M3	0,5	1,1 0.043	11,0 0.433	36 1.417	54,9 2.161	57,2 2.252	2,2 0.087	2.20X1.80	2,5 0.098	3	C
T32-SN01C06-4X0.7-63R	10139696	M4	0,7	1,61 0.063	12,0 0.472	43 1.693	61,39 2.417	64,6 2.543	2,8 0.110	2.80X2.10	3,3 0.130	3	C
T32-SN01C06-5X0.8-63R	10139697	M5	0,8	1,78 0.070	14,0 0.551	49 1.929	68,22 2.686	72,0 2.835	3,5 0.138	3.50X2.70	4,2 0.165	3	C
T32-SN01C06-6X1-63R	10139698	M6	1,0	2,14 0.084	18,0 0.709	59 2.323	77,86 3.065	82,4 3.244	4,5 0.177	4.50X3.40	5,0 0.197	3	C

Thread turning

MDT

Mini-Shaft™

Thread milling

Thread tapping

Annex

T32-SNC

Blind and through holes – Metric coarse threads

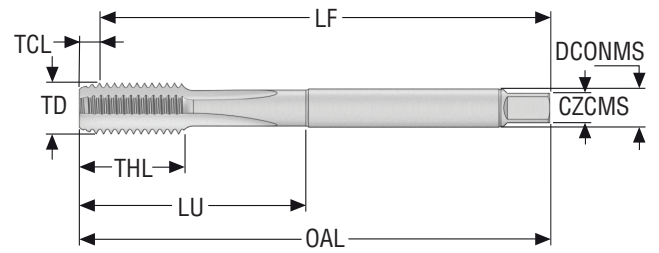

- Substrate: HSSE
- Coating: TiAlN + TiN
- Standard: DIN376
- Thread tolerance class: 6H
- For cutting data see page(s) 261

Designation	Item number	TDZ	Pitch	TCL	THL	LU	LF	OAL	DCONMS	CZCMS	PHDR Ø	NOF	THCHT
			mm	mm Inch	mm Inch	mm Inch	mm Inch	mm Inch	mm Inch		mm Inch		
T32-SN01C06-8X1.25-63R	10139700	M8	1,25	2,94 0.116	20,0 0.787	67 2.638	87,06 3.428	90,0 3.543	6,0 0.236	6.00X4.90	6,8 0.268	3	C
T32-SN01C06-10X1.5-63R	10139702	M10	1,5	3,55 0.140	20,0 0.787	77 3.031	96,45 3.797	100,0 3.937	7,0 0.276	7.00X5.50	8,5 0.335	3	C
T32-SN01C06-12X1.75-63R	10139703	M12	1,75	4,17 0.164	24,0 0.945	83 3.268	105,83 4.167	110,0 4.331	9,0 0.354	9.00X7.00	10,2 0.402	3	C
T32-SN01C06-14X2-63R	10139704	M14	2,0	4,78 0.188	25,0 0.984	81 3.189	105,22 4.143	110,0 4.331	11,0 0.433	11.00X9.00	12,0 0.472	4	C
T32-SN01C06-16X2-63R	10139705	M16	2,0	4,88 0.192	32,0 1.260	68 2.677	105,12 4.139	110,0 4.331	12,0 0.472	12.00X9.00	14,0 0.551	4	C
T32-SN01C06-18X2.5-63R	10139706	M18	2,5	5,97 0.235	32,0 1.260	81 3.189	119,03 4.686	125,0 4.921	14,0 0.551	14.00X11.00	15,5 0.610	4	C
T32-SN01C06-20X2.5-63R	10139707	M20	2,5	6,17 0.243	32,0 1.260	95 3.740	133,83 5.269	140,0 5.512	16,0 0.630	16.00X12.00	17,5 0.689	4	C
T32-SN01C06-22X2.5-63R	10139708	M22	2,5	6,17 0.243	32,0 1.260	93 3.661	133,83 5.269	140,0 5.512	18,0 0.709	18.00X14.50	19,5 0.768	4	C
T32-SN01C06-24X3-63R	10139709	M24	3,0	7,4 0.291	38,0 1.496	113 4.449	152,6 6.008	160,0 6.299	18,0 0.709	18.00X14.50	21,0 0.827	4	C
T32-SN01C06-27X3-63R	10139710	M27	3,0	7,4 0.291	38,0 1.496	97 3.819	152,6 6.008	160,0 6.299	20,0 0.787	20.00X16.00	24,0 0.945	4	C
T32-SN01C06-30X3.5-63R	10139711	M30	3,5	8,4 0.331	45,0 1.772	115 4.528	171,6 6.756	180,0 7.087	22,0 0.866	22.00X18.00	26,5 1.043	4	C
T32-SN01C06-33X3.5-63R	10139712	M33	3,5	8,4 0.331	45,0 1.772	113 4.449	171,6 6.756	180,0 7.087	25,0 0.984	25.00X20.00	29,5 1.161	4	C
T32-SN01C06-36X4-63R	10139713	M36	4,0	9,4 0.370	50,0 1.969	131 5.157	190,6 7.504	200,0 7.874	28,0 1.102	28.00X22.00	32,0 1.260	4	C
T32-SN01C06-39X4-63R	10139714	M39	4,0	9,4 0.370	50,0 1.969	102 4.016	190,6 7.504	200,0 7.874	32,0 1.260	32.00X24.00	35,0 1.378	4	C
T32-SN01C06-42X4.5-63R	10139715	M42	4,5	10,4 0.409	60,0 2.362	102 4.016	189,6 7.465	200,0 7.874	32,0 1.260	32.00X24.00	37,5 1.476	5	C
T32-SN01C06-45X4.5-63R	10139716	M45	4,5	10,42 0.410	60,0 2.362	117 4.606	209,58 8.251	220,0 8.661	36,0 1.417	36.00X29.00	40,5 1.594	5	C
T32-SN01C06-48X5-63R	10139717	M48	5,0	11,4 0.449	65,0 2.559	147 5.787	238,6 9.394	250,0 9.843	36,0 1.417	36.00X29.00	43,0 1.693	5	C
T32-SN01C06-52X5-63R	10139718	M52	5,0	11,4 0.449	65,0 2.559	120 4.724	238,6 9.394	250,0 9.843	40,0 1.575	40.00X32.00	47,0 1.850	5	C

T32-SNC

Blind and through holes – Metric coarse threads, left hand thread

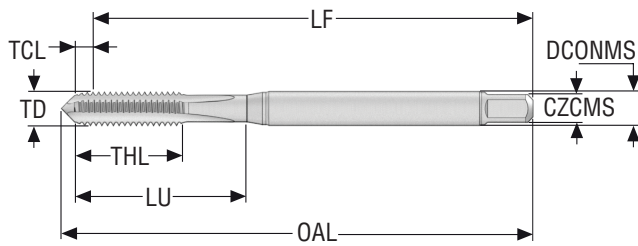

- Substrate: HSSE
- Coating: TiAlN + TiN
- Standard: DIN371
- Thread tolerance class: 6H
- For cutting data see page(s) 261

Designation	Item number	TDZ	Pitch	TCL	THL	LU	LF	OAL	DCONMS	CZCMS	PHDR Ø	NOF	THCHT
				mm	mm Inch	mm Inch	mm Inch	mm Inch	mm Inch	mm Inch			
T32-SN01C03-3X0.5-63L	10139686	M3	0,5	1,1 0.043	10,0 0.394	18 0.709	54,9 2.161	57,2 2.252	3,5 0.138	3.50X2.70	2,5 0.098	3	C
T32-SN01C03-4X0.7-63L	10139687	M4	0,7	1,61 0.063	12,0 0.472	21 0.827	61,39 2.417	64,6 2.543	4,5 0.177	4.50X3.40	3,3 0.130	3	C
T32-SN01C03-5X0.8-63L	10139688	M5	0,8	1,78 0.070	14,0 0.551	25 0.984	68,22 2.686	72,0 2.835	6,0 0.236	6.00X4.90	4,2 0.165	3	C
T32-SN01C03-6X1-63L	10139689	M6	1,0	2,14 0.084	18,0 0.709	30 1.181	77,86 3.065	82,4 3.244	6,0 0.236	6.00X4.90	5,0 0.197	3	C
T32-SN01C03-7X1-63L	10139690	M7	1,0	2,14 0.084	18,0 0.709	30 1.181	77,86 3.065	82,9 3.264	7,0 0.276	7.00X5.50	6,0 0.236	3	C
T32-SN01C03-8X1.25-63L	10139691	M8	1,25	2,94 0.116	20,0 0.787	35 1.378	87,06 3.428	93,3 3.673	8,0 0.315	8.00X6.20	6,8 0.268	3	C
T32-SN01C03-9X1.25-63L	10139692	M9	1,25	2,94 0.116	20,0 0.787	35 1.378	87,06 3.428	91,7 3.610	9,0 0.354	9.00X7.00	7,8 0.307	3	C
T32-SN01C03-10X1.5-63L	10139693	M10	1,5	3,55 0.140	20,0 0.787	39 1.535	96,45 3.797	101,8 4.008	10,0 0.394	10.00X8.00	8,5 0.335	3	C

Thread turning

MDT

Mini-Shaft™

Thread milling

Thread tapping

Annex

T32-SNC

Blind and through holes – Metric coarse threads, left hand thread

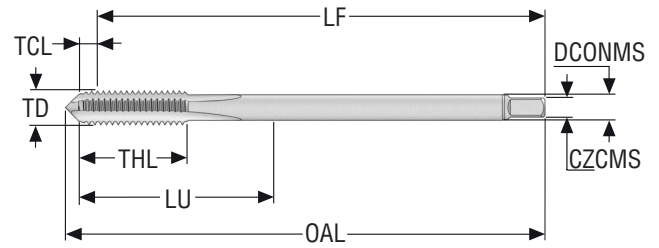

- Substrate: HSSE
- Coating: TiAlN + TiN
- Standard: DIN376
- Thread tolerance class: 6H
- For cutting data see page(s) 261

Designation	Item number	TDZ	Pitch	TCL	THL	LU	LF	OAL	DCONMS	CZCMS	PHDR Ø	NOF	THCHT
			mm	mm <i>Inch</i>	mm <i>Inch</i>	mm <i>Inch</i>	mm <i>Inch</i>	mm <i>Inch</i>	mm <i>Inch</i>		mm <i>Inch</i>		
T32-SN01C06-12X1.75-63L	10139751	M12	1,75	4,17 0.164	24,0 0.945	83 3.268	105,83 4.167	110,0 4.331	9,0 0.354	9.00X7.00	10,2 0.402	3	C
T32-SN01C06-16X2-63L	10139752	M16	2,0	4,88 0.192	32,0 1.260	68 2.677	105,12 4.139	110,0 4.331	12,0 0.472	12.00X9.00	14,0 0.551	4	C
T32-SN01C06-20X2.5-63L	10139753	M20	2,5	6,17 0.243	32,0 1.260	95 3.740	133,83 5.269	140,0 5.512	16,0 0.630	16.00X12.00	17,5 0.689	4	C
T32-SN01C06-24X3-63L	10139754	M24	3,0	7,4 0.291	38,0 1.496	113 4.449	152,6 6.008	160,0 6.299	18,0 0.709	18.00X14.50	21,0 0.827	4	C

Thread turning

MDT

Mini-Shaft™

Thread milling

Thread tapping

Annex

T32-SNC

Blind and through holes – MF threads

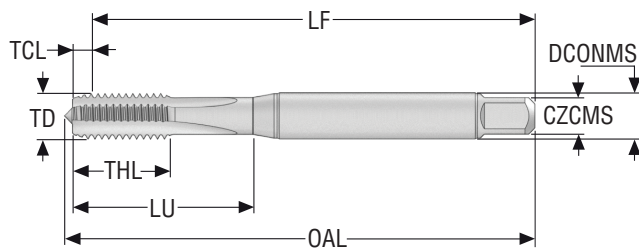

- Substrate: HSSE
- Coating: TiAlN + TiN
- Standard: DIN371
- Thread tolerance class: 6H
- For cutting data see page(s) 261

Designation	Item number	TDZ	Pitch	TCL	THL	LU	LF	OAL	DCONMS	CZCMS	PHDR Ø	NOF	THCHT
			mm	mm <i>Inch</i>	mm <i>Inch</i>	mm <i>Inch</i>	mm <i>Inch</i>	mm <i>Inch</i>	mm <i>Inch</i>	mm <i>Inch</i>	mm <i>Inch</i>		
T32-SN02C03-8X1-63R	10139684	MF8X1.0	1,0	2,44 <i>0.096</i>	20,0 <i>0.787</i>	35 <i>1.378</i>	87,56 <i>3.447</i>	93,3 <i>3.673</i>	8,0 <i>0.315</i>	8.00X6.20	7,0 <i>0.276</i>	3	C
T32-SN02C03-10X1-63R	10139685	MF10X1.0	1,0	2,54 <i>0.100</i>	20,0 <i>0.787</i>	35 <i>1.378</i>	87,46 <i>3.443</i>	91,8 <i>3.614</i>	10,0 <i>0.394</i>	10.00X8.00	9,0 <i>0.354</i>	3	C

Thread turning

MDT

Mini-Shaft™

Thread milling

Thread tapping

Annex

T32-SNC

Blind and through holes – MF threads

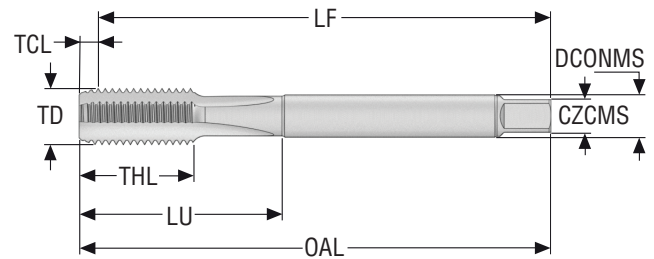

- Substrate: HSSE
- Coating: TiAlN + TiN
- Standard: DIN374
- Thread tolerance class: 6H
- For cutting data see page(s) 261

Designation	Item number	TDZ	Pitch	TCL	THL	LU	LF	OAL	DCONMS	CZCMS	PHDR Ø	NOF	THCHT
			mm	mm	mm	mm	mm	mm	mm	mm	mm		
			Inch	Inch	Inch	Inch	Inch	Inch	Inch	Inch	Inch		
T32-SN02C05-8X1-63R	10139719	MF8X1.0	1,0	2,44 0.096	20,0 0.787	67 2.638	87,56 3.447	90,0 3.543	6,0 0.236	6.00X4.90	7,0 0.276	3	C
T32-SN02C05-10X0.75-63R	10139720	MF10X0.75	0,75	3,43 0.135	18,0 0.709	67 2.638	86,57 3.408	90,0 3.543	7,0 0.276	7.00X5.50	9,2 0.362	3	C
T32-SN02C05-10X1-63R	10139721	MF10X1.0	1,0	2,54 0.100	20,0 0.787	67 2.638	87,46 3.443	90,0 3.543	7,0 0.276	7.00X5.50	9,0 0.354	3	C
T32-SN02C05-10X1.25-63R	10139722	MF10X1.25	1,25	3,04 0.120	20,0 0.787	77 3.031	96,96 3.817	100,0 3.937	7,0 0.276	7.00X5.50	8,8 0.346	3	C
T32-SN02C05-12X1-63R	10139723	MF12X1.0	1,0	2,65 0.104	20,0 0.787	73 2.874	97,35 3.833	100,0 3.937	9,0 0.354	9.00X7.00	11,0 0.433	3	C
T32-SN02C05-12X1.25-63R	10139724	MF12X1.25	1,25	3,16 0.124	20,0 0.787	73 2.874	96,84 3.813	100,0 3.937	9,0 0.354	9.00X7.00	10,8 0.425	3	C
T32-SN02C05-12X1.5-63R	10139725	MF12X1.5	1,5	3,66 0.144	20,0 0.787	73 2.874	96,34 3.793	100,0 3.937	9,0 0.354	9.00X7.00	10,5 0.413	3	C
T32-SN02C05-14X1-63R	10139726	MF14X1.0	1,0	2,75 0.108	20,0 0.787	71 2.795	97,25 3.829	100,0 3.937	11,0 0.433	11.00X9.00	13,0 0.512	4	C
T32-SN02C05-14X1.25-63R	10139727	MF14X1.25	1,25	3,26 0.128	20,0 0.787	71 2.795	96,74 3.809	100,0 3.937	11,0 0.433	11.00X9.00	12,8 0.504	4	C
T32-SN02C05-14X1.5-63R	10139728	MF14X1.5	1,5	3,76 0.148	20,0 0.787	71 2.795	96,24 3.789	100,0 3.937	11,0 0.433	11.00X9.00	12,5 0.492	4	C
T32-SN02C05-16X1-63R	10139729	MF16X1.0	1,0	2,85 0.112	20,0 0.787	58 2.283	97,15 3.825	100,0 3.937	12,0 0.472	12.00X9.00	15,0 0.591	4	C
T32-SN02C05-16X1.5-63R	10139730	MF16X1.5	1,5	3,86 0.152	20,0 0.787	58 2.283	96,14 3.785	100,0 3.937	12,0 0.472	12.00X9.00	14,5 0.571	4	C
T32-SN02C05-18X1.5-63R	10139731	MF18X1.5	1,5	3,96 0.156	24,0 0.945	66 2.598	106,04 4.175	110,0 4.331	14,0 0.551	14.00X11.00	16,5 0.650	4	C
T32-SN02C05-18X2-63R	10139732	MF18X2.0	2,0	4,98 0.196	27,0 1.063	81 3.189	120,02 4.725	125,0 4.921	14,0 0.551	14.00X11.00	16,0 0.630	4	C
T32-SN02C05-20X1.5-63R	10139733	MF20X1.5	1,5	4,16 0.164	24,0 0.945	80 3.150	120,84 4.757	125,0 4.921	16,0 0.630	16.00X12.00	18,5 0.728	4	C
T32-SN02C05-20X2-63R	10139734	MF20X2.0	2,0	5,18 0.204	27,0 1.063	95 3.740	134,82 5.308	140,0 5.512	16,0 0.630	16.00X12.00	18,0 0.709	4	C
T32-SN02C05-22X1.5-63R	10139735	MF22X1.5	1,5	4,16 0.164	24,0 0.945	78 3.071	120,84 4.757	125,0 4.921	18,0 0.709	18.00X14.50	20,5 0.807	4	C
T32-SN02C05-22X2-63R	10139736	MF22X2.0	2,0	5,18 0.204	27,0 1.063	93 3.661	134,82 5.308	140,0 5.512	18,0 0.709	18.00X14.50	20,0 0.787	4	C
T32-SN02C05-24X1.5-63R	10139737	MF24X1.5	1,5	3,88 0.153	27,0 1.063	93 3.661	136,12 5.359	140,0 5.512	18,0 0.709	18.00X14.50	22,5 0.886	4	C
T32-SN02C05-24X2-63R	10139738	MF24X2.0	2,0	4,89 0.193	27,0 1.063	93 3.661	135,11 5.319	140,0 5.512	18,0 0.709	18.00X14.50	22,0 0.866	4	C
T32-SN02C05-27X1.5-63R	10139739	MF27X1.5	1,5	4,38 0.172	27,0 1.063	77 3.031	135,62 5.339	140,0 5.512	20,0 0.787	20.00X16.00	25,5 1.004	4	C

Designation	Item number	TDZ	Pitch	TCL	THL	LU	LF	OAL	DCONMS	CZCMS	PHDR Ø	NOF	THCHT
			mm	mm <i>Inch</i>	mm <i>Inch</i>	mm <i>Inch</i>	mm <i>Inch</i>	mm <i>Inch</i>	mm <i>Inch</i>	mm <i>Inch</i>	mm <i>Inch</i>		
T32-SN02C05-27X2-63R	10139740	MF27X2.0	2.0	5,39 0.212	27,0 1.063	77 3.031	134,61 5.300	140,0 5.512	20,0 0.787	20.00X16.00	25,0 0.984	4	C
T32-SN02C05-30X1.5-63R	10139741	MF30X1.5	1,5	4,38 0.172	27,0 1.063	85 3.346	145,62 5.733	150,0 5.906	22,0 0.866	22.00X18.00	28,5 1.122	4	C
T32-SN02C05-30X2-63R	10139742	MF30X1.0	2,0	5,39 0.212	27,0 1.063	85 3.346	144,61 5.693	150,0 5.906	22,0 0.866	22.00X18.00	28,0 1.102	4	C

Thread turning

MDT

Mini-Shaft™

Thread milling

Thread tapping

Annex

T32-SNC

Blind and through holes – G threads

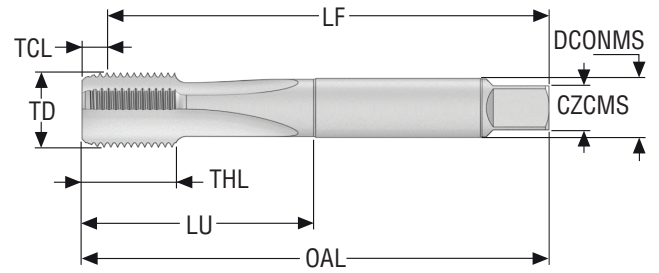

- Substrate: HSSE
- Coating: TiAlN + TiN
- Standard: DIN5156
- Thread tolerance class: NORMAL
- For cutting data see page(s) 261

Designation	Item number	TDZ	TD	Pitch	TCL	THL	LU	LF	OAL	DCONMS	CZCMS	PHDR Ø	NOF	THCHT
			mm Inch	TPI	mm Inch	mm Inch	mm Inch	mm Inch	mm Inch	mm Inch		mm Inch		
T32-SN21C09-1/8-28-11R	10139743	G1/8-28	9,728 0.383	28.0	2,43 0.096	18,0 0.709	67 2.638	87,57 3.448	90,0 3.543	7,0 0.276	7.00X5.50	8,8 0.346	3	C
T32-SN21C09-1/4-19-11R	10139744	G1/4-19	13,157 0.518	19.0	3,52 0.139	22,0 0.866	71 2.795	96,48 3.798	100,0 3.937	11,0 0.433	11.00X9.00	11,8 0.465	4	C
T32-SN21C09-3/8-19-11R	10139745	G3/8-19	16,662 0.656	19.0	3,72 0.146	22,0 0.866	58 2.283	96,28 3.791	100,0 3.937	12,0 0.472	12.00X9.00	15,25 0.600	4	C
T32-SN21C09-1/2-14-11R	10139746	G1/2-14	20,955 0.825	14.0	5,02 0.198	25,0 0.984	80 3.150	119,98 4.724	125,0 4.921	16,0 0.630	16.00X12.00	19,0 0.748	4	C
T32-SN21C09-5/8-14-11R	10139747	G5/8-14	22,911 0.902	14.0	4,94 0.194	25,0 0.984	78 3.071	120,06 4.727	125,0 4.921	18,0 0.709	18.00X14.50	21,0 0.827	4	C
T32-SN21C09-3/4-14-11R	10139748	G3/4-14	26,441 1.041	14.0	5,19 0.204	28,0 1.102	77 3.031	134,81 5.307	140,0 5.512	20,0 0.787	20.00X16.00	24,5 0.965	4	C
T32-SN21C09-7/8-14-11R	10139749	G7/8-14	30,201 1.189	14.0	5,13 0.202	30,0 1.181	85 3.346	144,87 5.704	150,0 5.906	22,0 0.866	22.00X18.00	28,25 1.112	4	C
T32-SN21C09-1-11-11R	10139750	G1-11	33,249 1.309	11.0	6,03 0.237	32,0 1.260	93 3.661	153,97 6.062	160,0 6.299	25,0 0.984	25.00X20.00	30,75 1.211	4	C

Thread turning

MDT

Mini-Shaft™

Thread milling

Thread tapping

Annex

T32-PNB-micro

Through holes – Metric coarse threads

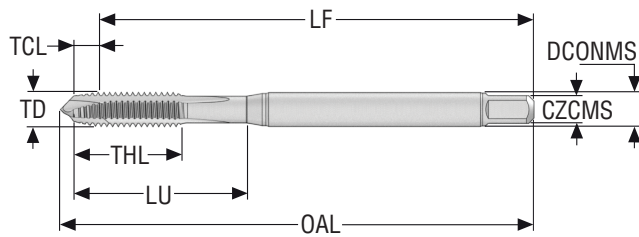

- Substrate: HSSE
- Coating: TiAlN + TiN
- Standard: DIN371
- Thread tolerance class: 4H
- For cutting data see page(s) 261

Designation	Item number	TDZ	Pitch	TCL	THL	LU	LF	OAL	DCONMS	CZCMS	PHDR Ø	NOF	THCHT
			mm	mm <i>Inch</i>	mm <i>Inch</i>	mm <i>Inch</i>	mm <i>Inch</i>	mm <i>Inch</i>	mm <i>Inch</i>	mm <i>Inch</i>	mm <i>Inch</i>		
T32-PN01B03-1X0.25-41R	10139427	M1	0,25	1,13 <i>0.044</i>	6,0 <i>0.236</i>	13 <i>0.512</i>	38,87 <i>1.530</i>	40,9 <i>1.610</i>	2,5 <i>0.098</i>	2.50X2.10	0,75 <i>0.030</i>	2	B
T32-PN01B03-1.1X0.25-41R	10139428	M1.1	0,25	1,13 <i>0.044</i>	6,0 <i>0.236</i>	13 <i>0.512</i>	38,87 <i>1.530</i>	41,0 <i>1.614</i>	2,5 <i>0.098</i>	2.50X2.10	0,85 <i>0.033</i>	2	B
T32-PN01B03-1.2X0.25-41R	10139429	M1.2	0,25	1,13 <i>0.044</i>	6,0 <i>0.236</i>	13 <i>0.512</i>	38,87 <i>1.530</i>	41,1 <i>1.618</i>	2,5 <i>0.098</i>	2.50X2.10	0,95 <i>0.037</i>	2	B
T32-PN01B03-1.4X0.3-41R	10139430	M1.4	0,3	1,32 <i>0.052</i>	7,0 <i>0.276</i>	13 <i>0.512</i>	38,68 <i>1.523</i>	41,3 <i>1.626</i>	2,5 <i>0.098</i>	2.50X2.10	1,1 <i>0.043</i>	2	B

Thread turning

MDT

Mini-Shaft™

Thread milling

Thread tapping

Annex

T32-PNB-micro

Through holes – Metric coarse threads

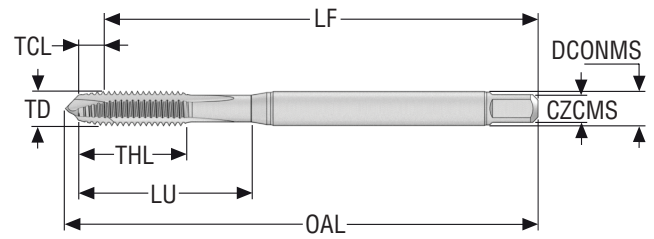

- Substrate: HSSE
- Coating: TiAlN + TiN
- Standard: DIN371
- Thread tolerance class: 6H
- For cutting data see page(s) 261

Designation	Item number	TDZ	Pitch	TCL	THL	LU	LF	OAL	DCONMS	CZCMS	PHDR Ø	NOF	THCHT
			mm	mm <i>Inch</i>	mm <i>Inch</i>	mm <i>Inch</i>	mm <i>Inch</i>	mm <i>Inch</i>	mm <i>Inch</i>		mm <i>Inch</i>		
T32-PN01B03-1.6X0.35-63R	10139431	M1.6	0,35	1,54 0.061	8,0 0.315	13 0.512	38,46 1.514	41,4 1.630	2,5 0.098	2.50X2.10	1,25 0.049	2	B
T32-PN01B03-1.7X0.35-63R	10139432	M1.7	0,35	1,54 0.061	8,0 0.315	13 0.512	38,46 1.514	41,5 1.634	2,5 0.098	2.50X2.10	1,35 0.053	2	B
T32-PN01B03-1.8X0.35-63R	10139433	M1.8	0,35	1,54 0.061	8,0 0.315	13 0.512	38,46 1.514	41,6 1.638	2,5 0.098	2.50X2.10	1,45 0.057	2	B
T32-PN01B03-2X0.4-63R	10139434	M2	0,4	1,89 0.074	10,0 0.394	13 0.512	43,11 1.697	46,3 1.823	2,8 0.110	2.80X2.10	1,6 0.063	2	B
T32-PN01B03-2.2X0.45-63R	10139435	M2.2	0,45	2,07 0.081	10,0 0.394	13 0.512	42,93 1.690	46,3 1.823	2,8 0.110	2.80X2.10	1,75 0.069	2	B
T32-PN01B03-2.3X0.4-63R	10139436	M2.3	0,4	1,89 0.074	10,0 0.394	13 0.512	43,11 1.697	46,3 1.823	2,8 0.110	2.80X2.10	1,9 0.075	2	B
T32-PN01B03-2.5X0.45-63R	10139437	M2.5	0,45	2,07 0.081	9,0 0.354	14 0.551	47,93 1.887	51,7 2.035	2,8 0.110	2.80X2.10	2,05 0.081	2	B
T32-PN01B03-2.6X0.45-63R	10139438	M2.6	0,45	2,07 0.081	9,0 0.354	14 0.551	47,93 1.887	51,7 2.035	2,8 0.110	2.80X2.10	2,15 0.085	2	B

Thread turning

MDT

Mini-Shaft™

Thread milling

Thread tapping

Annex

T32-PNB

Through holes – Metric coarse threads

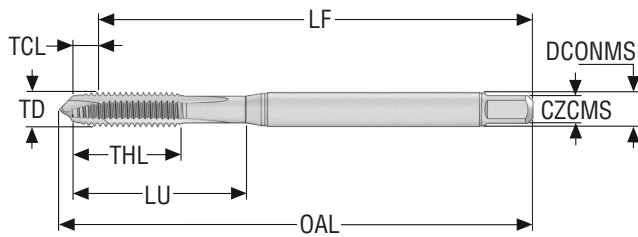

- Substrate: HSSE
- Coating: TiAlN + TiN
- Standard: DIN371
- Thread tolerance class: 6H
- For cutting data see page(s) 261

Designation	Item number	TDZ	Pitch	TCL	THL	LU	LF	OAL	DCONMS	CZCMS	PHDR Ø	NOF	THCHT
				mm	mm Inch	mm Inch	mm Inch	mm Inch	mm Inch	mm Inch	mm Inch	mm Inch	mm Inch
T32-PN01B03-3X0.5-63R	10139439	M3	0,5	2,28 0.090	10,0 0.394	18 0.709	53,72 2.115	57,2 2.252	3,5 0.138	3.50X2.70	2,5 0.098	3	B
T32-PN01B03-3.5X0.6-63R	10139440	M3.5	0,6	2,65 0.104	12,0 0.472	20 0.787	53,35 2.100	57,4 2.260	4,0 0.157	4.00X3.00	2,9 0.114	3	B
T32-PN01B03-4X0.7-63R	10139441	M4	0,7	3,33 0.131	12,0 0.472	21 0.827	59,67 2.349	64,6 2.543	4,5 0.177	4.50X3.40	3,3 0.130	3	B
T32-PN01B03-4.5X0.75-63R	10139442	M4.5	0,75	3,33 0.131	14,0 0.551	25 0.984	66,67 2.625	71,8 2.827	6,0 0.236	6.00X4.90	3,8 0.150	3	B
T32-PN01B03-5X0.8-63R	10139443	M5	0,8	3,68 0.145	14,0 0.551	25 0.984	66,32 2.611	72,0 2.835	6,0 0.236	6.00X4.90	4,2 0.165	3	B
T32-PN01B03-6X1-63R	10139444	M6	1,0	4,41 0.174	18,0 0.709	30 1.181	75,59 2.976	82,4 3.244	6,0 0.236	6.00X4.90	5,0 0.197	3	B
T32-PN01B03-7X1-63R	10139445	M7	1,0	4,41 0.174	18,0 0.709	30 1.181	75,59 2.976	82,9 3.264	7,0 0.276	7.00X5.50	6,0 0.236	3	B
T32-PN01B03-8X1.25-63R	10139446	M8	1,25	5,43 0.214	20,0 0.787	35 1.378	84,57 3.330	93,3 3.673	8,0 0.315	8.00X6.20	6,8 0.268	3	B
T32-PN01B03-9X1.25-63R	10139447	M9	1,25	5,7 0.224	20,0 0.787	35 1.378	84,3 3.319	91,7 3.610	9,0 0.354	9.00X7.00	7,8 0.307	3	B
T32-PN01B03-10X1.5-63R	10139448	M10	1,5	6,84 0.269	20,0 0.787	39 1.535	93,16 3.668	101,8 4.008	10,0 0.394	10.00X8.00	8,5 0.335	3	B

T32-PNB

Through holes – Metric coarse threads

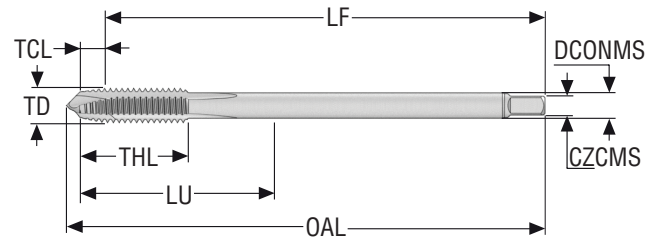

- Substrate: HSSE
- Coating: TiAlN + TiN
- Standard: DIN376
- Thread tolerance class: 6H
- For cutting data see page(s) 261

Designation	Item number	TDZ	Pitch	TCL	THL	LU	LF	OAL	DCONMS	CZCMS	PHDR Ø	NOF	THCHT
			mm	mm <i>Inch</i>	mm <i>Inch</i>	mm <i>Inch</i>	mm <i>Inch</i>	mm <i>Inch</i>	mm <i>Inch</i>	mm <i>Inch</i>			
T32-PN01B06-3X0.5-63R	10139482	M3	0,5	2,2 <i>0.087</i>	11,0 <i>0.433</i>	36 <i>1.417</i>	53,8 <i>2.118</i>	57,2 <i>2.252</i>	2,2 <i>0.087</i>	2.20X1.80	2,5 <i>0.098</i>	3	B
T32-PN01B06-4X0.7-63R	10139484	M4	0,7	3,3 <i>0.130</i>	12,0 <i>0.472</i>	43 <i>1.693</i>	59,7 <i>2.350</i>	64,6 <i>2.543</i>	2,8 <i>0.110</i>	2.80X2.10	3,3 <i>0.130</i>	3	B
T32-PN01B06-5X0.8-63R	10139485	M5	0,8	3,6 <i>0.142</i>	14,0 <i>0.551</i>	49 <i>1.929</i>	66,4 <i>2.614</i>	72,0 <i>2.835</i>	3,5 <i>0.138</i>	3.50X2.70	4,2 <i>0.165</i>	3	B
T32-PN01B06-6X1-63R	10139486	M6	1,0	4,4 <i>0.173</i>	18,0 <i>0.709</i>	59 <i>2.323</i>	75,6 <i>2.976</i>	82,4 <i>3.244</i>	4,5 <i>0.177</i>	4.50X3.40	5,0 <i>0.197</i>	3	B

Thread turning

MDT

Mini-Shaft™

Thread milling

Thread tapping

Annex

T32-PNB

Through holes – Metric coarse threads

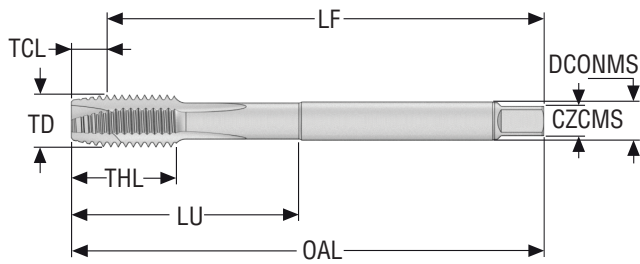

- Substrate: HSSE
- Coating: TiAlN + TiN
- Standard: DIN376
- Thread tolerance class: 6H
- For cutting data see page(s) 261

Designation	Item number	TDZ	Pitch	TCL	THL	LU	LF	OAL	DCONMS	CZCMS	PHDR Ø	NOF	THCHT
				mm	mm Inch	mm Inch	mm Inch	mm Inch	mm Inch	mm Inch			
T32-PN01B06-8X1.25-63R	10139488	M8	1,25	5,7 0.224	20,0 0.787	67 2.638	84,3 3.319	90,0 3.543	6,0 0.236	6.00X4.90	6,8 0.268	3	B
T32-PN01B06-9X1.25-63R	10139489	M9	1,25	5,7 0.224	20,0 0.787	67 2.638	84,3 3.319	90,0 3.543	7,0 0.276	7.00X5.50	7,8 0.307	3	B
T32-PN01B06-10X1.5-63R	10139490	M10	1,5	6,84 0.269	20,0 0.787	77 3.031	93,16 3.668	100,0 3.937	7,0 0.276	7.00X5.50	8,5 0.335	3	B
T32-PN01B06-12X1.75-63R	10139491	M12	1,75	8,01 0.315	24,0 0.945	83 3.268	101,99 4.015	110,0 4.331	9,0 0.354	9.00X7.00	10,2 0.402	3	B
T32-PN01B06-14X2-63R	10139492	M14	2,0	9,14 0.360	25,0 0.984	81 3.189	100,86 3.971	110,0 4.331	11,0 0.433	11.00X9.00	12,0 0.472	3	B
T32-PN01B06-16X2-63R	10139493	M16	2,0	9,24 0.364	32,0 1.260	68 2.677	100,76 3.967	110,0 4.331	12,0 0.472	12.00X9.00	14,0 0.551	3	B
T32-PN01B06-18X2.5-63R	10139494	M18	2,5	11,38 0.448	32,0 1.260	81 3.189	113,62 4.473	125,0 4.921	14,0 0.551	14.00X11.00	15,5 0.610	4	B
T32-PN01B06-20X2.5-63R	10139495	M20	2,5	11,58 0.456	32,0 1.260	95 3.740	128,42 5.056	140,0 5.512	16,0 0.630	16.00X12.00	17,5 0.689	4	B
T32-PN01B06-22X2.5-63R	10139496	M22	2,5	11,78 0.464	32,0 1.260	93 3.661	128,22 5.048	140,0 5.512	18,0 0.709	18.00X14.50	19,5 0.768	4	B
T32-PN01B06-24X3-63R	10139497	M24	3,0	13,68 0.539	38,0 1.496	113 4.449	146,32 5.761	160,0 6.299	18,0 0.709	18.00X14.50	21,0 0.827	4	B
T32-PN01B06-27X3-63R	10139498	M27	3,0	13,88 0.546	38,0 1.496	97 3.819	146,12 5.753	160,0 6.299	20,0 0.787	20.00X16.00	24,0 0.945	4	B
T32-PN01B06-30X3.5-63R	10139499	M30	3,5	15,93 0.627	45,0 1.772	115 4.528	164,07 6.459	180,0 7.087	22,0 0.866	22.00X18.00	26,5 1.043	4	B
T32-PN01B06-33X3.5-63R	10139500	M33	3,5	15,93 0.627	45,0 1.772	113 4.449	164,07 6.459	180,0 7.087	25,0 0.984	25.00X20.00	29,5 1.161	4	B
T32-PN01B06-36X4-63R	10139501	M36	4,0	17,97 0.707	50,0 1.969	131 5.157	182,03 7.167	200,0 7.874	28,0 1.102	28.00X22.00	32,0 1.260	4	B
T32-PN01B06-39X4-63R	10139502	M39	4,0	17,97 0.707	50,0 1.969	102 4.016	182,03 7.167	200,0 7.874	32,0 1.260	32.00X24.00	35,0 1.378	4	B
T32-PN01B06-42X4.5-63R	10139503	M42	4,5	20,02 0.788	60,0 2.362	102 4.016	179,98 7.086	200,0 7.874	32,0 1.260	32.00X24.00	37,5 1.476	5	B
T32-PN01B06-45X4.5-63R	10139504	M45	4,5	20,02 0.788	60,0 2.362	117 4.606	199,98 7.873	220,0 8.661	36,0 1.417	36.00X29.00	40,5 1.594	5	B
T32-PN01B06-48X5-63R	10139505	M48	5,0	22,07 0.869	65,0 2.559	147 5.787	227,93 8.974	250,0 9.843	36,0 1.417	36.00X29.00	43,0 1.693	5	B
T32-PN01B06-52X5-63R	10139506	M52	5,0	22,07 0.869	65,0 2.559	120 4.724	227,93 8.974	250,0 9.843	40,0 1.575	40.00X32.00	47,0 1.850	5	B

T32-PNB

Through holes – Metric coarse threads

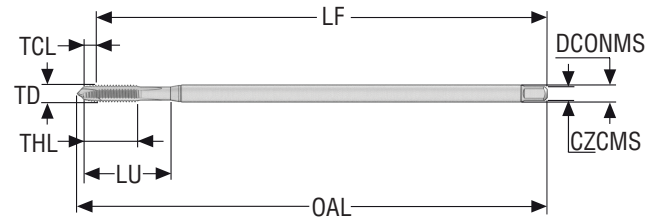

- Substrate: HSSE
- Coating: TiAlN + TiN
- Standard: DIN371/EL
- Thread tolerance class: 6H
- For cutting data see page(s) 261

Designation	Item number	TDZ	Pitch	TCL	THL	LU	LF	OAL	DCONMS	CZCMS	PHDR Ø	NOF	THCHT
			mm	mm <i>Inch</i>	mm <i>Inch</i>	mm <i>Inch</i>	mm <i>Inch</i>	mm <i>Inch</i>	mm <i>Inch</i>	mm <i>Inch</i>	mm <i>Inch</i>		
T32-PN01B04-3X0.5-63R	10139652	M3	0,5	2,28 <i>0.090</i>	10,0 <i>0.394</i>	18 <i>0.709</i>	97,72 <i>3.847</i>	101,2 <i>3.984</i>	3,5 <i>0.138</i>	3.50X2.70	2,5 <i>0.098</i>	3	B
T32-PN01B04-4X0.7-63R	10139653	M4	0,7	3,33 <i>0.131</i>	12,0 <i>0.472</i>	21 <i>0.827</i>	121,67 <i>4.790</i>	126,6 <i>4.984</i>	4,5 <i>0.177</i>	4.50X3.40	3,3 <i>0.130</i>	3	B
T32-PN01B04-5X0.8-63R	10139654	M5	0,8	3,68 <i>0.145</i>	14,0 <i>0.551</i>	25 <i>0.984</i>	136,32 <i>5.367</i>	142,0 <i>5.591</i>	6,0 <i>0.236</i>	6.00X4.90	4,2 <i>0.165</i>	3	B
T32-PN01B04-6X1-63R	10139655	M6	1,0	4,41 <i>0.174</i>	18,0 <i>0.709</i>	30 <i>1.181</i>	155,59 <i>6.126</i>	162,4 <i>6.394</i>	6,0 <i>0.236</i>	6.00X4.90	5,0 <i>0.197</i>	3	B

Thread turning

MDT

Mini-Shaft™

Thread milling

Thread tapping

Annex

T32-PNB

Through holes – Metric coarse threads

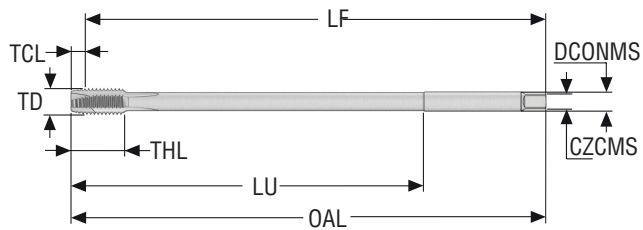

- Substrate: HSSE
- Coating: TiAlN + TiN
- Standard: DIN376/EL
- Thread tolerance class: 6H
- For cutting data see page(s) 261

Designation	Item number	TDZ	Pitch	TCL	THL	LU	LF	OAL	DCONMS	CZCMS	PHDR Ø	NOF	THCHT
			mm	mm <i>Inch</i>	mm <i>Inch</i>	mm <i>Inch</i>	mm <i>Inch</i>	mm <i>Inch</i>	mm <i>Inch</i>	mm <i>Inch</i>	mm <i>Inch</i>		
T32-PN01B07-8X1.25-63R	10139656	M8	1,25	5,7 0.224	20,0 0.787	157 6.181	174,3 6.862	180,0 7.087	6,0 0.236	6.00X4.90	6,8 0.268	3	B
T32-PN01B07-10X1.5-63R	10139657	M10	1,5	6,84 0.269	20,0 0.787	177 6.969	193,16 7.605	200,0 7.874	7,0 0.276	7.00X5.50	8,5 0.335	3	B
T32-PN01B07-12X1.75-63R	10139658	M12	1,75	8,01 0.315	24,0 0.945	83 3.268	211,99 8.346	220,0 8.661	9,0 0.354	9.00X7.00	10,2 0.402	3	B
T32-PN01B07-16X2-63R	10139659	M16	2,0	9,24 0.364	32,0 1.260	191 7.520	210,76 8.298	220,0 8.661	11,0 0.433	11.00X9.00	14,0 0.551	3	B

Thread turning

MDT

Mini-Shaft™

Thread milling

Thread tapping

Annex

T32-PNB

Through holes – Metric coarse threads, 6G

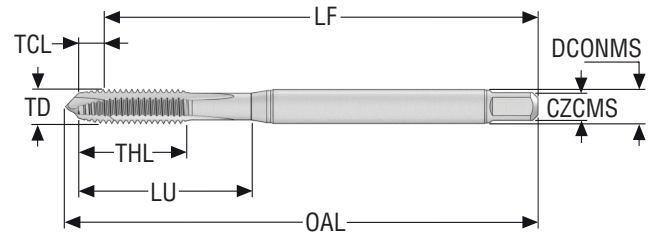

- Substrate: HSSE
- Coating: TiAlN + TiN
- Standard: DIN371
- Thread tolerance class: 6G
- For cutting data see page(s) 261

Designation	Item number	TDZ	Pitch	TCL	THL	LU	LF	OAL	DCONMS	CZCMS	PHDR Ø	NOF	THCHT
			mm	mm <i>Inch</i>	mm <i>Inch</i>	mm <i>Inch</i>	mm <i>Inch</i>	mm <i>Inch</i>	mm <i>Inch</i>	mm <i>Inch</i>	mm <i>Inch</i>		
T32-PN01B03-3X0.5-61R	10139474	M3	0,5	2,28 0.090	10,0 0.394	18 0.709	53,72 2.115	57,2 2.252	3,5 0.138	3.50X2.70	2,5 0.098	3	B
T32-PN01B03-4X0.7-61R	10139475	M4	0,7	3,33 0.131	12,0 0.472	21 0.827	59,67 2.349	64,6 2.543	4,5 0.177	4.50X3.40	3,3 0.130	3	B
T32-PN01B03-5X0.8-61R	10139476	M5	0,8	3,68 0.145	14,0 0.551	25 0.984	66,32 2.611	72,0 2.835	6,0 0.236	6.00X4.90	4,2 0.165	3	B
T32-PN01B03-6X1-61R	10139477	M6	1,0	4,41 0.174	18,0 0.709	30 1.181	75,59 2.976	82,4 3.244	6,0 0.236	6.00X4.90	5,0 0.197	3	B
T32-PN01B03-7X1-61R	10139478	M7	1,0	4,41 0.174	18,0 0.709	30 1.181	75,59 2.976	82,9 3.264	7,0 0.276	7.00X5.50	6,0 0.236	3	B
T32-PN01B03-8X1.25-61R	10139479	M8	1,25	5,43 0.214	20,0 0.787	35 1.378	84,57 3.330	93,3 3.673	8,0 0.315	8.00X6.20	6,8 0.268	3	B
T32-PN01B03-9X1.25-61R	10139480	M9	1,25	5,7 0.224	20,0 0.787	35 1.378	84,3 3.319	91,7 3.610	9,0 0.354	9.00X7.00	7,8 0.307	3	B
T32-PN01B03-10X1.5-61R	10139481	M10	1,5	6,84 0.269	20,0 0.787	39 1.535	93,16 3.668	101,8 4.008	10,0 0.394	10.00X8.00	8,5 0.335	3	B

Thread turning

MDT

Mini-Shaft™

Thread milling

Thread tapping

Annex

T32-PNB

Through holes – Metric coarse threads, 6G

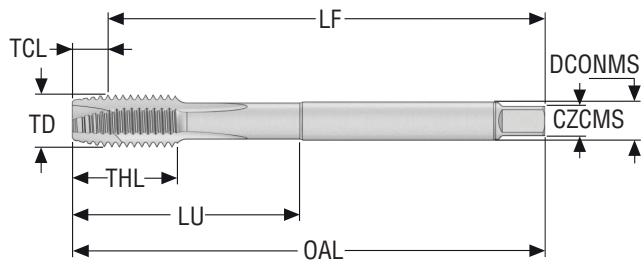

- Substrate: HSSE
- Coating: TiAlN + TiN
- Standard: DIN376
- Thread tolerance class: 6G
- For cutting data see page(s) 261

Designation	Item number	TDZ	Pitch	TCL	THL	LU	LF	OAL	DCONMS	CZCMS	PHDR Ø	NOF	THCHT
				mm	mm	mm	mm	mm	mm	mm			
T32-PN01B06-12X1.75-61R	10139564	M12	1,75	8,01 0.315	24,0 0.945	83 3.268	101,99 4.015	110,0 4.331	9,0 0.354	9.00X7.00	10,2 0.402	3	B
T32-PN01B06-16X2-61R	10139565	M16	2,0	9,24 0.364	32,0 1.260	68 2.677	100,76 3.967	110,0 4.331	12,0 0.472	12.00X9.00	14,0 0.551	3	B
T32-PN01B06-20X2.5-61R	10139566	M20	2,5	11,58 0.456	32,0 1.260	95 3.740	128,42 5.056	140,0 5.512	16,0 0.630	16.00X12.00	17,5 0.689	4	B
T32-PN01B06-24X3-61R	10139567	M24	3,0	13,68 0.539	38,0 1.496	113 4.449	146,32 5.761	160,0 6.299	18,0 0.709	18.00X14.50	21,0 0.827	4	B

Thread turning

MDT

Mini-Shaft™

Thread milling

Thread tapping

Annex

T32-PNB

Through holes – Metric coarse threads, left hand thread

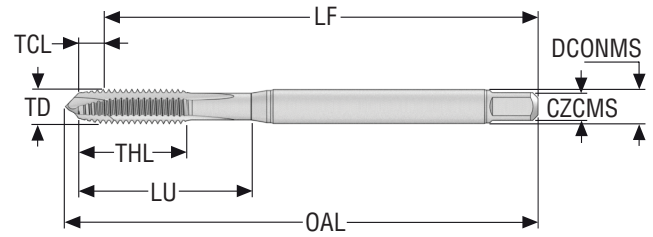

- Substrate: HSSE
- Coating: TiAlN + TiN
- Standard: DIN371
- Thread tolerance class: 6H
- For cutting data see page(s) 261

Designation	Item number	TDZ	Pitch	TCL	THL	LU	LF	OAL	DCONMS	CZCMS	PHDR Ø	NOF	THCHT
			mm	mm <i>Inch</i>	mm <i>Inch</i>	mm <i>Inch</i>	mm <i>Inch</i>	mm <i>Inch</i>	mm <i>Inch</i>	mm <i>Inch</i>	mm <i>Inch</i>		
T32-PN01B03-3X0.5-63L	10139466	M3	0,5	2,2 <i>0.087</i>	10,0 <i>0.394</i>	18 <i>0.709</i>	53,8 <i>2.118</i>	57,2 <i>2.252</i>	3,5 <i>0.138</i>	3.50X2.70	2,5 <i>0.098</i>	3	B
T32-PN01B03-4X0.7-63L	10139467	M4	0,7	3,3 <i>0.130</i>	12,0 <i>0.472</i>	21 <i>0.827</i>	59,7 <i>2.350</i>	64,6 <i>2.543</i>	4,5 <i>0.177</i>	4.50X3.40	3,3 <i>0.130</i>	3	B
T32-PN01B03-5X0.8-63L	10139468	M5	0,8	3,6 <i>0.142</i>	14,0 <i>0.551</i>	25 <i>0.984</i>	66,4 <i>2.614</i>	72,0 <i>2.835</i>	6,0 <i>0.236</i>	6.00X4.90	4,2 <i>0.165</i>	3	B
T32-PN01B03-6X1-63L	10139469	M6	1,0	4,4 <i>0.173</i>	18,0 <i>0.709</i>	30 <i>1.181</i>	75,6 <i>2.976</i>	82,4 <i>3.244</i>	6,0 <i>0.236</i>	6.00X4.90	5,0 <i>0.197</i>	3	B
T32-PN01B03-7X1-63L	10139470	M7	1,0	4,4 <i>0.173</i>	18,0 <i>0.709</i>	30 <i>1.181</i>	75,6 <i>2.976</i>	82,9 <i>3.264</i>	7,0 <i>0.276</i>	7.00X5.50	6,0 <i>0.236</i>	3	B
T32-PN01B03-8X1.25-63L	10139471	M8	1,25	5,4 <i>0.213</i>	20,0 <i>0.787</i>	35 <i>1.378</i>	84,6 <i>3.331</i>	93,3 <i>3.673</i>	8,0 <i>0.315</i>	8.00X6.20	6,8 <i>0.268</i>	3	B
T32-PN01B03-9X1.25-63L	10139472	M9	1,25	5,7 <i>0.224</i>	20,0 <i>0.787</i>	35 <i>1.378</i>	84,3 <i>3.319</i>	91,7 <i>3.610</i>	9,0 <i>0.354</i>	9.00X7.00	7,8 <i>0.307</i>	3	B
T32-PN01B03-10X1.5-63L	10139473	M10	1,5	6,8 <i>0.268</i>	20,0 <i>0.787</i>	39 <i>1.535</i>	93,2 <i>3.669</i>	101,8 <i>4.008</i>	10,0 <i>0.394</i>	10.00X8.00	8,5 <i>0.335</i>	3	B

Thread turning

MDT

Mini-Shaft™

Thread milling

Thread tapping

Annex

T32-PNB

Through holes – Metric coarse threads, left hand thread

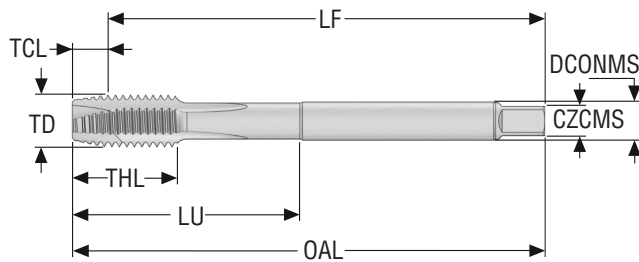

- Substrate: HSSE
- Coating: TiAlN + TiN
- Standard: DIN376
- Thread tolerance class: 6H
- For cutting data see page(s) 261

Designation	Item number	TDZ	Pitch	TCL	THL	LU	LF	OAL	DCONMS	CZCMS	PHDR Ø	NOF	THCHT
				mm	mm	mm	mm	mm	mm	mm			
T32-PN01B06-12X1.75-63L	10139560	M12	1,75	8,01 0.315	24,0 0.945	83 3.268	101,99 4.015	110,0 4.331	9,0 0.354	9.00X7.00	10,2 0.402	3	B
T32-PN01B06-16X2-63L	10139561	M16	2,0	9,24 0.364	32,0 1.260	68 2.677	100,76 3.967	110,0 4.331	12,0 0.472	12.00X9.00	14,0 0.551	3	B
T32-PN01B06-20X2.5-63L	10139562	M20	2,5	11,58 0.456	32,0 1.260	95 3.740	128,42 5.056	140,0 5.512	16,0 0.630	16.00X12.00	17,5 0.689	4	B
T32-PN01B06-24X3-63L	10139563	M24	3,0	13,68 0.539	38,0 1.496	113 4.449	146,32 5.761	160,0 6.299	18,0 0.709	18.00X14.50	21,0 0.827	4	B

Thread turning

MDT

Mini-Shaft™

Thread milling

Thread tapping

Annex

T32-PNB

Through holes – MF threads

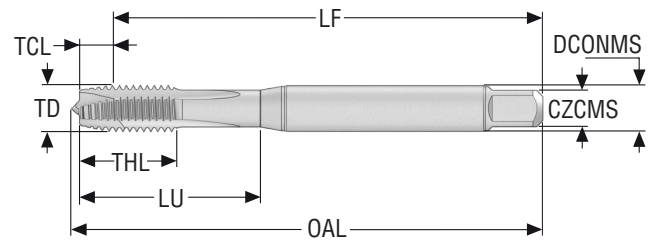

- Substrate: HSSE
- Coating: TiAlN + TiN
- Standard: DIN371
- Thread tolerance class: 6H
- For cutting data see page(s) 261

Designation	Item number	TDZ	Pitch	TCL	THL	LU	LF	OAL	DCONMS	CZCMS	PHDR Ø	NOF	THCHT
			mm	mm Inch	mm Inch	mm Inch	mm Inch	mm Inch	mm Inch	mm Inch	mm Inch		
T32-PN02B03-8X1-63R	10139449	MF8X1.0	1,0	4,41 0.174	20,0 0.787	35 1.378	85,59 3.370	93,3 3.673	8,0 0.315	8.00X6.20	7,0 0.276	3	B
T32-PN02B03-10X1-63R	10139450	MF10X1.0	1,0	4,77 0.188	20,0 0.787	35 1.378	85,23 3.356	91,8 3.614	10,0 0.394	10.00X8.00	9,0 0.354	3	B
T32-PN02B03-10X1.25-63R	10139451	MF10X1.25	1,25	5,8 0.228	20,0 0.787	39 1.535	94,2 3.709	101,8 4.008	10,0 0.394	10.00X8.00	8,8 0.346	3	B

Thread turning

MDT

Mini-Shaft™

Thread milling

Thread tapping

Annex

T32-PNB

Through holes – MF threads

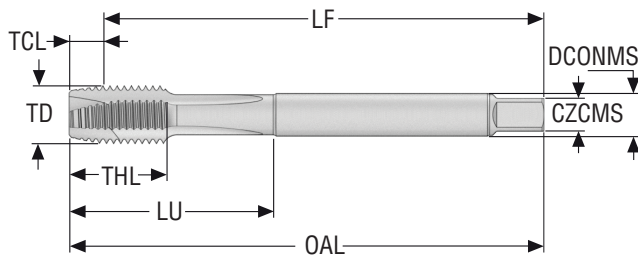

- Substrate: HSSE
- Coating: TiAlN + TiN
- Standard: DIN374
- Thread tolerance class: 6H
- For cutting data see page(s) 261

Designation	Item number	TDZ	Pitch	TCL	THL	LU	LF	OAL	DCONMS	CZCMS	PHDR Ø	NOF	THCHT
			mm	mm Inch	mm Inch	mm Inch	mm Inch	mm Inch	mm Inch		mm Inch		
T32-PN02B05-8X1-63R	10139507	MF8X1.0	1,0	4,67 0.184	20,0 0.787	67 2.638	85,33 3.359	90,0 3.543	6,0 0.236	6.00X4.90	7,0 0.276	3	B
T32-PN02B05-10X0.75-63R	10139508	MF10X0.75	0,75	3,73 0.147	18,0 0.709	67 2.638	86,27 3.396	90,0 3.543	7,0 0.276	7.00X5.50	9,2 0.362	3	B
T32-PN02B05-10X1-63R	10139509	MF10X1.0	1,0	4,79 0.189	20,0 0.787	67 2.638	85,21 3.355	90,0 3.543	7,0 0.276	7.00X5.50	9,0 0.354	3	B
T32-PN02B05-10X1.25-63R	10139510	MF10X1.25	1,25	5,8 0.228	20,0 0.787	77 3.031	94,2 3.709	100,0 3.937	7,0 0.276	7.00X5.50	8,8 0.346	3	B
T32-PN02B05-12X1-63R	10139511	MF12X1.0	1,0	4,89 0.193	20,0 0.787	73 2.874	95,11 3.744	100,0 3.937	9,0 0.354	9.00X7.00	11,0 0.433	3	B
T32-PN02B05-12X1.25-63R	10139512	MF12X1.25	1,25	5,94 0.234	20,0 0.787	73 2.874	94,06 3.703	100,0 3.937	9,0 0.354	9.00X7.00	10,8 0.425	3	B
T32-PN02B05-12X1.5-63R	10139513	MF12X1.5	1,5	6,97 0.274	20,0 0.787	73 2.874	93,03 3.663	100,0 3.937	9,0 0.354	9.00X7.00	10,5 0.413	3	B
T32-PN02B05-14X1-63R	10139514	MF14X1.0	1,0	4,99 0.196	20,0 0.787	71 2.795	95,01 3.741	100,0 3.937	11,0 0.433	11.00X9.00	13,0 0.512	3	B
T32-PN02B05-14X1.25-63R	10139515	MF14X1.25	1,25	6,04 0.238	20,0 0.787	71 2.795	93,96 3.699	100,0 3.937	11,0 0.433	11.00X9.00	12,8 0.504	3	B
T32-PN02B05-14X1.5-63R	10139516	MF14X1.5	1,5	7,07 0.278	20,0 0.787	71 2.795	92,93 3.659	100,0 3.937	11,0 0.433	11.00X9.00	12,5 0.492	3	B
T32-PN02B05-16X1-63R	10139517	MF16X1.0	1,0	5,09 0.200	20,0 0.787	58 2.283	94,91 3.737	100,0 3.937	12,0 0.472	12.00X9.00	15,0 0.591	3	B
T32-PN02B05-16X1.5-63R	10139518	MF16X1.5	1,5	7,17 0.282	20,0 0.787	58 2.283	92,83 3.655	100,0 3.937	12,0 0.472	12.00X9.00	14,5 0.571	3	B
T32-PN02B05-18X1.5-63R	10139519	MF18X1.5	1,5	7,27 0.286	24,0 0.945	66 2.598	102,73 4.044	110,0 4.331	14,0 0.551	14.00X11.00	16,5 0.650	4	B
T32-PN02B05-18X2-63R	10139520	MF18X2.0	2,0	9,34 0.368	27,0 1.063	81 3.189	115,66 4.554	125,0 4.921	14,0 0.551	14.00X11.00	16,0 0.630	4	B
T32-PN02B05-20X1.5-63R	10139521	MF20X1.5	1,5	7,47 0.294	24,0 0.945	80 3.150	117,53 4.627	125,0 4.921	16,0 0.630	16.00X12.00	18,5 0.728	4	B
T32-PN02B05-20X2-63R	10139522	MF20X2.0	2,0	9,54 0.376	27,0 1.063	95 3.740	130,46 5.136	140,0 5.512	16,0 0.630	16.00X12.00	18,0 0.709	4	B
T32-PN02B05-22X1.5-63R	10139523	MF22X1.5	1,5	7,67 0.302	24,0 0.945	78 3.071	117,33 4.619	125,0 4.921	18,0 0.709	18.00X14.50	20,5 0.807	4	B
T32-PN02B05-22X2-63R	10139524	MF22X2.0	2,0	9,74 0.383	27,0 1.063	93 3.661	130,26 5.128	140,0 5.512	18,0 0.709	18.00X14.50	20,0 0.787	4	B
T32-PN02B05-24X1.5-63R	10139525	MF24X1.5	1,5	7,5 0.295	27,0 1.063	93 3.661	132,5 5.217	140,0 5.512	18,0 0.709	18.00X14.50	22,5 0.886	4	B
T32-PN02B05-24X2-63R	10139526	MF24X2.0	2,0	9,57 0.377	27,0 1.063	93 3.661	130,43 5.135	140,0 5.512	18,0 0.709	18.00X14.50	22,0 0.866	4	B
T32-PN02B05-27X1.5-63R	10139527	MF27X1.5	1,5	7,7 0.303	27,0 1.063	77 3.031	132,3 5.209	140,0 5.512	20,0 0.787	20.00X16.00	25,5 1.004	4	B

Thread turning

MDT

Mini-Shaft™

Thread milling

Thread tapping

Annex

Designation	Item number	TDZ	Pitch	TCL	THL	LU	LF	OAL	DCONMS	CZCMS	PHDR Ø	NOF	THCT
			mm	mm <i>Inch</i>	mm <i>Inch</i>	mm <i>Inch</i>	mm <i>Inch</i>	mm <i>Inch</i>	mm <i>Inch</i>	mm <i>Inch</i>	mm <i>Inch</i>	mm <i>Inch</i>	
T32-PN02B05-27X2-63R	10139528	MF27X2.0	2,0	9,77 0.385	27,0 1.063	77 3.031	130,23 5.127	140,0 5.512	20,0 0.787	20.00X16.00	25,0 0.984	4	B
T32-PN02B05-30X1.5-63R	10139529	MF30X1.5	1,5	7,7 0.303	27,0 1.063	85 3.346	142,3 5.602	150,0 5.906	22,0 0.866	22.00X18.00	28,5 1.122	4	B
T32-PN02B05-30X2-63R	10139530	MF30X1.0	2,0	9,77 0.385	27,0 1.063	85 3.346	140,23 5.521	150,0 5.906	22,0 0.866	22.00X18.00	28,0 1.102	4	B

Thread turning

MDT

Mini-Shaft™

Thread milling

Thread tapping

Annex

T32-PNB

Through holes – UNC threads

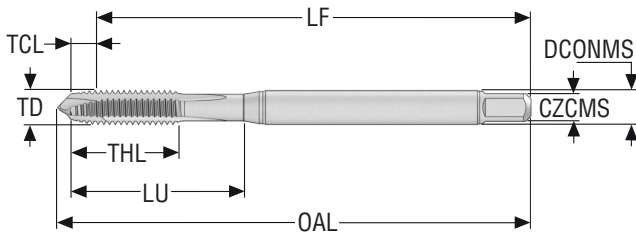

- Substrate: HSSE
- Coating: TiAlN + TiN
- Standard: DIN371
- Thread tolerance class: 2B
- For cutting data see page(s) 261

Designation	Item number	TDZ	TD	Pitch	TCL	THL	LU	LF	OAL	DCONMS	CZCMS	PHDR Ø	NOF	THCHT
			mm Inch	TPI	mm Inch	mm Inch	mm Inch	mm Inch	mm Inch	mm Inch	mm Inch	mm Inch		
T32-PN08B03-4-40-21R	10139452	UNC4-40	2,845 0.112	40.0	2,81 0.111	10,0 0.394	18 0.709	53,19 2.094	56,0 2.205	3,5 0.138	3.50X2.70	2.35 0.093	3	B
T32-PN08B03-5-40-21R	10139453	UNC5-40	3,175 0.125	40.0	2,92 0.115	10,0 0.394	18 0.709	53,08 2.090	57,2 2.252	3,5 0.138	3.50X2.70	2.65 0.104	3	B
T32-PN08B03-6-32-21R	10139454	UNC6-32	3,505 0.138	32.0	3,71 0.146	12,0 0.472	20 0.787	52,29 2.059	57,4 2.260	4,0 0.157	4.00X3.00	2.85 0.112	3	B
T32-PN08B03-8-32-21R	10139455	UNC8-32	4,166 0.164	32.0	3,59 0.141	12,0 0.472	21 0.827	59,41 2.339	64,6 2.543	4,5 0.177	4.50X3.40	3.5 0.138	3	B
T32-PN08B03-10-24-21R	10139456	UNC10-24	4,826 0.190	24.0	4,82 0.190	14,0 0.551	25 0.984	65,18 2.566	72,0 2.835	6,0 0.236	6.00X4.90	3.9 0.154	3	B
T32-PN08B03-12-24-21R	10139457	UNC12-24	5,486 0.216	24.0	4,69 0.185	18,0 0.709	30 1.181	75,31 2.965	82,2 3.236	6,0 0.236	6.00X4.90	4.5 0.177	3	B
T32-PN08B03-1/4-20-21R	10139458	UNC1/4-20	6,35 0.250	20.0	5,6 0.220	18,0 0.709	32 1.260	74,4 2.929	82,4 3.244	7,0 0.276	7.00X5.50	5.1 0.201	3	B
T32-PN08B03-5/16-18-21R	10139459	UNC5/16-18	7,937 0.312	18.0	6,26 0.246	20,0 0.787	35 1.378	83,74 3.297	93,3 3.673	8,0 0.315	8.00X6.20	6.6 0.260	3	B
T32-PN08B03-3/8-16-21R	10139460	UNC3/8-16	9,525 0.375	16.0	7,28 0.287	20,0 0.787	39 1.535	92,72 3.650	100,0 3.937	10,0 0.394	10.00X8.00	8.0 0.315	3	B

Thread turning

MDT

Mini-Shaft™

Thread milling

Thread tapping

Annex

T32-PNB

Through holes – UNC threads

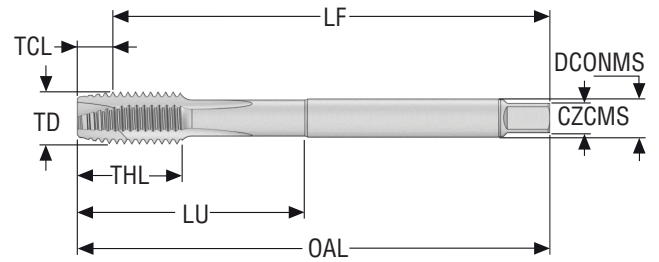

- Substrate: HSSE
- Coating: TiAlN + TiN
- Standard: DIN376
- Thread tolerance class: 2B
- For cutting data see page(s) 261

Designation	Item number	TDZ	TD	Pitch	TCL	THL	LU	LF	OAL	DCONMS	CZCMS	PHDR Ø	NOF	THCHT
			mm Inch	<i>TPI</i>	mm Inch	mm Inch	mm Inch	mm Inch	mm Inch	mm Inch		mm Inch		
T32-PN08B06-7/16-14-21R	10139531	UNC7/16-14	11,112 0.437	14.0	8,27 0.326	22,0 0.866	76 2.992	91,73 3.611	100,0 3.937	8,0 0.315	8.00X6.20	9,3 0.366	3	B
T32-PN08B06-1/2-13-21R	10139540	UNC1/2-13	12,7 0.500	13.0	9,01 0.355	24,0 0.945	83 3.268	100,99 3.976	110,0 4.331	9,0 0.354	9.00X7.00	10,7 0.421	3	B
T32-PN08B06-9/16-12-21R	10139533	UNC9/16-12	14,287 0.562	12.0	9,76 0.384	25,0 0.984	81 3.189	100,24 3.946	110,0 4.331	11,0 0.433	11.00X9.00	12,3 0.484	3	B
T32-PN08B06-5/8-11-21R	10139534	UNC5/8-11	15,875 0.625	11.0	10,51 0.414	32,0 1.260	68 2.677	99,49 3.917	110,0 4.331	12,0 0.472	12.00X9.00	13,5 0.531	3	B
T32-PN08B06-3/4-10-21R	10139535	UNC3/4-10	19,05 0.750	10.0	11,55 0.455	32,0 1.260	81 3.189	113,45 4.467	125,0 4.921	14,0 0.551	14.00X11.00	16,5 0.650	4	B
T32-PN08B06-7/8-9-21R	10139536	UNC7/8-9	22,225 0.875	9.0	13,04 0.513	32,0 1.260	93 3.661	126,96 4.998	140,0 5.512	18,0 0.709	18.00X14.50	19,5 0.768	4	B
T32-PN08B06-1-8-21R	10139537	UNC1-8	25,4 1.000	8.0	14,86 0.585	38,0 1.496	97 3.819	145,14 5.714	160,0 6.299	20,0 0.787	20.00X16.00	22,25 0.876	4	B
T32-PN08B06-1_1/8-7-21R	10139756	UNC1 1/8-7	28,575 1.125	7.0	16,48 0.649	45,0 1.772	115 4.528	163,52 6.438	180,0 7.087	22,0 0.866	22.00X18.00	25,0 0.984	4	B
T32-PN08B06-1_1/4-7-21R	10139538	UNC1 1/4-7	31,75 1.250	7.0	16,74 0.659	45,0 1.772	115 4.528	163,26 6.428	180,0 7.087	22,0 0.866	22.00X18.00	28,0 1.102	4	B
T32-PN08B06-1_3/8-6-21R	10139532	UNC1 3/8-6	34,925 1.375	6.0	19,04 0.750	50,0 1.969	131 5.157	180,96 7.124	200,0 7.874	28,0 1.102	28.00X22.00	30,75 1.211	4	B
T32-PN08B06-1_1/2-6-21R	10139539	UNC1 1/2-6	38,1 1.500	6.0	19,3 0.760	55,0 2.165	131 5.157	180,7 7.114	200,0 7.874	28,0 1.102	28.00X22.00	34,0 1.339	4	B

T32-PNB

Through holes – UNF threads

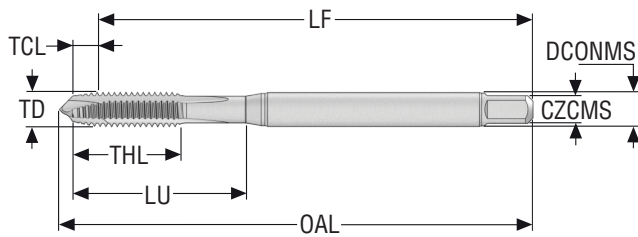

- Substrate: HSSE
- Coating: TiAlN + TiN
- Standard: DIN371
- Thread tolerance class: 2B
- For cutting data see page(s) 261

Designation	Item number	TDZ	TD	Pitch	TCL	THL	LU	LF	OAL	DCONMS	CZCMS	PHDR Ø	NOF	THCHT
			mm Inch	TPI	mm Inch	mm Inch	mm Inch	mm Inch	mm Inch	mm Inch	mm Inch			
T32-PN09B03-10-32-21R	10139461	UNF10-32	4,826 0.190	32.0	3,8 0.150	14,0 0.551	25 0.984	66,2 2.606	72,0 2.835	6,0 0.236	6.00X4.90	4,1 0.161	3	B
T32-PN09B03-12-28-21R	10139462	UNF12-28	5,486 0.216	28.0	4,01 0.158	18,0 0.709	30 1.181	75,99 2.992	82,4 3.244	6,0 0.236	6.00X4.90	4,6 0.181	3	B
T32-PN09B03-1/4-28-21R	10139463	UNF1/4-28	6,35 0.250	28.0	4,24 0.167	18,0 0.709	30 1.181	75,76 2.983	82,4 3.244	7,0 0.276	7.00X5.50	5,5 0.217	3	B
T32-PN09B03-5/16-24-21R	10139464	UNF5/16-24	7,937 0.312	24.0	4,89 0.193	20,0 0.787	35 1.378	85,11 3.351	93,3 3.673	8,0 0.315	8.00X6.20	6,9 0.272	3	B
T32-PN09B03-3/8-24-21R	10139465	UNF3/8-24	9,525 0.375	24.0	5,22 0.206	20,0 0.787	35 1.378	84,78 3.338	90,0 3.543	10,0 0.394	10.00X8.00	8,5 0.335	3	B

Thread turning

MDT

Mini-Shaft™

Thread milling

Thread tapping

Annex

T32-PNB

Through holes – UNF threads

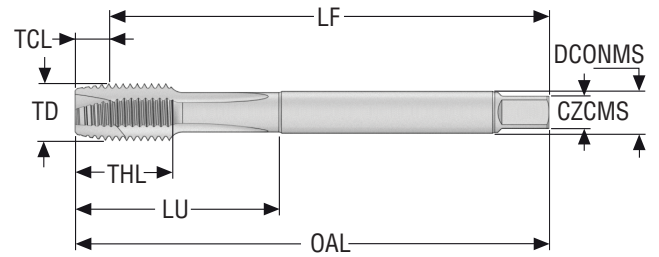

- Substrate: HSSE
- Coating: TiAlN + TiN
- Standard: DIN374
- Thread tolerance class: 2B
- For cutting data see page(s) 261

Designation	Item number	TDZ	TD	Pitch	TCL	THL	LU	LF	OAL	DCONMS	CZCMS	PHDR Ø	NOF	THCHT
			mm Inch	TPI	mm Inch	mm Inch	mm Inch	mm Inch	mm Inch	mm Inch		mm Inch		
T32-PN09B05-7/16-20-21R	10139542	UNF7/16-20	11,112 0.437	20.0	5.88 0.231	20,0 0.787	76 2.992	94,12 3.706	100,0 3.937	8,0 0.315	8.00X6.20	9,9 0.390	3	B
T32-PN09B05-1/2-20-21R	10139551	UNF1/2-20	12,7 0.500	20.0	6,28 0.247	20,0 0.787	73 2.874	93,72 3.690	100,0 3.937	9,0 0.354	9.00X7.00	11,5 0.453	3	B
T32-PN09B05-9/16-18-21R	10139544	UNF9/16-18	14,287 0.562	18.0	6,69 0.263	20,0 0.787	71 2.795	93,31 3.674	100,0 3.937	11,0 0.433	11.00X9.00	13,0 0.512	3	B
T32-PN09B05-5/8-18-21R	10139545	UNF5/8-18	15,875 0.625	18.0	6,76 0.266	20,0 0.787	58 2.283	93,24 3.671	100,0 3.937	12,0 0.472	12.00X9.00	14,5 0.571	3	B
T32-PN09B05-3/4-16-21R	10139546	UNF3/4-16	19,05 0.750	16.0	7,81 0.307	24,0 0.945	66 2.598	102,19 4.023	110,0 4.331	14,0 0.551	14.00X11.00	17,5 0.689	4	B
T32-PN09B05-7/8-14-21R	10139547	UNF7/8-14	22,225 0.875	14.0	8,96 0.353	24,0 0.945	78 3.071	116,04 4.569	125,0 4.921	18,0 0.709	18.00X14.50	20,5 0.807	4	B
T32-PN09B05-1-12-21R	10139548	UNF1-12	25,4 1.000	12.0	10,44 0.411	27,0 1.063	93 3.661	129,56 5.101	140,0 5.512	18,0 0.709	18.00X14.50	23,3 0.917	4	B
T32-PN09B05-1_1/8-12-21R	10139757	UNF1 1/8-12	28,575 1.125	12.0	10,37 0.408	27,0 1.063	85 3.346	139,63 5.497	150,0 5.906	22,0 0.866	22.00X18.00	26,5 1.043	4	B
T32-PN09B05-1_1/4-12-21R	10139549	UNF1 1/4-12	31,75 1.250	12.0	10,29 0.405	27,0 1.063	85 3.346	139,71 5.500	150,0 5.906	22,0 0.866	22.00X18.00	29,5 1.161	4	B
T32-PN09B05-1_3/8-12-21R	10139543	UNF1 3/8-12	34,925 1.375	12.0	10,55 0.415	30,0 1.181	101 3.976	159,45 6.278	170,0 6.693	28,0 1.102	28.00X22.00	32,8 1.291	4	B
T32-PN09B05-1_1/2-12-21R	10139550	UNF1 1/2-12	38,1 1.500	12.0	10,48 0.413	30,0 1.181	101 3.976	159,52 6.280	170,0 6.693	28,0 1.102	28.00X22.00	36,0 1.417	4	B

Thread turning

MDT

Mini-Shaft™

Thread milling

Thread tapping

Annex

T32-PNB

Through holes – G threads

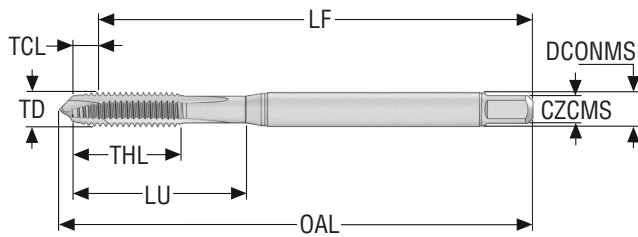

- Substrate: HSSE
- Coating: TiAlN + TiN
- Standard: DIN5156
- Thread tolerance class: NORMAL
- For cutting data see page(s) 261

Designation	Item number	TDZ	TD	Pitch	TCL	THL	LU	LF	OAL	DCONMS	CZCMS	PHDR Ø	NOF	THCHT
			mm Inch	TPI	mm Inch	mm Inch	mm Inch	mm Inch	mm Inch	mm Inch	mm Inch			
T32-PN21B09-1/8-28-11R	10139552	G1/8-28	9,728 0.383	28.0	4,76 0.187	18,0 0.709	67 2.638	85,24 3.356	90,0 3.543	7,0 0.276	7.00X5.50	8,8 0.346	3	B
T32-PN21B09-1/4-19-11R	10139553	G1/4-19	13,157 0.518	19.0	6,77 0.267	22,0 0.866	71 2.795	93,23 3.670	100,0 3.937	11,0 0.433	11.00X9.00	11,8 0.465	3	B
T32-PN21B09-3/8-19-11R	10139554	G3/8-19	16,662 0.656	19.0	6,89 0.271	22,0 0.866	58 2.283	93,11 3.666	100,0 3.937	12,0 0.472	12.00X9.00	15,25 0.600	4	B
T32-PN21B09-1/2-14-11R	10139555	G1/2-14	20,955 0.825	14.0	9,22 0.363	25,0 0.984	80 3.150	115,78 4.558	125,0 4.921	16,0 0.630	16.00X12.00	19,0 0.748	4	B
T32-PN21B09-5/8-14-11R	10139556	G5/8-14	22,911 0.902	14.0	9,4 0.370	25,0 0.984	78 3.071	115,6 4.551	125,0 4.921	18,0 0.709	18.00X14.50	21,0 0.827	4	B
T32-PN21B09-3/4-14-11R	10139557	G3/4-14	26,441 1.041	14.0	9,36 0.369	28,0 1.102	77 3.031	130,64 5.143	140,0 5.512	20,0 0.787	20.00X16.00	24,5 0.965	4	B
T32-PN21B09-7/8-14-11R	10139558	G7/8-14	30,201 1.189	14.0	9,03 0.356	30,0 1.181	85 3.346	140,97 5.550	150,0 5.906	22,0 0.866	22.00X18.00	28,25 1.112	4	B
T32-PN21B09-1-11-11R	10139559	G1-11	33,249 1.309	11.0	11,49 0.452	32,0 1.260	93 3.661	148,51 5.847	160,0 6.299	25,0 0.984	25.00X20.00	30,75 1.211	4	B

Thread turning

MDT

Mini-Shaft™

Thread milling

Thread tapping

Annex

T32-R40NC-micro

Blind holes – Metric coarse threads

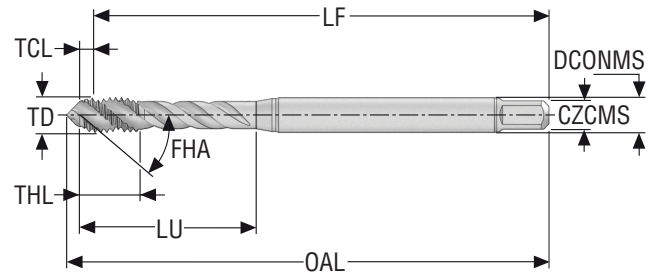

- Substrate: HSS-PM
- Coating: TiAlN + TiN
- Standard: DIN371
- Thread tolerance class: 4H
- FHA = 40°
- For cutting data see page(s) 261

Designation	Item number	TDZ	Pitch	TCL	THL	LU	LF	OAL	DCONMS	CZCMS	PHDR Ø	NOF	THCT
			mm	mm <i>Inch</i>	mm <i>Inch</i>	mm <i>Inch</i>	mm <i>Inch</i>	mm <i>Inch</i>	mm <i>Inch</i>	mm <i>Inch</i>	mm <i>Inch</i>		
T32-R40N01C03-1X0.25-41R	10139129	M1	0,25	0,59 <i>0.023</i>	6,0 <i>0.236</i>	13 <i>0.512</i>	39,41 <i>1.552</i>	40,9 <i>1.610</i>	2,5 <i>0.098</i>	2.50X2.10	0,75 <i>0.030</i>	2	C
T32-R40N01C03-1.1X0.25-41R	10139130	M1.1	0,25	0,59 <i>0.023</i>	6,0 <i>0.236</i>	13 <i>0.512</i>	39,41 <i>1.552</i>	41,0 <i>1.614</i>	2,5 <i>0.098</i>	2.50X2.10	0,85 <i>0.033</i>	2	C
T32-R40N01C03-1.2X0.25-41R	10139131	M1.2	0,25	0,59 <i>0.023</i>	6,0 <i>0.236</i>	13 <i>0.512</i>	39,41 <i>1.552</i>	41,1 <i>1.618</i>	2,5 <i>0.098</i>	2.50X2.10	0,95 <i>0.037</i>	2	C
T32-R40N01C03-1.4X0.3-41R	10139132	M1.4	0,3	0,69 <i>0.027</i>	8,0 <i>0.315</i>	13 <i>0.512</i>	39,31 <i>1.548</i>	41,3 <i>1.626</i>	2,5 <i>0.098</i>	2.50X2.10	1,1 <i>0.043</i>	2	C

Thread turning

MDT

Mini-Shaft™

Thread milling

Thread tapping

Annex

T32-R40NC-micro

Blind holes – Metric coarse threads

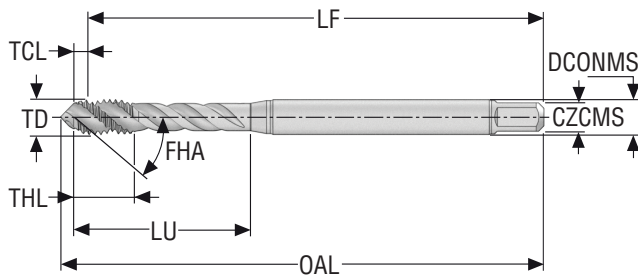

- Substrate: HSSE
- Coating: TiAlN + TiN
- Standard: DIN371
- Thread tolerance class: 6H
- FHA = 40°
- For cutting data see page(s) 261

Designation	Item number	TDZ	Pitch	TCL	THL	LU	LF	OAL	DCONMS	CZCMS	PHDR Ø	NOF	THCHT
			mm	mm <i>Inch</i>	mm <i>Inch</i>	mm <i>Inch</i>	mm <i>Inch</i>	mm <i>Inch</i>	mm <i>Inch</i>	mm <i>Inch</i>	mm <i>Inch</i>		
T32-R40N01C03-1.6X0.35-63R	10139133	M1.6	0,35	0,8 <i>0.031</i>	8,0 <i>0.315</i>	13 <i>0.512</i>	39,2 <i>1.543</i>	41,4 <i>1.630</i>	2,5 <i>0.098</i>	2.50X2.10	1,25 <i>0.049</i>	2	C
T32-R40N01C03-1.7X0.35-63R	10139134	M1.7	0,35	0,8 <i>0.031</i>	8,0 <i>0.315</i>	13 <i>0.512</i>	39,2 <i>1.543</i>	41,5 <i>1.634</i>	2,5 <i>0.098</i>	2.50X2.10	1,35 <i>0.053</i>	2	C
T32-R40N01C03-1.8X0.35-63R	10139135	M1.8	0,35	0,8 <i>0.031</i>	8,0 <i>0.315</i>	13 <i>0.512</i>	39,2 <i>1.543</i>	41,6 <i>1.638</i>	2,5 <i>0.098</i>	2.50X2.10	1,45 <i>0.057</i>	2	C
T32-R40N01C03-2X0.4-63R	10139136	M2	0,4	1,03 <i>0.041</i>	10,0 <i>0.394</i>	13 <i>0.512</i>	43,974 <i>1.731</i>	46,3 <i>1.823</i>	2,8 <i>0.110</i>	2.80X2.10	1,6 <i>0.063</i>	2	C
T32-R40N01C03-2.2X0.45-63R	10139137	M2.2	0,45	1,15 <i>0.045</i>	10,0 <i>0.394</i>	13 <i>0.512</i>	43,847 <i>1.726</i>	46,3 <i>1.823</i>	2,8 <i>0.110</i>	2.80X2.10	1,75 <i>0.069</i>	2	C
T32-R40N01C03-2.3X0.4-63R	10139138	M2.3	0,4	1,05 <i>0.041</i>	10,0 <i>0.394</i>	13 <i>0.512</i>	43,948 <i>1.730</i>	46,3 <i>1.823</i>	2,8 <i>0.110</i>	2.80X2.10	1,9 <i>0.075</i>	2	C
T32-R40N01C03-2.5X0.45-63R	10139139	M2.5	0,45	1,06 <i>0.042</i>	5,0 <i>0.197</i>	14 <i>0.551</i>	48,94 <i>1.927</i>	51,7 <i>2.035</i>	2,8 <i>0.110</i>	2.80X2.10	2,05 <i>0.081</i>	2	C
T32-R40N01C03-2.6X0.45-63R	10139140	M2.6	0,45	1,15 <i>0.045</i>	5,0 <i>0.197</i>	14 <i>0.551</i>	48,847 <i>1.923</i>	51,7 <i>2.035</i>	2,8 <i>0.110</i>	2.80X2.10	2,15 <i>0.085</i>	2	C

T32-R40NC

Blind holes – Metric coarse threads

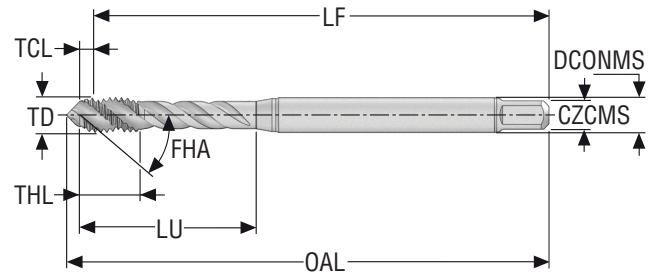

- Substrate: HSSE
- Coating: TiAlN + TiN
- Standard: DIN371
- Thread tolerance class: 6H
- FHA = 40°
- For cutting data see page(s) 261

Designation	Item number	TDZ	Pitch	TCL	THL	LU	LF	OAL	DCONMS	CZCMS	PHDR Ø	NOF	THCT
			mm	mm <i>Inch</i>	mm <i>Inch</i>	mm <i>Inch</i>	mm <i>Inch</i>	mm <i>Inch</i>	mm <i>Inch</i>	mm <i>Inch</i>	mm <i>Inch</i>		
T32-R40N01C03-3X0.5-63R	10139141	M3	0,5	1,2 <i>0.047</i>	5,0 <i>0.197</i>	18 <i>0.709</i>	54,8 <i>2.157</i>	57,2 <i>2.252</i>	3,5 <i>0.138</i>	3.50X2.70	2,5 <i>0.098</i>	3	C
T32-R40N01C03-3.5X0.6-63R	10139142	M3.5	0,6	1,36 <i>0.054</i>	6,0 <i>0.236</i>	20 <i>0.787</i>	54,64 <i>2.151</i>	57,4 <i>2.260</i>	4,0 <i>0.157</i>	4.00X3.00	2,9 <i>0.114</i>	3	C
T32-R40N01C03-4X0.7-63R	10139143	M4	0,7	1,54 <i>0.061</i>	7,0 <i>0.276</i>	21 <i>0.827</i>	61,46 <i>2.420</i>	64,6 <i>2.543</i>	4,5 <i>0.177</i>	4.50X3.40	3,3 <i>0.130</i>	3	C
T32-R40N01C03-5X0.8-63R	10139144	M5	0,8	1,9 <i>0.075</i>	8,0 <i>0.315</i>	25 <i>0.984</i>	68,1 <i>2.681</i>	72,0 <i>2.835</i>	6,0 <i>0.236</i>	6.00X4.90	4,2 <i>0.165</i>	3	C
T32-R40N01C03-6X1-63R	10139145	M6	1,0	2,28 <i>0.090</i>	10,0 <i>0.394</i>	30 <i>1.181</i>	77,72 <i>3.060</i>	82,4 <i>3.244</i>	6,0 <i>0.236</i>	6.00X4.90	5,0 <i>0.197</i>	3	C
T32-R40N01C03-7X1-63R	10139146	M7	1,0	2,28 <i>0.090</i>	10,0 <i>0.394</i>	30 <i>1.181</i>	77,72 <i>3.060</i>	82,9 <i>3.264</i>	7,0 <i>0.276</i>	7.00X5.50	6,0 <i>0.236</i>	3	C
T32-R40N01C03-8X1.25-63R	10139147	M8	1,25	3,11 <i>0.122</i>	13,0 <i>0.512</i>	35 <i>1.378</i>	86,89 <i>3.421</i>	91,7 <i>3.610</i>	8,0 <i>0.315</i>	8.00X6.20	6,8 <i>0.268</i>	3	C
T32-R40N01C03-9X1.25-63R	10139148	M9	1,25	3,11 <i>0.122</i>	13,0 <i>0.512</i>	35 <i>1.378</i>	86,89 <i>3.421</i>	91,7 <i>3.610</i>	9,0 <i>0.354</i>	9.00X7.00	7,8 <i>0.307</i>	3	C
T32-R40N01C03-10X1.5-63R	10139149	M10	1,5	3,76 <i>0.148</i>	15,0 <i>0.591</i>	39 <i>1.535</i>	96,24 <i>3.789</i>	101,8 <i>4.008</i>	10,0 <i>0.394</i>	10.00X8.00	8,5 <i>0.335</i>	3	C

Thread turning

MDT

Mini-Shaft™

Thread milling

Thread tapping

Annex

T32-R40NC

Blind holes – Metric coarse threads

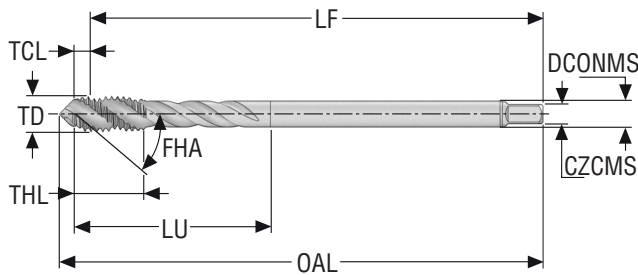

- Substrate: HSSE
- Coating: TiAlN + TiN
- Standard: DIN376
- Thread tolerance class: 6H
- FHA = 40°
- For cutting data see page(s) 261

Designation	Item number	TDZ	Pitch	TCL	THL	LU	LF	OAL	DCONMS	CZCMS	PHDR Ø	NOF	THCHT
			mm	mm <i>Inch</i>	mm <i>Inch</i>	mm <i>Inch</i>	mm <i>Inch</i>	mm <i>Inch</i>	mm <i>Inch</i>	mm <i>Inch</i>	mm <i>Inch</i>		
T32-R40N01C06-3X0.5-63R	10139568	M3	0,5	1,17 0.046	5,0 0.197	36 1.417	54,83 2.159	57,2 2.252	2,2 0.087	2.20X1.80	2,5 0.098	3	C
T32-R40N01C06-4X0.7-63R	10139570	M4	0,7	1,72 0.068	8,0 0.315	43 1.693	61,28 2.413	64,6 2.543	2,8 0.110	2.80X2.10	3,3 0.130	3	C
T32-R40N01C06-5X0.8-63R	10139571	M5	0,8	1,9 0.075	10,0 0.394	49 1.929	68,1 2.681	72,0 2.835	3,5 0.138	3.50X2.70	4,2 0.165	3	C
T32-R40N01C06-6X1-63R	10139572	M6	1,0	2,28 0.090	12,0 0.472	59 2.323	77,72 3.060	82,4 3.244	4,5 0.177	4.50X3.40	5,0 0.197	3	C
T32-R40N01C06-8X1.25-63R	10139574	M8	1,25	3,11 0.122	15,0 0.591	67 2.638	86,89 3.421	90,0 3.543	6,0 0.236	6.00X4.90	6,8 0.268	3	C
T32-R40N01C06-9X1.25-63R	10139575	M9	1,25	3,21 0.126	15,0 0.591	67 2.638	86,79 3.417	90,0 3.543	7,0 0.276	7.00X5.50	7,8 0.307	3	C
T32-R40N01C06-10X1.5-63R	10139576	M10	1,5	3,76 0.148	17,0 0.669	77 3.031	96,24 3.789	100,0 3.937	7,0 0.276	7.00X5.50	8,5 0.335	3	C
T32-R40N01C06-12X1.75-63R	10139577	M12	1,75	4,41 0.174	18,0 0.709	83 3.268	105,59 4.157	110,0 4.331	9,0 0.354	9.00X7.00	10,2 0.402	3	C
T32-R40N01C06-14X2-63R	10139578	M14	2,0	5,07 0.200	20,0 0.787	81 3.189	104,93 4.131	110,0 4.331	11,0 0.433	11.00X9.00	12,0 0.472	4	C
T32-R40N01C06-16X2-63R	10139579	M16	2,0	5,15 0.203	20,0 0.787	68 2.677	104,85 4.128	110,0 4.331	12,0 0.472	12.00X9.00	14,0 0.551	4	C
T32-R40N01C06-18X2.5-63R	10139580	M18	2,5	6,31 0.248	25,0 0.984	81 3.189	118,69 4.673	125,0 4.921	14,0 0.551	14.00X11.00	15,5 0.610	4	C
T32-R40N01C06-20X2.5-63R	10139581	M20	2,5	6,51 0.256	25,0 0.984	95 3.740	133,49 5.256	140,0 5.512	16,0 0.630	16.00X12.00	17,5 0.689	4	C
T32-R40N01C06-22X2.5-63R	10139582	M22	2,5	6,51 0.256	25,0 0.984	93 3.661	133,49 5.256	140,0 5.512	18,0 0.709	18.00X14.50	19,5 0.768	4	C
T32-R40N01C06-24X3-63R	10139583	M24	3,0	7,81 0.307	30,0 1.181	113 4.449	152,19 5.992	160,0 6.299	18,0 0.709	18.00X14.50	21,0 0.827	4	C
T32-R40N01C06-27X3-63R	10139584	M27	3,0	7,81 0.307	30,0 1.181	97 3.819	152,19 5.992	160,0 6.299	20,0 0.787	20.00X16.00	24,0 0.945	4	C
T32-R40N01C06-30X3.5-63R	10139585	M30	3,5	8,88 0.350	35,0 1.378	115 4.528	171,12 6.737	180,0 7.087	22,0 0.866	22.00X18.00	26,5 1.043	4	C
T32-R40N01C06-33X3.5-63R	10139586	M33	3,5	8,88 0.350	35,0 1.378	113 4.449	171,12 6.737	180,0 7.087	25,0 0.984	25.00X20.00	29,5 1.161	4	C
T32-R40N01C06-36X4-63R	10139587	M36	4,0	9,94 0.391	40,0 1.575	131 5.157	190,06 7.483	200,0 7.874	28,0 1.102	28.00X22.00	32,0 1.260	4	C
T32-R40N01C06-39X4-63R	10139588	M39	4,0	9,94 0.391	40,0 1.575	102 4.016	190,06 7.483	200,0 7.874	32,0 1.260	32.00X24.00	35,0 1.378	4	C
T32-R40N01C06-42X4.5-63R	10139589	M42	4,5	11,01 0.433	45,0 1.772	102 4.016	188,99 7.441	200,0 7.874	32,0 1.260	32.00X24.00	37,5 1.476	5	C

Designation	Item number	TDZ	Pitch	TCL	THL	LU	LF	OAL	DCONMS	CZCMS	PHDR Ø	NOF	THCHT
			mm	mm <i>Inch</i>	mm <i>Inch</i>	mm <i>Inch</i>	mm <i>Inch</i>	mm <i>Inch</i>	mm <i>Inch</i>	mm <i>Inch</i>	mm <i>Inch</i>		
T32-R40N01C06-45X4.5-63R	10139590	M45	4,5	11,01 0.433	45,0 1.772	117 4.606	208,99 8.228	220,0 8.661	36,0 1.417	36.00X29.00	40,5 1.594	5	C
T32-R40N01C06-48X5-63R	10139591	M48	5,0	12,08 0.476	50,0 1.969	147 5.787	237,92 9.367	250,0 9.843	36,0 1.417	36.00X29.00	43,0 1.693	5	C
T32-R40N01C06-52X5-63R	10139592	M52	5,0	12,08 0.476	50,0 1.969	120 4.724	237,92 9.367	250,0 9.843	40,0 1.575	40.00X32.00	47,0 1.850	5	C

Thread turning

MDT

Mini-Shaft™

Thread milling

Thread tapping

Annex

T32-R40NC

Blind holes – Metric coarse threads

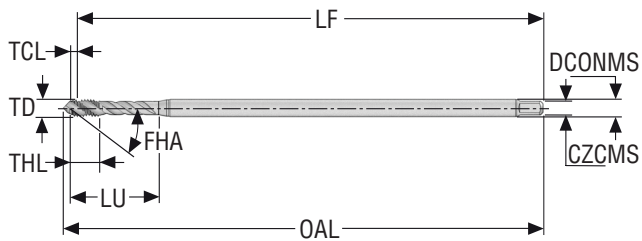

- Substrate: HSSE
- Coating: TiAlN + TiN
- Standard: DIN371/EL
- Thread tolerance class: 6H
- FHA = 40°
- For cutting data see page(s) 261

Designation	Item number	TDZ	Pitch	TCL	THL	LU	LF	OAL	DCONMS	CZCMS	PHDR Ø	NOF	THCT
			mm	mm <i>Inch</i>	mm <i>Inch</i>	mm <i>Inch</i>	mm <i>Inch</i>	mm <i>Inch</i>	mm <i>Inch</i>	mm <i>Inch</i>	mm <i>Inch</i>		
T32-R40N01C04-3X0.5-63R	10139179	M3	0,5	1,17 0.046	5,0 0.197	18 0.709	98,83 3.891	101,2 3.984	3,5 0.138	3.50X2.70	2,5 0.098	3	C
T32-R40N01C04-4X0.7-63R	10139180	M4	0,7	1,45 0.057	7,0 0.276	21 0.827	123,55 4.864	126,6 4.984	4,5 0.177	4.50X3.40	3,3 0.130	3	C
T32-R40N01C04-5X0.8-63R	10139181	M5	0,8	1,9 0.075	8,0 0.315	25 0.984	138,1 5.437	142,0 5.591	6,0 0.236	6.00X4.90	4,2 0.165	3	C
T32-R40N01C04-6X1-63R	10139182	M6	1,0	2,28 0.090	10,0 0.394	30 1.181	157,72 6.209	162,4 6.394	6,0 0.236	6.00X4.90	5,0 0.197	3	C

Thread turning

MDT

Mini-Shaft™

Thread milling

Thread tapping

Annex

T32-R40NC

Blind holes – Metric coarse threads

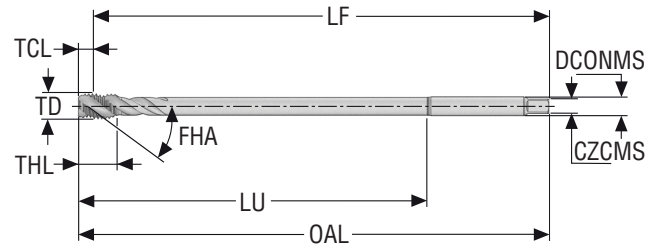

- Substrate: HSSE
- Coating: TiAlN + TiN
- Standard: DIN376/EL
- Thread tolerance class: 6H
- FHA = 40°
- For cutting data see page(s) 261

Designation	Item number	TDZ	Pitch	TCL	THL	LU	LF	OAL	DCONMS	CZCMS	PHDR Ø	NOF	THCT
			mm	mm <i>Inch</i>	mm <i>Inch</i>	mm <i>Inch</i>	mm <i>Inch</i>	mm <i>Inch</i>	mm <i>Inch</i>	mm <i>Inch</i>	mm <i>Inch</i>		
T32-R40N01C07-8X1.25-63R	10139183	M8	1,25	3,11 0.122	15,0 0.591	157 6.181	176,89 6.964	180,0 7.087	6,0 0.236	6.00X4.90	6,8 0.268	3	C
T32-R40N01C07-10X1.5-63R	10139185	M10	1,5	3,76 0.148	17,0 0.669	177 6.969	196,24 7.726	200,0 7.874	7,0 0.276	7.00X5.50	8,5 0.335	3	C
T32-R40N01C07-12X1.75-63R	10139186	M12	1,75	4,41 0.174	18,0 0.709	193 7.598	215,59 8.488	220,0 8.661	9,0 0.354	9.00X7.00	10,2 0.402	3	C
T32-R40N01C07-16X2-63R	10139187	M16	2,0	5,21 0.205	20,0 0.787	178 7.008	214,79 8.456	220,0 8.661	12,0 0.472	12.00X9.00	14,0 0.551	4	C

Thread turning

MDT

Mini-Shaft™

Thread milling

Thread tapping

Annex

T32-R40NC

Blind holes – Metric coarse threads, 6G

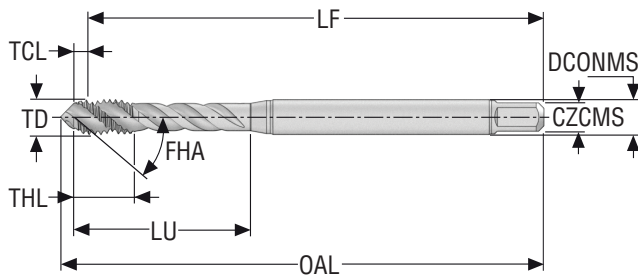

- Substrate: HSSE
- Coating: TiAlN + TiN
- Standard: DIN371
- Thread tolerance class: 6G
- FHA = 40°
- For cutting data see page(s) 261

Designation	Item number	TDZ	Pitch	TCL	THL	LU	LF	OAL	DCONMS	CZCMS	PHDR Ø	NOF	THCT
			mm	mm <i>Inch</i>	mm <i>Inch</i>	mm <i>Inch</i>	mm <i>Inch</i>	mm <i>Inch</i>	mm <i>Inch</i>	mm <i>Inch</i>	mm <i>Inch</i>		
T32-R40N01C03-3X0.5-61R	10139173	M3	0,5	1,2 <i>0.047</i>	5,0 <i>0.197</i>	18 <i>0.709</i>	54,8 <i>2.157</i>	57,2 <i>2.252</i>	3,5 <i>0.138</i>	3.50X2.70	2,5 <i>0.098</i>	3	C
T32-R40N01C03-4X0.7-61R	10139174	M4	0,7	1,54 <i>0.061</i>	7,0 <i>0.276</i>	21 <i>0.827</i>	61,46 <i>2.420</i>	64,6 <i>2.543</i>	4,5 <i>0.177</i>	4.50X3.40	3,3 <i>0.130</i>	3	C
T32-R40N01C03-5X0.8-61R	10139175	M5	0,8	1,9 <i>0.075</i>	8,0 <i>0.315</i>	25 <i>0.984</i>	68,1 <i>2.681</i>	72,0 <i>2.835</i>	6,0 <i>0.236</i>	6.00X4.90	4,2 <i>0.165</i>	3	C
T32-R40N01C03-6X1-61R	10139176	M6	1,0	2,28 <i>0.090</i>	10,0 <i>0.394</i>	30 <i>1.181</i>	77,72 <i>3.060</i>	82,4 <i>3.244</i>	6,0 <i>0.236</i>	6.00X4.90	5,0 <i>0.197</i>	3	C
T32-R40N01C03-8X1.25-61R	10139177	M8	1,25	3,11 <i>0.122</i>	13,0 <i>0.512</i>	35 <i>1.378</i>	86,89 <i>3.421</i>	91,7 <i>3.610</i>	8,0 <i>0.315</i>	8.00X6.20	6,8 <i>0.268</i>	3	C
T32-R40N01C03-10X1.5-61R	10139178	M10	1,5	3,76 <i>0.148</i>	15,0 <i>0.591</i>	39 <i>1.535</i>	96,24 <i>3.789</i>	101,8 <i>4.008</i>	10,0 <i>0.394</i>	10.00X8.00	8,5 <i>0.335</i>	3	C

T32-R40NC

Blind holes – Metric coarse threads, 6G

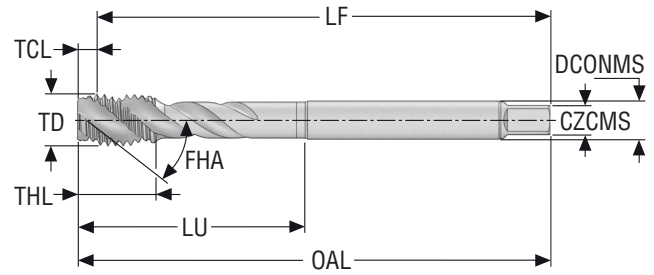

- Substrate: HSSE
- Coating: TiAlN + TiN
- Standard: DIN376
- Thread tolerance class: 6G
- FHA = 40°
- For cutting data see page(s) 261

Designation	Item number	TDZ	Pitch	TCL	THL	LU	LF	OAL	DCONMS	CZCMS	PHDR Ø	NOF	THCT
			mm	mm <i>Inch</i>	mm <i>Inch</i>	mm <i>Inch</i>	mm <i>Inch</i>	mm <i>Inch</i>	mm <i>Inch</i>	mm <i>Inch</i>	mm <i>Inch</i>		
T32-R40N01C06-12X1.75-61R	10139649	M12	1,75	4,41 <i>0.174</i>	18,0 <i>0.709</i>	83 <i>3.268</i>	105,59 <i>4.157</i>	110,0 <i>4.331</i>	9,0 <i>0.354</i>	9.00X7.00	10,2 <i>0.402</i>	3	C
T32-R40N01C06-16X2-61R	10139650	M16	2,0	5,15 <i>0.203</i>	20,0 <i>0.787</i>	81 <i>3.189</i>	104,85 <i>4.128</i>	110,0 <i>4.331</i>	11,0 <i>0.433</i>	11.00X9.00	14,0 <i>0.551</i>	4	C
T32-R40N01C06-20X2.5-61R	10139651	M20	2,5	6,51 <i>0.256</i>	25,0 <i>0.984</i>	95 <i>3.740</i>	133,49 <i>5.256</i>	140,0 <i>5.512</i>	16,0 <i>0.630</i>	16.00X12.00	17,5 <i>0.689</i>	4	C

Thread turning

MDT

Mini-Shaft™

Thread milling

Thread tapping

Annex

T32-R40NC

Blind holes – Metric coarse threads, left hand thread

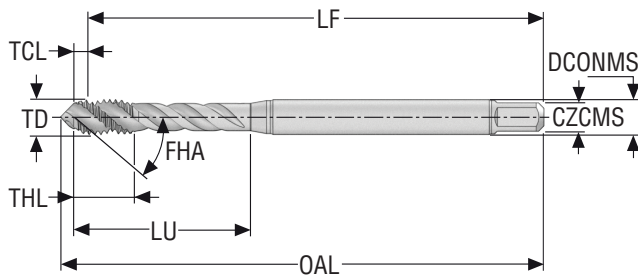

- Substrate: HSSE
- Coating: TiAlN + TiN
- Standard: DIN371
- Thread tolerance class: 6H
- FHA = 40°
- For cutting data see page(s) 261

Designation	Item number	TDZ	Pitch	TCL	THL	LU	LF	OAL	DCONMS	CZCMS	PHDR Ø	NOF	THCHT
			mm	mm <i>Inch</i>	mm <i>Inch</i>	mm <i>Inch</i>	mm <i>Inch</i>	mm <i>Inch</i>	mm <i>Inch</i>	mm <i>Inch</i>	mm <i>Inch</i>		
T32-L40N01C03-3X0.5-63L	10139167	M3	0,5	1,2 <i>0.047</i>	5,0 <i>0.197</i>	18 <i>0.709</i>	54,8 <i>2.157</i>	57,2 <i>2.252</i>	3,5 <i>0.138</i>	3.50X2.70	2,5 <i>0.098</i>	3	C
T32-L40N01C03-4X0.7-63L	10139168	M4	0,7	1,54 <i>0.061</i>	7,0 <i>0.276</i>	21 <i>0.827</i>	61,46 <i>2.420</i>	64,6 <i>2.543</i>	4,5 <i>0.177</i>	4.50X3.40	3,3 <i>0.130</i>	3	C
T32-L40N01C03-5X0.8-63L	10139169	M5	0,8	1,9 <i>0.075</i>	8,0 <i>0.315</i>	25 <i>0.984</i>	68,1 <i>2.681</i>	72,0 <i>2.835</i>	6,0 <i>0.236</i>	6.00X4.90	4,2 <i>0.165</i>	3	C
T32-L40N01C03-6X1-63L	10139170	M6	1,0	2,28 <i>0.090</i>	10,0 <i>0.394</i>	30 <i>1.181</i>	77,72 <i>3.060</i>	82,4 <i>3.244</i>	6,0 <i>0.236</i>	6.00X4.90	5,0 <i>0.197</i>	3	C
T32-L40N01C03-8X1.25-63L	10139171	M8	1,25	3,11 <i>0.122</i>	13,0 <i>0.512</i>	35 <i>1.378</i>	86,89 <i>3.421</i>	91,7 <i>3.610</i>	8,0 <i>0.315</i>	8.00X6.20	6,8 <i>0.268</i>	3	C
T32-L40N01C03-10X1.5-63L	10139172	M10	1,5	3,76 <i>0.148</i>	15,0 <i>0.591</i>	39 <i>1.535</i>	96,24 <i>3.789</i>	101,8 <i>4.008</i>	10,0 <i>0.394</i>	10.00X8.00	8,5 <i>0.335</i>	3	C

T32-R40NC

Blind holes – Metric coarse threads, left hand thread

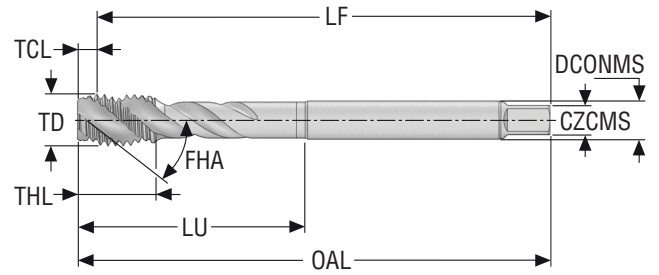

- Substrate: HSSE
- Coating: TiAlN + TiN
- Standard: DIN376
- Thread tolerance class: 6H
- FHA = 40°
- For cutting data see page(s) 261

Designation	Item number	TDZ	Pitch	TCL	THL	LU	LF	OAL	DCONMS	CZCMS	PHDR Ø	NOF	THCT
			mm	mm <i>Inch</i>	mm <i>Inch</i>	mm <i>Inch</i>	mm <i>Inch</i>	mm <i>Inch</i>	mm <i>Inch</i>	mm <i>Inch</i>	mm <i>Inch</i>		
T32-L40N01C06-12X1.75-63L	10139645	M12	1,75	4,41 0.174	18,0 0.709	83 3.268	105,59 4.157	110,0 4.331	9,0 0.354	9.00X7.00	10,2 0.402	3	C
T32-L40N01C06-16X2-63L	10139646	M16	2,0	5,15 0.203	20,0 0.787	68 2.677	104,85 4.128	110,0 4.331	12,0 0.472	12.00X9.00	14,0 0.551	4	C
T32-L40N01C06-20X2.5-63L	10139647	M20	2,5	6,51 0.256	25,0 0.984	95 3.740	133,49 5.256	140,0 5.512	16,0 0.630	16.00X12.00	17,5 0.689	4	C
T32-L40N01C06-24X3-63L	10139648	M24	3,0	7,81 0.307	30,0 1.181	113 4.449	152,19 5.992	160,0 6.299	18,0 0.709	18.00X14.50	21,0 0.827	4	C

Thread turning

MDT

Mini-Shaft™

Thread milling

Thread tapping

Annex

T32-R40NC

Blind holes – MF threads

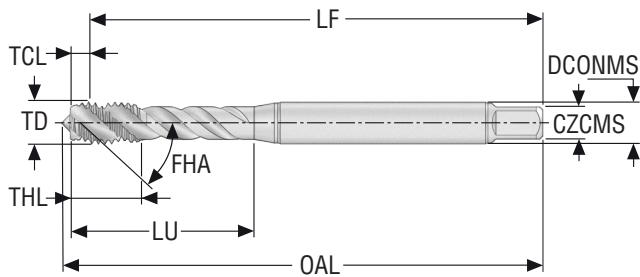

- Substrate: HSSE
- Coating: TiAlN + TiN
- Standard: DIN371
- Thread tolerance class: 6H
- FHA = 40°
- For cutting data see page(s) 261

Designation	Item number	TDZ	Pitch	TCL	THL	LU	LF	OAL	DCONMS	CZCMS	PHDR Ø	NOF	THCT
			mm	mm	mm	mm	mm	mm	mm	mm	mm		
			Inch	Inch	Inch	Inch	Inch	Inch	Inch	Inch	Inch		
T32-R40N02C03-8X1-63R	10139150	MF8X1.0	1,0	2,58 0.102	13,0 0.512	35 1.378	87,42 3.442	91,7 3.610	8,0 0.315	8.00X6.20	7,0 0.276	3	C
T32-R40N02C03-10X1-63R	10139151	MF10X1.0	1,0	2,68 0.106	13,0 0.512	35 1.378	87,32 3.438	90,0 3.543	10,0 0.394	10.00X8.00	9,0 0.354	3	C
T32-R40N02C03-10X1.25-63R	10139152	MF10X1.25	1,25	3,21 0.126	15,0 0.591	39 1.535	96,79 3.811	101,8 4.008	10,0 0.394	10.00X8.00	8,8 0.346	3	C

Thread turning

MDT

Mini-Shaft™

Thread milling

Thread tapping

Annex

T32-R40NC

Blind holes – MF threads

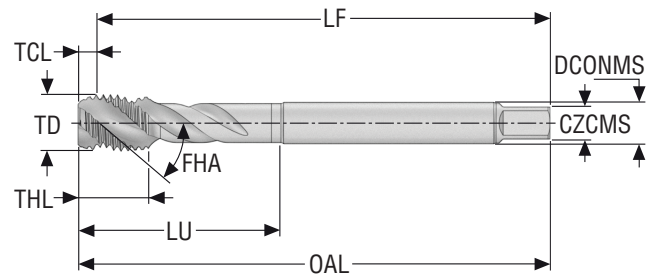

- Substrate: HSSE
- Coating: TiAlN + TiN
- Standard: DIN374
- Thread tolerance class: 6H
- FHA = 40°
- For cutting data see page(s) 261

Designation	Item number	TDZ	Pitch	TCL	THL	LU	LF	OAL	DCONMS	CZCMS	PHD Ø	NOF	THCT
			mm	mm <i>Inch</i>	mm <i>Inch</i>	mm <i>Inch</i>	mm <i>Inch</i>	mm <i>Inch</i>	mm <i>Inch</i>	mm <i>Inch</i>	mm <i>Inch</i>		
T32-R40N02C05-8X1-63R	10139593	MF8X1.0	1,0	2,58 <i>0.102</i>	10,0 <i>0.394</i>	67 <i>2.638</i>	87,42 <i>3.442</i>	90,0 <i>3.543</i>	6,0 <i>0.236</i>	6.00X4.90	7,0 <i>0.276</i>	3	C
T32-R40N02C05-10X0.75-63R	10139594	MF10X0.75	0,75	2,13 <i>0.084</i>	10,0 <i>0.394</i>	67 <i>2.638</i>	87,87 <i>3.459</i>	90,0 <i>3.543</i>	7,0 <i>0.276</i>	7.00X5.50	9,2 <i>0.362</i>	3	C
T32-R40N02C05-10X1-63R	10139595	MF10X1.0	1,0	2,68 <i>0.106</i>	13,0 <i>0.512</i>	67 <i>2.638</i>	87,32 <i>3.438</i>	90,0 <i>3.543</i>	7,0 <i>0.276</i>	7.00X5.50	9,0 <i>0.354</i>	3	C
T32-R40N02C05-10X1.25-63R	10139596	MF10X1.25	1,25	3,21 <i>0.126</i>	15,0 <i>0.591</i>	77 <i>3.031</i>	96,79 <i>3.811</i>	100,0 <i>3.937</i>	7,0 <i>0.276</i>	7.00X5.50	8,8 <i>0.346</i>	3	C
T32-R40N02C05-12X1-63R	10139597	MF12X1.0	1,0	2,79 <i>0.110</i>	10,0 <i>0.394</i>	73 <i>2.874</i>	97,21 <i>3.827</i>	100,0 <i>3.937</i>	9,0 <i>0.354</i>	9.00X7.00	11,0 <i>0.433</i>	3	C
T32-R40N02C05-12X1.25-63R	10139598	MF12X1.25	1,25	3,34 <i>0.131</i>	15,0 <i>0.591</i>	73 <i>2.874</i>	96,66 <i>3.806</i>	100,0 <i>3.937</i>	9,0 <i>0.354</i>	9.00X7.00	10,8 <i>0.425</i>	3	C
T32-R40N02C05-12X1.5-63R	10139599	MF12X1.5	1,5	3,87 <i>0.152</i>	15,0 <i>0.591</i>	73 <i>2.874</i>	96,13 <i>3.785</i>	100,0 <i>3.937</i>	9,0 <i>0.354</i>	9.00X7.00	10,5 <i>0.413</i>	3	C
T32-R40N02C05-14X1-63R	10139600	MF14X1.0	1,0	2,89 <i>0.114</i>	10,0 <i>0.394</i>	71 <i>2.795</i>	97,11 <i>3.823</i>	100,0 <i>3.937</i>	11,0 <i>0.433</i>	11.00X9.00	13,0 <i>0.512</i>	4	C
T32-R40N02C05-14X1.25-63R	10139601	MF14X1.25	1,25	3,44 <i>0.135</i>	15,0 <i>0.591</i>	71 <i>2.795</i>	96,56 <i>3.802</i>	100,0 <i>3.937</i>	11,0 <i>0.433</i>	11.00X9.00	12,8 <i>0.504</i>	4	C
T32-R40N02C05-14X1.5-63R	10139602	MF14X1.5	1,5	3,97 <i>0.156</i>	15,0 <i>0.591</i>	71 <i>2.795</i>	96,03 <i>3.781</i>	100,0 <i>3.937</i>	11,0 <i>0.433</i>	11.00X9.00	12,5 <i>0.492</i>	4	C
T32-R40N02C05-16X1-63R	10139603	MF16X1.0	1,0	2,79 <i>0.110</i>	10,0 <i>0.394</i>	58 <i>2.283</i>	97,21 <i>3.827</i>	100,0 <i>3.937</i>	12,0 <i>0.472</i>	12.00X9.00	15,0 <i>0.591</i>	4	C
T32-R40N02C05-16X1.5-63R	10139604	MF16X1.5	1,5	4,07 <i>0.160</i>	15,0 <i>0.591</i>	58 <i>2.283</i>	95,93 <i>3.777</i>	100,0 <i>3.937</i>	12,0 <i>0.472</i>	12.00X9.00	14,5 <i>0.571</i>	4	C
T32-R40N02C05-18X1.5-63R	10139605	MF18X1.5	1,5	4,17 <i>0.164</i>	17,0 <i>0.669</i>	66 <i>2.598</i>	105,83 <i>4.167</i>	110,0 <i>4.331</i>	14,0 <i>0.551</i>	14.00X11.00	16,5 <i>0.650</i>	4	C
T32-R40N02C05-18X2-63R	10139606	MF18X2.0	2,0	5,25 <i>0.207</i>	20,0 <i>0.787</i>	81 <i>3.189</i>	119,75 <i>4.715</i>	125,0 <i>4.921</i>	14,0 <i>0.551</i>	14.00X11.00	16,0 <i>0.630</i>	4	C
T32-R40N02C05-20X1.5-63R	10139607	MF20X1.5	1,5	4,37 <i>0.172</i>	17,0 <i>0.669</i>	80 <i>3.150</i>	120,63 <i>4.749</i>	125,0 <i>4.921</i>	16,0 <i>0.630</i>	16.00X12.00	18,5 <i>0.728</i>	4	C
T32-R40N02C05-20X2-63R	10139608	MF20X2.0	2,0	5,45 <i>0.215</i>	20,0 <i>0.787</i>	95 <i>3.740</i>	134,55 <i>5.297</i>	140,0 <i>5.512</i>	16,0 <i>0.630</i>	16.00X12.00	18,0 <i>0.709</i>	4	C
T32-R40N02C05-22X1.5-63R	10139609	MF22X1.5	1,5	4,37 <i>0.172</i>	17,0 <i>0.669</i>	78 <i>3.071</i>	120,63 <i>4.749</i>	125,0 <i>4.921</i>	18,0 <i>0.709</i>	18.00X14.50	20,5 <i>0.807</i>	4	C
T32-R40N02C05-22X2-63R	10139610	MF22X2.0	2,0	5,45 <i>0.215</i>	20,0 <i>0.787</i>	93 <i>3.661</i>	134,55 <i>5.297</i>	140,0 <i>5.512</i>	18,0 <i>0.709</i>	18.00X14.50	20,0 <i>0.787</i>	4	C
T32-R40N02C05-24X1.5-63R	10139611	MF24X1.5	1,5	4,39 <i>0.173</i>	20,0 <i>0.787</i>	93 <i>3.661</i>	135,61 <i>5.339</i>	140,0 <i>5.512</i>	18,0 <i>0.709</i>	18.00X14.50	22,5 <i>0.886</i>	4	C
T32-R40N02C05-24X2-63R	10139612	MF24X2.0	2,0	5,67 <i>0.223</i>	20,0 <i>0.787</i>	93 <i>3.661</i>	134,33 <i>5.289</i>	140,0 <i>5.512</i>	18,0 <i>0.709</i>	18.00X14.50	22,0 <i>0.866</i>	4	C

Designation	Item number	TDZ	Pitch	TCL	THL	LU	LF	OAL	DCONMS	CZCMS	PHDR Ø	NOF	THCHT
			mm	mm <i>Inch</i>	mm <i>Inch</i>	mm <i>Inch</i>	mm <i>Inch</i>	mm <i>Inch</i>	mm <i>Inch</i>	mm <i>Inch</i>	mm <i>Inch</i>		
T32-R40N02C05-27X1.5-63R	10139613	MF27X1.5	1,5	4,59 <i>0.181</i>	20,0 <i>0.787</i>	77 <i>3.031</i>	135,41 <i>5.331</i>	140,0 <i>5.512</i>	20,0 <i>0.787</i>	20.00X16.00	25,5 <i>1.004</i>	4	C
T32-R40N02C05-27X2-63R	10139614	MF27X2.0	2,0	5,67 <i>0.223</i>	20,0 <i>0.787</i>	77 <i>3.031</i>	134,33 <i>5.289</i>	140,0 <i>5.512</i>	20,0 <i>0.787</i>	20.00X16.00	25,0 <i>0.984</i>	4	C
T32-R40N02C05-30X1.5-63R	10139615	MF30X1.5	1,5	4,19 <i>0.165</i>	22,0 <i>0.866</i>	85 <i>3.346</i>	145,81 <i>5.741</i>	150,0 <i>5.906</i>	22,0 <i>0.866</i>	22.00X18.00	28,5 <i>1.122</i>	4	C
T32-R40N02C05-30X2-63R	10139616	MF30X1.0	2,0	5,67 <i>0.223</i>	22,0 <i>0.866</i>	85 <i>3.346</i>	144,33 <i>5.682</i>	150,0 <i>5.906</i>	22,0 <i>0.866</i>	22.00X18.00	28,0 <i>1.102</i>	4	C

Thread turning

MDT

Mini-Shaft™

Thread milling

Thread tapping

Annex

T32-R40NC

Blind holes – UNC threads

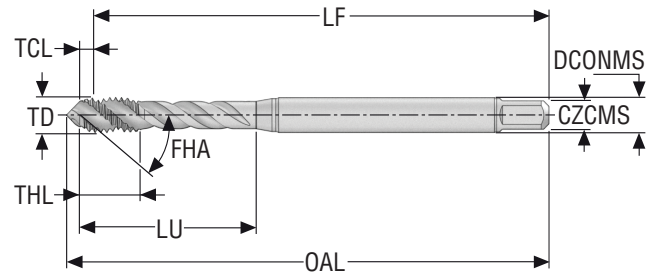

- Substrate: HSSE
- Coating: TiAlN + TiN
- Standard: DIN371
- Thread tolerance class: 2B
- FHA = 40°
- For cutting data see page(s) 261

Designation	Item number	TDZ	TD	Pitch	TCL	THL	LU	LF	OAL	DCONMS	CZCMS	PHDR Ø	NOF	THCHT
			mm Inch	TPI	mm Inch	mm Inch	mm Inch	mm Inch	mm Inch	mm Inch	mm Inch	mm Inch		
T32-R40N08C03-4-40-21R	10139153	UNC4-40	2,845 0.112	40.0	1,45 0.057	5,0 0.197	18 0.709	54,55 2.148	56,0 2.205	3,5 0.138	3.50X2.70	2,35 0.093	3	C
T32-R40N08C03-5-40-21R	10139154	UNC5-40	3,175 0.125	40.0	1,5 0.059	7,0 0.276	18 0.709	54,5 2.146	57,2 2.252	3,5 0.138	3.50X2.70	2,65 0.104	3	C
T32-R40N08C03-6-32-21R	10139155	UNC6-32	3,505 0.138	32.0	1,92 0.076	6,0 0.236	20 0.787	54,08 2.129	57,4 2.260	4,0 0.157	4.00X3.00	2,85 0.112	3	C
T32-R40N08C03-8-32-21R	10139156	UNC8-32	4,166 0.164	32.0	1,85 0.073	7,0 0.276	21 0.827	61,15 2.407	64,6 2.543	4,5 0.177	4.50X3.40	3,5 0.138	3	C
T32-R40N08C03-10-24-21R	10139157	UNC10-24	4,826 0.190	24.0	2,49 0.098	8,0 0.315	25 0.984	67,51 2.658	72,0 2.835	6,0 0.236	6.00X4.90	3,9 0.154	3	C
T32-R40N08C03-12-24-21R	10139158	UNC12-24	5,486 0.216	24.0	2,43 0.096	10,0 0.394	30 1.181	77,57 3.054	82,2 3.236	6,0 0.236	6.00X4.90	4,5 0.177	3	C
T32-R40N08C03-1/4-20-21R	10139159	UNC1/4-20	6,35 0.250	20.0	2,9 0.114	13,0 0.512	32 1.260	77,1 3.035	82,4 3.244	7,0 0.276	7.00X5.50	5,1 0.201	3	C
T32-R40N08C03-5/16-18-21R	10139160	UNC5/16-18	7,937 0.312	18.0	3,54 0.139	13,0 0.512	35 1.378	86,46 3.404	90,0 3.543	8,0 0.315	8.00X6.20	6,6 0.260	3	C
T32-R40N08C03-3/8-16-21R	10139161	UNC3/8-16	9,525 0.375	16.0	3,99 0.157	15,0 0.591	39 1.535	96,01 3.780	100,0 3.937	10,0 0.394	10.00X8.00	8,0 0.315	3	C

Thread turning

MDT

Mini-Shaft™

Thread milling

Thread tapping

Annex

T32-R40NC

Blind holes – UNC threads

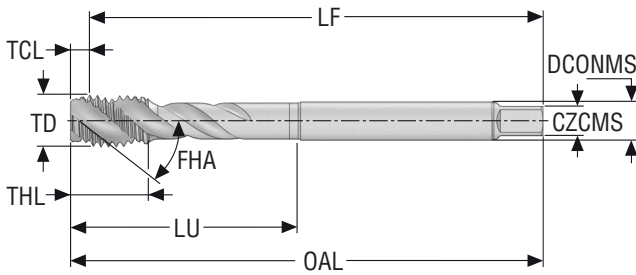

- Substrate: HSSE
- Coating: TiAlN + TiN
- Standard: DIN376
- Thread tolerance class: 2B
- FHA = 40°
- For cutting data see page(s) 261

Designation	Item number	TDZ	TD	Pitch	TCL	THL	LU	LF	OAL	DCONMS	CZCMS	PHDR Ø	NOF	THCHT
			mm Inch	TPI	mm Inch	mm Inch	mm Inch	mm Inch	mm Inch	mm Inch	mm Inch	mm Inch		
T32-R40N08C06-7/16-14-21R	10139617	UNC7/16-14	11,112 0.437	14.0	4,6 0.181	15,0 0.591	76 2.992	95,4 3.756	100,0 3.937	8,0 0.315	8.00X6.20	9,3 0.366	3	C
T32-R40N08C06-1/2-13-21R	10139626	UNC1/2-13	12,7 0.500	13.0	4,94 0.194	18,0 0.709	83 3.268	105,06 4.136	110,0 4.331	9,0 0.354	9.00X7.00	10,7 0.421	4	C
T32-R40N08C06-9/16-12-21R	10139619	UNC9/16-12	14,287 0.562	12.0	5,37 0.211	20,0 0.787	81 3.189	104,63 4.119	110,0 4.331	11,0 0.433	11.00X9.00	12,3 0.484	4	C
T32-R40N08C06-5/8-11-21R	10139620	UNC5/8-11	15,875 0.625	11.0	5,81 0.229	22,0 0.866	68 2.677	104,19 4.102	110,0 4.331	12,0 0.472	12.00X9.00	13,5 0.531	4	C
T32-R40N08C06-3/4-10-21R	10139621	UNC3/4-10	19,05 0.750	10.0	6,78 0.267	25,0 0.984	81 3.189	118,22 4.654	125,0 4.921	14,0 0.551	14.00X11.00	16,5 0.650	4	C
T32-R40N08C06-7/8-9-21R	10139622	UNC7/8-9	22,225 0.875	9.0	7,27 0.286	30,0 1.181	93 3.661	132,73 5.226	140,0 5.512	18,0 0.709	18.00X14.50	19,5 0.768	4	C
T32-R40N08C06-1-8-21R	10139623	UNC1-8	25,4 1.000	8.0	8,32 0.328	30,0 1.181	97 3.819	151,68 5.972	160,0 6.299	20,0 0.787	20.00X16.00	22,25 0.876	4	C
T32-R40N08C06-1_1/8-7-21R	10139758	UNC1 1/8-7	28,575 1.125	7.0	9,17 0.361	37,0 1.457	115 4.528	170,83 6.726	180,0 7.087	22,0 0.866	22.00X18.00	25,0 0.984	4	C
T32-R40N08C06-1_1/4-7-21R	10139624	UNC1 1/4-7	31,75 1.250	7.0	9,3 0.366	37,0 1.457	115 4.528	170,7 6.720	180,0 7.087	22,0 0.866	22.00X18.00	28,0 1.102	4	C
T32-R40N08C06-1_3/8-6-21R	10139618	UNC1 3/8-6	34,925 1.375	6.0	10,5 0.413	40,0 1.575	131 5.157	189,5 7.461	200,0 7.874	28,0 1.102	28.00X22.00	30,75 1.211	4	C
T32-R40N08C06-1_1/2-6-21R	10139625	UNC1 1/2-6	38,1 1.500	6.0	10,63 0.419	40,0 1.575	131 5.157	189,37 7.456	200,0 7.874	28,0 1.102	28.00X22.00	34,0 1.339	4	C

Thread turning

MDT

Mini-Shaft™

Thread milling

Thread tapping

Annex

T32-R40NC

Blind holes – UNF threads

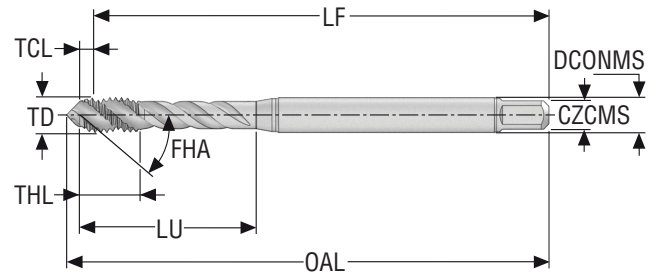

- Substrate: HSSE
- Coating: TiAlN + TiN
- Standard: DIN371
- Thread tolerance class: 2B
- FHA = 40°
- For cutting data see page(s) 261

Designation	Item number	TDZ	TD	Pitch	TCL	THL	LU	LF	OAL	DCONMS	CZCMS	PHDR Ø	NOF	THCHT
			mm Inch	TPI	mm Inch	mm Inch	mm Inch	mm Inch	mm Inch	mm Inch	mm Inch	mm Inch		
T32-R40N09C03-10-32-21R	10139162	UNF10-32	4,826 0.190	32.0	1,96 0.077	8,0 0.315	25 0.984	68,04 2.679	72,0 2.835	6,0 0.236	6.00X4.90	4,1 0.161	3	C
T32-R40N09C03-12-28-21R	10139163	UNF12-28	5,486 0.216	28.0	2,07 0.081	10,0 0.394	30 1.181	77,93 3.068	82,4 3.244	6,0 0.236	6.00X4.90	4,6 0.181	3	C
T32-R40N09C03-1/4-28-21R	10139164	UNF1/4-28	6,35 0.250	28.0	2,19 0.086	10,0 0.394	30 1.181	77,81 3.063	82,4 3.244	7,0 0.276	7.00X5.50	5,5 0.217	3	C
T32-R40N09C03-5/16-24-21R	10139165	UNF5/16-24	7,937 0.312	24.0	2,83 0.111	13,0 0.512	35 1.378	87,17 3.432	90,0 3.543	8,0 0.315	8.00X6.20	6,9 0.272	3	C
T32-R40N09C03-3/8-24-21R	10139166	UNF3/8-24	9,525 0.375	24.0	2,91 0.115	15,0 0.591	35 1.378	87,09 3.429	90,0 3.543	10,0 0.394	10.00X8.00	8,5 0.335	3	C

Thread turning

MDT

Mini-Shaft™

Thread milling

Thread tapping

Annex

T32-R40NC

Blind holes – UNF threads

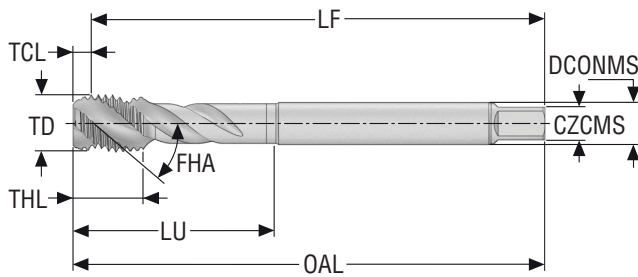

- Substrate: HSSE
- Coating: TiAlN + TiN
- Standard: DIN374
- Thread tolerance class: 2B
- FHA = 40°
- For cutting data see page(s) 261

Designation	Item number	TDZ	TD	Pitch	TCL	THL	LU	LF	OAL	DCONMS	CZCMS	PHDR Ø	NOF	THCHT
			mm Inch	TPI	mm Inch	mm Inch	mm Inch	mm Inch	mm Inch	mm Inch	mm Inch	mm Inch		
T32-R40N09C05-7/16-20-21R	10139627	UNF7/16-20	11,112 0.437	20.0	3,35 0.132	15,0 0.591	76 2.992	96,65 3.805	100,0 3.937	8,0 0.315	8.00X6.20	9,9 0.390	3	C
T32-R40N09C05-1/2-20-21R	10139636	UNF1/2-20	12,7 0.500	20.0	3,51 0.138	15,0 0.591	73 2.874	96,49 3.799	100,0 3.937	9,0 0.354	9.00X7.00	11,5 0.453	4	C
T32-R40N09C05-9/16-18-21R	10139629	UNF9/16-18	14,287 0.562	18.0	3,77 0.148	15,0 0.591	71 2.795	96,23 3.789	100,0 3.937	11,0 0.433	11.00X9.00	13,0 0.512	4	C
T32-R40N09C05-5/8-18-21R	10139630	UNF5/8-18	15,875 0.625	18.0	3,86 0.152	15,0 0.591	58 2.283	96,14 3.785	100,0 3.937	12,0 0.472	12.00X9.00	14,5 0.571	4	C
T32-R40N09C05-3/4-16-21R	10139631	UNF3/4-16	19,05 0.750	16.0	4,45 0.175	17,0 0.669	66 2.598	105,55 4.156	110,0 4.331	14,0 0.551	14.00X11.00	17,5 0.689	4	C
T32-R40N09C05-7/8-14-21R	10139632	UNF7/8-14	22,225 0.875	14.0	5,15 0.203	17,0 0.669	78 3.071	119,85 4.719	125,0 4.921	18,0 0.709	18.00X14.50	20,5 0.807	4	C
T32-R40N09C05-1-12-21R	10139633	UNF1-12	25,4 1.000	12.0	5,82 0.229	22,0 0.866	93 3.661	134,18 5.283	140,0 5.512	18,0 0.709	18.00X14.50	23,3 0.917	4	C
T32-R40N09C05-1_1/8-12-21R	10139759	UNF1 1/8-12	28,575 1.125	12.0	5,98 0.235	22,0 0.866	85 3.346	144,02 5.670	150,0 5.906	22,0 0.866	22.00X18.00	26,5 1.043	4	C
T32-R40N09C05-1_1/4-12-21R	10139634	UNF1 1/4-12	31,75 1.250	12.0	5,94 0.234	22,0 0.866	85 3.346	144,06 5.672	150,0 5.906	22,0 0.866	22.00X18.00	29,5 1.161	4	C
T32-R40N09C05-1_3/8-12-21R	10139628	UNF1 3/8-12	34,925 1.375	12.0	6,07 0.239	22,0 0.866	101 3.976	163,93 6.454	170,0 6.693	28,0 1.102	28.00X22.00	32,8 1.291	4	C
T32-R40N09C05-1_1/2-12-21R	10139635	UNF1 1/2-12	38,1 1.500	12.0	6,04 0.238	24,0 0.945	101 3.976	163,96 6.455	170,0 6.693	28,0 1.102	28.00X22.00	36,0 1.417	4	C

Thread turning

MDT

Mini-Shaft™

Thread milling

Thread tapping

Annex

T32-R40NC

Blind holes – G threads

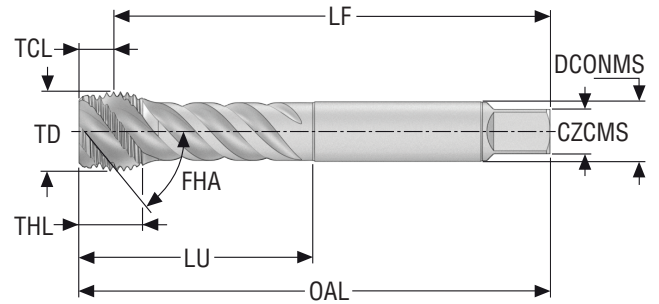

- Substrate: HSSE
- Coating: TiAlN + TiN
- Standard: DIN5156
- Thread tolerance class: NORMAL
- FHA = 40°
- For cutting data see page(s) 261

Designation	Item number	TDZ	TD	Pitch	TCL	THL	LU	LF	OAL	DCONMS	CZCMS	PHDR Ø	NOF	THCHT
			mm Inch	TPI	mm Inch	mm Inch	mm Inch	mm Inch	mm Inch	mm Inch	mm Inch	mm Inch		
T32-R40N21C09-1/8-28-11R	10139637	G1/8-28	9,728 0.383	28.0	2,67 0.105	10,0 0.394	67 2.638	87,33 3.438	90,0 3.543	7,0 0.276	7.00X5.50	8,8 0.346	3	C
T32-R40N21C09-1/4-19-11R	10139638	G1/4-19	13,157 0.518	19.0	3,72 0.146	14,0 0.551	71 2.795	96,28 3.791	100,0 3.937	11,0 0.433	11.00X9.00	11,8 0.465	3	C
T32-R40N21C09-3/8-19-11R	10139639	G3/8-19	16,662 0.656	19.0	3,92 0.154	15,0 0.591	58 2.283	96,08 3.783	100,0 3.937	12,0 0.472	12.00X9.00	15,25 0.600	4	C
T32-R40N21C09-1/2-14-11R	10139640	G1/2-14	20,955 0.825	14.0	5,28 0.208	17,0 0.669	80 3.150	119,72 4.713	125,0 4.921	16,0 0.630	16.00X12.00	19,0 0.748	4	C
T32-R40N21C09-5/8-14-11R	10139641	G5/8-14	22,911 0.902	14.0	5,21 0.205	20,0 0.787	78 3.071	119,79 4.716	125,0 4.921	18,0 0.709	18.00X14.50	21,0 0.827	4	C
T32-R40N21C09-3/4-14-11R	10139642	G3/4-14	26,441 1.041	14.0	5,45 0.215	20,0 0.787	77 3.031	134,55 5.297	140,0 5.512	20,0 0.787	20.00X16.00	24,5 0.965	4	C
T32-R40N21C09-7/8-14-11R	10139643	G7/8-14	30,201 1.189	14.0	5,38 0.212	22,0 0.866	85 3.346	144,62 5.694	150,0 5.906	22,0 0.866	22.00X18.00	28,25 1.112	4	C
T32-R40N21C09-1-11-11R	10139644	G1-11	33,249 1.309	11.0	6,56 0.258	24,0 0.945	93 3.661	153,44 6.041	160,0 6.299	25,0 0.984	25.00X20.00	30,75 1.211	4	C

Thread turning

MDT

Mini-Shaft™

Thread milling

Thread tapping

Annex

T34-PHB-micro

Through holes – Metric coarse threads

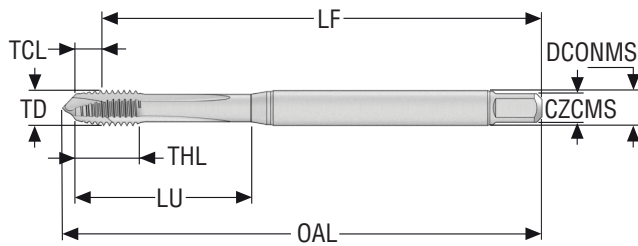

- Substrate: HSS-PM
- Coating: TiAlN + WC/C
- Standard: DIN371
- Thread tolerance class: 4H
- For cutting data see page(s) 263

Designation	Item number	TDZ	Pitch	TCL	THL	LU	LF	OAL	DCONMS	CZCMS	PHDR Ø	NOF	THCHT
			mm	mm <i>Inch</i>	mm <i>Inch</i>	mm <i>Inch</i>	mm <i>Inch</i>	mm <i>Inch</i>	mm <i>Inch</i>	mm <i>Inch</i>	mm <i>Inch</i>		
T34-PH01B03-1X0.25-41R	10139302	M1	0,25	1,13 <i>0.044</i>	6,0 <i>0.236</i>	13 <i>0.512</i>	38,87 <i>1.530</i>	40,9 <i>1.610</i>	2,5 <i>0.098</i>	2.50X2.10	0,75 <i>0.030</i>	2	B
T34-PH01B03-1.1X0.25-41R	10139303	M1.1	0,25	1,13 <i>0.044</i>	6,0 <i>0.236</i>	13 <i>0.512</i>	38,87 <i>1.530</i>	41,0 <i>1.614</i>	2,5 <i>0.098</i>	2.50X2.10	0,85 <i>0.033</i>	2	B
T34-PH01B03-1.2X0.25-41R	10139304	M1.2	0,25	1,13 <i>0.044</i>	6,0 <i>0.236</i>	13 <i>0.512</i>	38,87 <i>1.530</i>	41,1 <i>1.618</i>	2,5 <i>0.098</i>	2.50X2.10	0,95 <i>0.037</i>	2	B
T34-PH01B03-1.4X0.3-41R	10139305	M1.4	0,3	1,32 <i>0.052</i>	8,0 <i>0.315</i>	13 <i>0.512</i>	38,68 <i>1.523</i>	41,3 <i>1.626</i>	2,5 <i>0.098</i>	2.50X2.10	1,1 <i>0.043</i>	2	B

Thread turning

MDT

Mini-Shaft™

Thread milling

Thread tapping

Annex

T34-PHB-micro

Through holes – Metric coarse threads

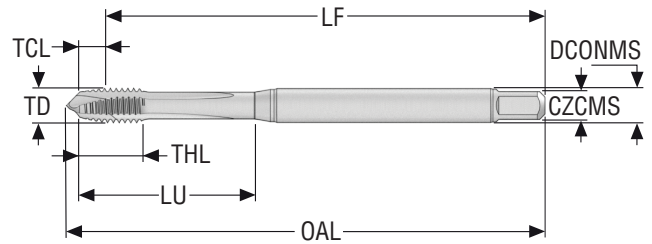

- Substrate: HSS-PM
- Coating: TiAlN + WC/C
- Standard: DIN371
- Thread tolerance class: 6H
- For cutting data see page(s) 263

Designation	Item number	TDZ	Pitch	TCL	THL	LU	LF	OAL	DCONMS	CZCMS	PHDR Ø	NOF	THCHT
			mm	mm <i>Inch</i>	mm <i>Inch</i>	mm <i>Inch</i>	mm <i>Inch</i>	mm <i>Inch</i>	mm <i>Inch</i>		mm <i>Inch</i>		
T34-PH01B03-1.6X0.35-63R	10139306	M1.6	0,35	1,54 <i>0.061</i>	8,0 <i>0.315</i>	13 <i>0.512</i>	38,46 <i>1.514</i>	41,4 <i>1.630</i>	2,5 <i>0.098</i>	2.50X2.10	1,25 <i>0.049</i>	2	B
T34-PH01B03-1.7X0.35-63R	10139307	M1.7	0,35	1,54 <i>0.061</i>	8,0 <i>0.315</i>	13 <i>0.512</i>	38,46 <i>1.514</i>	41,5 <i>1.634</i>	2,5 <i>0.098</i>	2.50X2.10	1,35 <i>0.053</i>	2	B
T34-PH01B03-1.8X0.35-63R	10139308	M1.8	0,35	1,54 <i>0.061</i>	8,0 <i>0.315</i>	13 <i>0.512</i>	38,46 <i>1.514</i>	41,6 <i>1.638</i>	2,5 <i>0.098</i>	2.50X2.10	1,45 <i>0.057</i>	2	B
T34-PH01B03-2X0.4-63R	10139309	M2	0,4	1,89 <i>0.074</i>	10,0 <i>0.394</i>	13 <i>0.512</i>	43,11 <i>1.697</i>	46,3 <i>1.823</i>	2,8 <i>0.110</i>	2.80X2.10	1,6 <i>0.063</i>	2	B
T34-PH01B03-2.2X0.45-63R	10139310	M2.2	0,45	2,07 <i>0.081</i>	10,0 <i>0.394</i>	13 <i>0.512</i>	42,93 <i>1.690</i>	46,3 <i>1.823</i>	2,8 <i>0.110</i>	2.80X2.10	1,75 <i>0.069</i>	2	B
T34-PH01B03-2.3X0.4-63R	10139311	M2.3	0,4	1,89 <i>0.074</i>	10,0 <i>0.394</i>	13 <i>0.512</i>	43,11 <i>1.697</i>	46,3 <i>1.823</i>	2,8 <i>0.110</i>	2.80X2.10	1,9 <i>0.075</i>	2	B
T34-PH01B03-2.5X0.45-63R	10139312	M2.5	0,45	2,07 <i>0.081</i>	9,0 <i>0.354</i>	14 <i>0.551</i>	47,93 <i>1.887</i>	51,7 <i>2.035</i>	2,8 <i>0.110</i>	2.80X2.10	2,05 <i>0.081</i>	2	B
T34-PH01B03-2.6X0.45-63R	10139313	M2.6	0,45	2,07 <i>0.081</i>	9,0 <i>0.354</i>	14 <i>0.551</i>	47,93 <i>1.887</i>	51,7 <i>2.035</i>	2,8 <i>0.110</i>	2.80X2.10	2,15 <i>0.085</i>	2	B

Thread turning

MDT

Mini-Shaft™

Thread milling

Thread tapping

Annex

T34-PHB

Through holes – Metric coarse threads

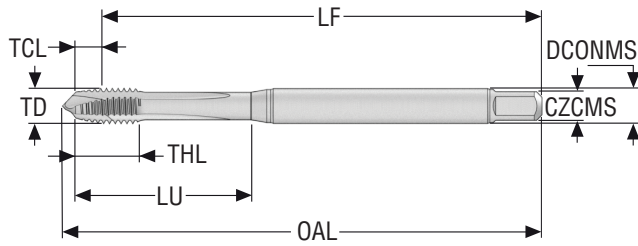

- Substrate: HSSE-PM
- Coating: TiAlN + WC/C
- Standard: DIN371
- Thread tolerance class: 6HX
- For cutting data see page(s) 263

Designation	Item number	TDZ	Pitch	TCL	THL	LU	LF	OAL	DCONMS	CZCMS	PHDR Ø	NOF	THCHT
				mm	mm	mm	mm	mm	mm	mm			
T34-PH01B03-3X0.5-65R	10139314	M3	0,5	2,3 0.091	5,0 0.197	18 0.709	53,7 2.114	57,2 2.252	3,5 0.138	3.50X2.70	2,5 0.098	3	B
T34-PH01B03-3.5X0.6-65R	10139315	M3.5	0,6	2,67 0.105	6,0 0.236	20 0.787	53,33 2.100	57,4 2.260	4,0 0.157	4.00X3.00	2,9 0.114	3	B
T34-PH01B03-4X0.7-65R	10139316	M4	0,7	3,03 0.119	7,0 0.276	21 0.827	59,97 2.361	64,6 2.543	4,5 0.177	4.50X3.40	3,3 0.130	3	B
T34-PH01B03-4.5X0.75-65R	10139317	M4.5	0,75	3,36 0.132	7,5 0.295	25 0.984	66,64 2.624	71,8 2.827	6,0 0.236	6.00X4.90	3,8 0.150	3	B
T34-PH01B03-5X0.8-65R	10139318	M5	0,8	3,71 0.146	8,0 0.315	25 0.984	66,29 2.610	72,0 2.835	6,0 0.236	6.00X4.90	4,2 0.165	3	B
T34-PH01B03-6X1-65R	10139319	M6	1,0	4,5 0.177	10,0 0.394	30 1.181	75,5 2.972	82,4 3.244	6,0 0.236	6.00X4.90	5,0 0.197	3	B
T34-PH01B03-8X1.25-65R	10139320	M8	1,25	5,48 0.216	13,0 0.512	35 1.378	84,52 3.328	93,3 3.673	8,0 0.315	8.00X6.20	6,8 0.268	3	B
T34-PH01B03-10X1.5-65R	10139321	M10	1,5	6,9 0.272	15,0 0.591	39 1.535	93,1 3.665	101,8 4.008	10,0 0.394	10.00X8.00	8,5 0.335	3	B

T34-PHB

Through holes – Metric coarse threads

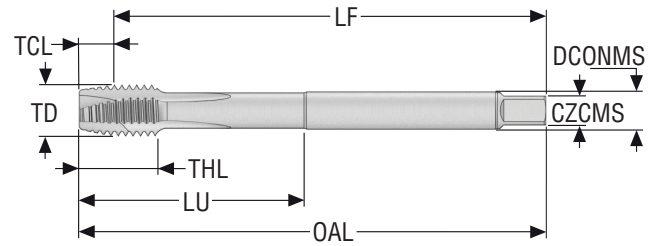

- Substrate: HSSE-PM
- Coating: TiAlN + WC/C
- Standard: DIN376
- Thread tolerance class: 6HX
- For cutting data see page(s) 263

Designation	Item number	TDZ	Pitch	TCL	THL	LU	LF	OAL	DCONMS	CZCMS	PHDR Ø	NOF	THCHT
			mm	mm Inch	mm Inch	mm Inch	mm Inch	mm Inch	mm Inch	mm Inch	mm Inch		
T34-PH01B06-12X1.75-65R	10139322	M12	1,75	8,11 0.319	18,0 0.709	83 3.268	101,89 4.011	110,0 4.331	9,0 0.354	9.00X7.00	10,2 0.402	3	B
T34-PH01B06-14X2-65R	10139323	M14	2,0	9,26 0.365	20,0 0.787	81 3.189	100,74 3.966	110,0 4.331	11,0 0.433	11.00X9.00	12,0 0.472	3	B
T34-PH01B06-16X2-65R	10139324	M16	2,0	9,36 0.369	20,0 0.787	68 2.677	100,64 3.962	110,0 4.331	12,0 0.472	12.00X9.00	14,0 0.551	3	B
T34-PH01B06-18X2.5-65R	10139325	M18	2,5	11,3 0.445	25,0 0.984	81 3.189	113,7 4.476	125,0 4.921	14,0 0.551	14.00X11.00	15,5 0.610	4	B
T34-PH01B06-20X2.5-65R	10139326	M20	2,5	11,4 0.449	25,0 0.984	95 3.740	128,6 5.063	140,0 5.512	16,0 0.630	16.00X12.00	17,5 0.689	4	B
T34-PH01B06-22X2.5-65R	10139327	M22	2,5	11,4 0.449	25,0 0.984	93 3.661	128,6 5.063	140,0 5.512	18,0 0.709	18.00X14.50	19,5 0.768	4	B
T34-PH01B06-24X3-65R	10139328	M24	3,0	13,62 0.536	30,0 1.181	113 4.449	146,38 5.763	160,0 6.299	18,0 0.709	18.00X14.50	21,0 0.827	4	B
T34-PH01B06-27X3-65R	10139329	M27	3,0	13,82 0.544	30,0 1.181	97 3.819	146,18 5.755	160,0 6.299	20,0 0.787	20.00X16.00	24,0 0.945	4	B
T34-PH01B06-30X3.5-65R	10139330	M30	3,5	15,87 0.625	35,0 1.378	115 4.528	164,13 6.462	180,0 7.087	22,0 0.866	22.00X18.00	26,5 1.043	4	B
T34-PH01B06-33X3.5-65R	10139331	M33	3,5	15,87 0.625	35,0 1.378	113 4.449	164,13 6.462	180,0 7.087	25,0 0.984	25.00X20.00	29,5 1.161	4	B
T34-PH01B06-36X4-65R	10139332	M36	4,0	18,13 0.714	40,0 1.575	131 5.157	181,87 7.160	200,0 7.874	28,0 1.102	28.00X22.00	32,0 1.260	4	B

Thread turning

MDT

Mini-Shaft™

Thread milling

Thread tapping

Annex

T34B-PHB

Through holes – Metric coarse threads

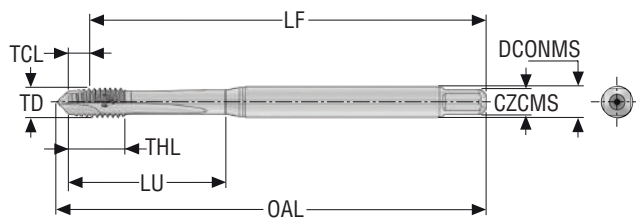

- Internal coolant
- Substrate: HSSE-PM
- Coating: TiAlN + WC/C
- Standard: DIN371
- Thread tolerance class: 6HX
- For cutting data see page(s) 263

Designation	Item number	TDZ	Pitch	TCL	THL	LU	LF	OAL	DCONMS	CZCMS	PHDR Ø	NOF	THCT
			mm	mm <i>Inch</i>	mm <i>Inch</i>	mm <i>Inch</i>	mm <i>Inch</i>	mm <i>Inch</i>	mm <i>Inch</i>	mm <i>Inch</i>	mm <i>Inch</i>		
T34B-PH01B03-5X0.8-65R	10139333	M5	0,8	3,71 <i>0.146</i>	8,0 <i>0.315</i>	25 <i>0.984</i>	66,29 <i>2.610</i>	72,0 <i>2.835</i>	6,0 <i>0.236</i>	6.00X4.90	4,2 <i>0.165</i>	3	B
T34B-PH01B03-6X1-65R	10139334	M6	1,0	4,5 <i>0.177</i>	10,0 <i>0.394</i>	30 <i>1.181</i>	75,5 <i>2.972</i>	82,4 <i>3.244</i>	6,0 <i>0.236</i>	6.00X4.90	5,0 <i>0.197</i>	3	B
T34B-PH01B03-8X1.25-65R	10139335	M8	1,25	5,48 <i>0.216</i>	13,0 <i>0.512</i>	35 <i>1.378</i>	84,52 <i>3.328</i>	93,3 <i>3.673</i>	8,0 <i>0.315</i>	8.00X6.20	6,8 <i>0.268</i>	3	B
T34B-PH01B03-10X1.5-65R	10139336	M10	1,5	6,9 <i>0.272</i>	15,0 <i>0.591</i>	39 <i>1.535</i>	93,1 <i>3.665</i>	100,0 <i>3.937</i>	10,0 <i>0.394</i>	10.00X8.00	8,5 <i>0.335</i>	3	B

Thread turning

MDT

Mini-Shaft™

Thread milling

Thread tapping

Annex

T34B-PHB

Through holes – Metric coarse threads

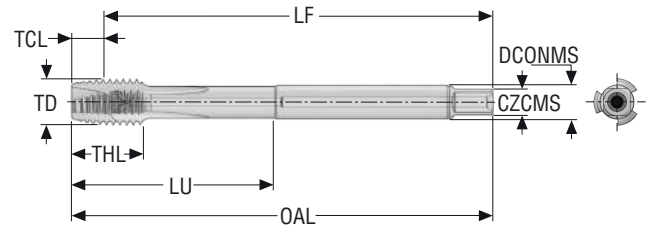

- Internal coolant
- Substrate: HSSE-PM
- Coating: TiAlN + WC/C
- Standard: DIN376
- Thread tolerance class: 6HX
- For cutting data see page(s) 263

Designation	Item number	TDZ	Pitch	TCL	THL	LU	LF	OAL	DCONMS	CZCMS	PHDR Ø	NOF	THCT
			mm	mm <i>Inch</i>	mm <i>Inch</i>	mm <i>Inch</i>	mm <i>Inch</i>	mm <i>Inch</i>	mm <i>Inch</i>	mm <i>Inch</i>	mm <i>Inch</i>		
T34B-PH01B06-12X1.75-65R	10139337	M12	1,75	8,11 <i>0.319</i>	18,0 <i>0.709</i>	83 <i>3.268</i>	101,89 <i>4.011</i>	110,0 <i>4.331</i>	9,0 <i>0.354</i>	9.00X7.00	10,2 <i>0.402</i>	3	B
T34B-PH01B06-14X2-65R	10139338	M14	2,0	9,26 <i>0.365</i>	20,0 <i>0.787</i>	81 <i>3.189</i>	100,74 <i>3.966</i>	110,0 <i>4.331</i>	11,0 <i>0.433</i>	11.00X9.00	12,0 <i>0.472</i>	3	B
T34B-PH01B06-16X2-65R	10139339	M16	2,0	9,36 <i>0.369</i>	20,0 <i>0.787</i>	68 <i>2.677</i>	100,64 <i>3.962</i>	110,0 <i>4.331</i>	12,0 <i>0.472</i>	12.00X9.00	14,0 <i>0.551</i>	3	B

Thread turning

MDT

Mini-Shaft™

Thread milling

Thread tapping

Annex

T34-PHB

Through holes – MF threads

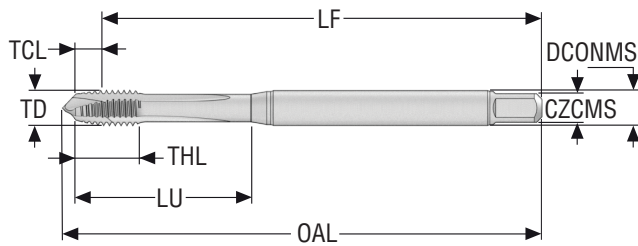

- Substrate: HSSE-PM
- Coating: TiAlN + WC/C
- Standard: DIN371
- Thread tolerance class: 6HX
- For cutting data see page(s) 263

Designation	Item number	TDZ	Pitch	TCL	THL	LU	LF	OAL	DCONMS	CZCMS	PHDR Ø	NOF	THCHT
			mm	mm Inch	mm Inch	mm Inch	mm Inch	mm Inch	mm Inch	mm Inch	mm Inch		
T34-PH02B03-3X0.35-65R	10139340	MF3X0.35	0,35	1,6 0.063	5,0 0.197	18 0.709	54,4 2.142	57,2 2.252	3,5 0.138	3.50X2.70	2,65 0.104	3	B
T34-PH02B03-3.5X0.35-65R	10139341	MF3.5X0.35	0,35	1,6 0.063	5,0 0.197	20 0.787	54,4 2.142	57,4 2.260	4,0 0.157	4.00X3.00	3,15 0.124	3	B
T34-PH02B03-4X0.5-65R	10139342	MF4X0.5	0,5	2,3 0.091	7,0 0.276	21 0.827	60,7 2.390	64,6 2.543	4,5 0.177	4.50X3.40	3,5 0.138	3	B
T34-PH02B03-5X0.5-65R	10139343	MF5X0.5	0,5	2,3 0.091	8,0 0.315	25 0.984	67,7 2.665	72,0 2.835	6,0 0.236	6.00X4.90	4,5 0.177	3	B
T34-PH02B03-6X0.5-65R	10139344	MF6X0.5	0,5	2,34 0.092	10,0 0.394	30 1.181	77,6 3.057	82,4 3.244	6,0 0.236	6.00X4.90	5,5 0.217	3	B
T34-PH02B03-6X0.75-65R	10139345	MF6X0.75	0,75	3,4 0.134	10,0 0.394	30 1.181	76,6 3.016	82,4 3.244	6,0 0.236	6.00X4.90	5,2 0.205	3	B
T34-PH02B03-8X0.75-65R	10139346	MF8X0.75	0,75	3,4 0.134	10,0 0.394	30 1.181	76,6 3.016	83,6 3.291	8,0 0.315	8.00X6.20	7,2 0.283	3	B
T34-PH02B03-8X1-65R	10139347	MF8X1.0	1,0	4,45 0.175	13,0 0.512	35 1.378	85,55 3.368	93,3 3.673	8,0 0.315	8.00X6.20	7,0 0.276	3	B
T34-PH02B03-10X0.75-65R	10139348	MF10X0.75	0,75	3,8 0.150	13,0 0.512	35 1.378	86,2 3.394	91,8 3.614	10,0 0.394	10.00X8.00	9,2 0.362	3	B
T34-PH02B03-10X1-65R	10139349	MF10X1.0	1,0	5,25 0.207	13,0 0.512	35 1.378	84,75 3.337	91,8 3.614	10,0 0.394	10.00X8.00	9,0 0.354	3	B
T34-PH02B03-10X1.25-65R	10139350	MF10X1.25	1,25	6,28 0.247	15,0 0.591	39 1.535	93,72 3.690	101,8 4.008	10,0 0.394	10.00X8.00	8,8 0.346	3	B

Thread turning

MDT

Mini-Shaft™

Thread milling

Thread tapping

Annex

T34-PHB

Through holes – MF threads

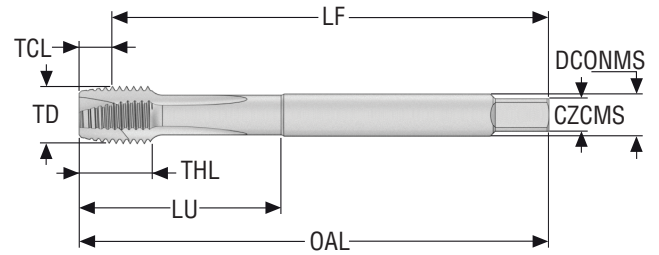

- Substrate: HSSE-PM
- Coating: TiAlN + WC/C
- Standard: DIN374
- Thread tolerance class: 6HX
- For cutting data see page(s) 263

Designation	Item number	TDZ	Pitch	TCL	THL	LU	LF	OAL	DCONMS	CZCMS	PHDR Ø	NOF	THCHT
			mm	mm Inch	mm Inch	mm Inch	mm Inch	mm Inch	mm Inch	mm Inch	mm Inch		
T34-PH02B05-8X1-65R	10139351	MF8X1.0	1,0	4,75 0.187	10,0 0.394	35 1.378	85,25 3.356	90,0 3.543	6,0 0.236	6.00X4.90	7,0 0.276	3	B
T34-PH02B05-10X1-65R	10139352	MF10X1.0	1,0	4,85 0.191	10,0 0.394	35 1.378	85,15 3.352	90,0 3.543	7,0 0.276	7.00X5.50	9,0 0.354	3	B
T34-PH02B05-12X1-65R	10139353	MF12X1.0	1,0	4,98 0.196	10,0 0.394	73 2.874	95,02 3.741	100,0 3.937	9,0 0.354	9.00X7.00	11,0 0.433	3	B
T34-PH02B05-12X1.25-65R	10139354	MF12X1.25	1,25	7,07 0.278	15,0 0.591	73 2.874	92,93 3.659	100,0 3.937	9,0 0.354	9.00X7.00	10,8 0.425	3	B
T34-PH02B05-12X1.5-65R	10139355	MF12X1.5	1,5	6,03 0.237	15,0 0.591	73 2.874	93,97 3.700	100,0 3.937	9,0 0.354	9.00X7.00	10,5 0.413	3	B
T34-PH02B05-14X1.5-65R	10139356	MF14X1.5	1,5	7,17 0.282	15,0 0.591	71 2.795	92,83 3.655	100,0 3.937	11,0 0.433	11.00X9.00	12,5 0.492	3	B
T34-PH02B05-16X1.5-65R	10139357	MF16X1.5	1,5	7,27 0.286	15,0 0.591	58 2.283	92,73 3.651	100,0 3.937	12,0 0.472	12.00X9.00	14,5 0.571	3	B
T34-PH02B05-18X1.5-65R	10139358	MF18X1.5	1,5	7,17 0.282	17,0 0.669	66 2.598	102,83 4.048	110,0 4.331	14,0 0.551	14.00X11.00	16,5 0.650	4	B
T34-PH02B05-20X1.5-65R	10139359	MF20X1.5	1,5	7,27 0.286	17,0 0.669	80 3.150	117,73 4.635	125,0 4.921	16,0 0.630	16.00X12.00	18,5 0.728	4	B
T34-PH02B05-22X1.5-65R	10139360	MF22X1.5	1,5	7,27 0.286	17,0 0.669	78 3.071	117,73 4.635	125,0 4.921	18,0 0.709	18.00X14.50	20,5 0.807	4	B
T34-PH02B05-24X1.5-65R	10139361	MF24X1.5	1,5	7,41 0.292	20,0 0.787	93 3.661	132,59 5.220	140,0 5.512	18,0 0.709	18.00X14.50	22,5 0.886	4	B

Thread turning

MDT

Mini-Shaft™

Thread milling

Thread tapping

Annex

T34B-PHB

Through holes – MF threads

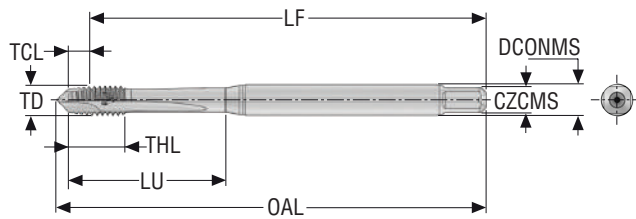

- Internal coolant
- Substrate: HSSE-PM
- Coating: TiAlN + WC/C
- Standard: DIN371
- Thread tolerance class: 6HX
- For cutting data see page(s) 263

Designation	Item number	TDZ	Pitch	TCL	THL	LU	LF	OAL	DCONMS	CZCMS	PHDR Ø	NOF	THCHT
			mm	mm <i>Inch</i>	mm <i>Inch</i>	mm <i>Inch</i>	mm <i>Inch</i>	mm <i>Inch</i>	mm <i>Inch</i>	mm <i>Inch</i>	mm <i>Inch</i>		
T34B-PH02B03-8X1-65R	10139362	MF8X1.0	1,0	4,45 <i>0.175</i>	13,0 <i>0.512</i>	35 <i>1.378</i>	85,55 <i>3.368</i>	93,4 <i>3.677</i>	8,0 <i>0.315</i>	8.00X6.20	7,0 <i>0.276</i>	3	B
T34B-PH02B03-10X1-65R	10139363	MF10X1.0	1,0	5,25 <i>0.207</i>	13,0 <i>0.512</i>	35 <i>1.378</i>	84,75 <i>3.337</i>	90,0 <i>3.543</i>	10,0 <i>0.394</i>	10.00X8.00	9,0 <i>0.354</i>	3	B

Thread turning

MDT

Mini-Shaft™

Thread milling

Thread tapping

Annex

T34B-PHB

Through holes – MF threads

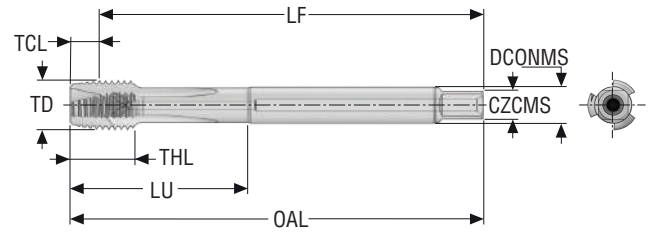

- Internal coolant
- Substrate: HSSE-PM
- Coating: TiAIN + WC/C
- Standard: DIN374
- Thread tolerance class: 6HX
- For cutting data see page(s) 263

Designation	Item number	TDZ	Pitch	TCL	THL	LU	LF	OAL	DCONMS	CZCMS	PHDR Ø	NOF	THCT
			mm	mm <i>Inch</i>	mm <i>Inch</i>	mm <i>Inch</i>	mm <i>Inch</i>	mm <i>Inch</i>	mm <i>Inch</i>	mm <i>Inch</i>	mm <i>Inch</i>		
T34B-PH02B05-8X1-65R	10139364	MF8X1.0	1,0	4,75 <i>0.187</i>	10,0 <i>0.394</i>	35 <i>1.378</i>	85,25 <i>3.356</i>	90,0 <i>3.543</i>	6,0 <i>0.236</i>	6.00X4.90	7,0 <i>0.276</i>	3	B
T34B-PH02B05-10X1-65R	10139365	MF10X1.0	1,0	4,85 <i>0.191</i>	10,0 <i>0.394</i>	35 <i>1.378</i>	85,15 <i>3.352</i>	90,0 <i>3.543</i>	7,0 <i>0.276</i>	7.00X5.50	9,0 <i>0.354</i>	3	B
T34B-PH02B05-12X1.5-65R	10139366	MF12X1.5	1,5	7,07 <i>0.278</i>	15,0 <i>0.591</i>	73 <i>2.874</i>	92,93 <i>3.659</i>	100,0 <i>3.937</i>	9,0 <i>0.354</i>	9.00X7.00	10,5 <i>0.413</i>	3	B
T34B-PH02B05-14X1.5-65R	10139367	MF14X1.5	1,5	7,17 <i>0.282</i>	15,0 <i>0.591</i>	71 <i>2.795</i>	92,83 <i>3.655</i>	100,0 <i>3.937</i>	11,0 <i>0.433</i>	11.00X9.00	12,5 <i>0.492</i>	3	B
T34B-PH02B05-16X1.5-65R	10139368	MF16X1.5	1,5	7,27 <i>0.286</i>	15,0 <i>0.591</i>	58 <i>2.283</i>	92,73 <i>3.651</i>	100,0 <i>3.937</i>	12,0 <i>0.472</i>	12.00X9.00	14,5 <i>0.571</i>	3	B

Thread turning

MDT

Mini-Shaft™

Thread milling

Thread tapping

Annex

T34-PHB

Through holes – UNC threads

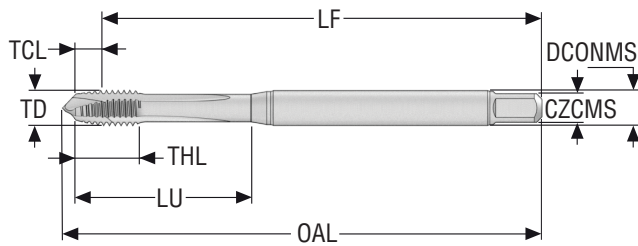

- Substrate: HSSE-PM
- Coating: TiAlN + WC/C
- Standard: DIN371
- Thread tolerance class: 2BX
- For cutting data see page(s) 263

Designation	Item number	TDZ	TD	Pitch	TCL	THL	LU	LF	OAL	DCONMS	CZCMS	PHDR Ø	NOF	THCHT
			mm Inch	TPI	mm Inch	mm Inch	mm Inch	mm Inch	mm Inch	mm Inch	mm Inch			
T34-PH08B03-4-40-22R	10139041	UNC4-40	2,845 0.112	40.0	2,83 0.111	5,0 0.197	18 0.709	53,17 2.093	56,0 2.205	3,5 0.138	3.50X2.70	2,35 0.093	3	B
T34-PH08B03-5-40-22R	10139042	UNC5-40	3,175 0.125	40.0	2,94 0.116	7,0 0.276	18 0.709	53,06 2.089	57,2 2.252	3,5 0.138	3.50X2.70	2,65 0.104	3	B
T34-PH08B03-6-32-22R	10139043	UNC6-32	3,505 0.138	32.0	3,74 0.147	6,0 0.236	20 0.787	52,26 2.057	57,4 2.260	4,0 0.157	4.00X3.00	2,85 0.112	3	B
T34-PH08B03-8-32-22R	10139044	UNC8-32	4,166 0.164	32.0	3,62 0.143	7,0 0.276	21 0.827	59,38 2.338	64,6 2.543	4,5 0.177	4.50X3.40	3,5 0.138	3	B
T34-PH08B03-10-24-22R	10139045	UNC10-24	4,826 0.190	24.0	4,86 0.191	8,0 0.315	25 0.984	65,14 2.565	72,0 2.835	6,0 0.236	6.00X4.90	3,9 0.154	3	B
T34-PH08B03-12-24-22R	10139046	UNC12-24	5,486 0.216	24.0	4,74 0.187	10,0 0.394	30 1.181	75,26 2.963	82,2 3.236	6,0 0.236	6.00X4.90	4,5 0.177	3	B
T34-PH08B03-1/4-20-22R	10139047	UNC1/4-20	6,35 0.250	20.0	5,65 0.222	13,0 0.512	32 1.260	74,35 2.927	82,4 3.244	7,0 0.276	7.00X5.50	5,1 0.201	3	B
T34-PH08B03-5/16-18-22R	10139048	UNC5/16-18	7,937 0.312	18.0	6,31 0.248	13,0 0.512	35 1.378	83,69 3.295	93,3 3.673	8,0 0.315	8.00X6.20	6,6 0.260	3	B
T34-PH08B03-3/8-16-22R	10139049	UNC3/8-16	9,525 0.375	16.0	7,37 0.290	15,0 0.591	39 1.535	92,63 3.647	100,0 3.937	10,0 0.394	10.00X8.00	8,0 0.315	3	B

Thread turning

MDT

Mini-Shaft™

Thread milling

Thread tapping

Annex

T34-PHB

Through holes – UNC threads

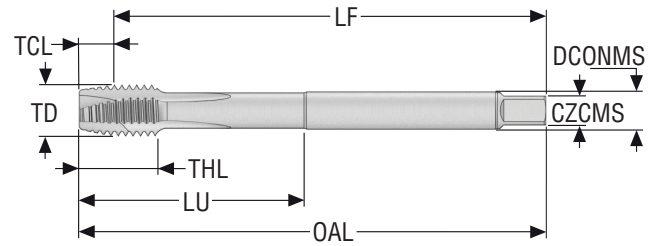

- Substrate: HSSE-PM
- Coating: TiAlN + WC/C
- Standard: DIN376
- Thread tolerance class: 2BX
- For cutting data see page(s) 263

Designation	Item number	TDZ	TD	Pitch	TCL	THL	LU	LF	OAL	DCONMS	CZCMS	PHDR Ø	NOF	THCHT
			mm Inch	TPI	mm Inch	mm Inch	mm Inch	mm Inch	mm Inch	mm Inch	mm Inch			
T34-PH08B06-7/16-14-22R	10139050	UNC7/16-14	11,112 0.437	14.0	8,36 0.329	15,0 0.591	76 2.992	91,64 3.608	100,0 3.937	8,0 0.315	8.00X6.20	9,3 0.366	3	B
T34-PH08B06-1/2-13-22R	10139051	UNC1/2-13	12,7 0.500	13.0	9,01 0.355	18,0 0.709	83 3.268	100,99 3.976	110,0 4.331	9,0 0.354	9.00X7.00	10,7 0.421	3	B
T34-PH08B06-9/16-12-22R	10139052	UNC9/16-12	14,287 0.562	12.0	9,87 0.389	20,0 0.787	81 3.189	100,13 3.942	110,0 4.331	11,0 0.433	11.00X9.00	12,3 0.484	3	B
T34-PH08B06-5/8-11-22R	10139053	UNC5/8-11	15,875 0.625	11.0	10,62 0.418	22,0 0.866	68 2.677	99,38 3.913	110,0 4.331	12,0 0.472	12.00X9.00	13,5 0.531	3	B

Thread turning

MDT

Mini-Shaft™

Thread milling

Thread tapping

Annex

T34-PHB

Through holes – UNF threads

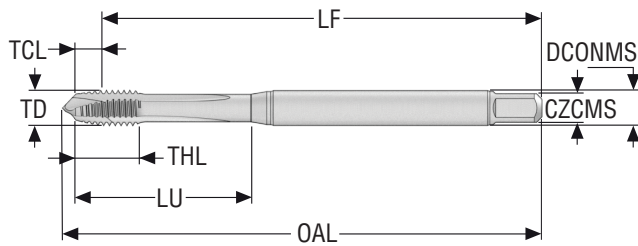

- Substrate: HSSE-PM
- Coating: TiAlN + WC/C
- Standard: DIN371
- Thread tolerance class: 2BX
- For cutting data see page(s) 263

Designation	Item number	TDZ	TD	Pitch	TCL	THL	LU	LF	OAL	DCONMS	CZCMS	PHDR Ø	NOF	THCHT
			mm Inch	TPI	mm Inch	mm Inch	mm Inch	mm Inch	mm Inch	mm Inch	mm Inch	mm Inch		
T34-PH09B03-4-48-22R	10139369	UNF4-48	2,845 0.112	48.0	2,48 0.098	5,0 0.197	18 0.709	53,52 2.107	57,2 2.252	3,5 0.138	3.50X2.70	2,4 0.094	3	B
T34-PH09B03-5-44-22R	10139370	UNF5-44	3,175 0.125	44.0	2,6 0.102	7,0 0.276	18 0.709	53,4 2.102	57,2 2.252	3,5 0.138	3.50X2.70	2,7 0.106	3	B
T34-PH09B03-6-40-22R	10139371	UNF6-40	3,505 0.138	40.0	3,05 0.120	6,0 0.236	20 0.787	52,95 2.085	57,4 2.260	4,0 0.157	4.00X3.00	2,95 0.116	3	B
T34-PH09B03-8-36-22R	10139372	UNF8-36	4,166 0.164	36.0	3,28 0.129	7,0 0.276	21 0.827	59,72 2.351	64,6 2.543	4,5 0.177	4.50X3.40	3,5 0.138	3	B
T34-PH09B03-10-32-22R	10139373	UNF10-32	4,826 0.190	32.0	3,5 0.138	8,0 0.315	25 0.984	66,5 2.618	72,0 2.835	6,0 0.236	6.00X4.90	4,1 0.161	3	B
T34-PH09B03-12-28-22R	10139374	UNF12-28	5,486 0.216	28.0	4,05 0.159	10,0 0.394	30 1.181	75,95 2.990	82,2 3.236	6,0 0.236	6.00X4.90	4,6 0.181	3	B
T34-PH09B03-1/4-28-22R	10139375	UNF1/4-28	6,35 0.250	28.0	3,94 0.155	10,0 0.394	30 1.181	76,06 2.994	82,4 3.244	7,0 0.276	7.00X5.50	5,5 0.217	3	B
T34-PH09B03-5/16-24-22R	10139376	UNF5/16-24	7,937 0.312	24.0	4,6 0.181	13,0 0.512	35 1.378	85,4 3.362	93,3 3.673	8,0 0.315	8.00X6.20	6,9 0.272	3	B
T34-PH09B03-3/8-24-22R	10139377	UNF3/8-24	9,525 0.375	24.0	4,98 0.196	15,0 0.591	35 1.378	85,02 3.347	90,0 3.543	10,0 0.394	10.00X8.00	8,5 0.335	3	B

Thread turning

MDT

Mini-Shaft™

Thread milling

Thread tapping

Annex

T34-PHB

Through holes – UNF threads

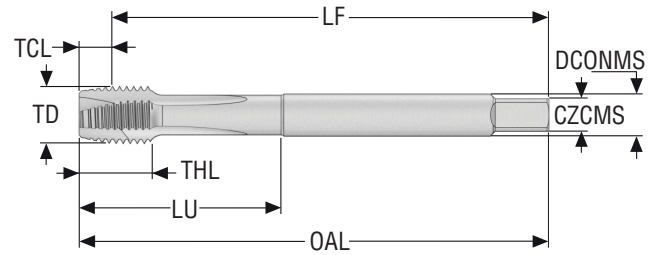

- Substrate: HSSE-PM
- Coating: TiAlN + WC/C
- Standard: DIN376
- Thread tolerance class: 2BX
- For cutting data see page(s) 263

Designation	Item number	TDZ	TD	Pitch	TCL	THL	LU	LF	OAL	DCONMS	CZCMS	PHDR Ø	NOF	THCHT
			mm Inch	TPI	mm Inch	mm Inch	mm Inch	mm Inch	mm Inch	mm Inch	mm Inch	mm Inch		
T34-PH09B05-7/16-20-22R	10139378	UNF7/16-20	11,112 0.437	20.0	5,95 0.234	15,0 0.591	76 2.992	94,05 3.703	100,0 3.937	8,0 0.315	8.00X6.20	9,9 0.390	3	B
T34-PH09B05-1/2-20-22R	10139379	UNF1/2-20	12,7 0.500	20.0	6,14 0.242	15,0 0.591	73 2.874	93,86 3.695	100,0 3.937	9,0 0.354	9.00X7.00	11,5 0.453	3	B
T34-PH09B05-9/16-18-22R	10139380	UNF9/16-18	14,287 0.562	18.0	6,8 0.268	15,0 0.591	71 2.795	93,2 3.669	100,0 3.937	11,0 0.433	11.00X9.00	13,0 0.512	3	B
T34-PH09B05-5/8-18-22R	10139381	UNF5/8-18	15,875 0.625	18.0	6,87 0.270	15,0 0.591	58 2.283	93,13 3.667	100,0 3.937	12,0 0.472	12.00X9.00	14,5 0.571	3	B

Thread turning

MDT

Mini-Shaft™

Thread milling

Thread tapping

Annex

T34-PHB

Through holes – G threads

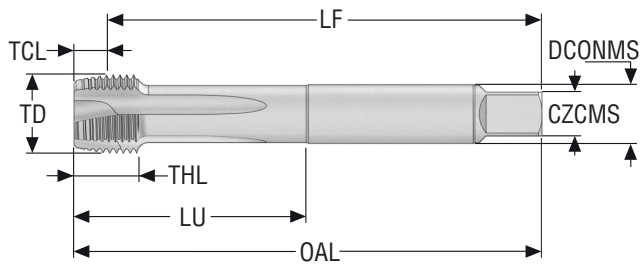

- Substrate: HSSE-PM
- Coating: TiAlN + WC/C
- Standard: DIN5156
- Thread tolerance class: NORMAL-X
- For cutting data see page(s) 263

Designation	Item number	TDZ	TD	Pitch	TCL	THL	LU	LF	OAL	DCONMS	CZCMS	PHDR Ø	NOF	THCHT
			mm Inch	TPI	mm Inch	mm Inch	mm Inch	mm Inch	mm Inch	mm Inch	mm Inch			
T34-PH21B09-1/8-28-12R	10139401	G1/8-28	9,728 0.383	28.0	4,49 0.177	10,0 0.394	36 1.417	85,51 3.367	90,0 3.543	7,0 0.276	7.00X5.50	8,8 0.346	3	B
T34-PH21B09-1/4-19-12R	10139402	G1/4-19	13,157 0.518	19.0	6,85 0.270	14,0 0.551	71 2.795	93,15 3.667	100,0 3.937	11,0 0.433	11.00X9.00	11,8 0.465	3	B
T34-PH21B09-3/8-19-12R	10139403	G3/8-19	16,662 0.656	19.0	6,97 0.274	15,0 0.591	58 2.283	93,03 3.663	100,0 3.937	12,0 0.472	12.00X9.00	15,25 0.600	4	B
T34-PH21B09-1/2-14-12R	10139404	G1/2-14	20,955 0.825	14.0	9,0 0.354	17,0 0.669	80 3.150	116,0 4.567	125,0 4.921	16,0 0.630	16.00X12.00	19,0 0.748	4	B
T34-PH21B09-5/8-14-12R	10139405	G5/8-14	22,911 0.902	14.0	9,4 0.370	20,0 0.787	78 3.071	115,6 4.551	125,0 4.921	18,0 0.709	18.00X14.50	21,0 0.827	4	B
T34-PH21B09-3/4-14-12R	10139406	G3/4-14	26,441 1.041	14.0	9,16 0.361	20,0 0.787	77 3.031	130,84 5.151	140,0 5.512	20,0 0.787	20.00X16.00	24,5 0.965	4	B
T34-PH21B09-7/8-14-12R	10139407	G7/8-14	30,201 1.189	14.0	9,03 0.356	22,0 0.866	85 3.346	140,97 5.550	150,0 5.906	22,0 0.866	22.00X18.00	28,25 1.112	4	B
T34-PH21B09-1-11-12R	10139408	G1-11	33,249 1.309	11.0	11,49 0.452	24,0 0.945	93 3.661	148,51 5.847	160,0 6.299	25,0 0.984	25.00X20.00	30,75 1.211	4	B

Thread turning

MDT

Mini-Shaft™

Thread milling

Thread tapping

Annex

T34-PHB

Through holes – EGM threads

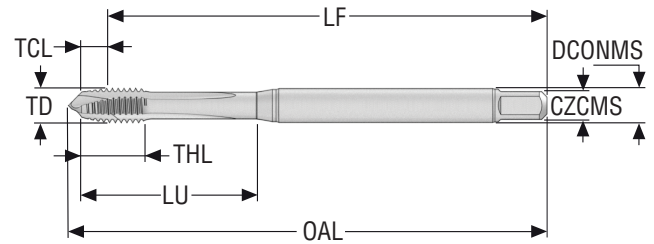

- Substrate: HSSE-PM
- Coating: TiAlN + WC/C
- Standard: DIN371
- Thread tolerance class: 6H mod.
- For cutting data see page(s) 263

Designation	Item number	TDZ	Pitch	TCL	THL	LU	LF	OAL	DCONMS	CZCMS	PHDR Ø	NOF	THCHT
			mm	mm Inch	mm Inch	mm Inch	mm Inch	mm Inch	mm Inch		mm Inch		
T34-PH04B03-2X0.4-64R	10139382	EGM2	0,4	2,07 0.081	9,0 0.354	14 0.551	47,93 1.887	51,7 2.035	2,8 0.110	2.80X2.10	2,1 0.083	2	B
T34-PH04B03-2.5X0.45-64R	10139383	EGM2.5	0,45	2,13 0.084	10,0 0.394	18 0.709	53,87 2.121	57,2 2.252	3,5 0.138	3.50X2.70	2,65 0.104	3	B
T34-PH04B03-3X0.5-64R	10139384	EGM3	0,5	2,03 0.080	12,0 0.472	21 0.827	60,97 2.400	64,6 2.543	4,5 0.177	4.50X3.40	3,15 0.124	3	B
T34-PH04B03-4X0.7-64R	10139385	EGM4	0,7	3,27 0.129	14,0 0.551	25 0.984	66,73 2.627	72,0 2.835	6,0 0.236	6.00X4.90	4,2 0.165	3	B
T34-PH04B03-5X0.8-64R	10139386	EGM5	0,8	3,72 0.146	18,0 0.709	30 1.181	76,28 3.003	82,4 3.244	6,0 0.236	6.00X4.90	5,25 0.207	3	B
T34-PH04B03-6X1-64R	10139387	EGM6	1,0	4,7 0.185	18,0 0.709	35 1.378	85,3 3.358	90,0 3.543	8,0 0.315	8.00X6.20	6,3 0.248	3	B
T34-PH04B03-8X1.25-64R	10139388	EGM8	1,25	5,8 0.228	20,0 0.787	39 1.535	94,2 3.709	100,0 3.937	10,0 0.394	10.00X8.00	8,4 0.331	3	B

Thread turning

MDT

Mini-Shaft™

Thread milling

Thread tapping

Annex

T34-PHB

Through holes – EGM threads

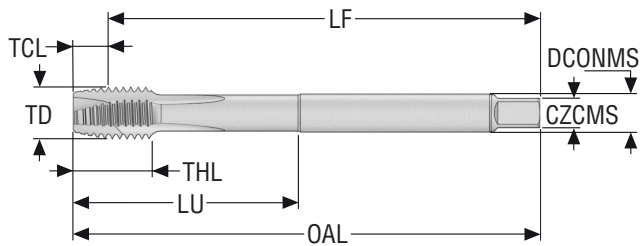

- Substrate: HSSE-PM
- Coating: TiAlN + WC/C
- Standard: DIN376
- Thread tolerance class: 6H mod.
- For cutting data see page(s) 263

Designation	Item number	TDZ	Pitch	TCL	THL	LU	LF	OAL	DCONMS	CZCMS	PHDR Ø	NOF	THCHT
			mm	mm <i>Inch</i>	mm <i>Inch</i>	mm <i>Inch</i>	mm <i>Inch</i>	mm <i>Inch</i>	mm <i>Inch</i>	mm <i>Inch</i>	mm <i>Inch</i>		
T34-PH04B06-10X1.5-64R	10139409	EGM10	1,5	7,41 0.292	15,0 0.591	73 2.874	92,59 3.645	100,0 3.937	9,0 0.354	9.00X7.00	10,5 0.413	3	B
T34-PH04B06-12X1.75-64R	10139410	EGM12	1,75	8,29 0.326	20,0 0.787	81 3.189	101,71 4.004	110,0 4.331	11,0 0.433	11.00X9.00	12,5 0.492	4	B
T34-PH04B06-14X2-64R	10139411	EGM14	2,0	9,14 0.360	20,0 0.787	68 2.677	100,86 3.971	110,0 4.331	12,0 0.472	12.00X9.00	14,5 0.571	4	B
T34-PH04B06-16X2-64R	10139412	EGM16	2,0	9,14 0.360	20,0 0.787	81 3.189	115,86 4.561	125,0 4.921	14,0 0.551	14.00X11.00	16,5 0.650	4	B
T34-PH04B06-18X2.5-64R	10139413	EGM18	2,5	11,45 0.451	27,0 1.063	93 3.661	128,55 5.061	140,0 5.512	18,0 0.709	18.00X14.50	18,75 0.738	4	B
T34-PH04B06-20X2.5-64R	10139414	EGM20	2,5	11,45 0.451	30,0 1.181	113 4.449	148,55 5.848	160,0 6.299	18,0 0.709	18.00X14.50	20,75 0.817	4	B

Thread turning

MDT

Mini-Shaft™

Thread milling

Thread tapping

Annex

T34-PHB

Through holes – EGUNC threads

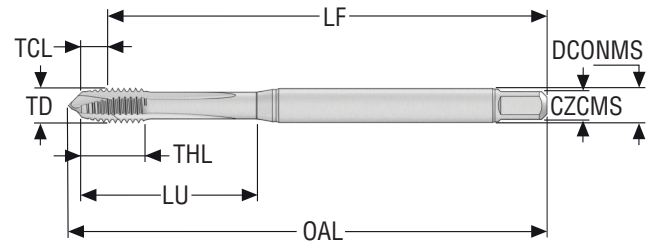

- Substrate: HSSE-PM
- Coating: TiAlN + WC/C
- Standard: DIN371
- Thread tolerance class: 2B
- For cutting data see page(s) 263

Designation	Item number	TDZ	TD	Pitch	TCL	THL	LU	LF	OAL	DCONMS	CZCMS	PHDR Ø	NOF	THCHT
			mm Inch	TPI	mm Inch	mm Inch	mm Inch	mm Inch	mm Inch	mm Inch		mm Inch		
T34-PH16B03-4-40-21R	10139389	EGUNC4-40	3,67 0.144	40.0	2,83 0.111	13,0 0.512	21 0.827	60,17 2.369	64,6 2.543	4,5 0.177	4.50X3.40	3,1 0.122	3	B
T34-PH16B03-6-32-21R	10139390	EGUNC6-32	4,536 0.179	32.0	3,75 0.148	14,0 0.551	25 0.984	66,25 2.608	71,8 2.827	6,0 0.236	6.00X4.90	3,8 0.150	3	B
T34-PH16B03-8-32-21R	10139391	EGUNC8-32	5,197 0.205	32.0	3,73 0.147	16,0 0.630	30 1.181	76,27 3.003	82,1 3.232	6,0 0.236	6.00X4.90	4,4 0.173	3	B
T34-PH16B03-10-24-21R	10139392	EGUNC10-24	6,2 0.244	24.0	3,5 0.138	17,0 0.669	30 1.181	76,5 3.012	82,4 3.244	7,0 0.276	7.00X5.50	5,2 0.205	3	B
T34-PH16B03-1/4-20-21R	10139393	EGUNC1/4-20	8,001 0.315	20.0	5,71 0.225	20,0 0.787	35 1.378	84,29 3.319	93,3 3.673	8,0 0.315	8.00X6.20	6,7 0.264	3	B
T34-PH16B03-5/16-18-21R	10139394	EGUNC5/16-18	9,771 0.385	18.0	6,61 0.260	22,0 0.866	39 1.535	93,39 3.677	100,0 3.937	10,0 0.394	10.00X8.00	8,4 0.331	3	B

Thread turning

MDT

Mini-Shaft™

Thread milling

Thread tapping

Annex

T34-PHB

Through holes – EGUNC threads

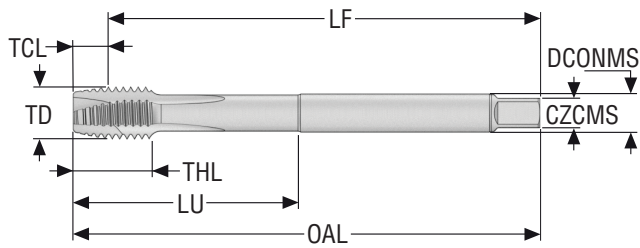

- Substrate: HSSE-PM
- Coating: TiAlN + WC/C
- Standard: DIN376
- Thread tolerance class: 2B
- For cutting data see page(s) 263

Designation	Item number	TDZ	TD	Pitch	TCL	THL	LU	LF	OAL	DCONMS	CZCMS	PHDR Ø	NOF	THCHT
			mm Inch	TPI	mm Inch	mm Inch	mm Inch	mm Inch	mm Inch	mm Inch	mm Inch	mm Inch		
T34-PH16B06-3/8-16-21R	10139415	EGUNC3/8-16	11,587 0.456	16.0	7,6 0.299	15,0 0.591	73 2.874	92,4 3.638	100,0 3.937	9,0 0.354	9.00X7.00	10,0 0.394	3	B
T34-PH16B06-7/16-14-21R	10139416	EGUNC7/16-14	13,47 0.530	14.0	8,6 0.339	18,0 0.709	81 3.189	101,4 3.992	110,0 4.331	11,0 0.433	11.00X9.00	11,6 0.457	3	B
T34-PH16B06-1/2-13-21R	10139417	EGUNC1/2-13	15,237 0.600	13.0	9,3 0.366	18,0 0.709	68 2.677	100,7 3.965	110,0 4.331	12,0 0.472	12.00X9.00	13,3 0.524	3	B
T34-PH16B06-9/16-12-21R	10139418	EGUNC9/16-12	17,038 0.671	12.0	9,7 0.382	20,0 0.787	68 2.677	100,3 3.949	110,0 4.331	12,0 0.472	12.00X9.00	14,9 0.587	4	B
T34-PH16B06-5/8-11-21R	10139419	EGUNC5/8-11	18,875 0.743	11.0	10,6 0.417	20,0 0.787	81 3.189	114,4 4.504	125,0 4.921	14,0 0.551	14.00X11.00	16,5 0.650	4	B
T34-PH16B06-3/4-10-21R	10139420	EGUNC3/4-10	22,349 0.880	10.0	11,8 0.465	25,0 0.984	93 3.661	128,2 5.047	140,0 5.512	18,0 0.709	18.00X14.50	19,75 0.778	4	B

Thread turning

MDT

Mini-Shaft™

Thread milling

Thread tapping

Annex

T34-PHB

Through holes – EGUNF threads

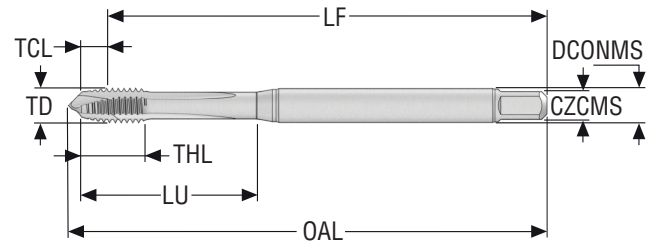

- Substrate: HSSE-PM
- Coating: TiAlN + WC/C
- Standard: DIN371
- Thread tolerance class: 2B
- For cutting data see page(s) 263

Designation	Item number	TDZ	TD	Pitch	TCL	THL	LU	LF	OAL	DCONMS	CZCMS	PHDR Ø	NOF	THCHT
			mm Inch	TPI	mm Inch	mm Inch	mm Inch	mm Inch	mm Inch	mm Inch	mm Inch	mm Inch		
T34-PH17B03-4-48-21R	10139395	EGUNF4-48	3,533 0.139	48.0	2,36 0.093	9,0 0.354	20 0.787	53,64 2.112	57,4 2.260	4,0 0.157	4.00X3.00	3,0 0.118	3	B
T34-PH17B03-6-40-21R	10139396	EGUNF6-40	4,331 0.171	40.0	2,75 0.108	10,0 0.394	25 0.984	67,25 2.648	71,8 2.827	6,0 0.236	6.00X4.90	3,7 0.146	3	B
T34-PH17B03-8-36-21R	10139397	EGUNF8-36	5,083 0.200	36.0	2,93 0.115	13,0 0.512	30 1.181	77,07 3.034	82,1 3.232	6,0 0.236	6.00X4.90	4,4 0.173	3	B
T34-PH17B03-10-32-21R	10139398	EGUNF10-32	5,857 0.231	32.0	3,5 0.138	13,0 0.512	30 1.181	76,5 3.012	82,4 3.244	6,0 0.236	6.00X4.90	5,1 0.201	3	B
T34-PH17B03-1/4-28-21R	10139399	EGUNF1/4-28	7,529 0.296	28.0	4,09 0.161	17,0 0.669	35 1.378	85,91 3.382	93,2 3.669	8,0 0.315	8.00X6.20	6,6 0.260	3	B
T34-PH17B03-5/16-24-21R	10139400	EGUNF5/16-24	9,312 0.367	24.0	5,1 0.201	18,0 0.709	35 1.378	84,97 3.345	90,0 3.543	10,0 0.394	10.00X8.00	8,25 0.325	3	B

Thread turning

MDT

Mini-Shaft™

Thread milling

Thread tapping

Annex

T34-PHB

Through holes – EGUNF threads

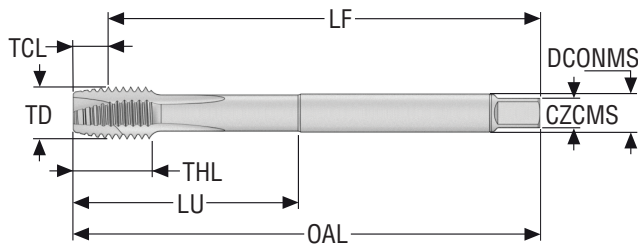

- Substrate: HSSE-PM
- Coating: TiAlN + WC/C
- Standard: DIN376
- Thread tolerance class: 2B
- For cutting data see page(s) 263

Designation	Item number	TDZ	TD	Pitch	TCL	THL	LU	LF	OAL	DCONMS	CZCMS	PHDR Ø	NOF	THCHT
			mm Inch	TPI	mm Inch	mm Inch	mm Inch	mm Inch	mm Inch	mm Inch	mm Inch			
T34-PH17B06-3/8-24-21R	10139421	EGUNF3/8-24	10,899 0.429	24.0	4,43 0.174	12,0 0.472	66 2.598	85,57 3.369	90,0 3.543	8,0 0.315	8.00X6.00	9,8 0.386	3	B
T34-PH17B06-7/16-20-21R	10139422	EGUNF7/16-20	12,763 0.502	20.0	6,2 0.244	15,0 0.591	73 2.874	93,8 3.693	100,0 3.937	9,0 0.354	9.00X7.00	11,5 0.453	3	B
T34-PH17B06-1/2-20-21R	10139423	EGUNF1/2-20	14,351 0.565	20.0	6,2 0.244	15,0 0.591	71 2.795	93,8 3.693	100,0 3.937	11,0 0.433	11.00X9.00	13,1 0.516	3	B
T34-PH17B06-9/16-18-21R	10139424	EGUNF9/16-18	16,121 0.635	18.0	6,9 0.272	15,0 0.591	58 2.283	93,1 3.665	100,0 3.937	12,0 0.472	12.00X9.00	14,7 0.579	4	B
T34-PH17B06-5/8-18-21R	10139425	EGUNF5/8-18	17,709 0.697	18.0	6,9 0.272	15,0 0.591	66 2.598	103,1 4.059	110,0 4.331	14,0 0.551	14.00X11.00	16,25 0.640	4	B
T34-PH17B06-3/4-16-21R	10139426	EGUNF3/4-16	21,112 0.831	16.0	7,9 0.311	17,0 0.669	80 3.150	117,1 4.610	125,0 4.921	16,0 0.630	16.00X12.00	19,5 0.768	4	B

Thread turning

MDT

Mini-Shaft™

Thread milling

Thread tapping

Annex

T34-R45HC-micro

Blind holes – Metric coarse threads

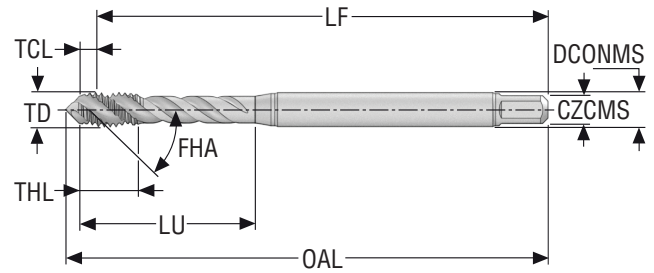

- Substrate: HSS-PM
- Coating: TiAlN + WC/C
- Standard: DIN371
- Thread tolerance class: 4H
- FHA = 45°
- For cutting data see page(s) 263

Designation	Item number	TDZ	Pitch	TCL	THL	LU	LF	OAL	DCONMS	CZCMS	PHDR Ø	NOF	THCT
			mm	mm <i>Inch</i>	mm <i>Inch</i>	mm <i>Inch</i>	mm <i>Inch</i>	mm <i>Inch</i>	mm <i>Inch</i>	mm <i>Inch</i>	mm <i>Inch</i>		
T34-R45H01C03-1X0.25-41R	10138952	M1	0,25	0,59 <i>0.023</i>	6,0 <i>0.236</i>	13 <i>0.512</i>	39,41 <i>1.552</i>	40,9 <i>1.610</i>	2,5 <i>0.098</i>	2.50X2.10	0,75 <i>0.030</i>	2	C
T34-R45H01C03-1.1X0.25-41R	10138953	M1.1	0,25	0,59 <i>0.023</i>	6,0 <i>0.236</i>	13 <i>0.512</i>	39,41 <i>1.552</i>	41,0 <i>1.614</i>	2,5 <i>0.098</i>	2.50X2.10	0,85 <i>0.033</i>	2	C
T34-R45H01C03-1.2X0.25-41R	10138954	M1.2	0,25	0,59 <i>0.023</i>	6,0 <i>0.236</i>	13 <i>0.512</i>	39,41 <i>1.552</i>	41,1 <i>1.618</i>	2,5 <i>0.098</i>	2.50X2.10	0,95 <i>0.037</i>	2	C
T34-R45H01C03-1.4X0.3-41R	10138955	M1.4	0,3	0,69 <i>0.027</i>	8,0 <i>0.315</i>	13 <i>0.512</i>	39,31 <i>1.548</i>	41,3 <i>1.626</i>	2,5 <i>0.098</i>	2.50X2.10	1,1 <i>0.043</i>	2	C

Thread turning

MDT

Mini-Shaft™

Thread milling

Thread tapping

Annex

T34-R45HC-micro

Blind holes – Metric coarse threads

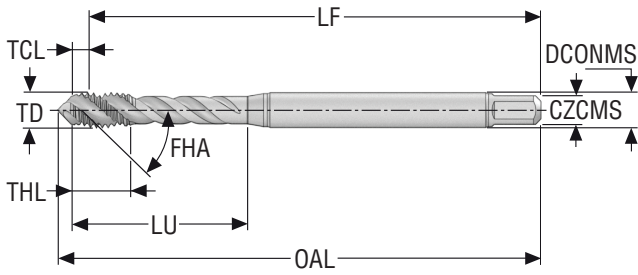

- Substrate: HSS-PM
- Coating: TiAlN + WC/C
- Standard: DIN371
- Thread tolerance class: 6H
- FHA = 45°
- For cutting data see page(s) 263

Designation	Item number	TDZ	Pitch	TCL	THL	LU	LF	OAL	DCONMS	CZCMS	PHDR Ø	NOF	THCHT
			mm	mm <i>Inch</i>	mm <i>Inch</i>	mm <i>Inch</i>	mm <i>Inch</i>	mm <i>Inch</i>	mm <i>Inch</i>	mm <i>Inch</i>	mm <i>Inch</i>		
T34-R45H01C03-1.6X0.35-63R	10138956	M1.6	0,35	0,8 <i>0.031</i>	8,0 <i>0.315</i>	13 <i>0.512</i>	39,2 <i>1.543</i>	41,4 <i>1.630</i>	2,5 <i>0.098</i>	2.50X2.10	1,25 <i>0.049</i>	2	C
T34-R45H01C03-1.7X0.35-63R	10138957	M1.7	0,35	0,8 <i>0.031</i>	8,0 <i>0.315</i>	13 <i>0.512</i>	39,2 <i>1.543</i>	41,5 <i>1.634</i>	2,5 <i>0.098</i>	2.50X2.10	1,35 <i>0.053</i>	2	C
T34-R45H01C03-1.8X0.35-63R	10138958	M1.8	0,35	0,8 <i>0.031</i>	8,0 <i>0.315</i>	13 <i>0.512</i>	39,2 <i>1.543</i>	41,6 <i>1.638</i>	2,5 <i>0.098</i>	2.50X2.10	1,45 <i>0.057</i>	2	C
T34-R45H01C03-2X0.4-63R	10138959	M2	0,4	1,05 <i>0.041</i>	10,0 <i>0.394</i>	13 <i>0.512</i>	43,95 <i>1.730</i>	46,3 <i>1.823</i>	2,8 <i>0.110</i>	2.80X2.10	1,6 <i>0.063</i>	2	C
T34-R45H01C03-2.2X0.45-63R	10138960	M2.2	0,45	1,15 <i>0.045</i>	10,0 <i>0.394</i>	13 <i>0.512</i>	43,85 <i>1.726</i>	46,3 <i>1.823</i>	2,8 <i>0.110</i>	2.80X2.10	1,75 <i>0.069</i>	2	C
T34-R45H01C03-2.3X0.4-63R	10138961	M2.3	0,4	1,05 <i>0.041</i>	10,0 <i>0.394</i>	13 <i>0.512</i>	43,95 <i>1.730</i>	46,3 <i>1.823</i>	2,8 <i>0.110</i>	2.80X2.10	1,9 <i>0.075</i>	2	C
T34-R45H01C03-2.5X0.45-63R	10138962	M2.5	0,45	1,06 <i>0.042</i>	5,0 <i>0.197</i>	14 <i>0.551</i>	48,94 <i>1.927</i>	51,7 <i>2.035</i>	2,8 <i>0.110</i>	2.80X2.10	2,05 <i>0.081</i>	2	C
T34-R45H01C03-2.6X0.45-63R	10138963	M2.6	0,45	1,15 <i>0.045</i>	5,0 <i>0.197</i>	14 <i>0.551</i>	48,85 <i>1.923</i>	51,7 <i>2.035</i>	2,8 <i>0.110</i>	2.80X2.10	2,15 <i>0.085</i>	2	C

Thread turning

MDT

Mini-Shaft™

Thread milling

Thread tapping

Annex

T34-R45HC

Blind holes – Metric coarse threads

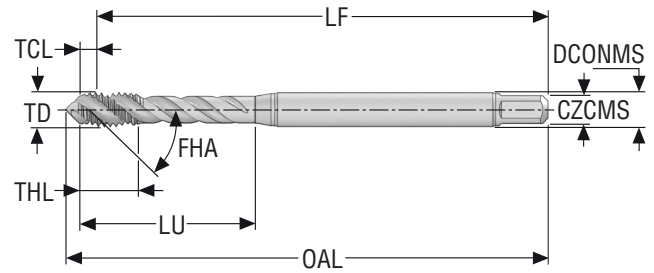

- Substrate: HSSE-PM
- Coating: TiAlN + WC/C
- Standard: DIN371
- Thread tolerance class: 6HX
- FHA = 45°
- For cutting data see page(s) 263

Designation	Item number	TDZ	Pitch	TCL	THL	LU	LF	OAL	DCONMS	CZCMS	PHDR Ø	NOF	THCT
			mm	mm <i>Inch</i>	mm <i>Inch</i>	mm <i>Inch</i>	mm <i>Inch</i>	mm <i>Inch</i>	mm <i>Inch</i>	mm <i>Inch</i>	mm <i>Inch</i>		
T34-R45H01C03-3X0.5-65R	10138964	M3	0,5	1,2 <i>0.047</i>	5,0 <i>0.197</i>	18 <i>0.709</i>	54,8 <i>2.157</i>	57,2 <i>2.252</i>	3,5 <i>0.138</i>	3.50X2.70	2,5 <i>0.098</i>	3	C
T34-R45H01C03-3.5X0.6-65R	10138966	M3.5	0,6	1,31 <i>0.052</i>	6,0 <i>0.236</i>	20 <i>0.787</i>	54,69 <i>2.153</i>	57,4 <i>2.260</i>	4,0 <i>0.157</i>	4.00X3.00	2,9 <i>0.114</i>	3	C
T34-R45H01C03-4X0.7-65R	10138967	M4	0,7	1,82 <i>0.072</i>	7,0 <i>0.276</i>	21 <i>0.827</i>	61,18 <i>2.409</i>	64,6 <i>2.543</i>	4,5 <i>0.177</i>	4.50X3.40	3,3 <i>0.130</i>	3	C
T34-R45H01C03-4.5X0.75-65R	10138968	M4.5	0,75	1,82 <i>0.072</i>	7,5 <i>0.295</i>	25 <i>0.984</i>	68,18 <i>2.684</i>	71,8 <i>2.827</i>	6,0 <i>0.236</i>	6.00X4.90	3,8 <i>0.150</i>	3	C
T34-R45H01C03-5X0.8-65R	10138969	M5	0,8	2,01 <i>0.079</i>	8,0 <i>0.315</i>	25 <i>0.984</i>	67,99 <i>2.677</i>	72,0 <i>2.835</i>	6,0 <i>0.236</i>	6.00X4.90	4,2 <i>0.165</i>	3	C
T34-R45H01C03-6X1-65R	10138970	M6	1,0	2,32 <i>0.091</i>	10,0 <i>0.394</i>	30 <i>1.181</i>	77,68 <i>3.058</i>	82,4 <i>3.244</i>	6,0 <i>0.236</i>	6.00X4.90	5,0 <i>0.197</i>	3	C
T34-R45H01C03-8X1.25-65R	10138971	M8	1,25	3,16 <i>0.124</i>	13,0 <i>0.512</i>	35 <i>1.378</i>	86,84 <i>3.419</i>	91,7 <i>3.610</i>	8,0 <i>0.315</i>	8.00X6.20	6,8 <i>0.268</i>	3	C
T34-R45H01C03-10X1.5-65R	10138972	M10	1,5	3,81 <i>0.150</i>	15,0 <i>0.591</i>	39 <i>1.535</i>	96,19 <i>3.787</i>	101,8 <i>4.008</i>	10,0 <i>0.394</i>	10.00X8.00	8,5 <i>0.335</i>	3	C

Thread turning

MDT

Mini-Shaft™

Thread milling

Thread tapping

Annex

T34-R45HC

Blind holes – Metric coarse threads

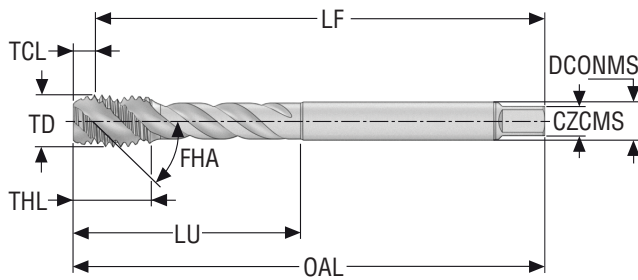

- Substrate: HSSE-PM
- Coating: TiAlN + WC/C
- Standard: DIN376
- Thread tolerance class: 6HX
- FHA = 45°
- For cutting data see page(s) 263

Designation	Item number	TDZ	Pitch	TCL	THL	LU	LF	OAL	DCONMS	CZCMS	PHDR Ø	NOF	THCT
			mm	mm <i>Inch</i>	mm <i>Inch</i>	mm <i>Inch</i>	mm <i>Inch</i>	mm <i>Inch</i>	mm <i>Inch</i>	mm <i>Inch</i>	mm <i>Inch</i>		
T34-R45H01C06-12X1.75-65R	10138973	M12	1,75	4,47 0.176	18,0 0.709	83 3.268	105,53 4.155	110,0 4.331	9,0 0.354	9.00X7.00	10,2 0.402	3	C
T34-R45H01C06-14X2-65R	10138974	M14	2,0	5,11 0.201	20,0 0.787	81 3.189	104,89 4.130	110,0 4.331	11,0 0.433	11.00X9.00	12,0 0.472	4	C
T34-R45H01C06-16X2-65R	10138975	M16	2,0	5,21 0.205	20,0 0.787	68 2.677	104,79 4.126	110,0 4.331	12,0 0.472	12.00X9.00	14,0 0.551	4	C
T34-R45H01C06-18X2.5-65R	10138976	M18	2,5	6,28 0.247	25,0 0.984	81 3.189	118,72 4.674	125,0 4.921	14,0 0.551	14.00X11.00	15,5 0.610	4	C
T34-R45H01C06-20X2.5-65R	10138977	M20	2,5	6,28 0.247	25,0 0.984	95 3.740	133,72 5.265	140,0 5.512	16,0 0.630	16.00X12.00	17,5 0.689	4	C
T34-R45H01C06-22X2.5-65R	10138978	M22	2,5	6,28 0.247	25,0 0.984	93 3.661	133,72 5.265	140,0 5.512	18,0 0.709	18.00X14.50	19,5 0.768	4	C
T34-R45H01C06-24X3-65R	10138979	M24	3,0	7,48 0.294	30,0 1.181	113 4.449	152,52 6.005	160,0 6.299	18,0 0.709	18.00X14.50	21,0 0.827	4	C
T34-R45H01C06-27X3-65R	10138980	M27	3,0	7,68 0.302	30,0 1.181	97 3.819	152,32 5.997	160,0 6.299	20,0 0.787	20.00X16.00	24,0 0.945	4	C
T34-R45H01C06-30X3.5-65R	10138981	M30	3,5	8,75 0.344	35,0 1.378	115 4.528	171,25 6.742	180,0 7.087	22,0 0.866	22.00X18.00	26,5 1.043	4	C
T34-R45H01C06-33X3.5-65R	10138982	M33	3,5	8,75 0.344	35,0 1.378	113 4.449	171,25 6.742	180,0 7.087	25,0 0.984	25.00X20.00	29,5 1.161	4	C
T34-R45H01C06-36X4-65R	10138983	M36	4,0	10,02 0.394	40,0 1.575	131 5.157	189,98 7.480	200,0 7.874	28,0 1.102	28.00X22.00	32,0 1.260	4	C

T34-R45HE

Blind holes – Metric coarse threads

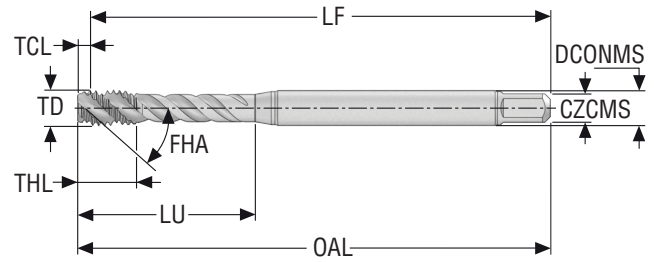

- Internal coolant
- Substrate: HSSE-PM
- Coating: TiAlN + WC/C
- Standard: DIN371
- Thread tolerance class: 6HX
- FHA = 45°
- For cutting data see page(s) 263

Designation	Item number	TDZ	Pitch	TCL	THL	LU	LF	OAL	DCONMS	CZCMS	PHDR Ø	NOF	THCHT
			mm	mm <i>Inch</i>	mm <i>Inch</i>	mm <i>Inch</i>	mm <i>Inch</i>	mm <i>Inch</i>	mm <i>Inch</i>	mm <i>Inch</i>	mm <i>Inch</i>		
T34-R45H01E03-3X0.5-65R	10138991	M3	0,5	0,81 0.032	5,0 0.197	18 0.709	55,19 2.173	56,0 2.205	3,5 0.138	3.50X2.70	2,5 0.098	3	E
T34-R45H01E03-3.5X0.6-65R	10138992	M3.5	0,6	0,94 0.037	6,0 0.236	20 0.787	55,06 2.168	56,0 2.205	4,0 0.157	4.00X3.00	2,9 0.114	3	E
T34-R45H01E03-4X0.7-65R	10138993	M4	0,7	1,18 0.046	7,0 0.276	21 0.827	61,82 2.434	63,0 2.480	4,5 0.177	4.50X3.40	3,3 0.130	3	E
T34-R45H01E03-4.5X0.75-65R	10138994	M4.5	0,75	1,18 0.046	7,5 0.295	25 0.984	68,82 2.709	70,0 2.756	6,0 0.236	6.00X4.90	3,8 0.150	3	E
T34-R45H01E03-5X0.8-65R	10138995	M5	0,8	1,31 0.052	8,0 0.315	25 0.984	68,69 2.704	70,0 2.756	6,0 0.236	6.00X4.90	4,2 0.165	3	E
T34-R45H01E03-6X1-65R	10138996	M6	1,0	1,57 0.062	10,0 0.394	30 1.181	78,43 3.088	80,0 3.150	6,0 0.236	6.00X4.90	5,0 0.197	3	E
T34-R45H01E03-8X1.25-65R	10138997	M8	1,25	2,23 0.088	13,0 0.512	35 1.378	87,77 3.456	90,0 3.543	8,0 0.315	8.00X6.20	6,8 0.268	3	E
T34-R45H01E03-10X1.5-65R	10138998	M10	1,5	2,6 0.102	15,0 0.591	39 1.535	97,4 3.835	100,0 3.937	10,0 0.394	10.00X8.00	8,5 0.335	3	E

Thread turning

MDT

Mini-Shaft™

Thread milling

Thread tapping

Annex

T34-R45HE

Blind holes – Metric coarse threads

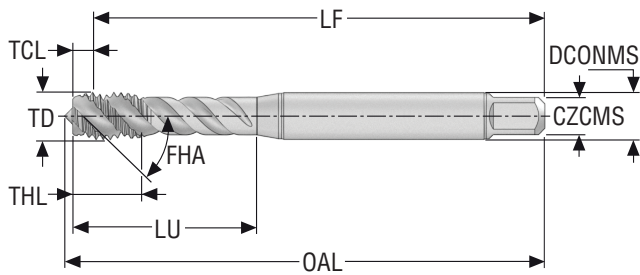

- Substrate: HSSE-PM
- Coating: TiAlN + WC/C
- Standard: DIN376
- Thread tolerance class: 6HX
- FHA = 45°
- For cutting data see page(s) 263

Designation	Item number	TDZ	Pitch	TCL	THL	LU	LF	OAL	DCONMS	CZCMS	PHDR Ø	NOF	THCHT
			mm	mm <i>Inch</i>	mm <i>Inch</i>	mm <i>Inch</i>	mm <i>Inch</i>	mm <i>Inch</i>	mm <i>Inch</i>	mm <i>Inch</i>	mm <i>Inch</i>		
T34-R45H01E06-12X1.75-65R	10138999	M12	1,75	3,18 <i>0.125</i>	18,0 <i>0.709</i>	83 <i>3.268</i>	106,82 <i>4.206</i>	110,0 <i>4.331</i>	9,0 <i>0.354</i>	9.00X7.00	10,2 <i>0.402</i>	3	E
T34-R45H01E06-14X2-65R	10139000	M14	2,0	3,65 <i>0.144</i>	20,0 <i>0.787</i>	81 <i>3.189</i>	106,35 <i>4.187</i>	110,0 <i>4.331</i>	11,0 <i>0.433</i>	11.00X9.00	12,0 <i>0.472</i>	4	E
T34-R45H01E06-16X2-65R	10139001	M16	2,0	3,75 <i>0.148</i>	20,0 <i>0.787</i>	68 <i>2.677</i>	106,25 <i>4.183</i>	110,0 <i>4.331</i>	12,0 <i>0.472</i>	12.00X9.00	14,0 <i>0.551</i>	4	E

T34A-R45HC

Blind holes – Metric coarse threads

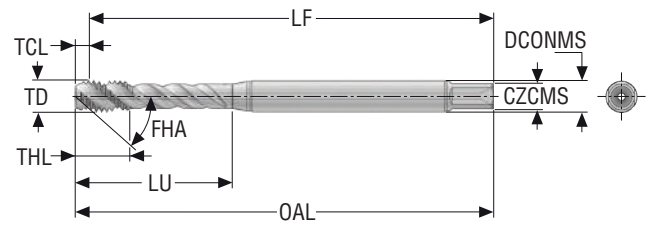

- Internal coolant
- Substrate: HSSE-PM
- Coating: TiAIN + WC/C
- Standard: DIN371
- Thread tolerance class: 6HX
- FHA = 45°
- For cutting data see page(s) 263

Designation	Item number	TDZ	Pitch	TCL	THL	LU	LF	OAL	DCONMS	CZCMS	PHDR Ø	NOF	THCHT
			mm	mm <i>Inch</i>	mm <i>Inch</i>	mm <i>Inch</i>	mm <i>Inch</i>	mm <i>Inch</i>	mm <i>Inch</i>	mm <i>Inch</i>	mm <i>Inch</i>		
T34A-R45H01C03-5X0.8-65R	10138984	M5	0,8	1,94 0.076	8,0 0.315	25 0.984	68,06 2.680	70,0 2.756	6,0 0.236	6.00X4.90	4,2 0.165	3	C
T34A-R45H01C03-6X1-65R	10138985	M6	1,0	2,32 0.091	10,0 0.394	30 1.181	77,68 3.058	80,0 3.150	6,0 0.236	6.00X4.90	5,0 0.197	3	C
T34A-R45H01C03-8X1.25-65R	10138986	M8	1,25	3,16 0.124	13,0 0.512	35 1.378	86,84 3.419	90,0 3.543	8,0 0.315	8.00X6.20	6,8 0.268	3	C
T34A-R45H01C05-10X1.5-65R	10138987	M10	1,5	3,81 0.150	17,0 0.669	39 1.535	96,19 3.787	100,0 3.937	10,0 0.394	10.00X8.00	8,5 0.335	3	C

Thread turning

MDT

Mini-Shaft™

Thread milling

Thread tapping

Annex

T34A-R45HC

Blind holes – Metric coarse threads

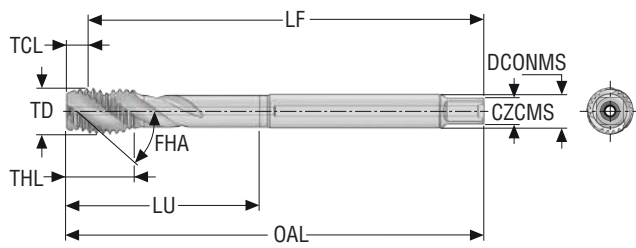

- Internal coolant
- Substrate: HSSE-PM
- Coating: TiAlN + WC/C
- Standard: DIN376
- Thread tolerance class: 6HX
- FHA = 45°
- For cutting data see page(s) 263

Designation	Item number	TDZ	Pitch	TCL	THL	LU	LF	OAL	DCONMS	CZCMS	PHDR Ø	NOF	THCHT
			mm	mm <i>Inch</i>	mm <i>Inch</i>	mm <i>Inch</i>	mm <i>Inch</i>	mm <i>Inch</i>	mm <i>Inch</i>	mm <i>Inch</i>	mm <i>Inch</i>		
T34A-R45H01C06-12X1.75-65R	10138988	M12	1,75	4,47 0.176	18,0 0.709	83 3.268	105,53 4.155	110,0 4.331	9,0 0.354	9.00X7.00	10,2 0.402	3	C
T34A-R45H01C06-14X2-65R	10138989	M14	2,0	5,11 0.201	20,0 0.787	81 3.189	104,89 4.130	110,0 4.331	11,0 0.433	11.00X9.00	12,0 0.472	4	C
T34A-R45H01C06-16X2-65R	10138990	M16	2,0	5,21 0.205	20,0 0.787	68 2.677	104,79 4.126	110,0 4.331	12,0 0.472	12.00X9.00	14,0 0.551	4	C

Thread turning

MDT

Mini-Shaft™

Thread milling

Thread tapping

Annex

T34-R45HC

Blind holes – MF threads

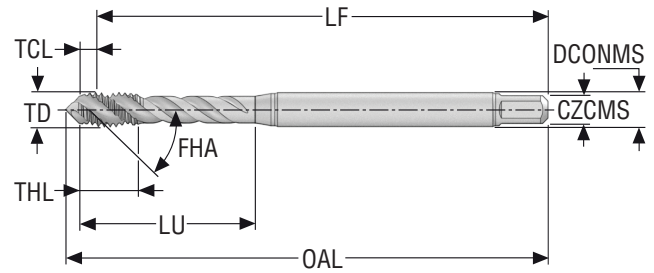

- Substrate: HSSE-PM
- Coating: TiAlN + WC/C
- Standard: DIN371
- Thread tolerance class: 6HX
- FHA = 45°
- For cutting data see page(s) 263

Designation	Item number	TDZ	Pitch	TCL	THL	LU	LF	OAL	DCONMS	CZCMS	PHDR Ø	NOF	THCT
			mm	mm <i>Inch</i>	mm <i>Inch</i>	mm <i>Inch</i>	mm <i>Inch</i>	mm <i>Inch</i>	mm <i>Inch</i>	mm <i>Inch</i>	mm <i>Inch</i>		
T34-R45H02C03-3X0.35-65R	10139002	MF3X0.35	0,35	0,7 <i>0.028</i>	5,0 <i>0.197</i>	18 <i>0.709</i>	55,3 <i>2.177</i>	57,2 <i>2.252</i>	3,5 <i>0.138</i>	3.50X2.70	2,65 <i>0.104</i>	3	C
T34-R45H02C03-3.5X0.35-65R	10139003	MF3.5X0.35	0,35	0,69 <i>0.027</i>	5,0 <i>0.197</i>	20 <i>0.787</i>	55,31 <i>2.178</i>	57,4 <i>2.260</i>	4,0 <i>0.157</i>	4.00X3.00	3,15 <i>0.124</i>	3	C
T34-R45H02C03-4X0.5-65R	10139004	MF4X0.5	0,5	1,31 <i>0.052</i>	7,0 <i>0.276</i>	21 <i>0.827</i>	61,69 <i>2.429</i>	64,6 <i>2.543</i>	4,5 <i>0.177</i>	4.50X3.40	3,5 <i>0.138</i>	3	C
T34-R45H02C03-5X0.5-65R	10139005	MF5X0.5	0,5	1,2 <i>0.047</i>	8,0 <i>0.315</i>	25 <i>0.984</i>	68,8 <i>2.709</i>	72,0 <i>2.835</i>	6,0 <i>0.236</i>	6.00X4.90	4,5 <i>0.177</i>	3	C
T34-R45H02C03-6X0.5-65R	10139006	MF6X0.5	0,5	1,22 <i>0.048</i>	10,0 <i>0.394</i>	30 <i>1.181</i>	78,78 <i>3.102</i>	82,4 <i>3.244</i>	6,0 <i>0.236</i>	6.00X4.90	5,5 <i>0.217</i>	3	C
T34-R45H02C03-6X0.75-65R	10139007	MF6X0.75	0,75	1,77 <i>0.070</i>	10,0 <i>0.394</i>	30 <i>1.181</i>	78,23 <i>3.080</i>	82,4 <i>3.244</i>	6,0 <i>0.236</i>	6.00X4.90	5,2 <i>0.205</i>	3	C
T34-R45H02C03-8X0.75-65R	10139008	MF8X0.75	0,75	2,07 <i>0.081</i>	10,0 <i>0.394</i>	30 <i>1.181</i>	77,93 <i>3.068</i>	81,7 <i>3.217</i>	8,0 <i>0.315</i>	8.00X6.20	7,2 <i>0.283</i>	3	C
T34-R45H02C03-8X1-65R	10139009	MF8X1.0	1,0	2,62 <i>0.103</i>	13,0 <i>0.512</i>	35 <i>1.378</i>	87,38 <i>3.440</i>	91,7 <i>3.610</i>	8,0 <i>0.315</i>	8.00X6.20	7,0 <i>0.276</i>	3	C
T34-R45H02C03-10X0.75-65R	10139011	MF10X0.75	0,75	2,17 <i>0.085</i>	13,0 <i>0.512</i>	35 <i>1.378</i>	87,83 <i>3.458</i>	91,8 <i>3.614</i>	10,0 <i>0.394</i>	10.00X8.00	9,2 <i>0.362</i>	3	C
T34-R45H02C03-10X1-65R	10139012	MF10X1.0	1,0	2,72 <i>0.107</i>	13,0 <i>0.512</i>	35 <i>1.378</i>	87,28 <i>3.436</i>	91,8 <i>3.614</i>	10,0 <i>0.394</i>	10.00X8.00	9,0 <i>0.354</i>	3	C
T34-R45H02C03-10X1.25-65R	10139013	MF10X1.25	1,25	3,26 <i>0.128</i>	15,0 <i>0.591</i>	39 <i>1.535</i>	96,74 <i>3.809</i>	101,8 <i>4.008</i>	10,0 <i>0.394</i>	10.00X8.00	8,8 <i>0.346</i>	3	C

Thread turning

MDT

Mini-Shaft™

Thread milling

Thread tapping

Annex

T34-R45HC

Blind holes – MF threads

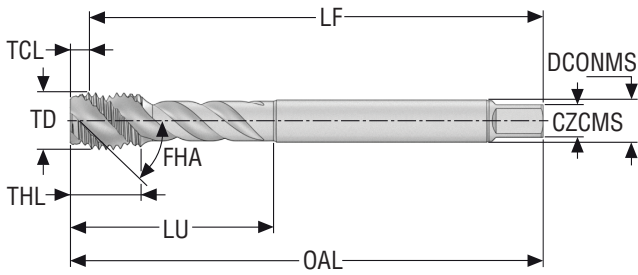

- Substrate: HSSE-PM
- Coating: TiAlN + WC/C
- Standard: DIN374
- Thread tolerance class: 6HX
- FHA = 45°
- For cutting data see page(s) 263

Designation	Item number	TDZ	Pitch	TCL	THL	LU	LF	OAL	DCONMS	CZCMS	PHDR Ø	NOF	THCHT
			mm	mm <i>Inch</i>	mm <i>Inch</i>	mm <i>Inch</i>	mm <i>Inch</i>	mm <i>Inch</i>	mm <i>Inch</i>	mm <i>Inch</i>	mm <i>Inch</i>		
T34-R45H02C05-8X1-65R	10139014	MF8X1.0	1,0	2,62 0.103	10,0 0.394	35 1.378	87,38 3.440	90,0 3.543	6,0 0.236	6.00X4.90	7,0 0.276	3	C
T34-R45H02C05-10X1-65R	10139015	MF10X1.0	1,0	2,62 0.103	10,0 0.394	35 1.378	87,38 3.440	90,0 3.543	7,0 0.276	7.00X5.50	9,0 0.354	3	C
T34-R45H02C05-12X1-65R	10139016	MF12X1.0	1,0	2,83 0.111	10,0 0.394	73 2.874	97,17 3.826	100,0 3.937	9,0 0.354	9.00X7.00	11,0 0.433	3	C
T34-R45H02C05-12X1.25-65R	10139017	MF12X1.25	1,25	3,38 0.133	15,0 0.591	73 2.874	96,62 3.804	100,0 3.937	9,0 0.354	9.00X7.00	10,8 0.425	3	C
T34-R45H02C05-12X1.5-65R	10139018	MF12X1.5	1,5	3,93 0.155	15,0 0.591	73 2.874	96,07 3.782	100,0 3.937	9,0 0.354	9.00X7.00	10,5 0.413	3	C
T34-R45H02C05-14X1.5-65R	10139019	MF14X1.5	1,5	4,03 0.159	15,0 0.591	71 2.795	95,97 3.778	100,0 3.937	11,0 0.433	11.00X9.00	12,5 0.492	4	C
T34-R45H02C05-16X1.5-65R	10139020	MF16X1.5	1,5	4,13 0.163	15,0 0.591	58 2.283	95,87 3.774	100,0 3.937	12,0 0.472	12.00X9.00	14,5 0.571	4	C
T34-R45H02C05-18X1.5-65R	10139021	MF18X1.5	1,5	4,13 0.163	17,0 0.669	66 2.598	105,87 4.168	110,0 4.331	14,0 0.551	14.00X11.00	16,5 0.650	4	C
T34-R45H02C05-20X1.5-65R	10139022	MF20X1.5	1,5	4,13 0.163	17,0 0.669	80 3.150	120,87 4.759	125,0 4.921	16,0 0.630	16.00X12.00	18,5 0.728	4	C
T34-R45H02C05-22X1.5-65R	10139023	MF22X1.5	1,5	4,13 0.163	17,0 0.669	78 3.071	120,87 4.759	125,0 4.921	18,0 0.709	18.00X14.50	20,5 0.807	4	C
T34-R45H02C05-24X1.5-65R	10139024	MF24X1.5	1,5	4,25 0.167	20,0 0.787	93 3.661	135,75 5.344	140,0 5.512	18,0 0.709	18.00X14.50	22,5 0.886	4	C

Thread turning

MDT

Mini-Shaft™

Thread milling

Thread tapping

Annex

T34-R45HE

Blind holes – MF threads

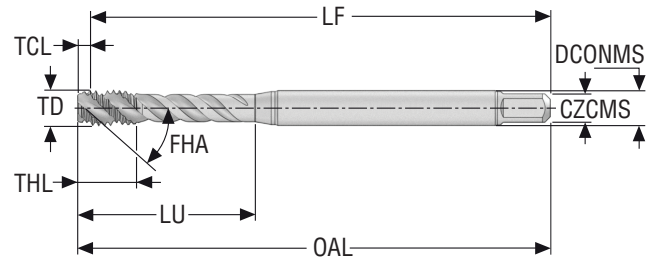

- Substrate: HSSE-PM
- Coating: TiAlN + WC/C
- Standard: DIN371
- Thread tolerance class: 6HX
- FHA = 45°
- For cutting data see page(s) 263

Designation	Item number	TDZ	Pitch	TCL	THL	LU	LF	OAL	DCONMS	CZCMS	PHDR Ø	NOF	THCT
			mm	mm <i>Inch</i>	mm <i>Inch</i>	mm <i>Inch</i>	mm <i>Inch</i>	mm <i>Inch</i>	mm <i>Inch</i>		mm <i>Inch</i>		
T34-R45H02E03-8X1-65R	10139032	MF8X1.0	1,0	1,87 <i>0.074</i>	13,0 <i>0.512</i>	35 <i>1.378</i>	88,13 <i>3.470</i>	90,0 <i>3.543</i>	8,0 <i>0.315</i>	8.00X6.20	7,0 <i>0.276</i>	3	E
T34-R45H02E03-10X1-65R	10139033	MF10X1.0	1,0	1,97 <i>0.078</i>	13,0 <i>0.512</i>	35 <i>1.378</i>	88,03 <i>3.466</i>	90,0 <i>3.543</i>	10,0 <i>0.394</i>	10.00X8.00	9,0 <i>0.354</i>	3	E

Thread turning

MDT

Mini-Shaft™

Thread milling

Thread tapping

Annex

T34-R45HE

Blind holes – MF threads

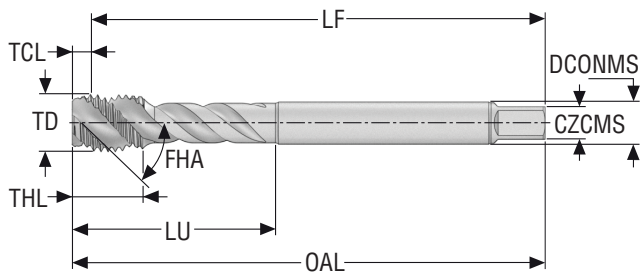

- Substrate: HSSE-PM
- Coating: TiAlN + WC/C
- Standard: DIN374
- Thread tolerance class: 6HX
- FHA = 45°
- For cutting data see page(s) 263

Designation	Item number	TDZ	Pitch	TCL	THL	LU	LF	OAL	DCONMS	CZCMS	PHDR Ø	NOF	THCHT
			mm	mm	mm	mm	mm	mm	mm		mm		
			Inch	Inch	Inch	Inch	Inch	Inch	Inch		Inch		
T34-R45H02E05-8X1-65R	10139034	MF8X1.0	1,0	1,87 0.074	10,0 0.394	35 1.378	88,13 3.470	90,0 3.543	6,0 0.236	6.00X4.90	7,0 0.276	3	E
T34-R45H02E05-10X1-65R	10139035	MF10X1.0	1,0	1,87 0.074	10,0 0.394	35 1.378	88,13 3.470	90,0 3.543	7,0 0.276	7.00X5.50	9,0 0.354	3	E
T34-R45H02E05-12X1.5-65R	10139036	MF12X1.5	1,5	2,81 0.111	15,0 0.591	73 2.874	97,19 3.826	100,0 3.937	9,0 0.354	9.00X7.00	10,5 0.413	3	E
T34-R45H02E05-14X1.5-65R	10139037	MF14X1.5	1,5	3,01 0.119	15,0 0.591	71 2.795	96,99 3.819	100,0 3.937	11,0 0.433	11.00X9.00	12,5 0.492	4	E
T34-R45H02E05-16X1.5-65R	10139038	MF16X1.5	1,5	3,01 0.119	15,0 0.591	58 2.283	96,99 3.819	100,0 3.937	12,0 0.472	12.00X9.00	14,5 0.571	4	E

Thread turning

MDT

Mini-Shaft™

Thread milling

Thread tapping

Annex

T34A-R45HC

Blind holes – MF threads

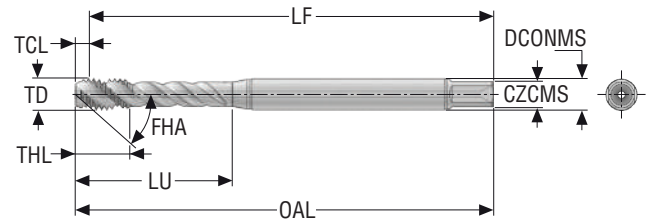

- Internal coolant
- Substrate: HSSE-PM
- Coating: TiAIN + WC/C
- Standard: DIN371
- Thread tolerance class: 6HX
- FHA = 45°
- For cutting data see page(s) 263

Designation	Item number	TDZ	Pitch	TCL	THL	LU	LF	OAL	DCONMS	CZCMS	PHDR Ø	NOF	THCHT
			mm	mm <i>Inch</i>	mm <i>Inch</i>	mm <i>Inch</i>	mm <i>Inch</i>	mm <i>Inch</i>	mm <i>Inch</i>	mm <i>Inch</i>	mm <i>Inch</i>		
T34A-R45H02C03-8X1-65R	10139025	MF8X1.0	1,0	2,62 0.103	13,0 0.512	35 1.378	87,38 3.440	90,0 3.543	8,0 0.315	8.00X6.20	7,0 0.276	3	C
T34A-R45H02C03-10X1-65R	10139026	MF10X1.0	1,0	2,72 0.107	13,0 0.512	35 1.378	87,28 3.436	90,0 3.543	10,0 0.394	10.00X8.00	9,0 0.354	3	C

Thread turning

MDT

Mini-Shaft™

Thread milling

Thread tapping

Annex

T34A-R45HC

Blind holes – MF threads

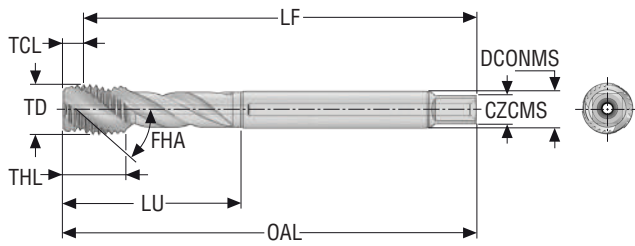

- Internal coolant
- Substrate: HSSE-PM
- Coating: TiAlN + WC/C
- Standard: DIN374
- Thread tolerance class: 6HX
- FHA = 45°
- For cutting data see page(s) 263

Designation	Item number	TDZ	Pitch	TCL	THL	LU	LF	OAL	DCONMS	CZCMS	PHDR Ø	NOF	THCHT
			mm	mm <i>Inch</i>	mm <i>Inch</i>	mm <i>Inch</i>	mm <i>Inch</i>	mm <i>Inch</i>	mm <i>Inch</i>	mm <i>Inch</i>	mm <i>Inch</i>		
T34A-R45H02C05-8X1-65R	10139027	MF8X1.0	1,0	2,62 <i>0.103</i>	10,0 <i>0.394</i>	35 <i>1.378</i>	87,38 <i>3.440</i>	90,0 <i>3.543</i>	6,0 <i>0.236</i>	6.00X4.90	7,0 <i>0.276</i>	3	C
T34A-R45H02C05-10X1-65R	10139028	MF10X1.0	1,0	2,62 <i>0.103</i>	10,0 <i>0.394</i>	35 <i>1.378</i>	87,38 <i>3.440</i>	90,0 <i>3.543</i>	7,0 <i>0.276</i>	7.00X5.50	9,0 <i>0.354</i>	3	C
T34A-R45H02C05-12X1.5-65R	10139029	MF12X1.5	1,5	3,93 <i>0.155</i>	15,0 <i>0.591</i>	73 <i>2.874</i>	96,07 <i>3.782</i>	100,0 <i>3.937</i>	9,0 <i>0.354</i>	9.00X7.00	10,5 <i>0.413</i>	3	C
T34A-R45H02C05-14X1.5-65R	10139030	MF14X1.5	1,5	4,03 <i>0.159</i>	15,0 <i>0.591</i>	71 <i>2.795</i>	95,97 <i>3.778</i>	100,0 <i>3.937</i>	11,0 <i>0.433</i>	11.00X9.00	12,5 <i>0.492</i>	4	C
T34A-R45H02C05-16X1.5-65R	10139031	MF16X1.5	1,5	4,13 <i>0.163</i>	15,0 <i>0.591</i>	58 <i>2.283</i>	95,87 <i>3.774</i>	100,0 <i>3.937</i>	12,0 <i>0.472</i>	12.00X9.00	14,5 <i>0.571</i>	4	C

Thread turning

MDT

Mini-Shaft™

Thread milling

Thread tapping

Annex

T34A-R45HE

Blind holes – MF threads

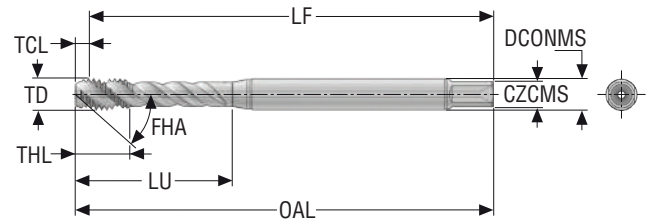

- Internal coolant
- Substrate: HSSE-PM
- Coating: TiAIN + WC/C
- Standard: DIN371
- Thread tolerance class: 6HX
- FHA = 45°
- For cutting data see page(s) 263

Designation	Item number	TDZ	Pitch	TCL	THL	LU	LF	OAL	DCONMS	CZCMS	PHDR Ø	NOF	THCHT
			mm	mm <i>Inch</i>	mm <i>Inch</i>	mm <i>Inch</i>	mm <i>Inch</i>	mm <i>Inch</i>	mm <i>Inch</i>	mm <i>Inch</i>	mm <i>Inch</i>		
T34A-R45H02E03-8X1-65R	10139039	MF8X1.0	1,0	1,87 0.074	13,0 0.512	35 1.378	88,13 3.470	90,0 3.543	8,0 0.315	8.00X6.20	7,0 0.276	3	E
T34A-R45H02E03-10X1-65R	10139040	MF10X1.0	1,0	1,97 0.078	13,0 0.512	35 1.378	88,03 3.466	90,0 3.543	10,0 0.394	10.00X8.00	9,0 0.354	3	E

Thread turning

MDT

Mini-Shaft™

Thread milling

Thread tapping

Annex

T34-R45HC

Blind holes – UNC threads

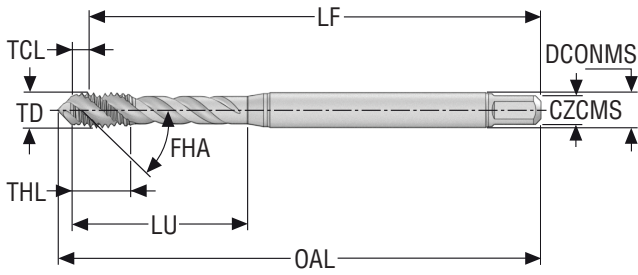

- Substrate: HSSE-PM
- Coating: TiAlN + WC/C
- Standard: DIN371
- Thread tolerance class: 2BX
- FHA = 45°
- For cutting data see page(s) 263

Designation	Item number	TDZ	TD	Pitch	TCL	THL	LU	LF	OAL	DCONMS	CZCMS	PHDR Ø	NOF	THCHT
			mm Inch	TPI	mm Inch	mm Inch	mm Inch	mm Inch	mm Inch	mm Inch	mm Inch	mm Inch		
T34-R45H08C03-4-40-22R	10139054	UNC4-40	2,845 0.112	40.0	1,48 0.058	5,0 0.197	18 0.709	54,52 2.146	56,0 2.205	3,5 0.138	3.50X2.70	2,35 0.093	3	C
T34-R45H08C03-5-40-22R	10139055	UNC5-40	3,175 0.125	40.0	1,53 0.060	7,0 0.276	18 0.709	54,47 2.144	57,2 2.252	3,5 0.138	3.50X2.70	2,65 0.104	3	C
T34-R45H08C03-6-32-22R	10139056	UNC6-32	3,505 0.138	32.0	1,95 0.077	6,0 0.236	20 0.787	54,05 2.128	57,4 2.260	4,0 0.157	4.00X3.00	2,85 0.112	3	C
T34-R45H08C03-8-32-22R	10139057	UNC8-32	4,166 0.164	32.0	1,89 0.074	7,0 0.276	21 0.827	61,11 2.406	64,6 2.543	4,5 0.177	4.50X3.40	3,5 0.138	3	C
T34-R45H08C03-10-24-22R	10139058	UNC10-24	4,826 0.190	24.0	2,53 0.100	8,0 0.315	25 0.984	67,47 2.656	72,0 2.835	6,0 0.236	6.00X4.90	3,9 0.154	3	C
T34-R45H08C03-12-24-22R	10139059	UNC12-24	5,486 0.216	24.0	2,47 0.097	10,0 0.394	30 1.181	77,53 3.052	82,2 3.236	6,0 0.236	6.00X4.90	4,5 0.177	3	C
T34-R45H08C03-1/4-20-22R	10139060	UNC1/4-20	6,35 0.250	20.0	2,94 0.116	13,0 0.512	32 1.260	77,06 3.034	82,4 3.244	7,0 0.276	7.00X5.50	5,1 0.201	3	C
T34-R45H08C03-5/16-18-22R	10139061	UNC5/16-18	7,937 0.312	18.0	3,59 0.141	13,0 0.512	35 1.378	86,41 3.402	90,0 3.543	8,0 0.315	8.00X6.20	6,6 0.260	3	C
T34-R45H08C03-3/8-16-22R	10139062	UNC3/8-16	9,525 0.375	16.0	4,03 0.159	15,0 0.591	39 1.535	95,97 3.778	100,0 3.937	10,0 0.394	10.00X8.00	8,0 0.315	3	C

Thread turning

MDT

Mini-Shaft™

Thread milling

Thread tapping

Annex

T34-R45HC

Blind holes – UNC threads

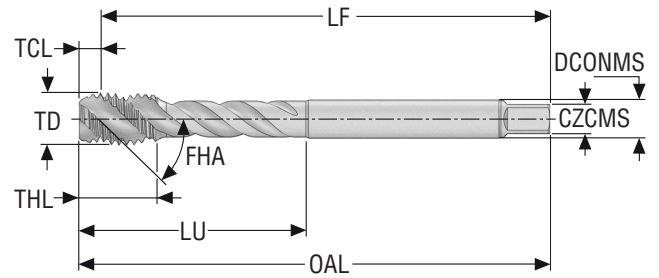

- Substrate: HSSE-PM
- Coating: TiAlN + WC/C
- Standard: DIN376
- Thread tolerance class: 2BX
- FHA = 45°
- For cutting data see page(s) 263

Designation	Item number	TDZ	TD	Pitch	TCL	THL	LU	LF	OAL	DCONMS	CZCMS	PHDR Ø	NOF	THCHT
			mm Inch	TPI	mm Inch	mm Inch	mm Inch	mm Inch	mm Inch	mm Inch	mm Inch	mm Inch		
T34-R45H08C06-7/16-14-22R	10139063	UNC7/16-14	11,112 0.437	14.0	4,65 0.183	15,0 0.591	76 2.992	95,35 3.754	100,0 3.937	8,0 0.315	8.00X6.20	9,3 0.366	3	C
T34-R45H08C06-1/2-13-22R	10139064	UNC1/2-13	12,7 0.500	13.0	4,99 0.196	18,0 0.709	83 3.268	105,01 4.134	110,0 4.331	9,0 0.354	9.00X7.00	10,7 0.421	4	C
T34-R45H08C06-9/16-12-22R	10139065	UNC9/16-12	14,287 0.562	12.0	5,43 0.214	20,0 0.787	81 3.189	104,57 4.117	110,0 4.331	11,0 0.433	11.00X9.00	12,3 0.484	4	C
T34-R45H08C06-5/8-11-22R	10139066	UNC5/8-11	15,875 0.625	11.0	5,87 0.231	22,0 0.866	68 2.677	104,13 4.100	110,0 4.331	12,0 0.472	12.00X9.00	13,5 0.531	4	C

Thread turning

MDT

Mini-Shaft™

Thread milling

Thread tapping

Annex

T34-R45HC

Blind holes – UNF threads

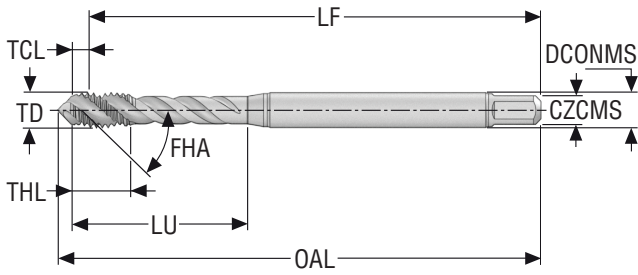

- Substrate: HSSE-PM
- Coating: TiAlN + WC/C
- Standard: DIN371
- Thread tolerance class: 2BX
- FHA = 45°
- For cutting data see page(s) 263

Designation	Item number	TDZ	TD	Pitch	TCL	THL	LU	LF	OAL	DCONMS	CZCMS	PHDR Ø	NOF	THCT
			mm Inch	TPI	mm Inch	mm Inch	mm Inch	mm Inch	mm Inch	mm Inch	mm Inch	mm Inch		
T34-R45H09C03-4-48-22R	10139067	UNF4-48	2,845 0.112	48.0	1,29 0.051	5,0 0.197	18 0.709	54,71 2.154	57,2 2.252	3,5 0.138	3.50X2.70	2,4 0.094	3	C
T34-R45H09C03-5-44-22R	10139068	UNF5-44	3,175 0.125	44.0	1,35 0.053	7,0 0.276	18 0.709	54,65 2.152	57,2 2.252	3,5 0.138	3.50X2.70	2,7 0.106	3	C
T34-R45H09C03-6-40-22R	10139073	UNF6-40	3,505 0.138	40.0	1,59 0.063	6,0 0.236	20 0.787	54,41 2.142	57,4 2.260	4,0 0.157	4.00X3.00	2,95 0.116	3	C
T34-R45H09C03-8-36-22R	10139074	UNF8-36	4,166 0.164	36.0	1,71 0.067	7,0 0.276	21 0.827	61,29 2.413	64,6 2.543	4,5 0.177	4.50X3.40	3,5 0.138	3	C
T34-R45H09C03-10-32-22R	10139075	UNF10-32	4,826 0.190	32.0	2,0 0.079	8,0 0.315	25 0.984	68,0 2.677	72,0 2.835	6,0 0.236	6.00X4.90	4,1 0.161	3	C
T34-R45H09C03-12-28-22R	10139076	UNF12-28	5,486 0.216	28.0	2,11 0.083	10,0 0.394	30 1.181	77,89 3.067	82,2 3.236	6,0 0.236	6.00X4.90	4,6 0.181	3	C
T34-R45H09C03-1/4-28-22R	10139077	UNF1/4-28	6,35 0.250	28.0	2,23 0.088	10,0 0.394	30 1.181	77,77 3.062	82,4 3.244	7,0 0.276	7.00X5.50	5,5 0.217	3	C
T34-R45H09C03-5/16-24-22R	10139078	UNF5/16-24	7,937 0.312	24.0	2,87 0.113	13,0 0.512	35 1.378	87,13 3.430	90,0 3.543	8,0 0.315	8.00X6.20	6,9 0.272	3	C
T34-R45H09C03-3/8-24-22R	10139079	UNF3/8-24	9,525 0.375	24.0	2,96 0.117	15,0 0.591	35 1.378	87,04 3.427	90,0 3.543	10,0 0.394	10.00X8.00	8,5 0.335	3	C

Thread turning

MDT

Mini-Shaft™

Thread milling

Thread tapping

Annex

T34-R45HC

Blind holes – UNF threads

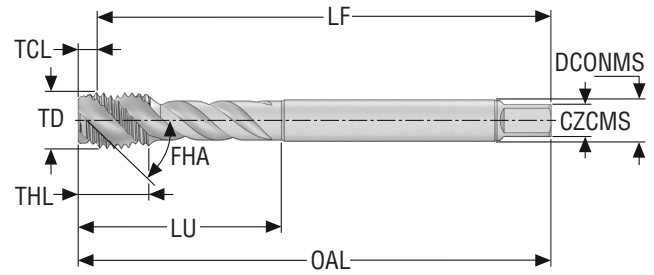

- Substrate: HSSE-PM
- Coating: TiAlN + WC/C
- Standard: DIN374
- Thread tolerance class: 2BX
- FHA = 45°
- For cutting data see page(s) 263

Designation	Item number	TDZ	TD	Pitch	TCL	THL	LU	LF	OAL	DCONMS	CZCMS	PHDR Ø	NOF	THCHT
			mm Inch	TPI	mm Inch	mm Inch	mm Inch	mm Inch	mm Inch	mm Inch	mm Inch	mm Inch		
T34-R45H09C05-7/16-20-22R	10139080	UNF7/16-20	11,112 0.437	20.0	3,39 0.133	15,0 0.591	76 2.992	96,61 3.804	100,0 3.937	8,0 0.315	8.00X6.20	9,9 0.390	3	C
T34-R45H09C05-1/2-20-22R	10139081	UNF1/2-20	12,7 0.500	20.0	3,56 0.140	15,0 0.591	73 2.874	96,44 3.797	100,0 3.937	9,0 0.354	9.00X7.00	11,5 0.453	4	C
T34-R45H09C05-9/16-18-22R	10139082	UNF9/16-18	14,287 0.562	18.0	3,86 0.152	15,0 0.591	71 2.795	96,14 3.785	100,0 3.937	11,0 0.433	11.00X9.00	13,0 0.512	4	C
T34-R45H09C05-5/8-18-22R	10139083	UNF5/8-18	15,875 0.625	18.0	3,91 0.154	15,0 0.591	58 2.283	96,09 3.783	100,0 3.937	12,0 0.472	12.00X9.00	14,5 0.571	4	C

Thread turning

MDT

Mini-Shaft™

Thread milling

Thread tapping

Annex

T34-R45HC

Blind holes – G threads

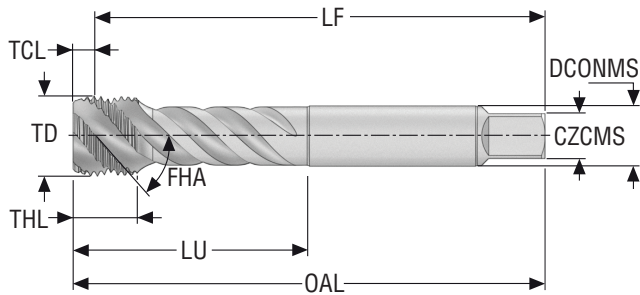

- Substrate: HSSE-PM
- Coating: TiAlN + WC/C
- Standard: DIN5156
- Thread tolerance class: NORMAL-X
- FHA = 45°
- For cutting data see page(s) 263

Designation	Item number	TDZ	TD	Pitch	TCL	THL	LU	LF	OAL	DCONMS	CZCMS	PHDR Ø	NOF	THCHT
			mm Inch	TPI	mm Inch	mm Inch	mm Inch	mm Inch	mm Inch	mm Inch	mm Inch	mm Inch		
T34-R45H21C09-1/8-28-12R	10139084	G1/8-28	9,728 0.383	28.0	2,43 0.096	10,0 0.394	36 1.417	87,57 3.448	90,0 3.543	7,0 0.276	7.00X5.50	8,8 0.346	3	C
T34-R45H21C09-1/4-19-12R	10139085	G1/4-19	13,157 0.518	19.0	3,66 0.144	14,0 0.551	71 2.795	96,34 3.793	100,0 3.937	11,0 0.433	11.00X9.00	11,8 0.465	3	C
T34-R45H21C09-3/8-19-12R	10139086	G3/8-19	16,662 0.656	19.0	3,67 0.144	15,0 0.591	58 2.283	96,33 3.793	100,0 3.937	12,0 0.472	12.00X9.00	15,25 0.600	4	C
T34-R45H21C09-1/2-14-12R	10139087	G1/2-14	20,955 0.825	14.0	4,93 0.194	17,0 0.669	80 3.150	120,07 4.727	125,0 4.921	16,0 0.630	16.00X12.00	19,0 0.748	4	C
T34-R45H21C09-5/8-14-12R	10139088	G5/8-14	22,911 0.902	14.0	5,06 0.199	20,0 0.787	78 3.071	119,94 4.722	125,0 4.921	18,0 0.709	18.00X14.50	21,0 0.827	4	C
T34-R45H21C09-3/4-14-12R	10139089	G3/4-14	26,441 1.041	14.0	5,05 0.199	20,0 0.787	73 2.874	134,95 5.313	140,0 5.512	20,0 0.787	20.00X16.00	24,5 0.965	4	C
T34-R45H21C09-7/8-14-12R	10139090	G7/8-14	30,201 1.189	14.0	4,98 0.196	22,0 0.866	85 3.346	145,02 5.709	150,0 5.906	22,0 0.866	22.00X18.00	28,25 1.112	4	C
T34-R45H21C09-1-11-12R	10139091	G1-11	33,249 1.309	11.0	6,56 0.258	24,0 0.945	93 3.661	153,44 6.041	160,0 6.299	25,0 0.984	25.00X20.00	30,75 1.211	4	C

T34-R45HE

Blind holes – EGM threads

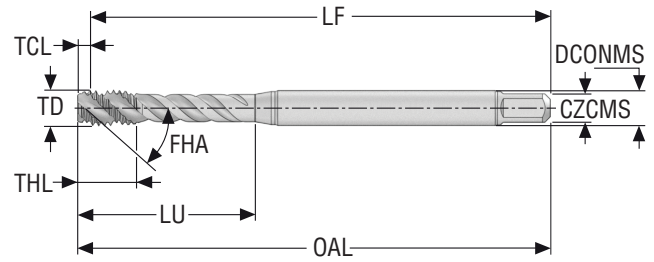

- Substrate: HSSE-PM
- Coating: TiAlN + WC/C
- Standard: DIN371
- Thread tolerance class: 6H mod.
- FHA = 45°
- For cutting data see page(s) 263

Designation	Item number	TDZ	Pitch	TCL	THL	LU	LF	OAL	DCONMS	CZCMS	PHDR Ø	NOF	THCHT
			mm	mm <i>Inch</i>	mm <i>Inch</i>	mm <i>Inch</i>	mm <i>Inch</i>	mm <i>Inch</i>	mm <i>Inch</i>	mm <i>Inch</i>	mm <i>Inch</i>		
T34-R45H04E03-2X0.4-64R	10139092	EGM2	0,4	0,73 0.029	5,0 0.197	14 0.551	49,27 1.940	50,0 1.969	2,8 0.110	2.80X2.10	2,1 0.083	2	E
T34-R45H04E03-2.5X0.45-64R	10139093	EGM2.5	0,45	0,75 0.030	5,0 0.197	18 0.709	55,25 2.175	56,0 2.205	3,5 0.138	3.50X2.70	2,65 0.104	3	E
T34-R45H04E03-3X0.5-64R	10139094	EGM3	0,5	0,83 0.033	5,0 0.197	21 0.827	62,17 2.448	63,0 2.480	4,5 0.177	4.50X3.40	3,15 0.124	3	E
T34-R45H04E03-4X0.7-64R	10139095	EGM4	0,7	1,15 0.045	8,0 0.315	25 0.984	68,85 2.711	70,0 2.756	6,0 0.236	6.00X4.90	4,2 0.165	3	E
T34-R45H04E03-5X0.8-64R	10139096	EGM5	0,8	1,19 0.047	10,0 0.394	30 1.181	78,81 3.103	80,0 3.150	6,0 0.236	6.00X4.90	5,25 0.207	3	E
T34-R45H04E03-6X1-64R	10139097	EGM6	1,0	1,81 0.071	10,0 0.394	35 1.378	88,19 3.472	90,0 3.543	8,0 0.315	8.00X6.20	6,3 0.248	3	E
T34-R45H04E03-8X1.25-64R	10139098	EGM8	1,25	2,2 0.087	13,0 0.512	39 1.535	97,8 3.850	100,0 3.937	10,0 0.394	10.00X8.00	8,4 0.331	3	E

Thread turning

MDT

Mini-Shaft™

Thread milling

Thread tapping

Annex

T34-R45HE

Blind holes – EGM threads

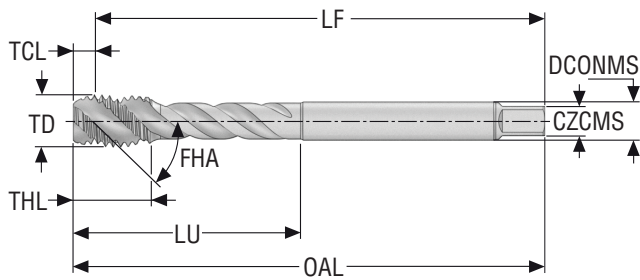

- Substrate: HSSE-PM
- Coating: TiAlN + WC/C
- Standard: DIN376
- Thread tolerance class: 6H mod.
- FHA = 45°
- For cutting data see page(s) 263

Designation	Item number	TDZ	Pitch	TCL	THL	LU	LF	OAL	DCONMS	CZCMS	PHDR Ø	NOF	THCHT
			mm	mm <i>Inch</i>	mm <i>Inch</i>	mm <i>Inch</i>	mm <i>Inch</i>	mm <i>Inch</i>	mm <i>Inch</i>	mm <i>Inch</i>	mm <i>Inch</i>		
T34-R45H04E06-10X1.5-64R	10139111	EGM10	1,5	2,83 <i>0.111</i>	15,0 <i>0.591</i>	73 <i>2.874</i>	97,17 <i>3.826</i>	100,0 <i>3.937</i>	9,0 <i>0.354</i>	9.00X7.00	10,5 <i>0.413</i>	3	E
T34-R45H04E06-12X1.75-64R	10139112	EGM12	1,75	3,21 <i>0.126</i>	20,0 <i>0.787</i>	81 <i>3.189</i>	106,79 <i>4.204</i>	110,0 <i>4.331</i>	11,0 <i>0.433</i>	11.00X9.00	12,5 <i>0.492</i>	4	E
T34-R45H04E06-14X2-64R	10139113	EGM14	2,0	3,67 <i>0.144</i>	20,0 <i>0.787</i>	68 <i>2.677</i>	106,33 <i>4.186</i>	110,0 <i>4.331</i>	12,0 <i>0.472</i>	12.00X9.00	14,5 <i>0.571</i>	4	E
T34-R45H04E06-16X2-64R	10139114	EGM16	2,0	3,67 <i>0.144</i>	20,0 <i>0.787</i>	81 <i>3.189</i>	121,33 <i>4.777</i>	125,0 <i>4.921</i>	14,0 <i>0.551</i>	14.00X11.00	16,5 <i>0.650</i>	4	E
T34-R45H04E06-18X2.5-64R	10139115	EGM18	2,5	4,45 <i>0.175</i>	27,0 <i>1.063</i>	93 <i>3.661</i>	135,55 <i>5.337</i>	140,0 <i>5.512</i>	18,0 <i>0.709</i>	18.00X14.50	18,75 <i>0.738</i>	4	E
T34-R45H04E06-20X2.5-64R	10139116	EGM20	2,5	4,55 <i>0.179</i>	30,0 <i>1.181</i>	113 <i>4.449</i>	155,45 <i>6.120</i>	160,0 <i>6.299</i>	18,0 <i>0.709</i>	18.00X14.50	20,75 <i>0.817</i>	4	E

Thread turning

MDT

Mini-Shaft™

Thread milling

Thread tapping

Annex

T34-R45HE

Blind holes – EGUNC threads

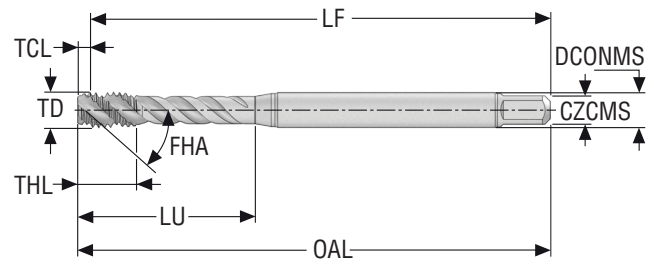

- Substrate: HSSE-PM
- Coating: TiAlN + WC/C
- Standard: DIN371
- Thread tolerance class: 2B
- FHA = 45°
- For cutting data see page(s) 263

Designation	Item number	TDZ	TD	Pitch	TCL	THL	LU	LF	OAL	DCONMS	CZCMS	PHDR Ø	NOF	THCHT
			mm Inch	TPI	mm Inch	mm Inch	mm Inch	mm Inch	mm Inch	mm Inch	mm Inch	mm Inch		
T34-R45H16E03-4-40-21R	10139099	EGUNC4-40	3,67 0.144	40.0	1,0 0.039	7,0 0.276	21 0.827	62,0 2.441	63,0 2.480	4,5 0.177	4.50X3.40	3,1 0.122	3	E
T34-R45H16E03-6-32-21R	10139100	EGUNC6-32	4,536 0.179	32.0	1,32 0.052	8,0 0.315	25 0.984	68,68 2.704	70,0 2.756	6,0 0.236	6.00X4.90	3,8 0.150	3	E
T34-R45H16E03-8-32-21R	10139101	EGUNC8-32	5,197 0.205	32.0	1,32 0.052	10,0 0.394	30 1.181	78,68 3.098	80,0 3.150	6,0 0.236	6.00X4.90	4,4 0.173	3	E
T34-R45H16E03-10-24-21R	10139102	EGUNC10-24	6,2 0.244	24.0	1,64 0.065	12,0 0.472	30 1.181	78,36 3.085	80,0 3.150	7,0 0.276	7.00X5.50	5,2 0.205	3	E
T34-R45H16E03-1/4-20-21R	10139103	EGUNC1/4-20	8,001 0.315	20.0	2,29 0.090	15,0 0.591	35 1.378	87,71 3.453	90,0 3.543	8,0 0.315	8.00X6.20	6,7 0.264	3	E
T34-R45H16E03-5/16-18-21R	10139104	EGUNC5/16-18	9,771 0.385	18.0	2,5 0.098	18,0 0.709	39 1.535	97,5 3.839	100,0 3.937	10,0 0.394	10.00X8	8,4 0.331	3	E

Thread turning

MDT

Mini-Shaft™

Thread milling

Thread tapping

Annex

T34-R45HE

Blind holes – EGUNC threads

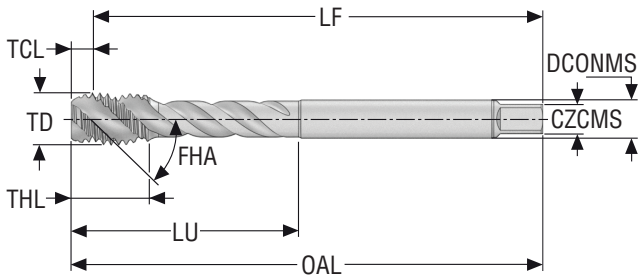

- Substrate: HSSE-PM
- Coating: TiAlN + WC/C
- Standard: DIN376
- Thread tolerance class: 2B
- FHA = 45°
- For cutting data see page(s) 263

Designation	Item number	TDZ	TD	Pitch	TCL	THL	LU	LF	OAL	DCONMS	CZCMS	PHDR Ø	NOF	THCT
			mm Inch	TPI	mm Inch	mm Inch	mm Inch	mm Inch	mm Inch	mm Inch	mm Inch	mm Inch		
T34-R45H16E06-3/8-16-21R	10139117	EGUNC3/8-16	11,587 0.456	16.0	2,99 0.118	15,0 0.591	73 2.874	97,01 3.819	100,0 3.937	9,0 0.354	9.00X7.00	10,0 0.394	3	E
T34-R45H16E06-7/16-14-21R	10139118	EGUNC7/16-14	13,47 0.530	14.0	3,3 0.130	18,0 0.709	81 3.189	106,7 4.201	110,0 4.331	11,0 0.433	11.00X9.00	11,6 0.457	3	E
T34-R45H16E06-1/2-13-21R	10139119	EGUNC1/2-13	15,237 0.600	13.0	3,74 0.147	18,0 0.709	68 2.677	106,26 4.183	110,0 4.331	12,0 0.472	12.00X9.00	13,3 0.524	3	E
T34-R45H16E06-9/16-12-21R	10139120	EGUNC9/16-12	17,038 0.671	12.0	3,6 0.142	20,0 0.787	68 2.677	106,4 4.189	110,0 4.331	12,0 0.472	12.00X9.00	14,9 0.587	4	E
T34-R45H16E06-5/8-11-21R	10139121	EGUNC5/8-11	18,875 0.743	11.0	4,3 0.169	20,0 0.787	81 3.189	120,7 4.752	125,0 4.921	14,0 0.551	14.00X11.00	16,5 0.650	4	E
T34-R45H16E06-3/4-10-21R	10139122	EGUNC3/4-10	22,349 0.880	10.0	4,8 0.189	25,0 0.984	93 3.661	135,2 5.323	140,0 5.512	18,0 0.709	18.00X14.50	19,75 0.778	4	E

Thread turning

MDT

Mini-Shaft™

Thread milling

Thread tapping

Annex

T34-R45HE

Blind holes – EGUNF threads

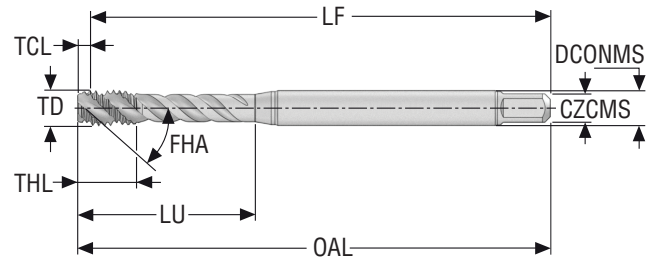

- Substrate: HSSE-PM
- Coating: TiAlN + WC/C
- Standard: DIN371
- Thread tolerance class: 2B
- FHA = 45°
- For cutting data see page(s) 263*

Designation	Item number	TDZ	TD	Pitch	TCL	THL	LU	LF	OAL	DCONMS	CZCMS	PHDR Ø	NOF	THCHT
			mm Inch	TPI	mm Inch	mm Inch	mm Inch	mm Inch	mm Inch	mm Inch	mm Inch	mm Inch		
T34-R45H17E03-4-48-21R	10139105	EGUNF4-48	3,533 0.139	48.0	0,83 0.033	6,0 0.236	20 0.787	55,17 2.172	56,0 2.205	4,0 0.157	4.00X3.00	3,0 0.118	3	E
T34-R45H17E03-6-40-21R	10139106	EGUNF6-40	4,331 0.171	40.0	1,12 0.044	7,0 0.276	25 0.984	68,88 2.712	70,0 2.756	6,0 0.236	6.00X4.90	3,7 0.146	3	E
T34-R45H17E03-8-36-21R	10139107	EGUNF8-36	5,083 0.200	36.0	1,32 0.052	9,0 0.354	30 1.181	78,68 3.098	80,0 3.150	6,0 0.236	6.00X4.90	4,4 0.173	3	E
T34-R45H17E03-10-32-21R	10139108	EGUNF10-32	5,857 0.231	32.0	1,23 0.048	9,0 0.354	30 1.181	78,77 3.101	80,0 3.150	6,0 0.236	6.00X4.90	5,1 0.201	3	E
T34-R45H17E03-1/4-28-21R	10139109	EGUNF1/4-28	7,529 0.296	28.0	1,74 0.069	10,0 0.394	35 1.378	88,26 3.475	90,0 3.543	8,0 0.315	8.00X6.20	6,6 0.260	3	E
T34-R45H17E03-5/16-24-21R	10139110	EGUNF5/16-24	9,312 0.367	24.0	2,52 0.099	12,0 0.472	35 1.378	87,48 3.444	90,0 3.543	10,0 0.394	10.00X8.00	8,25 0.325	3	E

Thread turning

MDT

Mini-Shaft™

Thread milling

Thread tapping

Annex

T34-R45HE

Blind holes – EGUNF threads

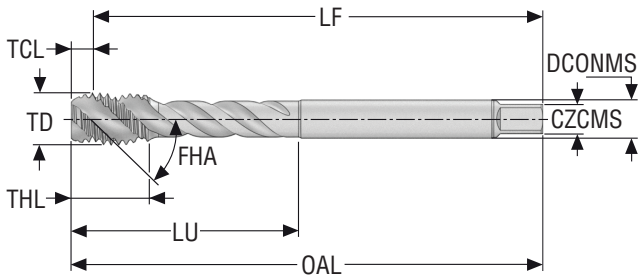

- Substrate: HSSE-PM
- Coating: TiAlN + WC/C
- Standard: DIN376
- Thread tolerance class: 2B
- FHA = 45°
- For cutting data see page(s) 263

Designation	Item number	TDZ	TD	Pitch	TCL	THL	LU	LF	OAL	DCONMS	CZCMS	PHDR Ø	NOF	THCT
			mm Inch	TPI	mm Inch	mm Inch	mm Inch	mm Inch	mm Inch	mm Inch	mm Inch	mm Inch		
T34-R45H17E06-3/8-24-21R	10139123	EGUNF3/8-24	10,899 0.429	24.0	2,0 0.079	12,0 0.472	66 2.598	88,0 3.465	90,0 3.543	8,0 0.315	8.00X6.00	9,8 0.386	3	E
T34-R45H17E06-7/16-20-21R	10139124	EGUNF7/16-20	12,763 0.502	20.0	2,5 0.098	15,0 0.591	73 2.874	97,5 3.839	100,0 3.937	9,0 0.354	9.00X7.00	11,5 0.453	3	E
T34-R45H17E06-1/2-20-21R	10139125	EGUNF1/2-20	14,351 0.565	20.0	2,5 0.098	15,0 0.591	71 2.795	97,5 3.839	100,0 3.937	11,0 0.433	11.00X9.00	13,1 0.516	3	E
T34-R45H17E06-9/16-18-21R	10139126	EGUNF9/16-18	16,121 0.635	18.0	2,58 0.102	15,0 0.591	58 2.283	97,42 3.835	100,0 3.937	12,0 0.472	12.00X9.00	14,7 0.579	4	E
T34-R45H17E06-5/8-18-21R	10139127	EGUNF5/8-18	17,709 0.697	18.0	2,7 0.106	15,0 0.591	66 2.598	107,3 4.224	110,0 4.331	14,0 0.551	14.00X11.00	16,25 0.640	4	E
T34-R45H17E06-3/4-16-21R	10139128	EGUNF3/4-16	21,112 0.831	16.0	3,0 0.118	17,0 0.669	80 3.150	122,0 4.803	125,0 4.921	16,0 0.630	16.00X12.00	19,5 0.768	4	E

Thread turning

MDT

Mini-Shaft™

Thread milling

Thread tapping

Annex

T33-FNC

Blind and through holes – Metric coarse threads

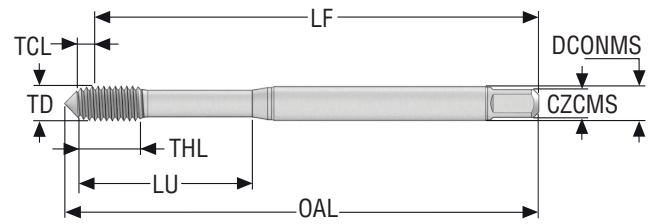

- Substrate: HSSE-PM
- Coating: TiAlN + TiN
- Standard: DIN371
- Thread tolerance class: 6HX
- For cutting data see page(s) 265

Designation	Item number	TDZ	Pitch	TCL	THL	LU	LF	OAL	DCONMS	CZCMS	PHDR Ø	NOF	THCHT
			mm	mm <i>Inch</i>	mm <i>Inch</i>	mm <i>Inch</i>	mm <i>Inch</i>	mm <i>Inch</i>	mm <i>Inch</i>		mm <i>Inch</i>		
T33-FN01C03-2X0.4-65R	10139189	M2	0,4	1,02 <i>0.040</i>	8,0 <i>0.315</i>	8 <i>0.315</i>	43,98 <i>1.731</i>	46,3 <i>1.823</i>	2,8 <i>0.110</i>	2.80X2.10	1,85 <i>0.073</i>	0	C
T33-FN01C03-2.5X0.45-65R	10139190	M2.5	0,45	1,1 <i>0.043</i>	9,0 <i>0.354</i>	9 <i>0.354</i>	48,9 <i>1.925</i>	51,7 <i>2.035</i>	2,8 <i>0.110</i>	2.80X2.10	2,33 <i>0.092</i>	0	C
T33-FN01C03-3X0.5-65R	10139191	M3	0,5	1,2 <i>0.047</i>	10,0 <i>0.394</i>	18 <i>0.709</i>	54,8 <i>2.157</i>	57,2 <i>2.252</i>	3,5 <i>0.138</i>	3.50X2.70	2,8 <i>0.110</i>	0	C
T33-FN01C03-4X0.7-65R	10139192	M4	0,7	1,6 <i>0.063</i>	7,0 <i>0.276</i>	21 <i>0.827</i>	61,4 <i>2.417</i>	64,6 <i>2.543</i>	4,5 <i>0.177</i>	4.50X3.40	3,7 <i>0.146</i>	0	C
T33-FN01C03-5X0.8-65R	10139193	M5	0,8	2,1 <i>0.083</i>	8,0 <i>0.315</i>	25 <i>0.984</i>	67,9 <i>2.673</i>	72,0 <i>2.835</i>	6,0 <i>0.236</i>	6.00X4.90	4,65 <i>0.183</i>	0	C
T33-FN01C03-6X1-65R	10139195	M6	1,0	2,3 <i>0.091</i>	10,0 <i>0.394</i>	30 <i>1.181</i>	77,7 <i>3.059</i>	82,4 <i>3.244</i>	6,0 <i>0.236</i>	6.00X4.90	5,6 <i>0.220</i>	0	C
T33-FN01C03-8X1.25-65R	10139196	M8	1,25	3,1 <i>0.122</i>	13,0 <i>0.512</i>	35 <i>1.378</i>	86,9 <i>3.421</i>	93,3 <i>3.673</i>	8,0 <i>0.315</i>	8.00X6.20	7,45 <i>0.293</i>	0	C
T33-FN01C03-10X1.5-65R	10139197	M10	1,5	3,5 <i>0.138</i>	15,0 <i>0.591</i>	39 <i>1.535</i>	96,5 <i>3.799</i>	101,8 <i>4.008</i>	10,0 <i>0.394</i>	10.00X8.00	9,35 <i>0.368</i>	0	C

Thread turning

MDT

Mini-Shaft™

Thread milling

Thread tapping

Annex

T33-FNC

Blind and through holes – Metric coarse threads

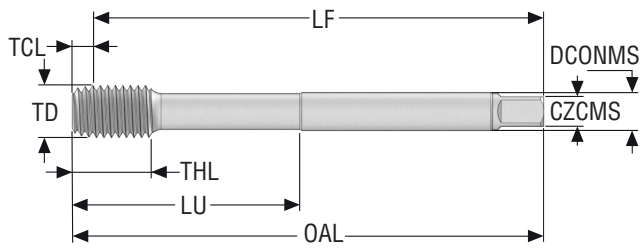

- Substrate: HSSE
- Coating: TiAlN + TiN
- Standard: DIN376
- Thread tolerance class: 6HX
- For cutting data see page(s) 265

Designation	Item number	TDZ	Pitch	TCL	THL	LU	LF	OAL	DCONMS	CZCMS	PHDR Ø	NOF	THCHT
				mm	mm <i>Inch</i>	mm <i>Inch</i>	mm <i>Inch</i>	mm <i>Inch</i>	mm <i>Inch</i>	mm <i>Inch</i>			
T33-FN01C06-12X1.75-65R	10139198	M12	1,75	3,7 <i>0.146</i>	18,0 <i>0.709</i>	83 <i>3.268</i>	106,3 <i>4.185</i>	110,0 <i>4.331</i>	9,0 <i>0.354</i>	9.00X7.00	11,25 <i>0.443</i>	0	C
T33-FN01C06-14X2-65R	10139199	M14	2,0	4,6 <i>0.181</i>	20,0 <i>0.787</i>	81 <i>3.189</i>	105,4 <i>4.150</i>	110,0 <i>4.331</i>	11,0 <i>0.433</i>	11.00X9.00	13,1 <i>0.516</i>	0	C
T33-FN01C06-16X2-65R	10139200	M16	2,0	4,6 <i>0.181</i>	20,0 <i>0.787</i>	81 <i>3.189</i>	105,4 <i>4.150</i>	110,0 <i>4.331</i>	11,0 <i>0.433</i>	11.00X9.00	15,1 <i>0.594</i>	0	C
T33-FN01C06-18X2.5-65R	10139201	M18	2,5	5,76 <i>0.227</i>	25,0 <i>0.984</i>	81 <i>3.189</i>	119,24 <i>4.694</i>	125,0 <i>4.921</i>	14,0 <i>0.551</i>	14.00X11.00	16,85 <i>0.663</i>	0	C
T33-FN01C06-20X2.5-65R	10139202	M20	2,5	5,8 <i>0.228</i>	25,0 <i>0.984</i>	95 <i>3.740</i>	134,2 <i>5.283</i>	140,0 <i>5.512</i>	16,0 <i>0.630</i>	16.00X12.00	18,85 <i>0.742</i>	0	C

T33-FSNC

Blind and through holes – Metric coarse threads

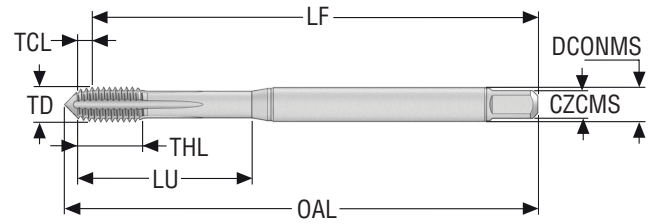

- Substrate: HSSE-PM
- Coating: TiAlN + TiN
- Standard: DIN371
- Thread tolerance class: 6HX
- For cutting data see page(s) 265

Designation	Item number	TDZ	Pitch	TCL	THL	LU	LF	OAL	DCONMS	CZCMS	PHDR Ø	NOF	THCHT
			mm	mm <i>Inch</i>	mm <i>Inch</i>	mm <i>Inch</i>	mm <i>Inch</i>	mm <i>Inch</i>	mm <i>Inch</i>	mm <i>Inch</i>	mm <i>Inch</i>		
T33-FSN01C03-2X0.4-65R	10139204	M2	0,4	1,02 <i>0.040</i>	8,0 <i>0.315</i>	8 <i>0.315</i>	43,98 <i>1.731</i>	46,3 <i>1.823</i>	2,8 <i>0.110</i>	2.80X2.10	1,85 <i>0.073</i>	3	C
T33-FSN01C03-2.5X0.45-65R	10139205	M2.5	0,45	1,1 <i>0.043</i>	9,0 <i>0.354</i>	9 <i>0.354</i>	48,9 <i>1.925</i>	51,7 <i>2.035</i>	2,8 <i>0.110</i>	2.80X2.10	2,33 <i>0.092</i>	3	C
T33-FSN01C03-3X0.5-65R	10139206	M3	0,5	1,2 <i>0.047</i>	10,0 <i>0.394</i>	18 <i>0.709</i>	54,8 <i>2.157</i>	57,2 <i>2.252</i>	3,5 <i>0.138</i>	3.50X2.70	2,8 <i>0.110</i>	3	C
T33-FSN01C03-4X0.7-65R	10139207	M4	0,7	1,6 <i>0.063</i>	7,0 <i>0.276</i>	21 <i>0.827</i>	61,4 <i>2.417</i>	64,6 <i>2.543</i>	4,5 <i>0.177</i>	4.50X3.40	3,7 <i>0.146</i>	5	C
T33-FSN01C03-5X0.8-65R	10139208	M5	0,8	2,1 <i>0.083</i>	8,0 <i>0.315</i>	25 <i>0.984</i>	67,9 <i>2.673</i>	72,0 <i>2.835</i>	6,0 <i>0.236</i>	6.00X4.90	4,65 <i>0.183</i>	5	C
T33-FSN01C03-6X1-65R	10139209	M6	1,0	2,3 <i>0.091</i>	10,0 <i>0.394</i>	30 <i>1.181</i>	77,7 <i>3.059</i>	82,4 <i>3.244</i>	6,0 <i>0.236</i>	6.00X4.90	5,6 <i>0.220</i>	5	C
T33-FSN01C03-8X1.25-65R	10139210	M8	1,25	3,1 <i>0.122</i>	13,0 <i>0.512</i>	35 <i>1.378</i>	86,9 <i>3.421</i>	93,3 <i>3.673</i>	8,0 <i>0.315</i>	8.00X6.20	7,45 <i>0.293</i>	5	C
T33-FSN01C03-10X1.5-65R	10139211	M10	1,5	3,5 <i>0.138</i>	15,0 <i>0.591</i>	39 <i>1.535</i>	96,5 <i>3.799</i>	101,8 <i>4.008</i>	10,0 <i>0.394</i>	10.00X8.00	9,35 <i>0.368</i>	5	C

Thread turning

MDT

Mini-Shaft™

Thread milling

Thread tapping

Annex

T33-FSNC

Blind and through holes– Metric coarse threads

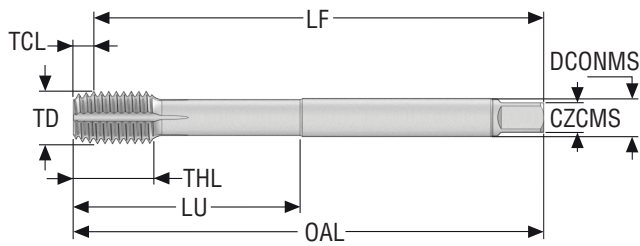

- Substrate: HSSE
- Coating: TiAlN + TiN
- Standard: DIN376
- Thread tolerance class: 6HX
- For cutting data see page(s) 265

Designation	Item number	TDZ	Pitch	TCL	THL	LU	LF	OAL	DCONMS	CZCMS	PHDR Ø	NOF	THCHT
			mm	mm Inch	mm Inch	mm Inch	mm Inch	mm Inch	mm Inch	mm Inch	mm Inch		
T33-FSN01C06-12X1.75-65R	10139212	M12	1,75	3,9 0.154	18,0 0.709	83 3.268	106,1 4.177	110,0 4.331	9,0 0.354	9.00X7.00	11,25 0.443	5	C
T33-FSN01C06-14X2-65R	10139213	M14	2,0	4,77 0.188	20,0 0.787	81 3.189	105,23 4.143	110,0 4.331	11,0 0.433	11.00X9.00	13,1 0.516	6	C
T33-FSN01C06-16X2-65R	10139214	M16	2,0	4,6 0.181	20,0 0.787	81 3.189	105,4 4.150	110,0 4.331	11,0 0.433	11.00X9.00	15,1 0.594	6	C
T33-FSN01C06-18X2.5-65R	10139215	M18	2,5	5,76 0.227	25,0 0.984	81 3.189	119,24 4.694	125,0 4.921	14,0 0.551	14.00X11.00	16,85 0.663	6	C
T33-FSN01C06-20X2.5-65R	10139216	M20	2,5	5,47 0.215	25,0 0.984	95 3.740	134,53 5.296	140,0 5.512	16,0 0.630	16.00X12.00	18,85 0.742	6	C

T33-FSNC

Blind and through holes – Metric coarse threads, 6GX

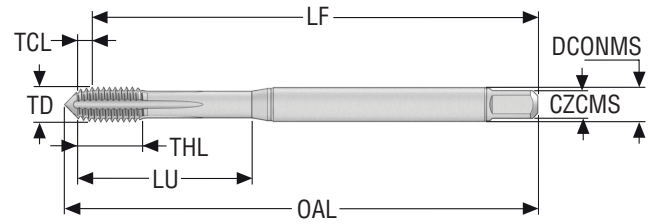

- Substrate: HSSE-PM
- Coating: TiAlN + TiN
- Standard: DIN371
- Thread tolerance class: 6GX
- For cutting data see page(s) 265

Designation	Item number	TDZ	Pitch	TCL	THL	LU	LF	OAL	DCONMS	CZCMS	PHDR Ø	NOF	THCHT
			mm	mm <i>Inch</i>	mm <i>Inch</i>	mm <i>Inch</i>	mm <i>Inch</i>	mm <i>Inch</i>	mm <i>Inch</i>	mm <i>Inch</i>	mm <i>Inch</i>		
T33-FSN01C03-3X0.5-62R	10139258	M3	0,5	1,2 <i>0.047</i>	10,0 <i>0.394</i>	18 <i>0.709</i>	54,8 <i>2.157</i>	57,2 <i>2.252</i>	3,5 <i>0.138</i>	3.50X2.70	2,8 <i>0.110</i>	3	C
T33-FSN01C03-4X0.7-62R	10139259	M4	0,7	1,7 <i>0.067</i>	7,0 <i>0.276</i>	21 <i>0.827</i>	61,3 <i>2.413</i>	64,6 <i>2.543</i>	4,5 <i>0.177</i>	4.50X3.40	3,7 <i>0.146</i>	5	C
T33-FSN01C03-5X0.8-62R	10139260	M5	0,8	2,2 <i>0.087</i>	8,0 <i>0.315</i>	25 <i>0.984</i>	67,8 <i>2.669</i>	72,0 <i>2.835</i>	6,0 <i>0.236</i>	6.00X4.90	4,65 <i>0.183</i>	5	C
T33-FSN01C03-6X1-62R	10139261	M6	1,0	2,3 <i>0.091</i>	10,0 <i>0.394</i>	30 <i>1.181</i>	77,7 <i>3.059</i>	82,4 <i>3.244</i>	6,0 <i>0.236</i>	6.00X4.90	5,6 <i>0.220</i>	5	C
T33-FSN01C03-8X1.25-62R	10139262	M8	1,25	3,2 <i>0.126</i>	13,0 <i>0.512</i>	35 <i>1.378</i>	86,8 <i>3.417</i>	93,3 <i>3.673</i>	8,0 <i>0.315</i>	8.00X6.20	7,45 <i>0.293</i>	5	C
T33-FSN01C03-10X1.5-62R	10139263	M10	1,5	4,4 <i>0.173</i>	15,0 <i>0.591</i>	39 <i>1.535</i>	95,6 <i>3.764</i>	101,8 <i>4.008</i>	10,0 <i>0.394</i>	10.00X8.00	9,35 <i>0.368</i>	5	C

Thread turning

MDT

Mini-Shaft™

Thread milling

Thread tapping

Annex

T33-FSNC

Blind and through holes – Metric coarse threads, 6GX

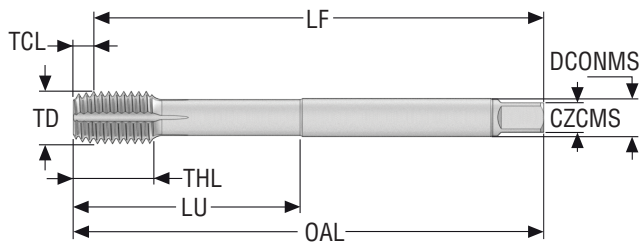

- Substrate: HSSE
- Coating: TiAlN + TiN
- Standard: DIN376
- Thread tolerance class: 6GX
- For cutting data see page(s) 265

Designation	Item number	TDZ	Pitch	TCL	THL	LU	LF	OAL	DCONMS	CZCMS	PHDR Ø	NOF	THCHT
				mm	mm	mm	mm	mm	mm	mm			
T33-FSN01C06-12X1.75-62R	10139264	M12	1,75	3,9 0.154	18,0 0.709	83 3.268	106,1 4.177	110,0 4.331	9,0 0.354	9.00X7.00	11,25 0.443	5	C
T33-FSN01C06-14X2-62R	10139265	M14	2,0	4,77 0.188	20,0 0.787	81 3.189	105,23 4.143	110,0 4.331	11,0 0.433	11.00X9.00	13,1 0.516	6	C
T33-FSN01C06-16X2-62R	10139266	M16	2,0	5,88 0.231	20,0 0.787	81 3.189	104,12 4.099	110,0 4.331	11,0 0.433	11.00X9.00	15,1 0.594	6	C
T33-FSN01C06-18X2.5-62R	10139267	M18	2,5	5,47 0.215	25,0 0.984	81 3.189	119,53 4.706	125,0 4.921	14,0 0.551	14.00X11.00	16,85 0.663	6	C
T33-FSN01C06-20X2.5-62R	10139268	M20	2,5	6,68 0.263	25,0 0.984	95 3.740	133,32 5.249	140,0 5.512	16,0 0.630	16.00X12.00	18,85 0.742	6	C

T33-FSNC

Blind and through holes – MF threads

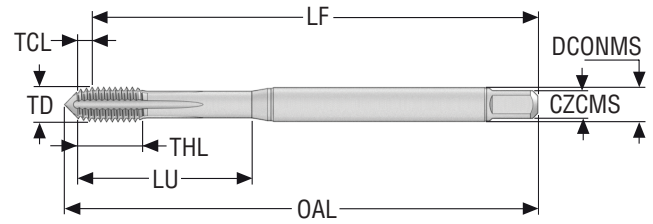

- Substrate: HSSE-PM
- Coating: TiAlN + TiN
- Standard: DIN371
- Thread tolerance class: 6HX
- For cutting data see page(s) 265

Designation	Item number	TDZ	Pitch	TCL	THL	LU	LF	OAL	DCONMS	CZCMS	PHDR Ø	NOF	THCHT
			mm	mm <i>Inch</i>	mm <i>Inch</i>	mm <i>Inch</i>	mm <i>Inch</i>	mm <i>Inch</i>	mm <i>Inch</i>		mm <i>Inch</i>		
T33-FSN02C03-4X0.5-65R	10139217	MF4X0.5	0,5	1,4 <i>0.055</i>	7,0 <i>0.276</i>	21 <i>0.827</i>	61,6 <i>2.425</i>	64,6 <i>2.543</i>	4,5 <i>0.177</i>	4.50X3.40	3,8 <i>0.150</i>	5	C
T33-FSN02C03-5X0.5-65R	10139218	MF5X0.5	0,5	1,2 <i>0.047</i>	8,0 <i>0.315</i>	25 <i>0.984</i>	68,8 <i>2.709</i>	72,0 <i>2.835</i>	6,0 <i>0.236</i>	6.00X4.90	4,8 <i>0.189</i>	5	C
T33-FSN02C03-6X0.5-65R	10139219	MF6X0.5	0,5	1,35 <i>0.053</i>	10,0 <i>0.394</i>	30 <i>1.181</i>	78,65 <i>3.096</i>	82,4 <i>3.244</i>	6,0 <i>0.236</i>	6.00X4.90	5,8 <i>0.228</i>	5	C
T33-FSN02C03-6X0.75-65R	10139220	MF6X0.75	0,75	1,8 <i>0.071</i>	10,0 <i>0.394</i>	30 <i>1.181</i>	78,2 <i>3.079</i>	82,4 <i>3.244</i>	6,0 <i>0.236</i>	6.00X4.90	5,7 <i>0.224</i>	5	C
T33-FSN02C03-8X1-65R	10139221	MF8X1.0	1,0	2,25 <i>0.089</i>	13,0 <i>0.512</i>	35 <i>1.378</i>	87,75 <i>3.455</i>	93,3 <i>3.673</i>	8,0 <i>0.315</i>	8.00X6.20	7,6 <i>0.299</i>	5	C
T33-FSN02C03-10X1-65R	10139222	MF10X1.0	1,0	2,9 <i>0.114</i>	13,0 <i>0.512</i>	35 <i>1.378</i>	87,1 <i>3.429</i>	91,8 <i>3.614</i>	10,0 <i>0.394</i>	10.00X8.00	9,6 <i>0.378</i>	5	C
T33-FSN02C03-10X1.25-65R	10139223	MF10X1.25	1,25	3,1 <i>0.122</i>	15,0 <i>0.591</i>	39 <i>1.535</i>	96,9 <i>3.815</i>	101,8 <i>4.008</i>	10,0 <i>0.394</i>	10.00X8.00	9,45 <i>0.372</i>	5	C

Thread turning

MDT

Mini-Shaft™

Thread milling

Thread tapping

Annex

T33-FSNC

Blind and through holes – MF threads

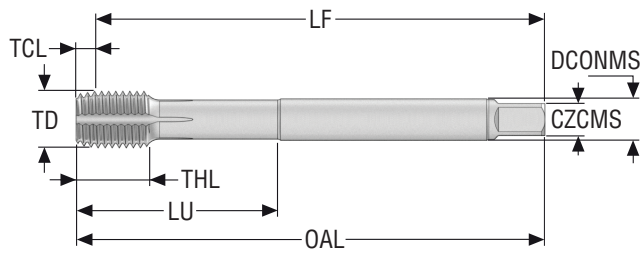

- Substrate: HSSE
- Coating: TiAlN + TiN
- Standard: DIN374
- Thread tolerance class: 6HX
- For cutting data see page(s) 265

Designation	Item number	TDZ	Pitch	TCL	THL	LU	LF	OAL	DCONMS	CZCMS	PHDR Ø	NOF	THCHT
			mm	mm Inch	mm Inch	mm Inch	mm Inch	mm Inch	mm Inch	mm Inch	mm Inch		
T33-FSN02C05-12X1.65R	10139224	MF12X1.0	1,0	3,27 0.129	10,0 0.394	73 2.874	96,73 3.808	100,0 3.937	9,0 0.354	9.00X7.00	11,6 0.457	5	C
T33-FSN02C05-12X1.25-65R	10139225	MF12X1.25	1,25	3,96 0.156	15,0 0.591	73 2.874	96,04 3.781	100,0 3.937	9,0 0.354	9.00X7.00	11,45 0.451	5	C
T33-FSN02C05-12X1.5-65R	10139226	MF12X1.5	1,5	4,15 0.163	15,0 0.591	73 2.874	95,85 3.774	100,0 3.937	9,0 0.354	9.00X7.00	11,35 0.447	5	C
T33-FSN02C05-16X1.5-65R	10139227	MF16X1.5	1,5	4,33 0.170	15,0 0.591	71 2.795	95,67 3.767	100,0 3.937	11,0 0.433	11.00X9.00	15,35 0.604	6	C
T33-FSN02C05-18X1.5-65R	10139228	MF18X1.5	1,5	4,4 0.173	17,0 0.669	66 2.598	105,6 4.157	110,0 4.331	14,0 0.551	14.00X11.00	17,35 0.683	6	C
T33-FSN02C05-20X1.5-65R	10139229	MF20X1.5	1,5	4,6 0.181	17,0 0.669	80 3.150	120,4 4.740	125,0 4.921	16,0 0.630	16.00X12.00	19,35 0.762	6	C

T33-FSNC

Blind and through holes – UNC threads

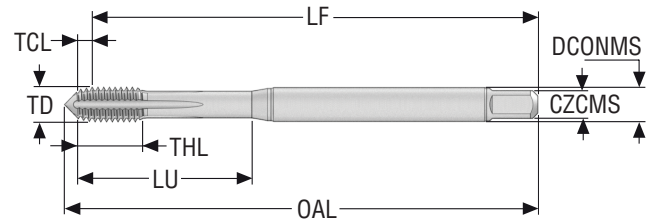

- Substrate: HSSE
- Coating: TiAlN + TiN
- Standard: DIN371
- Thread tolerance class: 2BX
- For cutting data see page(s) 265

Designation	Item number	TDZ	TD	Pitch	TCL	THL	LU	LF	OAL	DCONMS	CZCMS	PHDR Ø	NOF	THCHT
			mm Inch	TPI	mm Inch	mm Inch	mm Inch	mm Inch	mm Inch	mm Inch		mm Inch		
T33-FSN08C03-5-40-22R	10139230	UNC5-40	3,175 0.125	40.0	1,6 0.063	7,0 0.276	18 0.709	54,4 2.142	57,2 2.252	3,5 0.138	3.50X2.70	2,9 0.114	3	C
T33-FSN08C03-6-32-22R	10139231	UNC6-32	3,505 0.138	32.0	1,8 0.071	6,0 0.236	20 0.787	54,2 2.134	57,4 2.260	4,0 0.157	4.00X3.00	3,15 0.124	3	C
T33-FSN08C03-8-32-22R	10139232	UNC8-32	4,166 0.164	32.0	2,0 0.079	7,0 0.276	21 0.827	61,0 2.402	64,6 2.543	4,5 0.177	4.50X3.40	3,8 0.150	5	C
T33-FSN08C03-10-24-22R	10139233	UNC10-24	4,826 0.190	24.0	2,7 0.106	8,0 0.315	25 0.984	67,3 2.650	72,0 2.835	6,0 0.236	6.00X4.90	4,35 0.171	5	C
T33-FSN08C03-12-24-22R	10139234	UNC12-24	5,486 0.216	24.0	2,7 0.106	10,0 0.394	30 1.181	77,3 3.043	82,4 3.244	6,0 0.236	6.00X4.90	5,0 0.197	5	C
T33-FSN08C03-1/4-20-22R	10139235	UNC1/4-20	6,35 0.250	20.0	3,9 0.154	13,0 0.512	30 1.181	76,1 2.996	80,0 3.150	7,0 0.276	7.00X5.50	5,75 0.226	5	C
T33-FSN08C03-5/16-18-22R	10139236	UNC5/16-18	7,937 0.312	18.0	3,6 0.142	13,0 0.512	35 1.378	86,4 3.402	93,3 3.673	8,2 0.323	8.20X6.20	7,3 0.287	5	C
T33-FSN08C03-3/8-16-22R	10139237	UNC3/8-16	9,525 0.375	16.0	4,74 0.187	15,0 0.591	39 1.535	95,26 3.750	100,0 3.937	10,0 0.394	10.00X8.00	8,8 0.346	5	C

Thread turning

MDT

Mini-Shaft™

Thread milling

Thread tapping

Annex

T33-FSNC

Blind and through holes– UNC threads

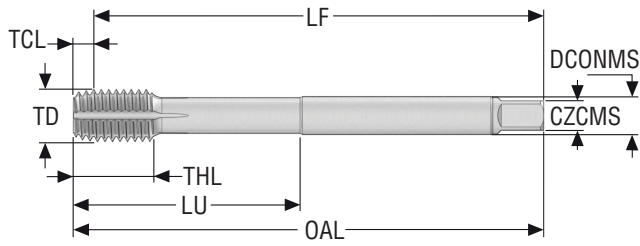

- Substrate: HSSE
- Coating: TiAlN + TiN
- Standard: DIN376
- Thread tolerance class: 2BX
- For cutting data see page(s) 265

Designation	Item number	TDZ	TD	Pitch	TCL	THL	LU	LF	OAL	DCONMS	CZCMS	PHDR Ø	NOF	THCHT
			mm Inch	TPI	mm Inch	mm Inch	mm Inch	mm Inch	mm Inch	mm Inch	mm Inch			
T33-FSN08C06-7/16-14-22R	10139238	UNC7/16-14	11,112 0.437	14.0	5,4 0.213	15,0 0.591	76 2.992	94,6 3.724	100,0 3.937	8,0 0.315	8.00X6.20	10,25 0.404	5	C
T33-FSN08C06-1/2-13-22R	10139239	UNC1/2-13	12,7 0.500	13.0	5,8 0.228	18,0 0.709	83 3.268	104,2 4.102	110,0 4.331	9,0 0.354	9.00X7.00	11,8 0.465	5	C
T33-FSN08C06-5/8-11-22R	10139240	UNC5/8-11	15,875 0.625	11.0	6,8 0.268	20,0 0.787	81 3.189	103,2 4.063	110,0 4.331	12,0 0.472	12.00x9.00	14,8 0.583	6	C

T33-FSNC

Blind and through holes – UNF threads

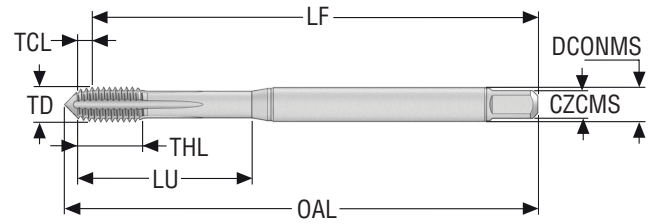

- Substrate: HSSE
- Coating: TiAlN + TiN
- Standard: DIN371
- Thread tolerance class: 2BX
- For cutting data see page(s) 265

Designation	Item number	TDZ	TD	Pitch	TCL	THL	LU	LF	OAL	DCONMS	CZCMS	PHDR Ø	NOF	THCHT
			mm Inch	TPI	mm Inch	mm Inch	mm Inch	mm Inch	mm Inch	mm Inch		mm Inch		
T33-FSN09C03-5-44-22R	10139241	UNF5-44	3,175 0.125	44.0	1,4 0.055	7,0 0.276	18 0.709	54,6 2.150	57,2 2.252	3,5 0.138	3.50X2.70	2,92 0.115	3	C
T33-FSN09C03-6-40-22R	10139242	UNF6-40	3,505 0.138	40.0	1,6 0.063	6,0 0.236	20 0.787	54,4 2.142	57,4 2.260	4,0 0.157	4.00X3.00	3,22 0.127	3	C
T33-FSN09C03-8-36-22R	10139243	UNF8-36	4,166 0.164	36.0	1,8 0.071	7,0 0.276	21 0.827	61,2 2.409	64,6 2.543	4,5 0.177	4.50X3.40	3,85 0.152	5	C
T33-FSN09C03-10-32-22R	10139244	UNF10-32	4,826 0.190	32.0	1,9 0.075	8,0 0.315	25 0.984	68,1 2.681	72,0 2.835	6,0 0.236	6.00X4.90	4,45 0.175	5	C
T33-FSN09C03-12-28-22R	10139245	UNF12-28	5,486 0.216	28.0	1,9 0.075	10,0 0.394	30 1.181	78,1 3.075	82,4 3.244	6,0 0.236	6.00X4.90	5,1 0.201	5	C
T33-FSN09C03-1/4-28-22R	10139246	UNF1/4-28	6,35 0.250	28.0	2,23 0.088	10,0 0.394	30 1.181	77,77 3.062	82,4 3.244	7,0 0.276	7.00X5.50	5,95 0.234	5	C
T33-FSN09C03-5/16-24-22R	10139247	UNF5/16-24	7,937 0.312	24.0	2,6 0.102	13,0 0.512	35 1.378	87,4 3.441	93,3 3.673	8,0 0.315	8.00X6.20	7,45 0.293	5	C
T33-FSN09C03-3/8-24-22R	10139248	UNF3/8-24	9,525 0.375	24.0	3,5 0.138	15,0 0.591	35 1.378	86,5 3.406	90,0 3.543	10,0 0.394	10.00X8.00	9,05 0.356	5	C

Thread turning

MDT

Mini-Shaft™

Thread milling

Thread tapping

Annex

T33-FSNC

Blind and through holes – UNF threads

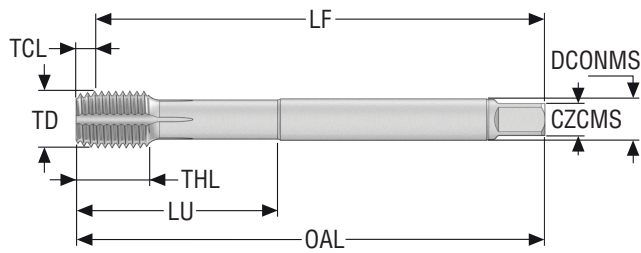

- Substrate: HSSE
- Coating: TiAlN + TiN
- Standard: DIN374
- Thread tolerance class: 2BX
- For cutting data see page(s) 265

Designation	Item number	TDZ	TD	Pitch	TCL	THL	LU	LF	OAL	DCONMS	CZCMS	PHDR Ø	NOF	THCHT
			mm Inch	TPI	mm Inch	mm Inch	mm Inch	mm Inch	mm Inch	mm Inch	mm Inch	mm Inch	mm Inch	
T33-FSN09C05-7/16-20-22R	10139249	UNF7/16-20	11,112 0.437	20.0	3,8 0.150	15,0 0.591	76 2.992	96,2 3.787	100,0 3.937	8,0 0.315	8.00X6.20	10,55 0.415	5	C
T33-FSN09C05-1/2-20-22R	10139250	UNF1/2-20	12,7 0.500	20.0	3,8 0.150	15,0 0.591	83 3.268	106,2 4.181	110,0 4.331	9,0 0.354	9.00X7.00	12,15 0.478	5	C
T33-FSN09C05-5/8-18-22R	10139251	UNF5/8-18	15,875 0.625	18.0	4,7 0.185	15,0 0.591	68 2.677	105,3 4.146	110,0 4.331	12,0 0.472	12.00X9.00	15,25 0.600	6	C

Thread turning

MDT

Mini-Shaft™

Thread milling

Thread tapping

Annex

T33-FSNC

Blind and through holes – G threads

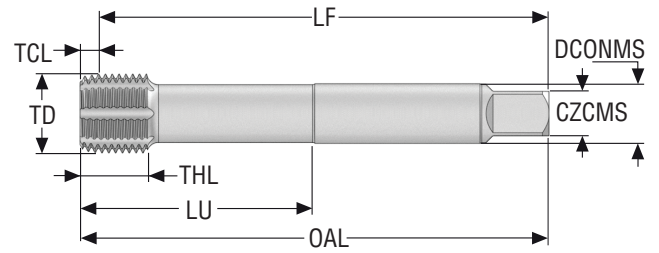

- Substrate: HSSE
- Coating: TiAlN + TiN
- Standard: DIN5156
- Thread tolerance class: NORMAL-X
- For cutting data see page(s) 265

Designation	Item number	TDZ	TD	Pitch	TCL	THL	LU	LF	OAL	DCONMS	CZCMS	PHDR Ø	NOF	THCHT
			mm Inch	TPI	mm Inch	mm Inch	mm Inch	mm Inch	mm Inch	mm Inch	mm Inch	mm Inch		
T33-FSN21C09-1/8-28-12R	10139252	G1/8-28	9,728 0.383	28.0	2,6 0.102	10,0 0.394	67 2.638	87,4 3.441	90,0 3.543	7,0 0.276	7.00X5.50	9,25 0.364	5	C
T33-FSN21C09-1/4-19-12R	10139253	G1/4-19	13,157 0.518	19.0	3,7 0.146	14,0 0.551	71 2.795	96,3 3.791	100,0 3.937	11,0 0.433	11.00X9.00	12,55 0.494	6	C
T33-FSN21C09-3/8-19-12R	10139254	G3/8-19	16,662 0.656	19.0	3,85 0.152	15,0 0.591	71 2.795	96,15 3.785	100,0 3.937	11,0 0.433	11.00X9.00	16,05 0.632	7	C
T33-FSN21C09-1/2-14-12R	10139255	G1/2-14	20,955 0.825	14.0	5,1 0.201	17,0 0.669	80 3.150	119,9 4.720	125,0 4.921	16,0 0.630	16.00X12.00	20,1 0.791	7	C
T33-FSN21C09-5/8-14-12R	10139256	G5/8-14	22,911 0.902	14.0	5,1 0.201	20,0 0.787	78 3.071	119,9 4.720	125,0 4.921	18,0 0.709	18.00X14.50	22,05 0.868	7	C
T33-FSN21C09-3/4-14-12R	10139257	G3/4-14	26,441 1.041	14.0	5,1 0.201	22,0 0.866	73 2.874	134,9 5.311	140,0 5.512	20,0 0.787	20.00X16.00	25,6 1.008	7	C

Thread turning

MDT

Mini-Shaft™

Thread milling

Thread tapping

Annex

T33-FSCC

Blind and through holes – Metric coarse threads

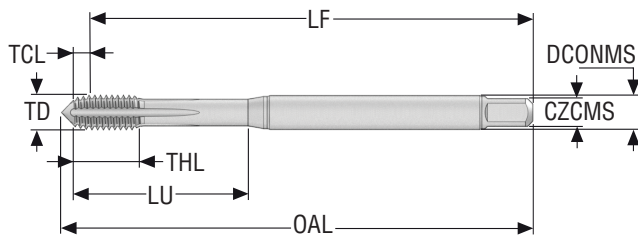

- Substrate: HSSE-PM
- Coating: TiN + TiCN
- Standard: DIN371
- Thread tolerance class: 6HX
- For cutting data see page(s) 265

Designation	Item number	TDZ	Pitch	TCL	THL	LU	LF	OAL	DCONMS	CZCMS	PHDR Ø	NOF	THCHT
			mm	mm <i>Inch</i>	mm <i>Inch</i>	mm <i>Inch</i>	mm <i>Inch</i>	mm <i>Inch</i>	mm <i>Inch</i>	mm <i>Inch</i>	mm <i>Inch</i>		
T33-FSC01C03-3X0.5-65R	10139282	M3	0,5	1,2 <i>0.047</i>	10,0 <i>0.394</i>	18 <i>0.709</i>	54,8 <i>2.157</i>	57,2 <i>2.252</i>	3,5 <i>0.138</i>	3.50X2.70	2,8 <i>0.110</i>	3	C
T33-FSC01C03-4X0.7-65R	10139283	M4	0,7	1,6 <i>0.063</i>	7,0 <i>0.276</i>	21 <i>0.827</i>	61,4 <i>2.417</i>	64,6 <i>2.543</i>	4,5 <i>0.177</i>	4.50X3.40	3,7 <i>0.146</i>	5	C
T33-FSC01C03-5X0.8-65R	10139284	M5	0,8	2,1 <i>0.083</i>	8,0 <i>0.315</i>	25 <i>0.984</i>	67,9 <i>2.673</i>	72,0 <i>2.835</i>	6,0 <i>0.236</i>	6.00X4.90	4,65 <i>0.183</i>	5	C
T33-FSC01C03-6X1-65R	10139285	M6	1,0	2,3 <i>0.091</i>	10,0 <i>0.394</i>	30 <i>1.181</i>	77,7 <i>3.059</i>	82,4 <i>3.244</i>	6,0 <i>0.236</i>	6.00X4.90	5,6 <i>0.220</i>	5	C
T33-FSC01C03-8X1.25-65R	10139286	M8	1,25	3,1 <i>0.122</i>	13,0 <i>0.512</i>	35 <i>1.378</i>	86,9 <i>3.421</i>	93,3 <i>3.673</i>	8,0 <i>0.315</i>	8.00X6.20	7,45 <i>0.293</i>	5	C
T33-FSC01C03-10X1.5-65R	10139287	M10	1,5	3,5 <i>0.138</i>	15,0 <i>0.591</i>	39 <i>1.535</i>	96,5 <i>3.799</i>	101,8 <i>4.008</i>	10,0 <i>0.394</i>	10.00X8.00	9,35 <i>0.368</i>	5	C

Thread turning

MDT

Mini-Shaft™

Thread milling

Thread tapping

Annex

T33-FSCE

Blind and through holes – Metric coarse threads

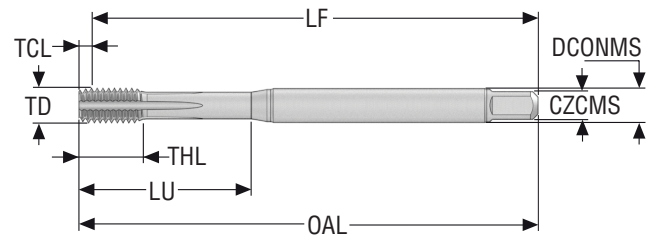

- Substrate: HSSE-PM
- Coating: TiN + TiCN
- Standard: DIN371
- Thread tolerance class: 6HX
- For cutting data see page(s) 265

Designation	Item number	TDZ	Pitch	TCL	THL	LU	LF	OAL	DCONMS	CZCMS	PHDR Ø	NOF	THCHT
			mm	mm <i>Inch</i>	mm <i>Inch</i>	mm <i>Inch</i>	mm <i>Inch</i>	mm <i>Inch</i>	mm <i>Inch</i>	mm <i>Inch</i>	mm <i>Inch</i>		
T33-FSC01E03-3X0.5-65R	10139288	M3	0,5	1,2 <i>0.047</i>	10,0 <i>0.394</i>	18 <i>0.709</i>	54,8 <i>2.157</i>	56,0 <i>2.205</i>	3,5 <i>0.138</i>	3.50X2.70	2,8 <i>0.110</i>	3	E
T33-FSC01E03-4X0.7-65R	10139289	M4	0,7	1,6 <i>0.063</i>	7,0 <i>0.276</i>	21 <i>0.827</i>	61,4 <i>2.417</i>	63,0 <i>2.480</i>	4,5 <i>0.177</i>	4.50X3.40	3,7 <i>0.146</i>	5	E
T33-FSC01E03-5X0.8-65R	10139290	M5	0,8	1,5 <i>0.059</i>	8,0 <i>0.315</i>	25 <i>0.984</i>	68,5 <i>2.697</i>	70,0 <i>2.756</i>	6,0 <i>0.236</i>	6.00X4.90	4,65 <i>0.183</i>	5	E

Thread turning

MDT

Mini-Shaft™

Thread milling

Thread tapping

Annex

T33A-FSCE

Blind holes – Metric coarse threads

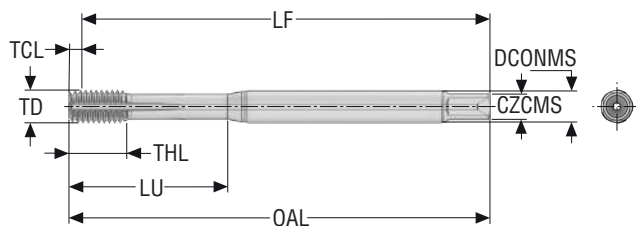

- Internal coolant
- Substrate: HSSE-PM
- Coating: TiN + TiCN
- Standard: DIN371
- Thread tolerance class: 6HX
- For cutting data see page(s) 265

Designation	Item number	TDZ	Pitch	TCL	THL	LU	LF	OAL	DCONMS	CZCMS	PHDR Ø	NOF	THCHT
			mm	mm <i>Inch</i>	mm <i>Inch</i>	mm <i>Inch</i>	mm <i>Inch</i>	mm <i>Inch</i>	mm <i>Inch</i>	mm <i>Inch</i>	mm <i>Inch</i>		
T33A-FSC01E03-5X0.8-65R	10139294	M5	0,8	1,7 <i>0.067</i>	8,0 <i>0.315</i>	25 <i>0.984</i>	68,3 <i>2.689</i>	70,0 <i>2.756</i>	6,0 <i>0.236</i>	6.00X4.90	4,65 <i>0.183</i>	5	E
T33A-FSC01E03-6X1-65R	10139295	M6	1,0	1,95 <i>0.077</i>	10,0 <i>0.394</i>	30 <i>1.181</i>	78,05 <i>3.073</i>	80,0 <i>3.150</i>	6,0 <i>0.236</i>	6.00X4.90	5,6 <i>0.220</i>	5	E
T33A-FSC01E03-8X1.25-65R	10139296	M8	1,25	2,55 <i>0.100</i>	13,0 <i>0.512</i>	35 <i>1.378</i>	87,45 <i>3.443</i>	90,0 <i>3.543</i>	8,0 <i>0.315</i>	8.00X6.20	7,45 <i>0.293</i>	5	E
T33A-FSC01E03-10X1.5-65R	10139297	M10	1,5	2,84 <i>0.112</i>	15,0 <i>0.591</i>	39 <i>1.535</i>	97,16 <i>3.825</i>	100,0 <i>3.937</i>	10,0 <i>0.394</i>	10.00X8.00	9,35 <i>0.368</i>	5	E

Thread turning

MDT

Mini-Shaft™

Thread milling

Thread tapping

Annex

T33B-FSCE

Blind and through holes– Metric coarse threads

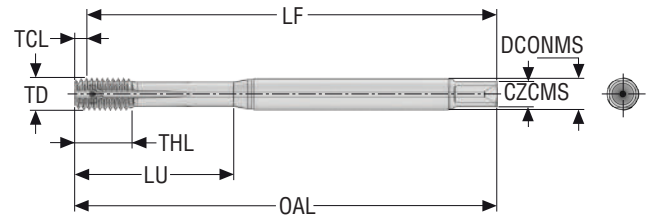

- Internal coolant
- Substrate: HSSE-PM
- Coating: TiN + TiCN
- Standard: DIN371
- Thread tolerance class: 6HX
- For cutting data see page(s) 265

Designation	Item number	TDZ	Pitch	TCL	THL	LU	LF	OAL	DCONMS	CZCMS	PHDR Ø	NOF	THCT
			mm	mm <i>Inch</i>	mm <i>Inch</i>	mm <i>Inch</i>	mm <i>Inch</i>	mm <i>Inch</i>	mm <i>Inch</i>	mm <i>Inch</i>	mm <i>Inch</i>		
T33B-FSC01E03-5X0.8-65R	10139298	M5	0,8	1,57 <i>0.062</i>	8,0 <i>0.315</i>	25 <i>0.984</i>	68,43 <i>2.694</i>	70,0 <i>2.756</i>	6,0 <i>0.236</i>	6.00X4.90	4,65 <i>0.183</i>	5	E
T33B-FSC01E03-6X1-65R	10139299	M6	1,0	1,95 <i>0.077</i>	10,0 <i>0.394</i>	30 <i>1.181</i>	78,05 <i>3.073</i>	80,0 <i>3.150</i>	6,0 <i>0.236</i>	6.00X4.90	5,6 <i>0.220</i>	5	E
T33B-FSC01E03-8X1.25-65R	10139300	M8	1,25	2,42 <i>0.095</i>	13,0 <i>0.512</i>	35 <i>1.378</i>	87,58 <i>3.448</i>	90,0 <i>3.543</i>	8,0 <i>0.315</i>	8.00X6.20	7,45 <i>0.293</i>	5	E
T33B-FSC01E03-10X1.5-65R	10139301	M10	1,5	2,84 <i>0.112</i>	15,0 <i>0.591</i>	39 <i>1.535</i>	97,16 <i>3.825</i>	100,0 <i>3.937</i>	10,0 <i>0.394</i>	10.00X8.00	9,35 <i>0.368</i>	5	E

Thread turning

MDT

Mini-Shaft™

Thread milling

Thread tapping

Annex

T33-FSCC

Blind and through holes – MF threads

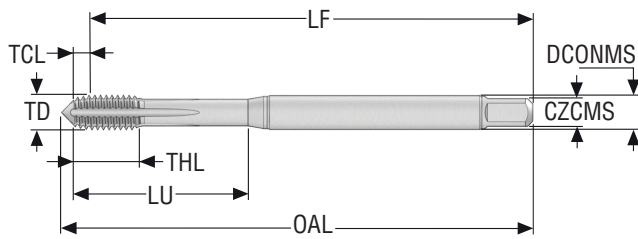

- Substrate: HSSE-PM
- Coating: TiN + TiCN
- Standard: DIN371
- Thread tolerance class: 6HX
- For cutting data see page(s) 265

Designation	Item number	TDZ	Pitch	TCL	THL	LU	LF	OAL	DCONMS	CZCMS	PHDR Ø	NOF	THCHT
			mm	mm Inch	mm Inch	mm Inch	mm Inch	mm Inch	mm Inch	mm Inch	mm Inch		
T33-FSC02C03-4X0.5-65R	10139269	MF4X0.5	0,5	1,4 0.055	7,0 0.276	21 0.827	61,6 2.425	64,6 2.543	4,5 0.177	4.50X3.40	3,8 0.150	5	C
T33-FSC02C03-5X0.5-65R	10139270	MF5X0.5	0,5	1,2 0.047	8,0 0.315	25 0.984	68,8 2.709	72,0 2.835	6,0 0.236	6.00X4.90	4,8 0.189	5	C
T33-FSC02C03-6X0.5-65R	10139271	MF6X0.5	0,5	1,35 0.053	10,0 0.394	30 1.181	78,65 3.096	82,4 3.244	6,0 0.236	6.00X4.90	5,8 0.228	5	C
T33-FSC02C03-6X0.75-65R	10139272	MF6X0.75	0,75	1,8 0.071	10,0 0.394	30 1.181	78,2 3.079	82,4 3.244	6,0 0.236	6.00X4.90	5,7 0.224	5	C
T33-FSC02C03-8X1-65R	10139273	MF8X1.0	1,0	2,25 0.089	13,0 0.512	35 1.378	87,75 3.455	93,3 3.673	8,0 0.315	8.00X6.20	7,6 0.299	5	C
T33-FSC02C03-10X1-65R	10139274	MF10X1.0	1,0	2,9 0.114	13,0 0.512	35 1.378	87,1 3.429	91,8 3.614	10,0 0.394	10.00X8.00	9,6 0.378	5	C
T33-FSC02C03-10X1.25-65R	10139275	MF10X1.25	1,25	4,0 0.157	15,0 0.591	39 1.535	96,0 3.780	101,8 4.008	10,0 0.394	10.00X8.00	9,45 0.372	5	C

T33-FSCC

Blind and through holes – MF threads

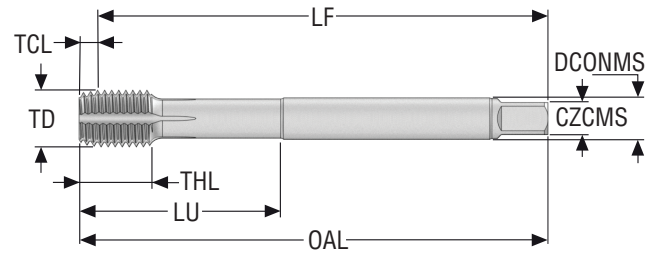

- Substrate: HSSE
- Coating: TiN + TiCN
- Standard: DIN374
- Thread tolerance class: 6HX
- For cutting data see page(s) 265

Designation	Item number	TDZ	Pitch	TCL	THL	LU	LF	OAL	DCONMS	CZCMS	PHDR Ø	NOF	THCHT
			mm	mm <i>Inch</i>	mm <i>Inch</i>	mm <i>Inch</i>	mm <i>Inch</i>	mm <i>Inch</i>	mm <i>Inch</i>		mm <i>Inch</i>		
T33-FSC02C05-12X1.65R	10139276	MF12X1.0	1,0	3,27 <i>0.129</i>	10,0 <i>0.394</i>	73 <i>2.874</i>	96,73 <i>3.808</i>	100,0 <i>3.937</i>	9,0 <i>0.354</i>	9.00X7.00	11,6 <i>0.457</i>	5	C
T33-FSC02C05-12X1.25-65R	10139277	MF12X1.25	1,25	3,96 <i>0.156</i>	15,0 <i>0.591</i>	73 <i>2.874</i>	96,04 <i>3.781</i>	100,0 <i>3.937</i>	9,0 <i>0.354</i>	9.00X7.00	11,45 <i>0.451</i>	5	C
T33-FSC02C05-12X1.5-65R	10139278	MF12X1.5	1,5	4,2 <i>0.165</i>	15,0 <i>0.591</i>	73 <i>2.874</i>	95,8 <i>3.772</i>	100,0 <i>3.937</i>	9,0 <i>0.354</i>	9.00X7.00	11,35 <i>0.447</i>	5	C
T33-FSC02C05-16X1.5-65R	10139279	MF16X1.5	1,5	4,33 <i>0.170</i>	15,0 <i>0.591</i>	71 <i>2.795</i>	95,67 <i>3.767</i>	100,0 <i>3.937</i>	11,0 <i>0.433</i>	11.00X9.00	15,35 <i>0.604</i>	5	C
T33-FSC02C05-18X1.5-65R	10139280	MF18X1.5	1,5	4,4 <i>0.173</i>	17,0 <i>0.669</i>	66 <i>2.598</i>	105,6 <i>4.157</i>	110,0 <i>4.331</i>	14,0 <i>0.551</i>	14.00X11.00	17,35 <i>0.683</i>	5	C
T33-FSC02C05-20X1.5-65R	10139281	MF20X1.5	1,5	4,6 <i>0.181</i>	17,0 <i>0.669</i>	80 <i>3.150</i>	120,4 <i>4.740</i>	125,0 <i>4.921</i>	16,0 <i>0.630</i>	16.00X12.00	19,35 <i>0.762</i>	5	C

Thread turning

MDT

Mini-Shaft™

Thread milling

Thread tapping

Annex

MTP-P001

Through holes – Metric coarse threads

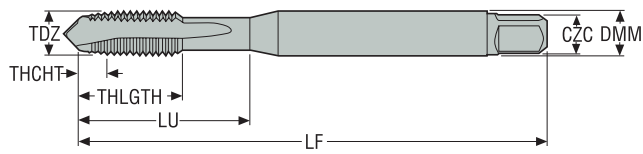

- Substrate: HSS-E-PM
- Coating: TiAlN
- For cutting data see page(s) 269

Designation	Item number	TDZ	Pitch		DMM	LU	THLGTH	LF	PHDR	CZC	NOF	BSG	TCTR	THCHT
			mm	TPI										
MTP-M3X0.50ISO6H-TB-P001	02999886	M3	0,5	–	4,5 <i>0.177</i>	12,0 <i>0.472</i>	12,0 <i>0.472</i>	61,625 <i>2.426</i>	2,5 <i>0.098</i>	4.50X3.40	3	SECO-DIN	6H	B
MTP-M4X0.70ISO6H-TB-P001	02999887	M4	0,7	–	6,0 <i>0.236</i>	13,0 <i>0.512</i>	13,0 <i>0.512</i>	68,075 <i>2.680</i>	3,4 <i>0.134</i>	6.00X4.90	3	SECO-DIN	6H	B
MTP-M5X0.80ISO6H-TB-P001	02999888	M5	0,8	–	6,0 <i>0.236</i>	15,0 <i>0.591</i>	15,0 <i>0.591</i>	76,3 <i>3.004</i>	4,3 <i>0.169</i>	6.00X4.90	3	SECO-DIN	6H	B
MTP-M6X1.00ISO6H-TB-P001	02999889	M6	1,0	–	8,0 <i>0.315</i>	18,0 <i>0.709</i>	18,0 <i>0.709</i>	85,375 <i>3.361</i>	5,1 <i>0.201</i>	8.00X6.20	3	SECO-DIN	6H	B
MTP-M8X1.25ISO6H-TB-P001	02999890	M8	1,25	–	10,0 <i>0.394</i>	20,0 <i>0.787</i>	20,0 <i>0.787</i>	94,21875 <i>3.709</i>	6,8 <i>0.268</i>	10.00X8.00	3	SECO-DIN	6H	B
MTP-M10X1.50ISO6H-TB-P001	02999891	M10	1,5	–	10,0 <i>0.394</i>	39,0 <i>1.535</i>	20,0 <i>0.787</i>	95,875 <i>3.775</i>	8,6 <i>0.339</i>	10.00X8.00	3	SECO-DIN	6H	B

Thread turning

MDT

Mini-Shaft™

Thread milling

Thread tapping

Annex

MTP-P002

Through holes – Metric coarse threads

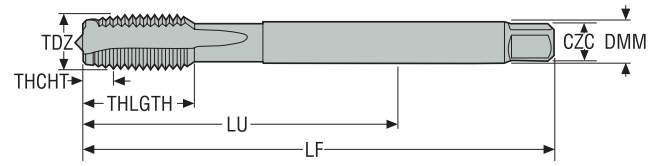

- Substrate: HSS-E-PM
- Coating: TiAlN
- For cutting data see page(s) 269

Designation	Item number	TDZ	Pitch	DMM	LU	THLGTH	LF	PHDR	CZC	NOF	BSG	TCTR	THCHT
			mm TPI	mm <i>Inch</i>	mm <i>Inch</i>	mm <i>Inch</i>	mm <i>Inch</i>	mm <i>Inch</i>					
MTP-M12X1.75ISO6H-TB-P002	02999892	M12	1,75 –	9,0 <i>0.354</i>	83,0 <i>3.268</i>	23,0 <i>0.906</i>	105,1875 <i>4.141</i>	10,4 <i>0.409</i>	9.00X7.00	4	DIN376	6H	B
MTP-M14X2.00ISO6H-TB-P002	02999893	M14	2,0 –	11,0 <i>0.433</i>	81,0 <i>3.189</i>	25,0 <i>0.984</i>	104,5 <i>4.114</i>	12,1 <i>0.476</i>	11.00X9.00	4	DIN376	6H	B
MTP-M16X2.00ISO6H-TB-P002	02999894	M16	2,0 –	12,0 <i>0.472</i>	68,0 <i>2.677</i>	25,0 <i>0.984</i>	104,5 <i>4.114</i>	14,1 <i>0.555</i>	12.00X9.00	4	DIN376	6H	B
MTP-M18X2.50ISO6H-TB-P002	02999895	M18	2,5 –	14,0 <i>0.551</i>	81,0 <i>3.189</i>	30,0 <i>1.181</i>	112,63 <i>4.434</i>	15,7 <i>0.618</i>	14.00X11.00	4	DIN376	6H	B
MTP-M20X2.50ISO6H-TB-P002	02999896	M20	2,5 –	16,0 <i>0.630</i>	95,0 <i>3.740</i>	30,0 <i>1.181</i>	133,125 <i>5.241</i>	17,7 <i>0.697</i>	16.00X12.00	4	DIN376	6H	B

Thread turning

MDT

Mini-Shaft™

Thread milling

Thread tapping

Annex

MTP-P003

Through holes – Metric coarse threads

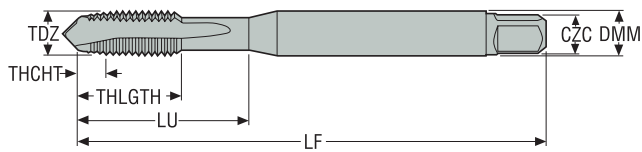

- Substrate: HSS-E-PM
- Coating: AlTiN-based
- For cutting data see page(s) 269

Designation	Item number	TDZ	Pitch		DMM	LU	THLGTH	LF	PHDR	CXC	NOF	BSG	TCTR	THCHT
			mm	TPI										
MTP-M1X0.25ISO5HX-TB-P003	02999897	M1	0,25	–	2,5 0.098	20,0 0.787	5,0 0.197	38,87 1.530	0,75 0.030	2.50X2.10	2	DIN371	5HX	B
MTP-M1.2X0.25ISO5HX-TB-P003	02999898	M1.2	0,25	–	2,5 0.098	20,0 0.787	5,0 0.197	38,87 1.530	0,95 0.037	2.50X2.10	2	DIN371	5HX	B
MTP-M1.4X0.30ISO5HX-TB-P003	02999899	M1.4	0,3	–	2,5 0.098	20,0 0.787	6,5 0.256	38,65 1.522	1,1 0.043	2.50X2.10	2	DIN371	5HX	B
MTP-M1.6X0.35ISO6HX-TB-P003	02999900	M1.6	0,35	–	2,5 0.098	12,5 0.492	7,0 0.276	38,42 1.513	1,3 0.051	2.50X2.10	2	DIN371	6HX	B
MTP-M1.8X0.35ISO6HX-TB-P003	02999901	M1.8	0,35	–	2,5 0.098	20,0 0.787	7,0 0.276	38,42 1.513	1,5 0.059	2.50X2.10	2	DIN371	6HX	B
MTP-M2X0.40ISO6HX-TB-P003	02999902	M2	0,4	–	2,8 0.110	9,0 0.354	6,0 0.236	43,2 1.701	1,6 0.063	2.80X2.10	2	DIN371	6HX	B
MTP-M2.2X0.45ISO6HX-TB-P003	02999903	M2.2	0,45	–	2,8 0.110	12,0 0.472	7,0 0.276	42,97 1.692	1,8 0.071	2.80X2.10	2	DIN371	6HX	B
MTP-M2.3X0.40ISO6HX-TB-P003	02999904	M2.3	0,4	–	2,8 0.110	12,0 0.472	7,0 0.276	43,2 1.701	1,9 0.075	2.80X2.10	2	DIN371	6HX	B
MTP-M2.5X0.45ISO6HX-TB-P003	02999905	M2.5	0,45	–	2,8 0.110	12,5 0.492	8,0 0.315	47,97 1.889	2,1 0.083	2.80X2.10	2	DIN371	6HX	B
MTP-M2.6X0.45ISO6HX-TB-P003	02999906	M2.6	0,45	–	2,8 0.110	12,5 0.492	8,0 0.315	47,97 1.889	2,15 0.085	2.80X2.10	2	DIN371	6HX	B
MTP-M3X0.50ISO6HX-TB-P003	02999907	M3	0,5	–	3,5 0.138	18,0 0.709	8,9 0.350	53,6875 2.114	2,5 0.098	3.50X2.70	3	DIN371	6HX	B
MTP-M3.5X0.60ISO6HX-TB-P003	02999908	M3.5	0,6	–	4,0 0.157	20,0 0.787	10,8 0.425	53,225 2.095	2,9 0.114	4.00X3.00	3	DIN371	6HX	B
MTP-M4X0.70ISO6HX-TB-P003	02999909	M4	0,7	–	4,5 0.177	21,0 0.827	11,7 0.461	59,7625 2.353	3,4 0.134	4.50X3.40	3	DIN371	6HX	B
MTP-M5X0.80ISO6HX-TB-P003	02999910	M5	0,8	–	6,0 0.236	25,0 0.984	12,6 0.496	66,3 2.610	4,3 0.169	6.00X4.90	3	DIN371	6HX	B
MTP-M6X1.00ISO6HX-TB-P003	02999911	M6	1,0	–	6,0 0.236	30,0 1.181	14,5 0.571	75,375 2.968	5,1 0.201	6.00X4.90	3	DIN371	6HX	B
MTP-M7X1.00ISO6HX-TB-P003	02999912	M7	1,0	–	7,0 0.276	30,0 1.181	14,5 0.571	78,275 3.082	6,1 0.240	7.00X5.50	3	DIN371	6HX	B
MTP-M8X1.25ISO6HX-TB-P003	02999913	M8	1,25	–	8,0 0.315	35,0 1.378	17,4 0.685	84,21875 3.316	6,8 0.268	8.00X6.20	3	DIN371	6HX	B
MTP-M10X1.50ISO6HX-TB-P003	02999914	M10	1,5	–	10,0 0.394	39,0 1.535	19,2 0.756	93,0625 3.664	8,6 0.339	10.00X8.00	3	DIN371	6HX	B

Thread turning

MDT

Mini-Shaft™

Thread milling

Thread tapping

Annex

MTP-P003-A

Through holes – Metric coarse threads

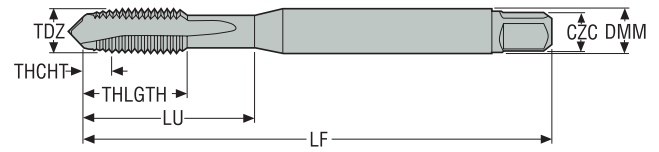

- Internal coolant
- Substrate: HSS-E-PM
- Coating: AlTiN-based
- For cutting data see page(s) 269

Designation	Item number	TDZ	Pitch	DMM	LU	THLGTH	LF	PHDR	CXC	NOF	BSG	TCTR	THCHT
			mm TPI	mm Inch	mm Inch	mm Inch	mm Inch	mm Inch					
MTP-M4X0.70ISO6HX-TB-P003-A	02999929	M4	0,7 –	4,5 0.177	21,0 0.827	11,7 0.461	59,73 2.352	3,4 0.134	4.50X3.40	3	DIN371	6HX	B
MTP-M5X0.80ISO6HX-TB-P003-A	02999930	M5	0,8 –	6,0 0.236	25,0 0.984	12,6 0.496	66,35 2.612	4,3 0.169	6.00X4.90	3	DIN371	6HX	B
MTP-M6X1.00ISO6HX-TB-P003-A	02999931	M6	1,0 –	6,0 0.236	30,0 1.181	14,5 0.571	75,51 2.973	5,1 0.201	6.00X4.90	3	DIN371	6HX	B
MTP-M7X1.00ISO6HX-TB-P003-A	02999932	M7	1,0 –	7,0 0.276	30,0 1.181	14,5 0.571	75,51 2.973	6,1 0.240	7.00X5.50	3	DIN371	6HX	B
MTP-M8X1.25ISO6HX-TB-P003-A	02999933	M8	1,25 –	8,0 0.315	35,0 1.378	17,4 0.685	84,48 3.326	6,8 0.268	8.00X6.20	3	DIN371	6HX	B
MTP-M10X1.50ISO6HX-TB-P003-A	02999934	M10	1,5 –	10,0 0.394	39,0 1.535	19,2 0.756	93,46 3.680	8,6 0.339	10.00X8.00	3	DIN371	6HX	B

Thread turning

MDT

Mini-Shaft™

Thread milling

Thread tapping

Annex

MTP-P004

Through holes – Metric coarse threads

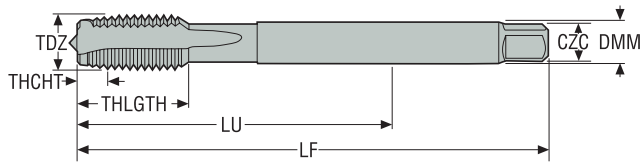

- Substrate: HSS-E-PM
- Coating: AlTiN-based
- For cutting data see page(s) 269

Designation	Item number	TDZ	Pitch		DMM	LU	THLGH	LF	PHDR	CZC	NOF	BSG	TCTR	THCHT
			mm	TPI										
MTP-M4X0.70ISO6HX-TB-P004	02999915	M4	0,7	–	2,8 0.110	43,0 1.693	12,0 0.472	59,7625 2.353	3,4 0.134	2.80X2.10	3	DIN376	6HX	B
MTP-M5X0.80ISO6HX-TB-P004	02999916	M5	0,8	–	3,5 0.138	49,0 1.929	13,2 0.520	66,3 2.610	4,3 0.169	3.50X2.70	3	DIN376	6HX	B
MTP-M6X1.00ISO6HX-TB-P004	02999917	M6	1,0	–	4,5 0.177	59,0 2.323	15,1 0.594	75,375 2.968	5,1 0.201	4.50X3.40	3	DIN376	6HX	B
MTP-M8X1.25ISO6HX-TB-P004	02999918	M8	1,25	–	6,0 0.236	67,0 2.638	18,0 0.709	84,21875 3.316	6,8 0.268	6.00X4.90	3	DIN376	6HX	B
MTP-M10X1.50ISO6HX-TB-P004	02999919	M10	1,5	–	7,0 0.276	77,0 3.031	19,8 0.780	93,0625 3.664	8,6 0.339	7.00X5.50	3	DIN376	6HX	B
MTP-M12X1.75ISO6HX-TB-P004	02999920	M12	1,75	–	9,0 0.354	83,0 3.268	23,0 0.906	101,90625 4.012	10,4 0.409	9.00X7.00	4	DIN376	6HX	B
MTP-M14X2.00ISO6HX-TB-P004	02999921	M14	2,0	–	11,0 0.433	81,0 3.189	25,0 0.984	100,75 3.967	12,1 0.476	11.00X9.00	4	DIN376	6HX	B
MTP-M16X2.00ISO6HX-TB-P004	02999922	M16	2,0	–	12,0 0.472	68,0 2.677	25,0 0.984	100,75 3.967	14,1 0.555	12.00X9.00	4	DIN376	6HX	B
MTP-M18X2.50ISO6HX-TB-P004	02999923	M18	2,5	–	14,0 0.551	81,0 3.189	30,0 1.181	114,46 4.506	15,7 0.618	14.00X11.00	4	DIN376	6HX	B
MTP-M20X2.50ISO6HX-TB-P004	02999924	M20	2,5	–	16,0 0.630	95,0 3.740	30,0 1.181	128,4375 5.057	17,7 0.697	16.00X12.00	4	DIN376	6HX	B
MTP-M22X2.50ISO6HX-TB-P004	02999925	M22	2,5	–	18,0 0.709	93,0 3.661	34,0 1.339	129,36 5.093	19,7 0.776	18.00X14.50	4	DIN376	6HX	B
MTP-M24X3.00ISO6HX-TB-P004	02999926	M24	3,0	–	18,0 0.709	113,0 4.449	38,0 1.496	146,125 5.753	21,0 0.827	18.00X14.50	4	DIN376	6HX	B
MTP-M27X3.00ISO6HX-TB-P004	02999927	M27	3,0	–	20,0 0.787	97,0 3.819	38,0 1.496	147,37 5.802	24,0 0.945	20.00X16.00	4	DIN376	6HX	B
MTP-M30X3.50ISO6HX-TB-P004	02999928	M30	3,5	–	22,0 0.866	115,0 4.528	45,0 1.772	165,42 6.513	26,5 1.043	22.00X18.00	4	DIN376	6HX	B

Thread turning

MDT

Mini-Shaft™

Thread milling

Thread tapping

Annex

MTP-P004-A

Through holes – Metric coarse threads

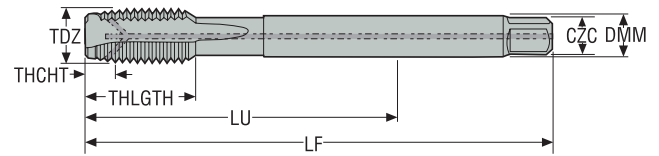

- Internal coolant
- Substrate: HSS-E-PM
- Coating: AlTiN-based
- For cutting data see page(s) 269

Designation	Item number	TDZ	Pitch	DMM	LU	THLGTH	LF	PHDR	CZC	NOF	BSG	TCTR	THCHT
			mm TPI	mm Inch	mm Inch	mm Inch	mm Inch	mm Inch					
MTP-M12X1.75ISO6HX-TB-P004-A	02999935	M12	1,75 –	9,0 0.354	83,0 3.268	23,0 0.906	101,90625 4.012	10,4 0.409	9.00X7.00	4	DIN376	6HX	B
MTP-M14X2.00ISO6HX-TB-P004-A	02999936	M14	2,0 –	11,0 0.433	81,0 3.189	25,0 0.984	101,41 3.993	12,1 0.476	11.00X9.00	4	DIN376	6HX	B
MTP-M16X2.00ISO6HX-TB-P004-A	02999937	M16	2,0 –	12,0 0.472	68,0 2.677	25,0 0.984	100,75 3.967	14,1 0.555	12.00X9.00	4	DIN376	6HX	B
MTP-M18X2.50ISO6HX-TB-P004-A	02999938	M18	2,5 –	14,0 0.551	81,0 3.189	30,0 1.181	114,46 4.506	15,7 0.618	14.00X11.00	4	DIN376	6HX	B
MTP-M20X2.50ISO6HX-TB-P004-A	02999939	M20	2,5 –	16,0 0.630	95,0 3.740	30,0 1.181	129,46 5.097	17,7 0.697	16.00X12.00	4	DIN376	6HX	B
MTP-M22X2.50ISO6HX-TB-P004-A	02999940	M22	2,5 –	18,0 0.709	93,0 3.661	34,0 1.339	129,36 5.093	19,7 0.776	18.00X14.50	4	DIN376	6HX	B
MTP-M24X3.00ISO6HX-TB-P004-A	02999941	M24	3,0 –	18,0 0.709	113,0 4.449	38,0 1.496	146,125 5.753	21,0 0.827	18.00X14.50	4	DIN376	6HX	B
MTP-M27X3.00ISO6HX-TB-P004-A	02999942	M27	3,0 –	20,0 0.787	97,0 3.819	38,0 1.496	147,37 5.802	24,0 0.945	20.00X16.00	4	DIN376	6HX	B
MTP-M30X3.50ISO6HX-TB-P004-A	02999943	M30	3,5 –	22,0 0.866	115,0 4.528	45,0 1.772	165,42 6.513	26,5 1.043	22.00X18.00	4	DIN376	6HX	B

Thread turning

MDT

Mini-Shaft™

Thread milling

Thread tapping

Annex

MTP-P011

Through holes – MF threads

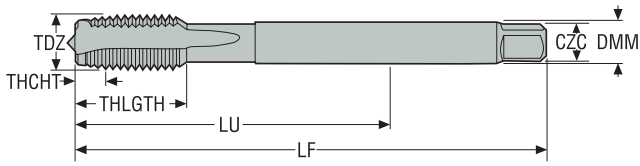

- Substrate: HSS-E-PM
- Coating: AlTiN-based
- For cutting data see page(s) 269

Designation	Item number	TDZ	Pitch		DMM	LU	THLGTH	LF	PHDR	CZC	NOF	BSG	TCTR	THCHT
			mm	TPI										
MTP-M4X0.50ISO6HX-TB-P011	02999944	MF4X0.5	0,5	–	2,8 0.110	43,0 1.693	12,0 0.472	60,6875 2.389	3,5 0.138	2.80X2.10	3	DIN374	6HX	B
MTP-M5X0.50ISO6HX-TB-P011	02999945	MF5X0.5	0,5	–	3,5 0.138	49,0 1.929	13,0 0.512	67,57 2.660	4,5 0.177	3.50X2.70	3	DIN374	6HX	B
MTP-M6X0.75ISO6HX-TB-P011	02999946	MF6X0.75	0,75	–	4,5 0.177	59,0 2.323	15,0 0.591	76,5 3.012	5,3 0.209	4.50X3.40	3	DIN374	6HX	B
MTP-M8X0.75ISO6HX-TB-P011	02999947	MF8X0.75	0,75	–	6,0 0.236	57,0 2.244	15,0 0.591	76,43 3.009	7,3 0.287	6.00X4.90	3	DIN374	6HX	B
MTP-M8X1.00ISO6HX-TB-P011	02999948	MF8X1.0	1,0	–	6,0 0.236	67,0 2.638	18,0 0.709	85,375 3.361	7,1 0.280	6.00X4.90	3	DIN374	6HX	B
MTP-M10X0.75ISO6HX-TB-P011	02999949	MF10X0.75	0,75	–	7,0 0.276	67,0 2.638	17,6 0.693	86,42 3.402	9,3 0.366	7.00X5.50	3	DIN374	6HX	B
MTP-M10X1.00ISO6HX-TB-P011	02999950	MF10X1.0	1,0	–	7,0 0.276	67,0 2.638	17,6 0.693	85,375 3.361	9,1 0.358	7.00X5.50	3	DIN374	6HX	B
MTP-M10X1.25ISO6HX-TB-P011	02999951	MF10X1.25	1,25	–	7,0 0.276	77,0 3.031	19,8 0.780	98,51875 3.879	8,8 0.346	7.00X5.50	3	DIN374	6HX	B
MTP-M12X1.00ISO6HX-TB-P011	02999952	MF12X1.0	1,0	–	9,0 0.354	73,0 2.874	21,0 0.827	95,36 3.754	11,1 0.437	9.00X7.00	4	DIN374	6HX	B
MTP-M12X1.25ISO6HX-TB-P011	02999953	MF12X1.25	1,25	–	9,0 0.354	73,0 2.874	21,0 0.827	94,21875 3.709	10,8 0.425	9.00X7.00	4	DIN374	6HX	B
MTP-M12X1.50ISO6HX-TB-P011	02999954	MF12X1.5	1,5	–	9,0 0.354	73,0 2.874	21,0 0.827	93,37 3.676	10,6 0.417	9.00X7.00	4	DIN374	6HX	B
MTP-M14X1.00ISO6HX-TB-P011	02999955	MF14X1.0	1,0	–	11,0 0.433	71,0 2.795	21,0 0.827	95,35 3.754	13,1 0.516	11.00X9.00	4	DIN374	6HX	B
MTP-M14X1.25ISO6HX-TB-P011	02999956	MF14X1.25	1,25	–	11,0 0.433	71,0 2.795	21,0 0.827	94,33 3.714	12,8 0.504	11.00X9.00	4	DIN374	6HX	B
MTP-M14X1.50ISO6HX-TB-P011	02999957	MF14X1.5	1,5	–	11,0 0.433	71,0 2.795	21,0 0.827	93,0625 3.664	12,6 0.496	11.00X9.00	4	DIN374	6HX	B
MTP-M16X1.00ISO6HX-TB-P011	02999958	MF16X1.0	1,0	–	12,0 0.472	58,0 2.283	21,0 0.827	95,35 3.754	15,1 0.594	12.00X9.00	4	DIN374	6HX	B
MTP-M16X1.50ISO6HX-TB-P011	02999959	MF16X1.5	1,5	–	12,0 0.472	58,0 2.283	21,0 0.827	93,0625 3.664	14,6 0.575	12.00X9.00	4	DIN374	6HX	B
MTP-M18X1.00ISO6HX-TB-P011	02999960	MF18X1.0	1,0	–	14,0 0.551	66,0 2.598	24,0 0.945	105,35 4.148	17,1 0.673	14.00X11.00	4	DIN374	6HX	B
MTP-M18X1.50ISO6HX-TB-P011	02999961	MF18X1.5	1,5	–	14,0 0.551	66,0 2.598	24,0 0.945	103,35 4.069	16,6 0.654	14.00X11.00	4	DIN374	6HX	B
MTP-M20X1.00ISO6HX-TB-P011	02999962	MF20X1.0	1,0	–	16,0 0.630	80,0 3.150	24,0 0.945	120,24 4.734	19,1 0.752	16.00X12.00	4	DIN374	6HX	B
MTP-M20X1.50ISO6HX-TB-P011	02999963	MF20X1.5	1,5	–	16,0 0.630	80,0 3.150	24,0 0.945	118,25 4.656	18,6 0.732	16.00X12.00	4	DIN374	6HX	B
MTP-M22X1.50ISO6HX-TB-P011	02999964	MF22X1.5	1,5	–	18,0 0.709	78,0 3.071	25,0 0.984	118,25 4.656	20,5 0.807	18.00X14.50	4	DIN374	6HX	B
MTP-M24X1.50ISO6HX-TB-P011	02999965	MF24X1.5	1,5	–	18,0 0.709	93,0 3.661	28,0 1.102	133,23 5.245	22,5 0.886	18.00X14.50	4	DIN374	6HX	B

Thread turning

MDT

Mini-Shaft™

Thread milling

Thread tapping

Annex

Designation	Item number	TDZ	Pitch		DMM	LU	THLGTH	LF	PHDR	CZC	NOF	BSG	TCTR	THCHT
			mm	TPI										
MTP-M24X2.00ISO6HX-TB-P011	02999966	MF24X2.0	2,0	–	18,0 0.709	93,0 3.661	28,0 1.102	131,28 5.169	22,0 0.866	18.00X14.50	4	DIN374	6HX	B
MTP-M25X1.50ISO6HX-TB-P011	02999967	MF25X1.5	1,5	–	18,0 0.709	93,0 3.661	28,0 1.102	133,23 5.245	23,5 0.925	18.00X14.50	4	DIN374	6HX	B
MTP-M26X1.50ISO6HX-TB-P011	02999968	MF26X1.5	1,5	–	18,0 0.709	93,0 3.661	28,0 1.102	133,23 5.245	24,5 0.965	18.00X14.50	4	DIN374	6HX	B
MTP-M27X1.50ISO6HX-TB-P011	02999969	MF27X1.5	1,5	–	20,0 0.787	77,0 3.031	28,0 1.102	133,22 5.245	25,5 1.004	20.00X16.00	4	DIN374	6HX	B
MTP-M27X2.00ISO6HX-TB-P011	02999970	MF27X2.0	2,0	–	20,0 0.787	77,0 3.031	28,0 1.102	131,28 5.169	25,0 0.984	20.00X16.00	4	DIN374	6HX	B
MTP-M28X1.50ISO6HX-TB-P011	02999971	MF28X1.5	1,5	–	20,0 0.787	77,0 3.031	28,0 1.102	133,22 5.245	26,5 1.043	20.00X16.00	4	DIN374	6HX	B
MTP-M30X1.50ISO6HX-TB-P011	02999972	MF30X1.5	1,5	–	22,0 0.866	85,0 3.346	28,0 1.102	143,22 5.639	28,5 1.122	22.00X18.00	4	DIN374	6HX	B
MTP-M30X2.00ISO6HX-TB-P011	02999973	MF30X2.0	2,0	–	22,0 0.866	85,0 3.346	28,0 1.102	141,27 5.562	28,0 1.102	22.00X18.00	4	DIN374	6HX	B

Thread turning

MDT

Mini-Shaft™

Thread milling

Thread tapping

Annex

MTP-M003-A

Through holes – MF threads

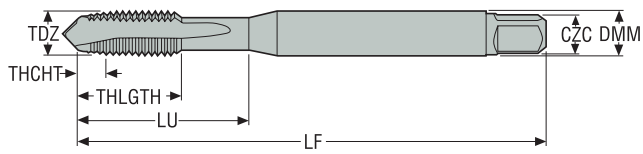

- Internal coolant
- Substrate: HSS-E
- Coating: TiCN
- For cutting data see page(s) 271

Designation	Item number	TDZ	Pitch		DMM	LU	THLGTH	LF	PHDR	CXC	NOF	BSG	TCTR	THCHT
			mm	TPI										
MTP-M4X0.70ISO6H-TB-M003-A	03000094	M4	0,7	–	4,5 <i>0.177</i>	21,0 <i>0.827</i>	11,7 <i>0.461</i>	59,82 <i>2.355</i>	3,4 <i>0.134</i>	4.50X3.40	3	DIN371	6H	B
MTP-M5X0.80ISO6H-TB-M003-A	03000095	M5	0,8	–	6,0 <i>0.236</i>	25,0 <i>0.984</i>	12,6 <i>0.496</i>	66,4 <i>2.614</i>	4,3 <i>0.169</i>	6.00X4.90	3	DIN371	6H	B
MTP-M6X1.00ISO6H-TB-M003-A	03000096	M6	1,0	–	6,0 <i>0.236</i>	30,0 <i>1.181</i>	14,5 <i>0.571</i>	75,375 <i>2.968</i>	5,1 <i>0.201</i>	6.00X4.90	3	DIN371	6H	B
MTP-M8X1.25ISO6H-TB-M003-A	03000097	M8	1,25	–	8,0 <i>0.315</i>	35,0 <i>1.378</i>	17,4 <i>0.685</i>	84,21875 <i>3.316</i>	6,8 <i>0.268</i>	8.00X6.20	3	DIN371	6H	B
MTP-M10X1.50ISO6H-TB-M003-A	03000098	M10	1,5	–	10,0 <i>0.394</i>	39,0 <i>1.535</i>	19,2 <i>0.756</i>	93,0625 <i>3.664</i>	8,6 <i>0.339</i>	10.00X8.00	3	DIN371	6H	B

MTP-M004

Through holes – Metric coarse threads

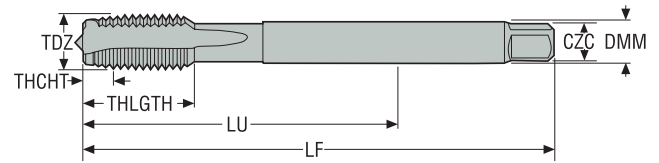

- Internal coolant
- Substrate: HSS-E
- Coating: TiCN
- For cutting data see page(s) 271

Designation	Item number	TDZ	Pitch	DMM	LU	THLGTH	LF	PHDR	CZC	NOF	BSG	TCTR	THCHT
			mm TPI	mm Inch	mm Inch	mm Inch	mm Inch	mm Inch					
MTP-M12X1.75ISO6H-TB-M004	03000087	M12	1,75 -	9,0 0.354	83,0 3.268	23,0 0.906	101,90625 4.012	10,4 0.409	9.00X7.00	4	DIN376	6H	B
MTP-M14X2.00ISO6H-TB-M004	03000088	M14	2,0 -	11,0 0.433	81,0 3.189	25,0 0.984	100,75 3.967	12,1 0.476	11.00X9.00	4	DIN376	6H	B
MTP-M16X2.00ISO6H-TB-M004	03000090	M16	2,0 -	12,0 0.472	68,0 2.677	25,0 0.984	100,75 3.967	14,1 0.555	12.00X9.00	4	DIN376	6H	B
MTP-M18X2.50ISO6H-TB-M004	03000091	M18	2,5 -	14,0 0.551	81,0 3.189	30,0 1.181	113,4375 4.466	15,7 0.618	14.00X11.00	4	DIN376	6H	B
MTP-M20X2.50ISO6H-TB-M004	03000092	M20	2,5 -	16,0 0.630	95,0 3.740	30,0 1.181	128,4375 5.057	17,7 0.697	16.00X12.00	4	DIN376	6H	B

Thread turning

MDT

Mini-Shaft™

Thread milling

Thread tapping

Annex

MTP-M004-A

Through holes – Metric coarse threads

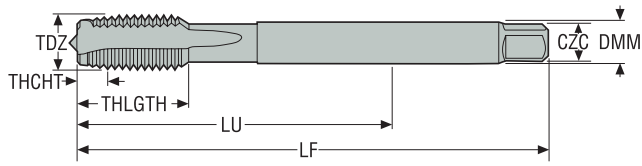

- Internal coolant
- Substrate: HSS-E
- Coating: TiCN
- For cutting data see page(s) 271

Designation	Item number	TDZ	Pitch		DMM	LU	THLGH	LF	PHDR	CZC	NOF	BSG	TCTR	THCHT
			mm	TPI										
MTP-M12X1.75ISO6H-TB-M004-A	03000099	M12	1,75	–	9,0 0.354	83,0 3.268	23,0 0.906	101,90625 4.012	10,4 0.409	9.00X7.00	4	DIN376	6H	B
MTP-M14X2.00ISO6H-TB-M004-A	03000100	M14	2,0	–	11,0 0.433	81,0 3.189	25,0 0.984	101,14 3.982	12,1 0.476	11.00X9.00	4	DIN376	6H	B
MTP-M16X2.00ISO6H-TB-M004-A	03000101	M16	2,0	–	12,0 0.472	68,0 2.677	25,0 0.984	101,05 3.978	14,1 0.555	12.00X9.00	4	DIN376	6H	B
MTP-M18X2.50ISO6H-TB-M004-A	03000102	M18	2,5	–	14,0 0.551	81,0 3.189	30,0 1.181	114,15 4.494	15,7 0.618	14.00X11.00	4	DIN376	6H	B
MTP-M20X2.50ISO6H-TB-M004-A	03000103	M20	2,5	–	16,0 0.630	95,0 3.740	30,0 1.181	129,15 5.085	17,7 0.697	16.00X12.00	4	DIN376	6H	B
MTP-M22X2.50ISO6H-TB-M004-A	03000104	M22	2,5	–	18,0 0.709	93,0 3.661	34,0 1.339	129,53 5.100	19,7 0.776	18.00X14.50	4	DIN376	6H	B
MTP-M24X3.00ISO6H-TB-M004-A	03000105	M24	3,0	–	18,0 0.709	113,0 4.449	38,0 1.496	147,58 5.810	21,0 0.827	18.00X14.50	4	DIN376	6H	B

MTP-N001

Through holes – Metric coarse threads

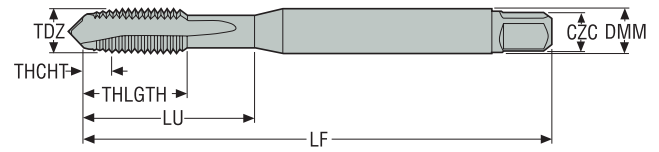

- Substrate: HSS-E
- Coating: BRIGHT
- For cutting data see page(s) 273

Designation	Item number	TDZ	Pitch	DMM	LU	THLGTH	LF	PHDR	CXC	NOF	BSG	TCTR	THCHT
			mm TPI	mm <i>Inch</i>	mm <i>Inch</i>	mm <i>Inch</i>	mm <i>Inch</i>	mm <i>Inch</i>					
MTP-M3X0.50ISO6H-TB-N001	03000136	M3	0,5 –	3,5 <i>0.138</i>	16,0 <i>0.630</i>	9,0 <i>0.354</i>	54,625 <i>2.151</i>	2,5 <i>0.098</i>	3.50X2.70	2	DIN371	6H	B
MTP-M4X0.70ISO6H-TB-N001	03000137	M4	0,7 –	4,5 <i>0.177</i>	19,0 <i>0.748</i>	12,0 <i>0.472</i>	59,85 <i>2.356</i>	3,4 <i>0.134</i>	4.50X3.40	2	DIN371	6H	B
MTP-M5X0.80ISO6H-TB-N001	03000138	M5	0,8 –	6,0 <i>0.236</i>	23,0 <i>0.906</i>	13,0 <i>0.512</i>	66,4 <i>2.614</i>	4,3 <i>0.169</i>	6.00X4.90	2	DIN371	6H	B
MTP-M6X1.00ISO6H-TB-N001	03000139	M6	1,0 –	6,0 <i>0.236</i>	27,0 <i>1.063</i>	15,0 <i>0.591</i>	75,375 <i>2.968</i>	5,1 <i>0.201</i>	6.00X4.90	3	DIN371	6H	B
MTP-M8X1.25ISO6H-TB-N001	03000140	M8	1,25 –	8,0 <i>0.315</i>	28,0 <i>1.102</i>	18,0 <i>0.709</i>	84,21875 <i>3.316</i>	6,8 <i>0.268</i>	8.00X6.20	3	DIN371	6H	B
MTP-M10X1.50ISO6H-TB-N001	03000141	M10	1,5 –	10,0 <i>0.394</i>	30,0 <i>1.181</i>	20,0 <i>0.787</i>	93,25 <i>3.671</i>	8,6 <i>0.339</i>	10.00X8.00	3	DIN371	6H	B

Thread turning

MDT

Mini-Shaft™

Thread milling

Thread tapping

Annex

MTP-N001-A

Through holes – Metric coarse threads

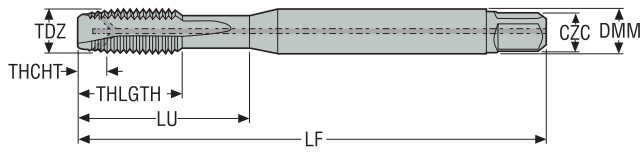

- Internal coolant
- Substrate: HSS-PM
- Coating: BRIGHT
- For cutting data see page(s) 273

Designation	Item number	TDZ	Pitch		DMM	LU	THLGTH	LF	PHDR	CZC	NOF	BSG	TCTR	THCHT
			mm	TPI										
MTP-M4X0.70ISO6H-TB-N001-A	03000145	M4	0,7	–	4,5 0.177	19,0 0.748	12,0 0.472	59,85 2.356	3,4 0.134	4.50X3.40	2	DIN371	6H	B
MTP-M5X0.80ISO6H-TB-N001-A	03000146	M5	0,8	–	6,0 0.236	23,0 0.906	13,0 0.512	66,4 2.614	4,3 0.169	6.00X4.90	2	DIN371	6H	B
MTP-M6X1.00ISO6H-TB-N001-A	03000147	M6	1,0	–	6,0 0.236	27,0 1.063	15,0 0.591	75,5 2.972	5,1 0.201	6.00X4.90	3	DIN371	6H	B
MTP-M8X1.25ISO6H-TB-N001-A	03000148	M8	1,25	–	8,0 0.315	28,0 1.102	18,0 0.709	84,37 3.322	6,8 0.268	8.00X6.20	3	DIN371	6H	B
MTP-M10X1.50ISO6H-TB-N001-A	03000149	M10	1,5	–	10,0 0.394	30,0 1.181	20,0 0.787	93,25 3.671	8,6 0.339	10.00X8.00	3	DIN371	6H	B

MTP-N002

Through holes – Metric coarse threads

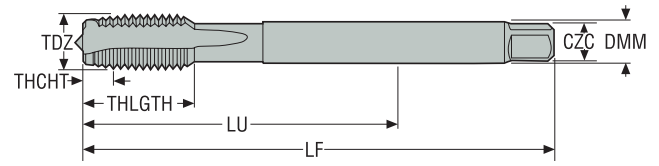

- Substrate: HSS-E
- Coating: BRIGHT
- For cutting data see page(s) 273

Designation	Item number	TDZ	Pitch	DMM	LU	THLGTH	LF	PHDR	CZC	NOF	BSG	TCTR	THCHT
			mm TPI	mm <i>Inch</i>	mm <i>Inch</i>	mm <i>Inch</i>	mm <i>Inch</i>	mm <i>Inch</i>					
MTP-M12X1.75ISO6H-TB-N002	03000142	M12	1,75 –	9,0 <i>0.354</i>	83,0 <i>3.268</i>	23,0 <i>0.906</i>	102,1 <i>4.020</i>	10,4 <i>0.409</i>	9.00X7.00	3	DIN376	6H	B
MTP-M14X2.00ISO6H-TB-N002	03000143	M14	2,0 –	11,0 <i>0.433</i>	81,0 <i>3.189</i>	25,0 <i>0.984</i>	101,0 <i>3.976</i>	12,1 <i>0.476</i>	11.00X9.00	4	DIN376	6H	B
MTP-M16X2.00ISO6H-TB-N002	03000144	M16	2,0 –	12,0 <i>0.472</i>	68,0 <i>2.677</i>	25,0 <i>0.984</i>	101,0 <i>3.976</i>	14,1 <i>0.555</i>	12.00X9.00	4	DIN376	6H	B

Thread turning

MDT

Mini-Shaft™

Thread milling

Thread tapping

Annex

MTP-N002-A

Through holes – Metric coarse threads

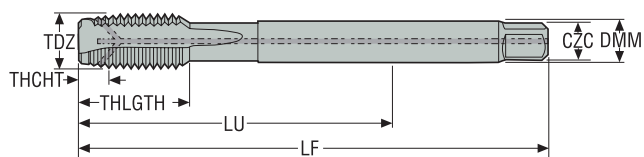

- Internal coolant
- Substrate: HSS-PM
- Coating: BRIGHT
- For cutting data see page(s) 273

Designation	Item number	TDZ	Pitch		DMM	LU	THLGTH	LF	PHDR	CZC	NOF	BSG	TCTR	THCHT
			mm	TPI										
MTP-M12X1.75ISO6H-TB-N002-A	03000150	M12	1,75	–	9,0 0.354	83,0 3.268	23,0 0.906	102,1 4.020	10,4 0.409	9.00X7.00	3	DIN376	6H	B
MTP-M14X2.00ISO6H-TB-N002-A	03000151	M14	2,0	–	11,0 0.433	81,0 3.189	25,0 0.984	101,0 3.976	12,1 0.476	11.00X9.00	4	DIN376	6H	B
MTP-M16X2.00ISO6H-TB-N002-A	03000152	M16	2,0	–	12,0 0.472	68,0 2.677	25,0 0.984	101,0 3.976	14,1 0.555	12.00X9.00	4	DIN376	6H	B

MTP-S001

Through holes – Metric coarse threads

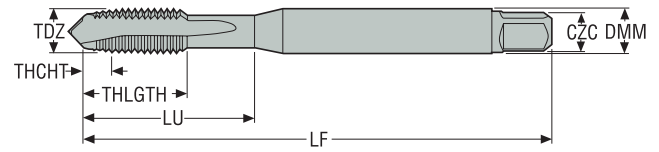

- Substrate: HSS-E-PM
- Coating: AlCrN
- For cutting data see page(s) 279

Designation	Item number	TDZ	Pitch		DMM	LU	THLGTH	LF	PHDR	CZC	NOF	BSG	TCTR	THCHT
			mm	TPI										
MTP-M2X0.40ISO6HX-TB-S001	10001159	M2	0,4	–	2,8 0.110	8,0 0.315	8,0 0.315	43,2 1.701	1,6 0.063	2.80X2.10	2	DIN371	6HX	B
MTP-M2.5X0.45ISO6HX-TB-S001	10001161	M2.5	0,45	–	2,8 0.110	9,0 0.354	9,0 0.354	47,97 1.889	2,1 0.083	2.80X2.10	2	DIN371	6HX	B
MTP-M3X0.50ISO6HX-TB-S001	10001162	M3	0,5	–	3,5 0.138	10,0 0.394	10,0 0.394	53,75 2.116	2,5 0.098	3.50X2.70	2	DIN371	6HX	B
MTP-M3.5X0.60ISO6HX-TB-S001	10001163	M3.5	0,6	–	4,0 0.157	12,0 0.472	12,0 0.472	53,3 2.098	2,9 0.114	4.00X3.00	3	DIN371	6HX	B
MTP-M4X0.70ISO6HX-TB-S001	10001164	M4	0,7	–	4,5 0.177	13,0 0.512	13,0 0.512	59,85 2.356	3,4 0.134	4.50X3.40	3	DIN371	6HX	B
MTP-M5X0.80ISO6HX-TB-S001	10001165	M5	0,8	–	6,0 0.236	16,0 0.630	16,0 0.630	66,4 2.614	4,3 0.169	6.00X4.90	3	DIN371	6HX	B
MTP-M6X1.00ISO6HX-TB-S001	10001166	M6	1,0	–	6,0 0.236	23,0 0.906	15,0 0.591	75,5 2.972	5,1 0.201	6.00X4.90	3	DIN371	6HX	B
MTP-M8X1.25ISO6HX-TB-S001	10001167	M8	1,25	–	8,0 0.315	29,5 1.161	18,0 0.709	84,37 3.322	6,8 0.268	8.00X6.20	3	DIN371	6HX	B
MTP-M10X1.50ISO6HX-TB-S001	10001168	M10	1,5	–	10,0 0.394	33,5 1.319	20,0 0.787	93,25 3.671	8,6 0.339	10.00X8.00	3	DIN371	6HX	B

Thread turning

MDT

Mini-Shaft™

Thread milling

Thread tapping

Annex

MTP-S002

Through holes – Metric coarse threads

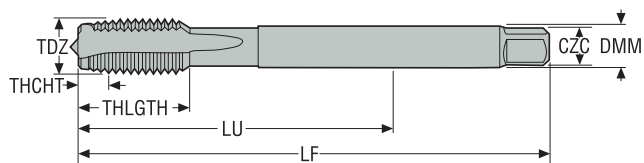

- Substrate: HSS-E-PM
- Coating: AlCrN
- For cutting data see page(s) 279

Designation	Item number	TDZ	Pitch		DMM	LU	THLGTH	LF	PHDR	CZC	NOF	BSG	TCTR	THCHT
			mm	TPI										
MTP-M12X1.75ISO6HX-TB-S002	10001169	M12	1,75	–	9,0 0.354	83,0 3.268	23,0 0.906	102,12 4.020	10,4 0.409	9.00X7.00	4	DIN376	6HX	B
MTP-M16X2.00ISO6HX-TB-S002	10001170	M16	2,0	–	12,0 0.472	68,0 2.677	25,0 0.984	101,0 3.976	14,1 0.555	12.00X9.00	4	DIN376	6HX	B
MTP-M20X2.50ISO6HX-TB-S002	10001171	M20	2,5	–	16,0 0.630	95,0 3.740	30,0 1.181	128,75 5.069	17,7 0.697	16.00X12.00	4	DIN376	6HX	B

MTP-S011

Through holes – MF threads

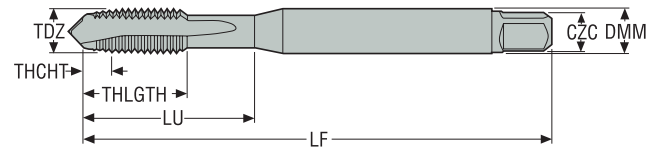

- Substrate: HSS-E-PM
- Coating: AlCrN
- For cutting data see page(s) 279

Designation	Item number	TDZ	Pitch	DMM	LU	THLGTH	LF	PHDR	CZC	NOF	BSG	TCTR	THCHT
			mm TPI	mm Inch	mm Inch	mm Inch	mm Inch	mm Inch					
MTP-M6X0.75ISO6HX-TB-S011	10001176	MF6X0.75	0,75 –	6,0 0.236	23,0 0.906	15,0 0.591	76,62 3.017	5,25 0.207	6.00X4.90	3	DIN371	6HX	B
MTP-M8X0.75ISO6HX-TB-S011	10001177	MF8X0.75	0,75 –	8,0 0.315	29,5 1.161	18,0 0.709	86,62 3.410	7,25 0.285	8.00X6.20	3	DIN371	6HX	B
MTP-M8X1.00ISO6HX-TB-S011	10001178	MF8X1.0	1,0 –	8,0 0.315	29,5 1.161	18,0 0.709	85,5 3.366	7,0 0.276	8.00X6.20	3	DIN371	6HX	B
MTP-M10X1.00ISO6HX-TB-S011	10001179	MF10X1.0	1,0 –	10,0 0.394	33,5 1.319	20,0 0.787	95,5 3.760	9,0 0.354	10.00X8.00	3	DIN371	6HX	B
MTP-M12X1.00ISO6HX-TB-S011	10001180	MF12X1.0	1,0 –	9,0 0.354	73,0 2.874	21,0 0.827	95,5 3.760	11,0 0.433	9.00X7.00	4	DIN374	6HX	B
MTP-M12X1.50ISO6HX-TB-S011	10001181	MF12X1.5	1,5 –	9,0 0.354	73,0 2.874	21,0 0.827	93,25 3.671	10,5 0.413	9.00X7.00	4	DIN374	6HX	B
MTP-M14X1.50ISO6HX-TB-S011	10001182	MF14X1.5	1,5 –	11,0 0.433	71,0 2.795	21,0 0.827	93,25 3.671	12,5 0.492	11.00X9.00	4	DIN374	6HX	B

Thread turning

MDT

Mini-Shaft™

Thread milling

Thread tapping

Annex

MTP-S012

Through holes – MJ threads

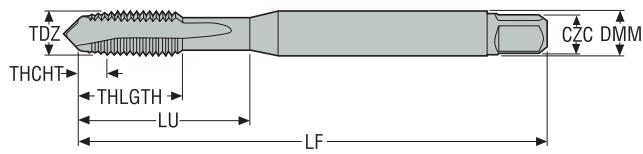

- Substrate: HSS-E-PM
- Coating: AlCrN
- For cutting data see page(s) 279

Designation	Item number	TDZ	Pitch		DMM	LU	THLGTH	LF	PHDR	CZC	NOF	BSG	TCTR	THCHT
			mm	TPI										
MTP-MJ4X0.70ISO4H-TB-S012	10001172	MJ4X0.7	0,7	–	4,5 0.177	13,0 0.512	13,0 0.512	59,85 2.356	3,4 0.134	4.50X3.40	3	DIN371	4H	B
MTP-MJ5X0.80ISO4H-TB-S012	10001173	MJ5X0.8	0,8	–	6,0 0.236	16,0 0.630	16,0 0.630	66,4 2.614	4,3 0.169	6.00X4.90	3	DIN371	4H	B
MTP-MJ6X1.00ISO4H-TB-S012	10001174	MJ6X1	1,0	–	6,0 0.236	23,0 0.906	15,0 0.591	75,5 2.972	5,1 0.201	6.00X4.90	3	DIN371	4H	B
MTP-MJ8X1.25ISO4H-TB-S012	10001175	MJ8X1.25	1,25	–	8,0 0.315	29,5 1.161	18,0 0.709	84,37 3.322	6,9 0.272	8.00X6.20	3	DIN371	4H	B

Thread turning

MDT

Mini-Shaft™

Thread milling

Thread tapping

Annex

MTP-S013

Through holes – EGM threads

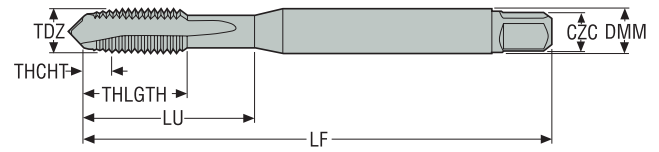

- Substrate: HSS-E-PM
- For cutting data see page(s) 279

Designation	Item number	TDZ	Pitch		DMM	LU	THLGTH	LF	PHDR	CXC	NOF	BSG	TCTR	THCHT
			mm	TPI										
MTP-EGM4X0.7ISO4H-TB-S013 MTP-STIM4X0.7ISO4H-TB-S013	10001218	EGM4	0,7	–	6,0 0.236	16 0.630	16,0 0.630	66,9 2.632	4,2 0.165	6.00X4.90	3	DIN40435	4H	B
MTP-EGM5X0.8ISO4H-TB-S013 MTP-STIM5X0.8ISO4H-TB-S013	10001219	EGM5	0,8	–	6,0 0.236	23 0.906	15,0 0.591	76,4 3.008	5,3 0.207	6.00X4.90	3	DIN40435	4H	B
MTP-EGM6X1.0ISO4H-TB-S013 MTP-STIM6X1.0ISO4H-TB-S013	10001220	EGM6	1,0	–	8,0 0.315	35 1.378	18,0 0.709	85,5 3.366	6,3 0.248	8.00X6.20	3	DIN40435	4H	B
MTP-EGM8X1.25ISO4H-TB-S013 MTP-STIM8X1.25ISO4H-TB-S013	10001221	EGM8	1,25	–	10,0 0.394	34 1.319	20,0 0.787	94,4 3.715	8,4 0.331	10.00X8.00	3	DIN40435	4H	B

Thread turning

MDT

Mini-Shaft™

Thread milling

Thread tapping

Annex

MTP-S042

Through holes – UNJF threads

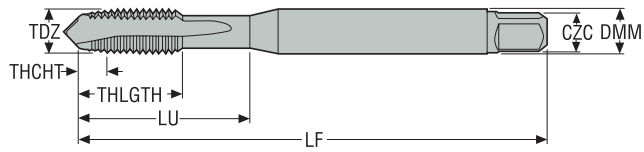

- Substrate: HSS-E-PM
- Coating: AlCrN
- For cutting data see page(s) 279

Designation	Item number	TDZ	Pitch		DMM	LU	THLGTH	LF	PHDR	CZC	NOF	BSG	TCTR	THCHT
			mm	TPI										
MTP-10-32UNJF3B-TB-S042	10001183	UNJF10-32	–	32.0	6,0 <i>0.236</i>	16,0 <i>0.630</i>	16,0 <i>0.630</i>	66,43 <i>2.615</i>	4,15 <i>0.163</i>	6.00X4.90	3	DIN2184-1	3B	B
MTP-1/4-28UNJF3B-TB-S042	10001184	UNJF1/4-28	–	28.0	7,0 <i>0.276</i>	25,0 <i>0.984</i>	15,0 <i>0.591</i>	75,92 <i>2.989</i>	5,6 <i>0.220</i>	7.00X5.50	3	DIN2184-1	3B	B
MTP-5/16-24UNJF3B-TB-S042	10001186	UNJF5/16-24	–	24.0	8,0 <i>0.315</i>	29,5 <i>1.161</i>	18,0 <i>0.709</i>	85,24 <i>3.356</i>	7,0 <i>0.276</i>	8.00X6.20	3	DIN2184-1	3B	B
MTP-3/8-24UNJF3B-TB-S042	10001185	UNJF3/8-24	–	24.0	10,0 <i>0.394</i>	33,5 <i>1.319</i>	20,0 <i>0.787</i>	95,24 <i>3.750</i>	8,6 <i>0.339</i>	10.00X8.00	3	DIN2184-1	3B	B

MTP-S043

Through holes – EGUNF threads

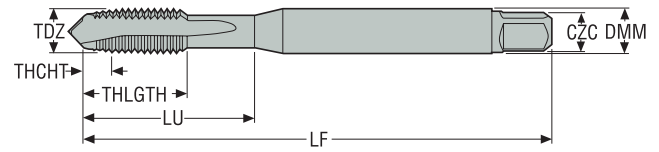

- Substrate: HSS-E-PM
- For cutting data see page(s) 279

Designation	Item number	TDZ	Pitch		DMM	LU	THLGTH	LF	PHDR	CZC	NOF	BSG	TCTR	THCHT
			mm	TPI										
MTP-10-32EGUNF3B-TB-S043	10001214	EGUN10-32	–	32.0	6,0 0.236	23,0 0.906	15,0 0.591	76,43 3.009	5,1 0.201	6.00X4.90	3	DIN2184-1	3B	B
MTP-1/4-28EGUNF3B-TB-S043	10001215	EGUNF1/4-28	–	28.0	8,0 0.315	29,5 1.161	18,0 0.709	85,92 3.383	6,6 0.260	8.00X6.20	3	DIN2184-1	3B	B
MTP-5/16-24EGUNF3B-TB-S043	10001216	EGUNF5/16-24	–	24.0	10,0 0.394	33,5 1.319	20,0 0.787	95,24 3.750	8,2 0.323	10.00X8.00	3	DIN2184-1	3B	B
MTP-3/8-24EGUNF3B-TB-S043	10001217	EGUNF3/8-24	–	24.0	8,0 0.315	76,0 2.992	20,0 0.787	95,24 3.750	9,8 0.386	8.00X6.20	3	DIN2184-1	3B	B

Thread turning

MDT

Mini-Shaft™

Thread milling

Thread tapping

Annex

MTH-P001

Blind holes – Metric coarse threads

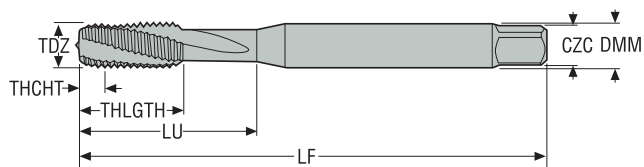

- Substrate: HSS-E-PM
- Coating: TiAlN
- For cutting data see page(s) 267

Designation	Item number	TDZ	Pitch		DMM	LU	THLGTH	LF	PHDR	CZC	NOF	BSG	TCTR	THCHT
			mm	TPI										
MTH-M3X0.50ISO6H-BC-P001	02999974	M3	0,5	–	4,5 0.177	12,0 0.472	12,0 0.472	61,625 2.426	2,5 0.098	4.50X3.40	3	SECO-DIN	6H	C
MTH-M4X0.70ISO6H-BC-P001	02999975	M4	0,7	–	6,0 0.236	13,0 0.512	13,0 0.512	67,97 2.676	3,4 0.134	6.00X4.90	3	SECO-DIN	6H	C
MTH-M5X0.80ISO6H-BC-P001	02999976	M5	0,8	–	6,0 0.236	15,0 0.591	15,0 0.591	77,67 3.058	4,3 0.169	6.00X4.90	3	SECO-DIN	6H	C
MTH-M6X1.00ISO6H-BC-P001	02999977	M6	1,0	–	8,0 0.315	18,0 0.709	18,0 0.709	87,25 3.435	5,1 0.201	8.00X6.20	3	SECO-DIN	6H	C
MTH-M8X1.25ISO6H-BC-P001	02999978	M8	1,25	–	10,0 0.394	20,0 0.787	20,0 0.787	96,5625 3.802	6,8 0.268	10.00X8.00	3	SECO-DIN	6H	C
MTH-M10X1.50ISO6H-BC-P001	02999979	M10	1,5	–	10,0 0.394	39,0 1.535	20,0 0.787	95,875 3.775	8,6 0.339	10.00X8.00	3	SECO-DIN	6H	C

MTH-P001-A

Blind holes – Metric coarse threads

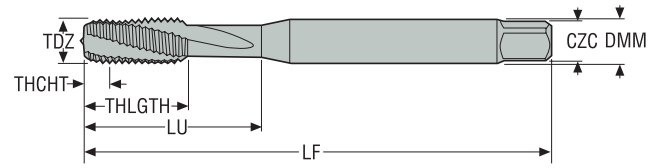

- Internal coolant
- Substrate: HSS-E-PM
- Coating: TiAIN
- For cutting data see page(s) 267

Designation	Item number	TDZ	Pitch	DMM	LU	THLGTH	LF	PHDR	CZC	NOF	BSG	TCTR	THCHT
			mm TPI	mm Inch	mm Inch	mm Inch	mm Inch	mm Inch					
MTH-M4X0.70ISO6H-BC-P001-A	02999985	M4	0,7 –	6,0 0.236	13,0 0.512	13,0 0.512	67,97 2.676	3,4 0.134	6.00X4.90	3	SECO-DIN	6H	C
MTH-M5X0.80ISO6H-BC-P001-A	02999986	M5	0,8 –	6,0 0.236	15,0 0.591	15,0 0.591	77,67 3.058	4,3 0.169	6.00X4.90	3	SECO-DIN	6H	C
MTH-M6X1.00ISO6H-BC-P001-A	02999987	M6	1,0 –	8,0 0.315	18,0 0.709	18,0 0.709	87,07 3.428	5,1 0.201	8.00X6.20	3	SECO-DIN	6H	C
MTH-M8X1.25ISO6H-BC-P001-A	02999988	M8	1,25 –	10,0 0.394	20,0 0.787	20,0 0.787	96,32 3.792	6,8 0.268	10.00X8.00	3	SECO-DIN	6H	C
MTH-M10X1.50ISO6H-BC-P001-A	02999989	M10	1,5 –	10,0 0.394	39,0 1.535	20,0 0.787	95,57 3.763	8,6 0.339	10.00X8.00	3	SECO-DIN	6H	C

Thread turning

MDT

Mini-Shaft™

Thread milling

Thread tapping

Annex

MTH-P002

Blind holes – Metric coarse threads

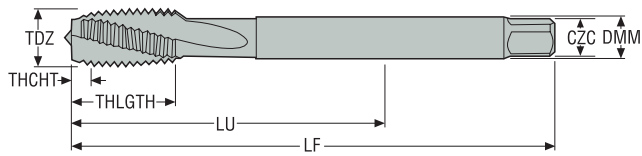

- Substrate: HSS-E-PM
- Coating: TiAlN
- For cutting data see page(s) 267

Designation	Item number	TDZ	Pitch		DMM	LU	THLGTH	LF	PHDR	CZC	NOF	BSG	TCTR	THCHT
			mm	TPI										
MTH-M12X1.75ISO6H-BC-P002	02999980	M12	1,75	–	9,0 0.354	83,0 3.268	23,0 0.906	105,1875 4.141	10,4 0.409	9.00X7.00	4	DIN376	6H	C
MTH-M14X2.00ISO6H-BC-P002	02999981	M14	2,0	–	11,0 0.433	81,0 3.189	25,0 0.984	104,5 4.114	12,1 0.476	11.00X9.00	4	DIN376	6H	C
MTH-M16X2.00ISO6H-BC-P002	02999982	M16	2,0	–	12,0 0.472	68,0 2.677	25,0 0.984	104,5 4.114	14,1 0.555	12.00X9.00	4	DIN376	6H	C
MTH-M18X2.50ISO6H-BC-P002	02999983	M18	2,5	–	14,0 0.551	81,0 3.189	30,0 1.181	118,125 4.651	15,7 0.618	14.00X11.00	4	DIN376	6H	C
MTH-M20X2.50ISO6H-BC-P002	02999984	M20	2,5	–	16,0 0.630	95,0 3.740	30,0 1.181	133,125 5.241	17,7 0.697	16.00X12.00	4	DIN376	6H	C

MTH-P002-A

Blind holes – Metric coarse threads

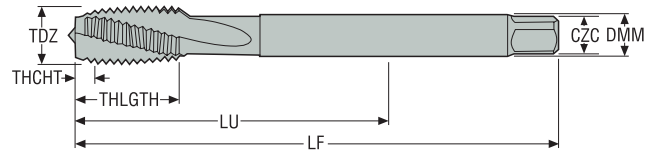

- Internal coolant
- Substrate: HSS-E-PM
- Coating: TiAIN
- For cutting data see page(s) 267

Designation	Item number	TDZ	Pitch	DMM	LU	THLGTH	LF	PHDR	CXC	NOF	BSG	TCTR	THCHT
			mm TPI	mm Inch	mm Inch	mm Inch	mm Inch	mm Inch					
MTH-M12X1.75ISO6H-BC-P002-A	02999990	M12	1,75 –	9,0 0.354	83,0 3.268	23,0 0.906	104,38 4.109	10,4 0.409	9.00X7.00	4	DIN376	6H	C
MTH-M14X2.00ISO6H-BC-P002-A	02999991	M14	2,0 –	11,0 0.433	81,0 3.189	25,0 0.984	103,74 4.084	12,1 0.476	11.00X9.00	4	DIN376	6H	C
MTH-M16X2.00ISO6H-BC-P002-A	02999992	M16	2,0 –	12,0 0.472	68,0 2.677	25,0 0.984	103,74 4.084	14,1 0.555	12.00X9.00	4	DIN376	6H	C
MTH-M18X2.50ISO6H-BC-P002-A	02999993	M18	2,5 –	14,0 0.551	81,0 3.189	30,0 1.181	117,05 4.608	15,7 0.618	14.00X11.00	4	DIN376	6H	C
MTH-M20X2.50ISO6H-BC-P002-A	02999994	M20	2,5 –	16,0 0.630	95,0 3.740	30,0 1.181	132,05 5.199	17,7 0.697	16.00X12.00	4	DIN376	6H	C

Thread turning

MDT

Mini-Shaft™

Thread milling

Thread tapping

Annex

MTH-P003

Blind holes – Metric coarse threads

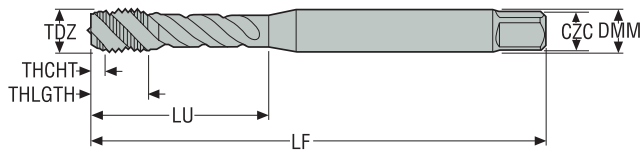

- Internal coolant
- Substrate: HSS-E-PM
- Coating: TiAlN
- For cutting data see page(s) 267

Designation	Item number	TDZ	Pitch		DMM	LU	THLGTH	LF	PHDR	CZC	NOF	BSG	TCTR	THCHT
			mm	TPI	mm Inch	mm Inch	mm Inch	mm Inch	mm Inch					
MTH-M1.6X0.35ISO6HX-BC-P003	02999995	M1.6	0,35	–	2,5 0.098	6,0 0.236	4,0 0.157	39,3 1.547	1,3 0.051	2.50X2.10	2	DIN371	6HX	C
MTH-M2X0.40ISO6HX-BC-P003	02999996	M2	0,4	–	2,8 0.110	9,0 0.354	4,0 0.157	44,2 1.740	1,6 0.063	2.80X2.10	2	DIN371	6HX	C
MTH-M2.2X0.45ISO6HX-BC-P003	02999997	M2.2	0,45	–	2,8 0.110	12,0 0.472	4,0 0.157	44,1 1.736	1,8 0.071	2.80X2.10	2	DIN371	6HX	C
MTH-M2.3X0.40ISO6HX-BC-P003	02999998	M2.3	0,4	–	2,8 0.110	12,0 0.472	4,0 0.157	44,2 1.740	1,9 0.075	2.80X2.10	2	DIN371	6HX	C
MTH-M2.5X0.45ISO6HX-BC-P003	02999999	M2.5	0,45	–	2,8 0.110	12,5 0.492	4,0 0.157	49,1 1.933	2,1 0.083	2.80X2.10	2	DIN371	6HX	C
MTH-M2.6X0.45ISO6HX-BC-P003	03000000	M2.6	0,45	–	2,8 0.110	12,5 0.492	4,0 0.157	49,1 1.933	2,15 0.085	2.80X2.10	2	DIN371	6HX	C
MTH-M3X0.50ISO6HX-BC-P003	03000001	M3	0,5	–	3,5 0.138	18,0 0.709	5,9 0.232	54,625 2.151	2,5 0.098	3.50X2.70	3	DIN371	6HX	C
MTH-M3.5X0.60ISO6HX-BC-P003	03000002	M3.5	0,6	–	4,0 0.157	20,0 0.787	7,0 0.276	54,35 2.140	2,9 0.114	4.00X3.00	3	DIN371	6HX	C
MTH-M4X0.70ISO6HX-BC-P003	03000003	M4	0,7	–	4,5 0.177	21,0 0.827	6,7 0.264	61,075 2.405	3,4 0.134	4.50X3.40	3	DIN371	6HX	C
MTH-M5X0.80ISO6HX-BC-P003	03000004	M5	0,8	–	6,0 0.236	25,0 0.984	7,7 0.303	67,8 2.669	4,3 0.169	6.00X4.90	3	DIN371	6HX	C
MTH-M6X1.00ISO6HX-BC-P003	03000006	M6	1,0	–	6,0 0.236	30,0 1.181	10,0 0.394	77,25 3.041	5,1 0.201	6.00X4.90	3	DIN371	6HX	C
MTH-M7X1.00ISO6HX-BC-P003	03000007	M7	1,0	–	7,0 0.276	30,0 1.181	10,0 0.394	77,25 3.041	6,1 0.240	7.00X5.50	3	DIN371	6HX	C
MTH-M8X1.25ISO6HX-BC-P003	03000008	M8	1,25	–	8,0 0.315	35,0 1.378	11,6 0.457	86,5625 3.408	6,8 0.268	8.00X6.20	3	DIN371	6HX	C
MTH-M10X1.50ISO6HX-BC-P003	03000009	M10	1,5	–	10,0 0.394	39,0 1.535	15,1 0.594	95,875 3.775	8,6 0.339	10.00X8.00	3	DIN371	6HX	C

MTH-P003-A

Blind holes – Metric coarse threads

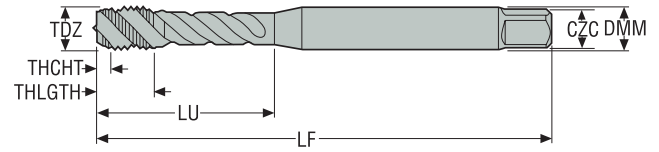

- Internal coolant
- Substrate: HSS-E-PM
- Coating: AlTiN-based
- For cutting data see page(s) 267

Designation	Item number	TDZ	Pitch	DMM	LU	THLGTH	LF	PHDR	CXC	NOF	BSG	TCTR	THCHT
			mm TPI	mm Inch	mm Inch	mm Inch	mm Inch	mm Inch					
MTH-M4X0.70ISO6HX-BC-P003-A	03000024	M4	0,7 –	4,5 0.177	21,0 0.827	6,7 0.264	61,075 2.405	3,4 0.134	4.50X3.40	3	DIN371	6HX	C
MTH-M5X0.80ISO6HX-BC-P003-A	03000025	M5	0,8 –	6,0 0.236	25,0 0.984	7,7 0.303	68,1 2.681	4,3 0.169	6.00X4.90	3	DIN371	6HX	C
MTH-M6X1.00ISO6HX-BC-P003-A	03000026	M6	1,0 –	6,0 0.236	30,0 1.181	10,0 0.394	77,39 3.047	5,1 0.201	6.00X4.90	3	DIN371	6HX	C
MTH-M7X1.00ISO6HX-BC-P003-A	03000027	M7	1,0 –	7,0 0.276	30,0 1.181	10,0 0.394	77,25 3.041	6,1 0.240	7.00X5.50	3	DIN371	6HX	C
MTH-M8X1.25ISO6HX-BC-P003-A	03000028	M8	1,25 –	8,0 0.315	35,0 1.378	11,6 0.457	86,5625 3.408	6,8 0.268	8.00X6.20	3	DIN371	6HX	C
MTH-M10X1.50ISO6HX-BC-P003-A	03000029	M10	1,5 –	10,0 0.394	39,0 1.535	15,1 0.594	95,875 3.775	8,6 0.339	10.00X8.00	3	DIN371	6HX	C

Thread turning

MDT

Mini-Shaft™

Thread milling

Thread tapping

Annex

MTH-P004

Blind holes – Metric coarse threads

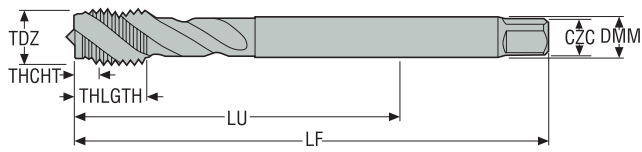

- Substrate: HSS-E-PM
- Coating: AlTiN-based
- For cutting data see page(s) 267

Designation	Item number	TDZ	Pitch		DMM	LU	THLGTH	LF	PHDR	CZC	NOF	BSG	TCTR	THCHT
			mm	TPI										
MTH-M5X0.80ISO6HX-BC-P004	03000010	M5	0.8	–	3,5 0.138	49,0 1.929	8,0 0.315	67,8 2.669	4,3 0.169	3.50X2.70	3	DIN376	6HX	C
MTH-M6X1.00ISO6HX-BC-P004	03000011	M6	1,0	–	4,5 0.177	59,0 2.323	10,0 0.394	77,25 3.041	5,1 0.201	4.50X3.40	3	DIN376	6HX	C
MTH-M7X1.00ISO6HX-BC-P004	03000012	M7	1,0	–	5,5 0.217	59,0 2.323	10,0 0.394	77,25 3.041	6,1 0.240	5.50X4.30	3	DIN376	6HX	C
MTH-M8X1.25ISO6HX-BC-P004	03000013	M8	1,25	–	6,0 0.236	67,0 2.638	13,0 0.512	86,5625 3.408	6,8 0.268	6.00X4.90	3	DIN376	6HX	C
MTH-M10X1.50ISO6HX-BC-P004	03000014	M10	1,5	–	7,0 0.276	77,0 3.031	20,0 0.787	95,875 3.775	8,6 0.339	7.00X5.50	3	DIN376	6HX	C
MTH-M12X1.75ISO6HX-BC-P004	03000015	M12	1,75	–	9,0 0.354	83,0 3.268	16,0 0.630	105,59 4.157	10,4 0.409	9.00X7.00	3	DIN376	6HX	C
MTH-M14X2.00ISO6HX-BC-P004	03000016	M14	2,0	–	11,0 0.433	81,0 3.189	25,0 0.984	104,5 4.114	12,1 0.476	11.00X9.00	3	DIN376	6HX	C
MTH-M16X2.00ISO6HX-BC-P004	03000017	M16	2,0	–	12,0 0.472	68,0 2.677	20,0 0.787	104,5 4.114	14,1 0.555	12.00X9.00	4	DIN376	6HX	C
MTH-M18X2.50ISO6HX-BC-P004	03000018	M18	2,5	–	14,0 0.551	81,0 3.189	25,0 0.984	118,75 4.675	15,7 0.618	14.00X11.00	4	DIN376	6HX	C
MTH-M20X2.50ISO6HX-BC-P004	03000019	M20	2,5	–	16,0 0.630	95,0 3.740	25,0 0.984	133,75 5.266	17,7 0.697	16.00X12.00	4	DIN376	6HX	C
MTH-M22X2.50ISO6HX-BC-P004	03000020	M22	2,5	–	18,0 0.709	93,0 3.661	25,0 0.984	133,73 5.265	19,7 0.776	18.00X14.50	4	DIN376	6HX	C
MTH-M24X3.00ISO6HX-BC-P004	03000021	M24	3,0	–	18,0 0.709	113,0 4.449	30,0 1.181	152,72 6.013	21,0 0.827	18.00X14.50	4	DIN376	6HX	C
MTH-M27X3.00ISO6HX-BC-P004	03000022	M27	3,0	–	20,0 0.787	97,0 3.819	30,0 1.181	152,76 6.014	24,0 0.945	20.00X16.00	4	DIN376	6HX	C
MTH-M30X3.50ISO6HX-BC-P004	03000023	M30	3,5	–	22,0 0.866	115,0 4.528	36,0 1.417	171,78 6.763	26,5 1.043	22.00X18.00	4	DIN376	6HX	C

MTH-P004-A

Blind holes – Metric coarse threads

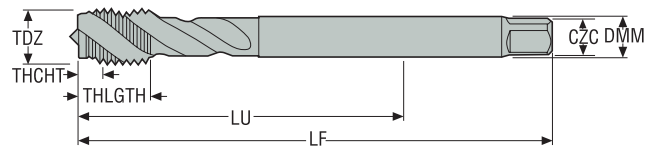

- Internal coolant
- Substrate: HSS-E-PM
- Coating: AlTiN-based
- For cutting data see page(s) 267

Designation	Item number	TDZ	Pitch	DMM	LU	THLGTH	LF	PHDR	CZC	NOF	BSG	TCTR	THCHT
			mm TPI	mm Inch	mm Inch	mm Inch	mm Inch	mm Inch					
MTH-M12X1.75ISO6HX-BC-P004-A	03000030	M12	1,75 –	9,0 0.354	83,0 3.268	16,0 0.630	105,59 4.157	10,4 0.409	9.00X7.00	3	DIN376	6HX	C
MTH-M14X2.00ISO6HX-BC-P004-A	03000031	M14	2,0 –	11,0 0.433	81,0 3.189	25,0 0.984	105,08 4.137	12,1 0.476	11.00X9.00	3	DIN376	6HX	C
MTH-M16X2.00ISO6HX-BC-P004-A	03000032	M16	2,0 –	12,0 0.472	68,0 2.677	20,0 0.787	104,5 4.114	14,1 0.555	12.00X9.00	4	DIN376	6HX	C
MTH-M18X2.50ISO6HX-BC-P004-A	03000033	M18	2,5 –	14,0 0.551	81,0 3.189	25,0 0.984	118,75 4.675	15,7 0.618	14.00X11.00	4	DIN376	6HX	C
MTH-M20X2.50ISO6HX-BC-P004-A	03000034	M20	2,5 –	16,0 0.630	95,0 3.740	25,0 0.984	133,75 5.266	17,7 0.697	16.00X12.00	4	DIN376	6HX	C
MTH-M22X2.50ISO6HX-BC-P004-A	03000036	M22	2,5 –	18,0 0.709	93,0 3.661	25,0 0.984	133,73 5.265	19,7 0.776	18.00X14.50	4	DIN376	6HX	C
MTH-M24X3.00ISO6HX-BC-P004-A	03000037	M24	3,0 –	18,0 0.709	113,0 4.449	30,0 1.181	152,72 6.013	21,0 0.827	18.00X14.50	4	DIN376	6HX	C
MTH-M27X3.00ISO6HX-BC-P004-A	03000038	M27	3,0 –	20,0 0.787	97,0 3.819	30,0 1.181	151,75 5.974	24,0 0.945	20.00X16.00	4	DIN376	6HX	C
MTH-M30X3.50ISO6HX-BC-P004-A	03000039	M30	3,5 –	22,0 0.866	115,0 4.528	36,0 1.417	171,78 6.763	26,5 1.043	22.00X18.00	4	DIN376	6HX	C

Thread turning

MDT

Mini-Shaft™

Thread milling

Thread tapping

Annex

MTH-P011

Blind holes – MF threads

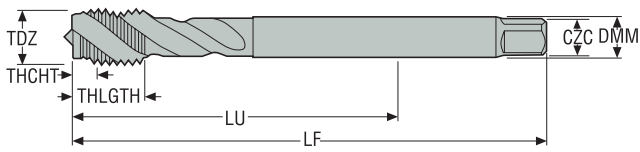

- Substrate: HSS-E-PM
- Coating: AlTiN-based
- For cutting data see page(s) 267

Designation	Item number	TDZ	Pitch		DMM	LU	THLGTH	LF	PHDR	CZC	NOF	BSG	CTCR	THCHT
			mm	TPI										
MTH-M4X0.50ISO6HX-BC-P011	03000040	MF4X0.5	0,5	–	2,8 0.110	43,0 1.693	7,0 0.276	61,625 2.426	3,5 0.138	2.80X2.10	3	DIN374	6HX	C
MTH-M5X0.50ISO6HX-BC-P011	03000041	MF5X0.5	0,5	–	3,5 0.138	49,0 1.929	8,0 0.315	68,75 2.707	4,5 0.177	3.50X2.70	3	DIN374	6HX	C
MTH-M6X0.75ISO6HX-BC-P011	03000042	MF6X0.75	0,75	–	4,5 0.177	59,0 2.323	10,0 0.394	77,7 3.059	5,3 0.209	4.50X3.40	3	DIN374	6HX	C
MTH-M8X0.75ISO6HX-BC-P011	03000043	MF8X0.75	0,75	–	6,0 0.236	57,0 2.244	13,0 0.512	77,72 3.060	7,3 0.287	6.00X4.90	3	DIN374	6HX	C
MTH-M8X1.00ISO6HX-BC-P011	03000044	MF8X1.0	1,0	–	6,0 0.236	67,0 2.638	13,0 0.512	87,2 3.433	7,1 0.280	6.00X4.90	3	DIN374	6HX	C
MTH-M10X0.75ISO6HX-BC-P011	03000045	MF10X0.75	0,75	–	7,0 0.276	67,0 2.638	13,0 0.512	87,73 3.454	9,3 0.366	7.00X5.50	3	DIN374	6HX	C
MTH-M10X1.00ISO6HX-BC-P011	03000046	MF10X1.0	1,0	–	7,0 0.276	67,0 2.638	13,0 0.512	87,25 3.435	9,1 0.358	7.00X5.50	3	DIN374	6HX	C
MTH-M10X1.25ISO6HX-BC-P011	03000047	MF10X1.25	1,25	–	7,0 0.276	77,0 3.031	15,0 0.591	96,5625 3.802	8,8 0.346	7.00X5.50	3	DIN374	6HX	C
MTH-M12X1.00ISO6HX-BC-P011	03000048	MF12X1.0	1,0	–	9,0 0.354	73,0 2.874	15,0 0.591	97,25 3.829	11,1 0.437	9.00X7.00	3	DIN374	6HX	C
MTH-M12X1.25ISO6HX-BC-P011	03000049	MF12X1.25	1,25	–	9,0 0.354	73,0 2.874	15,0 0.591	96,5625 3.802	10,8 0.425	9.00X7.00	3	DIN374	6HX	C
MTH-M12X1.50ISO6HX-BC-P011	03000050	MF12X1.5	1,5	–	9,0 0.354	73,0 2.874	15,0 0.591	96,07 3.782	10,6 0.417	9.00X7.00	3	DIN374	6HX	C
MTH-M14X1.00ISO6HX-BC-P011	03000051	MF14X1.0	1,0	–	11,0 0.433	71,0 2.795	15,0 0.591	97,11 3.823	13,1 0.516	11.00X9.00	3	DIN374	6HX	C
MTH-M14X1.25ISO6HX-BC-P011	03000052	MF14X1.25	1,25	–	11,0 0.433	71,0 2.795	15,0 0.591	96,5625 3.802	12,8 0.504	11.00X9.00	3	DIN374	6HX	C
MTH-M14X1.50ISO6HX-BC-P011	03000053	MF14X1.5	1,5	–	11,0 0.433	71,0 2.795	15,0 0.591	95,875 3.775	12,6 0.496	11.00X9.00	3	DIN374	6HX	C
MTH-M16X1.00ISO6HX-BC-P011	03000054	MF16X1.0	1,0	–	12,0 0.472	58,0 2.283	15,0 0.591	97,25 3.829	15,1 0.594	12.00X9.00	4	DIN374	6HX	C
MTH-M16X1.50ISO6HX-BC-P011	03000055	MF16X1.5	1,5	–	12,0 0.472	58,0 2.283	15,0 0.591	95,875 3.775	14,6 0.575	12.00X9.00	4	DIN374	6HX	C
MTH-M18X1.00ISO6HX-BC-P011	03000056	MF18X1.0	1,0	–	14,0 0.551	66,0 2.598	17,0 0.669	105,875 4.168	17,1 0.673	14.00X11.00	4	DIN374	6HX	C
MTH-M18X1.50ISO6HX-BC-P011	03000057	MF18X1.5	1,5	–	14,0 0.551	66,0 2.598	17,0 0.669	105,71 4.162	16,6 0.654	14.00X11.00	4	DIN374	6HX	C
MTH-M20X1.00ISO6HX-BC-P011	03000058	MF20X1.0	1,0	–	16,0 0.630	80,0 3.150	17,0 0.669	122,25 4.813	19,1 0.752	16.00X12.00	4	DIN374	6HX	C
MTH-M20X1.50ISO6HX-BC-P011	03000059	MF20X1.5	1,5	–	16,0 0.630	80,0 3.150	17,0 0.669	120,875 4.759	18,6 0.732	16.00X12.00	4	DIN374	6HX	C
MTH-M22X1.50ISO6HX-BC-P011	03000060	MF22X1.5	1,5	–	18,0 0.709	78,0 3.071	17,0 0.669	120,875 4.759	20,5 0.807	18.00X14.50	4	DIN374	6HX	C
MTH-M24X1.50ISO6HX-BC-P011	03000061	MF24X1.5	1,5	–	18,0 0.709	93,0 3.661	20,0 0.787	135,875 5.349	22,5 0.886	18.00X14.50	4	DIN374	6HX	C

Thread turning

MDT

Mini-Shaft™

Thread milling

Thread tapping

Annex

Designation	Item number	TDZ	Pitch		DMM	LU	THLGTH	LF	PHDR	CZC	NOF	BSG	TCTR	THCHT
			mm	TPI										
MTH-M24X2.00ISO6HX-BC-P011	03000062	MF24X2.0	2,0	–	18,0 0.709	93,0 3.661	20,0 0.787	134,7 5.303	22,0 0.866	18.00X14.50	4	DIN374	6HX	C
MTH-M25X1.50ISO6HX-BC-P011	03000063	MF25X1.5	1,5	–	18,0 0.709	93,0 3.661	20,0 0.787	135,7 5.343	23,5 0.925	18.00X14.50	4	DIN374	6HX	C
MTH-M26X1.50ISO6HX-BC-P011	03000064	MF26X1.5	1,5	–	18,0 0.709	93,0 3.661	20,0 0.787	135,7 5.343	24,5 0.965	18.00X14.50	4	DIN374	6HX	C
MTH-M27X1.50ISO6HX-BC-P011	03000065	MF27X1.5	1,5	–	20,0 0.787	77,0 3.031	20,0 0.787	135,875 5.349	25,5 1.004	20.00X16.00	4	DIN374	6HX	C
MTH-M27X2.00ISO6HX-BC-P011	03000066	MF27X2.0	2,0	–	20,0 0.787	77,0 3.031	20,0 0.787	134,73 5.304	25,0 0.984	20.00X16.00	4	DIN374	6HX	C
MTH-M28X1.50ISO6HX-BC-P011	03000067	MF28X1.5	1,5	–	20,0 0.787	77,0 3.031	20,0 0.787	135,72 5.343	26,5 1.043	20.00X16.00	4	DIN374	6HX	C
MTH-M30X1.50ISO6HX-BC-P011	03000068	MF30X1.5	1,5	–	22,0 0.866	85,0 3.346	20,0 0.787	150,0 5.906	28,5 1.122	22.00X18.00	4	DIN374	6HX	C
MTH-M30X2.00ISO6HX-BC-P011	03000069	MF30X2.0	2,0	–	22,0 0.866	85,0 3.346	20,0 0.787	144,73 5.698	28,0 1.102	22.00X18.00	4	DIN374	6HX	C

Thread turning

MDT

Mini-Shaft™

Thread milling

Thread tapping

Annex

MTH-M003

Blind holes – Metric coarse threads

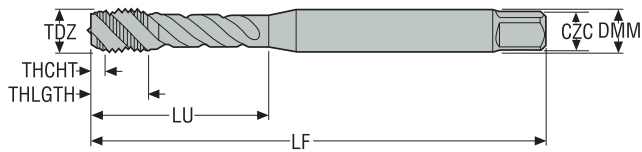

- Substrate: HSS-E
- Coating: TiCN
- For cutting data see page(s) 271

Designation	Item number	TDZ	Pitch		DMM	LU	THLGTH	LF	PHDR	CXC	NOF	BSG	TCTR	THCHT
			mm	TPI										
MTH-M1.6X0.35ISO6H-BC-M003	03000106	M1.6	0,35	–	2,5 0.098	6,0 0.236	4,0 0.157	39,21 1.544	1,3 0.051	2.50X2.10	2	DIN371	6H	C
MTH-M2X0.40ISO6H-BC-M003	03000107	M2	0,4	–	2,8 0.110	9,0 0.354	4,0 0.157	44,2 1.740	1,6 0.063	2.80X2.10	3	DIN371	6H	C
MTH-M2.2X0.45ISO6H-BC-M003	03000108	M2.2	0,45	–	2,8 0.110	12,0 0.472	4,0 0.157	44,41 1.748	1,8 0.071	2.80X2.10	3	DIN371	6H	C
MTH-M2.3X0.40ISO6H-BC-M003	03000109	M2.3	0,4	–	2,8 0.110	12,0 0.472	4,0 0.157	44,4 1.748	1,9 0.075	2.80X2.10	3	DIN371	6H	C
MTH-M2.5X0.45ISO6H-BC-M003	03000110	M2.5	0,45	–	2,8 0.110	12,5 0.492	4,0 0.157	49,32 1.942	2,1 0.083	2.80X2.10	3	DIN371	6H	C
MTH-M2.6X0.45ISO6H-BC-M003	03000111	M2.6	0,45	–	2,8 0.110	12,5 0.492	4,0 0.157	49,32 1.942	2,15 0.085	2.80X2.10	3	DIN371	6H	C
MTH-M3X0.50ISO6H-BC-M003	03000112	M3	0,5	–	3,5 0.138	18,0 0.709	5,9 0.232	54,625 2.151	2,5 0.098	3.50X2.70	3	DIN371	6H	C
MTH-M3.5X0.60ISO6H-BC-M003	03000113	M3.5	0,6	–	4,0 0.157	20,0 0.787	7,0 0.276	54,35 2.140	2,9 0.114	4.00X3.00	3	DIN371	6H	C
MTH-M4X0.70ISO6H-BC-M003	03000114	M4	0,7	–	4,5 0.177	21,0 0.827	6,7 0.264	61,075 2.405	3,4 0.134	4.50X3.40	3	DIN371	6H	C
MTH-M5X0.80ISO6H-BC-M003	03000115	M5	0,8	–	6,0 0.236	25,0 0.984	7,7 0.303	67,8 2.669	4,3 0.169	6.00X4.90	3	DIN371	6H	C
MTH-M6X1.00ISO6H-BC-M003	03000116	M6	1,0	–	6,0 0.236	30,0 1.181	10,0 0.394	77,25 3.041	5,1 0.201	6.00X4.90	3	DIN371	6H	C
MTH-M7X1.00ISO6H-BC-M003	03000117	M7	1,0	–	7,0 0.276	30,0 1.181	10,0 0.394	77,25 3.041	6,1 0.240	7.00X5.50	3	DIN371	6H	C
MTH-M8X1.25ISO6H-BC-M003	03000118	M8	1,25	–	8,0 0.315	35,0 1.378	11,6 0.457	86,5625 3.408	6,8 0.268	8.00X6.20	3	DIN371	6H	C
MTH-M10X1.50ISO6H-BC-M003	03000119	M10	1,5	–	10,0 0.394	39,0 1.535	15,1 0.594	95,875 3.775	8,6 0.339	10.00X8.00	3	DIN371	6H	C

Thread turning

MDT

Mini-Shaft™

Thread milling

Thread tapping

Annex

MTH-M003-A

Blind holes – Metric coarse threads

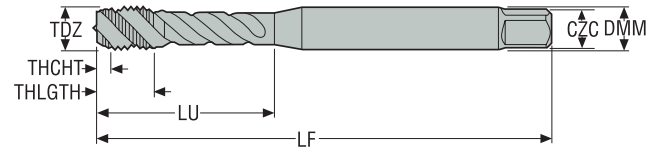

- Internal coolant
- Substrate: HSS-E
- Coating: TiCN
- For cutting data see page(s) 271

Designation	Item number	TDZ	Pitch	DMM	LU	THLGTH	LF	PHDR	CXC	NOF	BSG	TCTR	THCHT
			mm TPI	mm Inch	mm Inch	mm Inch	mm Inch	mm Inch					
MTH-M4X0.70ISO6H-BC-M003-A	03000125	M4	0,7 –	4,5 0.177	21,0 0.827	6,7 0.264	61,075 2.405	3,4 0.134	4.50X3.40	3	DIN371	6H	C
MTH-M5X0.80ISO6H-BC-M003-A	03000126	M5	0,8 –	6,0 0.236	25,0 0.984	7,7 0.303	67,8 2.669	4,3 0.169	6.00X4.90	3	DIN371	6H	C
MTH-M6X1.00ISO6H-BC-M003-A	03000127	M6	1,0 –	6,0 0.236	30,0 1.181	10,0 0.394	77,25 3.041	5,1 0.201	6.00X4.90	3	DIN371	6H	C
MTH-M7X1.00ISO6H-BC-M003-A	03000128	M7	1,0 –	7,0 0.276	30,0 1.181	10,0 0.394	77,57 3.054	6,1 0.240	7.00X5.50	3	DIN371	6H	C
MTH-M8X1.25ISO6H-BC-M003-A	03000129	M8	1,25 –	8,0 0.315	35,0 1.378	11,6 0.457	86,5625 3.408	6,8 0.268	8.00X6.20	3	DIN371	6H	C
MTH-M10X1.50ISO6H-BC-M003-A	03000130	M10	1,5 –	10,0 0.394	39,0 1.535	15,1 0.594	95,875 3.775	8,6 0.339	10.00X8.00	3	DIN371	6H	C

Thread turning

MDT

Mini-Shaft™

Thread milling

Thread tapping

Annex

MTH-M004

Blind holes – Metric coarse threads

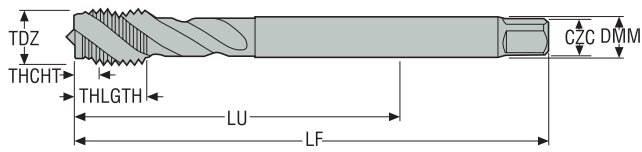

- Substrate: HSS-E
- Coating: TiCN
- For cutting data see page(s) 271

Designation	Item number	TDZ	Pitch	DMM	LU	THLGTH	LF	PHDR	CZC	NOF	BSG	TCTR	THCHT
			mm TPI	mm Inch	mm Inch	mm Inch	mm Inch	mm Inch					
MTH-M12X1.75ISO6H-BC-M004	03000120	M12	1,75 –	9,0 0.354	83,0 3.268	23,0 0.906	105,1875 4.141	10,4 0.409	9.00X7.00	3	DIN376	6H	C
MTH-M14X2.00ISO6H-BC-M004	03000121	M14	2,0 –	11,0 0.433	81,0 3.189	25,0 0.984	104,5 4.114	12,1 0.476	11.00X9.00	3	DIN376	6H	C
MTH-M16X2.00ISO6H-BC-M004	03000122	M16	2,0 –	12,0 0.472	68,0 2.677	20,0 0.787	104,5 4.114	14,1 0.555	12.00X9.00	4	DIN376	6H	C
MTH-M18X2.50ISO6H-BC-M004	03000123	M18	2,5 –	14,0 0.551	81,0 3.189	25,0 0.984	118,125 4.651	15,7 0.618	14.00X11.00	4	DIN376	6H	C
MTH-M20X2.50ISO6H-BC-M004	03000124	M20	2,5 –	16,0 0.630	95,0 3.740	25,0 0.984	133,125 5.241	17,7 0.697	16.00X12.00	4	DIN376	6H	C

MTH-M004-A

Blind holes – Metric coarse threads

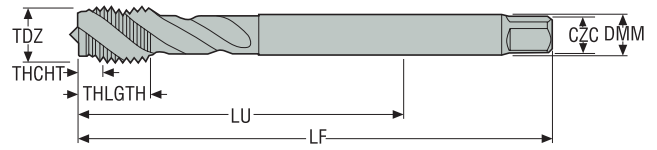

- Internal coolant
- Substrate: HSS-E
- Coating: TiCN
- For cutting data see page(s) 271

Designation	Item number	TDZ	Pitch	DMM	LU	THLGTH	LF	PHDR	CXC	NOF	BSG	TCTR	THCHT
			mm TPI	mm Inch	mm Inch	mm Inch	mm Inch	mm Inch					
MTH-M12X1.75ISO6H-BC-M004-A	03000131	M12	1,75 –	9,0 0.354	83,0 3.268	23,0 0.906	105,1875 4.141	10,4 0.409	9.00X7.00	3	DIN376	6H	C
MTH-M14X2.00ISO6H-BC-M004-A	03000132	M14	2,0 –	11,0 0.433	81,0 3.189	25,0 0.984	105,63 4.159	12,1 0.476	11.00X9.00	3	DIN376	6H	C
MTH-M16X2.00ISO6H-BC-M004-A	03000133	M16	2,0 –	12,0 0.472	68,0 2.677	20,0 0.787	104,5 4.114	14,1 0.555	12.00X9.00	4	DIN376	6H	C
MTH-M18X2.50ISO6H-BC-M004-A	03000134	M18	2,5 –	14,0 0.551	81,0 3.189	25,0 0.984	119,42 4.702	15,7 0.618	14.00X11.00	4	DIN376	6H	C
MTH-M20X2.50ISO6H-BC-M004-A	03000135	M20	2,5 –	16,0 0.630	95,0 3.740	25,0 0.984	134,43 5.293	17,7 0.697	16.00X12.00	4	DIN376	6H	C

Thread turning

MDT

Mini-Shaft™

Thread milling

Thread tapping

Annex

MTH-N001

Blind holes – Metric coarse threads

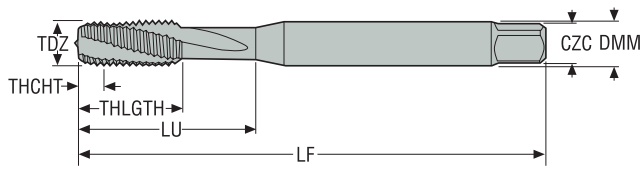

- Substrate: HSS-E-PM
- Coating: BRIGHT
- For cutting data see page(s) 273

Designation	Item number	TDZ	Pitch		DMM	LU	THLGTH	LF	PHDR	CZC	NOF	BSG	TCTR	THCHT
			mm	TPI										
MTH-M3X0.50ISO6H-BC-N001	03000153	M3	0,5	–	3,5 0.138	18,0 0.709	9,0 0.354	54,625 2.151	2,5 0.098	3.50X2.70	3	DIN371	6H	C
MTH-M4X0.70ISO6H-BC-N001	03000154	M4	0,7	–	4,5 0.177	21,0 0.827	12,0 0.472	61,075 2.405	3,4 0.134	4.50X3.40	3	DIN371	6H	C
MTH-M5X0.80ISO6H-BC-N001	03000155	M5	0,8	–	6,0 0.236	25,0 0.984	13,0 0.512	68,2 2.685	4,3 0.169	6.00X4.90	3	DIN371	6H	C
MTH-M6X1.00ISO6H-BC-N001	03000156	M6	1,0	–	6,0 0.236	30,0 1.181	15,0 0.591	77,25 3.041	5,1 0.201	6.00X4.90	3	DIN371	6H	C
MTH-M8X1.25ISO6H-BC-N001	03000157	M8	1,25	–	8,0 0.315	35,0 1.378	18,0 0.709	87,0 3.425	6,8 0.268	8.00X6.20	3	DIN371	6H	C
MTH-M10X1.50ISO6H-BC-N001	03000158	M10	1,5	–	10,0 0.394	39,0 1.535	20,0 0.787	96,3 3.791	8,6 0.339	10.00X8.00	3	DIN371	6H	C

MTH-N002

Blind holes – Metric coarse threads

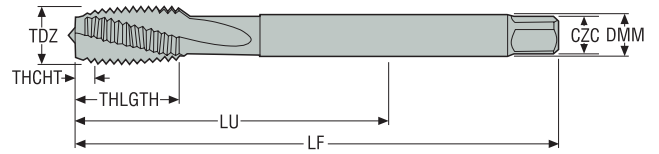

- Substrate: HSS-E-PM
- Coating: BRIGHT
- For cutting data see page(s) 273

Designation	Item number	TDZ	Pitch	DMM	LU	THLGTH	LF	PHDR	CZC	NOF	BSG	TCTR	THCHT
			mm TPI	mm <i>Inch</i>	mm <i>Inch</i>	mm <i>Inch</i>	mm <i>Inch</i>	mm <i>Inch</i>					
MTH-M12X1.75ISO6H-BC-N002	03000159	M12	1,75 –	9,0 <i>0.354</i>	83,0 <i>3.268</i>	23,0 <i>0.906</i>	105,25 <i>4.144</i>	10,4 <i>0.409</i>	9.00X7.00	3	DIN376	6H	C
MTH-M14X2.00ISO6H-BC-N002	03000160	M14	2,0 –	11,0 <i>0.433</i>	81,0 <i>3.189</i>	25,0 <i>0.984</i>	104,6 <i>4.118</i>	12,1 <i>0.476</i>	11.00X9.00	3	DIN376	6H	C
MTH-M16X2.00ISO6H-BC-N002	03000161	M16	2,0 –	12,0 <i>0.472</i>	68,0 <i>2.677</i>	25,0 <i>0.984</i>	104,5 <i>4.114</i>	14,1 <i>0.555</i>	12.00X9.00	3	DIN376	6H	C

Thread turning

MDT

Mini-Shaft™

Thread milling

Thread tapping

Annex

MTH-S001

Blind holes – Metric coarse threads

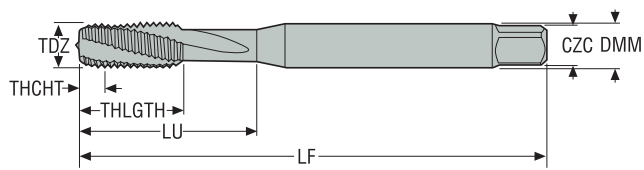

- Substrate: HSS-E-PM
- For cutting data see page(s) 275

Designation	Item number	TDZ	Pitch		DMM	LU	THLGTH	LF	PHDR	CZC	NOF	BSG	TCTR	THCHT
			mm	TPI										
MTH-M3X0.50ISO6HX-BC-S001	10001105	M3	0,5	–	3,5 0.138	8,0 0.315	8,0 0.315	54,75 2.156	2,5 0.098	3.50X2.70	3	DIN371	6HX	C
MTH-M4X0.70ISO6HX-BC-S001	10001106	M4	0,7	–	4,5 0.177	10,5 0.413	10,5 0.413	61,25 2.411	3,4 0.134	4.50X3.40	3	DIN371	6HX	C
MTH-M5X0.80ISO6HX-BC-S001	10001107	M5	0,8	–	6,0 0.236	13,0 0.512	13,0 0.512	68,0 2.677	4,3 0.169	6.00X4.90	3	DIN371	6HX	C
MTH-M6X1.00ISO6HX-BC-S001	10001108	M6	1,0	–	6,0 0.236	16,0 0.630	16,0 0.630	77,5 3.051	5,1 0.201	6.00X4.90	3	DIN371	6HX	C
MTH-M8X1.25ISO6HX-BC-S001	10001109	M8	1,25	–	8,0 0.315	20,5 0.807	20,5 0.807	86,87 3.420	6,8 0.268	8.00X6.20	3	DIN371	6HX	C
MTH-M10X1.50ISO6HX-BC-S001	10001110	M10	1,5	–	10,0 0.394	25,5 1.004	25,5 1.004	96,25 3.789	8,6 0.339	10.00X8.00	3	DIN371	6HX	C

MTH-S002

Blind holes – Metric coarse threads

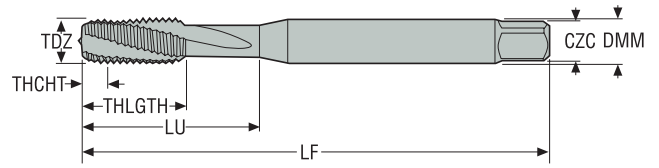

- Substrate: HSS-E-PM
- For cutting data see page(s) 275

Designation	Item number	TDZ	Pitch		DMM	LU	THLGTH	LF	PHDR	CZC	NOF	BSG	TCTR	THCHT
			mm	TPI	mm <i>Inch</i>	mm <i>Inch</i>	mm <i>Inch</i>	mm <i>Inch</i>	mm <i>Inch</i>					
MTH-M12X1.75ISO6HX-BC-S002	10001111	M12	1,75	–	12,0 <i>0.472</i>	30,5 <i>1.201</i>	30,5 <i>1.201</i>	105,09 <i>4.137</i>	10,4 <i>0.409</i>	12.00X9.00	4	DIN371	6HX	C
MTH-M16X2.00ISO6HX-BC-S002	10001112	M16	2,0	–	16,0 <i>0.630</i>	39,5 <i>1.555</i>	39,5 <i>1.555</i>	104,4 <i>4.110</i>	14,1 <i>0.555</i>	16.00X12.00	4	DIN371	6HX	C

Thread turning

MDT

Mini-Shaft™

Thread milling

Thread tapping

Annex

MTH-S003

Blind holes – Metric coarse threads

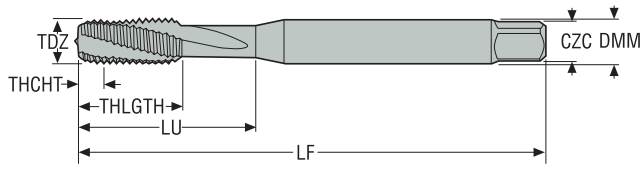

- Substrate: HSS-E-PM
- Coating: TiN
- For cutting data see page(s) 275

Designation	Item number	TDZ	Pitch		DMM	LU	THLGTH	LF	PHDR	CZC	NOF	BSG	TCTR	THCHT
			mm	TPI										
MTH-M3X0.50ISO6HX-BC-S003	10001073	M3	0,5	–	3,5 0.138	8,0 0.315	8,0 0.315	54,75 2.156	2,5 0.098	3.50X2.70	3	DIN371	6HX	C
MTH-M4X0.70ISO6HX-BC-S003	10001074	M4	0,7	–	4,5 0.177	10,5 0.413	10,5 0.413	61,25 2.411	3,4 0.134	4.50X3.40	3	DIN371	6HX	C
MTH-M5X0.80ISO6HX-BC-S003	10001075	M5	0,8	–	6,0 0.236	13,0 0.512	13,0 0.512	68,0 2.677	4,3 0.169	6.00X4.90	3	DIN371	6HX	C
MTH-M6X1.00ISO6HX-BC-S003	10001076	M6	1,0	–	6,0 0.236	16,0 0.630	16,0 0.630	77,5 3.051	5,1 0.201	6.00X4.90	3	DIN371	6HX	C
MTH-M8X1.25ISO6HX-BC-S003	10001077	M8	1,25	–	8,0 0.315	20,5 0.807	20,5 0.807	86,87 3.420	6,8 0.268	8.00X6.20	3	DIN371	6HX	C
MTH-M10X1.50ISO6HX-BC-S003	10001078	M10	1,5	–	10,0 0.394	25,5 1.004	25,5 1.004	96,25 3.789	8,6 0.339	10.00X8.00	3	DIN371	6HX	C

MTH-S004

Blind holes – Metric coarse threads

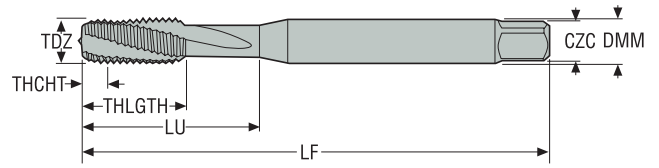

- Substrate: HSS-E-PM
- Coating: TiN
- For cutting data see page(s) 275

Designation	Item number	TDZ	Pitch	DMM	LU	THLGTH	LF	PHDR	CZC	NOF	BSG	TCTR	THCHT
			mm TPI	mm <i>Inch</i>	mm <i>Inch</i>	mm <i>Inch</i>	mm <i>Inch</i>	mm <i>Inch</i>					
MTH-M12X1.75ISO6HX-BC-S004	10001079	M12	1,75 –	12,0 <i>0.472</i>	30,5 <i>1.201</i>	30,5 <i>1.201</i>	105,09 <i>4.137</i>	10,4 <i>0.409</i>	12.00X9.00	4	DIN371	6HX	C
MTH-M16X2.00ISO6HX-BC-S004	10001080	M16	2,0 –	16,0 <i>0.630</i>	39,5 <i>1.555</i>	39,5 <i>1.555</i>	104,4 <i>4.110</i>	14,1 <i>0.555</i>	16.00X12.00	4	DIN371	6HX	C

Thread turning

MDT

Mini-Shaft™

Thread milling

Thread tapping

Annex

MTH-S011

Blind holes – MF threads

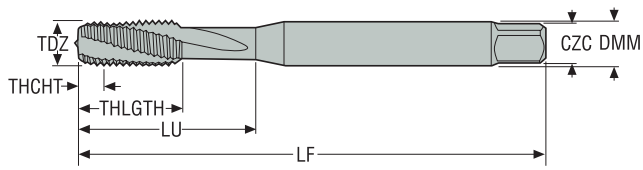

- Substrate: HSS-E-PM
- For cutting data see page(s) 275

Designation	Item number	TDZ	Pitch		DMM	LU	THLGTH	LF	PHDR	CZC	NOF	BSG	TCTR	THCHT
			mm	TPI										
MTH-M8X1.00ISO6HX-BC-S011	10001082	MF8X1.0	1,0	–	8,0 0.315	20,0 0.787	20,0 0.787	87,5 3.445	7,0 0.276	8.00X6.20	3	DIN371	6HX	C
MTH-M10X1.00ISO6HX-BC-S011	10001083	MF10X1.0	1,0	–	10,0 0.394	24,0 0.945	24,0 0.945	87,5 3.445	9,0 0.354	10.00X8.00	3	DIN371	6HX	C
MTH-M10X1.25ISO6HX-BC-S011	10001084	MF10X1.25	1,25	–	10,0 0.394	24,5 0.965	24,5 0.965	96,87 3.814	8,75 0.344	10.00X8.00	3	DIN371	6HX	C
MTH-M12X1.25ISO6HX-BC-S011	10001085	MF12X1.25	1,25	–	12,0 0.472	28,5 1.122	28,5 1.122	96,49 3.799	10,75 0.423	12.00X9.00	4	DIN371	6HX	C
MTH-M12X1.50ISO6HX-BC-S011	10001086	MF12X1.5	1,5	–	12,0 0.472	29,5 1.161	29,5 1.161	95,8 3.772	10,5 0.413	12.00X9.00	4	DIN371	6HX	C

Thread turning

MDT

Mini-Shaft™

Thread milling

Thread tapping

Annex

MTH-S012

Blind holes – MJ threads

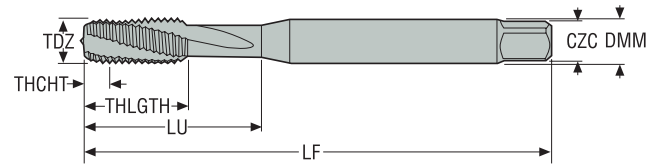

- Substrate: HSS-E-PM
- For cutting data see page(s) 275

Designation	Item number	TDZ	Pitch		DMM	LU	THLGTH	LF	PHDR	CZC	NOF	BSG	TCTR	THCHT
			mm	TPI										
MTH-MJ3X0.50ISO4H-BC-S012	10001069	MJ3X0.5	0,5	–	3,5 <i>0.138</i>	8,0 <i>0.315</i>	8,0 <i>0.315</i>	54,75 <i>2.156</i>	2,6 <i>0.102</i>	3.50X2.70	3	DIN371	4H	C
MTH-MJ4X0.70ISO4H-BC-S012	10001070	MJ4X0.7	0,7	–	4,5 <i>0.177</i>	10,5 <i>0.413</i>	10,5 <i>0.413</i>	61,25 <i>2.411</i>	3,4 <i>0.134</i>	4.50X3.40	3	DIN371	4H	C
MTH-MJ5X0.80ISO4H-BC-S012	10001071	MJ5X0.8	0,8	–	6,0 <i>0.236</i>	13,0 <i>0.512</i>	13,0 <i>0.512</i>	68,0 <i>2.677</i>	4,3 <i>0.169</i>	6.00X4.90	3	DIN371	4H	C
MTH-MJ6X1.00ISO4H-BC-S012	10001072	MJ6X1	1,0	–	6,0 <i>0.236</i>	15,5 <i>0.610</i>	15,5 <i>0.610</i>	77,5 <i>3.051</i>	5,1 <i>0.201</i>	6.00X4.90	3	DIN371	4H	C

Thread turning

MDT

Mini-Shaft™

Thread milling

Thread tapping

Annex

MTH-S031

Blind holes – UNC threads

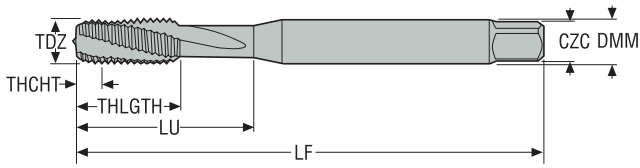

- Substrate: HSS-E-PM
- For cutting data see page(s) 275

Designation	Item number	TDZ	Pitch		DMM	LU	THLGTH	LF	PHDR	CZC	NOF	BSG	TCTR	THCHT
			mm	TPI										
MTH-2-56UNC2B-BC-S031	10001113	UNC2-56	–	56.0	2,8 0.110	9,0 0.354	9,0 0.354	43,87 1.727	1,85 0.073	2.80X2.10	3	DIN2184-1	2B	C
MTH-3-48UNC2B-BC-S031	10001114	UNC3-48	–	48.0	2,8 0.110	9,0 0.354	9,0 0.354	48,68 1.917	2,1 0.083	2.80X2.10	3	DIN2184-1	2B	C
MTH-4-40UNC2B-BC-S031	10001115	UNC4-40	–	40.0	3,5 0.138	10,0 0.394	10,0 0.394	54,41 2.142	2,35 0.093	3.50X2.70	3	DIN2184-1	2B	C
MTH-6-32UNC2B-BC-S031	10001116	UNC6-32	–	32.0	4,0 0.157	12,0 0.472	12,0 0.472	54,02 2.127	2,85 0.112	4.00X3.00	3	DIN2184-1	2B	C
MTH-8-32UNC2B-BC-S031	10001117	UNC8-32	–	32.0	4,5 0.177	13,0 0.512	13,0 0.512	61,02 2.402	3,5 0.138	4.50X3.40	3	DIN2184-1	2B	C
MTH-10-24UNC2B-BC-S031	10001119	UNC10-24	–	24.0	6,0 0.236	16,0 0.630	16,0 0.630	67,35 2.652	3,9 0.154	6.00X4.90	3	DIN2184-1	2B	C
MTH-1/4-20UNC2B-BC-S031	10001120	UNC1/4-20	–	20.0	7,0 0.276	15,0 0.591	15,0 0.591	76,44 3.009	5,1 0.201	7.00X5.50	3	DIN2184-1	2B	C
MTH-5/16-18UNC2B-BC-S031	10001122	UNC5/16-18	–	18.0	8,0 0.315	18,0 0.709	18,0 0.709	86,05 3.388	6,6 0.260	8.00X6.20	3	DIN2184-1	2B	C
MTH-3/8-16UNC2B-BC-S031	10001121	UNC3/8-16	–	16.0	10,0 0.394	20,0 0.787	20,0 0.787	95,55 3.762	8,0 0.315	10.00X8.00	4	DIN2184-1	2B	C

MTH-S032

Blind holes – UNJC threads

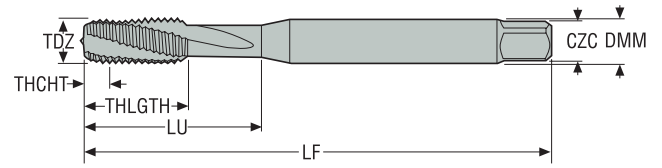

- Substrate: HSS-E-PM
- For cutting data see page(s) 275

Designation	Item number	TDZ	Pitch		DMM	LU	THLGTH	LF	PHDR	CZC	NOF	BSG	TCTR	THCHT
			mm	TPI										
MTH-4-40UNJC3B-BC-S032	10001087	UNJC4-40	–	40.0	3,5 <i>0.138</i>	8,0 <i>0.315</i>	8,0 <i>0.315</i>	54,41 <i>2.142</i>	2,3 <i>0.091</i>	3.50X2.70	3	DIN2184-1	3B	C
MTH-6-32UNJC3B-BC-S032	10001088	UNJC6-32	–	32.0	4,0 <i>0.157</i>	10,0 <i>0.394</i>	10,0 <i>0.394</i>	54,02 <i>2.127</i>	2,8 <i>0.110</i>	4.00X3.00	3	DIN2184-1	3B	C
MTH-8-32UNJC3B-BC-S032	10001089	UNJC8-32	–	32.0	4,5 <i>0.177</i>	11,0 <i>0.433</i>	11,0 <i>0.433</i>	61,02 <i>2.402</i>	3,5 <i>0.138</i>	4.50X3.40	3	DIN2184-1	3B	C
MTH-10-24UNJC3B-BC-S032	10001090	UNJC10-24	–	24.0	6,0 <i>0.236</i>	13,5 <i>0.531</i>	13,5 <i>0.531</i>	67,35 <i>2.652</i>	3,9 <i>0.154</i>	6.00X4.90	3	DIN2184-1	3B	C
MTH-1/4-20UNJC3B-BC-S032	10001091	UNJC1/4-20	–	20.0	7,0 <i>0.276</i>	17,5 <i>0.689</i>	17,5 <i>0.689</i>	76,82 <i>3.024</i>	5,2 <i>0.205</i>	7.00X5.50	3	DIN2184-1	3B	C
MTH-5/16-18UNJC3B-BC-S032	10001093	UNJC5/16-18	–	18.0	8,0 <i>0.315</i>	21,0 <i>0.827</i>	21,0 <i>0.827</i>	86,47 <i>3.404</i>	6,7 <i>0.264</i>	8.00X6.20	3	DIN2184-1	3B	C
MTH-3/8-16UNJC3B-BC-S032	10001092	UNJC3/8-16	–	16.0	10,0 <i>0.394</i>	25,0 <i>0.984</i>	25,0 <i>0.984</i>	96,03 <i>3.781</i>	8,1 <i>0.319</i>	10.00X8.00	3	DIN2184-1	3B	C

Thread turning

MDT

Mini-Shaft™

Thread milling

Thread tapping

Annex

MTH-S041

Blind holes – UNF threads

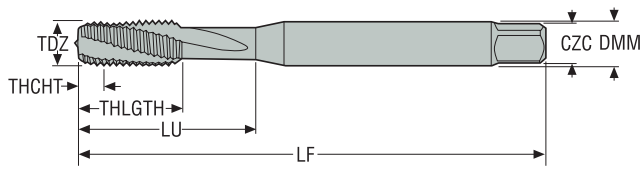

- Substrate: HSS-E-PM
- For cutting data see page(s) 277

Designation	Item number	TDZ	Pitch		DMM	LU	THLGTH	LF	PHDR	CZC	NOF	BSG	TCTR	THCHT
			mm	TPI										
MTH-6-40UNF3B-BC-S041	10001123	UNF6-40	–	40.0	4,0 0.157	12,0 0.472	12,0 0.472	54,41 2.142	2,95 0.116	4.00X3.00	3	DIN2184-1	3B	C
MTH-8-36UNF3B-BC-S041	10001126	UNF8-36	–	36.0	4,5 0.177	13,0 0.512	13,0 0.512	61,24 2.411	3,5 0.138	4.50X3.40	3	DIN2184-1	3B	C
MTH-10-32UNF3B-BC-S041	10001127	UNF10-32	–	32.0	6,0 0.236	16,0 0.630	16,0 0.630	68,02 2.678	4,1 0.161	6.00X4.90	3	DIN2184-1	3B	C
MTH-12-28UNF3B-BC-S041	10001129	UNF12-28	–	28.0	6,0 0.236	15,0 0.591	15,0 0.591	77,46 3.050	4,6 0.181	6.00X4.90	3	DIN2184-1	3B	C
MTH-1/4-28UNF3B-BC-S041	10001130	UNF1/4-28	–	28.0	7,0 0.276	25,0 0.984	15,0 0.591	77,46 3.050	5,5 0.217	7.00X5.50	3	DIN2184-1	3B	C
MTH-5/16-24UNF3B-BC-S041	10001133	UNF5/16-24	–	24.0	8,0 0.315	29,5 1.161	18,0 0.709	87,03 3.426	6,9 0.272	8.00X6.20	3	DIN2184-1	3B	C
MTH-3/8-24UNF3B-BC-S041	10001131	UNF3/8-24	–	24.0	10,0 0.394	33,5 1.319	20,0 0.787	97,03 3.820	8,5 0.335	10.00X8.00	4	DIN2184-1	3B	C

Thread turning

MDT

Mini-Shaft™

Thread milling

Thread tapping

Annex

MTH-S042

Blind holes – UNJF threads

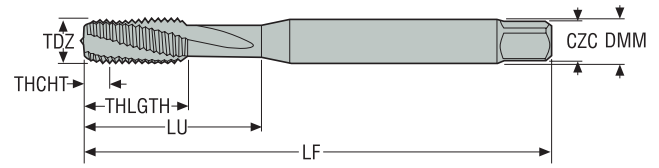

- Substrate: HSS-E-PM
- For cutting data see page(s) 277

Designation	Item number	TDZ	Pitch		DMM	LU	THLGTH	LF	PHDR	CZC	NOF	BSG	TCTR	THCHT
			mm	TPI										
MTH-6-40UNJF3B-BC-S042	10001094	UNJF6-40	–	40.0	4,0 0.157	9,5 0.374	9,5 0.374	54,41 2.142	2,95 0.116	4.00X3.00	3	DIN2184-1	3B	C
MTH-8-36UNJF3B-BC-S042	10001095	UNJF8-36	–	36.0	4,5 0.177	11,0 0.433	11,0 0.433	61,24 2.411	3,6 0.142	4.50X3.40	3	DIN2184-1	3B	C
MTH-10-32UNJF3B-BC-S042	10001097	UNJF10-32	–	32.0	6,0 0.236	12,5 0.492	12,5 0.492	68,02 2.678	4,15 0.163	6.00X4.90	3	DIN2184-1	3B	C
MTH-1/4-28UNJF3B-BC-S042	10001098	UNJF1/4-28	–	28.0	7,0 0.276	16,0 0.630	16,0 0.630	77,73 3.060	5,6 0.220	7.00X5.50	3	DIN2184-1	3B	C
MTH-5/16-24UNJF3B-BC-S042	10001100	UNJF5/16-24	–	24.0	8,0 0.315	20,0 0.787	20,0 0.787	87,35 3.439	7,0 0.276	8.00X6.20	3	DIN2184-1	3B	C
MTH-3/8-24UNJF3B-BC-S042	10001099	UNJF3/8-24	–	24.0	10,0 0.394	23,0 0.906	23,0 0.906	97,35 3.833	8,6 0.339	10.00X8.00	3	DIN2184-1	3B	C

Thread turning

MDT

Mini-Shaft™

Thread milling

Thread tapping

Annex

MTH-S043

Blind holes – EGUNF threads

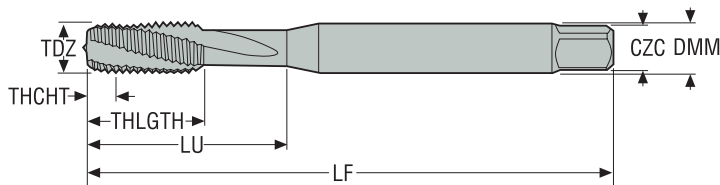

- Substrate: HSS-E-PM
- Coating: AlCrN
- For cutting data see page(s) 277

Designation	Item number	TDZ	Pitch		DMM	LU	THLGTH	LF	PHDR	CZC	NOF	BSG	TCTR	THCHT
			mm	TPI										
MTH-10-32EGUNF3B-BC-S043 MTH-10-32STIUNF3B-BC-S043	10001199	EGUN10-32	-	32.0	6,0 0.236	23 0.906	15,0 0.591	77,8 3.062	5,1 0.201	6.00X4.90	3	DIN2184-1	3B	C
MTH-1/4-28EGUNF3B-BC-S043 MTH-1/4-28STIUNF3B-BC-S043	10001200	EGUNF1/4-28	-	28.0	8,0 0.315	30 1.161	18,0 0.709	87,5 3.443	6,6 0.260	8.00X6.20	3	DIN2184-1	3B	C
MTH-5/16-24EGUNF3B-BC-S043 MTH-5/16-24STIUNF3B-BC-S043	10001201	EGUNF5/16-24	-	24.0	10,0 0.394	34 1.319	20,0 0.787	97,0 3.820	8,2 0.323	10.00X8.00	3	DIN2184-1	3B	C
MTH-3/8-24EGUNF3B-BC-S043 MTH-3/8-24STIUNF3B-BC-S043	10001202	EGUNF3/8-24	-	24.0	8,0 0.315	76 2.992	20,0 0.787	97,0 3.820	9,8 0.386	8.00X6.20	4	DIN2184-1	3B	C

Thread turning

MDT

Mini-Shaft™

Thread milling

Thread tapping

Annex

MTH-S044

Blind holes – EGUNF threads

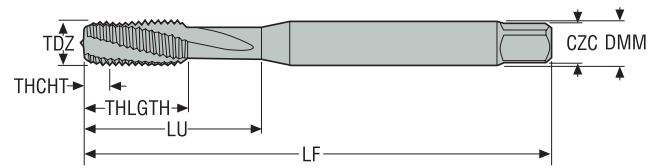

- Substrate: HSS-E-PM
- For cutting data see page(s) 277

Designation	Item number	TDZ	Pitch		DMM	LU	THLGTH	LF	PHDR	CZC	NOF	BSG	TCTR	THCHT
			mm	TPI										
MTH-10-32EGUNF3B-BC-S044 MTH-10-32STIUNF3B-BC-S044	10001101	EGUNF10-32	–	32.0	6,0 0.236	15 0.591	15,0 0.591	78,0 3.072	5,1 0.201	6.00X4.90	3	DIN2184-1	3B	C
MTH-1/4-28EGUNF3B-BC-S044 MTH-1/4-28STIUNF3B-BC-S044	10001102	EGUNF1/4-28	–	28.0	8,0 0.315	18 0.709	18,0 0.709	87,7 3.454	6,6 0.260	8.00X6.20	3	DIN2184-1	3B	C
MTH-3/8-24EGUNF3B-BC-S044 MTH-3/8-24STIUNF3B-BC-S044	10001103	EGUNF3/8-24	–	24.0	11,0 0.433	20 0.787	20,0 0.787	87,0 3.426	9,8 0.386	11.00X9.00	4	DIN2184-1	3B	C
MTH-5/16-24EGUNF3B-BC-S044 MTH-5/16-24STIUNF3B-BC-S044	10001104	EGUNF5/16-24	–	24.0	10,0 0.394	20 0.787	20,0 0.787	87,4 3.439	8,2 0.323	10.00X8.00	3	DIN2184-1	3B	C

Thread turning

MDT

Mini-Shaft™

Thread milling

Thread tapping

Annex

MTH-S101

Blind holes – Metric coarse threads

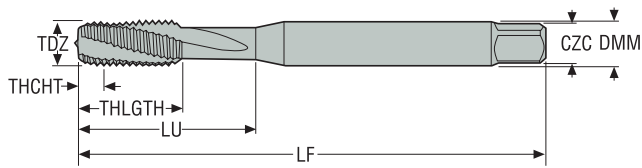

- Substrate: HSS-E-PM
- Coating: AlCrN
- For cutting data see page(s) 277

Designation	Item number	TDZ	Pitch		DMM	LU	THLGTH	LF	PHDR	CZC	NOF	BSG	TCTR	THCHT
			mm	TPI										
MTH-M2X0.40ISO6HX-BC-S101	10001134	M2	0,4	–	2,8 0.110	8,0 0.315	8,0 0.315	44,0 1.732	1,6 0.063	2.80X2.10	3	DIN371	6HX	C
MTH-M2.5X0.45ISO6HX-BC-S101	10001135	M2.5	0,45	–	2,8 0.110	9,0 0.354	9,0 0.354	48,87 1.924	2,1 0.083	2.80X2.10	3	DIN371	6HX	C
MTH-M3X0.50ISO6HX-BC-S101	10001136	M3	0,5	–	3,5 0.138	10,0 0.394	10,0 0.394	54,75 2.156	2,5 0.098	3.50X2.70	3	DIN371	6HX	C
MTH-M3.5X0.60ISO6HX-BC-S101	10001137	M3.5	0,6	–	4,0 0.157	12,0 0.472	12,0 0.472	54,5 2.146	2,9 0.114	4.00X3.00	3	DIN371	6HX	C
MTH-M4X0.70ISO6HX-BC-S101	10001138	M4	0,7	–	4,5 0.177	13,0 0.512	13,0 0.512	61,25 2.411	3,4 0.134	4.50X3.40	3	DIN371	6HX	C
MTH-M5X0.80ISO6HX-BC-S101	10001139	M5	0,8	–	6,0 0.236	16,0 0.630	16,0 0.630	68,0 2.677	4,3 0.169	6.00X4.90	3	DIN371	6HX	C
MTH-M6X1.00ISO6HX-BC-S101	10001140	M6	1,0	–	6,0 0.236	23,0 0.906	15,0 0.591	77,2 3.039	5,1 0.201	6.00X4.90	3	DIN371	6HX	C
MTH-M8X1.25ISO6HX-BC-S101	10001141	M8	1,25	–	8,0 0.315	29,5 1.161	18,0 0.709	86,49 3.405	6,8 0.268	8.00X6.20	3	DIN371	6HX	C
MTH-M10X1.50ISO6HX-BC-S101	10001142	M10	1,5	–	10,0 0.394	33,5 1.319	20,0 0.787	95,8 3.772	8,6 0.339	10.00X8.00	3	DIN371	6HX	C

Thread turning

MDT

Mini-Shaft™

Thread milling

Thread tapping

Annex

MTH-S102

Blind holes – Metric coarse threads

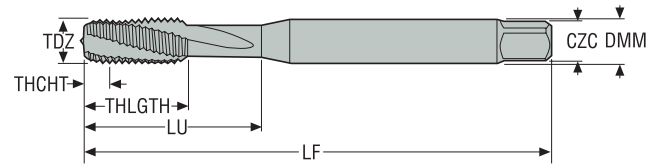

- Substrate: HSS-E-PM
- Coating: AlCrN
- For cutting data see page(s) 277

Designation	Item number	TDZ	Pitch	DMM	LU	THLGTH	LF	PHDR	CZC	NOF	BSG	TCTR	THCHT
			mm TPI	mm <i>Inch</i>	mm <i>Inch</i>	mm <i>Inch</i>	mm <i>Inch</i>	mm <i>Inch</i>					
MTH-M12X1.75ISO6HX-BC-S102	10001143	M12	1,75 –	9,0 <i>0.354</i>	83,0 <i>3.268</i>	23,0 <i>0.906</i>	105,09 <i>4.137</i>	10,4 <i>0.409</i>	9.00X7.00	4	DIN376	6HX	C
MTH-M16X2.00ISO6HX-BC-S102	10001145	M16	2,0 –	12,0 <i>0.472</i>	68,0 <i>2.677</i>	25,0 <i>0.984</i>	104,4 <i>4.110</i>	14,1 <i>0.555</i>	12.00X9.00	4	DIN376	6HX	C
MTH-M20X2.50ISO6HX-BC-S102	10001146	M20	2,5 –	16,0 <i>0.630</i>	95,0 <i>3.740</i>	30,0 <i>1.181</i>	133,0 <i>5.236</i>	17,7 <i>0.697</i>	16.00X12.00	4	DIN376	6HX	C

Thread turning

MDT

Mini-Shaft™

Thread milling

Thread tapping

Annex

MTH-S111

Blind holes – MF threads

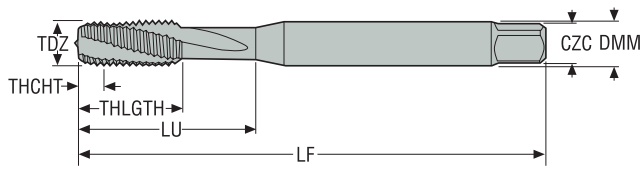

- Substrate: HSS-E-PM
- Coating: AlCrN
- For cutting data see page(s) 277

Designation	Item number	TDZ	Pitch		DMM	LU	THLGTH	LF	PHDR	CZC	NOF	BSG	TCTR	THCHT
			mm	TPI										
MTH-M6X0.75ISO6HX-BC-S111	10001147	MF6X0.75	0,75	–	6,0 <i>0.236</i>	23,0 <i>0.906</i>	15,0 <i>0.591</i>	77,89 <i>3.067</i>	5,25 <i>0.207</i>	6.00X4.90	3	DIN371	6HX	C
MTH-M8X0.75ISO6HX-BC-S111	10001148	MF8X0.75	0,75	–	8,0 <i>0.315</i>	29,5 <i>1.161</i>	18,0 <i>0.709</i>	87,89 <i>3.460</i>	7,25 <i>0.285</i>	8.00X6.20	3	DIN371	6HX	C
MTH-M8X1.00ISO6HX-BC-S111	10001149	MF8X1.0	1,0	–	8,0 <i>0.315</i>	29,5 <i>1.161</i>	18,0 <i>0.709</i>	87,2 <i>3.433</i>	7,0 <i>0.276</i>	8.00X6.20	3	DIN371	6HX	C
MTH-M10X1.00ISO6HX-BC-S111	10001150	MF10X1.0	1,0	–	10,0 <i>0.394</i>	33,5 <i>1.319</i>	20,0 <i>0.787</i>	97,2 <i>3.827</i>	9,0 <i>0.354</i>	10.00X8.00	3	DIN371	6HX	C
MTH-M12X1.50ISO6HX-BC-S111	10001151	MF12X1.5	1,5	–	9,0 <i>0.354</i>	73,0 <i>2.874</i>	21,0 <i>0.827</i>	95,8 <i>3.772</i>	10,5 <i>0.413</i>	9.00X7.00	4	DIN374	6HX	C
MTH-M14X1.50ISO6HX-BC-S111	10001152	MF14X1.5	1,5	–	11,0 <i>0.433</i>	71,0 <i>2.795</i>	21,0 <i>0.827</i>	95,8 <i>3.772</i>	12,5 <i>0.492</i>	11.00X9.00	4	DIN374	6HX	C

MTH-S112

Blind holes – MJ threads

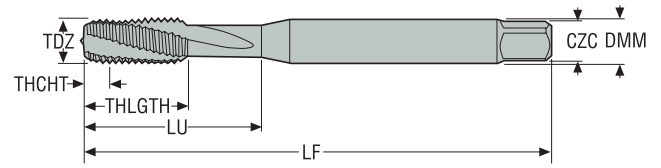

- Substrate: HSS-E-PM
- Coating: AlCrN
- For cutting data see page(s) 277

Designation	Item number	TDZ	Pitch	DMM	LU	THLGTH	LF	PHDR	CZC	NOF	BSG	TCTR	THCHT
			mm TPI	mm Inch	mm Inch	mm Inch	mm Inch	mm Inch					
MTH-MJ3X0.50ISO4H-BC-S112	10001203	MJ3X0.5	0,5 –	3,5 0.138	10,0 0.394	10,0 0.394	54,75 2.156	2,6 0.102	3.50X2.70	3	DIN371	4H	C
MTH-MJ4X0.70ISO4H-BC-S112	10001204	MJ4X0.7	0,7 –	4,5 0.177	13,0 0.512	13,0 0.512	61,25 2.411	3,4 0.134	4.50X3.40	3	DIN371	4H	C
MTH-MJ5X0.80ISO4H-BC-S112	10001205	MJ5X0.8	0,8 –	6,0 0.236	16,0 0.630	16,0 0.630	68,0 2.677	4,3 0.169	6.00X4.90	3	DIN371	4H	C
MTH-MJ6X1.00ISO4H-BC-S112	10001206	MJ6X1	1,0 –	6,0 0.236	23,0 0.906	15,0 0.591	77,2 3.039	5,1 0.201	6.00X4.90	3	DIN371	4H	C
MTH-MJ8X1.25ISO4H-BC-S112	10001207	MJ8X1.25	1,25 –	8,0 0.315	29,5 1.161	18,0 0.709	86,49 3.405	6,9 0.272	8.00X6.20	3	DIN371	4H	C
MTH-MJ10X1.5ISO4H-BC-S112	10001208	MJ10X1.5	1,5 –	10,0 0.394	33,5 1.319	20,0 0.787	95,8 3.772	8,7 0.343	10.00X8.00	3	DIN371	4H	C

Thread turning

MDT

Mini-Shaft™

Thread milling

Thread tapping

Annex

MTH-S142

Blind holes – UNJF threads

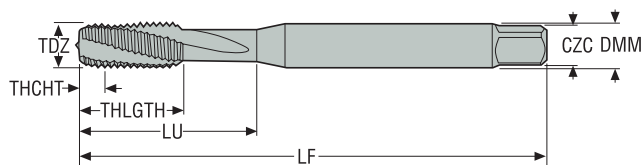

- Substrate: HSS-E-PM
- Coating: AlCrN
- For cutting data see page(s) 277

Designation	Item number	TDZ	Pitch		DMM	LU	THLGTH	LF	PHDR	CZC	NOF	BSG	TCTR	THCHT
			mm	TPI										
MTH-10-32UNJF3B-BC-S142	10001153	UNJF10-32	–	32.0	6,0 0.236	16,0 0.630	16,0 0.630	68,02 2.678	4,15 0.163	6.00X4.90	3	DIN2184-1	3B	C
MTH-1/4-28UNJF3B-BC-S142	10001154	UNJF1/4-28	–	28.0	7,0 0.276	25,0 0.984	15,0 0.591	77,73 3.060	5,6 0.220	7.00X5.50	3	DIN2184-1	3B	C
MTH-5/16-24UNJF3B-BC-S142	10001155	UNJF5/16-24	–	24.0	8,0 0.315	29,5 1.161	18,0 0.709	87,03 3.426	7,0 0.276	8.00X6.20	3	DIN2184-1	3B	C
MTH-3/8-24UNJF3B-BC-S142	10001156	UNJF3/8-24	–	24.0	10,0 0.394	33,5 1.319	20,0 0.787	97,03 3.820	8,6 0.339	10.00X8.00	3	DIN2184-1	3B	C

Thread turning

MDT

Mini-Shaft™

Thread milling

Thread tapping

Annex

MTH-V015

Blind holes – Metric coarse threads

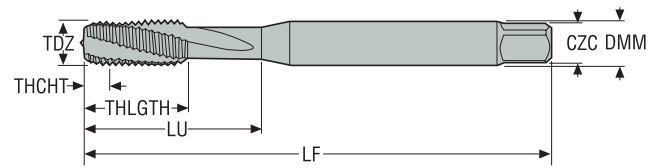

- Substrate: HSS-E
- Coating: TiN
- For cutting data see page(s) 283

Designation	Item number	TDZ	Pitch	DMM	LU	THLGTH	LF	PHDR	CZC	NOF	BSG	TCTR	THCHT
			mm TPI	mm Inch	mm Inch	mm Inch	mm Inch	mm Inch					
MTH-M3X0.50ISO6H-BC-V015	03019188	M3	0,5 –	3,5 0.138	18,0 0.709	9,0 0.354	54,625 2.151	2,5 0.098	3.50X2.70	3	DIN371	6H	C
MTH-M4X0.70ISO6H-BC-V015	03019189	M4	0,7 –	4,5 0.177	21,0 0.827	11,0 0.433	61,075 2.405	3,4 0.134	4.50X3.40	3	DIN371	6H	C
MTH-M5X0.80ISO6H-BC-V015	03019190	M5	0,8 –	6,0 0.236	25,0 0.984	13,0 0.512	67,8 2.669	4,3 0.169	6.00X4.90	3	DIN371	6H	C
MTH-M6X1.00ISO6H-BC-V015	03019191	M6	1,0 –	6,0 0.236	30,0 1.181	15,0 0.591	77,25 3.041	5,1 0.201	6.00X4.90	3	DIN371	6H	C
MTH-M8X1.25ISO6H-BC-V015	03019193	M8	1,25 –	8,0 0.315	35,0 1.378	18,0 0.709	86,5625 3.408	6,8 0.268	8.00X6.20	3	DIN371	6H	C
MTH-M10X1.50ISO6H-BC-V015	03019194	M10	1,5 –	10,0 0.394	39,0 1.535	20,0 0.787	95,875 3.775	8,6 0.339	10.00X8.00	3	DIN371	6H	C

Thread turning

MDT

Mini-Shaft™

Thread milling

Thread tapping

Annex

MTH-V016

Blind holes – Metric coarse threads

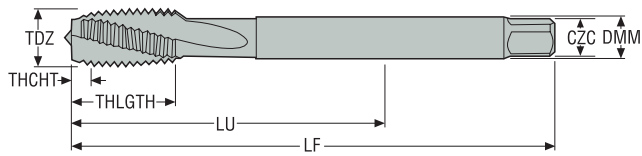

- Substrate: HSS-E
- Coating: TiN
- For cutting data see page(s) 283

Designation	Item number	TDZ	Pitch		DMM	LU	THLGTH	LF	PHDR	CZC	NOF	BSG	TCTR	THCHT
			mm	TPI										
MTH-M12X1.75ISO6H-BC-V016	03019195	M12	1,75	–	9,0 0.354	83,0 3.268	23,0 0.906	105,1875 4.141	10,4 0.409	9.00X7.00	3	DIN376	6H	C
MTH-M14X2.00ISO6H-BC-V016	03019196	M14	2,0	–	11,0 0.433	81,0 3.189	25,0 0.984	104,5 4.114	12,1 0.476	11.00X9.00	3	DIN376	6H	C
MTH-M16X2.00ISO6H-BC-V016	03019197	M16	2,0	–	12,0 0.472	68,0 2.677	25,0 0.984	104,5 4.114	14,1 0.555	12.00X9.00	3	DIN376	6H	C
MTH-M18X2.50ISO6H-BC-V016	03019198	M18	2,5	–	14,0 0.551	81,0 3.189	30,0 1.181	118,125 4.651	15,7 0.618	14.00X11.00	3	DIN376	6H	C
MTH-M20X2.50ISO6H-BC-V016	03019199	M20	2,5	–	16,0 0.630	95,0 3.740	30,0 1.181	133,125 5.241	17,7 0.697	16.00X12.00	3	DIN376	6H	C
MTH-M22X2.50ISO6H-BC-V016	03019200	M22	2,5	–	18,0 0.709	93,0 3.661	34,0 1.339	133,125 5.241	19,7 0.776	18.00X14.50	4	DIN376	6H	C
MTH-M24X3.00ISO6H-BC-V016	03019201	M24	3,0	–	18,0 0.709	113,0 4.449	38,0 1.496	151,75 5.974	21,0 0.827	18.00X14.50	4	DIN376	6H	C
MTH-M27X3.00ISO6H-BC-V016	03019202	M27	3,0	–	20,0 0.787	97,0 3.819	38,0 1.496	151,75 5.974	24,0 0.945	20.00X16.00	4	DIN376	6H	C
MTH-M30X3.50ISO6H-BC-V016	03019203	M30	3,5	–	22,0 0.866	115,0 4.528	45,0 1.772	171,79 6.763	26,5 1.043	22.00X18.00	4	DIN376	6H	C
MTH-M33X3.50ISO6H-BC-V016	03019204	M33	3,5	–	25,0 0.984	113,0 4.449	50,0 1.969	171,79 6.763	29,5 1.161	25.00X20.00	4	DIN376	6H	C
MTH-M36X4.00ISO6H-BC-V016	03019205	M36	4,0	–	28,0 1.102	131,0 5.157	55,0 2.165	190,7 7.508	32,0 1.260	28.00X22.00	4	DIN376	6H	C

MTH-V048

Blind holes – NPT threads

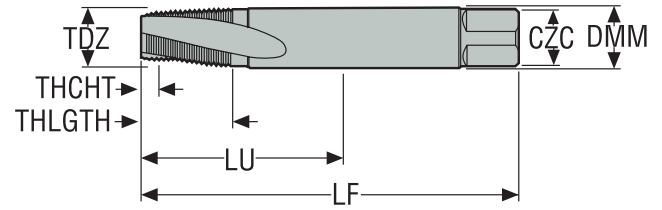

- Substrate: HSS-E
- Vaporised
- For cutting data see page(s) 285

Designation	Item number	TDZ	Pitch		DMM	LU	THLGTH	LF	PHDR	CZC	NOF	BSG	TCTR	THCHT
			mm	TPI	mm Inch	mm Inch	mm Inch	mm Inch	mm Inch					
MTH-1/16-27NPT-XC-V048	02880750	NPT1/16-27	–	27.0	7,95 0.313	56,0 2.205	14,0 0.551	80,0 3.150	6,15 0.242	7.95X5.94	3	DIN/ANSI	NORMAL	C
MTH-1/8-27NPT-XC-V048	02880751	NPT1/8-27	–	27.0	11,1 0.437	64,0 2.520	14,0 0.551	90,0 3.543	8,4 0.331	11.10X8.33	4	DIN/ANSI	NORMAL	C
MTH-1/4-18NPT-XC-V048	02880752	NPT1/4-18	–	18.0	14,27 0.562	59,0 2.323	20,0 0.787	100,0 3.937	11,1 0.437	14.27X10.69	4	DIN/ANSI	NORMAL	C
MTH-3/8-18NPT-XC-V048	02880753	NPT3/8-18	–	18.0	17,78 0.700	67,0 2.638	20,0 0.787	110,0 4.331	14,3 0.563	17.78X13.49	5	DIN/ANSI	NORMAL	C
MTH-1/2-14NPT-XC-V048	02880754	NPT1/2-14	–	14.0	17,45 0.687	79,0 3.110	26,0 1.024	125,0 4.921	17,9 0.705	17.45X13.08	5	DIN/ANSI	NORMAL	C
MTH-3/4-14NPT-XC-V048	02880755	NPT3/4-14	–	14.0	23,01 0.906	78,0 3.071	26,0 1.024	140,0 5.512	23,2 0.913	23.01X17.25	5	DIN/ANSI	NORMAL	C
MTH-1-11.5NPT-XC-V048	02880756	NPT1-11.5	–	11.5	28,58 1.125	58,0 2.283	31,0 1.220	150,0 5.906	29,0 1.142	28.58X21.41	5	DIN/ANSI	NORMAL	C

Thread turning

MDT

Mini-Shaft™

Thread milling

Thread tapping

Annex

MTH-V050

Blind holes – NPTF threads

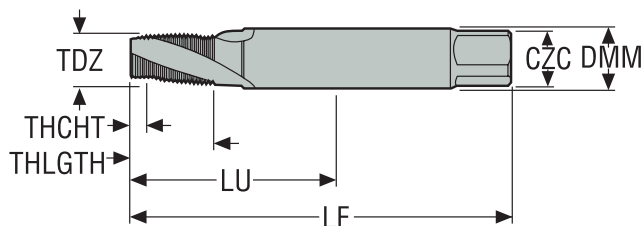

- Substrate: HSS-E
- Vaporised
- For cutting data see page(s) 285

Designation	Item number	TDZ	Pitch		DMM	LU	THLGTH	LF	PHDR	CZC	NOF	BSG	TCTR	THCHT
			mm	TPI										
MTH-1/16-27NPTF-XC-V050	02880757	NPTF1/16-27	-	27.0	7,95 <i>0.313</i>	56,0 <i>2.205</i>	14,0 <i>0.551</i>	80,0 <i>3.150</i>	6,1 <i>0.240</i>	7.95X5.94	3	DIN/ANSI	NORMAL	C
MTH-1/8-27NPTF-XC-V050	02880758	NPTF1/8-27	-	27.0	11,1 <i>0.437</i>	64,0 <i>2.520</i>	14,0 <i>0.551</i>	90,0 <i>3.543</i>	8,4 <i>0.331</i>	11.10X8.33	4	DIN/ANSI	NORMAL	C
MTH-1/4-18NPTF-XC-V050	02880759	NPTF1/4-18	-	18.0	14,27 <i>0.562</i>	59,0 <i>2.323</i>	20,0 <i>0.787</i>	100,0 <i>3.937</i>	11,0 <i>0.433</i>	14.27X10.69	4	DIN/ANSI	NORMAL	C
MTH-3/8-18NPTF-XC-V050	02880760	NPTF3/8-18	-	18.0	17,78 <i>0.700</i>	67,0 <i>2.638</i>	20,0 <i>0.787</i>	110,0 <i>4.331</i>	14,3 <i>0.563</i>	17.78X13.49	5	DIN/ANSI	NORMAL	C
MTH-1/2-14NPTF-XC-V050	02880761	NPTF1/2-14	-	14.0	17,45 <i>0.687</i>	79,0 <i>3.110</i>	26,0 <i>1.024</i>	125,0 <i>4.921</i>	17,6 <i>0.693</i>	17.45X13.08	5	DIN/ANSI	NORMAL	C
MTH-3/4-14NPTF-XC-V050	02880762	NPTF3/4-14	-	14.0	23,01 <i>0.906</i>	78,0 <i>3.071</i>	26,0 <i>1.024</i>	140,0 <i>5.512</i>	23,0 <i>0.906</i>	23X17.25	5	DIN/ANSI	NORMAL	C

Thread turning

MDT

Mini-Shaft™

Thread milling

Thread tapping

Annex

MTS-K101

Blind and through holes – Metric coarse threads

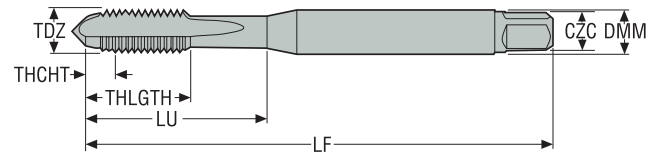

- Substrate: HSS-E-PM
- Coating: TiAlN
- For cutting data see page(s) 281

Designation	Item number	TDZ	Pitch	DMM	LU	THLGTH	LF	PHDR	CZC	NOF	BSG	TCTR	THCHT
			mm TPI	mm <i>Inch</i>	mm <i>Inch</i>	mm <i>Inch</i>	mm <i>Inch</i>	mm <i>Inch</i>					
MTS-M3X0.50ISO6HX-XC-K101	03305497	M3	0,5 –	3,5 <i>0.138</i>	18,0 <i>0.709</i>	9,0 <i>0.354</i>	54,63 <i>2.151</i>	2,5 <i>0.098</i>	3.50X2.70	4	DIN371	6HX	C
MTS-M4X0.70ISO6HX-XC-K101	03305498	M4	0,7 –	4,5 <i>0.177</i>	21,0 <i>0.827</i>	12,0 <i>0.472</i>	61,08 <i>2.405</i>	3,4 <i>0.134</i>	4.50X3.40	4	DIN371	6HX	C
MTS-M5X0.80ISO6HX-XC-K101	03305499	M5	0,8 –	6,0 <i>0.236</i>	25,0 <i>0.984</i>	13,0 <i>0.512</i>	67,80 <i>2.669</i>	4,3 <i>0.169</i>	6.00X4.90	5	DIN371	6HX	C
MTS-M6X1.00ISO6HX-XC-K101	03305500	M6	1,0 –	6,0 <i>0.236</i>	30,0 <i>1.181</i>	15,0 <i>0.591</i>	77,25 <i>3.041</i>	5,1 <i>0.201</i>	6.00X4.90	5	DIN371	6HX	C
MTS-M8X1.25ISO6HX-XC-K101	03305501	M8	1,25 –	8,0 <i>0.315</i>	35,0 <i>1.378</i>	18,0 <i>0.709</i>	86,56 <i>3.408</i>	6,8 <i>0.268</i>	8.00X6.20	5	DIN371	6HX	C
MTS-M10X1.50ISO6HX-XC-K101	03305502	M10	1,5 –	10,0 <i>0.394</i>	39,0 <i>1.535</i>	20,0 <i>0.787</i>	95,88 <i>3.775</i>	8,6 <i>0.339</i>	10.00X8.00	5	DIN371	6HX	C

Thread turning

MDT

Mini-Shaft™

Thread milling

Thread tapping

Annex

MTS-K101-A

Blind and through holes – Metric coarse threads

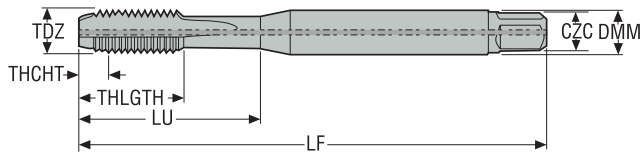

- Internal coolant
- Substrate: HSS-E-PM
- Coating: TiAlN
- For cutting data see page(s) 281

Designation	Item number	TDZ	Pitch		DMM	LU	THLGTH	LF	PHDR	CZC	NOF	BSG	TCTR	THCHT
			mm	TPI										
MTS-M4X0.70ISO6HX-XC-K101-A	03305448	M4	0,7	–	4,5 <i>0.177</i>	21,0 <i>0.827</i>	12,0 <i>0.472</i>	61,07 <i>2.404</i>	3,4 <i>0.134</i>	4.50X3.40	4	DIN371	6HX	C
MTS-M5X0.80ISO6HX-XC-K101-A	03305450	M5	0,8	–	6,0 <i>0.236</i>	25,0 <i>0.984</i>	13,0 <i>0.512</i>	67,80 <i>2.669</i>	4,3 <i>0.169</i>	6.00X4.90	5	DIN371	6HX	C
MTS-M5X0.80ISO6HX-XE-K101-A	03305460	M5	0,8	–	6,0 <i>0.236</i>	25,0 <i>0.984</i>	13,0 <i>0.512</i>	67,80 <i>2.669</i>	4,3 <i>0.169</i>	6.00X4.90	5	DIN371	6HX	E
MTS-M6X1.00ISO6HX-XC-K101-A	03305451	M6	1,0	–	6,0 <i>0.236</i>	30,0 <i>1.181</i>	15,0 <i>0.591</i>	77,25 <i>3.041</i>	5,1 <i>0.201</i>	6.00X4.90	5	DIN371	6HX	C
MTS-M6X1.00ISO6HX-XE-K101-A	03305461	M6	1,0	–	6,0 <i>0.236</i>	30,0 <i>1.181</i>	15,0 <i>0.591</i>	78,25 <i>3.081</i>	5,1 <i>0.201</i>	6.00X4.90	5	DIN371	6HX	E
MTS-M8X1.25ISO6HX-XC-K101-A	03305452	M8	1,25	–	8,0 <i>0.315</i>	35,0 <i>1.378</i>	18,0 <i>0.709</i>	86,56 <i>3.408</i>	6,8 <i>0.268</i>	8.00X6.20	5	DIN371	6HX	C
MTS-M8X1.25ISO6HX-XE-K101-A	03305462	M8	1,25	–	8,0 <i>0.315</i>	35,0 <i>1.378</i>	18,0 <i>0.709</i>	87,81 <i>3.457</i>	6,8 <i>0.268</i>	8.00X6.20	5	DIN371	6HX	E
MTS-M10X1.50ISO6HX-XC-K101-A	03305453	M10	1,5	–	10,0 <i>0.394</i>	39,0 <i>1.535</i>	20,0 <i>0.787</i>	95,88 <i>3.775</i>	8,6 <i>0.339</i>	10.00X8.00	5	DIN371	6HX	C
MTS-M10X1.50ISO6HX-XE-K101-A	03305463	M10	1,5	–	10,0 <i>0.394</i>	39,0 <i>1.535</i>	20,0 <i>0.787</i>	97,38 <i>3.834</i>	8,6 <i>0.339</i>	10.00X8.00	5	DIN371	6HX	E

MTS-K002

Blind and through holes – Metric coarse threads

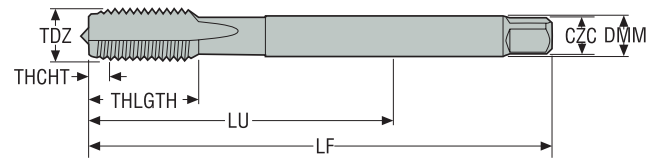

- Substrate: HSS-E-PM
- Coating: TiAlN
- For cutting data see page(s) 281

Designation	Item number	TDZ	Pitch	DMM	LU	THLGTH	LF	PHDR	CZC	NOF	BSG	TCTR	THCHT
			mm TPI	mm <i>Inch</i>	mm <i>Inch</i>	mm <i>Inch</i>	mm <i>Inch</i>	mm <i>Inch</i>					
MTS-M27X3.00ISO6HX-XC-K002	02999880	M27	3,0 –	20,0 <i>0.787</i>	97,0 <i>3.819</i>	38,0 <i>1.496</i>	151,6 <i>5.969</i>	24,0 <i>0.945</i>	20.00X16.00	4	DIN376	6HX	C
MTS-M30X3.50ISO6HX-XC-K002	02999881	M30	3,5 –	22,0 <i>0.866</i>	115,0 <i>4.528</i>	45,0 <i>1.772</i>	170,2 <i>6.701</i>	26,5 <i>1.043</i>	22.00X18.00	4	DIN376	6HX	C
MTS-M33X3.50ISO6HX-XC-K002	02999882	M33	3,5 –	25,0 <i>0.984</i>	113,0 <i>4.449</i>	50,0 <i>1.969</i>	170,2 <i>6.701</i>	29,5 <i>1.161</i>	25.00X20.00	4	DIN376	6HX	C
MTS-M36X4.00ISO6HX-XC-K002	02999883	M36	4,0 –	28,0 <i>1.102</i>	131,0 <i>5.157</i>	55,0 <i>2.165</i>	188,8 <i>7.433</i>	32,0 <i>1.260</i>	28.00X22.00	4	DIN376	6HX	C
MTS-M39X4.00ISO6HX-XC-K002	02999884	M39	4,0 –	32,0 <i>1.260</i>	102,0 <i>4.016</i>	60,0 <i>2.362</i>	188,8 <i>7.433</i>	35,0 <i>1.378</i>	32.00X24.00	4	DIN376	6HX	C
MTS-M42X4.50ISO6HX-XC-K002	02999885	M42	4,5 –	32,0 <i>1.260</i>	102,0 <i>4.016</i>	60,0 <i>2.362</i>	187,4 <i>7.378</i>	37,5 <i>1.476</i>	32.00X24.00	4	DIN376	6HX	C

Thread turning

MDT

Mini-Shaft™

Thread milling

Thread tapping

Annex

MTS-K002-A

Blind and through holes – Metric coarse threads

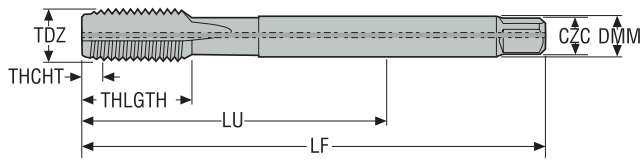

- Internal coolant
- Substrate: HSS-E-PM
- Coating: TiAlN
- For cutting data see page(s) 281

Designation	Item number	TDZ	Pitch		DMM	LU	THLGTH	LF	PHDR	CXC	NOF	BSG	TCTR	THCHT
			mm	TPI										
MTS-M27X3.00ISO6HX-XC-K002-A	02999838	M27	3,0	–	20,0 <i>0.787</i>	97,0 <i>3.819</i>	38,0 <i>1.496</i>	152,5 <i>6.004</i>	24,0 <i>0.945</i>	20.00X16.00	4	DIN376	6HX	C
MTS-M30X3.50ISO6HX-XC-K002-A	02999839	M30	3,5	–	22,0 <i>0.866</i>	115,0 <i>4.528</i>	45,0 <i>1.772</i>	171,25 <i>6.742</i>	26,5 <i>1.043</i>	22.00X18.00	4	DIN376	6HX	C
MTS-M33X3.50ISO6HX-XC-K002-A	02999840	M33	3,5	–	25,0 <i>0.984</i>	113,0 <i>4.449</i>	50,0 <i>1.969</i>	170,2 <i>6.701</i>	29,5 <i>1.161</i>	25.00X20.00	4	DIN376	6HX	C
MTS-M36X4.00ISO6HX-XC-K002-A	02999841	M36	4,0	–	28,0 <i>1.102</i>	131,0 <i>5.157</i>	55,0 <i>2.165</i>	188,8 <i>7.433</i>	32,0 <i>1.260</i>	28.00X22.00	4	DIN376	6HX	C
MTS-M39X4.00ISO6HX-XC-K002-A	02999842	M39	4,0	–	32,0 <i>1.260</i>	102,0 <i>4.016</i>	60,0 <i>2.362</i>	188,8 <i>7.433</i>	35,0 <i>1.378</i>	32.00X24.00	4	DIN376	6HX	C
MTS-M42X4.50ISO6HX-XC-K002-A	02999843	M42	4,5	–	32,0 <i>1.260</i>	102,0 <i>4.016</i>	60,0 <i>2.362</i>	187,4 <i>7.378</i>	37,5 <i>1.476</i>	32.00X24.00	4	DIN376	6HX	C

MTS-K102

Blind and through holes – Metric coarse threads

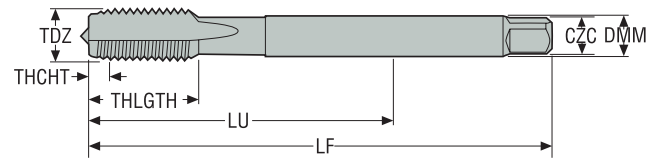

- Substrate: HSS-E-PM
- Coating: TiAlN
- For cutting data see page(s) 281

Designation	Item number	TDZ	Pitch	DMM	LU	THLGTH	LF	PHDR	CZC	NOF	BSG	TCTR	THCHT
			mm TPI	mm Inch	mm Inch	mm Inch	mm Inch	mm Inch					
MTS-M8X1.25ISO6HX-XC-K102	03305503	M8	1,25 –	6,0 0.236	67,0 2.638	20,0 0.787	86,56 3.408	6,8 0.268	6.00X4.90	5	DIN376	6HX	C
MTS-M10X1.50ISO6HX-XC-K102	03305504	M10	1,5 –	7,0 0.276	77,0 3.031	23,5 0.925	95,88 3.775	8,6 0.339	7.00X5.50	5	DIN376	6HX	C
MTS-M12X1.75ISO6HX-XC-K102	03305505	M12	1,75 –	9,0 0.354	83,0 3.268	23,0 0.906	105,19 4.141	10,4 0.409	9.00X7.00	5	DIN376	6HX	C
MTS-M14X2.00ISO6HX-XC-K102	03305506	M14	2,0 –	11,0 0.433	81,0 3.189	25,0 0.984	104,50 4.114	12,1 0.476	11.00X9.00	5	DIN376	6HX	C
MTS-M16X2.00ISO6HX-XC-K102	03305507	M16	2,0 –	12,0 0.472	68,0 2.677	25,0 0.984	104,50 4.114	14,1 0.555	12.00X9.00	5	DIN376	6HX	C
MTS-M18X2.50ISO6HX-XC-K102	03305508	M18	2,5 –	14,0 0.551	81,0 3.189	30,0 1.181	118,13 4.651	15,7 0.618	14.00X11.00	5	DIN376	6HX	C
MTS-M20X2.50ISO6HX-XC-K102	03305509	M20	2,5 –	16,0 0.630	95,0 3.740	30,0 1.181	133,13 5.241	17,7 0.697	16.00X12.00	5	DIN376	6HX	C
MTS-M22X2.50ISO6HX-XC-K102	03305510	M22	2,5 –	18,0 0.709	93,0 3.661	34,0 1.339	133,13 5.241	19,7 0.776	18.00X14.50	5	DIN376	6HX	C
MTS-M24X3.00ISO6HX-XC-K102	03305511	M24	3,0 –	18,0 0.709	113,0 4.449	38,0 1.496	151,75 5.974	21,0 0.827	18.00X14.50	5	DIN376	6HX	C

Thread turning

MDT

Mini-Shaft™

Thread milling

Thread tapping

Annex

MTS-K102-A

Blind and through holes – Metric coarse threads

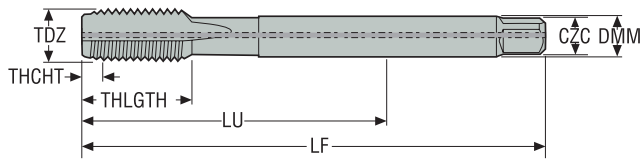

- Internal coolant
- Substrate: HSS-E-PM
- Coating: TiAlN
- For cutting data see page(s) 281

Designation	Item number	TDZ	Pitch		DMM	LU	THLGTH	LF	PHDR	CXC	NOF	BSG	TCTR	THCHT
			mm	TPI										
MTS-M12X1.75ISO6HX-XC-K102-A	03305454	M12	1,75	–	9,0 <i>0.354</i>	83,0 <i>3.268</i>	23,0 <i>0.906</i>	105,19 <i>4.141</i>	10,4 <i>0.409</i>	9.00X7.00	5	DIN376	6HX	C
MTS-M12X1.75ISO6HX-XE-K102-A	03305464	M12	1,75	–	9,0 <i>0.354</i>	83,0 <i>3.268</i>	23,0 <i>0.906</i>	106,94 <i>4.210</i>	10,4 <i>0.409</i>	9.00X7.00	5	DIN376	6HX	E
MTS-M14X2.00ISO6HX-XC-K102-A	03305455	M14	2,0	–	11,0 <i>0.433</i>	81,0 <i>3.189</i>	25,0 <i>0.984</i>	104,50 <i>4.114</i>	12,1 <i>0.476</i>	11.00X9.00	5	DIN376	6HX	C
MTS-M16X2.00ISO6HX-XC-K102-A	03305456	M16	2,0	–	12,0 <i>0.472</i>	68,0 <i>2.677</i>	25,0 <i>0.984</i>	104,50 <i>4.114</i>	14,1 <i>0.555</i>	12.00X9.00	5	DIN376	6HX	C
MTS-M16X2.00ISO6HX-XE-K102-A	03305465	M16	2,0	–	12,0 <i>0.472</i>	68,0 <i>2.677</i>	25,0 <i>0.984</i>	106,50 <i>4.193</i>	14,1 <i>0.555</i>	12.00X9.00	5	DIN376	6HX	E
MTS-M20X2.50ISO6HX-XC-K102-A	03305457	M20	2,5	–	16,0 <i>0.630</i>	95,0 <i>3.740</i>	30,0 <i>1.181</i>	133,13 <i>5.241</i>	17,7 <i>0.697</i>	16.00X12.00	5	DIN376	6HX	C
MTS-M22X2.50ISO6HX-XC-K102-A	03305458	M22	2,5	–	18,0 <i>0.709</i>	93,0 <i>3.661</i>	34,0 <i>1.339</i>	133,13 <i>5.241</i>	19,7 <i>0.776</i>	18.00X14.50	5	DIN376	6HX	C
MTS-M24X3.00ISO6HX-XC-K102-A	03305459	M24	3,0	–	18,0 <i>0.709</i>	113,0 <i>4.449</i>	38,0 <i>1.496</i>	151,75 <i>5.974</i>	21,0 <i>0.827</i>	18.00X14.50	5	DIN376	6HX	C

MTS-K111

Blind and through holes – MF threads

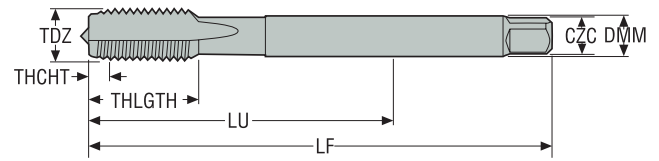

- Substrate: HSS-E-PM
- Coating: TiAlN
- For cutting data see page(s) 281

Designation	Item number	TDZ	Pitch		DMM	LU	THLGTH	LF	PHDR	CZC	NOF	BSG	TCTR	THCHT
			mm	TPI										
MTS-M10X1.00ISO6HX-XC-K111	03305466	MF10X1.0	1,0	–	7,0 0.276	67,0 2.638	18,0 0.709	87,25 3.435	9,0 0.354	7.00X5.50	5	DIN374	6HX	C
MTS-M10X1.25ISO6HX-XC-K111	03305467	MF10X1.25	1,25	–	7,0 0.276	77,0 3.031	20,0 0.787	96,56 3.802	8,8 0.346	7.00X5.50	5	DIN374	6HX	C
MTS-M12X1.25ISO6HX-XC-K111	03305468	MF12X1.25	1,25	–	9,0 0.354	73,0 2.874	21,0 0.827	96,56 3.802	10,75 0.423	9.00X7.00	5	DIN374	6HX	C
MTS-M12X1.50ISO6HX-XC-K111	03305469	MF12X1.5	1,5	–	9,0 0.354	73,0 2.874	21,0 0.827	95,88 3.775	10,5 0.413	9.00X7.00	5	DIN374	6HX	C
MTS-M14X1.50ISO6HX-XC-K111	03305470	MF14X1.5	1,5	–	11,0 0.433	71,0 2.795	21,0 0.827	95,88 3.775	12,5 0.492	11.00X9.00	5	DIN374	6HX	C
MTS-M16X1.50ISO6HX-XC-K111	03305471	MF16X1.5	1,5	–	12,0 0.472	58,0 2.283	21,0 0.827	95,88 3.775	14,5 0.571	12.00X9.00	5	DIN374	6HX	C
MTS-M18X1.50ISO6HX-XC-K111	03305472	MF18X1.5	1,5	–	14,0 0.551	66,0 2.598	24,0 0.945	105,88 4.168	16,5 0.650	14.00X11.00	5	DIN374	6HX	C
MTS-M20X1.50ISO6HX-XC-K111	03305473	MF20X1.5	1,5	–	16,0 0.630	80,0 3.150	24,0 0.945	120,88 4.759	18,5 0.728	16.00X12.00	5	DIN374	6HX	C

Thread turning

MDT

Mini-Shaft™

Thread milling

Thread tapping

Annex

MTS-K121

Blind and through holes – G threads

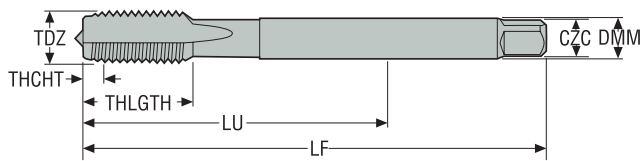

- Substrate: HSS-E-PM
- Coating: TiAlN
- For cutting data see page(s) 281

Designation	Item number	TDZ	Pitch		DMM	LU	THLGTH	LF	PHDR	CXC	NOF	BSG	TCTR	THCHT
			mm	TPI										
MTS-1/8-28G-XC-K121	03305474	G1/8-28	-	28,0	7,0 0.276	67,0 2.638	13,0 0.512	87,51 3.445	8,8 0.346	7.00X5.50	4	DIN5156	NORMAL-X	C
MTS-1/4-19G-XC-K121	03305475	G1/4-19	-	19,0	11,0 0.433	71,0 2.795	15,0 0.591	96,32 3.792	11,8 0.465	11.00X9.00	4	DIN5156	NORMAL-X	C
MTS-3/8-19G-XC-K121	03305476	G3/8-19	-	19,0	12,0 0.472	58,0 2.283	21,0 0.827	96,32 3.792	15,25 0.600	12.00X9.00	5	DIN5156	NORMAL-X	C
MTS-1/2-14G-XC-K121	03305477	G1/2-14	-	14,0	16,0 0.630	80,0 3.150	21,0 0.827	120,01 4.725	19,0 0.748	16.00X12.00	5	DIN5156	NORMAL-X	C
MTS-3/4-14G-XC-K121	03305478	G3/4-14	-	14,0	20,0 0.787	77,0 3.031	21,0 0.827	135,01 5.315	24,5 0.965	20.00X16.00	6	DIN5156	NORMAL-X	C
MTS-1-11G-XC-K121	03305479	G1-11	-	11,0	25,0 0.984	93,0 3.661	27,0 1.063	153,65 6.049	30,75 1.211	25.00X20.00	6	DIN5156	NORMAL-X	C

MTS-K131

Blind and through holes – UNC threads

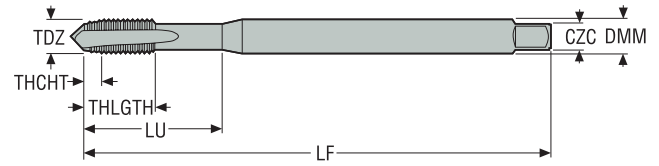

- Substrate: HSS-E-PM
- Coating: TiAlN
- For cutting data see page(s) 281

Designation	Item number	TDZ	Pitch		DMM	LU	THLGTH	LF	PHDR	CZC	NOF	BSG	TCTR	THCHT
			mm	TPI										
MTS-1/4-20UNC-XC-K131	03305480	UNC1/4-20	–	20.0	7,0 0.276	25,0 0.984	15,6 0.614	76,50 3.012	5,1 0.201	8.25X5.5	5	DIN2184-1	2BX	C
MTS-5/16-18UNC-XC-K131	03305481	UNC5/16-18	–	18.0	8,0 0.315	33,5 1.319	18,7 0.736	86,12 3.391	6,6 0.260	9.25X6.20	5	DIN2184-1	2BX	C
MTS-3/8-16UNC-XC-K131	03305482	UNC3/8-16	–	16.0	10,0 0.394	38,0 1.496	20,6 0.811	95,63 3.765	8,0 0.315	11.25X8.00	5	DIN2184-1	2BX	C
MTS-7/16-14UNC-XC-K131	03305483	UNC7/16-14	–	14.0	8,0 0.315	72,7 2.862	20,0 0.787	95,01 3.741	9,4 0.370	9.25X6.20	5	DIN2184-1	2BX	C
MTS-1/2-13UNC-XC-K131	03305484	UNC1/2-13	–	13.0	9,0 0.354	81,9 3.224	23,0 0.906	104,63 4.119	10,8 0.425	10.25X7.00	5	DIN2184-1	2BX	C
MTS-5/8-11UNC-XC-K131	03305485	UNC5/8-11	–	11.0	12,0 0.472	65,7 2.587	23,0 0.906	103,65 4.081	13,5 0.531	12.25X9.00	5	DIN2184-1	2BX	C
MTS-3/4-10UNC-XC-K131	03305486	UNC3/4-10	–	10.0	14,0 0.551	77,5 3.051	30,0 1.181	118,02 4.646	16,5 0.650	14.25X11.00	5	DIN2184-1	2BX	C
MTS-7/8-9UNC-XC-K131	03305487	UNC7/8-9	–	9.0	18,0 0.709	90,95 3.581	34,0 1.339	132,24 5.206	19,5 0.768	17.25X14.5	5	DIN2184-1	2BX	C

Thread turning

MDT

Mini-Shaft™

Thread milling

Thread tapping

Annex

MTS-K141

Blind and through holes – UNF threads

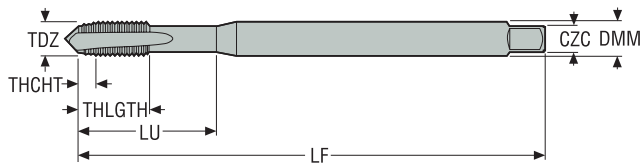

- Substrate: HSS-E-PM
- Coating: TiAlN
- For cutting data see page(s) 281

Designation	Item number	TDZ	Pitch		DMM	LU	THLGTH	LF	PHDR	CZC	NOF	BSG	TCTR	THCHT
			mm	TPI	mm <i>Inch</i>	mm <i>Inch</i>	mm <i>Inch</i>	mm <i>Inch</i>	mm <i>Inch</i>					
MTS-1/4-28UNF-XC-K141	03305488	UNF1/4-28	–	28.0	7,0 <i>0.276</i>	25,0 <i>0.984</i>	15,6 <i>0.614</i>	77,50 <i>3.051</i>	5,5 <i>0.217</i>	8.25X5.5	5	DIN2184-1	2BX	C
MTS-5/16-24UNF-XC-K141	03305489	UNF5/16-24	–	24.0	8,0 <i>0.315</i>	33,5 <i>1.319</i>	18,7 <i>0.736</i>	87,09 <i>3.429</i>	6,9 <i>0.272</i>	9.25X6.20	5	DIN2184-1	2BX	C
MTS-3/8-24UNF-XC-K141	03305491	UNF3/8-24	–	24.0	10,0 <i>0.394</i>	38,0 <i>1.496</i>	20,6 <i>0.811</i>	97,09 <i>3.822</i>	8,5 <i>0.335</i>	11.25X8.00	5	DIN2184-1	2BX	C
MTS-7/16-20UNF-XC-K141	03305492	UNF7/16-20	–	20.0	8,0 <i>0.315</i>	72,7 <i>2.862</i>	20,0 <i>0.787</i>	96,51 <i>3.800</i>	9,9 <i>0.390</i>	9.25X6.20	5	DIN2184-1	2BX	C
MTS-1/2-20UNF-XC-K141	03305493	UNF1/2-20	–	20.0	9,0 <i>0.354</i>	71,9 <i>2.831</i>	23,0 <i>0.906</i>	106,51 <i>4.193</i>	11,5 <i>0.453</i>	10.25X7.00	5	DIN2184-1	2BX	C
MTS-5/8-18UNF-XC-K141	03305494	UNF5/8-18	–	18.0	12,0 <i>0.472</i>	55,7 <i>2.193</i>	23,0 <i>0.906</i>	106,12 <i>4.178</i>	14,5 <i>0.571</i>	12.25X9.00	5	DIN2184-1	2BX	C
MTS-3/4-16UNF-XC-K141	03305495	UNF3/4-16	–	16.0	14,0 <i>0.551</i>	62,5 <i>2.461</i>	25,0 <i>0.984</i>	120,63 <i>4.749</i>	17,5 <i>0.689</i>	14.25X11.00	5	DIN2184-1	2BX	C
MTS-7/8-14UNF-XC-K141	03305496	UNF7/8-14	–	14.0	18,0 <i>0.709</i>	75,95 <i>2.990</i>	25,0 <i>0.984</i>	135,01 <i>5.315</i>	20,4 <i>0.803</i>	17.25X14.5	5	DIN2184-1	2BX	C

MF-V060-A

Forming holes– Metric coarse threads

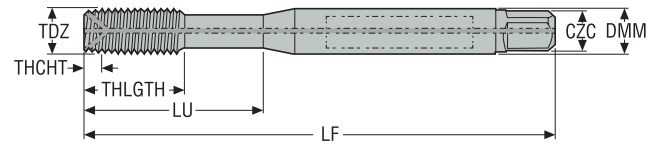

- Internal coolant
- Substrate: HSS-E
- Coating: TiN
- For cutting data see page(s) 287

Designation	Item number	TDZ	Pitch	DMM	LU	THLGTH	LF	PHDR	CZC	NOF	BSG	TCTR	THCHT
			mm TPI	mm Inch	mm Inch	mm Inch	mm Inch	mm Inch					
MF-M12X1.75ISO6HX-XC-V060-A	02880487	M12	1,75 –	9,0 0.354	83,0 3.268	23,0 0.906	104,75 4.124	11,2 0.441	9.00X7.00	5	DIN2174	6HX	C
MF-M14X2.00ISO6HX-XC-V060-A	03000329	M14	2,0 –	11,0 0.433	81,0 3.189	25,0 0.984	103,0 4.055	13,1 0.516	11.00X9.00	6	DIN2174	6HX	C
MF-M16X2.00ISO6HX-XC-V060-A	03000330	M16	2,0 –	12,0 0.472	68,0 2.677	25,0 0.984	104,0 4.094	15,1 0.594	12.00X9.00	6	DIN2174	6HX	C
MF-M18X2.50ISO6HX-XC-V060-A	03000331	M18	2,5 –	14,0 0.551	81,0 3.189	30,0 1.181	116,25 4.577	16,9 0.665	14.00X11.00	7	DIN2174	6HX	C
MF-M20X2.50ISO6HX-XC-V060-A	03000332	M20	2,5 –	16,0 0.630	95,0 3.740	30,0 1.181	132,5 5.217	18,9 0.744	16.00X12.00	7	DIN2174	6HX	C
MF-M22X2.50ISO6HX-XC-V060-A	03000333	M22	2,5 –	18,0 0.709	93,0 3.661	34,0 1.339	131,25 5.167	20,9 0.823	18.00X14.50	7	DIN2174	6HX	C
MF-M24X3.00ISO6HX-XC-V060-A	03000334	M24	3,0 –	18,0 0.709	113,0 4.449	38,0 1.496	149,5 5.886	22,65 0.892	18.00X14.50	8	DIN2174	6HX	C

Thread turning

MDT

Mini-Shaft™

Thread milling

Thread tapping

Annex

MF-V063-A

Forming holes– MF threads

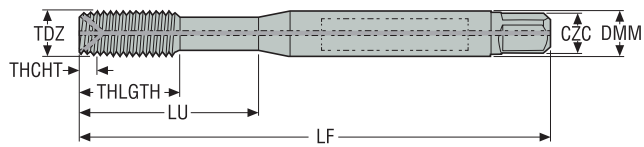

- Internal coolant
- Substrate: HSS-E
- Coating: TiN
- For cutting data see page(s) 287

Designation	Item number	TDZ	Pitch		DMM	LU	THLGTH	LF	PHDR	CZC	NOF	BSG	TCTR	THCHT
			mm	TPI										
MF-M12X1.25ISO6HX-XC-V063-A	03000351	MF12X1.25	1,25	-	9,0 0.354	73,0 2.874	21,0 0.827	95,62 3.765	11,45 0.451	9.00X7.00	5	DIN2174	6HX	C
MF-M14X1.50ISO6HX-XC-V063-A	03000355	MF14X1.5	1,5	-	11,0 0.433	71,0 2.795	21,0 0.827	95,5 3.760	13,35 0.526	11.00X9.00	6	DIN2174	6HX	C
MF-M16X1.50ISO6HX-XC-V063-A	03000357	MF16X1.5	1,5	-	12,0 0.472	58,0 2.283	21,0 0.827	95,5 3.760	15,35 0.604	12.00X9.00	6	DIN2174	6HX	C

Thread turning

MDT

Mini-Shaft™

Thread milling

Thread tapping

Annex

Steels, ferritic and martensitic stainless steels

SMG	Description	Properties	Reference	$k_{c1.1}$	m_c
P1	Free-cutting steels	$360 < R_m < 880$	11 SMn30 $R_m = 385 \text{ N/mm}^2$	1500	0,14
P2	Low-alloy ferritic steels, $C < 0.25\% \text{wt}$ Low-alloy weldable general structural steels	$320 < R_m < 600$	S235JRG2 $R_m = 420 \text{ N/mm}^2$	1600	0,23
P3	Ferritic & ferritic/pearlitic steels, $C < 0.25\% \text{wt}$ Weldable general structural steels Case-hardening steels	$430 < R_m < 610$	16 MnCr 5 $R_m = 550 \text{ N/mm}^2$	1800	0,14
P4	Low-alloy general structural steels, $0.25\% < C < 0.67\% \text{wt}$ Low-alloy Quench & Temper steels	$520 < R_m < 1200$	C 45E $R_m = 660 \text{ N/mm}^2$	2000	0,15
P5	Structural steels, $0.25\% < C < 0.67\% \text{wt}$ Quench & Temper steels	$550 < R_m < 1200$	42 CrMo 4 $R_m = 700 \text{ N/mm}^2$	2020	0,18
P6	Low-alloy through-hardening steels, $C > 0.67\% \text{wt}$ Low-alloy spring and bearing steels	$520 < R_m < 1200$	C 100S $R_m = 600 \text{ N/mm}^2$	2100	0,17
P7	Through-hardening steels, $C > 0.67\% \text{wt}$ Spring and bearing steels	$600 < R_m < 1200$	100 Cr 6 $R_m = 650 \text{ N/mm}^2$	2160	0,17
P8	Tool steels High Speed Steels (HSS)	$600 < R_m < 1200$	X 40 CrMoV 5 1 $R_m = 700 \text{ N/mm}^2$	2400	0,20
P11	Ferritic & martensitic stainless steels	$415 < R_m < 1200$	X 20 Cr 13 $R_m = 675 \text{ N/mm}^2$	2000	0,15
P12	Maraging and precipitation-hardening stainless steels	$500 < R_m < 1200$	X 5 CrNiCuNb 16 4 $R_m = 1100 \text{ N/mm}^2$	2100	0,17

Free-cutting, austenitic and duplex stainless steels

SMG	Description	Properties	Reference	$k_{c1.1}$	m_c
M1	Free-cutting austenitic stainless steels		X 10 CrNiS 18 9	1700	0,14
M2	Low-alloy austenitic stainless steels		X 5 CrNi 18 10	1920	0,18
M3	Medium-alloy austenitic stainless steels		X 2 CrNiMo 18 14 3	2070	0,17
M4	High-alloy austenitic and duplex stainless steels		X 2 CrNiMoN 22 5 3	2230	0,16
M5	Difficult high-alloy austenitic and duplex stainless steels		X 2 CrNiMoN 25 7 4	2510	0,13

Thread turning

MDT

Mini-Shaft™

Thread milling

Thread tapping

Annex

Cast irons

SMG	Description	Properties	Reference	$k_{c1.1}$	m_c
K1	Grey cast irons (GCI)		EN-GJL-250	930	0,32
K2	Compacted graphite irons (CGI)		EN-GJV-400	1000	0,35
K3	Malleable cast irons (MCI)		EN-GJMB-550-4	1050	0,37
K4	Nodular cast irons (SGI)		EN-GJS-500-7	1160	0,37
K5	Austempered ductile irons (ADI)		EN-GJS-1000-5		
K6	Austenitic lamellar cast irons		EN-GJLA-XNiCuCr15-6-2		
K7	Austenitic nodular cast irons		EN-GJSA-XNiMn23-4		

Non-ferrous metals

SMG	Description	Properties	Reference	$k_{c1.1}$	m_c
N1	Aluminium alloys, Si < 9%		AW-7075		
N2	Aluminium alloys, 9% < Si < 16%		AC-44200 Si = 12%		
N3	Aluminium alloys, Si > 16%		AISI17Cu5		
N11	Copper alloys		CW614N	740	0,26

Superalloys and titanium

SMG	Description	Properties	Reference	$k_{c1.1}$	m_c
S1	Iron-based superalloys		Disalloy		
S2	Cobalt-based superalloys		Stellite 21		
S3	Nickel-based superalloys		Inconel 718	2530	0,21
S11	Titanium, low alloyed, (α)		Ti		
S12	Titanium, medium alloyed, (α + β)		TiAl6V4	1500	0,24
S13	Titanium, high alloyed, (near β and β)		Ti10V2Fe3Al		

Hard materials

SMG	Description	Properties	Reference	$k_{c1.1}$	m_c
H3	Case-hardened steels	58 < HRC < 62	16 MnCr 5 60 HRC	2070	0,14
H5	Quenched & Tempered steels	38 < HRC < 56	42 CrMo 4 50 HRC	2320	0,18
H7	Quenched & Tempered steels Bearing steels	56 < HRC < 64	100 Cr 6 60 HRC	2480	0,17
H8	Tool steels High Speed Steels (HSS)	38 < HRC < 64	X 40 CrMoV 5 1 50 HRC	2750	0,20
H11	Martensitic stainless steels	38 < HRC < 50	X 20 Cr 13 45 HRC	2300	0,15
H12	Maraged and precipitation- hardened stainless steels	1200 < R_m < 1650	X 5 CrNiCuNb 16 4 $R_m = 1450 \text{ N/mm}^2$	2410	0,17
H21	Manganese steels	23 < HRC < 64	X 120 Mn 12 50 HRC		
H31	White cast irons	50 < HRC < 64	EN-GJN-HV600(XCr11) 55 HRC		

Other difficult materials

SMG	Description	Properties	Reference	$k_{c1.1}$	m_c
PM1	Low-alloy PM-materials		F-0008 Fe-0.7C		
PM2	Medium-alloy PM-materials		FLC-4608 Fe2Cu1.8Ni 0.5Mo0.2Mn0.8C		
PM3	High-alloy PM-materials Exhaust valve seat materials, etc.				
HF1	Hardfacing alloys Welded or plasma-deposited iron-based alloys				
HF2	Hardfacing alloys Welded or plasma-deposited cobalt- and nickel-based alloys				
CC1	Sintered tungsten carbide		G50		

Plastics and Composites

SMG	Description	Properties	Reference	$k_{c1.1}$	m_c
TS1	Thermosetting polymers		Urea formaldehyde (UF)		
TS2	Thermosetting carbon-fibre composites		T300 T700 T800 HTA-S IMA - Epoxy (M21)...		
TS3	Thermosetting glass-fibre composites		Epoxy - HX..(42..)E glass (7781...)...		
TS4	Thermosetting aramide-fibre composites		Kevlar 49		
TP1	Thermoplastic polymers		Polycarbonate (PC)		
TP2	Thermoplastic carbon-fibre composites		PPS/PEEK - T300..		
TP3	Thermoplastic glass-fibre composites		PPS/PEEK - E-glass or A-glass...		
TP4	Thermoplastic aramide-fibre composites				

Graphite

SMG	Description	Properties	Reference	$k_{c1.1}$	m_c
GR1	Graphite		R 8500		

SMG

SMG	EN	EN-Nr	W-Nr	DIN	AFNOR	BS	UNI	JIS	SS	UNS	
P1	11 SMn 30	1.0715	1.0715	9 SMn 28	S 250	230 M 07	CF 9 SMn 28	SUM 22	1912	G12130	
	11 SMnPb 30	1.0718	1.0718	9 SMnPb 28	S 250 Pb		CF 9 SMnPb 28	SUM 22 L	1914	G12134	
	10 S 20	1.0721	1.0721	10 S 20	10 F 1	210 M 15	CF 10 S 20				
			1.0722	10 SPb 20	10 PbF 2		CF 10 SPb 20				
	15 SMn 13	1.0725	1.0723	15 S 20		210 A 15		SUM 32	1922		
	35 S20	1.0726	1.0726	35 S 20	35 MF 4	212 M 36			1957	G11400	
	46 S20	1.0727	1.0727	46 S 20	46 MF 4	212 M 44			1973	G11460	
	11 SMn 37	1.0736	1.0736	9 SMn 36	S 300	240 M 07	CF 9 SMn 36			G12150	
11 SMn 37	1.0736	1.0736	9 SMn 36	S 300	240 M 07	CF 9 SMn 36			G12150		
S235JR	1.0037	1.0037	St 37-2	E 24-2		Fe 360 B	STKM 12 C	1311			
S235JRG2	1.0038	1.0116	St 37-3	E 24-3, E 24-4	4360-40 C	Fe 360 D FF		1312, 1313			
S275J2G3	1.0144	1.0144	St 44-3 N	E 28-3, E 28-4	4360-43 C	Fe 430 D FF	SM 41 C	1412, 1414			
C 10	1.0301	1.0301	C 10	34 C 10, XC 10	045 M 10	C 10	S 10 C			G10100	
		1.0401	C 15	37 C 12, XC 18	080 M 15	C 15, C 16		1350		G10170	
C22	1.0402	1.0402	C 22	C 20	050 A 20	C 20, C 21		1450		G10200	
S355JR	1.0570	1.0570	St 52-3	E 36-3, E 36-4	4360-50 C	Fe 510 B	SM 50 YA	2172, 2132			
C 15R	1.1141	1.1141	Ck 15	XC 15, XC 18	080 M 15	C 15, C 16		1370		G10170	
		1.1158	Ck 25	XC 25	060 A 25	C 25	S 25 C			G10250	
		1.2162	21 MnCr 5	20 NC 5			SCR 420 H				
P3	16 Mo 3	1.5415	1.5415	15 Mo 3	15 D 3	1501-240	16 Mo 3		2912		
			1.5423	16 Mo 5		1503-245-420	16 Mo 5	SB 450 M		G45200	
	14 NiCr 14	1.5752	1.5752	14 NiCr 14	12 NC 15	655 M 13		SNC 815 (H)		G33106	
			1.5919	15 CrNi 6	16 NC 6	S 107	16 CrNi 4				
	18 NiCrMo 7 6	1.6587	1.6587	18 CrNiMo 7 6	18 NCD 6	820 A 16	18 NiCrMo 7				
	16 MnCr 5	1.7131	1.7131	16 MnCr 5	16 MC 5	527 M 17	16 MnCr 5	SCR 415	2511		G51170
	16 MnCrS 5	1.7139	1.7139	16 MnCrS 5							
	20 MnCr 5	1.7147	1.7147	20 MnCr 5	20 MC 5		20 MnCr 5	SMnC 420 (H)			G51200
	20 MnCrS 5	1.7149	1.7149	20 MnCrS 5	20 MnCrS 5			SMnC 21 H			
	13 CrMo 4 5	1.7335	1.7335	13 CrMo 4 4	15 CD 3.5	1501-620 Gr. 27	14 CrMo 4 5		2216		
		1.7337	16 CrMo 4 4	15 CD 4.5	1501-620 Gr. 27	14 CrMo 4 5		2216			
10 CrMo 9 10	1.7380	1.7380	10 CrMo 9 10	10 CD 9.10	1501-622 Gr. 31	12 CrMo 9 10		2218		J21890	
P4	C35		1.0501	C 35	55 C 35	060 A 35	C 35		1550	G10350	
	E 335	1.0503	1.0503	C 45	65 C 45	80 M 46	C 45	S 45 C	1650	G10430	
	C40		1.0511	C 40	60 C 40	080 M 40	C 40	S 40 C			
	E 360	1.0070	1.0535	St 70-2	A 70-2		Fe 690		1655		
	C60	1.0601	1.0601	C 60	CC 55	080 A 62	C 60			G10600	
			1.1157	40 Mn 4	35 M 5	150 M 36				G10390	
	G 28 Mn6	1.1165	1.1165	30 Mn 5		120 M 36		SMn 1 H, SCMn 2		G13300	
	C 35E	1.1181	1.1181	Ck 35	XC 38 H1	080 M 36	C 35	S 35 C	1572		G10340
	C 45E	1.1191	1.1191	Ck 45	XC 42	080 M 46	C 45	S 45 C	1672		G10420
	C 60E	1.1221	1.1221	Ck 60	XC 60	080 A 62	C 60	S 58 C	1665, 1678		G10640
			1.1740	C 60 W	Y3 55			SK 7			
	P5	55 SiCr7	1.7100	1.0904	55 Si 7	55 S 7	250 A 53	55 Si 8		2085, 2090	
			1.2330	35 CrMo 4	34 CD 4	708 A 37	35 CrMo 4			T51620	
			1.2542	45 WCrV 7		BS 1	45 WCrV 8 KU		2710	T41901	
			1.2714	56 NiCrMoV 7		BH 224-5	56 NiCrMoV7-KU	SKT 4		T61206	
			1.5121	46 MnSi 4							
			1.5710	36 NiCr 6	35 NC 6	640 A 35			SNC 236		
			1.5736	36 NiCr 10	35 NC 11		35 NiCr 9	SNC 631 (H)			
36 CrNiMo 4			1.6511	36 CrNiMo 4	40 NCD 3	816 M 40	38 NiCrMo 4 (KB)			G98400	
34 CrNiMo 6		1.6582	1.6582	34 CrNiMo 6	35 NCD 6	817 M 40	35 NiCrMo 6 (KW)	SNCM 447	2541		G43400
34 Cr 4		1.7033	1.7033	34 Cr 4	32 C 4	530 A 32	34 Cr 4 (KB)	SCR 430 (H)			G51320
41 Cr 4		1.7035	1.7035	41 Cr 4	42 C 4	530 M 40	41 Cr 4	SCR 440 (H)			G51400
25 CrMo 4		1.7218	1.7218	25 CrMo 4	25 CD 4 S	708 M 25	25 CrMo 4 (KB)	SCM 425	2225		G41300
42 CrMo 4		1.7225	1.7225	42 CrMo 4	42 CD 4	708 M 40	42 CrMo 4	SCM 440 (H)	2244		G41400
42 CrMo 4		1.7225	1.7225	42 CrMo 4	42 CD 4	708 M 40	42 CrMo 4	SCM 440 (H)	2244		G41400
			1.7361	32 CrMo 12	30 CD 12	722 M 24	32 CrMo 12		2240		
50 CrV 4	1.8159	1.8159	50 CrV 4	50 CV 4	735 A 50	51 CrV 4	SUP 10	2230		H61500	
41 CrAlMo 7 10	1.8509	1.8509	41 CrAlMo 7	40 CAD 6.12	905 M 39	41 CrAlMo 7	SACM 645	2940		K24065	
C 67S	1.1231	1.1231	Ck 67	XC 68	060 A 67	C 70		1770		G10700	
C 100S	1.1274	1.1274	Ck 101		060 A 96		SUP 4	1870		G10950	
C 105U	1.1545	1.1545	C 105 W1	Y1 105		C 100 KU		1880			
		1.1645	C 105 W2	Y1 105		C 100 KU	SK 3				
		1.1663	C 125 W	Y2 120		C 120 KU	SK 2				

Thread turning

MDT

Mini-Shaft™

Thread milling

Thread tapping

Annex

SMG

U.N.E./ I.H.A.	AISI / ASTM	GOST	ČSN	Misc. Brands	Condition	Structure
	1213				Annealed	
	12 L 13				Annealed	
	1108				Annealed	
	11 L 08				Annealed	
					Annealed	
	1140	40			Annealed	
	1146				Annealed	
	1215				Annealed	
	12 L 14				Annealed	
		16D			Annealed	
	A573 Grade 58	18kp	11 378		Annealed	
	A573 Grade 70	St14kP	11 448		Annealed	
	1010	10			Annealed	
F.1110	1015	15			Annealed	
	1020, 1023	20	12 024		Annealed	
		17G1S	11 523		Annealed	
F.1511	1015	15			Annealed	
F.1120	1025	25			Annealed	
					Annealed	
	A204 Grade A		15 020		Annealed	
	4520				Annealed	
	3310, 9314	20X2H4A	16 420		Annealed	
	4320		16 220		Annealed	
					Annealed	
F.1516	5115	12KHN2	14 220		Annealed	
		18HG			Annealed	
	5120	20KH	14 221		Annealed	
	5120 H	20KH			Annealed	
	A182-F11, A182-F12	12KHM	15 121		Annealed	
	A387 Grade 12 Cl. 2				Annealed	
F.155	A182-F22	12KH8	15 313		Annealed	
F.1130	1035	35	12 040		Annealed	
F.5110	1045	45	12 050		Annealed	
	1040	40	12 041		Annealed	
F.1150	1055	55			Annealed	
	1060	60	12 061		Annealed	
	1039	40G			Annealed	
	1330	30G2			Annealed	
F.1135	1035	35			Annealed	
F.1140	1045	45	12 050		Annealed	
F.1150	1064	60			Annealed	
	1060	60			Annealed	
F.144	9255	55S2			Annealed	
F.1250	4135	35KHM			Annealed	
F.5241	S1	5KHV2S			Annealed	
	L6	5KHNV			Annealed	
	5045				Annealed	
	3135				Quenched & Tempered	
	3435				Annealed	
	9840				Quenched & Tempered	
F.1280	4340	38H2N2MA	16 343		Annealed	
	5132	35KH			Quenched & Tempered	
	5140	40H	14 140		Quenched & Tempered	
F.1251	4130	20KHM	15 130		Quenched & Tempered	
F.1252	4142, 4140	38HM	15 142		Annealed	
F.1252	4142, 4140	38HM	15 142		Quenched & Tempered	
					Quenched & Tempered	
F.143	6150	50KHFA	15 260		Quenched & Tempered	
F.1740	A355 Cl. A				Annealed	
F.5103	1070	70			Annealed	
F.5117	1095				Annealed	
F.5118	W1	U10A			Annealed	
		U10			Annealed	
	W1	U13			Annealed	

Thread turning

MDT

Mini-Shaft™

Thread milling

Thread tapping

Annex

SMG

SMG	EN	EN-Nr	W.-Nr	DIN	AFNOR	BS	UNI	JIS	SS	UNS		
P7	107 CrV 3	1.2210	1.2210	115 CrV 3	100 C 3		107 CrV 3 KU			T61202		
			1.2510	100 MnCrV 4	90 MWCV 5	BO 1	95 MnWCr 5 KU	SKS 3	2140	T31501		
	90 MnCrV 8	1.2842	1.2842	90 MnCrV 8	90 MV 8	BO 2	90 MnVCr 8 KU			T31502		
	100 Cr 6	1.3505	1.3505	100 Cr 6	100 C 6	534 A 99	100 Cr 6	SUJ 2	2258	G51986		
P8	X 210 Cr 12	1.2080	1.2080	X 210 Cr 12	Z 200 C 12	BD 3	X 210 Cr 13 KU	SKD 1		T30403		
			1.2343	X 38 CrMoV 5 1	Z 38 CDV 5	BH 11	X 37 CrMoV 5 1 KU	SKD 6		T20811		
	X 40 CrMoV 5 1	1.2344	1.2344	X 40 CrMoV 5 1	Z 40 CDV 5	BH 13	X 40 CrMo 5 1 1 KU	SKD 61	2242	T20813		
	X 100 CrMoV 5	1.2363	1.2363	X 100 CrMoV 5 1	Z 100 CDV 5	BA 2	X 100 CrMoV 5 1 KU	SKD 12	2260	T30102		
			1.2365	X 32 CrMoV 3 3	32 DCV 28	BH 10	30 CrMoV 12 27 KU	SKD 7		T20810		
			1.2436	X 210 CrW 12			X 215 CrW 12 1 KU	SKD 2		2312		
			1.2601	X 165 CrMoV 12			X 165 CrMoW 12 KU			2310		
			1.2713	55 NiCrMoV 6	55 NCDV 7			SKT 4			T61206	
	HS 6-5-2-5	1.3243	1.3243	S 6-5-2-5	Z 85 WDKCV 06-05-04-02		HS 6-5-2-5	SKH 55		2723		
	HS 2-10-1-8	1.3247	1.3247	S 2-10-1-8	Z 110 DKCWV 09-08-04	BM 42	HS 2-9-1-8	SKH 51			T11342	
HS 18-1-2-5	1.3255	1.3255	S 18-1-2-5	Z 80 WKCW 18-05-04-01	BT 4	HS 18-1-1-5	SKH 3			T12004		
HS 6-5-2	1.3343	1.3343	S 6-5-2	Z 85 WDCV 06-05-04-02	BM 2	HS 6-5-2	SKH 9, SKH 51		2722	T11302		
HS 2-9-2	1.3348	1.3348	S 2-9-2	Z 100 DCWV 09-04-02-02		HS 2-9-2	SKH 58		2782	T11307		
HS 18-0-1	1.3355	1.3355	S 18-0-1	Z 80 WCV 18-04-01	BT 1	HS 18-0-1	SKH 2			T12001		
P11	X 6 Cr 13	1.4000	1.4000	X 6 Cr 13	Z 6 C 12	403 S 17	X 6 Cr 13	SUS 403	2301	S41008		
	X 12 Cr 13	1.4006	1.4006	X 10 Cr 13	Z 10 C 13	410 S 21	X 12 Cr 13	SUS 410	2302	S41000		
	X 6 Cr 17	1.4016	1.4016	X 6 Cr 17	Z 8 C 17	430 S 15	X 8 Cr 17	SUS 430	2320	S43000		
	X 20 Cr 13	1.4021	1.4021	X 20 Cr 13	Z 20 C 13	420 S 37	X 20 Cr 13	SUS 420 J 1	2303	S42000		
	X 39 Cr 13	1.4031	1.4031	X 40 Cr 13	Z 40 C 14	420 S 45	X 40 Cr 14	SUS 420	2304	S40280		
	X 70 CrMo 15	1.4109	1.4109	X 65 CrMo 14	Z 70 D 14			SUS 440 A			S44002	
	X 90 CrMoV 18	1.4112	1.4112	X 90 CrMoV 18	Z 2 CND 18 05	409 S 19	X CrTi 12	SUS 440 B	2327	S44003		
	X 105 CrMo 17	1.4125	1.4125	X 105 CrMo 17	Z 100 CD 17		X 105 CrMo 17	SUS 440 C			S44004	
	X 3 CrNiMo 13 3	1.4313	1.4313	X 5 CrNi 13 4	Z 5 CN 13 4	425 C 11	X 6 CrNi 13 04	SCS 5		2385	S41500	
	X 18 CrNi 28	1.4749	1.4749	X 18 CrNi 28	Z 18 C 25					2322	S44600	
	P12	X 6 NiCrTiMoV 25 15	1.4534	1.4534	X 3 CrNiMoAl 13 8 2						S13800	
X 4 CrNiCuNb 16 4		1.4540	1.4540	X 4 CrNiCuNb 16 4						S15500		
		1.4540	1.4540	X 4 CrNiCuNb 16 4	Z 4 CNUNb 16.4 M						S15500	
X 4 CrNiCuNb 16 4		1.4540	1.4540	X 4 CrNiCuNb 16 4							S15500	
X 5 CrNiCuNb 16 4		1.4542	1.4542	X 5 CrNiCuNb 16 4				SUS 630			S17400	
X 5 CrNiCuNb 17 4		1.4548	1.4548	X 5 CrNiCuNb 17 4	Z 6 CNU 17.4			SCS 24, SUS 630			S17400	
X 7 CrNiAl 17 7		1.4564	1.4564	X 7 CrNiAl 17 7	Z 9 CAN 17.7	301 S 81	X 7 CrNiAl 17 7	SUS 631	2388		S17700	
X 2 NiCoMoTi 18 12 4		1.6356	1.6356	X 2 NiCoMoTi 18 12 4							K93160	
X 2 NiCoMoTi 18 9 5		1.6358	1.6358	X 2 NiCoMoTi 18 9 5	Z 2 NKD 19-09						K93120	
X 2 NiCoMo 18 9 5		1.6358	1.6358	X 2 NiCoMoTi 18 9 5	Z 2 NKD 19-09						K93120	
X 2 NiCoMo 18 8 5		1.6359	1.6359	X 2 NiCoMo 18 8 5		S 162					K92890	
X 2 NiCoMo 18 8 5	1.6359	1.6359	X 2 NiCoMo 18 8 5		S 162					K92890		
M1	X 10 CrNiS 18 9	1.4305	1.4305	X 10 CrNiS 18 9	Z 10 CNF 18.09	303 S 31	X 10 CrNi 18 09	SUS 303		2346	S30300	
	X 2 CrNi 19 11	1.4306	1.4306	X 2 CrNi 19 11	Z 2 CN 18.10	304 S 12	X 3 CrNi 18 11	SUS 304 L		2352	S30403	
M2	X 5 CrNi 18 10	1.4301	1.4301	X 5 CrNi 18 10	Z 6 CN 18.09	304 S 31	X 5 CrNi 18 11	SUS 304		2333	S30400	
	X 5 CrNiMo 17 12 2	1.4401	1.4401	X 5 CrNiMo 17 12 2	Z 3 CND 17.11.1	316 S 31	X 5 CrNiMo 17 12	SUS 316		2347	S31600	
	X 6 CrNiNb 18 10	1.4550	1.4550	X 6 CrNiNb 18 10	Z 6 CNNb 18.10	347 S 31	X 6 CrNiNb 18 11	SUS 347		2338	S34700	
	X 9 CrNi 18 8	1.4310	1.4310	X 12 CrNi 17 7	Z 12 CN 17.07	301 S 21	X 12 CrNi 17 07	SUS 301		(2331)	S30100	
	X 12 CrNi 18 8	1.4300	1.4300	X 12 CrNi 18 8	Z 12 CN 18	302 S 25		SUS 302			2331	S30200
	X 2 CrNiMo 18 14 3	1.4435	1.4435	X 2 CrNiMo 18 14 3	Z 2 CND 17.13	316 S 12	X 2 CrNiMo 17 13 2	SCS 16, SUS 316 L			2353	S31603
M3	X 2 CrNiMoN 17 13 3	1.4429	1.4429	X 2 CrNiMoN 17 13 3	Z 2 CND 17.13 Az	316 S 62	X 2 CrNiMoN 17 13 3	SUS 316 LN			2375	S31653
	X 2 CrNiN 18 10	1.4311	1.4311	X 2 CrNiN 19 11	Z 2 CN 18 .10 Az	304 S 62	X 2 CrNiN 18 11	SUS 304 LN			2371	S30453
	X 3 CrNiMo 18 12 3	1.4466	1.4466	X 5 CrNi 18 15		317 S 16	X 5 CrNi 18 15	SUS 317			2366	S31700
	X 9 CrNiSiN 21 11 2	1.4835	1.4893	X 9 CrNiSiN 21 11 2		310 S 31					2368	S30815
	X 12 CrNi 25 21	1.4335	1.4335	X 12 CrNi 25 21	Z 12 CN 25.20	310 S 24	X 6 CrNi 26 20	SUH 310, SUS 310 S			2361	S31008
M4	X 2 CrNiMoN 22 5 3	1.4462	1.4462	X 2 CrNiMoN 22 5	Z 2 CND 22.05 Az	332 S 15	X 2 CrNiMoN 22 5				2377	S31803
	X 2 CrNiMoSi 19 5	1.4424	1.4417	X 2 CrNiMoSi 19 5	Z 2 CND 18.05.03						2376	S31500
	X 2 NiCrMoCu 25 20 5	1.4539	1.4539	X 2 NiCrMoCu 25 20 5	Z 2 NCDU 25 20	904 S 13					2562	N08904
	X 3 CrNiMo 27 5 2	1.4460	1.4460	X 4 CrNiMo 27 5 2	Z 3 CND 25.7 Az		X 3 CrNiMo 27 5 2	SUS 329 J 1			2324	S32900
	X 5 CrNiCuNb 16 4	1.4980	1.4943	X 4 NiCrTi 25 15	Z 6 NCTDV 25.15	HR 51					2570	S66286
M5	X 1 CrNiMoN 20 18 7	1.4547	1.4529	X 1 CrNiMoN 20 18 7	Z 1 CNDU 20.18.05 Az		X 1 CrNiMoN 20 18 7				2778	S31254
	X 1 CrNiMoN 25 22 8	1.4652	1.4652	X 2 CrNiMoN 25 22 7								S32654
	X 10 NiCrAlTi 32 20	1.4876	1.4876	X 10 NiCrAlTi 32 20	Z 10 NC 32.21			NCF 800				N08800
	X 2 CrNiMoN 25 7 4	1.4410	1.4410	X 2 CrNiMoN 25 7 4	Z 3 CND 25.07 Az		X 2 CrNiMoN 25 7 4				2328	S32750

Thread turning

MDT

Mini-Shaft™

Thread milling

Thread tapping

Annex

SMG

U.N.E./I.H.A.	AIISI / ASTM	GOST	ČSN	Misc. Brands	Condition	Structure
F.520L	L2	11KHF			Annealed	
F.5220	O1	9KHVG			Annealed	
	O2	9G2F			Annealed	
F.5230	52100	SHKH15	14 109		Annealed	
F.5212	D3	KH12			Annealed	
	H11	4KH5MFS			Annealed	
F.5318	H13	4KH5MF1S			Annealed	
F.5227	A2	9KH5VF			Annealed	
	H10	3KH3M3F			Annealed	
F.5213		KH12			Annealed	
		KH12MF			Annealed	
F.520.S	L6	5KHNM			Annealed	
F.5613	M35	R6M5K5			Annealed	
	M42	R2AM9K5			Annealed	
	T4	R18K5F2			Annealed	
F.5603	M2	R6M5			Annealed	
	M7				Annealed	
	T1	R18			Annealed	
	403	08KH13			Annealed	Ferritic
F.3401	410, CA-15	12KH13, 08KH13			Annealed	Martensitic
F.3113	430	12KH17			Annealed	Ferritic
F.5261	420	20KH13	17 022		Annealed	Martensitic
F.3404	420	40KH13			Annealed	Martensitic
	440 A				Annealed	Martensitic
	440 B	95KH18			Annealed	Martensitic
	440 C	95KH18			Annealed	Martensitic
	A182 F6NM			F6NM	Annealed	Martensitic
	446	15KH28			Annealed	Ferritic
	XM-13			PH 13-8 Mo	Solution annealed	Austenitic
	XM-12			15-5 PH	H1150	Martensitic
	XM-12			15-5 PH	Solution annealed	Martensitic
	XM-12			15-5 PH	H1025	Martensitic
	SAE 630			17-4 PH	H1150	Martensitic
	630			17-4 PH	Solution annealed	Martensitic
	631	09KH17N7YU1		17-7 PH	Solution annealed	Austenitic/Ferritic
	AMS 6515			Marage 350	Solution annealed	Martensitic
	AMS 6521			Marage 300	Solution annealed	Martensitic
	AMS 6514			Marage 300, Vascomax C300	Solution annealed	Martensitic
	AMS 6512			Marage 250	Solution annealed	Martensitic
	AMS 6512			Marage 250, Vascomax C250	Solution annealed	Martensitic
F.3508	303	12KH19N9			Annealed	Austenitic
F.3504	304 L	03KH18N11			Annealed	Austenitic
F.3504	304	08KH18N10	17 240		Annealed	Austenitic
F.3534	316	08KH17H13M2T	17 346		Annealed	Austenitic
F.3524	347	08KH18N12B			Annealed	Austenitic
F.3517	301	07KH16N6			Annealed	Austenitic
	302	12KH18N9			Annealed	Austenitic
F.3533	(316 L)	03KH17N14M3	17 349		Annealed	Austenitic
	316 LN	03KH16N15M3			Annealed	Austenitic
F.3541	304 LN	03KH18N11			Annealed	Austenitic
	317	08KH17H15M3T			Annealed	Austenitic
				253 MA	Annealed	Austenitic
	310 S	12KH25N20			Annealed	Austenitic
	329 LN			SAF 2205	Annealed	Duplex
				3RE60	Annealed	Duplex
	904L				Annealed	Super austenitic
	329				Annealed	Duplex
	660			A286	Solution annealed	Austenitic
				254 SMO	Annealed	Super austenitic
				654 SMO	Annealed	Super austenitic
				Alloy 800	Annealed	Austenitic
	F 53			SAF 2507	Annealed	Super duplex

Thread turning

MDT

Mini-Shaft™

Thread milling

Thread tapping

Annex

SMG

SMG	EN	EN-Nr	W.-Nr	DIN	AFNOR	BS	UNI	JIS	SS	UNS	
K1	EN-GJL-150	0.6150	0.6150	GG-15	Fl 15 D	Grade 150	G15	FC 150	01 15-00	F11601	
	EN-GJL-200	0.6200	0.6200	GG-20	Fl 20 D	Grade 220	G20	FC 200	01 20-00	F12101	
	EN-GJL-250	0.6250	0.6250	GG-25	Fl 25 D	Grade 260	G25	FC 250	01 25-00	F12401	
	EN-GJL-350	0.6350	0.6350	GG-35	Fl 35 D	Grade 350	G35	FC 350	01 35-00	F13502	
	EN-GJL-215			GG-220 HB					02 19		
K2	EN-GJV-300			GJV-300							
	EN-GJV-350			GJV-350							
	EN-GJV-400			GJV-400							
	EN-GJV-450			GJV-450							
	EN-GJV-500			GJV-500							
K3	EN-GJMB-550-4	0.8155		GTS-55-04	P 540/5	P 540/5	P 55-04	PCMP55-04	08 54-00	F24130	
K4	EN-GJS-350-22	0.7033	0.7033	GGG-35.3	FGS 370-17	Grade 350/22		FCD 350-22L	07 17-15		
	EN-GJS-400-15	0.7040	0.7040	GGG-40	FGS 400-12	Grade 420/12	GS 400-12	FCD 400-18L	07 17-02	F32800	
	EN-GJS-400-18	0.7043	0.7043	GGG-40.3	FGS 370-17	Grade 370/17	GSO 42/17		07 17-12	F32800	
	EN-GJS-500-7	0.7050	0.7050	GGG-50	FGS 500-7	Grade 500/7	GS 500-7	FCD 500-7	07 27-02	F33800	
	EN-GJS-600-3	0.7060	0.7060	GGG-60	FGS 600-3	Grade 600/3	GS 600-3	FCD 600-3	07 32-03	F34100	
	EN-GJS-700-2	0.7070	0.7070	GGG-70	FGS 700-2	Grade 700/2	GS 700-2	FCD 700-2	07 37-01	F34800	
K5	EN-GJS-1000-5			GJS-1000-5						ADI grade 5	
	EN-GJS-1200-2			GJS-1200-2						ADI grade 2	
	EN-GJS-1400-1			GJS-1400-1						ADI grade 3	
	EN-GJS-800-8			GJS-800-8						ADI grade 4	
K6	EN-GJLA-XNiCr 20-2	0.6660	0.6660	GGL-NiCr 20 2	FGL Ni20 Cr2	Grade F2			05 23-00	F41002	
	EN-GJLA-XNiCr 30-3	0.6676	0.6676	GGL-NiCr 30 3	FGL Ni30 Cr3	Grade F3				F41004	
	EN-GJLA-XNiCuCr 15-6-2	0.6655	0.6655	GGL-NiCuCr 15 6 2	FGL Ni15 Cu6 Cr2	Grade F1				F41000	
K7	EN-GJSA-XNiMn 13-7	0.7652	0.7652	GGG-NiMn 13 7	FGS Ni13 Mn7	Grade S6			07 72-00		
	EN-GJSA-XNiCr 20-2	0.7660	0.7660	GGG-NiCr 20 2	FGS Ni20 Cr2	Grade S2				F43000	
	EN-GJSA-XNiMn 23-4	0.7673	0.7673	GGG-NiMn 23 4	FGS Ni23 Mn4	Grade S2M				F43010	
	EN-GJSA-XNiCr 30-3	0.7676	0.7676	GGG-NiCr 30 3	FGS Ni30 Cr3	Grade S3				F43003	
	EN-GJSA-XNi 35	0.7683	0.7683	GGG-Ni 35	FGS Ni35					F43006	
N1	AW-1050A	Al99.5	3.0255	Al99.5	A-5/1050A	1B	(A1050)		4007	AA1050A	
	AW-2011	AlCuBiPb	3.1655	AlCuBiPb	A-U5PbBi/2011	FC1		A2011	4355	AA2011	
	AW-2014	AlCuSiMn	3.1255	AlCuSiMn	A-U4SG/2014	H15			4338	AA2014	
	AW-5005	AlMg1	3.3315	AlMg1	A-G0.6	N41			4106	AA5005	
	AW-6060	AlMgSi0.5	3.3206	AlMgSi0.5	A-GS/6060	(H9)			4103	AA6060	
	AW-6063	AlMgSi0.7	3.3210	AlMgSi0.7	A-GSUC/6061	(H10)	(A6063)		4104, 4107	AA6005	
	AW-3103	AlMn1	3.0515	AlMn1		N3			4054	AA3103	
	AW-3003	AlMn1Cu	3.0517	AlMn1Cu	A-M1/3003			A3003		AA3003	
	AW-7020	AlZn4.5Mg1	3.4335	AlZn4.5Mg1	A-Z5G/7020	H17			4425	AA7020	
	AW-7075		3.4365	AlZnMgCu1.5	A-Z5GU/7075	2L95/2L96			A7075	AA7075	
	AC-42000		3.2341	G-AlSi5Mg	A-S7G	LM25	3599	AC 4C		4244	
	AC-46200	AlSi8Cu3(Si)	3.2161	G-AlSi8Cu3						4251	A13800
	MG-P-63	MgAl6Zn	3.5612	G-MgAl6Zn	G-A6-Z1	MAG-E-121					M11600
	MG-P-61	MgAl8Zn	3.5812	G-MgAl8Zn	(G-A7-Z1)						
	MN65120	MgSe3Zn2Zr1	3.5103	G-MgSe3Zn2Zr1	ZRE1	MAG6-TE					M12330
N2	AC-43400	AlSi10Mg(Fe)	3.2381	G-AlSi10Mg	A-S10G	LM9			4253	A13600	
	AC-44200	AlSi12	3.2382	GD-AlSi12							
	AW-6082	AlMgSi1	3.2315	AlMgSi1	A-SGM0.7/6082	H30			4212	AA6082	
N3				AlSi17Cu5				ADC14			
	CC331G		2.0940.01	CuAl10Fe	CuAl10Fe	AB1			5710	C95200	
N11	CC333G		2.0975.01	CuAl10Ni	CuAl10Ni5Fe5	AB2			5716	C95500	
		CuNi10Fe1Mn	2.0872	CuNi10Fe1Mn	CuNi10Fe1Mn	CN102			5667	C70600	
				CuNi10Zn45							
		CW408J	2.0790	CuNi18Zn19Pb	CuNi18Zn19Pb1						C76300
	CW352H		2.1176	CuPb10Sn	CuSn10Pb10	LB2			5640	C93700	
	CC480K		2.1050.01	CuSn10	CuSn10	CT1			5443	C90700	
			2.1087	CuSn10Zn					5458	C90500	
	CW452K	CuSn6	2.1020	CuSn6	CuSn6	PB103	C5191		5428	C51900	
	CW502L	CuZn15	2.0240	CuZn15	CuZn15	CZ102	C2300		5112	C23000	
	CW706R	CuZn28Sn1	2.0470	CuZn28Sn1	CuZn29Sn1				5220	C44300	
	CW508L	CuZn37	2.0321	CuZn37	CuZn37	CZ108			5150	C27200	
	CW717R	CuZn38Sn1	2.0530	CuZn38Sn1						C46400	
	CW614N	CuZn39Pb3	2.0401	CuZn39Pb3	CuZn39Pb3	CZ121			5170	C38500	
	CW612N	CuZn40Pb2	2.0402	CuZn40Pb2	CuZn39Pb2	CZ120			5168	C37800	
	CW622N	CuZn44Pb2	2.0410	CuZn44Pb2		CZ104			5272	C68700	

Thread turning

MDT

Mini-Shaft™

Thread milling

Thread tapping

Annex

SMG

SMG	EN	EN-Nr	W.-Nr	DIN	AFNOR	BS	UNI	JIS	SS	UNS	
S1											
S2											
S3	NiMo30		2.4810							N10002	
	NiMo16Cr15W		2.4819							N10276	
	NiCr19Fe19Nb5Mo3		2.4668							N07718	
			2.4669							N07750	
	NiCr20TiAl		2.4631							N07080	
	NiCr19Co18Mo4Ti3Al3									N07500	
	NiCr20Co13Mo4Ti3Al			2.4654						N07001	
S11			3.7024							R54620	
S12										R56320	
	TiAl6V4		3.7164							R56400	
S13				TiV10Fe2Al3							
H3	16 MnCr 5	1.7131	1.7131	16 MnCr 5	16 MC 5	527 M 17	16 MnCr 5	SCR 415	2511	G51170	
H5	C 67S	1.1231	1.1231	Ck 67	XC 68	060 A 67	C 70		1770	G10700	
	C 75S	1.1248	1.1248	Ck 75	XC 75	060 A 78	C 75		1774, 1778	G10780	
	C 100S	1.1274	1.1274	Ck 101		060 A 96		SUP 4	1870	G10950	
	C 105U	1.1545	1.1545	C 105 W1	Y1 105		C 100 KU		1880		
			1.2550		60 WCrV 7	55 WC 20		55 WCrV 8 KU			
	55 Cr 3	1.7176	1.7176	55 Cr 3	55 C 3	527 A 60	55 Cr 3	SUP 9 (A)	2253	G51550	
H7	42 CrMo 4	1.7225	1.7225	42 CrMo 4	42 CD 4	708 M 40	42 CrMo 4	SCM 440 (H)	2244	G41400	
	107 CrV 3	1.2210	1.2210	115 CrV 3	100 C 3		107 CrV 3 KU			T61202	
			1.2510		100 MnCrW 4	90 MWCV 5	BO 1	95 MnWCr 5 KU	SKS 3	2140	T31501
	90 MnCrV 8	1.2842	1.2842	90 MnCrV 8	90 MV 8	BO 2	90 MnVCr 8 KU			T31502	
H8	100 Cr 6	1.3505	1.3505	100 Cr 6	100 C 6	534 A 99	100 Cr 6	SUJ 2	2258	G51986	
	X 40 CrMoV 5 1	1.2344	1.2344	X 40 CrMoV 5 1	Z 40 CDV 5	BH 13	X 40 CrMo 5 1 1 KU	SKD 61	2242	T20813	
	X 100 CrMoV 5	1.2363	1.2363	X 100 CrMoV 5 1	Z 100 CDV 5	BA 2	X 100 CrMoV 5 1 KU	SKD 12	2260	T30102	
	X 155 CrVMo 12 1		1.2379	X 155 CrVMo 12 1	Z 160 CDV 12	BD 2	X 155 CrVMo 12 1 KU	SKD 11		T30402	
			1.2436		X 210 CrW 12			X 215 CrW 12 1 KU	SKD 2	2312	
			1.2601		X 165 CrMoV 12			X 165 CrMoV 12 KU		2310	
			1.2713		55 NiCrMoV 6	55 NCDV 7			SKT 4		T61206
	HS 6-5-2-5	1.3243	1.3243	S 6-5-2-5	Z 85 WDKCV 06-05-05-04-02		HS 6-5-2-5	SKH 55	2723		
	HS 2-10-1-8	1.3247	1.3247	S 2-10-1-8	Z 110 DKCWV 09-08-	BM 42	HS 2-9-1-8	SKH 51			T11342
	HS 18-0-1	1.3355	1.3355	S 18-0-1	Z 80 WCV 18-04-01	BT 1	HS 18-0-1	SKH 2			T12001
H11	X 20 Cr 13	1.4021	1.4021	X 20 Cr 13	Z 20 C 13	420 S 37	X 20 Cr 13	SUS 420 J 1	2303	S42000	
	X 70 CrMo 15	1.4109	1.4109	X 65 CrMo 14	Z 70 D 14			SUS 440 A		S44002	
	X 90 CrMoV 18	1.4112	1.4112	X 90 CrMoV 18	Z 2 CND 18 05	409 S 19	X CrTi 12	SUS 440 B	2327	S44003	
	X 105 CrMo 17	1.4125	1.4125	X 105 CrMo 17	Z 100 CD 17		X 105 CrMo 17	SUS 440 C		S44004	
H12	X 4 CrNiCuNb 16 4	1.4540	1.4540	X 4 CrNiCuNb 16 4						S15500	
	X 5 CrNiCuNb 16 4	1.4542	1.4542	X 5 CrNiCuNb 16 4				SUS 630		S17400	
	X 5 CrNiCuNb 16 4	1.4542	1.4542	X 5 CrNiCuNb 16 4				SUS 630		S17400	
	X 7 CrNiAl 17 7	1.4568	1.4568	X 7 CrNiAl 17 7	Z 9 CAN 17.7	301 S 81	X 7 CrNiAl 17 7	SUS 631	2388	S17700	
	X 8 CrNiMoAl 15 7 5	1.4574	1.4574	X 8 CrNiMoAl 15 7 5						S15700	
	X 6 NiCrTiMoV 25 15	1.4980	1.4943	X 4 NiCrTi 25 15	Z 6 NCTDV 25.15	HR 51		SUH 660	2570	S66286	
	X 2 NiCoMo 18 8 5	1.6359	1.6359	X 2 NiCoMo 18 8 5		S 162				K92890	
	X 2 NiCoMoTi 18 9 5	1.6358	1.6358	X 2 NiCoMoTi 18 9 5	Z 2 NKD 19-09					K93120	
	X 2 NiCoMoTi 18 9 5	1.6358	1.6358	X 2 NiCoMoTi 18 9 5	Z 2 NKD 19-09					K93120	
	X 2 NiCoMoTi 18 12 4	1.6356	1.6356	X 2 NiCoMoTi 18 12 4						K93160	
H21	X 120 Mn 12	1.3401	1.3401	X 120 Mn 12	Z 120 M 12	BW 10		SC MnH 1	2183		
H31	EN-GJN-HV520	0.9620	0.9620	G-X330 NiCr 4 2	FB Ni4 Cr2 BC	Grade 2 A			05 12-00	F45001	
	EN-GJN-HV550	0.9625	0.9625	G-X260 NiCr 4 2	FB Ni4 Cr2 HC	Grade 2 B			05 13-00	F45000	
	EN-GJN-HV600(XCr11)	0.9630	0.9630	G-X300 CrNiSi 9 5 2	FB Cr9 Ni5	Grade 2 C, D, E			04 57-00	F45003	

Thread turning

MDT

Mini-Shaft™

Thread milling

Thread tapping

Annex

SMG

U.N.E./ I.H.A.	AISI / ASTM	GOST	ČSN	Misc. Brands	Condition	Structure
				Discolloy	Precipitation hardened	
				Haynes 25		
				Stellite 21		
				Hastelloy C		
		KHN65MV		Hastelloy C-276		
				IN 100		
				Inconel 718		
				Inconel X-750	Solution annealed	
				Nimonic 80A		
				René 41		
				Udimet 500		
				Waspalloy		
				Ti	Commercially pure	Ti (α)
	AMS 4919			Ti 6-2-4-2	Annealed	Ti (α)
	AMS 4943			Ti 3Al-2.5V (grd 9)	Annealed	Ti (α+β)
	AMS 4920, Grade 5	VT6		Ti 6Al-4V	Annealed	Ti (α+β)
	AMS 4986			Ti 10V-2Fe-3Al	Annealed	Ti (β)
F.1516	5115	12KHN2	14 220		Case hardened	
F.5103	1070	70			Quenched & Tempered	
F.5107	1078, 1080	75			Quenched & Tempered	
F.5117	1095				Quenched & Tempered	
F.5118	W1	U10A			Quenched & Tempered	
	S1	5KHV2SF			Quenched & Tempered	
	5155				Quenched & Tempered	
F.1252	4142, 4140	38HM	15 142		Quenched & Tempered	
F.520L	L2	11KHF			Quenched & Tempered	
F.5220	O1	9KHVG			Quenched & Tempered	
	O2	9G2F			Quenched & Tempered	
F.5230	52100	SHKH15	14 109		Quenched & Tempered	
F.5318	H13	4KH5MF1S			Quenched & Tempered	
F.5227	A2	9KH5VF			Quenched & Tempered	
F.5211	D2	KH12MF			Quenched & Tempered	
F.5213		KH12			Quenched & Tempered	
		KH12MF			Quenched & Tempered	
F.520.S	L6	5KHNM			Quenched & Tempered	
F.5613	M35	R6M5K5			Quenched & Tempered	
	M42	R2AM9K5			Quenched & Tempered	
	T1	R18			Quenched & Tempered	
F.5261	420	20KH13	17 022		Quenched & Tempered	Martensitic
	440 A				Quenched & Tempered	Martensitic
	440 B	95KH18			Quenched & Tempered	Martensitic
	440 C	95KH18			Quenched & Tempered	Martensitic
	XM-12			15-5 PH	H900	Martensitic
	SAE 630			17-4 PH	H1025	Martensitic
	SAE 630			17-4 PH	H900	Martensitic
	AMS 5528	09KH17N7YU1		17-7 PH	TH1050	Martensitic
	632			PH 15-7 Mo	TH1050	Martensitic
	660			A286	Precipitation hardened	Austenitic
	AMS 6512			Marage 250	Precipitation hardened	Martensitic
	AMS 6521			Marage 300	Precipitation hardened	Martensitic
	AMS 6521			Marage 300	Precipitation hardened	Martensitic
	AMS 6515			Marage 350	Precipitation hardened	Martensitic
	A128 Grade A			Hadfield		
	A532 IB (NiCr-LC)			Ni-Hard 2		White cast iron
	A532 IA (NiCr-HC)			Ni-Hard 1		White cast iron
	A532 ID (Ni-HiCr)			Ni-Hard 4		White cast iron

Thread turning

MDT

Mini-Shaft™

Thread milling

Thread tapping

Annex

Thread turning

Cemented carbide inserts and insert carriers

Cemented carbide inserts and cemented carbide insert carriers from Seco Tools are not included in the product range intended for the following requirements. Nevertheless Seco Tools can make the following declaration. These products meet all requirements in RoHS (Restriction of the use of certain Hazardous Substances in electrical and electronic equipment), WEEE (Waste Electrical & Electronic Equipment) and ELV (End of Life Vehicles) requirements. Products do not contain mercury, lead, hexavalent chromium, cadmium, CFC, HCFC, flame retardants or solvents in concentrations that exceed specifications in the regulations.

Regrinding:

Wet or dry grinding can produce potentially hazardous dusts or mists that can irritate skin, eyes, nose, throat and result in lung damage or disease. To avoid injury use proper safety precautions and protective equipment.

Disposal:

Seco Tools will buy back used inserts and solid carbide tools for recycling. Inserts and solid carbide tools should be separated from other metal waste (steel, aluminium, copper etc). All packing material is fully recyclable.

MDT

CBN and PCD inserts

Inserts from Seco Tools are not included in the product range intended for the following requirements. Nevertheless Seco Tools can make the following declaration. This product meets all requirements in RoHS (Restriction of the use of certain Hazardous Substances in electrical and electronic equipment), WEEE (Waste Electrical & Electronic Equipment) and ELV (End of Life Vehicles) requirements. Products do not contain mercury, lead, hexavalent chromium, cadmium, CFC, HCFC, flame retardants or solvents in concentrations that exceed specifications in the regulations.

Regrinding:

Wet or dry grinding can produce potentially hazardous dusts or mists that can irritate skin, eyes, nose, throat and result in lung damage or disease. To avoid injury use proper safety precautions and protective equipment.

Disposal:

Seco Tools will buy back used CBN- or PCD-tipped inserts for recycling. Inserts should be separated from other metal waste (steel, aluminium, copper etc). Solid CBN-inserts may be discarded as landfill waste. All packing material is fully recyclable.

Mini-Shaft™

Thread milling

Black oxide insert carriers

Insert carriers from Seco Tools are not included in the product range intended for the following requirements. Nevertheless Seco Tools can make the following declaration. This product meets all requirements in RoHS (Restriction of the use of certain Hazardous Substances in electrical and electronic equipment), WEEE (Waste Electrical & Electronic Equipment) and ELV (End of Life Vehicles) requirements. Products do not contain mercury, lead, hexavalent chromium, cadmium, CFC, HCFC, flame retardants or solvents in concentrations that exceed specifications in the regulations.

Disposal:

Used insert carriers may be sent for recycling together with ordinary steel waste (swarf and discarded steel scrap) for recycling. All packing material is fully recyclable.

Thread tapping

Annex

Cermet inserts

Inserts from Seco Tools are not included in the product range intended for the following requirements. Nevertheless Seco Tools can make the following declaration.

This product meets all requirements in RoHS (Restriction of the use of certain Hazardous Substances in electrical and electronic equipment), WEEE (Waste Electrical & Electronic Equipment) and ELV (End of Life Vehicles) requirements.

Cermet grade C15M inserts do contain nickel and will leach nickel when in contact with the skin. Amount of leaching is higher than specified in norm SS-EN 1811 Reference test method for release of nickel from products intended to come into direct and prolonged contact with the skin. These norms are intended for products that are in direct and prolonged contact with the skin and are therefore not directly applicable for cermet inserts. Persons with known allergic reactions to nickel are advised to wear protective gloves when handling cermet inserts.

Regrinding:

Wet or dry grinding can produce potentially hazardous dusts or mists that can irritate skin, eyes, nose, throat and result in lung damage or disease. To avoid injury use proper safety precautions and protective equipment.

Disposal:

Used inserts may be recycled. Inserts should be separated from other metal waste (steel, aluminium, copper, etc) including cemented carbide inserts. All packing material is fully recyclable.

Nickel coated insert carriers

Insert carriers from Seco Tools are not included in the product range intended for the following requirements. Nevertheless Seco Tools can make the following declaration.

This product meets all requirements in RoHS (Restriction of the use of certain Hazardous Substances in electrical and electronic equipment), WEEE (Waste Electrical & Electronic Equipment) and ELV (End of Life Vehicles) requirements.

Products do not contain mercury, lead, hexavalent chromium, cadmium, CFC, HCFC, flame retardants or solvents in concentrations that exceed specifications in the regulations. Insert carriers do contain nickel and will leach nickel when in contact with the skin. Amount of leaching is not higher than norm SS-EN 1811 Reference test method for release of nickel from products intended to come into direct and prolonged contact with the skin.

These norms are intended for products that are in direct and prolonged contact with the skin and are therefore not directly applicable for insert carriers. Persons with known allergic reactions to nickel are advised to wear protective gloves when handling nickel coated insert carriers.

Disposal:

Used tools maybe sent for recycling together with ordinary steel waste (swarf and discarded steel scrap) for recycling. All packing material is fully recyclable.

Intentionally added alloying elements

Grade	Cemented carbide											Coating						
	W	Ti	Ta	Nb	Co	Cr	Ni	Mo	C	N	Ru	Ti	Al	C	N	O	Si	Nb
CP20	■				■				■			■			■			
CP200	■				■	■			■			■	■		■			
CP300	■	■	■	■	■				■			■	■		■			
CP500	■				■	■			■			■	■		■			
CP600	■				■	■			■			■	■		■			
C15M	■	■	■	■	■		■	■	■									
CF	■				■		■	■	■									
CM	■				■		■	■	■									
DP2000	■				■				■			■	■	■	■	■		
DP3000	■	■	■	■	■				■			■	■	■	■	■		
DS2050	■				■	■			■			■	■	■	■			
DS4050	■				■	■			■			■	■	■	■			■
F15M	■				■	■			■			■	■	■	■			
F25M	■	■	■	■	■				■			■	■	■	■			
F30M	■				■	■			■			■	■	■	■			
F40M	■				■	■			■			■	■	■	■			
HX	■		■		■				■			■	■	■	■			
H02	■		■		■				■			■	■	■	■			
H15	■				■				■			■	■	■	■			
H25	■				■				■			■	■	■	■			
KX	■				■				■			■	■	■	■			
MH1000	■				■				■			■	■	■	■			
MK1500	■		■		■				■			■	■	■	■	■		
MK2050	■		■		■				■			■	■	■	■		■	
MM4500	■				■				■			■	■	■	■			
MP1501	■		■	■	■				■			■	■	■	■			
MP2050	■				■				■		■	■	■	■	■			
MP2501	■		■	■	■				■			■	■	■	■			
MP3000	■				■	■			■			■	■	■	■			
MS2500	■		■	■	■				■			■	■	■	■			
MS2050	■				■	■			■			■	■	■	■			
RX1500	■		■		■		■	■	■			■	■	■	■			■
RX2000	■		■		■				■			■	■	■	■			
RM2020	■				■				■			■	■	■	■			
RM2090	■				■				■			■	■	■	■			
RN2010	■				■				■			■	■	■	■			
RS2090	■				■				■			■	■	■	■			
T350M	■		■	■	■				■			■	■	■	■			
T25M	■		■	■	■				■			■	■	■	■			
TGH1050	■				■				■			■	■	■	■			
TGK1500	■				■				■			■	■	■	■			
TGP25	■	■	■	■	■				■			■	■	■	■			
TGP35	■		■	■	■				■			■	■	■	■			
TGP45	■		■	■	■				■			■	■	■	■			
TGS2050	■				■				■			■	■	■	■			
TH1000	■				■				■			■	■	■	■			
TH1500	■				■				■			■	■	■	■			
TK0501	■				■				■			■	■	■	■			
TK1501	■		■		■				■			■	■	■	■			
TM1501	■	■	■	■	■				■			■	■	■	■			
TM2000	■				■				■			■	■	■	■			
TM2501	■				■				■			■	■	■	■			
TM3501	■				■				■			■	■	■	■			
TM4000	■				■				■			■	■	■	■			
TP0501	■				■	■			■			■	■	■	■			
TP1020	■				■				■			■	■	■	■			
TP1030	■				■				■			■	■	■	■			
TP1501	■				■				■			■	■	■	■			
TP25	■				■	■			■			■	■	■	■			
TP200	■				■				■			■	■	■	■			
TP2501	■				■	■			■			■	■	■	■			
TP3501	■				■				■			■	■	■	■			
TP40	■				■				■			■	■	■	■			
TS2000	■				■				■			■	■	■	■			
TS2050	■				■				■			■	■	■	■			
TS2500	■		■		■				■			■	■	■	■			
TTP2050	■				■				■			■	■	■	■			
T250D	■				■				■			■	■	■	■			
T400D	■				■				■			■	■	■	■			
T100R	■				■				■			■	■	■	■			
T60M	■	■	■	■	■				■			■	■	■	■			
883	■		■		■				■			■	■	■	■			
890	■				■	■			■			■	■	■	■			

This work is published with the understanding that Seco Tools and its editors are supplying information aimed to present a general orientation and direction of metal cutting and related sciences. If professional services are required for specific applications, the assistance of an appropriate professional should be acquired.

The information is provided “as is”; Seco Tools and its editors disclaim all representations and warranties, express or implied, of any kind, including, without limitations, any warranties of merchantability, fitness for a particular purpose, title, or non-infringement. In no event will Seco Tools or its editors be liable to any party for any direct, indirect, special or other consequential damages for any use of the information, even if Seco Tools or its editors are advised of the possibility of such damage.

The information provided herein is for reference purposes only. Actual prices, specifications, and product descriptions are finalised at the time of sale and may vary by location. The information provided herein is subject to change without prior notice.

WWW.SECOTOOLS.COM

70024870, ST20236778 GB,
© SECO TOOLS AB, 2023. All rights reserved.
Technical specifications are subject to
change without notice.