

CATALOG & TECHNICAL GUIDE 2023.1



SOLID END MILLS

>30,000

STANDARD PRODUCTS



>75

COUNTRIES



>4,100

DEDICATED EMPLOYEES



Headquartered in Fagersta, Sweden and present in more than 75 countries, Seco Tools is a leading global provider of metal cutting solutions for milling, stationary tools, holmaking and tooling systems.

For more than 80 years, the company has provided the technologies, processes and support that manufacturers depend on for maximum productivity and profitability. For more information on how Seco's innovative products and expert services bring success to manufacturers across all industry segments, please visit www.secotools.com.

WELCOME TO SECO

SOLID MILLING



JABRO was founded in 1976 in Lottum, Netherlands.

JABRO is Seco's competence centre for solid milling solutions, and has the global responsibility for Research & Development, Manufacturing and Application Engineering.

Seco JABRO's products provide the world market with a wide range of standard tools and custom tool solutions, including reconditioning, mainly for General Engineering, Aerospace, Energy, Medical and Mould & Die customers.

Advanced manufacturing technology and an environmental focus, ensures Seco's sustainable development and production of products that successfully respond to market demands in milling operations for both ferrous and non-ferrous materials.

- General Engineering
- Mould & Die
- Aerospace
- Medical
- Power energy
- 3C segment (Computer Customer Electronics and Communications)

General

Index.....	3-4
Product introduction and technical information	5-28

Universal

Product information and cutting data	29-181
--	--------

Steel and cast iron

Product information and cutting data	182-207
--	---------

Stainless steel and S-materials (HRSA and Titanium alloys)

Product information and cutting data	208-320
--	---------

Non-ferrous

Product information and cutting data	321-365
--	---------

Hardened steels

Product information and cutting data	366-402
--	---------

Plastic and CFRPs

Product information and cutting data	403-455
--	---------

Graphite

Product information and cutting data	456-472
--	---------

X-Heads

Product information and cutting data	473-555
--	---------

Technical information

Recalculation.....	556-563
Cutting calculations and definitions.....	564-565

Minimaster® Plus

Product information and cutting data	566-629
--	---------

Minimaster

Product information and cutting data	630-720
--	---------

SMG

Workpiece Materials - SMG (Seco material group).....	721-733
--	---------

SOLID²

JS412	325-326
JS413	328-329
JS452	331-334, 336, 338-339
JS453	336-339
JS506	123-124
JS509	127-128
JS520	102-103
JS522	106
JS532	111-112
JS533	115-116
JS534	119-120
JS553	52-61
JS554	77
JS554	70-81, 90-91
JS564	94-95
JS565	98-99
JS720	241-251
JS730	254-256
JS754	213-227
JS755	230-239
JSB512	109
JSE512	36-37
JSE513	40-43
JSE514	46-49

TORNADO

JH112	200-201, 384-385
JH120	375
JH130	377
JH142	195-196, 381-382
JH150	204, 388
JH160	206, 390
JH40	345-346
JH410	352
JH421	348-350
JH440	354
JH450	356
JH460	358
JH710	297
JH721	309
JH722	311
JH724	281
JH726	283
JH730	301
JH734	285
JH736	287
JH740	295
JH744	289
JH746	291
JH770	293
JH780	305
JH790	29
JH910	131-132
JH930	135, 379
JHB720	307
JHB970	137, 198

HPM

JHP170	369-370
JHP490	341-343
JHP751	258-259
JHP760	261-263
JHP770	265-270
JHP780	272-275
JHP794	277
JHP951	191-192
JHP993	185-186
JHP994	303

HFM

JHF181	372
JHF980	139-140
SHF712	313

MINI

JM403	362
JM404	362
JM406	362
JM413	364
JM416	364
JMB112	399-401
JMB542	173
JMB562	176-177
JMB563	180
JMB642	471
JMB662	471
JME142	392-395
JME144	397
JME542	163
JME562	166-167
JME564	170
JME642	469
SMB413/414/416	360
SMB614/616	467
SMB713/714/716	317
SME714/716	315

DIAMOND

JD620	459
JD630	461
JD640	463
JD660	465

COMPOSITE

JC845	407
JC850	409
JC860	411
JC870	413-416
JC871	419-422
JC875	425-426
JC876	429-430
JC877	433-434
JC880	437
JC885	439
JC898	441
JC899	443-444
JPD850	446
JPD880	448
JPD890	450

VHM

HK/HKM	149-159
V31	160
J28	454
J29	143
J36	146
J93	452

CERAMIC

JCG790	279
--------	-----

HSS-E

JCO710	319
--------	-----

Minimaster

MM06.....	636-641
MM08.....	651-656
MM10.....	668-674
MM12.....	686-693
MM16.....	705-711

Minimaster Plus

MP10.....	571-579
MP12.....	591-599
MP16.....	611-618

X-Heads

XE-DM.....	482
XE-E.....	480-481
XE-S.....	476-479
XHF580.....	519-520
XHF780.....	525-526
XHT740.....	517
XSB540.....	499
XSB720.....	507-508
XSE450.....	513-514
XSE550.....	483-484, 489-490, 495-496
XSE720.....	501-502
XVB510.....	546-547
XVC506.....	550
XVC509.....	550
XVC512.....	550
XVE510.....	543
XVE540.....	531-532, 537-538
XVK310.....	554

Product family overview

SOLID²



Jabro-Solid² is a range of solid carbide end mills for applications in general machining, offering flexibility, speed and cost efficiency. Jabro-Solid² is available in a diameter range of $\varnothing 1$ - $\varnothing 32$ mm and in *inch* $\varnothing 1/32$ - 1 1/4.

Jabro-Solid² also includes a group of dedicated advanced roughing tools (JS564 and JS565).

The 564 and 565 offer excellent performance when applied in well defined tool paths with constant arc of contact with high cutting speed and high cutting depth applications (advanced roughing).

For the complete range of JS500 series tools all chamfer ($c^{\circ}45^{\circ}$) have the following tolerances: $c = DC \pm 0,01$, $3 < DC \leq 6 \pm 0,02$, $6 < DC \leq 10 \pm 0,03$,

$10 < DC \leq 14 \pm 0,04$, $14 < DC \leq 18 \pm 0,05$, $18 < DC \leq 24 \pm 0,06$,

All Jabro-Solid² product codes begin with JS.

Please see page 9 for a grouped overview of JS² products.

HSM/TORNADO



These tools are characterized by high precision tolerances, short cutting lengths, reduced necks and significant core diameters, maximizing rigidity. These tools have been developed to excel in peripheral milling and copy milling machining methods.

Please see page 9 for a grouped overview of HSM/TORNADO (high speed machining) products.

HPM



Optimized endmills are dedicated for original equipment manufacturers and first-tier suppliers where large batches of a single component have to be machined and where processes need to be fully optimized to reduce cycle times, reducing costs per part.

Please see page 10 for a grouped overview of HPM (high performance machining) products.

HFM



High feed machining is the first choice for applications with deep and shallow workpiece features, 3D profiling for mold & die applications and machining in unstable conditions. High feed tools excel in plunge milling machine methods.

Please see page 10 for a grouped overview of HFM (high feed machining) products.

Product family overview

MINI



Seco's range of micro solid carbide end mills consists of square end mills and ballnose cutters with small cutting diameters. Universal tools are applicable for common workpiece materials and specific tools are dedicated for graphite and hardened-steel applications. All tools have a thin layered coating for optimal performance in small-sized applications.
Please see page 10 for a grouped overview of MINI (micro machining) products.

DIAMOND



Available in a variety of geometries and an extensive diameter range, these tools feature the best possible substrate to ensure the perfect adhesion of the diamond coating across a range of cutting parameters. Overall, these end mills significantly increase productivity and lower tooling costs by requiring fewer tool changes and being able to produce precision parts at high feed rates.
Please see page 10 for a grouped overview of DIAMOND (diamond coated) products.

COMPOSITE



It consists of diamond-coated and uncoated solid carbide and PCD end mills incorporating different geometries as well as with PCD-brazed cutting edges. This is a product range offering optimized tools for difficult cutting conditions on challenging workpiece materials.
Please see page 10 for a grouped overview of COMPOSITE (JC) products.

VHM



Includes universal coated and uncoated endmills, a range of products dedicated for machining plastics and aluminum, chamfer end mills and conical tools. These products consist of high-quality grades and coatings for predictable and premium tool life.
Please see page 11 for a grouped overview of VHM (general engineering) products.

Product family overview

CERAMIC



To cut the world's toughest heat-resistant superalloys (HRSA) quickly, you need a tool just as strong and advanced as the materials themselves. Streamline your processes and cut your HRSA parts considerably faster with these high-performance ceramic solid end mills. Please see page 11 for a grouped overview of CERAMIC products.

HSS-CO



High speed steel cobalt is a premium grade that offers higher performance compared to traditional high speed steels. Due to increased hardness, these end mills last longer in today's abrasive, heat resistant and exotic materials. The high-quality, low-cost production advantages of these end mills are a direct result of engineered flute designs, wear resistant coatings and optimized features like internal coolant channels for these challenging materials. Please see page 11 for a grouped overview of HSS-CO products.

X-Heads



With the Seco exchangeable head milling system, quickly and easily change between various solid carbide milling head profiles and types to optimize all your milling operations while you reduce manufacturing costs and tooling inventories. X-Heads end mills mount to a variety of available shank lengths for even greater versatility, with long-reach capability. End mill changes only require a simple turn of a wrench, and the shank could remain in the machine. Eliminate the need to reset tool lengths thanks to a secure and reliable connection that provides exchange accuracies within 50 microns. Please see page 474 for a grouped overview of X-heads (exchangeable heads) products.

Product family overview

Product family	Technology	Product	1xx	4xx	5xx	6xx	7xx	8xx	9xx
Jabro-Solid²	General machining	JS		■	■		■		
Jabro - HPM	High performance machining	JHP	■	■			■		■
Jabro - HFM	High feed machining	JHF	■						■
Jabro - Mini	Micro machining	JM	■	■	■	■			■
Jabro - HSM/Tornado	High speed machining	JH	■	■			■		■
Jabro - Ceramic	High performance machining	JCG					■		
Jabro - Diamond	Graphite machining	JD				■			
Jabro - Composites	Composite machining	JC, JPD						■	
Jabro - VHM	General machining	J		■					■
Jabro - HSS-E	General machining	JCO					■		
X-Heads - Solid2	High performance machining	XS		■	■		■		
X-Heads - HFM	High feed machining	XHF			■		■		
X-Heads - HSM/Tornado	High speed machining	XH			■		■		
X-Heads - VHM	General machining	XV			■		■		
SMG									
P1-8					■				■
P11-12					■				■
M1-3					■		■		
M4-5					■		■		
K1-7					■				■
S1-3					■		■		
S11-13					■		■		
H			■		■				
N1				■	■				
N2-3				■	■				
N11				■	■				
TS				■				■	
TP				■				■	
GR						■			
For further explanation on SMG (Seco material group) please see page 722									

Summary

	Page	Family name	Name	P1-8	P11-12	M1-3	M4-5	K1-7	N1	N2-3	N11	S1-3	S11-13	H3-31	TS1	TS2-3	TS4	TP1	TP2-3	TP4	Honeycomb	GR	
	36	SOLID ²	JSE512	●	○	●	○	●	○	○	○	○	○	○	○	○			○			○	
	40		JSE513	●	○	●	○	●	○	○	○	○	○	○	○	○	○			○			○
	46		JSE514	●	○	●	○	●	○	○	○	○	○	○	○	○	○			○			○
	109		JSB512	●	○	●	○	●	○	○	○	○	○	○	○	○	○			○			○
	52		JS553	●	○	●	○	●	○	○	○	○	○	○	○	○	○			○			○
	70		JS554	●	○	●	○	●	○	○	○	○	○	○	○	○	○			○			○
	325		JS412	○	○	○	○	○	○	○	○	○	○	○	○	○	○			○			○
	328		JS413	○	○	○	○	○	○	○	○	○	○	○	○	○	○			○			○
	331		JS452	○	○	○	○	○	○	○	○	○	○	○	○	○	○			○			○
	336		JS453	○	○	○	○	○	○	○	○	○	○	○	○	○	○			○			○
	102		JS520	●	○	○	○	○	○	○	○	○	○	○	○	○	○			○			○
	106		JS522	●	○	○	○	○	○	○	○	○	○	○	○	○	○			○			○
	111		JS532	●	○	○	○	○	○	○	○	○	○	○	○	○	○			○			○
	115		JS533	●	○	○	○	○	○	○	○	○	○	○	○	○	○			○			○
	119		JS534	●	○	○	○	○	○	○	○	○	○	○	○	○	○			○			○
	123		JS506	●	○	○	○	○	○	○	○	○	○	○	○	○	○			○			○
	127		JS509	●	○	○	○	○	○	○	○	○	○	○	○	○	○			○			○
	94		JS564	●	○	○	○	○	○	○	○	○	○	○	○	○	○			○			○
	98		JS565	●	○	○	○	○	○	○	○	○	○	○	○	○	○			○			○
	241		JS720	○	○	○	○	○	○	○	○	○	○	○	○	○	○			○			○
	254		JS730	○	○	○	○	○	○	○	○	○	○	○	○	○	○			○			○
	213		JS754	○	○	○	○	○	○	○	○	○	○	○	○	○	○			○			○
	230		JS755	○	○	○	○	○	○	○	○	○	○	○	○	○	○			○			○
345	JH40	HSM/TORNADO	JH40	○	○	○	○	○	○	○	○	○	○	○	○	○			○			○	
200, 385	JH112		○	○	○	○	○	○	○	○	○	○	○	○	○	○			○			○	
375	JH120		○	○	○	○	○	○	○	○	○	○	○	○	○	○			○			○	
377	JH130		○	○	○	○	○	○	○	○	○	○	○	○	○	○			○			○	
195, 382	JH142		●	○	○	○	○	○	○	○	○	○	○	○	○	○			○			○	
388	JH150		○	○	○	○	○	○	○	○	○	○	○	○	○	○			○			○	
390	JH160		●	○	○	○	○	○	○	○	○	○	○	○	○	○			○			○	
352	JH410		○	○	○	○	○	○	○	○	○	○	○	○	○	○			○			○	
348	JH421		○	○	○	○	○	○	○	○	○	○	○	○	○	○			○			○	
354	JH440		○	○	○	○	○	○	○	○	○	○	○	○	○	○			○			○	
356	JH450		○	○	○	○	○	○	○	○	○	○	○	○	○	○			○			○	
358	JH460		○	○	○	○	○	○	○	○	○	○	○	○	○	○			○			○	
297	JH710		○	○	○	○	○	○	○	○	○	○	○	○	○	○			○			○	
307	JHB720		○	○	○	○	○	○	○	○	○	○	○	○	○	○			○			○	
309	JH721		○	○	○	○	○	○	○	○	○	○	○	○	○	○			○			○	
311	JH722		○	○	○	○	○	○	○	○	○	○	○	○	○	○			○			○	
281	JH724		○	○	○	○	○	○	○	○	○	○	○	○	○	○			○			○	
283	JH726		○	○	○	○	○	○	○	○	○	○	○	○	○	○			○			○	
301	JH730		○	○	○	○	○	○	○	○	○	○	○	○	○	○			○			○	
285	JH734		○	○	○	○	○	○	○	○	○	○	○	○	○	○			○			○	
287	JH736		○	○	○	○	○	○	○	○	○	○	○	○	○	○			○			○	
289	JH740		○	○	○	○	○	○	○	○	○	○	○	○	○	○			○			○	
289	JH744		○	○	○	○	○	○	○	○	○	○	○	○	○	○			○			○	
291	JH746	○	○	○	○	○	○	○	○	○	○	○	○	○	○			○			○		
293	JH770	○	○	○	○	○	○	○	○	○	○	○	○	○	○			○			○		
305	JH780	○	○	○	○	○	○	○	○	○	○	○	○	○	○			○			○		
299	JH790	○	○	○	○	○	○	○	○	○	○	○	○	○	○			○			○		
131	JH910	○	○	○	○	○	○	○	○	○	○	○	○	○	○			○			○		
135, 379	JH930	○	○	○	○	○	○	○	○	○	○	○	○	○	○			○			○		
137, 198	JHB970	○	○	○	○	○	○	○	○	○	○	○	○	○	○			○			○		







● Preferred choice, ○ Alternative choice

Summary

	Page	Family name	Name	P1-8	P11-12	M1-3	M4-5	K1-7	N1	N2-3	N11	S1-3	S11-13	H3-31	TS1	TS2-3	TP1	TP2-3	TS2/TP2+N1	TS2/TP2+S12	Honeycomb	GR	
	369	HPM	JHP170												•								
	258		JHP751										•	•									
	261		JHP760			•	•																
	265		JHP770																				
	272		JHP780																				
	277		JHP794				•	•															
	341		JHP490							•	•												
	191		JHP951		•	○				•													
	185		JHP993		•	○				•													
	303		JHP994																				
	372	HFM	JHF181	○	○			•															
	313		SHF712																				
	139		JHF980	•	○	•	•	•						•	•	○							
	399	MINI	JMB112												•								
	392		JME142													•							
	397		JME144													•							
	362		JM403/404/406							•	•												
	364		JM413/416							•	•	•				•		•					
	364		SMB413/414/416							•	•					•		•					
	173		JMB542	•	•	•	•			○	○	○			•	○							○
	176		JMB562	•	•	•	•			○	○	○			•	○							○
	180		JMB563	•	•	•	•			○	○	○			•	○							○
	163		JME542	•	•	•	•			○	○	○			•	○							○
	166		JME562	•	•	•	•			○	○	○			•	○							○
	170		JME564	•	•	•	•			○	○	○			•	○							○
	170		SMB713/714/416																				
	170		JME714/716											•	•								
	471		JMB642/JMB662																				•
	471		JMB662																				•
	469		JME642																				•
467	SMB614/616																				•		
	459	DIAMOND	JD620																			•	
	461		JD630																				•
	463		JD640																				•
	465		JD660																				•
	407	COMPOSITE	JC845													•		•					
	409		JC850													•		•					
	411		JC860													•		•				•	
	413		JC870													•		•				•	
	419		JC871													•		•				•	
	425		JC875													•		•				•	
	429		JC876													•		•				•	
	433		JC877													•		•				•	
	437		JC880													•		•				•	
	439		JC885													•		•				•	
	441		JC898													•		•		•	•		
	443		JC899													•		•		•	•		
	446		JPD850													•		•					
	448		JPD880													•		•					
450	JPD890													•		•							

• Preferred choice, ○ Alternative choice

Summary

	Page	Family name	Name	P1-8	P11-12	M1-3	M4-5	K1-7	N1	N2-3	N11	S1-3	S11-13	H3-31	TS1	TS2-3	TS4	TP1	TP2-3	TP4	Honeycomb	GR		
	454	VHM	J28												•									
	146		J36	○	•	○	○	○	○	•	•	○	○			○			○					
	149		HK/HKM	•		•	•	•	•	•	○		•	•	•	•	•			•				
	160		V31	•	○	•	○	•	•	•	•	•	•	•	•	•	•			•			•	
	143		J29	•	•	•	•	•	•	•	•	•	•	•	•	○	•			•				•
	452		J93F														•			•				
	279	Ceramic	JCG790									•												
	319	HSS-Co	JCO710			•	•						•											
	483-490	X-HEADS SOLID²	XSE550	•	•	•	•	•	•	•	•	•	•	•	•	•			•			○		
	499		XSB540	•	○	•	•	•	•	•	•	•	○	•	○	•			•				○	
	513-514		XSE450							•	•	•				•			•					
	501-502		XSE720	○	•	•	•						•	•										
	507		XSB720	○	•	•	•						•	•										
	289	X-HEADS HSM/TORNADO	XHT740	○	•	•							○	•										
	520	X-HEADS HFM	XHF580	•	•	•	•	•					○	○	○									
	525		XHF780	○	○	•	•						•	•	○									
	538	X-HEADS VHM	XVE540	•	•	•	•	•	•	•	•	○	○	○	•				•			○		
	543		XVE510	•	•	•	•	•	○	○	○	○	○	○	○	•				•			○	
	546-547		XVB510	•	•	•	•	•	○	○	○	○	○	○	○	•				•			○	
	550		XVC506/509/512	•	•	•	•	•	○	○	○	○	○	○	○	•				•			○	
	554		XVK310	•	•	•	•	•	•	•	•	•	○	○	○	•				•			○	

• Preferred choice, ○ Alternative choice

Code keys

Solid end mills

R	JS	720	100	D	2	R050	.0	Z6	C	HXT
1	2	3	5	6	7	8	9	10	11	12

X-Heads – Heads

R	XSE	550	E10	100	D	2	R050	Z4	A	SIRA
1	2	3	4	5	6	7	8	10	11	12

1. Type of product	2. Product range	3. Geometry
BLANK = Standard (catalogue) product R = Reconditioned product (complete) RK = Reconditioned product (frontal)	J = JABRO® VHM JC = JABRO® Composites JD = JABRO® Diamond JH = JABRO® HSM/Tornado JHF = JABRO® HFM JHP = JABRO® HPM JM = JABRO® Mini JS = JABRO® SOLID ²	JPD = JABRO® PCD JCO = JABRO® HSS-Co JCG = JABRO® Ceramic XS* = X-Head SOLID ² XH* = X-Head HSM/Tornado XV* = X-Head VHM XHF = X-Head HFM
		A three-digit combination specifying the cutting geometry. Example: 111, 950, 553, 514, etc.

4. Connection size	5. Cutting diameter
This figure indicates the threading connection size between the head and adaptor E10 = 10 mm E12 = 12 mm E16 = 16 mm E20 = 20 mm E25 = 25 mm	Metric = 3 digit code (in case of 4 digit code – xx,xx mm) Imperial = a dot followed by a 3 digit code Example: (050 = metric, 5 mm) / (.500 = imperial, ½ inch)

6. Tool shape

(DC = DMM)		(DC < DMM)			(DC > DMM)
D	E	F	G	J	P
Form shape					
N	X	T			

7. Length of shape	9. Type of shank
A single digit that gives an indication of the length of the cutter compared to other products with the same cutting geometry.	.0 = Cylindrical .3 = Weldon .5 = Whistle Notch .9 = Safe-Lock

10. Number of flutes	11. Coolant channels	12. Grades																												
This figure indicates the number of flutes in the cutter. Example: PCEDC2= 2 flutes, PCEDC6 = 6 flutes	BLANK = No coolant channels A = Internal coolant channel(s) C = Chip splitters	4 character code specifying the coating on the cutter.																												
		<table border="0"> <tr> <td>MEGA =</td> <td>MEGA</td> <td>DURA =</td> <td>DURA</td> </tr> <tr> <td>MT =</td> <td>MEGA-T</td> <td>NXT =</td> <td>NXT</td> </tr> <tr> <td>M64 =</td> <td>MEGA-64</td> <td>HXT =</td> <td>HXT</td> </tr> <tr> <td>M64 T=</td> <td>MEGA-64-T</td> <td>STAX =</td> <td>STAX</td> </tr> <tr> <td>SIRA =</td> <td>SIRON-A</td> <td>TAN =</td> <td>TAN</td> </tr> <tr> <td>HEMI =</td> <td>HEMI</td> <td>M9 =</td> <td>M9</td> </tr> <tr> <td>DIA =</td> <td>DIAMOND</td> <td>AXT =</td> <td>AXT</td> </tr> </table>	MEGA =	MEGA	DURA =	DURA	MT =	MEGA-T	NXT =	NXT	M64 =	MEGA-64	HXT =	HXT	M64 T=	MEGA-64-T	STAX =	STAX	SIRA =	SIRON-A	TAN =	TAN	HEMI =	HEMI	M9 =	M9	DIA =	DIAMOND	AXT =	AXT
MEGA =	MEGA	DURA =	DURA																											
MT =	MEGA-T	NXT =	NXT																											
M64 =	MEGA-64	HXT =	HXT																											
M64 T=	MEGA-64-T	STAX =	STAX																											
SIRA =	SIRON-A	TAN =	TAN																											
HEMI =	HEMI	M9 =	M9																											
DIA =	DIAMOND	AXT =	AXT																											

8. Tip shape

Sharp	Ball-nose	Corner radius	Concave radius	Chamfer	High feed
S	B	R...	K...	C	H

Size of radius for convex and concave radius tipped products

000 = For metric products the tip shape is shown by a three-digit figure.
By dividing this figure by 100 you will get the actual corner radius size in millimetres.



.000 = For imperial products the tip shape is shown by a dot, followed by a three-digit figure.
This figure actually shows the size of the corner radius in *inch* (e.g. R.100 would indicate a radius of 0.100 *inch*).

Code keys

X-Heads – Shanks

X	E10	100	E	2	- 055 -	00	.0	S
1	2	3	4	5	6	7	8	9

1. Product range	2. Connection size	3. Shank diameter
X = X-Head Cylindrical shank	This figure indicates the threading connection size between the head and adaptor E10 = 10 mm E12 = 12 mm E16 = 16 mm E20 = 20 mm E25 = 25 mm	Metric = 3 digit code Imperial = a dot followed by a 3 digit code Example: (050 = metric, 5 mm) / (.500 = imperial, 1/2 inch)

4. Tool shape		
(DC = DMM)	(DC < DMM)	
 <p>E</p>	 <p>G</p>	 <p>J</p>

5. Length of shape	6. Overall length
A single digit that gives an indication of the length of the cutter compared to other products with the same cutting geometry.	Metric = 3 digit code Imperial = 3 digit code with a dot after the first digit Example: (055 = metric, 55 mm) / (2.50 = imperial, 2 1/2 inch)

7. Taper angle	8. Type of shank	9. Type of material
Indicates the body half taper angle. Example: (00 = 0°; 05 = 5°; 10 = 10°)	.0 = Cylindrical .3 = Weldon .5 = Whistle Notch .9 = Safe-Lock	Indicates the different shank materials that are available. S = Steel DM = Densimate E = Solid Carbide

How our solutions can benefit you

The individual solution - Custom and modified tools



If the requirements are very special, we have the right solution with our individual and customized tools - solutions that have been tailored specifically to your individual requirements. This will enable you to take your machining productivity to a whole new level. In addition to the standard solutions, our offer includes:

Custom tools

They are modified geometries or form shaped tools for customer specific demands as we can fully cooperate with the customer and design a specific tool which answers the needs. Examples can be:

- Modified tools within a standard geometry
- MEP (Mechanised edge Profiling)
- Firtree,
- Dovetail
- Tapered ballnose
- Condyle cutter
- Form shaped tools
- Barrel

Modified tools

Seco offers a quick delivery solution for standard tools requiring modification to meet specific dimensional requirements as this can be:

- (full) Radius/Facet/Chamfer/Concave
- OD reduction (neck reduction), including increased length
- Coating (application for uncoated tools)
- Reduced cutting diameter
- Chip breakers
- Adding Weldon / Safelock
- External coolant channels

Reconditioning cuts cost and tools inventory





Seco's modern carbide tools offer remarkable performance by utilizing the best combinations of carbide substrates with highly wear resistant coatings, optimized cutting geometry and controlled edge preparation.

However good a tool is, as part of its function, it will eventually show signs of wear on the cutting edge. Controlling this wear and the timely replacement of the tool will allow the used tool to be reconditioned, thus reducing tool investment costs. And we use the same advanced technology to recondition your solid carbide tools as we use to manufacture new products.

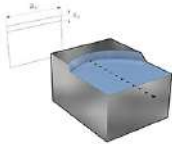

Your benefits from reconditioning

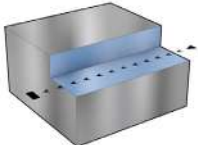
- Manufactured to Seco's high standards with the original Seco geometry, edge preparation and coating processes.
- Savings on tooling costs by repeated use of the same solid carbide tool.
- Our easy to use and free 'reconditioning box' includes a pre-prepared delivery note.
- Free, reliable collection on the following day when you call your Seco contact for pick up.
- An easy process due to the package service, reconditioning box and prepared delivery note.
- Delivery via the normal Seco channels.
- Safe transportation and storage of the reconditioned tools by packaging them in similar packaging as new tools.
- A new packaging label is included.
- Work towards greener and cleaner environment. -Seco's processes are globally certified with ISO14001.
- Guaranteed quality, as all processes are ISO9001 certified.

Basic operations:

Face milling:	Slot milling:
<p>Operation where the tool is in engagement with less than 180° arc of contact. Tool engagement: Small a_p and large a_e.</p> 	<p>Operation where the full diameter is in engagement, a_e is equal to DC and a_p up to 2 times DC depending on the machining strategy in use.</p> 
Side milling:	Copy milling:
<p>Operation where the side of the tool is in engagement, a_p is large and a_e is small.</p> 	<p>Operation where the radius is in engagement. a_p and a_e are both small.</p> 

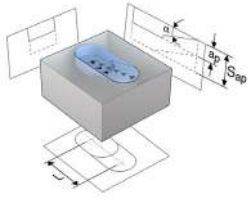
Advanced machining methods:

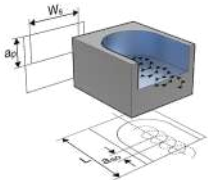
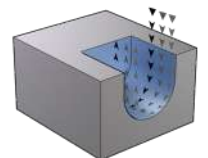
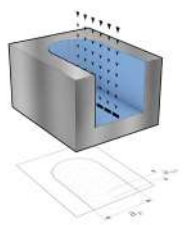
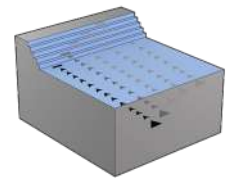
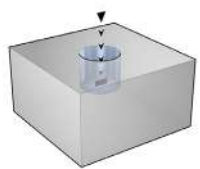
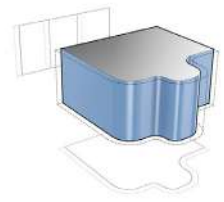
<p>Ramping:</p> <p>Opening up a pocket by making a Z axis at an angle.</p> 	<p>Helical interpolation ramping:</p> <p>Opening a pocket by making a circular movement with the tool while ramping in Z axis.</p> 
<p>Trochoidal:</p> <p>Opening a slot by using side milling, making a partial circular movement in X- or Y-axis. (changing slot milling into side milling).</p> 	<p>Push-pull:</p> <p>Machining a 3D form by making a down and up copying movement following the profile of the form.</p> 
<p>Plunge milling:</p> <p>Opening up a deep slot by using drilling (Z) axis.</p> 	<p>Z-leveling:</p> <p>Machining a surface by making a small drilling or ramping in Z axis then opening the pocket with X and Y movements.</p> 
<p>Drilling:</p> <p>Making a hole with movement in Z axis.</p> 	<p>Advanced roughing/ Optirough</p> <p>Well defined tool paths with constant arc of contact for reliable roughing of simple & complex shapes. The large axial depths (a_p) & small radial depths (a_e) of cut combined with high feeds per tooth (f_z) and cutting speeds (V_c) results in high productivity.</p> 

Definitions, machining strategies:

General machining:

A machining strategy for general use. $a_e - a_p$ ratio can vary depending on the operation.
 Tool characteristics: Tools have relatively long cutting lengths and thin core diameters. There are no high requirements on the tolerances.
 Machine requirements: There are no special machine requirements needed.
 With basic CNC technology, difficult advanced machining methods are not possible.
 Average results will be reached on metal removal rate Q (cm^3/min).
 The application area usually includes small batch sizes and a wide range of materials.

High Performance Machining:

Is a machining strategy where very high metal removal rates can be achieved. Typical for this strategy is that a_e is 1 times DC and a_p is 1 to 1½ times DC depending the workpiece material.
 With HPM (High Performance Machining) you achieve an extremely high metal removal rate by using a much higher chip load than in general machining.
 Tool characteristics: Specially developed chip formers in the flute of the tool, tip protection with a small 45° face or corner radius, special smooth formed chip space and coating, with or without Weldon shank.
 Machine requirements: High stability, high power requirements, CNC control, rigid clamping system.
 The application areas are: Operations in a mass production environment where production time/lead time is of great importance or on single products where a high metal removal rate Q (cm^3/min .) is required.

High Feed Machining:

Is a machining strategy where high feed rates can be reached with large radial engagements (a_e) in combination with a small a_p .
 With HFM (High Feed Machining) you achieve high metal removal rates and/or surface finish by using a much higher table feed compared to general machining.
 Tool characteristics: Specially developed front teeth, very short cutting length and coating.

Machine requirements: Good stability, CNC, possibility for high table feed (v_f).
 The big advantage of this technology is that it is very user friendly, easy, safe and quick to program in CAM. By using the so called Z-leveling strategy it is relatively easy to program complex forms without the necessity of having extensive experience in programming.
 The application area is: From soft to hardened steel, titanium and stainless steel and it is very good as a pre operation before HSM is used.
 It can also be applied in deep pocket machining.

Micro machining:

Is a machining strategy where extremely small tool diameters are used.
 Tool characteristics: Diameter range \varnothing 0,1 to 2,0 mm, small cutting lengths, a wide range of OD reductions, high accuracy, coating.
 Machine requirements: High spindle accuracy, high RPM, CNC, thermal stability against spindle growth.
 Application area is: Production of cavities like slots, pockets, holes or engravings in many types of material.

High speed machining:

Is a machining strategy where a combination of a small radial depth of cut and high cutting speed and table feeds are used.
 Depending on the method a high metal removal and a low R_a value can be reached.
 Typical for this strategy are the low cutting forces, less heat build up in tool and workpiece, less burr formation and high dimensional accuracy on the workpiece.

With HSM (High Speed Machining) you achieve high metal removal rate and/or surface finish by using a much higher cutting speed compared to general machining.
 Tool characteristics: Stable, (thick core diameter and a short cutting length) clear and well formed chip space for good chip evacuation, coating.

Machine requirements: Quick CNC control, high RPM, quick transmission to the axis.
 The applications area is: Mould & Die industry on pre-finishing and finishing operations in hardened steel (48-62 HRC) in a short lead time.
 This technique can also be applied in most other materials when using the right tool and advanced machining method.

Advanced roughing / Optirough:

Well defined tool paths with constant arc of contact for reliable roughing of simple & complex shapes. The large axial depths (a_p) & small radial depths (a_e) of cut combined with high feeds per tooth (f_z) and cutting speeds (V_c) results in high productivity.

These CAM-based rough-machining, or dynamic milling, strategies are ones that centre on a cutting tool's arc of contact and its average chip load.

When reducing the arc of contact, the amount of heat generated during roughing operations is reduced. As the radial depth of cut decreases, so does a cutter's arc of contact. A smaller amount of contact results in less friction and, therefore, less heat between the tool's cutting edges and the workpiece it is machining. These lower machining temperatures, in turn, allow for increased cutting speeds shorter cycle times.

Explanation of Advanced Roughing

Advanced Roughing, what does it mean?

Today's CAM packages offer toolpath strategies specifically for inside/outside radii shapes where changing arcs of contact are common when using conventional toolpaths. These software packages automatically apply different feeds to control arc of contact and keep chip loads consistent.

These CAM-based rough-machining, or advanced roughing, focus on a cutting tool's arc of contact and its average chip load. When reducing the arc of contact, the amount of heat generated during roughing operations is reduced. As the radial depth of cut decreases, so does a cutter's arc of contact. A smaller amount of contact results in less friction and, therefore, less heat between the tool's cutting edges and the workpiece it is machining. These lower machining temperatures, in turn, allow for increased cutting speeds shorter cycle times. Also, the resulting cutting force is lower, allowing high APMXS, or cutting depth to be programmed.

In advanced roughing, to maintain arc of contact, CAM packages need to employ trochoidal machining-like techniques when entering a radius.

When using an optimized roughing toolpath and maintaining consistent arc of contact, the cutter's radius can match that of the inside radius being cut without risk of cutter overload. This capability allows our Advanced Roughing tools (JS554-3C, JS564, JS656, JS754, JS755 and JS720) to remove more stock in the roughing pass, thus reducing the amount of stock the finish pass has to cut – all of which translates to faster machining cycle times and longer tool life. Also, while the remaining stock is constant the finishing tool can generate a better final surface quality and at the same time will have longer tool life.

Impact of arc of contact on cutting speed and feed per tooth

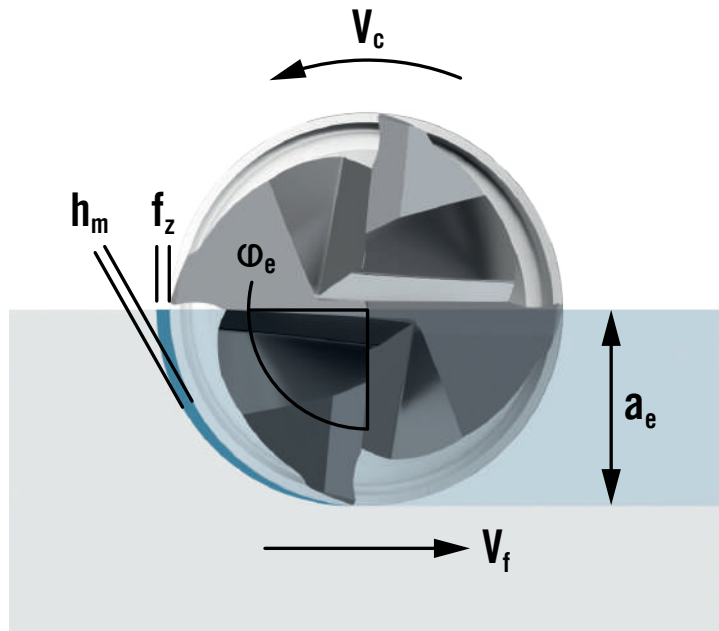

How our products can benefit you

Achieve Revolutionary speeds in superalloys with JABRO® Ceramic end mills

SiAlON ceramics, high-strength geometries and reinforced frontal teeth are some of the main features of these highly optimized tools and allow full utilization of high speed, high-performance machine tools. The tools can operate at cutting speeds of up to 1200M/min and can offer a significant productivity increase when compared to standard solid carbide solutions.

Since high temperatures are needed, also a significant amount of RPM is needed in order to achieve the high vc. The high temperatures are required in order to reach a level where the HRSA softens (850c +). With these tools, multiple strategies can be applied as long as a constant cut and constant contact with the workpiece is maximized.

The tool is designed for side milling, slot milling, high-feed milling and advanced roughing! All these are possible. To maintain the high cutting temperature in the cutting zone, coolant is compressed air. Because the tool operates at high speeds, also run out is of high importance.

You can find JABRO®Ceramic tools on page 279.



Simplify aerospace hybrid materials holemaking with two-in-one-geometry

The JC899 has a patented two-in-one double geometry solution, designed for machining hybrid stacked material combinations such as CFRP-Ti and CFRP-Alu. Due to its left-hand helix, right-hand cut design, this tool is preventing delamination, fiber pull-out and chip marks from damaging the workpiece surface (this as chips will be pushed downwards out of the hole). As a result, the JC899 left-hand helix, right-hand cut STAX finisher gives a perfect surface finish and prevents chip pollution between the 2 stack layers.

This means post-machining, unstacking, cleaning and deburring, and re-stacking is not needed anymore which can boost process efficiency by as much as 200 to 300 percent and provide tool life three to six times longer than that of conventional reamers.

At the same time the drilling process is replaced by applying the JC898 high feed rougher. This tool helical interpolates and allows the JC899 to operate in continuous stock conditions, maximizing quality output while minimizing corellation in hole size and tolerance.

You can find JABRO® JC898/JC899 on pages 441 - 443.



Take bigger stepovers for faster finishing productivity

For the fastest, most reliable finishing operations, new barrel-shaped tools use an innovative “taper” or “drop” geometry to enable large increases in stepover. This is possible through the use of advanced CAD/CAM systems or new plugins built for the uses of these tools. Using 5-axis machine movement, the tool’s cutting profile can remain engaged with the surface of the part at the proper angle at all times.

In addition to our standard barrel-style shapes, Seco can also offer all styles of barrel geometry’s as custom products, such as lens shapes, ensuring you always have access to the ideal tools for your part-production needs.

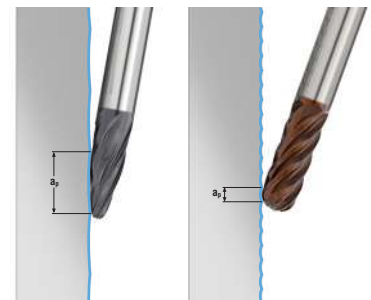

Take the risk out of micro milling operations

Achieve accuracy, precision and high surface finish quality from the very start when machining small, micro-sized surfaces with our range of solid-carbide JABRO® end mills. SECO's new Mini ranges deliver longer tool life, stability and peace of mind for machining operations where it is typically impossible to actually see the workpiece and cutting tool as it works.

Precisely produced geometries, virtually zero runout, advanced coatings and true line-form radius tolerances give these mini ranges its incredibly long tool life and reliability. Key is to apply these tools in suitable conditions, in which the benefits can be maximized. Minimize run-out of the tool plus the tool holder is essential. Also the CAM program can be optimized with the SECO JABRO® feed optimizer which calculates the ideal RPM and feed speed (vf) for every application. As a result, the tool and set-up help to eliminate any unforeseen problems during rough, pre-finish and final finish micro milling operations.

You can find an overview of JABRO®Mini tools on page 10.



JS522 long flute finisher

The JS522 long-flute finishing tool is capable of meeting the aerospace industry's stringent criteria for perpendicularity, fine surface finish, high metal removal rates and more effective machining.

With a cutting length of 5*Dc, an increased core diameter and a slightly negative taper to compensate deflection, the JS522 is specially designed to machine high shoulders in single-pass finishing operations. This single pass saves time (up to 80%) but most important, also delivers instant quality. This tool is often used in mass production areas.

Once in place and optimized, this has proven to be the number one cost saver in multiple applications!

You can find JABRO® JS522 on page 106.



Key symbols

 Center cut PCEDC 1	 Center cut PCEDC 2	 No center cut PCEDC 2	 Center cut PCEDC 3	 No center cut PCEDC 3	 Center cut PCEDC 4
 No center cut PCEDC 4	 Center cut PCEDC 5	 No center cut PCEDC 5	 Center cut PCEDC 6	 No center cut PCEDC 6	 No center cut PCEDC 7
 No center cut PCEDC 8	 No center cut PCEDC 9				
 Cylindrical shank	 Weldon shank	 Safelock shank			
 Sharp	 Chamfer	 Corner radius	 Ball nose	 Tapered sharp	 Tapered ball nose
 Cutter 250°	 T-shape	 Barrel			







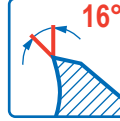











Key symbols

Helix angle 0°	Helix angle 3°	Helix angle 4°	Helix angle 10°	Helix angle 15°	Helix angle 17°	Helix angle 20°
Helix angle 25°	Helix angle 28°	Helix angle 30°	Helix angle 35°	Helix angle 37,5°	Helix angle 38°	Helix angle 40°
Helix angle 41°	Helix angle 42°	Helix angle 44°	Helix angle 45°	Helix angle 46°	Helix angle 48°	Helix angle 50°
Helix angle Left 3°	Helix angle Left 10°	Helix angle Left 15°				Double left hand helix 40° - 10°
Double helix 20° - 20°	Double helix 27° - 25°	Double helix 35° - 25°	Double helix 35° - 30°	Double helix 34° - 36°	Double helix 36° - 40°	Double helix 40° - 42°
Double core	Tapered Core					
Chip splitters	Roughing profile	Router profile				

Key symbols

 Cutting rake 0° Angular relief	 Cutting rake 1° Angular relief	 Cutting rake -1° Angular relief	 Cutting rake 2° Angular relief	 Cutting rake 3° Angular relief	 Cutting rake 4° Angular relief	 Cutting rake 4-6° Angular relief
 Cutting rake 5° Angular relief	 Cutting rake 6° Angular relief	 Cutting rake 7° Angular relief	 Cutting rake 8° Angular relief	 Cutting rake 9° Angular relief	 Cutting rake 10° Angular relief	 Cutting rake 11° Angular relief
 Cutting rake 12° Angular relief	 Cutting rake -12° Angular relief	 Cutting rake 14° Angular relief	 Cutting rake 15° Angular relief	 Cutting rake 16° Angular relief	 Cutting rake 18° Angular relief	 Cutting rake 20° Angular relief
 Cutting rake -24° Angular relief				 Cutting rake 1,5° Radial relief	 Cutting rake 10,5° Radial relief	 Cutting rake 13° Radial relief
 Cutting rake 0° Radial relief	 Cutting rake -1° Radial relief	 Cutting rake 3° Radial relief	 Cutting rake 5° Radial relief	 Cutting rake 6° Radial relief	 Cutting rake 7° Radial relief	 Cutting rake 8° Radial relief
 Cutting rake 10° Radial relief	 Cutting rake 11° Radial relief	 Cutting rake 15° Radial relief	 Cutting rake 16° Radial relief	 Cutting rake 20° Radial relief	 Cutting rake 7-11° Radial relief	
 ICC straight	 ICC and Y					
 Radial	 Radial/Ramping	 Radial/Ramping/Plunging				

Key symbols

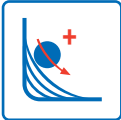
 Diamond	 Dura	 Hemi	 HSCO	 HXT
 Mega	 Mega-T	 Mega-64	 Mega-64-T	 NXT
 Stax	 SIRA	 TAN	 AXT	 Ceramic
 PCD	 M9			
 Regrind possible	 Advanced roughing			

Attributes Solid Milling and X-Heads

Attribute	Explanation
AP1	depth of cut split
APMXS	depth of cut maximum in feed direction side
BHTA	body half taper angle
CA	collision angle
CHW	corner chamfer width
CSP	coolant supply property
CZCMS	connection size code machine side
CZCWS	connection size code workpiece side
DC	cutting diameter
DCSFMS	contact surface diameter machine side
DCSFWS	contact surface diameter workpiece side
DCX	cutting diameter maximum
DMM	shank diameter
DN	neck diameter
FCEDC	face cutting edge count
ICC	internal coolant channel
L	cutting edge length
L2	cutting edge length 2
LF	functional length
LN	neck length
LN2	neck length 2
LSCN	clamping length minimum
NA	neck angle
OAL	overall length
PCEDC	peripheral cutting edge count
PRFA/2	profile angle divided by two
PRFRAD1	profile radius 1
PRFRAD2	profile radius 2
PRFRAD3	profile radius 3
PSIR	tool lead angle
RE	corner radius
RE2	corner radius 2
RP	programming radius
SA	sphere angle
SIG	point angle
SW	wrench size
TQ	torque
TQN	torque minimum
TQX	torque maximum
UTCN	uncut thickness
WDX0	maximum working depth 0 degree
WDX05	maximum working depth 0.5 degree
WDX1	maximum working depth 1 degree
WDX15	maximum working depth 1.5 degree
WDX2	maximum working depth 2 degree
WDX3	maximum working depth 3 degree

Attributes Minimaster

Attribute	Explanation
APMXE	depth of cut maximum in feed direction end
APMXS	depth of cut maximum in feed direction side
AZ	plunge depth maximum
BEC	back end chamfer angle
BHTA	body half taper angle
CCER	curved cutting edge radius
Cmax	helical interpolation hole diameter maximum
Cmin	helical interpolation hole diameter minimum
DC	cutting diameter
DCSFMS	contact surface diameter machine side
DCSFWS	contact surface diameter work piece side
DCX	cutting diameter maximum
DMM	shank diameter
DN	neck diameter
FCEDC	face cutting edge count
FHA	flute helix angle
KAPRS	tool cutting edge angle in feed direction side
LE	cutting edge effective length
LF	functional length
LPR	protruding length
OAL	overall length
RA	relief angle
RE	corner radius
RMPX	ramping angle maximum
RP	programming radius
RPMX	rotational speed maximum
SA	sphere angle
SIG	point angle
UTCN	uncut thickness
ZEFP	peripheral effective cutting edge count



UNIVERSAL

Seco offers a complete range of high performance solid carbide square shoulder end mills, ballnose cutters and finish end mills for high productivity and extended tool life. This range covers universal products and optimized end mills for specific workpiece materials.















Universal products offer full machining flexibility at an excellent price/performance ratio.

- JSE512, JSE513, JSE514, JS553, JS554, JS564, JS565 and JS520 with 45° chamfer type.
- JS522, JS553, JS554, JH910, JH930, JHF980, J36, V31, JME542, JME562 and JME564 for radius type.
- JS506, JS509, HK, HKM and J29 for conical type.
- JSB512, JS532, JS533, JS534, JHB970, JMB542, JMB562 and JMB563 for ball-nose type.

Universal		Tool Selection Universal				
Steel and cast iron						
Stainless steel and S-materials						
Non ferrous						
Hard						
Plastic and cfrp						
Graphite						
X-Heads						
Minimaster Plus						
Minimaster						
Name		JSE512	JSE513	JSE514	JS553	JS554
Page(s)		36	40	46	52	70
Family name		SOLID ²	SOLID ²	SOLID ²	SOLID ²	SOLID ²
Type of mill						
Shank	Cylindrical	■	■	■	■	■
	Weldon	■	■	■	■	■
Number of Flutes		2	3	4	3	4
ICC						
Diameter range	Metric	2-12	2-20	2-25	2-25	3-25
	Inch				1/8 - 1/2	1/4-1
Length availability		2	2,3	2,3	1,2,3	1,2,3
Operation						
SMG						
P1-8		●	●	●	●	●
P11-12		○	○	○	●	●
M1-3		●	●	●	●	●
M4-5		○	○	○	●	●
K1-7		●	●	●	●	●
S1-3		○	○	○	●	●
S11-13		○	○	○	●	●
H3 H5 H8 H11 H12 H21 H31		○	○	○	●	●
N1		○	○	○	●	●
N2-3		○	○	○	●	●
N11		○	○	○	●	●
TS1		○	○	○	●	●
TP1		○	○	○	●	●
GR		○	○	○	○	○

■ Stock standard □ Weldon available, delivery time is 3 days.
 ● Preferred choice ○ Alternative choice
 *JS554 3C also available. Can be applied in advanced roughing.

Tool Selection Unversal

						
Name		JS564	JS565	JS520	JS522	JSB512
Page(s)		94	98	102	106	109
Family name		SOLID ²	SOLID ²	SOLID ²	SOLID ²	SOLID ²
Type of mill						
Shank	Cylindrical	■	■	■	■	■
	Weldon	■	■	□		
Number of Flutes		4	5	5,6,8	2	2
ICC						
Diameter range	Metric		4-20	4-25	6-32	2-12
	Inch					
Length availability		2,3	2,3	2,3	4	2
Operation						
						
						
SMG						
P1-8		●	●	●	●	●
P11-12		○	○	○	●	○
M1-3		●	●	○	●	●
M4-5		●	●	○	●	○
K1-7		●	●	●	●	●
S1-3		●	●	○	○	○
S11-13		●	●	●	●	○
H3 H5 H8 H11 H12 H21 H31		●	●	○		○
N1		●	●	●	●	○
N2-3		●	●	●	●	○
N11		●	●	●	●	○
TS1				●	●	○
TP1				●	●	○
GR				○	○	○

■ Stock standard □ Weldon available, delivery time is 3 days.
 ● Preferred choice ○ Alternative choice

Universal

Steel and cast iron

Stainless steel and S-materials

Non ferrous

Hard

Plastic and cfrp

Graphite















X-Heads

Minimaster Plus

Minimaster

Universal		Tool Selection Universal				
Steel and cast iron						
Stainless steel and S-materials						
Non ferrous						
Hard						
Plastic and cfrp						
Graphite						
X-Heads						
Minimaster Plus						
Minimaster						
Universal						
Name		JS532	JS533	JS534	JS506	JS509
Page(s)		111	115	119	123	127
Family name		SOLID ²	SOLID ²	SOLID ²	SOLID ²	SOLID ²
Type of mill						
Shank	Cylindrical	■	■	■	■	■
	Weldon	□	■	■	■	■
Number of Flutes		2	3	4	3-4	3-4
ICC						
Diameter range	Metric	1-20	1-20	2-20	3-12	3-12
	Inch					
Length availability		1,2,3	1,2	1,2,3	2	2
Operation						
SMG						
P1-8		●	●	●	●	●
P11-12		○	○	○	○	○
M1-3		●	●	●	●	●
M4-5		●	●	●	●	●
K1-7		●	●	●	●	●
S1-3		○	○	○	○	○
S11-13		●	●	●	●	●
H3 H5 H8 H11 H12 H21					●	●
N1		●	●	●	●	●
N2-3		●	●	●	●	●
N11		●	●	●	●	●
TS1		●	●	●	●	●
TP1		●	●	●	●	●
GR		○	○	○	○	○

■ Stock standard □ Weldon available, delivery time is 3 days.
 ● Preferred choice ○ Alternative choice

Tool Selection Universal					
					
Name	JH910	JH930	JHB970	JHF980	
Page(s)	131	135, 379	137, 198	139	
Family name	HSM/TORNADO	HSM/TORNADO	HSM/TORNADO	HFM	
Type of mill					
Shank	Cylindrical	■	■	■	
	Weldon				
Number of Flutes	3	5,6,8	2	2,3,4,5	
ICC					
Diameter range	Metric	2-20	6-20	2-16	1-12
	Inch				
Length availability	2,3,4	2	1,2,3	1,2,3,4	
Operation					
					
					
SMG					
P1-8	●	●	●	●	
P11-12	○	○	○	○	
M1-3	●		●	●	
M4-5	●		●	●	
K1-7	●	●	●	●	
S1-3	●	●	●	●	
S11-13	●	●	●	●	
H3 H5 H7 H8 H11 H12 H21 H31		●		○	
N1					
N2-3					
N11					
TS1					
TP1	●				
GR	●				

■ Stock standard □ Weldon available, delivery time is 3 days.
 ● Preferred choice ○ Alternative choice

Universal

Steel and cast iron

Stainless steel and S-materials

Non ferrous

Hard

Plastic and cfrp

Graphite

X-Heads























Minimaster Plus

Minimaster

Universal		Tool Selection Universal			
Steel and cast iron					
Name		J29	J36	HK/HKM	V31
Page(s)		143	146	149	160
Family name		VHM	VHM	VHM	VHM
Type of mill					
Shank	Cylindrical	■	■	■	■
	Weldon				
Number of Flutes		1	3	2,3,4	4
ICC					
Diameter range	Metric	0,2-6	2-20	1-10	6-28
	Inch				
Length availability		2	2	2	2
Operation					
Graphite					
X-Heads					
Minimaster Plus					
Minimaster					
SMG					
P1-8		●	○	●	●
P11-12		●	●	●	○
M1-3		●	○	●	●
M4-5		●	○	●	○
K1-7		●	○	●	●
S1-3		●	○	●	●
S11-13		●	○	●	●
H3 H5 H8 H11 H12 H21		○		●	●
N1		●	○	●	●
N2-3		●	●	○	●
N11		●	●		●
TS1		●	○	●	●
TP1		●	○	●	●
GR		●			●

■ Stock standard □ Weldon available, delivery time is 3 days.
 ● Preferred choice ○ Alternative choice

Tool Selection Universal

							
Name		JME542	JME562	JME564	JMB542	JMB562	JMB563
Page(s)		163	166	170	173	176	180
Family name		MINI	MINI	MINI	MINI	MINI	MINI
Type of mill							
Shank	Cylindrical	■	■	■	■	■	■
	Weldon						
Number of Flutes		2	2	4	2	2	3
ICC							
Diameter range	Metric	2-20	0,5-3,0	0,5-3,0	0,2-3,0	0,5-3,0	1,0-3,0
	Inch						
Length availability		1,3,4,5,6	2,4,5,6,7	2,4	1,3,4,5,6	1,2,3,4,5,6	2,4
Operation							
							
							
SMG							
P1-8		●	●	●	●	●	●
P11-12		●	●	●	●	●	●
M1-3		●	●	●	●	●	●
M4-5		●	●	●	●	●	●
K1-7							
S1-3							
S11-13		●	●	●	●	●	●
H3 H5 H7 H8 H11 H12 H21 H31		○	○	○	○	○	○
N1		○	○	○	○	○	○
N2-3		○	○	○	○	○	○
N11		○	○	○	○	○	○
TS1							
TP1							
GR		○	○	○	○	○	○

■ Stock standard □ Weldon available, delivery time is 3 days.
● Preferred choice ○ Alternative choice

Universal

Steel and cast iron

Stainless steel and S-materials

Non ferrous

Hard

Plastic and cfrp

Graphite

X-Heads

Minimaster Plus

Minimaster

JSE512

General purpose – Universal – Square – 2 Flutes – Cylindrical – chamfer

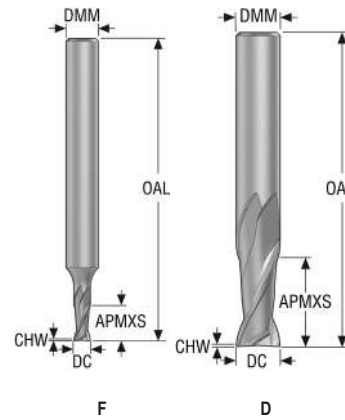

- Tolerances:
- DMM=h5
- DC=e8

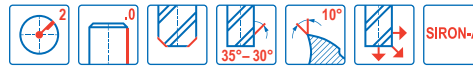

Designation	Grade	Item number	Length index	Tool shape	DC	DMM	APMXS	OAL	CHW	PCEDC	Cylindrical
					mm	mm	mm	mm	mm		
JSE512021F2C.0Z2	SIRA	10052986	2	F	2,0	3,0	4,0	50,0	0,02	2	■
JSE512020F2C.0Z2	SIRA	10052990	2	F	2,0	6,0	4,0	57,0	0,02	2	■
JSE512030D2C.0Z2	SIRA	10052987	2	D	3,0	3,0	6,0	50,0	0,03	2	■
JSE512030F2C.0Z2	SIRA	10052991	2	F	3,0	6,0	6,0	57,0	0,03	2	■
JSE512040D2C.0Z2	SIRA	10052988	2	D	4,0	4,0	8,0	50,0	0,04	2	■
JSE512040F2C.0Z2	SIRA	10052992	2	F	4,0	6,0	8,0	57,0	0,04	2	■
JSE512050D2C.0Z2	SIRA	10052989	2	D	5,0	5,0	10,0	50,0	0,05	2	■
JSE512060D2C.0Z2	SIRA	10052993	2	D	6,0	6,0	12,0	57,0	0,06	2	■
JSE512080D2C.0Z2	SIRA	10052994	2	D	8,0	8,0	16,0	63,0	0,08	2	■
JSE512100D2C.0Z2	SIRA	10052995	2	D	10,0	10,0	20,0	72,0	0,1	2	■
JSE512120D2C.0Z2	SIRA	10052996	2	D	12,0	12,0	24,0	83,0	0,12	2	■

■ Stocked standard.

Universal

Steel and cast iron

Stainless steel and S-materials

Non ferrous

Hard

Plastic and CFRP

Graphite

X-Heads

Minimaster Plus

Minimaster

JSE512

General purpose – Universal – Square – 2 Flutes – Weldon – chamfer

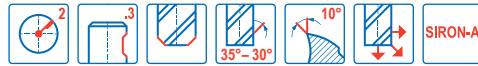
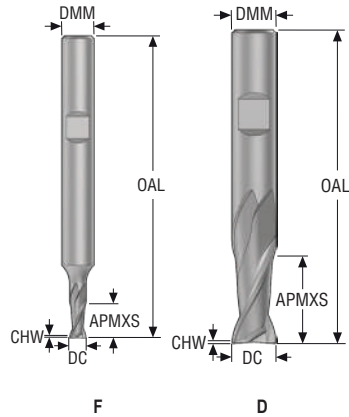

- Tolerances:
- DMM=h5
- DC=e8

Designation	Grade	Item number	Length index	Tool shape	DC	DMM	APMXS	OAL	CHW	PCEDC	Weldon
					mm	mm	mm	mm	mm		
JSE512020F2C.3Z2	SIRA	10053113	2	F	2,0	6,0	4,0	57,0	0,02	2	■
JSE512030F2C.3Z2	SIRA	10053114	2	F	3,0	6,0	6,0	57,0	0,03	2	■
JSE512040F2C.3Z2	SIRA	10053115	2	F	4,0	6,0	8,0	57,0	0,04	2	■
JSE512060D2C.3Z2	SIRA	10053116	2	D	6,0	6,0	12,0	57,0	0,06	2	■
JSE512080D2C.3Z2	SIRA	10053117	2	D	8,0	8,0	16,0	63,0	0,08	2	■
JSE512100D2C.3Z2	SIRA	10053118	2	D	10,0	10,0	20,0	72,0	0,1	2	■
JSE512120D2C.3Z2	SIRA	10053119	2	D	12,0	12,0	24,0	83,0	0,12	2	■

■ Stocked standard.

Universal

Steel and cast iron

Stainless steel and S-materials

Non ferrous

Hard

Plastic and CFRP

Graphite

X-Heads

Minimaster Plus

Minimaster

Cutting data – JSE512 Side milling

SMG		a _e /DC	a _p /DC	f _z								v _c
				2	3	4	5	6	8	10	12	
P1	M/A/D/E	0.250	1.5	0.012	0.018	0.024	0.030	0.036	0.048	0.060	0.070	145 (61 – 180)
		0,250	1,5	0,00048	0,00070	0,00095	0,0012	0,0014	0,0019	0,0024	0,0028	475 (210 – 590)
P2	M/A/D/E	0.250	1.5	0.012	0.018	0.024	0.030	0.036	0.048	0.060	0.070	145 (61 – 180)
		0,250	1,5	0,00048	0,00070	0,00095	0,0012	0,0014	0,0019	0,0024	0,0028	475 (210 – 590)
P3	M/A/D/E	0.250	1.5	0.012	0.018	0.024	0.030	0.036	0.048	0.060	0.070	145 (61 – 180)
		0,250	1,5	0,00048	0,00070	0,00095	0,0012	0,0014	0,0019	0,0024	0,0028	475 (210 – 590)
P4	M/A/D/E	0.250	1.5	0.012	0.018	0.024	0.030	0.036	0.048	0.060	0.070	145 (61 – 180)
		0,250	1,5	0,00048	0,00070	0,00095	0,0012	0,0014	0,0019	0,0024	0,0028	475 (210 – 590)
P5	M/A/D/E	0.250	1.5	0.012	0.018	0.024	0.030	0.036	0.048	0.060	0.070	145 (61 – 180)
		0,250	1,5	0,00048	0,00070	0,00095	0,0012	0,0014	0,0019	0,0024	0,0028	475 (210 – 590)
P6	M/A/D/E	0.250	1.5	0.012	0.018	0.024	0.030	0.036	0.048	0.060	0.070	145 (61 – 180)
		0,250	1,5	0,00048	0,00070	0,00095	0,0012	0,0014	0,0019	0,0024	0,0028	475 (210 – 590)
P7	M/A/D/E	0.250	1.5	0.012	0.018	0.024	0.030	0.036	0.048	0.060	0.070	145 (61 – 180)
		0,250	1,5	0,00048	0,00070	0,00095	0,0012	0,0014	0,0019	0,0024	0,0028	475 (210 – 590)
P8	M/A/D/E	0.250	1.5	0.012	0.018	0.024	0.030	0.036	0.048	0.060	0.070	145 (61 – 180)
		0,250	1,5	0,00048	0,00070	0,00095	0,0012	0,0014	0,0019	0,0024	0,0028	475 (210 – 590)
P11	M/A/D/E	0.250	1.5	0.012	0.018	0.024	0.030	0.036	0.048	0.060	0.070	85 (61 – 120)
		0,250	1,5	0,00048	0,00070	0,00095	0,0012	0,0014	0,0019	0,0024	0,0028	280 (210 – 390)
P12	M/A/D/E	0.250	1.5	0.012	0.018	0.024	0.030	0.036	0.048	0.060	0.070	85 (61 – 120)
		0,250	1,5	0,00048	0,00070	0,00095	0,0012	0,0014	0,0019	0,0024	0,0028	280 (210 – 390)
M1	E/M/A	0.250	1.5	0.012	0.018	0.024	0.030	0.036	0.048	0.060	0.070	85 (61 – 120)
		0,250	1,5	0,00048	0,00070	0,00095	0,0012	0,0014	0,0019	0,0024	0,0028	280 (210 – 390)
M2	E/M/A	0.250	1.5	0.012	0.018	0.024	0.030	0.036	0.048	0.060	0.070	85 (61 – 120)
		0,250	1,5	0,00048	0,00070	0,00095	0,0012	0,0014	0,0019	0,0024	0,0028	280 (210 – 390)
M3	E/M/A	0.250	1.5	0.012	0.018	0.024	0.030	0.036	0.048	0.060	0.070	85 (61 – 120)
		0,250	1,5	0,00048	0,00070	0,00095	0,0012	0,0014	0,0019	0,0024	0,0028	280 (210 – 390)
M4	E/M/A	0.250	1.5	0.012	0.018	0.024	0.030	0.036	0.048	0.060	0.070	85 (61 – 120)
		0,250	1,5	0,00048	0,00070	0,00095	0,0012	0,0014	0,0019	0,0024	0,0028	280 (210 – 390)
M5	E/M/A	0.250	1.5	0.012	0.018	0.024	0.030	0.036	0.048	0.060	0.070	85 (61 – 120)
		0,250	1,5	0,00048	0,00070	0,00095	0,0012	0,0014	0,0019	0,0024	0,0028	280 (210 – 390)
K1	A/D/M/E	0.250	1.5	0.012	0.018	0.024	0.030	0.036	0.048	0.060	0.070	145 (61 – 180)
		0,250	1,5	0,00048	0,00070	0,00095	0,0012	0,0014	0,0019	0,0024	0,0028	475 (210 – 590)
K2	A/D/M/E	0.250	1.5	0.012	0.018	0.024	0.030	0.036	0.048	0.060	0.070	145 (61 – 180)
		0,250	1,5	0,00048	0,00070	0,00095	0,0012	0,0014	0,0019	0,0024	0,0028	475 (210 – 590)
K3	A/D/M/E	0.250	1.5	0.012	0.018	0.024	0.030	0.036	0.048	0.060	0.070	145 (61 – 180)
		0,250	1,5	0,00048	0,00070	0,00095	0,0012	0,0014	0,0019	0,0024	0,0028	475 (210 – 590)
K4	A/D/M/E	0.250	1.5	0.012	0.018	0.024	0.030	0.036	0.048	0.060	0.070	145 (61 – 180)
		0,250	1,5	0,00048	0,00070	0,00095	0,0012	0,0014	0,0019	0,0024	0,0028	475 (210 – 590)
K5	A/D/M/E	0.250	1.5	0.012	0.018	0.024	0.030	0.036	0.048	0.060	0.070	145 (61 – 180)
		0,250	1,5	0,00048	0,00070	0,00095	0,0012	0,0014	0,0019	0,0024	0,0028	475 (210 – 590)
K6	A/D/M/E	0.250	1.5	0.012	0.018	0.024	0.030	0.036	0.048	0.060	0.070	145 (61 – 180)
		0,250	1,5	0,00048	0,00070	0,00095	0,0012	0,0014	0,0019	0,0024	0,0028	475 (210 – 590)
K7	A/D/M/E	0.250	1.5	0.012	0.018	0.024	0.030	0.036	0.048	0.060	0.070	145 (61 – 180)
		0,250	1,5	0,00048	0,00070	0,00095	0,0012	0,0014	0,0019	0,0024	0,0028	475 (210 – 590)
N1	E/M/A	0.200	1.5	0.020	0.030	0.040	0.050	0.060	0.080	0.10	0.12	500 (380 – 630)
		0,200	1,5	0,00080	0,0012	0,0016	0,0020	0,0024	0,0032	0,0040	0,0048	1650 (1300 – 2000)
N11	E/M/A	0.250	1.5	0.012	0.018	0.024	0.030	0.036	0.048	0.060	0.070	365 (250 – 480)
		0,250	1,5	0,00048	0,00070	0,00095	0,0012	0,0014	0,0019	0,0024	0,0028	1200 (830 – 1500)
S11	E	0.250	1.5	0.012	0.018	0.024	0.030	0.036	0.048	0.060	0.070	85 (61 – 120)
		0,250	1,5	0,00048	0,00070	0,00095	0,0012	0,0014	0,0019	0,0024	0,0028	280 (210 – 390)
S12	E	0.250	1.5	0.012	0.018	0.024	0.030	0.036	0.048	0.060	0.070	85 (61 – 120)
		0,250	1,5	0,00048	0,00070	0,00095	0,0012	0,0014	0,0019	0,0024	0,0028	280 (210 – 390)
S13	E	0.250	1.5	0.012	0.018	0.024	0.030	0.036	0.048	0.060	0.070	85 (61 – 120)
		0,250	1,5	0,00048	0,00070	0,00095	0,0012	0,0014	0,0019	0,0024	0,0028	280 (210 – 390)

For cutting data recalculations, see pages 556 - 563

SMG = Seco material group
Coolant = A=air D=dry E=emulsion M=mist spray
v_c = m/min (sf/min)
f_z = mm (in/tooth)
a_p = mm/DC (in/DC) = factor
a_e = mm/DC (in/DC) = factor
All cutting data are target values

Cutting data – JSE512 Slot milling

SMG		a _p /DC	f _z								v _c
			2	3	4	5	6	8	10	12	
P1	M/A/D/E	0.60	0.0060	0.0090	0.012	0.015	0.018	0.024	0.030	0.036	120 (51 – 150)
		0,60	0,00024	0,00036	0,00048	0,00060	0,00070	0,00095	0,0012	0,0014	395 (170 – 490)
P2	M/A/D/E	0.60	0.0060	0.0090	0.012	0.015	0.018	0.024	0.030	0.036	120 (50 – 140)
		0,60	0,00024	0,00036	0,00048	0,00060	0,00070	0,00095	0,0012	0,0014	395 (170 – 450)
P3	M/A/D/E	0.60	0.0060	0.0090	0.012	0.015	0.018	0.024	0.030	0.036	120 (51 – 150)
		0,60	0,00024	0,00036	0,00048	0,00060	0,00070	0,00095	0,0012	0,0014	395 (170 – 490)
P4	M/A/D/E	0.60	0.0060	0.0090	0.012	0.015	0.018	0.024	0.030	0.036	120 (50 – 140)
		0,60	0,00024	0,00036	0,00048	0,00060	0,00070	0,00095	0,0012	0,0014	395 (170 – 450)
P5	M/A/D/E	0.60	0.0060	0.0090	0.012	0.015	0.018	0.024	0.030	0.036	120 (50 – 140)
		0,60	0,00024	0,00036	0,00048	0,00060	0,00070	0,00095	0,0012	0,0014	395 (170 – 450)
P6	M/A/D/E	0.60	0.0060	0.0090	0.012	0.015	0.018	0.024	0.030	0.036	120 (50 – 140)
		0,60	0,00024	0,00036	0,00048	0,00060	0,00070	0,00095	0,0012	0,0014	395 (170 – 450)
P7	M/A/D/E	0.60	0.0060	0.0090	0.012	0.015	0.018	0.024	0.030	0.036	120 (51 – 150)
		0,60	0,00024	0,00036	0,00048	0,00060	0,00070	0,00095	0,0012	0,0014	395 (170 – 490)
P8	M/A/D/E	0.60	0.0060	0.0090	0.012	0.015	0.018	0.024	0.030	0.036	120 (50 – 140)
		0,60	0,00024	0,00036	0,00048	0,00060	0,00070	0,00095	0,0012	0,0014	395 (170 – 450)
P11	M/A/D/E	0.60	0.0060	0.0090	0.012	0.015	0.018	0.024	0.030	0.036	70 (51 – 100)
		0,60	0,00024	0,00036	0,00048	0,00060	0,00070	0,00095	0,0012	0,0014	230 (170 – 320)
P12	M/A/D/E	0.60	0.0060	0.0090	0.012	0.015	0.018	0.024	0.030	0.036	70 (50 – 99)
		0,60	0,00024	0,00036	0,00048	0,00060	0,00070	0,00095	0,0012	0,0014	230 (170 – 320)
M1	E/M/A	0.60	0.0060	0.0090	0.012	0.015	0.018	0.024	0.030	0.036	70 (50 – 99)
		0,60	0,00024	0,00036	0,00048	0,00060	0,00070	0,00095	0,0012	0,0014	230 (170 – 320)
M2	E/M/A	0.60	0.0060	0.0090	0.012	0.015	0.018	0.024	0.030	0.036	70 (50 – 99)
		0,60	0,00024	0,00036	0,00048	0,00060	0,00070	0,00095	0,0012	0,0014	230 (170 – 320)
M3	E/M/A	0.60	0.0060	0.0090	0.012	0.015	0.018	0.024	0.030	0.036	70 (50 – 99)
		0,60	0,00024	0,00036	0,00048	0,00060	0,00070	0,00095	0,0012	0,0014	230 (170 – 320)
M4	E/M/A	0.60	0.0060	0.0090	0.012	0.015	0.018	0.024	0.030	0.036	70 (50 – 99)
		0,60	0,00024	0,00036	0,00048	0,00060	0,00070	0,00095	0,0012	0,0014	230 (170 – 320)
M5	E/M/A	0.60	0.0060	0.0090	0.012	0.015	0.018	0.024	0.030	0.036	70 (50 – 99)
		0,60	0,00024	0,00036	0,00048	0,00060	0,00070	0,00095	0,0012	0,0014	230 (170 – 320)
K1	A/D/M/E	0.60	0.0060	0.0090	0.012	0.015	0.018	0.024	0.030	0.036	120 (50 – 140)
		0,60	0,00024	0,00036	0,00048	0,00060	0,00070	0,00095	0,0012	0,0014	395 (170 – 450)
K2	A/D/M/E	0.60	0.0060	0.0090	0.012	0.015	0.018	0.024	0.030	0.036	120 (50 – 140)
		0,60	0,00024	0,00036	0,00048	0,00060	0,00070	0,00095	0,0012	0,0014	395 (170 – 450)
K3	A/D/M/E	0.60	0.0060	0.0090	0.012	0.015	0.018	0.024	0.030	0.036	120 (50 – 140)
		0,60	0,00024	0,00036	0,00048	0,00060	0,00070	0,00095	0,0012	0,0014	395 (170 – 450)
K4	A/D/M/E	0.60	0.0060	0.0090	0.012	0.015	0.018	0.024	0.030	0.036	120 (50 – 140)
		0,60	0,00024	0,00036	0,00048	0,00060	0,00070	0,00095	0,0012	0,0014	395 (170 – 450)
K5	A/D/M/E	0.60	0.0060	0.0090	0.012	0.015	0.018	0.024	0.030	0.036	120 (50 – 140)
		0,60	0,00024	0,00036	0,00048	0,00060	0,00070	0,00095	0,0012	0,0014	395 (170 – 450)
K6	A/D/M/E	0.60	0.0060	0.0090	0.012	0.015	0.018	0.024	0.030	0.036	120 (50 – 140)
		0,60	0,00024	0,00036	0,00048	0,00060	0,00070	0,00095	0,0012	0,0014	395 (170 – 450)
K7	A/D/M/E	0.60	0.0060	0.0090	0.012	0.015	0.018	0.024	0.030	0.036	120 (50 – 140)
		0,60	0,00024	0,00036	0,00048	0,00060	0,00070	0,00095	0,0012	0,0014	395 (170 – 450)
N1	E/M/A	0.40	0.010	0.015	0.020	0.025	0.030	0.040	0.050	0.060	400 (300 – 500)
		0,40	0,00040	0,00060	0,00080	0,0010	0,0012	0,0016	0,0020	0,0024	1300 (990 – 1600)
N11	E/M/A	0.60	0.0060	0.0090	0.012	0.015	0.018	0.024	0.030	0.036	300 (200 – 390)
		0,60	0,00024	0,00036	0,00048	0,00060	0,00070	0,00095	0,0012	0,0014	980 (660 – 1200)
S11	E	0.60	0.0060	0.0090	0.012	0.015	0.018	0.024	0.030	0.036	70 (50 – 99)
		0,60	0,00024	0,00036	0,00048	0,00060	0,00070	0,00095	0,0012	0,0014	230 (170 – 320)
S12	E	0.60	0.0060	0.0090	0.012	0.015	0.018	0.024	0.030	0.036	70 (50 – 99)
		0,60	0,00024	0,00036	0,00048	0,00060	0,00070	0,00095	0,0012	0,0014	230 (170 – 320)
S13	E	0.60	0.0060	0.0090	0.012	0.015	0.018	0.024	0.030	0.036	70 (50 – 99)
		0,60	0,00024	0,00036	0,00048	0,00060	0,00070	0,00095	0,0012	0,0014	230 (170 – 320)

For cutting data recalculations, see pages 556 - 563

SMG = Seco material group
 Coolant = A=air D=dry E=emulsion M=mist spray
 v_c = m/min (sf/min)
 f_z = mm (in/tooth)
 a_p = mm/DC (in/DC) = factor
 a_s = mm/DC (in/DC) = factor
 All cutting data are target values

Universal
Steel and cast iron
Stainless steel and S-materials
Non ferrous
Hard
Plastic and cfrp
Graphite
X-Heads
Minimaster Plus
Minimaster

JSE513

General purpose – Universal – Square – 3 Flutes – Cylindrical – chamfer

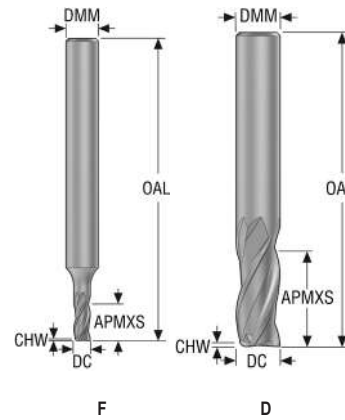

- Tolerances:
- DMM=h5
- DC=e8

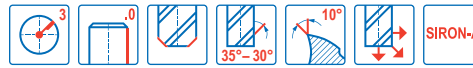

Designation	Grade	Item number	Length index	Tool shape	DC	DMM	APMXS	OAL	CHW	PCEDC	Cylindrical
					mm	mm	mm	mm	mm		
JSE513020F2C.0Z3	SIRA	10053000	2	F	2,0	6,0	4,0	57,0	0,02	3	■
JSE513025F2C.0Z3	SIRA	10053001	2	F	2,5	6,0	5,0	57,0	0,025	3	■
JSE513030D2C.0Z3	SIRA	10052998	2	D	3,0	3,0	6,0	50,0	0,03	3	■
JSE513030F2C.0Z3	SIRA	10053002	2	F	3,0	6,0	6,0	57,0	0,03	3	■
JSE513040D2C.0Z3	SIRA	10052999	2	D	4,0	4,0	8,0	50,0	0,04	3	■
JSE513040F2C.0Z3	SIRA	10053003	2	F	4,0	6,0	8,0	57,0	0,04	3	■
JSE513050F2C.0Z3	SIRA	10053004	2	F	5,0	6,0	10,0	57,0	0,05	3	■
JSE513060D2C.0Z3	SIRA	10053005	2	D	6,0	6,0	12,0	57,0	0,06	3	■
JSE513070F2C.0Z3	SIRA	10053006	2	F	7,0	8,0	14,0	63,0	0,07	3	■
JSE513080D2C.0Z3	SIRA	10053007	2	D	8,0	8,0	16,0	63,0	0,08	3	■
JSE513090F2C.0Z3	SIRA	10053008	2	F	9,0	10,0	18,0	72,0	0,09	3	■
JSE513100D2C.0Z3	SIRA	10053009	2	D	10,0	10,0	20,0	72,0	0,1	3	■
JSE513110F2C.0Z3	SIRA	10053010	2	F	11,0	12,0	22,0	83,0	0,11	3	■
JSE513120D2C.0Z3	SIRA	10053011	2	D	12,0	12,0	24,0	83,0	0,12	3	■
JSE513140D2C.0Z3	SIRA	10053012	2	D	14,0	14,0	28,0	80,0	0,14	3	■
JSE513160D2C.0Z3	SIRA	10053013	2	D	16,0	16,0	32,0	92,0	0,16	3	■
JSE513180D2C.0Z3	SIRA	10053014	2	D	18,0	18,0	35,0	100,0	0,18	3	■
JSE513200D2C.0Z3	SIRA	10053015	2	D	20,0	20,0	35,0	104,0	0,2	3	■
JSE513030F3C.0Z3	SIRA	10053038	3	F	3,0	6,0	10,0	57,0	0,03	3	■
JSE513040F3C.0Z3	SIRA	10053039	3	F	4,0	6,0	14,0	57,0	0,04	3	■
JSE513050F3C.0Z3	SIRA	10053040	3	F	5,0	6,0	18,0	57,0	0,05	3	■
JSE513060D3C.0Z3	SIRA	10053046	3	D	6,0	6,0	20,0	63,0	0,06	3	■
JSE513080D3C.0Z3	SIRA	10053047	3	D	8,0	8,0	28,0	80,0	0,08	3	■
JSE513100D3C.0Z3	SIRA	10053048	3	D	10,0	10,0	35,0	89,0	0,1	3	■
JSE513120D3C.0Z3	SIRA	10053049	3	D	12,0	12,0	42,0	100,0	0,12	3	■
JSE513160D3C.0Z3	SIRA	10053050	3	D	16,0	16,0	50,0	115,0	0,16	3	■
JSE513200D3C.0Z3	SIRA	10053052	3	D	20,0	20,0	60,0	125,0	0,2	3	■

■ Stocked standard.

Universal

Steel and cast iron

Stainless steel and S-materials

Non ferrous

Hard

Plastic and CFRP

Graphite

X-Heads

Minimaster Plus

Minimaster

JSE513

General purpose – Universal – Square – 3 Flutes – Cylindrical – Corner radius

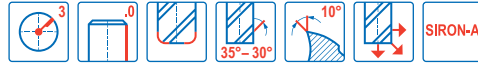
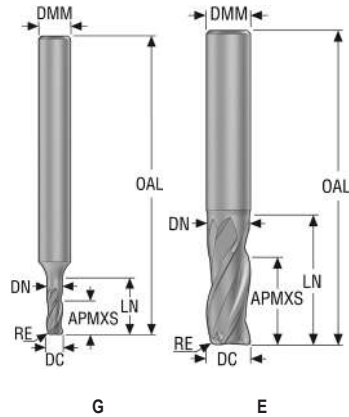

- Tolerances:
- DMM=h5
- DC=e8
- RE= ±0,05 mm

Designation	Grade	Item number	Length index	Tool shape	DC	DMM	APMXS	OAL	LN	DN	RE	PCEDC	Cylindrical
					mm	mm	mm	mm	mm	mm	mm		
JSE513030G2R050.0Z3	SIRA	10053023	2	G	3,0	6,0	6,0	57,0	10,0	2,85	0,5	3	■
JSE513040G2R050.0Z3	SIRA	10053024	2	G	4,0	6,0	8,0	57,0	13,0	3,8	0,5	3	■
JSE513050G2R050.0Z3	SIRA	10053025	2	G	5,0	6,0	10,0	57,0	16,0	4,75	0,5	3	■
JSE513060E2R050.0Z3	SIRA	10053026	2	E	6,0	6,0	12,0	57,0	18,0	5,7	0,5	3	■
JSE513060E2R100.0Z3	SIRA	10053032	2	E	6,0	6,0	12,0	57,0	18,0	5,7	1,0	3	■
JSE513080E2R050.0Z3	SIRA	10053027	2	E	8,0	8,0	16,0	63,0	25,0	7,6	0,5	3	■
JSE513080E2R100.0Z3	SIRA	10053033	2	E	8,0	8,0	16,0	63,0	25,0	7,6	1,0	3	■
JSE513100E2R050.0Z3	SIRA	10053028	2	E	10,0	10,0	20,0	72,0	29,0	9,5	0,5	3	■
JSE513100E2R100.0Z3	SIRA	10053034	2	E	10,0	10,0	20,0	72,0	29,0	9,5	1,0	3	■
JSE513120E2R050.0Z3	SIRA	10053029	2	E	12,0	12,0	24,0	83,0	35,0	11,4	0,5	3	■
JSE513120E2R100.0Z3	SIRA	10053035	2	E	12,0	12,0	24,0	83,0	35,0	11,4	1,0	3	■
JSE513160E2R050.0Z3	SIRA	10053030	2	E	16,0	16,0	32,0	92,0	42,0	15,2	0,5	3	■
JSE513160E2R100.0Z3	SIRA	10053036	2	E	16,0	16,0	28,0	92,0	42,0	15,2	1,0	3	■
JSE513200E2R050.0Z3	SIRA	10053031	2	E	20,0	20,0	35,0	104,0	51,0	19,0	0,5	3	■
JSE513200E2R100.0Z3	SIRA	10053037	2	E	20,0	20,0	35,0	104,0	51,0	19,0	1,0	3	■

■ Stocked standard.

Universal

Steel and cast iron

Stainless steel and S-materials

Non ferrous

Hard

Plastic and CFRP

Graphite

X-Heads

Minimaster Plus

Minimaster

JSE513

General purpose – Universal – Square – 3 Flutes – Weldon – chamfer

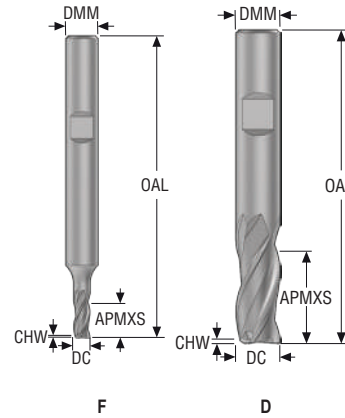

- Tolerances:
- DMM=h5
- DC=e8

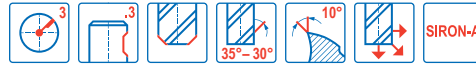

Designation	Grade	Item number	Length index	Tool shape	DC	DMM	APMXS	OAL	CHW	PCEDC	Weldon
					mm	mm	mm	mm	mm		
JSE513020F2C.3Z3	SIRA	10053120	2	F	2,0	6,0	4,0	57,0	0,02	3	■
JSE513025F2C.3Z3	SIRA	10053121	2	F	2,5	6,0	5,0	57,0	0,025	3	■
JSE513030F2C.3Z3	SIRA	10053122	2	F	3,0	6,0	6,0	57,0	0,03	3	■
JSE513040F2C.3Z3	SIRA	10053123	2	F	4,0	6,0	8,0	57,0	0,04	3	■
JSE513050F2C.3Z3	SIRA	10053124	2	F	5,0	6,0	10,0	57,0	0,05	3	■
JSE513060D2C.3Z3	SIRA	10053125	2	D	6,0	6,0	12,0	57,0	0,06	3	■
JSE513070F2C.3Z3	SIRA	10053126	2	F	7,0	8,0	14,0	63,0	0,07	3	■
JSE513080D2C.3Z3	SIRA	10053127	2	D	8,0	8,0	16,0	63,0	0,08	3	■
JSE513090F2C.3Z3	SIRA	10053128	2	F	9,0	10,0	18,0	72,0	0,09	3	■
JSE513100D2C.3Z3	SIRA	10053129	2	D	10,0	10,0	20,0	72,0	0,1	3	■
JSE513110F2C.3Z3	SIRA	10053130	2	F	11,0	12,0	22,0	83,0	0,11	3	■
JSE513120D2C.3Z3	SIRA	10053131	2	D	12,0	12,0	24,0	83,0	0,12	3	■
JSE513140D2C.3Z3	SIRA	10053132	2	D	14,0	14,0	28,0	80,0	0,14	3	■
JSE513160D2C.3Z3	SIRA	10053133	2	D	16,0	16,0	32,0	92,0	0,16	3	■
JSE513180D2C.3Z3	SIRA	10053258	2	D	18,0	18,0	35,0	100,0	0,18	3	■
JSE513200D2C.3Z3	SIRA	10053259	2	D	20,0	20,0	35,0	104,0	0,2	3	■
JSE513030F3C.3Z3	SIRA	10053275	3	F	3,0	6,0	10,0	57,0	0,03	3	■
JSE513040F3C.3Z3	SIRA	10053276	3	F	4,0	6,0	14,0	57,0	0,04	3	■
JSE513050F3C.3Z3	SIRA	10053277	3	F	5,0	6,0	18,0	57,0	0,05	3	■
JSE513060D3C.3Z3	SIRA	10053283	3	D	6,0	6,0	20,0	63,0	0,06	3	■
JSE513080D3C.3Z3	SIRA	10053284	3	D	8,0	8,0	28,0	80,0	0,08	3	■
JSE513100D3C.3Z3	SIRA	10053285	3	D	10,0	10,0	35,0	89,0	0,1	3	■
JSE513120D3C.3Z3	SIRA	10053286	3	D	12,0	12,0	42,0	100,0	0,12	3	■
JSE513160D3C.3Z3	SIRA	10053287	3	D	16,0	16,0	50,0	115,0	0,16	3	■
JSE513200D3C.3Z3	SIRA	10053288	3	D	20,0	20,0	60,0	125,0	0,2	3	■

■ Stocked standard.

Universal

Steel and cast iron

Stainless steel and S-materials

Non ferrous

Hard

Plastic and CFRP

Graphite

X-Heads

Minimaster Plus

Minimaster

JSE513

General purpose – Universal – Square – 3 Flutes – Weldon – Corner radius

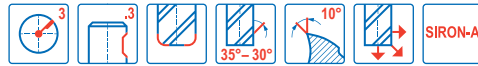
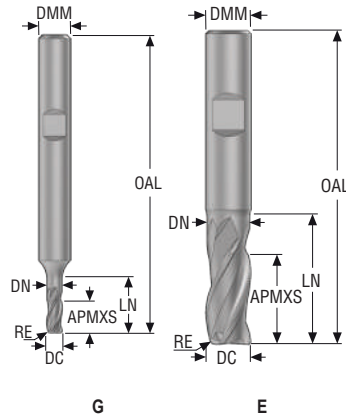

- Tolerances:
- DMM=h5
- DC=e8
- RE= ±0,05 mm

Designation	Grade	Item number	Length index	Tool shape	DC	DMM	APMXS	OAL	LN	DN	RE	PCEDC	Weldon
					mm	mm	mm	mm	mm	mm	mm		
JSE513030G2R050.3Z3	SIRA	10053260	2	G	3,0	6,0	6,0	57,0	10,0	2,85	0,5	3	■
JSE513040G2R050.3Z3	SIRA	10053261	2	G	4,0	6,0	8,0	57,0	13,0	3,8	0,5	3	■
JSE513050G2R050.3Z3	SIRA	10053262	2	G	5,0	6,0	10,0	57,0	16,0	4,75	0,5	3	■
JSE513060E2R050.3Z3	SIRA	10053263	2	E	6,0	6,0	12,0	57,0	18,0	5,7	0,5	3	■
JSE513060E2R100.3Z3	SIRA	10053269	2	E	6,0	6,0	12,0	57,0	18,0	5,7	1,0	3	■
JSE513080E2R050.3Z3	SIRA	10053264	2	E	8,0	8,0	16,0	63,0	25,0	7,6	0,5	3	■
JSE513080E2R100.3Z3	SIRA	10053270	2	E	8,0	8,0	16,0	63,0	25,0	7,6	1,0	3	■
JSE513100E2R050.3Z3	SIRA	10053265	2	E	10,0	10,0	20,0	72,0	29,0	9,5	0,5	3	■
JSE513100E2R100.3Z3	SIRA	10053271	2	E	10,0	10,0	20,0	72,0	29,0	9,5	1,0	3	■
JSE513120E2R050.3Z3	SIRA	10053266	2	E	12,0	12,0	24,0	83,0	35,0	11,4	0,5	3	■
JSE513120E2R100.3Z3	SIRA	10053272	2	E	12,0	12,0	24,0	83,0	35,0	11,4	1,0	3	■
JSE513160E2R050.3Z3	SIRA	10053267	2	E	16,0	16,0	32,0	92,0	42,0	15,2	0,5	3	■
JSE513160E2R100.3Z3	SIRA	10053273	2	E	16,0	16,0	28,0	92,0	42,0	15,2	1,0	3	■
JSE513200E2R050.3Z3	SIRA	10053268	2	E	20,0	20,0	35,0	104,0	51,0	19,0	0,5	3	■
JSE513200E2R100.3Z3	SIRA	10053274	2	E	20,0	20,0	35,0	104,0	51,0	19,0	1,0	3	■

■ Stocked standard.

Universal

Steel and cast iron

Stainless steel and S-materials

Non ferrous

Hard

Plastic and CFRP

Graphite

X-Heads

Minimaster Plus

Minimaster

JSE514

General purpose – Universal – Square – 4 Flutes – Cylindrical – chamfer

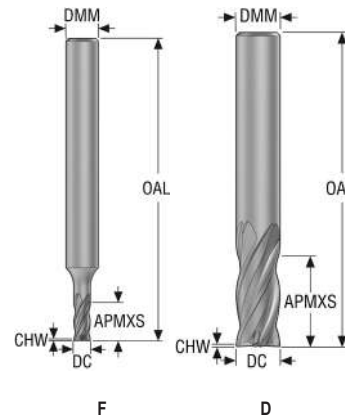

- Tolerances:
- DMM=h5
- DC=e8

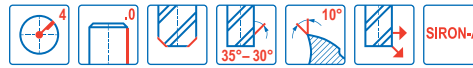

Designation	Grade	Item number	Length index	Tool shape	DC	DMM	APMXS	OAL	CHW	PCEDC	Cylindrical
					mm	mm	mm	mm	mm		
JSE514021F2C.0Z4	SIRA	10053053	2	F	2,0	3,0	4,0	50,0	0,02	4	■
JSE514020F2C.0Z4	SIRA	10053057	2	F	2,0	6,0	4,0	57,0	0,02	4	■
JSE514030D2C.0Z4	SIRA	10053054	2	D	3,0	3,0	6,0	50,0	0,03	4	■
JSE514030F2C.0Z4	SIRA	10053058	2	F	3,0	6,0	6,0	57,0	0,03	4	■
JSE514040D2C.0Z4	SIRA	10053055	2	D	4,0	4,0	8,0	50,0	0,04	4	■
JSE514040F2C.0Z4	SIRA	10053059	2	F	4,0	6,0	8,0	57,0	0,04	4	■
JSE514050D2C.0Z4	SIRA	10053056	2	D	5,0	5,0	10,0	50,0	0,05	4	■
JSE514050F2C.0Z4	SIRA	10053060	2	F	5,0	6,0	10,0	57,0	0,05	4	■
JSE514060D2C.0Z4	SIRA	10053061	2	D	6,0	6,0	12,0	57,0	0,06	4	■
JSE514080D2C.0Z4	SIRA	10053062	2	D	8,0	8,0	16,0	63,0	0,08	4	■
JSE514100D2C.0Z4	SIRA	10053063	2	D	10,0	10,0	20,0	72,0	0,1	4	■
JSE514120D2C.0Z4	SIRA	10053064	2	D	12,0	12,0	24,0	83,0	0,12	4	■
JSE514160D2C.0Z4	SIRA	10053067	2	D	16,0	16,0	32,0	92,0	0,16	4	■
JSE514180D2C.0Z4	SIRA	10053068	2	D	18,0	18,0	35,0	100,0	0,18	4	■
JSE514200D2C.0Z4	SIRA	10053069	2	D	20,0	20,0	35,0	104,0	0,2	4	■
JSE514250D2C.0Z4	SIRA	10053070	2	D	25,0	25,0	40,0	125,0	0,25	4	■
JSE514030F3C.0Z4	SIRA	10053090	3	F	3,0	6,0	10,0	57,0	0,03	4	■
JSE514040F3C.0Z4	SIRA	10053091	3	F	4,0	6,0	14,0	57,0	0,04	4	■
JSE514050F3C.0Z4	SIRA	10053092	3	F	5,0	6,0	18,0	57,0	0,05	4	■
JSE514060D3C.0Z4	SIRA	10053093	3	D	6,0	6,0	20,0	63,0	0,06	4	■
JSE514080D3C.0Z4	SIRA	10053094	3	D	8,0	8,0	28,0	80,0	0,08	4	■
JSE514100D3C.0Z4	SIRA	10053095	3	D	10,0	10,0	35,0	89,0	0,1	4	■
JSE514120D3C.0Z4	SIRA	10053096	3	D	12,0	12,0	42,0	100,0	0,12	4	■
JSE514160D3C.0Z4	SIRA	10053097	3	D	16,0	16,0	50,0	115,0	0,16	4	■
JSE514200D3C.0Z4	SIRA	10053098	3	D	20,0	20,0	60,0	125,0	0,2	4	■

■ Stocked standard.

Universal

Steel and cast iron

Stainless steel and S-materials

Non ferrous

Hard

Plastic and CFRP

Graphite

X-Heads

Minimaster Plus

Minimaster

JSE514

General purpose – Universal – Square – 4 Flutes – Cylindrical – Corner radius

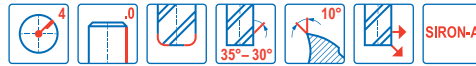
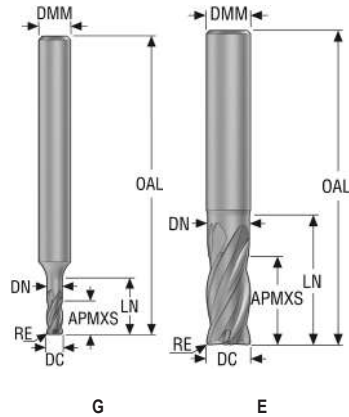

- Tolerances:
- DMM=h5
- DC=e8
- RE= ±0,05 mm

Designation	Grade	Item number	Length index	Tool shape	DC	DMM	APMXS	OAL	LN	DN	RE	PCEDC	Cylindrical
					mm	mm	mm	mm	mm	mm	mm		
JSE514030G2R050.0Z4	SIRA	10053071	2	G	3,0	6,0	6,0	57,0	10,0	2,85	0,5	4	■
JSE514040G2R050.0Z4	SIRA	10053072	2	G	4,0	6,0	8,0	57,0	13,0	3,8	0,5	4	■
JSE514050G2R050.0Z4	SIRA	10053073	2	G	5,0	6,0	10,0	57,0	16,0	4,75	0,5	4	■
JSE514060E2R050.0Z4	SIRA	10053074	2	E	6,0	6,0	12,0	57,0	18,0	5,7	0,5	4	■
JSE514060E2R100.0Z4	SIRA	10053081	2	E	6,0	6,0	12,0	57,0	18,0	5,7	1,0	4	■
JSE514080E2R050.0Z4	SIRA	10053075	2	E	8,0	8,0	16,0	63,0	25,0	7,6	0,5	4	■
JSE514080E2R100.0Z4	SIRA	10053082	2	E	8,0	8,0	16,0	63,0	25,0	7,6	1,0	4	■
JSE514100E2R050.0Z4	SIRA	10053076	2	E	10,0	10,0	20,0	72,0	29,0	9,5	0,5	4	■
JSE514100E2R100.0Z4	SIRA	10053083	2	E	10,0	10,0	20,0	72,0	29,0	9,5	1,0	4	■
JSE514120E2R050.0Z4	SIRA	10053077	2	E	12,0	12,0	24,0	83,0	35,0	11,4	0,5	4	■
JSE514120E2R100.0Z4	SIRA	10053084	2	E	12,0	12,0	24,0	83,0	35,0	11,4	1,0	4	■
JSE514160E2R050.0Z4	SIRA	10053078	2	E	16,0	16,0	32,0	92,0	42,0	15,2	0,5	4	■
JSE514160E2R100.0Z4	SIRA	10053087	2	E	16,0	16,0	32,0	92,0	42,0	15,2	1,0	4	■
JSE514200E2R050.0Z4	SIRA	10053079	2	E	20,0	20,0	35,0	104,0	51,0	19,0	0,5	4	■
JSE514200E2R100.0Z4	SIRA	10053088	2	E	20,0	20,0	35,0	104,0	51,0	19,0	1,0	4	■
JSE514250E2R050.0Z4	SIRA	10053080	2	E	25,0	25,0	40,0	125,0	66,0	23,8	0,5	4	■
JSE514250E2R100.0Z4	SIRA	10053089	2	E	25,0	25,0	40,0	125,0	66,0	23,8	1,0	4	■

■ Stocked standard.

Universal

Steel and cast iron

Stainless steel and S-materials

Non ferrous

Hard

Plastic and CFRP

Graphite

X-Heads

Minimaster Plus

Minimaster

JSE514

General purpose – Universal – Square – 4 Flutes – Weldon – chamfer

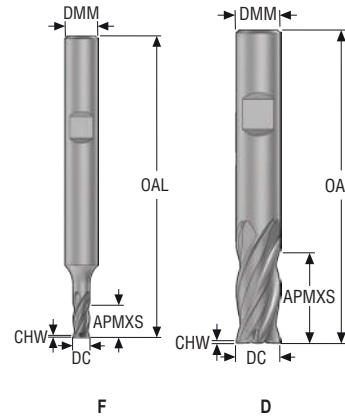

- Tolerances:
- DMM=h5
- DC=e8

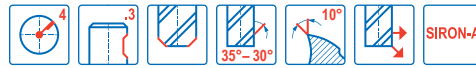

Designation	Grade	Item number	Length index	Tool shape	DC	DMM	APMXS	OAL	CHW	PCEDC	Weldon
					mm	mm	mm	mm	mm		
JSE514020F2C.3Z4	SIRA	10053289	2	F	2,0	6,0	4,0	57,0	0,02	4	■
JSE514030F2C.3Z4	SIRA	10053290	2	F	3,0	6,0	6,0	57,0	0,03	4	■
JSE514040F2C.3Z4	SIRA	10053291	2	F	4,0	6,0	8,0	57,0	0,04	4	■
JSE514050F2C.3Z4	SIRA	10053292	2	F	5,0	6,0	10,0	57,0	0,05	4	■
JSE514060D2C.3Z4	SIRA	10053293	2	D	6,0	6,0	12,0	57,0	0,06	4	■
JSE514080D2C.3Z4	SIRA	10053294	2	D	8,0	8,0	16,0	63,0	0,08	4	■
JSE514100D2C.3Z4	SIRA	10053295	2	D	10,0	10,0	20,0	72,0	0,1	4	■
JSE514120D2C.3Z4	SIRA	10053296	2	D	12,0	12,0	24,0	83,0	0,12	4	■
JSE514160D2C.3Z4	SIRA	10053297	2	D	16,0	16,0	32,0	92,0	0,16	4	■
JSE514180D2C.3Z4	SIRA	10053298	2	D	18,0	18,0	35,0	100,0	0,18	4	■
JSE514200D2C.3Z4	SIRA	10053299	2	D	20,0	20,0	35,0	104,0	0,2	4	■
JSE514250D2C.3Z4	SIRA	10053300	2	D	25,0	25,0	40,0	125,0	0,25	4	■
JSE514030F3C.3Z4	SIRA	10053321	3	F	3,0	6,0	10,0	57,0	0,03	4	■
JSE514040F3C.3Z4	SIRA	10053322	3	F	4,0	6,0	14,0	57,0	0,04	4	■
JSE514050F3C.3Z4	SIRA	10053323	3	F	5,0	6,0	18,0	57,0	0,05	4	■
JSE514060D3C.3Z4	SIRA	10053324	3	D	6,0	6,0	20,0	63,0	0,06	4	■
JSE514080D3C.3Z4	SIRA	10053325	3	D	8,0	8,0	28,0	80,0	0,08	4	■
JSE514100D3C.3Z4	SIRA	10053326	3	D	10,0	10,0	35,0	89,0	0,1	4	■
JSE514120D3C.3Z4	SIRA	10053327	3	D	12,0	12,0	42,0	100,0	0,12	4	■
JSE514160D3C.3Z4	SIRA	10053328	3	D	16,0	16,0	50,0	115,0	0,16	4	■
JSE514200D3C.3Z4	SIRA	10053329	3	D	20,0	20,0	60,0	125,0	0,2	4	■

■ Stocked standard.

Universal

Steel and cast iron

Stainless steel and S-materials

Non ferrous

Hard

Plastic and CFRP

Graphite

X-Heads

Minimaster Plus

Minimaster

JSE514

General purpose – Universal – Square – 4 Flutes – Weldon – Corner radius

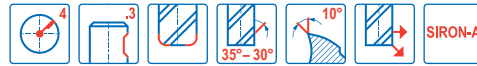
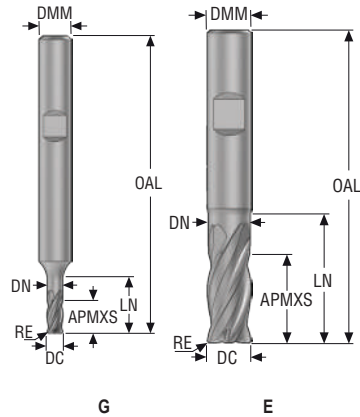

- Tolerances:
- DMM=h5
- DC=e8
- RE= ±0,05 mm

Designation	Grade	Item number	Length index	Tool shape	DC	DMM	APMXS	OAL	LN	DN	RE	PCEDC	Weldon
					mm	mm	mm	mm	mm	mm	mm		
JSE514030G2R050.3Z4	SIRA	10053301	2	G	3,0	6,0	6,0	57,0	10,0	2,85	0,5	4	■
JSE514040G2R050.3Z4	SIRA	10053302	2	G	4,0	6,0	8,0	57,0	13,0	3,8	0,5	4	■
JSE514050G2R050.3Z4	SIRA	10053306	2	G	5,0	6,0	10,0	57,0	16,0	4,75	0,5	4	■
JSE514060E2R050.3Z4	SIRA	10053307	2	E	6,0	6,0	12,0	57,0	18,0	5,7	0,5	4	■
JSE514060E2R100.3Z4	SIRA	10053314	2	E	6,0	6,0	12,0	57,0	18,0	5,7	1,0	4	■
JSE514080E2R050.3Z4	SIRA	10053308	2	E	8,0	8,0	16,0	63,0	25,0	7,6	0,5	4	■
JSE514080E2R100.3Z4	SIRA	10053315	2	E	8,0	8,0	16,0	63,0	25,0	7,6	1,0	4	■
JSE514100E2R050.3Z4	SIRA	10053309	2	E	10,0	10,0	20,0	72,0	29,0	9,5	0,5	4	■
JSE514100E2R100.3Z4	SIRA	10053316	2	E	10,0	10,0	20,0	72,0	29,0	9,5	1,0	4	■
JSE514120E2R050.3Z4	SIRA	10053310	2	E	12,0	12,0	24,0	83,0	35,0	11,4	0,5	4	■
JSE514120E2R100.3Z4	SIRA	10053317	2	E	12,0	12,0	24,0	83,0	35,0	11,4	1,0	4	■
JSE514160E2R050.3Z4	SIRA	10053311	2	E	16,0	16,0	32,0	92,0	42,0	15,2	0,5	4	■
JSE514160E2R100.3Z4	SIRA	10053318	2	E	16,0	16,0	32,0	92,0	42,0	15,2	1,0	4	■
JSE514200E2R050.3Z4	SIRA	10053312	2	E	20,0	20,0	35,0	104,0	51,0	19,0	0,5	4	■
JSE514200E2R100.3Z4	SIRA	10053319	2	E	20,0	20,0	35,0	104,0	51,0	19,0	1,0	4	■
JSE514250E2R050.3Z4	SIRA	10053313	2	E	25,0	25,0	40,0	125,0	66,0	23,8	0,5	4	■
JSE514250E2R100.3Z4	SIRA	10053320	2	E	25,0	25,0	40,0	125,0	66,0	23,8	1,0	4	■

■ Stocked standard.

Universal

Steel and cast iron

Stainless steel and S-materials

Non ferrous

Hard

Plastic and CFRP

Graphite

X-Heads

Minimaster Plus

Minimaster

Cutting data – JSE514 Side milling

SMG		a _e /DC	a _p /DC	f _z												v _c
				2	3	4	5	6	8	10	12	16	18	20	25	
P1	M/A/D/E	0.150	1.5	0.012	0.018	0.024	0.030	0.036	0.048	0.060	0.070	0.090	0.095	0.10	0.12	165 (69 – 200)
		0.150	1.5	0.00048	0.00070	0.00095	0.0012	0.0014	0.0019	0.0024	0.0028	0.0036	0.0038	0.0040	0.0048	540 (230 – 650)
P2	M/A/D/E	0.150	1.5	0.014	0.020	0.028	0.034	0.040	0.055	0.070	0.080	0.10	0.11	0.11	0.13	160 (67 – 190)
		0.150	1.5	0.00055	0.00080	0.0011	0.0013	0.0016	0.0022	0.0028	0.0032	0.0040	0.0044	0.0044	0.0050	520 (220 – 620)
P3	M/A/D/E	0.150	1.5	0.012	0.018	0.024	0.030	0.036	0.048	0.060	0.070	0.090	0.095	0.10	0.12	165 (69 – 200)
		0.150	1.5	0.00048	0.00070	0.00095	0.0012	0.0014	0.0019	0.0024	0.0028	0.0036	0.0038	0.0040	0.0048	540 (230 – 650)
P4	M/A/D/E	0.150	1.5	0.012	0.018	0.024	0.030	0.036	0.048	0.060	0.070	0.090	0.095	0.10	0.12	165 (69 – 200)
		0.150	1.5	0.00048	0.00070	0.00095	0.0012	0.0014	0.0019	0.0024	0.0028	0.0036	0.0038	0.0040	0.0048	540 (230 – 650)
P5	M/A/D/E	0.150	1.5	0.012	0.018	0.024	0.030	0.036	0.048	0.060	0.070	0.090	0.095	0.10	0.12	165 (69 – 200)
		0.150	1.5	0.00048	0.00070	0.00095	0.0012	0.0014	0.0019	0.0024	0.0028	0.0036	0.0038	0.0040	0.0048	540 (230 – 650)
P6	M/A/D/E	0.150	1.5	0.012	0.018	0.024	0.030	0.036	0.048	0.060	0.070	0.090	0.095	0.10	0.12	165 (69 – 200)
		0.150	1.5	0.00048	0.00070	0.00095	0.0012	0.0014	0.0019	0.0024	0.0028	0.0036	0.0038	0.0040	0.0048	540 (230 – 650)
P7	M/A/D/E	0.150	1.5	0.012	0.018	0.024	0.030	0.036	0.048	0.060	0.070	0.090	0.095	0.10	0.12	165 (69 – 200)
		0.150	1.5	0.00048	0.00070	0.00095	0.0012	0.0014	0.0019	0.0024	0.0028	0.0036	0.0038	0.0040	0.0048	540 (230 – 650)
P8	M/A/D/E	0.150	1.5	0.012	0.018	0.024	0.030	0.036	0.048	0.060	0.070	0.090	0.095	0.10	0.12	165 (69 – 200)
		0.150	1.5	0.00048	0.00070	0.00095	0.0012	0.0014	0.0019	0.0024	0.0028	0.0036	0.0038	0.0040	0.0048	540 (230 – 650)
P11	M/A/D/E	0.150	1.5	0.012	0.018	0.024	0.030	0.036	0.048	0.060	0.070	0.090	0.095	0.10	0.12	95 (69 – 130)
		0.150	1.5	0.00048	0.00070	0.00095	0.0012	0.0014	0.0019	0.0024	0.0028	0.0036	0.0038	0.0040	0.0048	310 (230 – 420)
P12	M/A/D/E	0.150	1.5	0.012	0.018	0.024	0.030	0.036	0.048	0.060	0.070	0.090	0.095	0.10	0.12	95 (69 – 130)
		0.150	1.5	0.00048	0.00070	0.00095	0.0012	0.0014	0.0019	0.0024	0.0028	0.0036	0.0038	0.0040	0.0048	310 (230 – 420)
M1	E/M/A	0.150	1.5	0.012	0.018	0.024	0.030	0.036	0.048	0.060	0.070	0.090	0.095	0.10	0.12	95 (69 – 130)
		0.150	1.5	0.00048	0.00070	0.00095	0.0012	0.0014	0.0019	0.0024	0.0028	0.0036	0.0038	0.0040	0.0048	310 (230 – 420)
M2	E/M/A	0.150	1.5	0.012	0.018	0.024	0.030	0.036	0.048	0.060	0.070	0.090	0.095	0.10	0.12	95 (69 – 130)
		0.150	1.5	0.00048	0.00070	0.00095	0.0012	0.0014	0.0019	0.0024	0.0028	0.0036	0.0038	0.0040	0.0048	310 (230 – 420)
M3	E/M/A	0.150	1.5	0.012	0.018	0.024	0.030	0.036	0.048	0.060	0.070	0.090	0.095	0.10	0.12	95 (69 – 130)
		0.150	1.5	0.00048	0.00070	0.00095	0.0012	0.0014	0.0019	0.0024	0.0028	0.0036	0.0038	0.0040	0.0048	310 (230 – 420)
M4	E/M/A	0.150	1.5	0.012	0.018	0.024	0.030	0.036	0.048	0.060	0.070	0.090	0.095	0.10	0.12	95 (69 – 130)
		0.150	1.5	0.00048	0.00070	0.00095	0.0012	0.0014	0.0019	0.0024	0.0028	0.0036	0.0038	0.0040	0.0048	310 (230 – 420)
M5	E/M/A	0.150	1.5	0.012	0.018	0.024	0.030	0.036	0.048	0.060	0.070	0.090	0.095	0.10	0.12	95 (69 – 130)
		0.150	1.5	0.00048	0.00070	0.00095	0.0012	0.0014	0.0019	0.0024	0.0028	0.0036	0.0038	0.0040	0.0048	310 (230 – 420)
K1	A/D/M/E	0.150	1.5	0.012	0.018	0.024	0.030	0.036	0.048	0.060	0.070	0.090	0.095	0.10	0.12	165 (69 – 200)
		0.150	1.5	0.00048	0.00070	0.00095	0.0012	0.0014	0.0019	0.0024	0.0028	0.0036	0.0038	0.0040	0.0048	540 (230 – 650)
K2	A/D/M/E	0.150	1.5	0.012	0.018	0.024	0.030	0.036	0.048	0.060	0.070	0.090	0.095	0.10	0.12	165 (69 – 200)
		0.150	1.5	0.00048	0.00070	0.00095	0.0012	0.0014	0.0019	0.0024	0.0028	0.0036	0.0038	0.0040	0.0048	540 (230 – 650)
K3	A/D/M/E	0.150	1.5	0.012	0.018	0.024	0.030	0.036	0.048	0.060	0.070	0.090	0.095	0.10	0.12	165 (69 – 200)
		0.150	1.5	0.00048	0.00070	0.00095	0.0012	0.0014	0.0019	0.0024	0.0028	0.0036	0.0038	0.0040	0.0048	540 (230 – 650)
K4	A/D/M/E	0.150	1.5	0.012	0.018	0.024	0.030	0.036	0.048	0.060	0.070	0.090	0.095	0.10	0.12	165 (69 – 200)
		0.150	1.5	0.00048	0.00070	0.00095	0.0012	0.0014	0.0019	0.0024	0.0028	0.0036	0.0038	0.0040	0.0048	540 (230 – 650)
K5	A/D/M/E	0.150	1.5	0.012	0.018	0.024	0.030	0.036	0.048	0.060	0.070	0.090	0.095	0.10	0.12	165 (69 – 200)
		0.150	1.5	0.00048	0.00070	0.00095	0.0012	0.0014	0.0019	0.0024	0.0028	0.0036	0.0038	0.0040	0.0048	540 (230 – 650)
K6	A/D/M/E	0.150	1.5	0.012	0.018	0.024	0.030	0.036	0.048	0.060	0.070	0.090	0.095	0.10	0.12	165 (69 – 200)
		0.150	1.5	0.00048	0.00070	0.00095	0.0012	0.0014	0.0019	0.0024	0.0028	0.0036	0.0038	0.0040	0.0048	540 (230 – 650)
K7	A/D/M/E	0.150	1.5	0.012	0.018	0.024	0.030	0.036	0.048	0.060	0.070	0.090	0.095	0.10	0.12	165 (69 – 200)
		0.150	1.5	0.00048	0.00070	0.00095	0.0012	0.0014	0.0019	0.0024	0.0028	0.0036	0.0038	0.0040	0.0048	540 (230 – 650)
N1	E/M/A	0.150	1.5	0.015	0.024	0.030	0.038	0.046	0.060	0.075	0.090	0.11	0.12	0.13	0.15	520 (400 – 650)
		0.150	1.5	0.00060	0.00095	0.0012	0.0015	0.0018	0.0024	0.0030	0.0036	0.0044	0.0048	0.0050	0.0060	1700 (1400 – 2100)
N11	E/M/A	0.150	1.5	0.012	0.018	0.024	0.030	0.036	0.048	0.060	0.070	0.090	0.095	0.10	0.12	410 (280 – 540)
		0.150	1.5	0.00048	0.00070	0.00095	0.0012	0.0014	0.0019	0.0024	0.0028	0.0036	0.0038	0.0040	0.0048	1350 (920 – 1700)
S11	E	0.150	1.5	0.012	0.018	0.024	0.030	0.036	0.048	0.060	0.070	0.090	0.095	0.10	0.12	95 (69 – 130)
		0.150	1.5	0.00048	0.00070	0.00095	0.0012	0.0014	0.0019	0.0024	0.0028	0.0036	0.0038	0.0040	0.0048	310 (230 – 420)
S12	E	0.150	1.5	0.012	0.018	0.024	0.030	0.036	0.048	0.060	0.070	0.090	0.095	0.10	0.12	95 (69 – 130)
		0.150	1.5	0.00048	0.00070	0.00095	0.0012	0.0014	0.0019	0.0024	0.0028	0.0036	0.0038	0.0040	0.0048	310 (230 – 420)
S13	E	0.150	1.5	0.012	0.018	0.024	0.030	0.036	0.048	0.060	0.070	0.090	0.095	0.10	0.12	95 (69 – 130)
		0.150	1.5	0.00048	0.00070	0.00095	0.0012	0.0014	0.0019	0.0024	0.0028	0.0036	0.0038	0.0040	0.0048	310 (230 – 420)

For cutting data recalculations, see pages 556 - 563

SMG = Seco material group
Coolant = A=air D=dry E=emulsion M=mist spray
v_c = m/min (sf/min)
f_z = mm (in/tooth)
a_p = mm/DC (in/DC) = factor
a_e = mm/DC (in/DC) = factor
All cutting data are target values

Cutting data – JSE514 Slot milling

SMG		a _p /DC	f _z												v _c
			2	3	4	5	6	8	10	12	16	18	20	25	
P1	M/A/D/E	0.40	0.0060	0.0090	0.012	0.015	0.018	0.024	0.030	0.036	0.048	0.055	0.060	0.075	120 (51 – 150)
		0.40	0.00024	0.00036	0.00048	0.00060	0.00070	0.00095	0.0012	0.0014	0.0019	0.0022	0.0024	0.0030	395 (170 – 490)
P2	M/A/D/E	0.40	0.0060	0.0090	0.012	0.015	0.018	0.024	0.030	0.036	0.048	0.055	0.060	0.075	120 (51 – 150)
		0.40	0.00024	0.00036	0.00048	0.00060	0.00070	0.00095	0.0012	0.0014	0.0019	0.0022	0.0024	0.0030	395 (170 – 490)
P3	M/A/D/E	0.40	0.0060	0.0090	0.012	0.015	0.018	0.024	0.030	0.036	0.048	0.055	0.060	0.075	120 (51 – 150)
		0.40	0.00024	0.00036	0.00048	0.00060	0.00070	0.00095	0.0012	0.0014	0.0019	0.0022	0.0024	0.0030	395 (170 – 490)
P4	M/A/D/E	0.40	0.0060	0.0090	0.012	0.015	0.018	0.024	0.030	0.036	0.048	0.055	0.060	0.075	120 (51 – 150)
		0.40	0.00024	0.00036	0.00048	0.00060	0.00070	0.00095	0.0012	0.0014	0.0019	0.0022	0.0024	0.0030	395 (170 – 450)
P5	M/A/D/E	0.40	0.0060	0.0090	0.012	0.015	0.018	0.024	0.030	0.036	0.048	0.055	0.060	0.075	120 (51 – 150)
		0.40	0.00024	0.00036	0.00048	0.00060	0.00070	0.00095	0.0012	0.0014	0.0019	0.0022	0.0024	0.0030	395 (170 – 490)
P6	M/A/D/E	0.40	0.0060	0.0090	0.012	0.015	0.018	0.024	0.030	0.036	0.048	0.055	0.060	0.075	120 (50 – 140)
		0.40	0.00024	0.00036	0.00048	0.00060	0.00070	0.00095	0.0012	0.0014	0.0019	0.0022	0.0024	0.0030	395 (170 – 450)
P7	M/A/D/E	0.40	0.0060	0.0090	0.012	0.015	0.018	0.024	0.030	0.036	0.048	0.055	0.060	0.075	120 (51 – 150)
		0.40	0.00024	0.00036	0.00048	0.00060	0.00070	0.00095	0.0012	0.0014	0.0019	0.0022	0.0024	0.0030	395 (170 – 490)
P8	M/A/D/E	0.40	0.0060	0.0090	0.012	0.015	0.018	0.024	0.030	0.036	0.048	0.055	0.060	0.075	120 (51 – 150)
		0.40	0.00024	0.00036	0.00048	0.00060	0.00070	0.00095	0.0012	0.0014	0.0019	0.0022	0.0024	0.0030	395 (170 – 490)
P11	M/A/D/E	0.40	0.0060	0.0090	0.012	0.015	0.018	0.024	0.030	0.036	0.048	0.055	0.060	0.075	70 (51 – 100)
		0.40	0.00024	0.00036	0.00048	0.00060	0.00070	0.00095	0.0012	0.0014	0.0019	0.0022	0.0024	0.0030	230 (170 – 320)
P12	M/A/D/E	0.40	0.0060	0.0090	0.012	0.015	0.018	0.024	0.030	0.036	0.048	0.055	0.060	0.075	70 (50 – 99)
		0.40	0.00024	0.00036	0.00048	0.00060	0.00070	0.00095	0.0012	0.0014	0.0019	0.0022	0.0024	0.0030	230 (170 – 320)
M1	E/M/A	0.40	0.0060	0.0090	0.012	0.015	0.018	0.024	0.030	0.036	0.048	0.055	0.060	0.075	70 (50 – 99)
		0.40	0.00024	0.00036	0.00048	0.00060	0.00070	0.00095	0.0012	0.0014	0.0019	0.0022	0.0024	0.0030	230 (170 – 320)
M2	E/M/A	0.40	0.0060	0.0090	0.012	0.015	0.018	0.024	0.030	0.036	0.048	0.055	0.060	0.075	70 (50 – 99)
		0.40	0.00024	0.00036	0.00048	0.00060	0.00070	0.00095	0.0012	0.0014	0.0019	0.0022	0.0024	0.0030	230 (170 – 320)
M3	E/M/A	0.40	0.0060	0.0090	0.012	0.015	0.018	0.024	0.030	0.036	0.048	0.055	0.060	0.075	70 (50 – 99)
		0.40	0.00024	0.00036	0.00048	0.00060	0.00070	0.00095	0.0012	0.0014	0.0019	0.0022	0.0024	0.0030	230 (170 – 320)
M4	E/M/A	0.40	0.0060	0.0090	0.012	0.015	0.018	0.024	0.030	0.036	0.048	0.055	0.060	0.075	70 (50 – 99)
		0.40	0.00024	0.00036	0.00048	0.00060	0.00070	0.00095	0.0012	0.0014	0.0019	0.0022	0.0024	0.0030	230 (170 – 320)
M5	E/M/A	0.40	0.0060	0.0090	0.012	0.015	0.018	0.024	0.030	0.036	0.048	0.055	0.060	0.075	70 (50 – 99)
		0.40	0.00024	0.00036	0.00048	0.00060	0.00070	0.00095	0.0012	0.0014	0.0019	0.0022	0.0024	0.0030	230 (170 – 320)
K1	A/D/M/E	0.40	0.0060	0.0090	0.012	0.015	0.018	0.024	0.030	0.036	0.048	0.055	0.060	0.075	120 (50 – 150)
		0.40	0.00024	0.00036	0.00048	0.00060	0.00070	0.00095	0.0012	0.0014	0.0019	0.0022	0.0024	0.0030	395 (170 – 490)
K2	A/D/M/E	0.40	0.0060	0.0090	0.012	0.015	0.018	0.024	0.030	0.036	0.048	0.055	0.060	0.075	120 (50 – 150)
		0.40	0.00024	0.00036	0.00048	0.00060	0.00070	0.00095	0.0012	0.0014	0.0019	0.0022	0.0024	0.0030	395 (170 – 490)
K3	A/D/M/E	0.40	0.0060	0.0090	0.012	0.015	0.018	0.024	0.030	0.036	0.048	0.055	0.060	0.075	120 (50 – 150)
		0.40	0.00024	0.00036	0.00048	0.00060	0.00070	0.00095	0.0012	0.0014	0.0019	0.0022	0.0024	0.0030	395 (170 – 490)
K4	A/D/M/E	0.40	0.0060	0.0090	0.012	0.015	0.018	0.024	0.030	0.036	0.048	0.055	0.060	0.075	120 (50 – 150)
		0.40	0.00024	0.00036	0.00048	0.00060	0.00070	0.00095	0.0012	0.0014	0.0019	0.0022	0.0024	0.0030	395 (170 – 490)
K5	A/D/M/E	0.40	0.0060	0.0090	0.012	0.015	0.018	0.024	0.030	0.036	0.048	0.055	0.060	0.075	120 (50 – 150)
		0.40	0.00024	0.00036	0.00048	0.00060	0.00070	0.00095	0.0012	0.0014	0.0019	0.0022	0.0024	0.0030	395 (170 – 490)
K6	A/D/M/E	0.40	0.0060	0.0090	0.012	0.015	0.018	0.024	0.030	0.036	0.048	0.055	0.060	0.075	120 (50 – 150)
		0.40	0.00024	0.00036	0.00048	0.00060	0.00070	0.00095	0.0012	0.0014	0.0019	0.0022	0.0024	0.0030	395 (170 – 490)
K7	A/D/M/E	0.40	0.0060	0.0090	0.012	0.015	0.018	0.024	0.030	0.036	0.048	0.055	0.060	0.075	120 (50 – 150)
		0.40	0.00024	0.00036	0.00048	0.00060	0.00070	0.00095	0.0012	0.0014	0.0019	0.0022	0.0024	0.0030	395 (170 – 490)
N1	E/M/A	0.30	0.0060	0.0090	0.012	0.015	0.018	0.024	0.030	0.036	0.048	0.055	0.060	0.075	400 (300 – 500)
		0.30	0.00024	0.00036	0.00048	0.00060	0.00070	0.00095	0.0012	0.0014	0.0019	0.0022	0.0024	0.0030	1300 (990 – 1600)
N11	E/M/A	0.40	0.0060	0.0090	0.012	0.015	0.018	0.024	0.030	0.036	0.048	0.055	0.060	0.075	300 (200 – 390)
		0.40	0.00024	0.00036	0.00048	0.00060	0.00070	0.00095	0.0012	0.0014	0.0019	0.0022	0.0024	0.0030	980 (660 – 1200)
S11	E	0.40	0.0060	0.0090	0.012	0.015	0.018	0.024	0.030	0.036	0.048	0.055	0.060	0.075	70 (50 – 99)
		0.40	0.00024	0.00036	0.00048	0.00060	0.00070	0.00095	0.0012	0.0014	0.0019	0.0022	0.0024	0.0030	230 (170 – 320)
S12	E	0.40	0.0060	0.0090	0.012	0.015	0.018	0.024	0.030	0.036	0.048	0.055	0.060	0.075	70 (50 – 99)
		0.40	0.00024	0.00036	0.00048	0.00060	0.00070	0.00095	0.0012	0.0014	0.0019	0.0022	0.0024	0.0030	230 (170 – 320)
S13	E	0.40	0.0060	0.0090	0.012	0.015	0.018	0.024	0.030	0.036	0.048	0.055	0.060	0.075	70 (50 – 99)
		0.40	0.00024	0.00036	0.00048	0.00060	0.00070	0.00095	0.0012	0.0014	0.0019	0.0022	0.0024	0.0030	230 (170 – 320)

For cutting data recalculations, see pages 556 - 563

SMG = Seco material group
 Coolant = A=air D=dry E=emulsion M=mist spray
 v_c = m/min (sf/min)
 f_z = mm (in/tooth)
 a_p = mm/DC (in/DC) = factor
 a_s = mm/DC (in/DC) = factor
 All cutting data are target values

Universal
 Steel and cast iron
 Stainless steel and S-materials
 Non ferrous
 Hard
 Plastic and CFRP
 Graphite
 X-Heads
 Minmaster Plus
 Minmaster

JS553

High performance – Universal – Square – 3 Flutes – Cylindrical – Sharp

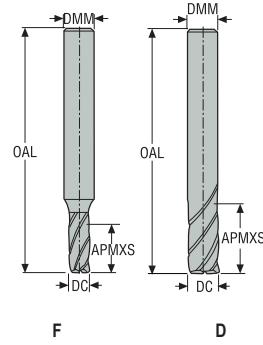

- Tolerances:
- DMM=h5
- DC=e7
- Regrind possible if DC is $\geq \phi 6$

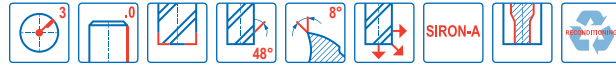

Designation	Item number	Length index	Tool shape	DC	DMM	APMXS	OAL	PCEDC	Cylindrical
				mm	mm	mm	mm		
553020SZ3.0-SIRON-A	02733903	2	F	2,0	6,0	5,0	50,0	3	■
553030SZ3.0-SIRON-A	02733906	2	F	3,0	6,0	7,0	50,0	3	■
553040SZ3.0-SIRON-A	02733910	2	F	4,0	6,0	10,0	55,0	3	■
553050SZ3.0-SIRON-A	02733912	2	F	5,0	6,0	12,0	55,0	3	■
553060SZ3.0-SIRON-A	02733914	2	D	6,0	6,0	14,0	55,0	3	■
553080SZ3.0-SIRON-A	02733918	2	D	8,0	8,0	18,0	60,0	3	■
553100SZ3.0-SIRON-A	02733922	2	D	10,0	10,0	22,0	70,0	3	■

■ Stocked standard.

Universal

Steel and cast iron

Stainless steel and S-materials

Non ferrous

Hard

Plastic and CFRP

Graphite

X-Heads

Minimaster Plus

Minimaster

JS553

High performance – Universal – Square – 3 Flutes – Cylindrical – Chamfer

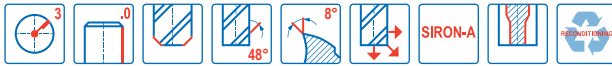
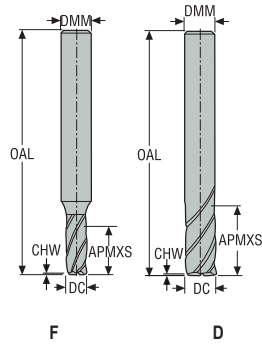

- Tolerances:
- DMM= h5
- DC= e7
- Regrind possible if DC is ≥Ø6

Designation	Item number	Length index	Tool shape	DC	DMM	APMXS	OAL	CHW	PCEDC	Cylindrical
				mm	mm	mm	mm	mm		
JS553020F1C.0Z3-SIRA	10041466	1	F	2,0	6,0	3,0	40,0	0,025	3	■
JS553030F1C.0Z3-SIRA	10041467	1	F	3,0	6,0	4,0	40,0	0,035	3	■
JS553040F1C.0Z3-SIRA	10041468	1	F	4,0	6,0	6,0	40,0	0,045	3	■
JS553045F1C.0Z3-SIRA	10041469	1	F	4,5	6,0	6,0	40,0	0,045	3	■
JS553050F1C.0Z3-SIRA	10041470	1	F	5,0	6,0	7,0	40,0	0,055	3	■
JS553055F1C.0Z3-SIRA	10041472	1	F	5,5	6,0	8,0	40,0	0,055	3	■
JS553060D1C.0Z3-SIRA	10041473	1	D	6,0	6,0	8,0	40,0	0,075	3	■
JS553080D1C.0Z3-SIRA	10041474	1	D	8,0	8,0	11,0	50,0	0,1	3	■
JS553100D1C.0Z3-SIRA	10041475	1	D	10,0	10,0	13,0	57,0	0,125	3	■
JS553120D1C.0Z3-SIRA	10041476	1	D	12,0	12,0	15,0	65,0	0,15	3	■
553020Z3.0-SIRON-A	02679241	2	F	2,0	6,0	5,0	50,0	0,025	3	■
553025Z3.0-SIRON-A	02679352	2	F	2,5	6,0	7,0	50,0	0,025	3	■
553030Z3.0-SIRON-A	02679353	2	F	3,0	6,0	7,0	50,0	0,035	3	■
553035Z3.0-SIRON-A	02679359	2	F	3,5	6,0	9,0	55,0	0,035	3	■
553040Z3.0-SIRON-A	02679360	2	F	4,0	6,0	10,0	55,0	0,045	3	■
553045Z3.0-SIRON-A	02679361	2	F	4,5	6,0	12,0	55,0	0,045	3	■
553050Z3.0-SIRON-A	02679364	2	F	5,0	6,0	12,0	55,0	0,055	3	■
553055Z3.0-SIRON-A	02679365	2	F	5,5	6,0	14,0	55,0	0,055	3	■
553060Z3.0-SIRON-A	02679368	2	D	6,0	6,0	14,0	55,0	0,075	3	■
553075Z3.0-SIRON-A	02733916	2	F	7,5	8,0	18,0	60,0	0,1	3	■
553080Z3.0-SIRON-A	02679371	2	D	8,0	8,0	18,0	60,0	0,1	3	■
553095Z3.0-SIRON-A	02733920	2	F	9,5	10,0	22,0	70,0	0,125	3	■
553100Z3.0-SIRON-A	02679374	2	D	10,0	10,0	22,0	70,0	0,125	3	■
553115Z3.0-SIRON-A	02733925	2	F	11,5	12,0	26,0	80,0	0,15	3	■
553120Z3.0-SIRON-A	02679380	2	D	12,0	12,0	26,0	80,0	0,15	3	■
553140Z3.0-SIRON-A	02733932	2	D	14,0	14,0	30,0	85,0	0,175	3	■
553160Z3.0-SIRON-A	02679384	2	D	16,0	16,0	34,0	90,0	0,2	3	■
553200Z3.0-SIRON-A	02679389	2	D	20,0	20,0	42,0	110,0	0,25	3	■
553250Z3.0-SIRON-A	02679393	2	D	25,0	25,0	52,0	125,0	0,3	3	■

■ Stocked standard.

Universal

Steel and cast iron

Stainless steel and S-materials

Non ferrous

Hard

Plastic and CFRP

Graphite

X-Heads

Minimaster Plus

Minimaster

JS553

High performance – Universal – Square – 3 Flutes – Cylindrical – Chamfer

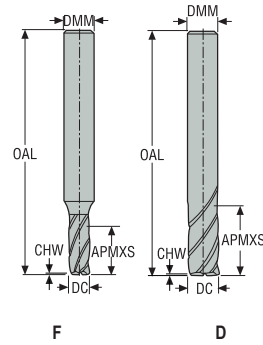

- Tolerances:
- DMM= h5
- DC= e7
- Regrind possible if DC is $\geq \phi 6$

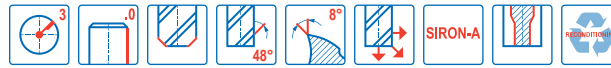

Designation	Item number	Length index	Tool shape	DC	DMM	APMXS	OAL	CHW	PCEDC	Cylindrical
				mm	mm	mm	mm	mm		
553L020Z3.0-SIRON-A	02733962	3	F	2,0	6,0	7,0	50,0	0,025	3	■
553L030Z3.0-SIRON-A	02733971	3	F	3,0	6,0	10,0	55,0	0,035	3	■
553L040Z3.0-SIRON-A	02733972	3	F	4,0	6,0	14,0	60,0	0,045	3	■
553L050Z3.0-SIRON-A	02733974	3	F	5,0	6,0	18,0	60,0	0,055	3	■
553L060Z3.0-SIRON-A	02733982	3	D	6,0	6,0	20,0	65,0	0,075	3	■
553L080Z3.0-SIRON-A	02733986	3	D	8,0	8,0	28,0	70,0	0,1	3	■
553L100Z3.0-SIRON-A	02733992	3	D	10,0	10,0	35,0	85,0	0,125	3	■
553L120Z3.0-SIRON-A	02733994	3	D	12,0	12,0	40,0	95,0	0,15	3	■
553L160Z3.0-SIRON-A	02733996	3	D	16,0	16,0	50,0	110,0	0,2	3	■
553L200Z3.0-SIRON-A	02733998	3	D	20,0	20,0	60,0	125,0	0,25	3	■
553L250Z3.0-SIRON-A	02734000	3	D	25,0	25,0	75,0	150,0	0,3	3	■

■ Stocked standard.

Universal

Steel and cast iron

Stainless steel and S-materials

Non ferrous

Hard

Plastic and cfrp

Graphite

X-Heads

Minimaster Plus

Minimaster

JS553

High performance – Universal – Square – 3 Flutes – Cylindrical – Corner radius

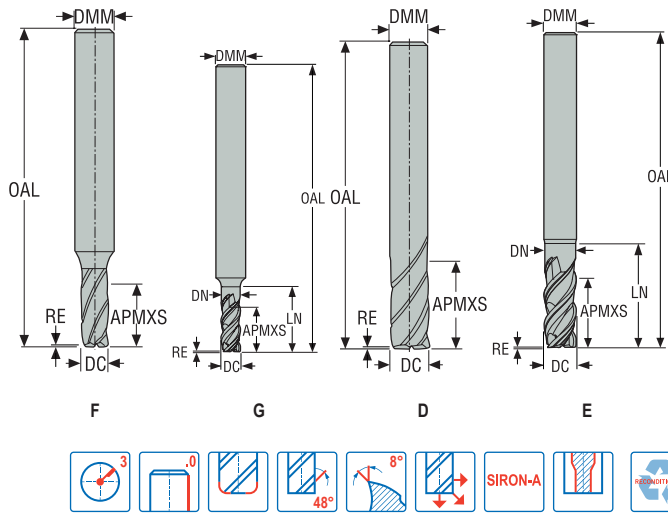

- Tolerances:
- DMM=h5
- DC=e7
- RE= ±0,02 mm
- Regrind possible if DC is ≥Ø6



Designation	Item number	Length index	Tool shape	DC	DMM	APMXS	OAL	LN	DN	RE	PCEDC	Cylindrical
				mm	mm	mm	mm	mm	mm	mm		
JS553020G2R050.0Z3-SIRA	02881683	2	G	2,0	6,0	5,0	57,0	8,0	1,9	0,5	3	■
553030R015Z3.0-SIRON-A	02733908	2	F	3,0	6,0	7,0	50,0	8,5	3,0	0,15	3	■
JS553030G2R050.0Z3-SIRA	02881684	2	G	3,0	6,0	7,0	57,0	11,0	2,85	0,5	3	■
553040R020Z3.0-SIRON-A	02733911	2	F	4,0	6,0	10,0	55,0	11,7	4,0	0,2	3	■
JS553040G2R050.0Z3-SIRA	02881685	2	G	4,0	6,0	10,0	57,0	13,0	3,8	0,5	3	■
553050R020Z3.0-SIRON-A	02687282	2	F	5,0	6,0	12,0	55,0	14,7	5,0	0,2	3	■
JS553050G2R050.0Z3-SIRA	02881686	2	G	5,0	6,0	10,0	57,0	15,0	4,75	0,5	3	■
553060R020Z3.0-SIRON-A	02679369	2	D	6,0	6,0	14,0	55,0	-	-	0,2	3	■
JS553060E2R050.0Z3-SIRA	02881687	2	E	6,0	6,0	14,0	57,0	19,0	5,7	0,5	3	■
JS553060E2R100.0Z3-SIRA	02881688	2	E	6,0	6,0	14,0	57,0	19,0	5,7	1,0	3	■
553080R050Z3.0-SIRON-A	02679372	2	D	8,0	8,0	18,0	60,0	-	-	0,5	3	■
553100R050Z3.0-SIRON-A	02679375	2	D	10,0	10,0	22,0	70,0	-	-	0,5	3	■
553100R100Z3.0-SIRON-A	02679376	2	D	10,0	10,0	22,0	70,0	-	-	1,0	3	■
553100R200Z3.0-SIRON-A	02810364	2	D	10,0	10,0	22,0	70,0	-	-	2,0	3	■
553100R250Z3.0-SIRON-A	02810365	2	D	10,0	10,0	22,0	70,0	-	-	2,5	3	■
553100R310Z3.0-SIRON-A	02810366	2	D	10,0	10,0	22,0	70,0	-	-	3,1	3	■
553120R050Z3.0-SIRON-A	02679381	2	D	12,0	12,0	26,0	80,0	-	-	0,5	3	■
553120R100Z3.0-SIRON-A	02679382	2	D	12,0	12,0	26,0	80,0	-	-	1,0	3	■
553120R200Z3.0-SIRON-A	02810367	2	D	12,0	12,0	26,0	80,0	-	-	2,0	3	■
553120R250Z3.0-SIRON-A	02810368	2	D	12,0	12,0	26,0	80,0	-	-	2,5	3	■
553120R310Z3.0-SIRON-A	02810369	2	D	12,0	12,0	26,0	80,0	-	-	3,1	3	■
553160R050Z3.0-SIRON-A	02679385	2	D	16,0	16,0	34,0	90,0	-	-	0,5	3	■
553160R100Z3.0-SIRON-A	02679386	2	D	16,0	16,0	34,0	90,0	-	-	1,0	3	■
553160R200Z3.0-SIRON-A	02810370	2	D	16,0	16,0	34,0	90,0	-	-	2,0	3	■
553160R250Z3.0-SIRON-A	02810371	2	D	16,0	16,0	34,0	90,0	-	-	2,5	3	■
553160R310Z3.0-SIRON-A	02810372	2	D	16,0	16,0	34,0	90,0	-	-	3,1	3	■
553160R400Z3.0-SIRON-A	02810373	2	D	16,0	16,0	34,0	90,0	-	-	4,0	3	■
553200R050Z3.0-SIRON-A	02679390	2	D	20,0	20,0	42,0	110,0	-	-	0,5	3	■
553200R100Z3.0-SIRON-A	02679391	2	D	20,0	20,0	42,0	110,0	-	-	1,0	3	■
JS553200E2R200.0Z3-SIRA	02881689	2	E	20,0	20,0	42,0	110,0	54,0	19,0	2,0	3	■
553250R050Z3.0-SIRON-A	02679395	2	D	25,0	25,0	52,0	125,0	-	-	0,5	3	■
553250R100Z3.0-SIRON-A	02679396	2	D	25,0	25,0	52,0	125,0	-	-	1,0	3	■

■ Stocked standard.

Universal

Steel and cast iron

Stainless steel and S-materials

Non ferrous

Hard

Plastic and CFRP

Graphite

X-Heads

Minimaster Plus

Minimaster

JS553

High performance – Universal – Square – 3 Flutes – Weldon – Sharp

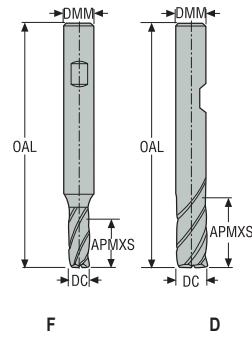

- Tolerances:
- DMM=h5
- DC=e7
- Regrind possible if DC is $\geq \phi 6$

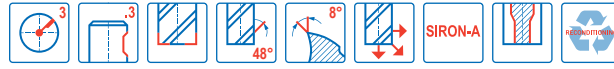

Designation	Item number	Length index	Tool shape	DC	DMM	APMXS	OAL	PCEDC	Weldon
				mm	mm	mm	mm		
553020SZ3.0-SIRON-AW	02733936	2	F	2,0	6,0	5,0	50,0	3	■
553030SZ3.0-SIRON-AW	02733939	2	F	3,0	6,0	7,0	50,0	3	■
553040SZ3.0-SIRON-AW	02733943	2	F	4,0	6,0	10,0	55,0	3	■
553050SZ3.0-SIRON-AW	02733945	2	F	5,0	6,0	12,0	55,0	3	■
553060SZ3.0-SIRON-AW	02733946	2	D	6,0	6,0	14,0	55,0	3	■
553080SZ3.0-SIRON-AW	02733950	2	D	8,0	8,0	18,0	60,0	3	■
553100SZ3.0-SIRON-AW	02733952	2	D	10,0	10,0	22,0	70,0	3	■

■ Stocked standard.

Universal

Steel and cast iron

Stainless steel and S-materials

Non ferrous

Hard

Plastic and CFRP

Graphite

X-Heads

Minimaster Plus

Minimaster

JS553

High performance – Universal – Square – 3 Flutes – Weldon – Chamfer

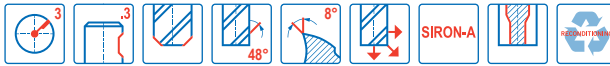
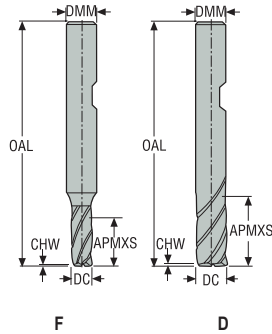

- Tolerances:
- DMM= h5
- DC= e7
- Regrind possible if DC is ≥Ø6

Designation	Item number	Length index	Tool shape	DC	DMM	APMXS	OAL	CHW	PCEDC	Weldon
				mm	mm	mm	mm	mm		
JS553020F1C.3Z3-SIRA	10041477	1	F	2,0	6,0	3,0	40,0	0,025	3	■
JS553030F1C.3Z3-SIRA	10041478	1	F	3,0	6,0	4,0	40,0	0,035	3	■
JS553040F1C.3Z3-SIRA	10041479	1	F	4,0	6,0	6,0	40,0	0,045	3	■
JS553045F1C.3Z3-SIRA	10041480	1	F	4,5	6,0	6,0	40,0	0,045	3	■
JS553050F1C.3Z3-SIRA	10041481	1	F	5,0	6,0	7,0	40,0	0,055	3	■
JS553055F1C.3Z3-SIRA	10041482	1	F	5,5	6,0	8,0	40,0	0,055	3	■
JS553060D1C.3Z3-SIRA	10041483	1	D	6,0	6,0	8,0	40,0	0,075	3	■
JS553080D1C.3Z3-SIRA	10041484	1	D	8,0	8,0	11,0	50,0	0,1	3	□
JS553100D1C.3Z3-SIRA	10041485	1	D	10,0	10,0	13,0	57,0	0,125	3	□
JS553120D1C.3Z3-SIRA	10041486	1	D	12,0	12,0	15,0	65,0	0,15	3	□
553020Z3.0-SIRON-AW	02697423	2	F	2,0	6,0	5,0	50,0	0,025	3	□
553025Z3.0-SIRON-AW	02700354	2	F	2,5	6,0	7,0	50,0	0,025	3	■
553030Z3.0-SIRON-AW	02700355	2	F	3,0	6,0	7,0	50,0	0,035	3	■
553035Z3.0-SIRON-AW	02700357	2	F	3,5	6,0	9,0	55,0	0,035	3	■
553040Z3.0-SIRON-AW	02700358	2	F	4,0	6,0	10,0	55,0	0,045	3	■
553045Z3.0-SIRON-AW	02700359	2	F	4,5	6,0	12,0	55,0	0,045	3	□
553050Z3.0-SIRON-AW	02700360	2	F	5,0	6,0	12,0	55,0	0,055	3	■
553055Z3.0-SIRON-AW	02700361	2	F	5,5	6,0	14,0	55,0	0,055	3	□
553060Z3.3-SIRON-A	02679367	2	D	6,0	6,0	14,0	55,0	0,075	3	■
553075Z3.3-SIRON-A	02733915	2	F	7,5	8,0	18,0	60,0	0,1	3	■
553080Z3.3-SIRON-A	02679370	2	D	8,0	8,0	18,0	60,0	0,1	3	■
553095Z3.3-SIRON-A	02733919	2	F	9,5	10,0	22,0	70,0	0,125	3	■
553100Z3.3-SIRON-A	02679373	2	D	10,0	10,0	22,0	70,0	0,125	3	■
553115Z3.3-SIRON-A	02733923	2	F	11,5	12,0	26,0	80,0	0,15	3	■
553120Z3.3-SIRON-A	02679379	2	D	12,0	12,0	26,0	80,0	0,15	3	■
553140Z3.3-SIRON-A	02733929	2	D	14,0	14,0	30,0	85,0	0,175	3	■
553160Z3.3-SIRON-A	02679383	2	D	16,0	16,0	34,0	90,0	0,2	3	■
553200Z3.3-SIRON-A	02679388	2	D	20,0	20,0	42,0	110,0	0,25	3	■
553250Z3.3-SIRON-A	02679392	2	D	25,0	25,0	52,0	125,0	0,3	3	■

■ Stocked standard. □ Weldon available. Delivery time is 3 days.

Universal

Steel and cast iron

Stainless steel and S-materials

Non ferrous

Hard

Plastic and CFRP

Graphite

X-Heads

Minimaster Plus

Minimaster

JS553

High performance – Universal – Square – 3 Flutes – Weldon – Chamfer

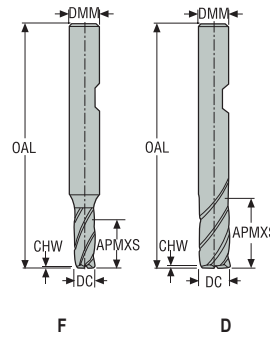

- Tolerances:
- DMM= h5
- DC= e7
- Regrind possible if DC is ≥ 6

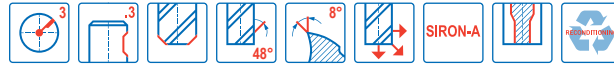

Designation	Item number	Length index	Tool shape	DC	DMM	APMXS	OAL	CHW	PCEDC	Weldon
				mm	mm	mm	mm	mm		
553L020Z3.0-SIRON-AW	02734001	3	F	2,0	6,0	7,0	50,0	0,025	3	<input type="checkbox"/>
553L030Z3.0-SIRON-AW	02734006	3	F	3,0	6,0	10,0	55,0	0,035	3	<input checked="" type="checkbox"/>
553L040Z3.0-SIRON-AW	02734007	3	F	4,0	6,0	14,0	60,0	0,045	3	<input checked="" type="checkbox"/>
553L050Z3.0-SIRON-AW	02734008	3	F	5,0	6,0	18,0	60,0	0,055	3	<input type="checkbox"/>
553L060Z3.3-SIRON-A	02733980	3	D	6,0	6,0	20,0	65,0	0,075	3	<input checked="" type="checkbox"/>
553L080Z3.3-SIRON-A	02733984	3	D	8,0	8,0	28,0	70,0	0,1	3	<input checked="" type="checkbox"/>
553L100Z3.3-SIRON-A	02733988	3	D	10,0	10,0	35,0	85,0	0,125	3	<input checked="" type="checkbox"/>
553L120Z3.3-SIRON-A	02733993	3	D	12,0	12,0	40,0	95,0	0,15	3	<input checked="" type="checkbox"/>
553L160Z3.3-SIRON-A	02733995	3	D	16,0	16,0	50,0	110,0	0,2	3	<input checked="" type="checkbox"/>
553L200Z3.3-SIRON-A	02733997	3	D	20,0	20,0	60,0	125,0	0,25	3	<input checked="" type="checkbox"/>
553L250Z3.3-SIRON-A	02733999	3	D	25,0	25,0	75,0	150,0	0,3	3	<input checked="" type="checkbox"/>

■ Stocked standard. □ Weldon available. Delivery time is 3 days.

Universal
Steel and cast iron
Stainless steel and S-materials
Non ferrous
Hard
Plastic and cfrp
Graphite
X-Heads
Minimaster Plus
Minimaster

JS553

High performance – Universal – Square – 3 Flutes – Weldon – Corner radius

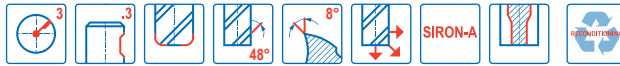
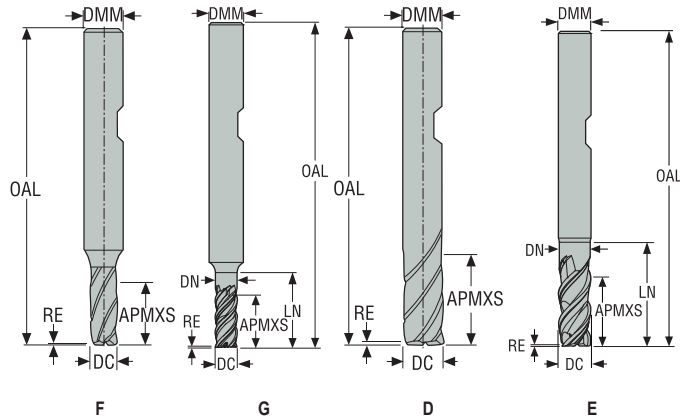

- Tolerances:
- DMM=h5
- DC=e7
- RE= ±0,02 mm
- Regrind possible if DC is ≥Ø6

Designation	Item number	Length index	Tool shape	DC	DMM	APMXS	OAL	LN	DN	RE	PCEDC	Weldon
				mm	mm	mm	mm	mm	mm	mm		
JS553020G2R050.3Z3-SIRA	02881690	2	G	2,0	6,0	5,0	57,0	8,0	1,9	0,5	3	□
553030R015Z3.0-SIRON-AW	02733941	2	F	3,0	6,0	7,0	50,0	8,5	3,0	0,15	3	□
JS553030G2R050.3Z3-SIRA	02881691	2	G	3,0	6,0	7,0	57,0	11,0	2,85	0,5	3	□
553040R020Z3.0-SIRON-AW	02733944	2	F	4,0	6,0	10,0	55,0	11,7	4,0	0,2	3	□
JS553040G2R050.3Z3-SIRA	02881692	2	G	4,0	6,0	10,0	57,0	13,0	3,8	0,5	3	□
553050R020Z3.0-SIRON-AW	02703763	2	F	5,0	6,0	12,0	55,0	14,7	5,0	0,2	3	□
JS553050G2R050.3Z3-SIRA	02881693	2	G	5,0	6,0	10,0	57,0	15,0	4,75	0,5	3	□
553060R020Z3.0-SIRON-AW	02700364	2	D	6,0	6,0	14,0	55,0	-	-	0,2	3	□
JS553060E2R050.3Z3-SIRA	02881694	2	E	6,0	6,0	14,0	57,0	19,0	5,7	0,5	3	□
JS553060E2R100.3Z3-SIRA	02881695	2	E	6,0	6,0	14,0	57,0	19,0	5,7	1,0	3	■
553080R050Z3.0-SIRON-AW	02700366	2	D	8,0	8,0	18,0	60,0	-	-	0,5	3	■
553100R050Z3.0-SIRON-AW	02700369	2	D	10,0	10,0	22,0	70,0	-	-	0,5	3	□
553100R100Z3.0-SIRON-AW	02700371	2	D	10,0	10,0	22,0	70,0	-	-	1,0	3	□
553100R200Z3.3-SIRON-A	02810422	2	D	10,0	10,0	22,0	70,0	-	-	2,0	3	□
553100R250Z3.3-SIRON-A	02810423	2	D	10,0	10,0	22,0	70,0	-	-	2,5	3	□
553100R310Z3.3-SIRON-A	02810424	2	D	10,0	10,0	22,0	70,0	-	-	3,1	3	□
553120R050Z3.0-SIRON-AW	02700373	2	D	12,0	12,0	26,0	80,0	-	-	0,5	3	□
553120R100Z3.0-SIRON-AW	02700374	2	D	12,0	12,0	26,0	80,0	-	-	1,0	3	□
553120R200Z3.3-SIRON-A	02810425	2	D	12,0	12,0	26,0	80,0	-	-	2,0	3	□
553120R250Z3.3-SIRON-A	02810426	2	D	12,0	12,0	26,0	80,0	-	-	2,5	3	□
553120R310Z3.3-SIRON-A	02810427	2	D	12,0	12,0	26,0	80,0	-	-	3,1	3	□
553160R050Z3.0-SIRON-AW	02700378	2	D	16,0	16,0	34,0	90,0	-	-	0,5	3	□
553160R100Z3.0-SIRON-AW	02700381	2	D	16,0	16,0	34,0	90,0	-	-	1,0	3	□
553160R200Z3.3-SIRON-A	02810428	2	D	16,0	16,0	34,0	90,0	-	-	2,0	3	□
553160R250Z3.3-SIRON-A	02810429	2	D	16,0	16,0	34,0	90,0	-	-	2,5	3	□
553160R310Z3.3-SIRON-A	02810430	2	D	16,0	16,0	34,0	90,0	-	-	3,1	3	□
553160R400Z3.3-SIRON-A	02810431	2	D	16,0	16,0	34,0	90,0	-	-	4,0	3	□
553200R050Z3.0-SIRON-AW	02700383	2	D	20,0	20,0	42,0	110,0	-	-	0,5	3	■
553200R100Z3.0-SIRON-AW	02700384	2	D	20,0	20,0	42,0	110,0	-	-	1,0	3	□
JS553200E2R200.3Z3-SIRA	02881696	2	E	20,0	20,0	42,0	110,0	54,0	19,0	2,0	3	□
553250R050Z3.0-SIRON-AW	02700386	2	D	25,0	25,0	52,0	125,0	-	-	0,5	3	□
553250R100Z3.0-SIRON-AW	02700385	2	D	25,0	25,0	52,0	125,0	-	-	1,0	3	□

■ Stocked standard. □ Weldon available. Delivery time is 3 days.

Universal

Steel and cast iron

Stainless steel and S-materials

Non ferrous

Hard

Plastic and CFRP

Graphite

X-Heads

Minimaster Plus

Minimaster

JS553

High performance – Universal – Square – 3 Flutes – Cylindrical – Corner radius or chamfer – Inch

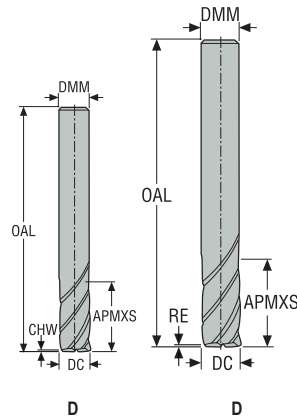

- Tolerances:
- DMM=h5
- DC=e7
- Regrind possible if DC is $\geq \varnothing 0.375$

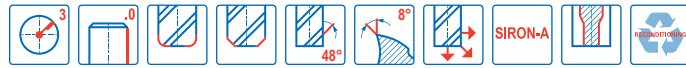

Designation	Item number	Length index	Tool shape	DC	DMM	APMXS	OAL	CHW	RE	PCEDC	Cylindrical
				inch	inch	inch	inch	inch	inch		
5530125Z3.0-SIRON-A	02712684	2	D	0.125	0.125	0.250	2.000	0.001	–	3	■
5530187Z3.0-SIRON-A	02712687	2	D	0.188	0.188	0.375	2.000	0.001	–	3	■
5530250Z3.0-SIRON-A	02712688	2	D	0.250	0.250	0.500	2.500	0.003	–	3	■
5530250R015Z3.0-SIRON-A	02712689	2	D	0.250	0.250	0.500	2.500	–	0.015	3	■
5530312Z3.0-SIRON-A	02712690	2	D	0.313	0.313	0.625	2.500	0.004	–	3	■
5530312R015Z3.0-SIRON-A	02712693	2	D	0.313	0.313	0.625	2.500	–	0.015	3	■
5530375Z3.0-SIRON-A	02712694	2	D	0.375	0.375	0.750	3.000	0.005	–	3	■
5530375R015Z3.0-SIRON-A	02712695	2	D	0.375	0.375	0.750	3.000	–	0.015	3	■
5530375R030Z3.0-SIRON-A	02712696	2	D	0.375	0.375	0.750	3.000	–	0.030	3	■
5530500Z3.0-SIRON-A	02712699	2	D	0.500	0.500	1.000	3.500	0.006	–	3	■
5530500R015Z3.0-SIRON-A	02712701	2	D	0.500	0.500	1.000	3.500	–	0.015	3	■
5530500R030Z3.0-SIRON-A	02712703	2	D	0.500	0.500	1.000	3.500	–	0.030	3	■

■ Stocked standard.

Universal

Steel and cast iron

Stainless steel and S-materials

Non ferrous

Hard

Plastic and CFRP

Graphite

X-Heads

Minimaster Plus

Minimaster

JS553

High performance – Universal – Square – 3 Flutes – Weldon – Corner radius or chamfer – Inch

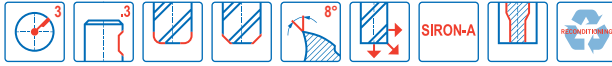
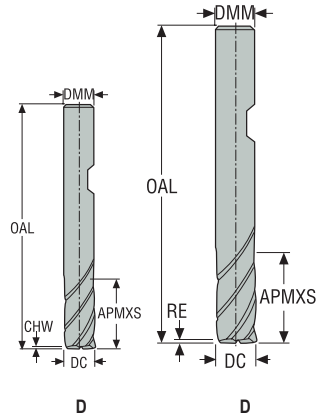

- Tolerances:
- DMM=h5
- DC=e7

Designation	Item number	Length index	Tool shape	DC	DMM	APMXS	OAL	CHW	RE	PCEDC	Weldon
				inch	inch	inch	inch	inch	inch		
5530500Z3.3-SIRON-A	02712697	2	D	0.500	0.500	1.000	3.500	0.006	–	3	■
5530500R015Z3.3-SIRON-A	02712700	2	D	0.500	0.500	1.000	3.500	–	0.015	3	■
5530500R030Z3.3-SIRON-A	02712702	2	D	0.500	0.500	1.000	3.500	–	0.030	3	■

■ Stocked standard.

Universal

Steel and cast iron

Stainless steel and S-materials

Non ferrous

Hard

Plastic and cfrp

Graphite

X-Heads

Minimaster Plus

Minimaster

Cutting data – JS553 Side milling

SMG		a _e /DC	a _p /DC	f _z												v _c
				2	3	4	5	6	8	10	12	14	16	20	25	
P1	M/A/D/E	0.400	1.0	0.020	0.030	0.040	0.050	0.060	0.080	0.10	0.12	0.13	0.15	0.17	0.19	225 (200 – 250)
		0.400	1.0	0.00080	0.0012	0.0016	0.0020	0.0024	0.0032	0.0040	0.0048	0.0050	0.0060	0.0065	0.0075	740 (660 – 820)
P2	M/A/D/E	0.400	1.0	0.020	0.030	0.040	0.050	0.060	0.080	0.10	0.12	0.13	0.15	0.17	0.19	220 (190 – 240)
		0.400	1.0	0.00080	0.0012	0.0016	0.0020	0.0024	0.0032	0.0040	0.0048	0.0050	0.0060	0.0065	0.0075	720 (630 – 780)
P3	M/A/D/E	0.400	1.0	0.019	0.028	0.038	0.048	0.055	0.075	0.095	0.11	0.13	0.14	0.16	0.18	190 (170 – 210)
		0.400	1.0	0.00075	0.0011	0.0015	0.0019	0.0022	0.0030	0.0038	0.0044	0.0050	0.0055	0.0065	0.0070	620 (560 – 680)
P4	M/A/D/E	0.400	1.0	0.019	0.028	0.038	0.046	0.055	0.075	0.095	0.11	0.13	0.14	0.16	0.18	165 (150 – 190)
		0.400	1.0	0.00075	0.0011	0.0015	0.0018	0.0022	0.0030	0.0038	0.0044	0.0050	0.0055	0.0065	0.0070	540 (500 – 620)
P5	M/A/D/E	0.400	1.0	0.018	0.028	0.036	0.046	0.055	0.075	0.090	0.11	0.12	0.13	0.16	0.18	160 (140 – 180)
		0.400	1.0	0.00070	0.0011	0.0014	0.0018	0.0022	0.0030	0.0036	0.0044	0.0048	0.0050	0.0065	0.0070	520 (460 – 590)
P6	M/A/D/E	0.400	1.0	0.018	0.028	0.036	0.046	0.055	0.075	0.090	0.11	0.12	0.13	0.15	0.17	180 (160 – 200)
		0.400	1.0	0.00070	0.0011	0.0014	0.0018	0.0022	0.0030	0.0036	0.0044	0.0048	0.0050	0.0060	0.0065	590 (530 – 650)
P7	M/A/D/E	0.400	1.0	0.018	0.028	0.036	0.046	0.055	0.075	0.090	0.11	0.12	0.13	0.15	0.17	170 (150 – 190)
		0.400	1.0	0.00070	0.0011	0.0014	0.0018	0.0022	0.0030	0.0036	0.0044	0.0048	0.0050	0.0060	0.0065	560 (500 – 620)
P8	M/A/D/E	0.400	1.0	0.019	0.028	0.038	0.048	0.055	0.075	0.095	0.11	0.13	0.14	0.16	0.18	160 (140 – 180)
		0.400	1.0	0.00075	0.0011	0.0015	0.0019	0.0022	0.0030	0.0038	0.0044	0.0050	0.0055	0.0065	0.0070	520 (460 – 590)
P11	M/A/D/E	0.400	1.0	0.018	0.026	0.036	0.044	0.055	0.070	0.090	0.11	0.12	0.13	0.15	0.17	145 (130 – 160)
		0.400	1.0	0.00070	0.0010	0.0014	0.0017	0.0022	0.0028	0.0036	0.0044	0.0048	0.0050	0.0060	0.0065	475 (430 – 520)
P12	M/A/D/E	0.400	1.0	0.012	0.018	0.024	0.030	0.036	0.048	0.060	0.070	0.080	0.090	0.10	0.12	95 (82 – 100)
		0.400	1.0	0.00048	0.00070	0.00095	0.0012	0.0014	0.0019	0.0024	0.0028	0.0032	0.0036	0.0040	0.0048	310 (270 – 320)
M1	E	0.400	1.0	0.013	0.020	0.026	0.034	0.040	0.055	0.065	0.080	0.090	0.10	0.11	0.13	115 (100 – 120)
		0.400	1.0	0.00050	0.00080	0.0010	0.0013	0.0016	0.0022	0.0026	0.0032	0.0036	0.0040	0.0044	0.0050	375 (330 – 390)
M2	E	0.400	1.0	0.012	0.018	0.024	0.030	0.036	0.048	0.060	0.070	0.080	0.090	0.10	0.12	95 (82 – 100)
		0.400	1.0	0.00048	0.00070	0.00095	0.0012	0.0014	0.0019	0.0024	0.0028	0.0032	0.0036	0.0040	0.0048	310 (270 – 320)
M3	E	0.400	1.0	0.010	0.015	0.020	0.025	0.030	0.040	0.050	0.060	0.070	0.075	0.085	0.10	60 (47 – 69)
		0.400	1.0	0.00040	0.00060	0.00080	0.0010	0.0012	0.0016	0.0020	0.0024	0.0028	0.0030	0.0034	0.0040	195 (160 – 220)
M4	E	0.400	1.0	0.0090	0.013	0.018	0.022	0.026	0.036	0.044	0.055	0.060	0.065	0.075	0.085	45 (36 – 53)
		0.400	1.0	0.00036	0.00050	0.00070	0.00085	0.0010	0.0014	0.0017	0.0022	0.0024	0.0026	0.0030	0.0034	150 (120 – 170)
M5	E	0.400	1.0	0.0090	0.013	0.018	0.022	0.026	0.036	0.044	0.055	0.060	0.065	0.075	0.085	37 (30 – 44)
		0.400	1.0	0.00036	0.00050	0.00070	0.00085	0.0010	0.0014	0.0017	0.0022	0.0024	0.0026	0.0030	0.0034	120 (99 – 140)
K1	E	0.400	1.2	0.016	0.024	0.032	0.040	0.048	0.065	0.080	0.095	0.11	0.12	0.14	0.16	165 (160 – 190)
		0.400	1.2	0.00065	0.00095	0.0013	0.0016	0.0019	0.0026	0.0032	0.0038	0.0044	0.0048	0.0055	0.0065	540 (530 – 620)
K2	E	0.400	1.2	0.015	0.022	0.030	0.038	0.044	0.060	0.075	0.090	0.10	0.11	0.13	0.14	145 (140 – 170)
		0.400	1.2	0.00060	0.00085	0.0012	0.0015	0.0017	0.0024	0.0030	0.0036	0.0040	0.0044	0.0050	0.0055	475 (460 – 550)
K3	E	0.400	1.2	0.015	0.022	0.030	0.038	0.044	0.060	0.075	0.090	0.10	0.11	0.13	0.14	125 (120 – 140)
		0.400	1.2	0.00060	0.00085	0.0012	0.0015	0.0017	0.0024	0.0030	0.0036	0.0040	0.0044	0.0050	0.0055	410 (400 – 450)
K4	E	0.400	1.2	0.015	0.022	0.030	0.038	0.044	0.060	0.075	0.090	0.10	0.11	0.13	0.14	120 (110 – 140)
		0.400	1.2	0.00060	0.00085	0.0012	0.0015	0.0017	0.0024	0.0030	0.0036	0.0040	0.0044	0.0050	0.0055	395 (370 – 450)
K5	E	0.400	1.1	0.016	0.024	0.032	0.040	0.048	0.065	0.080	0.095	0.11	0.12	0.14	0.16	155 (140 – 170)
		0.400	1.1	0.00065	0.00095	0.0013	0.0016	0.0019	0.0026	0.0032	0.0038	0.0044	0.0048	0.0055	0.0065	510 (460 – 550)
K6	E	0.400	1.1	0.018	0.028	0.036	0.046	0.055	0.070	0.090	0.11	0.12	0.13	0.15	0.17	220 (190 – 250)
		0.400	1.1	0.00070	0.0011	0.0014	0.0018	0.0022	0.0028	0.0036	0.0044	0.0048	0.0050	0.0060	0.0065	720 (630 – 820)
K7	E	0.400	1.1	0.016	0.024	0.032	0.040	0.048	0.065	0.080	0.095	0.11	0.12	0.14	0.16	195 (170 – 220)
		0.400	1.1	0.00065	0.00095	0.0013	0.0016	0.0019	0.0026	0.0032	0.0038	0.0044	0.0048	0.0055	0.0065	640 (560 – 720)

For cutting data recalculations, see pages 556 - 563

SMG = Seco material group
Coolant = A=air D=dry E=emulsion M=mist spray
v_c = m/min (sf/min)
f_z = mm (in/tooth)
a_p = mm/DC (in/DC) = factor
a_e = mm/DC (in/DC) = factor
All cutting data are target values

Cutting data – JS553 Side milling

SMG		a _e /DC	a _p /DC	f _z												v _c
				2	3	4	5	6	8	10	12	14	16	20	25	
N1	E	0.500	1.0	0.016	0.024	0.032	0.040	0.048	0.065	0.080	0.095	0.11	0.12	0.14	0.15	620 (520 – 720)
		0,500	1,0	0,00065	0,00095	0,0013	0,0016	0,0019	0,0026	0,0032	0,0038	0,0044	0,0048	0,0055	0,0060	2025 (1800 – 2300)
N2	E	0.500	1.0	0.016	0.024	0.032	0.040	0.048	0.065	0.080	0.095	0.11	0.12	0.14	0.15	400 (340 – 460)
		0,500	1,0	0,00065	0,00095	0,0013	0,0016	0,0019	0,0026	0,0032	0,0038	0,0044	0,0048	0,0055	0,0060	1300 (1200 – 1500)
N3	E	0.500	1.0	0.016	0.024	0.032	0.040	0.048	0.065	0.080	0.095	0.11	0.12	0.14	0.15	265 (230 – 300)
		0,500	1,0	0,00065	0,00095	0,0013	0,0016	0,0019	0,0026	0,0032	0,0038	0,0044	0,0048	0,0055	0,0060	870 (760 – 980)
N11	E	0.500	1.1	0.016	0.024	0.032	0.040	0.048	0.065	0.080	0.095	0.11	0.12	0.13	0.15	310 (260 – 350)
		0,500	1,1	0,00065	0,00095	0,0013	0,0016	0,0019	0,0026	0,0032	0,0038	0,0044	0,0048	0,0050	0,0060	1025 (860 – 1100)
S1	E	0.150	0.50	0.017	0.026	0.034	0.044	0.050	0.070	0.085	0.10	0.12	0.13	0.15	0.17	43 (26 – 60)
		0,150	0,50	0,00065	0,0010	0,0013	0,0017	0,0020	0,0028	0,0034	0,0040	0,0048	0,0050	0,0060	0,0065	140 (86 – 190)
S2	E	0.150	0.50	0.017	0.026	0.034	0.044	0.050	0.070	0.085	0.10	0.12	0.13	0.15	0.17	35 (21 – 48)
		0,150	0,50	0,00065	0,0010	0,0013	0,0017	0,0020	0,0028	0,0034	0,0040	0,0048	0,0050	0,0060	0,0065	115 (69 – 150)
S3	E	0.150	0.50	0.016	0.024	0.032	0.040	0.048	0.065	0.080	0.095	0.11	0.12	0.14	0.15	30 (19 – 42)
		0,150	0,50	0,00065	0,00095	0,0013	0,0016	0,0019	0,0026	0,0032	0,0038	0,0044	0,0048	0,0055	0,0060	100 (63 – 130)
S11	E	0.400	1.0	0.012	0.018	0.024	0.030	0.036	0.048	0.060	0.070	0.080	0.090	0.10	0.12	110 (78 – 130)
		0,400	1,0	0,00048	0,00070	0,00095	0,0012	0,0014	0,0019	0,0024	0,0028	0,0032	0,0036	0,0040	0,0048	360 (260 – 420)
S12	E	0.400	1.0	0.012	0.018	0.024	0.030	0.036	0.048	0.060	0.070	0.080	0.090	0.10	0.12	85 (60 – 100)
		0,400	1,0	0,00048	0,00070	0,00095	0,0012	0,0014	0,0019	0,0024	0,0028	0,0032	0,0036	0,0040	0,0048	280 (200 – 320)
S13	E	0.400	1.0	0.011	0.016	0.022	0.026	0.032	0.042	0.055	0.065	0.070	0.080	0.090	0.10	65 (48 – 84)
		0,400	1,0	0,00044	0,00065	0,00085	0,0010	0,0013	0,0017	0,0022	0,0026	0,0028	0,0032	0,0036	0,0040	215 (160 – 270)
H5	M/A/D	0.200	0.90	0.013	0.020	0.026	0.032	0.040	0.050	0.065	0.075	0.085	0.095	0.11	0.12	75 (62 – 91)
		0,200	0,90	0,00050	0,00080	0,0010	0,0013	0,0016	0,0020	0,0026	0,0030	0,0034	0,0038	0,0044	0,0048	245 (210 – 290)
H8	M/A/D	0.200	0.90	0.010	0.015	0.020	0.025	0.030	0.040	0.050	0.060	0.065	0.075	0.085	0.095	80 (65 – 96)
		0,200	0,90	0,00040	0,00060	0,00080	0,0010	0,0012	0,0016	0,0020	0,0024	0,0026	0,0030	0,0034	0,0038	260 (220 – 310)
H21	M/A/D	0.200	0.90	0.010	0.015	0.020	0.025	0.030	0.040	0.050	0.060	0.065	0.075	0.085	0.095	80 (65 – 96)
		0,200	0,90	0,00040	0,00060	0,00080	0,0010	0,0012	0,0016	0,0020	0,0024	0,0026	0,0030	0,0034	0,0038	260 (220 – 310)
H31	M/A/D	0.200	0.90	0.010	0.015	0.020	0.025	0.030	0.040	0.050	0.060	0.065	0.075	0.085	0.095	60 (49 – 72)
		0,200	0,90	0,00040	0,00060	0,00080	0,0010	0,0012	0,0016	0,0020	0,0024	0,0026	0,0030	0,0034	0,0038	195 (170 – 230)
TS1	A	0.500	1.2	0.020	0.030	0.040	0.050	0.060	0.080	0.10	0.12	0.13	0.15	0.17	0.19	290 (180 – 400)
		0,500	1,2	0,00080	0,0012	0,0016	0,0020	0,0024	0,0032	0,0040	0,0048	0,0050	0,0060	0,0065	0,0075	950 (600 – 1300)
TP1	A	0.500	1.2	0.020	0.030	0.040	0.050	0.060	0.080	0.10	0.12	0.13	0.15	0.17	0.19	300 (180 – 410)
		0,500	1,2	0,00080	0,0012	0,0016	0,0020	0,0024	0,0032	0,0040	0,0048	0,0050	0,0060	0,0065	0,0075	980 (600 – 1300)
GR1	A	0.500	1.2	0.020	0.030	0.040	0.050	0.060	0.080	0.10	0.12	0.13	0.15	0.17	0.19	580 (470 – 690)
		0,500	1,2	0,00080	0,0012	0,0016	0,0020	0,0024	0,0032	0,0040	0,0048	0,0050	0,0060	0,0065	0,0075	1900 (1600 – 2200)

For cutting data recalculations, see pages 556 - 563

SMG = Seco material group
 Coolant = A=air D=dry E=emulsion M=mist spray
 v_c = m/min (sf/min)
 f_z = mm (in/tooth)
 a_p = mm/DC (in/DC) = factor
 a_e = mm/DC (in/DC) = factor
 All cutting data are target values

Universal
 Steel and cast iron
 Stainless steel and S-materials
 Non ferrous
 Hard
 Plastic and CFRP
 Graphite
 X-Heads
 Minimax Plus
 Minimaxter

Cutting data – JS553 Slot milling

SMG		a _p /DC	f _z												v _c
			2	3	4	5	6	8	10	12	14	16	20	25	
P1	M/A/D/E	1.0	0.014	0.020	0.028	0.034	0.042	0.055	0.070	0.085	0.10	0.11	0.14	0.17	195 (170 – 220)
		1.0	0,00055	0,00080	0,0011	0,0013	0,0017	0,0022	0,0028	0,0034	0,0040	0,0044	0,0055	0,0065	640 (560 – 720)
P2	M/A/D/E	1.0	0.014	0.020	0.028	0.034	0.042	0.055	0.070	0.085	0.10	0.11	0.14	0.17	190 (170 – 210)
		1.0	0,00055	0,00080	0,0011	0,0013	0,0017	0,0022	0,0028	0,0034	0,0040	0,0044	0,0055	0,0065	620 (560 – 680)
P3	M/A/D/E	1.0	0.014	0.020	0.028	0.034	0.042	0.055	0.070	0.085	0.10	0.11	0.14	0.17	165 (140 – 180)
		1.0	0,00055	0,00080	0,0011	0,0013	0,0017	0,0022	0,0028	0,0034	0,0040	0,0044	0,0055	0,0065	540 (460 – 590)
P4	M/A/D/E	1.0	0.014	0.020	0.028	0.034	0.042	0.055	0.070	0.085	0.10	0.11	0.14	0.17	145 (130 – 160)
		1.0	0,00055	0,00080	0,0011	0,0013	0,0017	0,0022	0,0028	0,0034	0,0040	0,0044	0,0055	0,0065	475 (430 – 520)
P5	M/A/D/E	1.0	0.014	0.020	0.028	0.034	0.042	0.055	0.070	0.085	0.10	0.11	0.14	0.17	135 (120 – 150)
		1.0	0,00055	0,00080	0,0011	0,0013	0,0017	0,0022	0,0028	0,0034	0,0040	0,0044	0,0055	0,0065	445 (400 – 490)
P6	M/A/D/E	1.0	0.014	0.020	0.028	0.034	0.042	0.055	0.070	0.085	0.10	0.11	0.14	0.17	155 (140 – 170)
		1.0	0,00055	0,00080	0,0011	0,0013	0,0017	0,0022	0,0028	0,0034	0,0040	0,0044	0,0055	0,0065	510 (460 – 550)
P7	M/A/D/E	1.0	0.014	0.020	0.028	0.034	0.042	0.055	0.070	0.085	0.10	0.11	0.14	0.17	145 (130 – 160)
		1.0	0,00055	0,00080	0,0011	0,0013	0,0017	0,0022	0,0028	0,0034	0,0040	0,0044	0,0055	0,0065	475 (430 – 520)
P8	M/A/D/E	1.0	0.014	0.020	0.028	0.034	0.042	0.055	0.070	0.085	0.10	0.11	0.14	0.17	135 (120 – 150)
		1.0	0,00055	0,00080	0,0011	0,0013	0,0017	0,0022	0,0028	0,0034	0,0040	0,0044	0,0055	0,0065	445 (400 – 490)
P11	M/A/D/E	0.80	0.010	0.015	0.020	0.025	0.030	0.040	0.050	0.060	0.070	0.080	0.10	0.13	130 (120 – 140)
		0.80	0,00040	0,00060	0,00080	0,0010	0,0012	0,0016	0,0020	0,0024	0,0028	0,0032	0,0040	0,0050	425 (400 – 450)
P12	M/A/D/E	0.80	0.010	0.015	0.020	0.025	0.030	0.040	0.050	0.060	0.070	0.080	0.10	0.11	80 (69 – 87)
		0.80	0,00040	0,00060	0,00080	0,0010	0,0012	0,0016	0,0020	0,0024	0,0028	0,0032	0,0040	0,0044	260 (230 – 280)
M1	E	0.80	0.010	0.015	0.020	0.025	0.030	0.040	0.050	0.060	0.070	0.080	0.10	0.13	95 (85 – 100)
		0.80	0,00040	0,00060	0,00080	0,0010	0,0012	0,0016	0,0020	0,0024	0,0028	0,0032	0,0040	0,0050	310 (280 – 320)
M2	E	0.80	0.010	0.015	0.020	0.025	0.030	0.040	0.050	0.060	0.070	0.080	0.10	0.11	80 (69 – 87)
		0.80	0,00040	0,00060	0,00080	0,0010	0,0012	0,0016	0,0020	0,0024	0,0028	0,0032	0,0040	0,0044	260 (230 – 280)
M3	E	0.70	0.0080	0.012	0.016	0.020	0.025	0.032	0.040	0.050	0.055	0.065	0.080	0.095	48 (39 – 58)
		0.70	0,00032	0,00048	0,00065	0,00080	0,0010	0,0013	0,0016	0,0020	0,0022	0,0026	0,0032	0,0038	155 (130 – 190)
M4	E	0.70	0.0080	0.012	0.016	0.020	0.025	0.032	0.040	0.050	0.055	0.065	0.075	0.085	36 (30 – 43)
		0.70	0,00032	0,00048	0,00065	0,00080	0,0010	0,0013	0,0016	0,0020	0,0022	0,0026	0,0030	0,0034	120 (99 – 140)
M5	E	0.70	0.0080	0.012	0.016	0.020	0.025	0.032	0.040	0.050	0.055	0.065	0.075	0.085	30 (25 – 36)
		0.70	0,00032	0,00048	0,00065	0,00080	0,0010	0,0013	0,0016	0,0020	0,0022	0,0026	0,0030	0,0034	100 (83 – 110)
K1	E	1.0	0.010	0.015	0.020	0.025	0.030	0.040	0.050	0.060	0.070	0.080	0.10	0.13	145 (140 – 170)
		1.0	0,00040	0,00060	0,00080	0,0010	0,0012	0,0016	0,0020	0,0024	0,0028	0,0032	0,0040	0,0050	475 (460 – 550)
K2	E	1.0	0.010	0.015	0.020	0.025	0.030	0.040	0.050	0.060	0.070	0.080	0.10	0.13	125 (120 – 150)
		1.0	0,00040	0,00060	0,00080	0,0010	0,0012	0,0016	0,0020	0,0024	0,0028	0,0032	0,0040	0,0050	410 (400 – 490)
K3	E	1.0	0.010	0.015	0.020	0.025	0.030	0.040	0.050	0.060	0.070	0.080	0.10	0.13	110 (110 – 120)
		1.0	0,00040	0,00060	0,00080	0,0010	0,0012	0,0016	0,0020	0,0024	0,0028	0,0032	0,0040	0,0050	360 (370 – 390)
K4	E	1.0	0.010	0.015	0.020	0.025	0.030	0.040	0.050	0.060	0.070	0.080	0.10	0.13	105 (96 – 120)
		1.0	0,00040	0,00060	0,00080	0,0010	0,0012	0,0016	0,0020	0,0024	0,0028	0,0032	0,0040	0,0050	345 (320 – 390)
K5	E	0.80	0.010	0.015	0.020	0.025	0.030	0.040	0.050	0.060	0.070	0.080	0.10	0.13	135 (120 – 150)
		0.80	0,00040	0,00060	0,00080	0,0010	0,0012	0,0016	0,0020	0,0024	0,0028	0,0032	0,0040	0,0050	445 (400 – 490)
K6	E	0.80	0.010	0.015	0.020	0.025	0.030	0.040	0.050	0.060	0.070	0.080	0.10	0.13	200 (180 – 230)
		0.80	0,00040	0,00060	0,00080	0,0010	0,0012	0,0016	0,0020	0,0024	0,0028	0,0032	0,0040	0,0050	660 (600 – 750)
K7	E	0.80	0.010	0.015	0.020	0.025	0.030	0.040	0.050	0.060	0.070	0.080	0.10	0.13	175 (150 – 190)
		0.80	0,00040	0,00060	0,00080	0,0010	0,0012	0,0016	0,0020	0,0024	0,0028	0,0032	0,0040	0,0050	570 (500 – 620)

For cutting data recalculations, see pages 556 - 563

SMG = Seco material group
Coolant = A=air D=dry E=emulsion M=mist spray
v_c = m/min (sf/min)
f_z = mm/tooth (in/tooth)
a_p = mm/DC (in/DC) = factor
a_e = mm/DC (in/DC) = factor
All cutting data are target values

Cutting data – JS553 Slot milling

SMG		a _p /DC	f _z												v _c
			2	3	4	5	6	8	10	12	14	16	20	25	
N1	E	0.70	0.010	0.015	0.020	0.025	0.030	0.040	0.050	0.060	0.070	0.080	0.10	0.13	580 (490 – 670)
		0,70	0,00040	0,00060	0,00080	0,0010	0,0012	0,0016	0,0020	0,0024	0,0028	0,0032	0,0040	0,0050	1900 (1700 – 2100)
N2	E	0.70	0.010	0.015	0.020	0.025	0.030	0.040	0.050	0.060	0.070	0.080	0.10	0.13	375 (320 – 430)
		0,70	0,00040	0,00060	0,00080	0,0010	0,0012	0,0016	0,0020	0,0024	0,0028	0,0032	0,0040	0,0050	1225 (1100 – 1400)
N3	E	0.70	0.010	0.015	0.020	0.025	0.030	0.040	0.050	0.060	0.070	0.080	0.10	0.13	250 (210 – 290)
		0,70	0,00040	0,00060	0,00080	0,0010	0,0012	0,0016	0,0020	0,0024	0,0028	0,0032	0,0040	0,0050	820 (690 – 950)
N11	E	0.60	0.010	0.015	0.020	0.025	0.030	0.040	0.050	0.060	0.070	0.080	0.10	0.13	290 (250 – 330)
		0,60	0,00040	0,00060	0,00080	0,0010	0,0012	0,0016	0,0020	0,0024	0,0028	0,0032	0,0040	0,0050	950 (830 – 1000)
S1	E	0.30	0.0065	0.0095	0.013	0.016	0.019	0.025	0.032	0.038	0.044	0.050	0.065	0.080	34 (21 – 47)
		0,30	0,00026	0,00038	0,00050	0,00065	0,00075	0,0010	0,0013	0,0015	0,0017	0,0020	0,0026	0,0032	110 (69 – 150)
S2	E	0.30	0.0065	0.0095	0.013	0.016	0.019	0.025	0.032	0.038	0.044	0.050	0.065	0.080	27 (17 – 38)
		0,30	0,00026	0,00038	0,00050	0,00065	0,00075	0,0010	0,0013	0,0015	0,0017	0,0020	0,0026	0,0032	90 (56 – 120)
S3	E	0.30	0.0065	0.0095	0.013	0.016	0.019	0.025	0.032	0.038	0.044	0.050	0.065	0.080	23 (15 – 32)
		0,30	0,00026	0,00038	0,00050	0,00065	0,00075	0,0010	0,0013	0,0015	0,0017	0,0020	0,0026	0,0032	75 (50 – 100)
S11	E	0.50	0.012	0.018	0.024	0.030	0.036	0.048	0.060	0.070	0.080	0.090	0.10	0.11	85 (63 – 110)
		0,50	0,00048	0,00070	0,00095	0,0012	0,0014	0,0019	0,0024	0,0028	0,0032	0,0036	0,0040	0,0044	280 (210 – 360)
S12	E	0.50	0.012	0.018	0.024	0.030	0.036	0.048	0.060	0.070	0.080	0.090	0.10	0.11	65 (48 – 86)
		0,50	0,00048	0,00070	0,00095	0,0012	0,0014	0,0019	0,0024	0,0028	0,0032	0,0036	0,0040	0,0044	215 (160 – 280)
S13	E	0.50	0.010	0.016	0.020	0.026	0.032	0.042	0.050	0.060	0.070	0.075	0.090	0.10	55 (39 – 69)
		0,50	0,00040	0,00065	0,00080	0,0010	0,0013	0,0017	0,0020	0,0024	0,0028	0,0030	0,0036	0,0040	180 (130 – 220)
H5	M/A/D	0.50	0.0040	0.0060	0.0080	0.010	0.012	0.016	0.020	0.025	0.028	0.032	0.040	0.050	65 (52 – 77)
		0,50	0,00016	0,00024	0,00032	0,00040	0,00048	0,00065	0,00080	0,0010	0,0011	0,0013	0,0016	0,0020	215 (180 – 250)
H8	M/A/D	0.50	0.0040	0.0060	0.0080	0.010	0.012	0.016	0.020	0.025	0.028	0.032	0.040	0.050	65 (52 – 77)
		0,50	0,00016	0,00024	0,00032	0,00040	0,00048	0,00065	0,00080	0,0010	0,0011	0,0013	0,0016	0,0020	215 (180 – 250)
H11	M/A/D	0.50	0.0040	0.0060	0.0080	0.010	0.012	0.016	0.020	0.025	0.028	0.032	0.040	0.050	80 (66 – 98)
		0,50	0,00016	0,00024	0,00032	0,00040	0,00048	0,00065	0,00080	0,0010	0,0011	0,0013	0,0016	0,0020	260 (220 – 320)
H12	M/A/D	1.0	0.0095	0.014	0.019	0.024	0.028	0.038	0.046	0.055	0.060	0.070	0.080	0.090	65 (52 – 77)
		1,0	0,00038	0,00055	0,00075	0,00095	0,0011	0,0015	0,0018	0,0022	0,0024	0,0028	0,0032	0,0036	215 (180 – 250)
H21	M/A/D	0.50	0.0040	0.0060	0.0080	0.010	0.012	0.016	0.020	0.025	0.028	0.032	0.040	0.050	65 (52 – 77)
		0,50	0,00016	0,00024	0,00032	0,00040	0,00048	0,00065	0,00080	0,0010	0,0011	0,0013	0,0016	0,0020	215 (180 – 250)
TS1	A	1.0	0.020	0.030	0.040	0.050	0.060	0.080	0.10	0.12	0.13	0.15	0.17	0.19	245 (150 – 340)
		1,0	0,00080	0,0012	0,0016	0,0020	0,0024	0,0032	0,0040	0,0048	0,0050	0,0060	0,0065	0,0075	800 (500 – 1100)
TP1	A	1.0	0.020	0.030	0.040	0.050	0.060	0.080	0.10	0.12	0.13	0.15	0.17	0.19	250 (160 – 350)
		1,0	0,00080	0,0012	0,0016	0,0020	0,0024	0,0032	0,0040	0,0048	0,0050	0,0060	0,0065	0,0075	820 (530 – 1100)
GR1	A	1.0	0.020	0.030	0.040	0.050	0.060	0.080	0.10	0.12	0.13	0.15	0.17	0.19	490 (400 – 580)
		1,0	0,00080	0,0012	0,0016	0,0020	0,0024	0,0032	0,0040	0,0048	0,0050	0,0060	0,0065	0,0075	1600 (1400 – 1900)

For cutting data recalculations, see pages 556 - 563

SMG = Seco material group
 Coolant = A=air D=dry E=emulsion M=mist spray
 v_c = m/min (sf/min)
 f_z = mm/tooth (in/tooth)
 a_p = mm/DC (in/DC) = factor
 a_e = mm/DC (in/DC) = factor
 All cutting data are target values

Universal
 Steel and cast iron
 Stainless steel and S-materials
 Non ferrous
 Hard
 Plastic and CFRP
 Graphite
 X-Heads
 Minimaster Plus
 Minimaster

Cutting data – JS553 Side milling – Inch

SMG	Coolant	a _e /DC	a _p /DC	f _z						v _c
				1/8	3/16	1/4	5/16	3/8	1/2	
P1	M/A/D/E	0.400	1.0	0.032	0.048	0.065	0.080	0.095	0.12	225 (200 – 250)
		0,400	1,0	0,0013	0,0019	0,0026	0,0032	0,0038	0,0048	740 (660 – 820)
P2	M/A/D/E	0.400	1.0	0.032	0.048	0.065	0.080	0.095	0.13	220 (190 – 240)
		0,400	1,0	0,0013	0,0019	0,0026	0,0032	0,0038	0,0050	720 (630 – 780)
P3	M/A/D/E	0.400	1.0	0.030	0.046	0.060	0.075	0.090	0.12	190 (170 – 210)
		0,400	1,0	0,0012	0,0018	0,0024	0,0030	0,0036	0,0048	620 (560 – 680)
P4	M/A/D/E	0.400	1.0	0.030	0.044	0.060	0.075	0.090	0.12	165 (150 – 190)
		0,400	1,0	0,0012	0,0017	0,0024	0,0030	0,0036	0,0048	540 (500 – 620)
P5	M/A/D/E	0.400	1.0	0.030	0.044	0.060	0.075	0.085	0.11	160 (140 – 180)
		0,400	1,0	0,0012	0,0017	0,0024	0,0030	0,0034	0,0044	520 (460 – 590)
P6	M/A/D/E	0.400	1.0	0.028	0.044	0.060	0.070	0.085	0.11	180 (160 – 200)
		0,400	1,0	0,0011	0,0017	0,0024	0,0028	0,0034	0,0044	590 (530 – 650)
P7	M/A/D/E	0.400	1.0	0.028	0.044	0.060	0.070	0.085	0.11	170 (150 – 190)
		0,400	1,0	0,0011	0,0017	0,0024	0,0028	0,0034	0,0044	560 (500 – 620)
P8	M/A/D/E	0.400	1.0	0.030	0.046	0.060	0.075	0.090	0.12	160 (140 – 180)
		0,400	1,0	0,0012	0,0018	0,0024	0,0030	0,0036	0,0048	520 (460 – 590)
P11	M/A/D/E	0.400	1.0	0.028	0.042	0.055	0.070	0.085	0.11	145 (130 – 160)
		0,400	1,0	0,0011	0,0017	0,0022	0,0028	0,0034	0,0044	475 (430 – 520)
P12	M/A/D/E	0.400	1.0	0.019	0.030	0.038	0.048	0.060	0.075	95 (82 – 100)
		0,400	1,0	0,00075	0,0012	0,0015	0,0019	0,0024	0,0030	310 (270 – 320)
M1	E	0.400	1.0	0.022	0.032	0.042	0.055	0.065	0.085	115 (100 – 120)
		0,400	1,0	0,00085	0,0013	0,0017	0,0022	0,0026	0,0034	375 (330 – 390)
M2	E	0.400	1.0	0.019	0.030	0.038	0.048	0.060	0.075	95 (82 – 100)
		0,400	1,0	0,00075	0,0012	0,0015	0,0019	0,0024	0,0030	310 (270 – 320)
M3	E	0.400	1.0	0.016	0.024	0.032	0.040	0.048	0.065	60 (47 – 69)
		0,400	1,0	0,00065	0,00095	0,0013	0,0016	0,0019	0,0026	195 (160 – 220)
M4	E	0.400	1.0	0.014	0.022	0.028	0.036	0.042	0.055	45 (36 – 53)
		0,400	1,0	0,00055	0,00085	0,0011	0,0014	0,0017	0,0022	150 (120 – 170)
M5	E	0.400	1.0	0.014	0.022	0.028	0.036	0.042	0.055	37 (30 – 44)
		0,400	1,0	0,00055	0,00085	0,0011	0,0014	0,0017	0,0022	120 (99 – 140)
K1	E	0.400	1.2	0.026	0.038	0.050	0.065	0.080	0.10	165 (160 – 190)
		0,400	1,2	0,0010	0,0015	0,0020	0,0026	0,0032	0,0040	540 (530 – 620)
K2	E	0.400	1.2	0.024	0.036	0.048	0.060	0.070	0.090	145 (140 – 170)
		0,400	1,2	0,00095	0,0014	0,0019	0,0024	0,0028	0,0036	475 (460 – 550)
K3	E	0.400	1.2	0.024	0.036	0.048	0.060	0.070	0.090	125 (120 – 140)
		0,400	1,2	0,00095	0,0014	0,0019	0,0024	0,0028	0,0036	410 (400 – 450)
K4	E	0.400	1.2	0.024	0.036	0.048	0.060	0.070	0.090	120 (110 – 140)
		0,400	1,2	0,00095	0,0014	0,0019	0,0024	0,0028	0,0036	395 (370 – 450)
K5	E	0.400	1.1	0.026	0.038	0.050	0.065	0.080	0.10	155 (140 – 170)
		0,400	1,1	0,0010	0,0015	0,0020	0,0026	0,0032	0,0040	510 (460 – 550)
K6	E	0.400	1.1	0.028	0.044	0.060	0.070	0.085	0.11	220 (190 – 250)
		0,400	1,1	0,0011	0,0017	0,0024	0,0028	0,0034	0,0044	720 (630 – 820)
K7	E	0.400	1.1	0.026	0.038	0.050	0.065	0.080	0.10	195 (170 – 220)
		0,400	1,1	0,0010	0,0015	0,0020	0,0026	0,0032	0,0040	640 (560 – 720)

For cutting data recalculations, see pages 556 - 563

SMG = Seco material group
Coolant = A=air D=dry E=emulsion M=mist spray
v_c = m/min (sf/min)
f_z = mm/tooth (in/tooth)
a_p = mm/DC (in/DC) = factor
a_e = mm/DC (in/DC) = factor
All cutting data are target values

Cutting data – JS553 Side milling – Inch

SMG		a _e /DC	a _p /DC	f _z						v _c
				1/8	3/16	1/4	5/16	3/8	1/2	
N1	E	0.500	1.0	0.025	0.038	0.050	0.065	0.075	0.10	620 (520 – 720)
		0,500	1,0	0,0010	0,0015	0,0020	0,0026	0,0030	0,0040	2025 (1800 – 2300)
N2	E	0.500	1.0	0.025	0.038	0.050	0.065	0.075	0.10	400 (340 – 460)
		0,500	1,0	0,0010	0,0015	0,0020	0,0026	0,0030	0,0040	1300 (1200 – 1500)
N3	E	0.500	1.0	0.025	0.038	0.050	0.065	0.075	0.10	265 (230 – 300)
		0,500	1,0	0,0010	0,0015	0,0020	0,0026	0,0030	0,0040	870 (760 – 980)
N11	E	0.500	1.1	0.025	0.038	0.050	0.065	0.075	0.10	310 (260 – 350)
		0,500	1,1	0,0010	0,0015	0,0020	0,0026	0,0030	0,0040	1025 (860 – 1100)
S1	E	0.150	0.50	0.028	0.042	0.055	0.070	0.085	0.11	43 (26 – 60)
		0,150	0,50	0,0011	0,0017	0,0022	0,0028	0,0034	0,0044	140 (86 – 190)
S2	E	0.150	0.50	0.028	0.042	0.055	0.070	0.085	0.11	35 (21 – 48)
		0,150	0,50	0,0011	0,0017	0,0022	0,0028	0,0034	0,0044	115 (69 – 150)
S3	E	0.150	0.50	0.026	0.038	0.050	0.065	0.075	0.10	30 (19 – 42)
		0,150	0,50	0,0010	0,0015	0,0020	0,0026	0,0030	0,0040	100 (63 – 130)
S11	E	0.400	1.0	0.019	0.030	0.038	0.048	0.060	0.075	110 (78 – 130)
		0,400	1,0	0,00075	0,0012	0,0015	0,0019	0,0024	0,0030	360 (260 – 420)
S12	E	0.400	1.0	0.019	0.030	0.038	0.048	0.060	0.075	85 (60 – 100)
		0,400	1,0	0,00075	0,0012	0,0015	0,0019	0,0024	0,0030	280 (200 – 320)
S13	E	0.400	1.0	0.017	0.025	0.034	0.042	0.050	0.065	65 (48 – 84)
		0,400	1,0	0,00065	0,0010	0,0013	0,0017	0,0020	0,0026	215 (160 – 270)
H5	M/A/D	0.200	0.90	0.020	0.032	0.042	0.050	0.060	0.080	75 (62 – 91)
		0,200	0,90	0,00080	0,0013	0,0017	0,0020	0,0024	0,0032	245 (210 – 290)
H8	M/A/D	0.200	0.90	0.016	0.024	0.032	0.040	0.048	0.060	80 (65 – 96)
		0,200	0,90	0,00065	0,00095	0,0013	0,0016	0,0019	0,0024	260 (220 – 310)
H21	M/A/D	0.200	0.90	0.016	0.024	0.032	0.040	0.048	0.060	80 (65 – 96)
		0,200	0,90	0,00065	0,00095	0,0013	0,0016	0,0019	0,0024	260 (220 – 310)
H31	M/A/D	0.200	0.90	0.016	0.024	0.032	0.040	0.048	0.060	60 (49 – 72)
		0,200	0,90	0,00065	0,00095	0,0013	0,0016	0,0019	0,0024	195 (170 – 230)
TS1	A	0.500	1.2	0.032	0.048	0.065	0.080	0.095	0.12	290 (180 – 400)
		0,500	1,2	0,0013	0,0019	0,0026	0,0032	0,0038	0,0048	950 (600 – 1300)
TP1	A	0.500	1.2	0.032	0.048	0.065	0.080	0.095	0.12	300 (180 – 410)
		0,500	1,2	0,0013	0,0019	0,0026	0,0032	0,0038	0,0048	980 (600 – 1300)
GR1	A	0.500	1.2	0.032	0.048	0.065	0.080	0.095	0.12	580 (470 – 690)
		0,500	1,2	0,0013	0,0019	0,0026	0,0032	0,0038	0,0048	1900 (1600 – 2200)

For cutting data recalculations, see pages 556 - 563

SMG = Seco material group
 Coolant = A=air D=dry E=emulsion M=mist spray
 v_c= m/min (sf/min)
 f_z = mm/tooth (in/tooth)
 a_p = mm/DC (in/DC) = factor
 a_e = mm/DC (in/DC) = factor
 All cutting data are target values

Universal
 Steel and cast iron
 Stainless steel and S-materials
 Non ferrous
 Hard
 Plastic and cfrp
 Graphite
 X-Heads
 Mimimaster Plus
 Mimimaster

Cutting data – JS553 Slot milling – Inch

SMG		a _p /DC	f _z						v _c
			1/8	3/16	1/4	5/16	3/8	1/2	
P1	M/A/D/E	1.0	0.022	0.034	0.044	0.055	0.065	0.090	195 (170 – 220)
		1,0	0,00085	0,0013	0,0017	0,0022	0,0026	0,0036	640 (560 – 720)
P2	M/A/D/E	1.0	0.022	0.034	0.044	0.055	0.065	0.090	190 (170 – 210)
		1,0	0,00085	0,0013	0,0017	0,0022	0,0026	0,0036	620 (560 – 680)
P3	M/A/D/E	1.0	0.022	0.034	0.044	0.055	0.065	0.090	165 (140 – 180)
		1,0	0,00085	0,0013	0,0017	0,0022	0,0026	0,0036	540 (460 – 590)
P4	M/A/D/E	1.0	0.022	0.034	0.044	0.055	0.065	0.090	145 (130 – 160)
		1,0	0,00085	0,0013	0,0017	0,0022	0,0026	0,0036	475 (430 – 520)
P5	M/A/D/E	1.0	0.022	0.034	0.044	0.055	0.065	0.090	135 (120 – 150)
		1,0	0,00085	0,0013	0,0017	0,0022	0,0026	0,0036	445 (400 – 490)
P6	M/A/D/E	1.0	0.022	0.034	0.044	0.055	0.065	0.090	155 (140 – 170)
		1,0	0,00085	0,0013	0,0017	0,0022	0,0026	0,0036	510 (460 – 550)
P7	M/A/D/E	1.0	0.022	0.034	0.044	0.055	0.065	0.090	145 (130 – 160)
		1,0	0,00085	0,0013	0,0017	0,0022	0,0026	0,0036	475 (430 – 520)
P8	M/A/D/E	1.0	0.022	0.034	0.044	0.055	0.065	0.090	135 (120 – 150)
		1,0	0,00085	0,0013	0,0017	0,0022	0,0026	0,0036	445 (400 – 490)
P11	M/A/D/E	0.80	0.016	0.024	0.032	0.040	0.048	0.065	130 (120 – 140)
		0,80	0,00065	0,00095	0,0013	0,0016	0,0019	0,0026	425 (400 – 450)
P12	M/A/D/E	0.80	0.016	0.024	0.032	0.040	0.048	0.065	80 (69 – 87)
		0,80	0,00065	0,00095	0,0013	0,0016	0,0019	0,0026	260 (230 – 280)
M1	E	0.80	0.016	0.024	0.032	0.040	0.048	0.065	95 (85 – 100)
		0,80	0,00065	0,00095	0,0013	0,0016	0,0019	0,0026	310 (280 – 320)
M2	E	0.80	0.016	0.024	0.032	0.040	0.048	0.065	80 (69 – 87)
		0,80	0,00065	0,00095	0,0013	0,0016	0,0019	0,0026	260 (230 – 280)
M3	E	0.70	0.013	0.019	0.026	0.032	0.038	0.050	48 (39 – 58)
		0,70	0,00050	0,00075	0,0010	0,0013	0,0015	0,0020	155 (130 – 190)
M4	E	0.70	0.013	0.019	0.026	0.032	0.038	0.050	36 (30 – 43)
		0,70	0,00050	0,00075	0,0010	0,0013	0,0015	0,0020	120 (99 – 140)
M5	E	0.70	0.013	0.019	0.026	0.032	0.038	0.050	30 (25 – 36)
		0,70	0,00050	0,00075	0,0010	0,0013	0,0015	0,0020	100 (83 – 110)
K1	E	1.0	0.016	0.024	0.032	0.040	0.048	0.065	145 (140 – 170)
		1,0	0,00065	0,00095	0,0013	0,0016	0,0019	0,0026	475 (460 – 550)
K2	E	1.0	0.016	0.024	0.032	0.040	0.048	0.065	125 (120 – 150)
		1,0	0,00065	0,00095	0,0013	0,0016	0,0019	0,0026	410 (400 – 490)
K3	E	1.0	0.016	0.024	0.032	0.040	0.048	0.065	110 (110 – 120)
		1,0	0,00065	0,00095	0,0013	0,0016	0,0019	0,0026	360 (370 – 390)
K4	E	1.0	0.016	0.024	0.032	0.040	0.048	0.065	105 (96 – 120)
		1,0	0,00065	0,00095	0,0013	0,0016	0,0019	0,0026	345 (320 – 390)
K5	E	0.80	0.016	0.024	0.032	0.040	0.048	0.065	135 (120 – 150)
		0,80	0,00065	0,00095	0,0013	0,0016	0,0019	0,0026	445 (400 – 490)
K6	E	0.80	0.016	0.024	0.032	0.040	0.048	0.065	200 (180 – 230)
		0,80	0,00065	0,00095	0,0013	0,0016	0,0019	0,0026	660 (600 – 750)
K7	E	0.80	0.016	0.024	0.032	0.040	0.048	0.065	175 (150 – 190)
		0,80	0,00065	0,00095	0,0013	0,0016	0,0019	0,0026	570 (500 – 620)

For cutting data recalculations, see pages 556 - 563

SMG = Seco material group
Coolant = A=air D=dry E=emulsion M=mist spray
v_c = m/min (sf/min)
f_z = mm/tooth (in/tooth)
a_p = mm/DC (in/DC) = factor
a_e = mm/DC (in/DC) = factor
All cutting data are target values

Cutting data – JS553 Slot milling – Inch

SMG		a _p /DC	f _z						v _c
			1/8	3/16	1/4	5/16	3/8	1/2	
N1	E	0.70	0.016	0.024	0.032	0.040	0.048	0.065	580 (490 – 670)
		0.70	0,00065	0,00095	0,0013	0,0016	0,0019	0,0026	1900 (1700 – 2100)
N2	E	0.70	0.016	0.024	0.032	0.040	0.048	0.065	375 (320 – 430)
		0.70	0,00065	0,00095	0,0013	0,0016	0,0019	0,0026	1225 (1100 – 1400)
N3	E	0.70	0.016	0.024	0.032	0.040	0.048	0.065	250 (210 – 290)
		0.70	0,00065	0,00095	0,0013	0,0016	0,0019	0,0026	820 (690 – 950)
N11	E	0.60	0.016	0.024	0.032	0.040	0.048	0.065	290 (250 – 330)
		0.60	0,00065	0,00095	0,0013	0,0016	0,0019	0,0026	950 (830 – 1000)
S1	E	0.30	0.010	0.015	0.020	0.025	0.030	0.040	34 (21 – 47)
		0.30	0,00040	0,00060	0,00080	0,0010	0,0012	0,0016	110 (69 – 150)
S2	E	0.30	0.010	0.015	0.020	0.025	0.030	0.040	27 (17 – 38)
		0.30	0,00040	0,00060	0,00080	0,0010	0,0012	0,0016	90 (56 – 120)
S3	E	0.30	0.010	0.015	0.020	0.025	0.030	0.040	23 (15 – 32)
		0.30	0,00040	0,00060	0,00080	0,0010	0,0012	0,0016	75 (50 – 100)
S11	E	0.50	0.019	0.028	0.038	0.048	0.055	0.075	85 (63 – 110)
		0.50	0,00075	0,0011	0,0015	0,0019	0,0022	0,0030	280 (210 – 360)
S12	E	0.50	0.019	0.028	0.038	0.048	0.055	0.075	65 (48 – 86)
		0.50	0,00075	0,0011	0,0015	0,0019	0,0022	0,0030	215 (160 – 280)
S13	E	0.50	0.017	0.025	0.034	0.042	0.050	0.065	55 (39 – 69)
		0.50	0,00065	0,0010	0,0013	0,0017	0,0020	0,0026	180 (130 – 220)
H5	M/A/D	0.50	0.0065	0.0095	0.013	0.016	0.019	0.026	65 (52 – 77)
		0.50	0,00026	0,00038	0,00050	0,00065	0,00075	0,0010	215 (180 – 250)
H8	M/A/D	0.50	0.0065	0.0095	0.013	0.016	0.019	0.026	65 (52 – 77)
		0.50	0,00026	0,00038	0,00050	0,00065	0,00075	0,0010	215 (180 – 250)
H21	M/A/D	0.50	0.0065	0.0095	0.013	0.016	0.019	0.026	65 (52 – 77)
		0.50	0,00026	0,00038	0,00050	0,00065	0,00075	0,0010	215 (180 – 250)
H31	M/A/D	0.50	0.0065	0.0095	0.013	0.016	0.019	0.026	49 (39 – 58)
		0.50	0,00026	0,00038	0,00050	0,00065	0,00075	0,0010	160 (130 – 190)
TS1	A	1.0	0.032	0.048	0.065	0.080	0.095	0.12	245 (150 – 340)
		1.0	0,0013	0,0019	0,0026	0,0032	0,0038	0,0048	800 (500 – 1100)
TP1	A	1.0	0.032	0.048	0.065	0.080	0.095	0.12	250 (160 – 350)
		1.0	0,0013	0,0019	0,0026	0,0032	0,0038	0,0048	820 (530 – 1100)
GR1	A	1.0	0.032	0.048	0.065	0.080	0.095	0.12	490 (400 – 580)
		1.0	0,0013	0,0019	0,0026	0,0032	0,0038	0,0048	1600 (1400 – 1900)

For cutting data recalculations, see pages 556 - 563

SMG = Seco material group
 Coolant = A=air D=dry E=emulsion M=mist spray
 v_c = m/min (sf/min)
 f_z = mm/tooth (in/tooth)
 a_p = mm/DC (in/DC) = factor
 a_e = mm/DC (in/DC) = factor
 All cutting data are target values

Universal
 Steel and cast iron
 Stainless steel and S-materials
 Non ferrous
 Hard
 Plastic and cfrp
 Graphite
 X-Heads
 Minmaster Plus
 Minmaster

JS554

High performance – Universal – Square – 4 Flutes – Cylindrical – Sharp

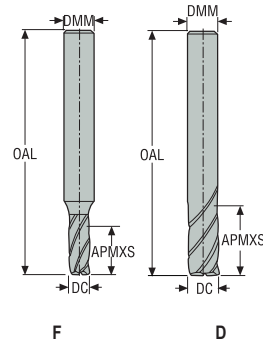

- Tolerances:
- DMM=h5
- DC=e7
- Regrind possible if DC is $\geq \varnothing 6$

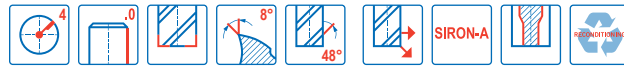

Designation	Item number	Length index	Tool shape	DC	DMM	APMXS	OAL	PCEDC	Cylindrical
				mm	mm	mm	mm		
554030SZ4.0-SIRON-A	02733453	2	F	3,0	6,0	7,0	50,0	4	■
554040SZ4.0-SIRON-A	02733458	2	F	4,0	6,0	10,0	55,0	4	■
554050SZ4.0-SIRON-A	02733812	2	F	5,0	6,0	12,0	55,0	4	■
554060SZ4.0-SIRON-A	02733814	2	D	6,0	6,0	14,0	55,0	4	■
554080SZ4.0-SIRON-A	02733815	2	D	8,0	8,0	18,0	60,0	4	■
554100SZ4.0-SIRON-A	02733816	2	D	10,0	10,0	22,0	70,0	4	■

■ Stocked standard.

Universal

Steel and cast iron

Stainless steel and S-materials

Non ferrous

Hard

Plastic and CFRP

Graphite

X-Heads

Minimaster Plus

Minimaster

JS554

High performance – Universal – Square – 4 Flutes – Cylindrical – Chamfer

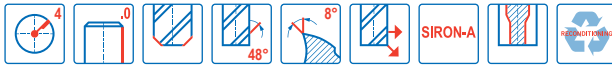
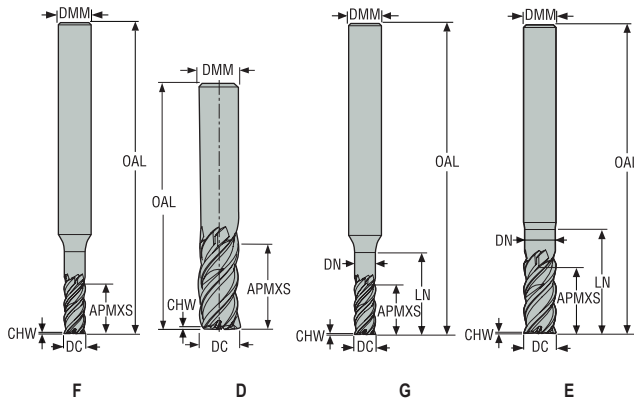

- Tolerances:
- DMM=h5
- DC=e7
- Regrind possible if DC is $\geq \varnothing 6$

Designation	Item number	Length index	Tool shape	DC	DMM	APMXS	OAL	LN	DN	CHW	PCEDC	Cylindrical
				mm	mm	mm	mm	mm	mm	mm		
JS554040F1C.0Z4-SIRA	10041454	1	F	4,0	6,0	6,0	40,0	9,0	4,05	0,045	4	■
JS554060D1C.0Z4-SIRA	10041455	1	D	6,0	6,0	8,0	40,0	-	-	0,075	4	■
JS554080D1C.0Z4-SIRA	10041456	1	D	8,0	8,0	11,0	50,0	-	-	0,1	4	■
JS554100D1C.0Z4-SIRA	10041457	1	D	10,0	10,0	13,0	57,0	-	-	0,125	4	■
JS554120D1C.0Z4-SIRA	10041458	1	D	12,0	12,0	15,0	65,0	-	-	0,15	4	■
JS554160D1C.0Z4-SIRA	10041459	1	D	16,0	16,0	19,0	75,0	-	-	0,2	4	■
554030Z4.0-SIRON-A	02733455	2	F	3,0	6,0	7,0	50,0	8,7	3,0	0,035	4	■
JS554030G2C.0Z4-SIRA	03029956	2	G	3,0	6,0	8,0	57,0	10,0	2,85	0,035	4	■
554040Z4.0-SIRON-A	02733459	2	F	4,0	6,0	10,0	55,0	11,7	4,0	0,045	4	■
JS554040G2C.0Z4-SIRA	03029957	2	G	4,0	6,0	10,0	57,0	13,0	3,8	0,045	4	■
554050Z4.0-SIRON-A	02733813	2	F	5,0	6,0	12,0	55,0	13,7	5,0	0,055	4	■
JS554050G2C.0Z4-SIRA	03029958	2	G	5,0	6,0	12,0	57,0	16,0	4,75	0,055	4	■
554060Z4.0-SIRON-A	02679503	2	D	6,0	6,0	14,0	55,0	-	-	0,075	4	■
JS554060E2C.0Z4-SIRA	03029959	2	E	6,0	6,0	14,0	57,0	18,0	5,7	0,075	4	■
554080Z4.0-SIRON-A	02679512	2	D	8,0	8,0	18,0	60,0	-	-	0,1	4	■
JS554080E2C.0Z4-SIRA	03029961	2	E	8,0	8,0	18,0	63,0	25,0	7,6	0,1	4	■
554100Z4.0-SIRON-A	02679537	2	D	10,0	10,0	22,0	70,0	-	-	0,125	4	■
JS554100E2C.0Z4-SIRA	03029963	2	E	10,0	10,0	22,0	72,0	29,0	9,5	0,125	4	■
554120Z4.0-SIRON-A	02679548	2	D	12,0	12,0	26,0	80,0	-	-	0,15	4	■
JS554120E2C.0Z4-SIRA	03029966	2	E	12,0	12,0	26,0	83,0	35,0	11,4	0,15	4	■
554160Z4.0-SIRON-A	02679560	2	D	16,0	16,0	34,0	90,0	-	-	0,2	4	■
JS554160E2C.0Z4-SIRA	03029970	2	E	16,0	16,0	34,0	92,0	42,0	15,2	0,2	4	■
554200Z4.0-SIRON-A	02679566	2	D	20,0	20,0	42,0	100,0	-	-	0,25	4	■
JS554200E2C.0Z4-SIRA	03029972	2	E	20,0	20,0	42,0	109,0	54,0	19,0	0,25	4	■
554250Z4.0-SIRON-A	02679573	2	D	25,0	25,0	52,0	125,0	-	-	0,3	4	■
554L030Z4.0-SIRON-A	02733818	3	F	3,0	6,0	12,0	55,0	13,7	3,0	0,035	4	■
554L040Z4.0-SIRON-A	02733823	3	F	4,0	6,0	16,0	60,0	17,7	4,0	0,045	4	■
554L050Z4.0-SIRON-A	02733825	3	F	5,0	6,0	20,0	65,0	21,7	5,0	0,055	4	■
554L060Z4.0-SIRON-A	02733828	3	D	6,0	6,0	23,0	65,0	-	-	0,075	4	■
554L080Z4.0-SIRON-A	02733830	3	D	8,0	8,0	32,0	75,0	-	-	0,1	4	■
554L100Z4.0-SIRON-A	02733832	3	D	10,0	10,0	40,0	85,0	-	-	0,125	4	■
554L120Z4.0-SIRON-A	02733834	3	D	12,0	12,0	45,0	100,0	-	-	0,15	4	■
554L160Z4.0-SIRON-A	02733836	3	D	16,0	16,0	55,0	115,0	-	-	0,2	4	■
554L200Z4.0-SIRON-A	02733838	3	D	20,0	20,0	65,0	125,0	-	-	0,25	4	■
554L250Z4.0-SIRON-A	02733841	3	D	25,0	25,0	85,0	150,0	-	-	0,3	4	■

■ Stocked standard.

JS554

High performance – Universal – Square – 4 Flutes – Cylindrical – Corner radius

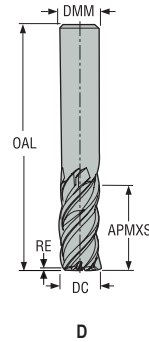

- Tolerances:
- DMM= h5
- DC= e7
- RE= ±0,02 mm
- Re grind possible

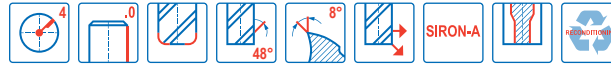

Designation	Item number	Length index	Tool shape	DC	DMM	APMXS	OAL	RE	PCEDC	Cylindrical
				mm	mm	mm	mm	mm		
554060R020Z4.0-SIRON-A	02679507	2	D	6,0	6,0	14,0	55,0	0,2	4	■
554080R050Z4.0-SIRON-A	02679514	2	D	8,0	8,0	18,0	60,0	0,5	4	■
554100R050Z4.0-SIRON-A	02679540	2	D	10,0	10,0	22,0	70,0	0,5	4	■
554100R100Z4.0-SIRON-A	02679544	2	D	10,0	10,0	22,0	70,0	1,0	4	■
554120R050Z4.0-SIRON-A	02679552	2	D	12,0	12,0	26,0	80,0	0,5	4	■
554120R100Z4.0-SIRON-A	02679557	2	D	12,0	12,0	26,0	80,0	1,0	4	■
554160R050Z4.0-SIRON-A	02679562	2	D	16,0	16,0	34,0	90,0	0,5	4	■
554160R100Z4.0-SIRON-A	02679564	2	D	16,0	16,0	34,0	90,0	1,0	4	■
554160R200Z4.0-SIRON-A	02810437	2	D	16,0	16,0	34,0	90,0	2,0	4	■
554160R310Z4.0-SIRON-A	02810439	2	D	16,0	16,0	34,0	90,0	3,1	4	■
554160R400Z4.0-SIRON-A	02810441	2	D	16,0	16,0	34,0	90,0	4,0	4	■
554200R050Z4.0-SIRON-A	02679568	2	D	20,0	20,0	42,0	100,0	0,5	4	■
554200R100Z4.0-SIRON-A	02679571	2	D	20,0	20,0	42,0	100,0	1,0	4	■
554200R250Z4.0-SIRON-A	02810443	2	D	20,0	20,0	42,0	100,0	2,5	4	■
554200R310Z4.0-SIRON-A	02810445	2	D	20,0	20,0	42,0	100,0	3,1	4	■
554200R400Z4.0-SIRON-A	02810447	2	D	20,0	20,0	42,0	100,0	4,0	4	■
554250R050Z4.0-SIRON-A	02679575	2	D	25,0	25,0	52,0	125,0	0,5	4	■
554250R100Z4.0-SIRON-A	02679577	2	D	25,0	25,0	52,0	125,0	1,0	4	■
554250R310Z4.0-SIRON-A	02810449	2	D	25,0	25,0	52,0	125,0	3,1	4	■
554250R400Z4.0-SIRON-A	02810452	2	D	25,0	25,0	52,0	125,0	4,0	4	■

■ Stocked standard.

Universal
Steel and cast iron
Stainless steel and S-materials
Non ferrous
Hard
Plastic and cfrp
Graphite
X-Heads
Minimaster Plus
Minimaster

JS554

High performance– Universal – Square – 4 Flutes – Cylindrical – Corner radius

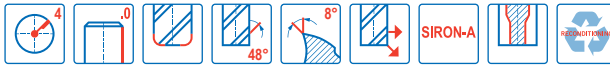
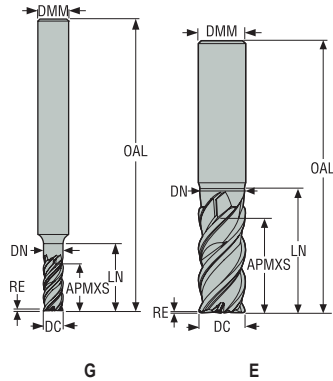

- Tolerances:
- DMM= h5
- DC= e7
- RE= ±0,02 mm
- Regrind possible if DC is ≥Ø6

Designation	Item number	Length index	Tool shape	DC	DMM	APMXS	OAL	LN	DN	RE	PCEDC	Cylindrical
				mm	mm	mm	mm	mm	mm	mm		
JS554030G2R015.0Z4-SIRA	02881697	2	G	3,0	6,0	7,0	57,0	10,0	2,85	0,15	4	■
JS554040G2R020.0Z4-SIRA	02881698	2	G	4,0	6,0	10,0	57,0	13,0	3,8	0,2	4	■
JS554050G2R020.0Z4-SIRA	02881699	2	G	5,0	6,0	12,0	57,0	16,0	4,75	0,2	4	■
JS554060E2R020.0Z4-SIRA	03029960	2	E	6,0	6,0	14,0	57,0	18,0	5,7	0,2	4	■
JS554060E2R050.0Z4-SIRA	02881700	2	E	6,0	6,0	14,0	57,0	18,0	5,7	0,5	4	■
JS554060E2R100.0Z4-SIRA	03029948	2	E	6,0	6,0	14,0	57,0	18,0	5,7	1,0	4	■
JS554080E2R050.0Z4-SIRA	03029962	2	E	8,0	8,0	18,0	63,0	25,0	7,6	0,5	4	■
JS554080E2R100.0Z4-SIRA	02881701	2	E	8,0	8,0	18,0	63,0	25,0	7,6	1,0	4	■
JS554100E2R050.0Z4-SIRA	03029964	2	E	10,0	10,0	22,0	72,0	29,0	9,5	0,5	4	■
JS554100E2R100.0Z4-SIRA	03029965	2	E	10,0	10,0	22,0	72,0	29,0	9,5	1,0	4	■
JS554100E2R200.0Z4-SIRA	02881702	2	E	10,0	10,0	22,0	72,0	29,0	9,5	2,0	4	■
JS554100E2R250.0Z4-SIRA	03029949	2	E	10,0	10,0	22,0	72,0	29,0	9,5	2,5	4	■
JS554120E2R050.0Z4-SIRA	03029968	2	E	12,0	12,0	26,0	83,0	35,0	11,4	0,5	4	■
JS554120E2R100.0Z4-SIRA	03029969	2	E	12,0	12,0	26,0	83,0	35,0	11,4	1,0	4	■
JS554120E2R200.0Z4-SIRA	02881703	2	E	12,0	12,0	26,0	83,0	35,0	11,4	2,0	4	■
JS554120E2R250.0Z4-SIRA	02881704	2	E	12,0	12,0	26,0	83,0	35,0	11,4	2,5	4	■
JS554120E2R300.0Z4-SIRA	03029950	2	E	12,0	12,0	26,0	83,0	35,0	11,4	3,0	4	■
JS554160E2R050.0Z4-SIRA	03029971	2	E	16,0	16,0	34,0	92,0	42,0	15,2	0,5	4	■
JS554160E2R600.0Z4-SIRA	03093685	2	E	16,0	16,0	34,0	92,0	42,0	15,2	6,0	4	■
JS554200E2R200.0Z4-SIRA	02881705	2	E	20,0	20,0	42,0	110,0	54,0	19,0	2,0	4	■
JS554200E2R600.0Z4-SIRA	03029951	2	E	20,0	20,0	42,0	109,0	54,0	19,0	6,0	4	■
JS554250E2R600.0Z4-SIRA	03093686	2	E	25,0	25,0	52,0	125,0	65,0	23,8	6,0	4	■

■ Stocked standard.

Universal

Steel and cast iron

Stainless steel and S-materials

Non ferrous

Hard

Plastic and cfrp

Graphite

X-Heads

Minimaster Plus

Minimaster

JS554

High performance – Universal – Square – 4 Flutes – Weldon – Sharp

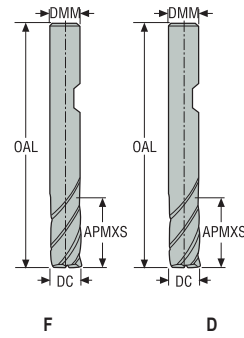

- Tolerances:
- DMM=h5
- DC=e7
- Regrind possible if DC is $\geq \phi 6$

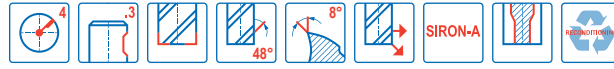

Designation	Item number	Length index	Tool shape	DC	DMM	APMXS	OAL	PCEDC	Weldon
				mm	mm	mm	mm		
554030SZ4.0-SIRON-AW	02733844	2	F	3,0	6,0	7,0	50,0	4	<input type="checkbox"/>
554040SZ4.0-SIRON-AW	02733846	2	F	4,0	6,0	10,0	55,0	4	<input type="checkbox"/>
554050SZ4.0-SIRON-AW	02733847	2	F	5,0	6,0	12,0	55,0	4	<input type="checkbox"/>
554060SZ4.0-SIRON-AW	02733848	2	D	6,0	6,0	14,0	55,0	4	<input type="checkbox"/>
554080SZ4.0-SIRON-AW	02733849	2	D	8,0	8,0	18,0	60,0	4	<input type="checkbox"/>
554100SZ4.0-SIRON-AW	02733850	2	D	10,0	10,0	22,0	70,0	4	<input type="checkbox"/>

Weldon available. Delivery time is 3 days.

Universal

Steel and cast iron

Stainless steel and S-materials

Non ferrous

Hard

Plastic and CFRP

Graphite

X-Heads

Minimaster Plus

Minimaster

JS554

High performance – Universal – Square – 4 Flutes – Weldon – Chamfer

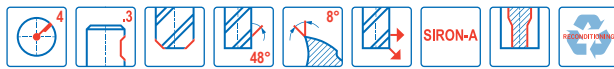
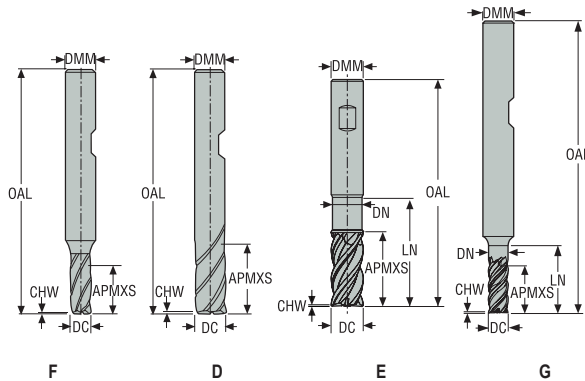

- Tolerances:
- DMM=h5
- DC=e7
- Regrind possible if DC is ≥Ø6

Designation	Item number	Length index	Tool shape	DC	DMM	APMXS	OAL	LN	DN	CHW	PCEDC	Weldon
				mm	mm	mm	mm	mm	mm	mm		
JS554040F1C.3Z4-SIRA	10041460	1	F	4,0	6,0	6,0	40,0	9,0	4,05	0,045	4	■
JS554060D1C.3Z4-SIRA	10041461	1	D	6,0	6,0	8,0	40,0	–	–	0,075	4	■
JS554080D1C.3Z4-SIRA	10041462	1	D	8,0	8,0	11,0	50,0	–	–	0,1	4	□
JS554100D1C.3Z4-SIRA	10041463	1	D	10,0	10,0	13,0	57,0	–	–	0,125	4	□
JS554120D1C.3Z4-SIRA	10041464	1	D	12,0	12,0	15,0	65,0	–	–	0,15	4	□
JS554160D1C.3Z4-SIRA	10041465	1	D	16,0	16,0	19,0	75,0	–	–	0,2	4	□
554030Z4.3-SIRON-A	02733450	2	F	3,0	6,0	7,0	50,0	8,7	3,0	0,035	4	■
JS554030G2C.3Z4-SIRA	03029973	2	G	3,0	6,0	8,0	57,0	10,0	2,85	0,035	4	□
554040Z4.3-SIRON-A	02733456	2	F	4,0	6,0	10,0	55,0	11,7	4,0	0,045	4	■
JS554040G2C.3Z4-SIRA	03029974	2	G	4,0	6,0	10,0	57,0	13,0	3,8	0,045	4	□
554050Z4.3-SIRON-A	02733461	2	F	5,0	6,0	12,0	55,0	13,7	5,0	0,055	4	■
JS554050G2C.3Z4-SIRA	03029975	2	G	5,0	6,0	12,0	57,0	16,0	4,75	0,055	4	□
554060Z4.3-SIRON-A	02679502	2	D	6,0	6,0	14,0	55,0	–	–	0,075	4	■
JS554060E2C.3Z4-SIRA	03029976	2	E	6,0	6,0	14,0	57,0	18,0	5,7	0,075	4	□
554080Z4.3-SIRON-A	02679511	2	D	8,0	8,0	18,0	60,0	–	–	0,1	4	■
JS554080E2C.3Z4-SIRA	03029978	2	E	8,0	8,0	18,0	63,0	25,0	7,6	0,1	4	□
JS554100E2C.3Z4-SIRA	03029980	2	E	10,0	10,0	22,0	72,0	29,0	9,5	0,125	4	□
554100Z4.3-SIRON-A	02679535	2	D	10,0	10,0	22,0	70,0	–	–	0,125	4	■
JS554120E2C.3Z4-SIRA	03029983	2	E	12,0	12,0	26,0	83,0	35,0	11,4	0,15	4	□
554120Z4.3-SIRON-A	02679547	2	D	12,0	12,0	26,0	80,0	–	–	0,15	4	■
JS554160E2C.3Z4-SIRA	03029986	2	E	16,0	16,0	34,0	92,0	42,0	15,2	0,2	4	□
554160Z4.3-SIRON-A	02679559	2	D	16,0	16,0	34,0	90,0	–	–	0,2	4	■
JS554200E2C.3Z4-SIRA	03029988	2	E	20,0	20,0	42,0	109,0	54,0	19,0	0,25	4	□
554200Z4.3-SIRON-A	02679565	2	D	20,0	20,0	42,0	100,0	–	–	0,25	4	■
554250Z4.3-SIRON-A	02679572	2	D	25,0	25,0	52,0	125,0	–	–	0,3	4	■
554L030Z4.3-SIRON-A	02733817	3	F	3,0	6,0	12,0	55,0	13,7	3,0	0,035	4	■
554L040Z4.3-SIRON-A	02733820	3	F	4,0	6,0	16,0	60,0	17,7	4,0	0,045	4	■
554L050Z4.3-SIRON-A	02733824	3	F	5,0	6,0	20,0	65,0	21,7	5,0	0,055	4	■
554L060Z4.3-SIRON-A	02733827	3	D	6,0	6,0	23,0	65,0	–	–	0,075	4	■
554L080Z4.3-SIRON-A	02733829	3	D	8,0	8,0	32,0	75,0	–	–	0,1	4	■
554L100Z4.3-SIRON-A	02733831	3	D	10,0	10,0	40,0	85,0	–	–	0,125	4	■
554L120Z4.3-SIRON-A	02733833	3	D	12,0	12,0	45,0	100,0	–	–	0,15	4	■
554L160Z4.3-SIRON-A	02733835	3	D	16,0	16,0	55,0	115,0	–	–	0,2	4	■
554L200Z4.3-SIRON-A	02733837	3	D	20,0	20,0	65,0	125,0	–	–	0,25	4	■
554L250Z4.3-SIRON-A	02733839	3	D	25,0	25,0	85,0	150,0	–	–	0,3	4	■

■ Stocked standard. □ Weldon available. Delivery time is 3 days.

JS554

High performance – Universal – Square – 4 Flutes – Weldon – Corner radius

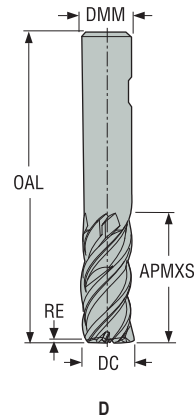

- Tolerances:
- DMM= h5
- DC= e7
- RE= ±0,02 mm
- Regrind possible

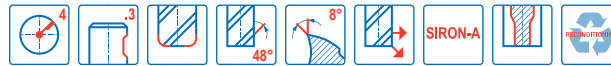

Designation	Item number	Length index	Tool shape	DC	DMM	APMXS	OAL	RE	PCEDC	Weldon
				mm	mm	mm	mm	mm		
554060R020Z4.3-SIRON-A	02679506	2	D	6,0	6,0	14,0	55,0	0,2	4	■
554080R050Z4.3-SIRON-A	02679513	2	D	8,0	8,0	18,0	60,0	0,5	4	■
554100R050Z4.3-SIRON-A	02679539	2	D	10,0	10,0	22,0	70,0	0,5	4	■
554100R100Z4.3-SIRON-A	02679542	2	D	10,0	10,0	22,0	70,0	1,0	4	■
554120R050Z4.3-SIRON-A	02679549	2	D	12,0	12,0	26,0	80,0	0,5	4	■
554120R100Z4.3-SIRON-A	02679554	2	D	12,0	12,0	26,0	80,0	1,0	4	■
554160R050Z4.3-SIRON-A	02679561	2	D	16,0	16,0	34,0	90,0	0,5	4	■
554160R100Z4.3-SIRON-A	02679563	2	D	16,0	16,0	34,0	90,0	1,0	4	■
554160R200Z4.3-SIRON-A	02810436	2	D	16,0	16,0	34,0	90,0	2,0	4	■
554160R310Z4.3-SIRON-A	02810438	2	D	16,0	16,0	34,0	90,0	3,1	4	■
554160R400Z4.3-SIRON-A	02810440	2	D	16,0	16,0	34,0	90,0	4,0	4	■
554200R050Z4.3-SIRON-A	02679567	2	D	20,0	20,0	42,0	100,0	0,5	4	■
554200R100Z4.3-SIRON-A	02679570	2	D	20,0	20,0	42,0	100,0	1,0	4	■
554200R250Z4.3-SIRON-A	02810442	2	D	20,0	20,0	42,0	100,0	2,5	4	■
554200R310Z4.3-SIRON-A	02810444	2	D	20,0	20,0	42,0	100,0	3,1	4	■
554200R400Z4.3-SIRON-A	02810446	2	D	20,0	20,0	42,0	100,0	4,0	4	■
554250R050Z4.3-SIRON-A	02679574	2	D	25,0	25,0	52,0	125,0	0,5	4	■
554250R100Z4.3-SIRON-A	02679576	2	D	25,0	25,0	52,0	125,0	1,0	4	■
554250R310Z4.3-SIRON-A	02810448	2	D	25,0	25,0	52,0	125,0	3,1	4	■
554250R400Z4.3-SIRON-A	02810451	2	D	25,0	25,0	52,0	125,0	4,0	4	■

■ Stocked standard.

Universal

Steel and cast iron

Stainless steel and S-materials

Non ferrous

Hard

Plastic and cfrp

Graphite

X-Heads

Minimaster Plus

Minimaster

JS554

High performance – Universal – Square – 4 Flutes – Weldon – Corner radius

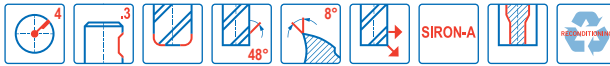
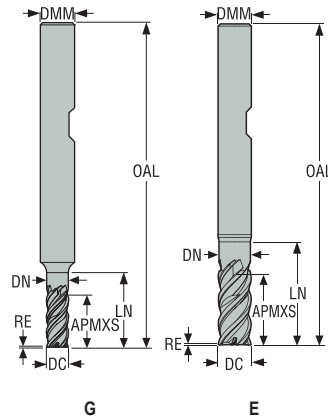

- Tolerances:
- DMM= h5
- DC= e7
- RE= ±0,02 mm
- Regrind possible if DC is ≥Ø6

Designation	Item number	Length index	Tool shape	DC	DMM	APMXS	OAL	LN	DN	RE	PCEDC	Weldon
				mm	mm	mm	mm	mm	mm	mm		
JS554030G2R015.3Z4-SIRA	02881706	2	G	3,0	6,0	7,0	57,0	10,0	2,85	0,15	4	□
JS554040G2R020.3Z4-SIRA	02881946	2	G	4,0	6,0	10,0	57,0	13,0	3,8	0,2	4	□
JS554050G2R020.3Z4-SIRA	02881708	2	G	5,0	6,0	12,0	57,0	16,0	4,75	0,2	4	□
JS554060E2R020.3Z4-SIRA	03029977	2	E	6,0	6,0	14,0	57,0	18,0	5,7	0,2	4	□
JS554060E2R050.3Z4-SIRA	02881709	2	E	6,0	6,0	14,0	57,0	18,0	5,7	0,5	4	□
JS554060E2R100.3Z4-SIRA	03029952	2	E	6,0	6,0	14,0	57,0	18,0	5,7	1,0	4	□
JS554080E2R050.3Z4-SIRA	03029979	2	E	8,0	8,0	18,0	63,0	25,0	7,6	0,5	4	□
JS554080E2R100.3Z4-SIRA	02881710	2	E	8,0	8,0	18,0	63,0	25,0	7,6	1,0	4	□
JS554100E2R050.3Z4-SIRA	03029981	2	E	10,0	10,0	22,0	72,0	29,0	9,5	0,5	4	□
JS554100E2R100.3Z4-SIRA	03029982	2	E	10,0	10,0	22,0	72,0	29,0	9,5	1,0	4	□
JS554100E2R200.3Z4-SIRA	02881711	2	E	10,0	10,0	22,0	72,0	29,0	9,5	2,0	4	□
JS554100E2R250.3Z4-SIRA	03029953	2	E	10,0	10,0	22,0	72,0	29,0	9,5	2,5	4	□
JS554120E2R050.3Z4-SIRA	03029984	2	E	12,0	12,0	26,0	83,0	35,0	11,4	0,5	4	■
JS554120E2R100.3Z4-SIRA	03029985	2	E	12,0	12,0	26,0	83,0	35,0	11,4	1,0	4	□
JS554120E2R200.3Z4-SIRA	02881712	2	E	12,0	12,0	26,0	83,0	35,0	11,4	2,0	4	□
JS554120E2R250.3Z4-SIRA	02881713	2	E	12,0	12,0	26,0	83,0	35,0	11,4	2,5	4	□
JS554120E2R300.3Z4-SIRA	03029954	2	E	12,0	12,0	26,0	83,0	35,0	11,4	3,0	4	□
JS554160E2R050.3Z4-SIRA	03029987	2	E	16,0	16,0	34,0	92,0	42,0	15,2	0,5	4	□
JS554160E2R600.3Z4-SIRA	03093687	2	E	16,0	16,0	34,0	92,0	42,0	15,2	6,0	4	□
JS554200E2R200.3Z4-SIRA	02881714	2	E	20,0	20,0	42,0	110,0	54,0	19,0	2,0	4	□
JS554200E2R600.3Z4-SIRA	03029955	2	E	20,0	20,0	42,0	109,0	54,0	19,0	6,0	4	□
JS554250E2R600.3Z4-SIRA	03093688	2	E	25,0	25,0	52,0	125,0	65,0	23,8	6,0	4	□

■ Stocked standard. □ Weldon available. Delivery time is 3 days.

Universal

Steel and cast iron

Stainless steel and S-materials

Non ferrous

Hard

Plastic and CFRP

Graphite

X-Heads

Minimaster Plus

Minimaster

JS554

High performance – Universal – Square – 4 Flutes – Cylindrical – Chamfer – Inch

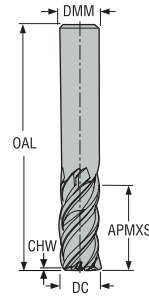

D

- Tolerances:
- DMM=h5
- DC=e7
- Regrind possible if DC is $\geq \varnothing.375$

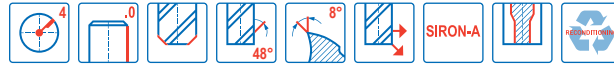

Designation	Item number	Length index	Tool shape	DC	DMM	APMXS	OAL	CHW	PCEDC	Cylindrical
				inch	inch	inch	inch	inch		
5540250Z4.0-SIRON-A	02711329	2	D	0.250	0.250	0.500	2.500	0.003	4	■
5540312Z4.0-SIRON-A	02711340	2	D	0.313	0.313	0.625	2.500	0.004	4	■
5540375Z4.0-SIRON-A	02711344	2	D	0.375	0.375	0.750	3.000	0.005	4	■
5540500Z4.0-SIRON-A	02711611	2	D	0.500	0.500	1.000	3.500	0.006	4	■
5540625Z4.0-SIRON-A	02711626	2	D	0.625	0.625	1.250	3.750	0.008	4	■
5540750Z4.0-SIRON-A	02711643	2	D	0.750	0.750	1.500	4.000	0.010	4	■
5541000Z4.0-SIRON-A	02711660	2	D	1.000	1.000	2.000	5.000	0.012	4	■

■ Stocked standard.

Universal

Steel and cast iron

Stainless steel and S-materials

Non ferrous

Hard

Plastic and CFRP

Graphite

X-Heads

Minimaster Plus

Minimaster

JS554

High performance – Universal – Square – 4 Flutes – Cylindrical – Corner radius – Inch

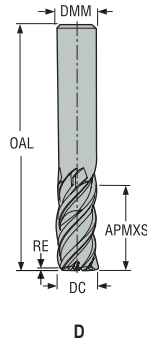

D

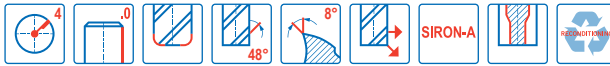

- Tolerances:
- DMM=h5
- DC=e7
- RE= ±.0008 inch
- Regrind possible if DC is ≥Ø.375

Designation	Item number	Length index	Tool shape	DC	DMM	APMXS	OAL	RE	PCEDC	Cylindrical
				inch	inch	inch	inch	inch		
5540250R015Z4.0-SIRON-A	02711335	2	D	0.250	0.250	0.500	2.500	0.015	4	■
5540312R015Z4.0-SIRON-A	02711341	2	D	0.313	0.313	0.625	2.500	0.015	4	■
5540375R015Z4.0-SIRON-A	02711588	2	D	0.375	0.375	0.750	3.000	0.015	4	■
5540375R030Z4.0-SIRON-A	02711589	2	D	0.375	0.375	0.750	3.000	0.030	4	■
5540500R015Z4.0-SIRON-A	02711614	2	D	0.500	0.500	1.000	3.500	0.015	4	■
5540500R030Z4.0-SIRON-A	02711616	2	D	0.500	0.500	1.000	3.500	0.030	4	■
5540500R125Z4.0-SIRON-A	02842370	2	D	0.500	0.500	1.000	3.500	0.125	4	■
5540625R015Z4.0-SIRON-A	02711629	2	D	0.625	0.625	1.250	3.750	0.015	4	■
5540625R030Z4.0-SIRON-A	02711631	2	D	0.625	0.625	1.250	3.750	0.030	4	■
5540625R125Z4.0-SIRON-A	02842371	2	D	0.625	0.625	1.250	3.750	0.125	4	■
5540750R030Z4.0-SIRON-A	02711647	2	D	0.750	0.750	1.500	4.000	0.030	4	■
5540750R060Z4.0-SIRON-A	02711655	2	D	0.750	0.750	1.500	4.000	0.060	4	■

■ Stocked standard.

Universal

Steel and cast iron

Stainless steel and S-materials

Non ferrous

Hard

Plastic and CFRP

Graphite

X-Heads

Minimaster Plus

Minimaster

JS554

High performance – Universal – Square – 4 Flutes – Weldon – Chamfer – inch

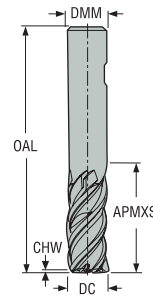

D

- Tolerances:
- DMM=h5
- DC=e7
- Regrind possible

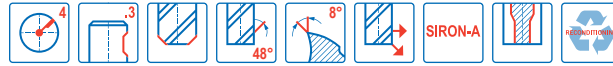

Designation	Item number	Length index	Tool shape	DC	DMM	APMXS	OAL	CHW	PCEDC	Weldon
				inch	inch	inch	inch	inch		
5540500Z4.3-SIRON-A	02711608	2	D	0.500	0.500	1.000	3.500	0.006	4	■
5540750Z4.3-SIRON-A	02711632	2	D	0.750	0.750	1.500	4.000	0.010	4	■

■ Stocked standard.

Universal

Steel and cast iron

Stainless steel and S-materials

Non ferrous

Hard

Plastic and CFRP

Graphite

X-Heads

Minimaster Plus

Minimaster

JS554

High performance – Universal – Square – 4 Flutes – Weldon – Corner radius – Inch

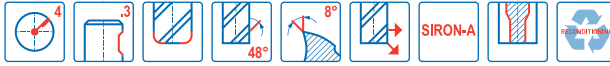
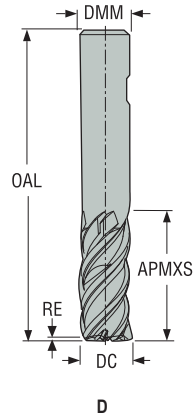

- Tolerances:
- DMM=h5
- DC=e7
- RE= ±.0008 inch
- Re grind possible

Designation	Item number	Length index	Tool shape	DC	DMM	APMXS	OAL	RE	PCEDC	Weldon
				inch	inch	inch	inch	inch		
5540500R015Z4.3-SIRON-A	02711613	2	D	0.500	0.500	1.000	3.500	0.015	4	■
5540500R030Z4.3-SIRON-A	02711615	2	D	0.500	0.500	1.000	3.500	0.030	4	■
5540500R125Z4.3-SIRON-A	02856456	2	D	0.500	0.500	1.000	3.500	0.125	4	□
5540625R125Z4.3-SIRON-A	02856457	2	D	0.625	0.625	1.250	3.750	0.125	4	□
5541000R060Z4.3-SIRON-A	02711663	2	D	1.000	1.000	2.000	5.000	0.060	4	■

■ Stocked standard. □ Weldon available. Delivery time is 3 days.

Universal

Steel and cast iron

Stainless steel and S-materials

Non ferrous

Hard

Plastic and CFRP

Graphite

X-Heads

Minimaster Plus

Minimaster

Cutting data – JS554 Side milling roughing

SMG		a _e /DC	a _p /DC	f _z										v _c
				3	4	5	6	8	10	12	16	20	25	
P1	M/A/D/E	0.400	1.0	0.030	0.040	0.050	0.060	0.080	0.10	0.12	0.15	0.17	0.19	215 (190 – 240)
		0.400	1.0	0.0012	0.0016	0.0020	0.0024	0.0032	0.0040	0.0048	0.0060	0.0065	0.0075	710 (630 – 780)
P2	M/A/D/E	0.400	1.0	0.030	0.040	0.050	0.060	0.080	0.10	0.12	0.15	0.17	0.19	210 (190 – 240)
		0.400	1.0	0.0012	0.0016	0.0020	0.0024	0.0032	0.0040	0.0048	0.0060	0.0065	0.0075	690 (630 – 780)
P3	M/A/D/E	0.400	1.0	0.028	0.038	0.048	0.055	0.075	0.095	0.11	0.14	0.16	0.18	185 (160 – 200)
		0.400	1.0	0.0011	0.0015	0.0019	0.0022	0.0030	0.0038	0.0044	0.0055	0.0065	0.0070	610 (530 – 650)
P4	M/A/D/E	0.400	1.0	0.028	0.038	0.046	0.055	0.075	0.095	0.11	0.14	0.16	0.18	160 (140 – 180)
		0.400	1.0	0.0011	0.0015	0.0018	0.0022	0.0030	0.0038	0.0044	0.0055	0.0065	0.0070	520 (460 – 590)
P5	M/A/D/E	0.400	1.0	0.028	0.036	0.046	0.055	0.075	0.090	0.11	0.13	0.16	0.18	155 (140 – 170)
		0.400	1.0	0.0011	0.0014	0.0018	0.0022	0.0030	0.0036	0.0044	0.0050	0.0065	0.0070	510 (460 – 550)
P6	M/A/D/E	0.400	1.0	0.028	0.036	0.046	0.055	0.075	0.090	0.11	0.13	0.15	0.17	175 (160 – 200)
		0.400	1.0	0.0011	0.0014	0.0018	0.0022	0.0030	0.0036	0.0044	0.0050	0.0060	0.0065	570 (530 – 650)
P7	M/A/D/E	0.400	1.0	0.028	0.036	0.046	0.055	0.075	0.090	0.11	0.13	0.15	0.17	165 (150 – 180)
		0.400	1.0	0.0011	0.0014	0.0018	0.0022	0.0030	0.0036	0.0044	0.0050	0.0060	0.0065	540 (500 – 590)
P8	M/A/D/E	0.400	1.0	0.028	0.038	0.048	0.055	0.075	0.095	0.11	0.14	0.16	0.18	155 (140 – 170)
		0.400	1.0	0.0011	0.0015	0.0019	0.0022	0.0030	0.0038	0.0044	0.0055	0.0065	0.0070	510 (460 – 550)
P11	M/A/D/E	0.400	1.0	0.026	0.036	0.044	0.055	0.070	0.090	0.11	0.13	0.15	0.17	140 (130 – 150)
		0.400	1.0	0.0010	0.0014	0.0017	0.0022	0.0028	0.0036	0.0044	0.0050	0.0060	0.0065	460 (430 – 490)
P12	M/A/D/E	0.400	1.0	0.018	0.024	0.030	0.036	0.048	0.060	0.070	0.090	0.10	0.12	90 (79 – 100)
		0.400	1.0	0.00070	0.00095	0.0012	0.0014	0.0019	0.0024	0.0028	0.0036	0.0040	0.0048	295 (260 – 320)
M1	E	0.400	1.0	0.020	0.026	0.034	0.040	0.055	0.065	0.080	0.10	0.11	0.13	110 (96 – 120)
		0.400	1.0	0.00080	0.0010	0.0013	0.0016	0.0022	0.0026	0.0032	0.0040	0.0044	0.0050	360 (320 – 390)
M2	E	0.400	1.0	0.018	0.024	0.030	0.036	0.048	0.060	0.070	0.090	0.10	0.12	90 (79 – 100)
		0.400	1.0	0.00070	0.00095	0.0012	0.0014	0.0019	0.0024	0.0028	0.0036	0.0040	0.0048	295 (260 – 320)
M3	E	0.400	0.90	0.015	0.020	0.025	0.030	0.040	0.050	0.060	0.075	0.085	0.095	55 (45 – 66)
		0.400	0.90	0.00060	0.00080	0.0010	0.0012	0.0016	0.0020	0.0024	0.0030	0.0034	0.0038	180 (150 – 210)
M4	E	0.400	0.90	0.013	0.018	0.022	0.026	0.036	0.044	0.055	0.065	0.075	0.085	43 (35 – 51)
		0.400	0.90	0.00050	0.00070	0.00085	0.0010	0.0014	0.0017	0.0022	0.0026	0.0030	0.0034	140 (120 – 160)
M5	E	0.400	0.90	0.013	0.018	0.022	0.026	0.036	0.044	0.055	0.065	0.075	0.085	36 (29 – 42)
		0.400	0.90	0.00050	0.00070	0.00085	0.0010	0.0014	0.0017	0.0022	0.0026	0.0030	0.0034	120 (96 – 130)
K1	E	0.400	1.2	0.024	0.032	0.040	0.048	0.065	0.080	0.095	0.12	0.14	0.16	175 (160 – 190)
		0.400	1.2	0.00095	0.0013	0.0016	0.0019	0.0026	0.0032	0.0038	0.0048	0.0055	0.0065	570 (530 – 620)
K2	E	0.400	1.2	0.022	0.030	0.038	0.044	0.060	0.075	0.090	0.11	0.13	0.14	155 (140 – 170)
		0.400	1.2	0.00085	0.0012	0.0015	0.0017	0.0024	0.0030	0.0036	0.0044	0.0050	0.0055	510 (460 – 550)
K3	E	0.400	1.2	0.022	0.030	0.038	0.044	0.060	0.075	0.090	0.11	0.13	0.14	130 (120 – 140)
		0.400	1.2	0.00085	0.0012	0.0015	0.0017	0.0024	0.0030	0.0036	0.0044	0.0050	0.0055	425 (400 – 450)
K4	E	0.400	1.2	0.022	0.030	0.038	0.044	0.060	0.075	0.090	0.11	0.13	0.14	125 (110 – 140)
		0.400	1.2	0.00085	0.0012	0.0015	0.0017	0.0024	0.0030	0.0036	0.0044	0.0050	0.0055	410 (370 – 450)
K5	E	0.400	1.0	0.024	0.032	0.040	0.048	0.065	0.080	0.095	0.12	0.14	0.16	155 (140 – 170)
		0.400	1.0	0.00095	0.0013	0.0016	0.0019	0.0026	0.0032	0.0038	0.0048	0.0055	0.0065	510 (460 – 550)
K6	E	0.400	1.0	0.028	0.036	0.046	0.055	0.070	0.090	0.11	0.13	0.15	0.17	220 (190 – 250)
		0.400	1.0	0.0011	0.0014	0.0018	0.0022	0.0028	0.0036	0.0044	0.0050	0.0060	0.0065	720 (630 – 820)
K7	E	0.400	1.0	0.024	0.032	0.040	0.048	0.065	0.080	0.095	0.12	0.14	0.16	195 (170 – 220)
		0.400	1.0	0.00095	0.0013	0.0016	0.0019	0.0026	0.0032	0.0038	0.0048	0.0055	0.0065	640 (560 – 720)

For cutting data recalculations, see pages 556 - 563

SMG = Seco material group
 Coolant = A=air D=dry E=emulsion M=mist spray
 v_c = m/min (sf/min)
 f_z = mm (in/tooth)
 a_p = mm/DC (in/DC) = factor
 a_e = mm/DC (in/DC) = factor
 All cutting data are target values

Cutting data – JS554 Side milling roughing

SMG		a _e /DC	a _p /DC	f _z										v _c
				3	4	5	6	8	10	12	16	20	25	
N1	E	0.500	0.90	0.024	0.032	0.040	0.048	0.065	0.080	0.095	0.12	0.13	0.15	610 (510 – 710)
		0,500	0,90	0,00095	0,0013	0,0016	0,0019	0,0026	0,0032	0,0038	0,0048	0,0050	0,0060	2000 (1700 – 2300)
N2	E	0.500	0.90	0.024	0.032	0.040	0.048	0.065	0.080	0.095	0.12	0.13	0.15	390 (330 – 450)
		0,500	0,90	0,00095	0,0013	0,0016	0,0019	0,0026	0,0032	0,0038	0,0048	0,0050	0,0060	1275 (1100 – 1400)
N11	E	0.500	1.1	0.024	0.032	0.040	0.048	0.065	0.080	0.095	0.12	0.13	0.15	320 (270 – 370)
		0,500	1,1	0,00095	0,0013	0,0016	0,0019	0,0026	0,0032	0,0038	0,0048	0,0050	0,0060	1050 (890 – 1200)
S11	E	0.400	0.70	0.018	0.024	0.030	0.036	0.048	0.060	0.070	0.090	0.10	0.12	100 (72 – 120)
		0,400	0,70	0,00070	0,00095	0,0012	0,0014	0,0019	0,0024	0,0028	0,0036	0,0040	0,0048	330 (240 – 390)
S12	E	0.400	0.70	0.018	0.024	0.030	0.036	0.048	0.060	0.070	0.090	0.10	0.12	75 (56 – 99)
		0,400	0,70	0,00070	0,00095	0,0012	0,0014	0,0019	0,0024	0,0028	0,0036	0,0040	0,0048	245 (190 – 320)
S13	E	0.400	0.70	0.016	0.022	0.026	0.032	0.042	0.055	0.065	0.080	0.090	0.10	60 (44 – 78)
		0,400	0,70	0,00065	0,00085	0,0010	0,0013	0,0017	0,0022	0,0026	0,0032	0,0036	0,0040	195 (150 – 250)
H5	M/A/D	0.200	0.90	0.022	0.030	0.038	0.046	0.060	0.075	0.090	0.11	0.13	0.14	75 (59 – 88)
		0,200	0,90	0,00085	0,0012	0,0015	0,0018	0,0024	0,0030	0,0036	0,0044	0,0050	0,0055	245 (200 – 280)
H8	M/A/D	0.200	0.90	0.017	0.022	0.028	0.034	0.046	0.055	0.070	0.085	0.095	0.11	80 (63 – 93)
		0,200	0,90	0,00065	0,00085	0,0011	0,0013	0,0018	0,0022	0,0028	0,0034	0,0038	0,0044	260 (210 – 300)
H11	M/A/D	0.200	0.90	0.022	0.030	0.038	0.046	0.060	0.075	0.090	0.11	0.13	0.14	95 (75 – 110)
		0,200	0,90	0,00085	0,0012	0,0015	0,0018	0,0024	0,0030	0,0036	0,0044	0,0050	0,0055	310 (250 – 360)
H12	M/A/D	0.200	0.90	0.017	0.022	0.028	0.034	0.046	0.055	0.070	0.085	0.095	0.11	90 (73 – 100)
		0,200	0,90	0,00065	0,00085	0,0011	0,0013	0,0018	0,0022	0,0028	0,0034	0,0038	0,0044	295 (240 – 320)
H21	M/A/D	0.200	0.90	0.017	0.022	0.028	0.034	0.046	0.055	0.070	0.085	0.095	0.11	155 (110 – 190)
		0,200	0,90	0,00065	0,00085	0,0011	0,0013	0,0018	0,0022	0,0028	0,0034	0,0038	0,0044	510 (370 – 620)
TS1	A	0.500	1.0	0.030	0.040	0.050	0.060	0.080	0.10	0.12	0.15	0.17	0.19	285 (180 – 400)
		0,500	1,0	0,0012	0,0016	0,0020	0,0024	0,0032	0,0040	0,0048	0,0060	0,0065	0,0075	940 (600 – 1300)
TP1	A	0.500	1.0	0.030	0.040	0.050	0.060	0.080	0.10	0.12	0.15	0.17	0.19	295 (180 – 410)
		0,500	1,0	0,0012	0,0016	0,0020	0,0024	0,0032	0,0040	0,0048	0,0060	0,0065	0,0075	970 (600 – 1300)
GR1	A	0.500	1.1	0.030	0.040	0.050	0.060	0.080	0.10	0.12	0.15	0.17	0.19	580 (470 – 690)
		0,500	1,1	0,0012	0,0016	0,0020	0,0024	0,0032	0,0040	0,0048	0,0060	0,0065	0,0075	1900 (1600 – 2200)

For cutting data recalculations, see pages 556 - 563

SMG = Seco material group
 Coolant = A=air D=dry E=emulsion M=mist spray
 v_c = m/min (sf/min)
 f_z = mm (in/tooth)
 a_p = mm/DC (in/DC) = factor
 a_e = mm/DC (in/DC) = factor
 All cutting data are target values

Universal
Steel and cast iron
Stainless steel and S-materials
Non ferrous
Hard
Plastic and CFRP
Graphite
X-Heads
Minimaster Plus
Minimaster

Cutting data – JS554 Slot milling

SMG	Coolant	a _p /DC	f _z										v _c
			3	4	5	6	8	10	12	16	20	25	
P1	M/A/D/E	1.0	0.018	0.024	0.030	0.036	0.048	0.060	0.070	0.095	0.12	0.15	195 (170 – 220)
		1.0	0,00070	0,00095	0,0012	0,0014	0,0019	0,0024	0,0028	0,0038	0,0048	0,0060	640 (560 – 720)
P2	M/A/D/E	1.0	0.018	0.024	0.030	0.036	0.048	0.060	0.070	0.095	0.12	0.15	190 (170 – 210)
		1.0	0,00070	0,00095	0,0012	0,0014	0,0019	0,0024	0,0028	0,0038	0,0048	0,0060	620 (560 – 680)
P3	M/A/D/E	1.0	0.018	0.024	0.030	0.036	0.048	0.060	0.070	0.095	0.12	0.15	165 (140 – 180)
		1.0	0,00070	0,00095	0,0012	0,0014	0,0019	0,0024	0,0028	0,0038	0,0048	0,0060	540 (460 – 590)
P4	M/A/D/E	1.0	0.018	0.024	0.030	0.036	0.048	0.060	0.070	0.095	0.12	0.15	145 (130 – 160)
		1.0	0,00070	0,00095	0,0012	0,0014	0,0019	0,0024	0,0028	0,0038	0,0048	0,0060	475 (430 – 520)
P5	M/A/D/E	1.0	0.018	0.024	0.030	0.036	0.048	0.060	0.070	0.095	0.12	0.15	135 (120 – 150)
		1.0	0,00070	0,00095	0,0012	0,0014	0,0019	0,0024	0,0028	0,0038	0,0048	0,0060	445 (400 – 490)
P6	M/A/D/E	1.0	0.018	0.024	0.030	0.036	0.048	0.060	0.070	0.095	0.12	0.15	155 (140 – 170)
		1.0	0,00070	0,00095	0,0012	0,0014	0,0019	0,0024	0,0028	0,0038	0,0048	0,0060	510 (460 – 550)
P7	M/A/D/E	1.0	0.018	0.024	0.030	0.036	0.048	0.060	0.070	0.095	0.12	0.15	145 (130 – 160)
		1.0	0,00070	0,00095	0,0012	0,0014	0,0019	0,0024	0,0028	0,0038	0,0048	0,0060	475 (430 – 520)
P8	M/A/D/E	1.0	0.018	0.024	0.030	0.036	0.048	0.060	0.070	0.095	0.12	0.15	135 (120 – 150)
		1.0	0,00070	0,00095	0,0012	0,0014	0,0019	0,0024	0,0028	0,0038	0,0048	0,0060	445 (400 – 490)
P11	M/A/D/E	0.80	0.012	0.016	0.020	0.024	0.032	0.040	0.048	0.065	0.080	0.10	130 (120 – 140)
		0,80	0,00048	0,00065	0,00080	0,00095	0,0013	0,0016	0,0019	0,0026	0,0032	0,0040	425 (400 – 450)
P12	M/A/D/E	0.80	0.012	0.016	0.020	0.024	0.032	0.040	0.048	0.065	0.080	0.10	80 (69 – 87)
		0,80	0,00048	0,00065	0,00080	0,00095	0,0013	0,0016	0,0019	0,0026	0,0032	0,0040	260 (230 – 280)
M1	E	0.80	0.012	0.016	0.020	0.024	0.032	0.040	0.048	0.065	0.080	0.10	95 (85 – 100)
		0,80	0,00048	0,00065	0,00080	0,00095	0,0013	0,0016	0,0019	0,0026	0,0032	0,0040	310 (280 – 320)
M2	E	0.80	0.012	0.016	0.020	0.024	0.032	0.040	0.048	0.065	0.080	0.10	80 (69 – 87)
		0,80	0,00048	0,00065	0,00080	0,00095	0,0013	0,0016	0,0019	0,0026	0,0032	0,0040	260 (230 – 280)
M3	E	0.60	0.0095	0.013	0.016	0.019	0.025	0.032	0.038	0.050	0.065	0.080	48 (39 – 57)
		0,60	0,00038	0,00050	0,00065	0,00075	0,0010	0,0013	0,0015	0,0020	0,0026	0,0032	155 (130 – 180)
M4	E	0.60	0.0095	0.013	0.016	0.019	0.025	0.032	0.038	0.050	0.065	0.080	36 (29 – 43)
		0,60	0,00038	0,00050	0,00065	0,00075	0,0010	0,0013	0,0015	0,0020	0,0026	0,0032	120 (96 – 140)
M5	E	0.60	0.0095	0.013	0.016	0.019	0.025	0.032	0.038	0.050	0.065	0.080	30 (25 – 36)
		0,60	0,00038	0,00050	0,00065	0,00075	0,0010	0,0013	0,0015	0,0020	0,0026	0,0032	100 (83 – 110)
K1	E	1.0	0.015	0.020	0.025	0.030	0.040	0.050	0.060	0.080	0.10	0.13	155 (140 – 170)
		1.0	0,00060	0,00080	0,0010	0,0012	0,0016	0,0020	0,0024	0,0032	0,0040	0,0050	510 (460 – 550)
K2	E	1.0	0.015	0.020	0.025	0.030	0.040	0.050	0.060	0.080	0.10	0.13	135 (120 – 150)
		1.0	0,00060	0,00080	0,0010	0,0012	0,0016	0,0020	0,0024	0,0032	0,0040	0,0050	445 (400 – 490)
K3	E	1.0	0.015	0.020	0.025	0.030	0.040	0.050	0.060	0.080	0.10	0.13	115 (110 – 120)
		1.0	0,00060	0,00080	0,0010	0,0012	0,0016	0,0020	0,0024	0,0032	0,0040	0,0050	375 (370 – 390)
K4	E	1.0	0.015	0.020	0.025	0.030	0.040	0.050	0.060	0.080	0.10	0.13	110 (96 – 120)
		1.0	0,00060	0,00080	0,0010	0,0012	0,0016	0,0020	0,0024	0,0032	0,0040	0,0050	360 (320 – 390)
K5	E	0.70	0.015	0.020	0.025	0.030	0.040	0.050	0.060	0.080	0.10	0.13	135 (120 – 150)
		0,70	0,00060	0,00080	0,0010	0,0012	0,0016	0,0020	0,0024	0,0032	0,0040	0,0050	445 (400 – 490)
K6	E	0.70	0.015	0.020	0.025	0.030	0.040	0.050	0.060	0.080	0.10	0.13	200 (180 – 220)
		0,70	0,00060	0,00080	0,0010	0,0012	0,0016	0,0020	0,0024	0,0032	0,0040	0,0050	660 (600 – 720)
K7	E	0.70	0.015	0.020	0.025	0.030	0.040	0.050	0.060	0.080	0.10	0.13	175 (150 – 190)
		0,70	0,00060	0,00080	0,0010	0,0012	0,0016	0,0020	0,0024	0,0032	0,0040	0,0050	570 (500 – 620)

For cutting data recalculations, see pages 556 - 563

SMG = Seco material group
Coolant = A=air D=dry E=emulsion M=mist spray
v_c = m/min (sf/min)
f_z = mm/tooth (in/tooth)
a_p = mm/DC (in/DC) = factor
a_e = mm/DC (in/DC) = factor
All cutting data are target values

Cutting data – JS554 Slot milling

SMG		a _p /DC	f _z										v _c
			3	4	5	6	8	10	12	16	20	25	
N1	E	0.50	0.015	0.020	0.025	0.030	0.040	0.050	0.060	0.080	0.10	0.13	570 (480 – 670)
		0,50	0,00060	0,00080	0,0010	0,0012	0,0016	0,0020	0,0024	0,0032	0,0040	0,0050	1875 (1600 – 2100)
N2	E	0.50	0.015	0.020	0.025	0.030	0.040	0.050	0.060	0.080	0.10	0.13	370 (310 – 430)
		0,50	0,00060	0,00080	0,0010	0,0012	0,0016	0,0020	0,0024	0,0032	0,0040	0,0050	1225 (1100 – 1400)
N3	E	0.50	0.015	0.020	0.025	0.030	0.040	0.050	0.060	0.080	0.10	0.13	245 (210 – 280)
		0,50	0,00060	0,00080	0,0010	0,0012	0,0016	0,0020	0,0024	0,0032	0,0040	0,0050	800 (690 – 910)
N11	E	0.60	0.018	0.024	0.030	0.036	0.048	0.060	0.070	0.095	0.12	0.15	290 (250 – 330)
		0,60	0,00070	0,00095	0,0012	0,0014	0,0019	0,0024	0,0028	0,0038	0,0048	0,0060	950 (830 – 1000)
S1	E	0.30	0.0095	0.013	0.016	0.019	0.025	0.032	0.038	0.050	0.065	0.080	30 (25 – 34)
		0,30	0,00038	0,00050	0,00065	0,00075	0,0010	0,0013	0,0015	0,0020	0,0026	0,0032	100 (83 – 110)
S2	E	0.30	0.0095	0.013	0.016	0.019	0.025	0.032	0.038	0.050	0.065	0.080	27 (17 – 38)
		0,30	0,00038	0,00050	0,00065	0,00075	0,0010	0,0013	0,0015	0,0020	0,0026	0,0032	90 (56 – 120)
S3	E	0.30	0.0095	0.013	0.016	0.019	0.025	0.032	0.038	0.050	0.065	0.080	23 (15 – 32)
		0,30	0,00038	0,00050	0,00065	0,00075	0,0010	0,0013	0,0015	0,0020	0,0026	0,0032	75 (50 – 100)
S11	E	0.50	0.012	0.016	0.020	0.025	0.032	0.040	0.050	0.065	0.080	0.10	85 (63 – 110)
		0,50	0,00048	0,00065	0,00080	0,0010	0,0013	0,0016	0,0020	0,0026	0,0032	0,0040	280 (210 – 360)
S12	E	0.50	0.012	0.016	0.020	0.025	0.032	0.040	0.050	0.065	0.080	0.10	65 (48 – 86)
		0,50	0,00048	0,00065	0,00080	0,0010	0,0013	0,0016	0,0020	0,0026	0,0032	0,0040	215 (160 – 280)
S13	E	0.50	0.012	0.016	0.020	0.025	0.032	0.040	0.050	0.065	0.080	0.10	50 (38 – 66)
		0,50	0,00048	0,00065	0,00080	0,0010	0,0013	0,0016	0,0020	0,0026	0,0032	0,0040	165 (130 – 210)
H5	M/A/D	0.40	0.0060	0.0080	0.010	0.012	0.016	0.020	0.025	0.032	0.040	0.050	65 (52 – 76)
		0,40	0,00024	0,00032	0,00040	0,00048	0,00065	0,00080	0,0010	0,0013	0,0016	0,0020	215 (180 – 240)
H8	M/A/D	0.40	0.0060	0.0080	0.010	0.012	0.016	0.020	0.025	0.032	0.040	0.050	65 (52 – 76)
		0,40	0,00024	0,00032	0,00040	0,00048	0,00065	0,00080	0,0010	0,0013	0,0016	0,0020	215 (180 – 240)
H11	M/A/D	0.40	0.0060	0.0080	0.010	0.012	0.016	0.020	0.025	0.032	0.040	0.050	80 (66 – 97)
		0,40	0,00024	0,00032	0,00040	0,00048	0,00065	0,00080	0,0010	0,0013	0,0016	0,0020	260 (220 – 310)
H12	M/A/D	0.40	0.0060	0.0080	0.010	0.012	0.016	0.020	0.025	0.032	0.040	0.050	75 (60 – 89)
		0,40	0,00024	0,00032	0,00040	0,00048	0,00065	0,00080	0,0010	0,0013	0,0016	0,0020	245 (200 – 290)
H21	M/A/D	0.40	0.0060	0.0080	0.010	0.012	0.016	0.020	0.025	0.032	0.040	0.050	125 (90 – 160)
		0,40	0,00024	0,00032	0,00040	0,00048	0,00065	0,00080	0,0010	0,0013	0,0016	0,0020	410 (300 – 520)
TS1	A	0.70	0.030	0.040	0.050	0.060	0.080	0.10	0.12	0.15	0.17	0.19	240 (150 – 330)
		0,70	0,0012	0,0016	0,0020	0,0024	0,0032	0,0040	0,0048	0,0060	0,0065	0,0075	790 (500 – 1000)
TP1	A	0.70	0.030	0.040	0.050	0.060	0.080	0.10	0.12	0.15	0.17	0.19	250 (150 – 340)
		0,70	0,0012	0,0016	0,0020	0,0024	0,0032	0,0040	0,0048	0,0060	0,0065	0,0075	820 (500 – 1100)
GR1	A	0.80	0.030	0.040	0.050	0.060	0.080	0.10	0.12	0.15	0.17	0.19	485 (390 – 580)
		0,80	0,0012	0,0016	0,0020	0,0024	0,0032	0,0040	0,0048	0,0060	0,0065	0,0075	1600 (1300 – 1900)

For cutting data recalculations, see pages 556 - 563

SMG = Seco material group
 Coolant = A=air D=dry E=emulsion M=mist spray
 v_c = m/min (sf/min)
 f_z = mm/tooth (in/tooth)
 a_p = mm/DC (in/DC) = factor
 a_e = mm/DC (in/DC) = factor
 All cutting data are target values

Universal
 Steel and cast iron
 Stainless steel and S-materials
 Non ferrous
 Hard
 Plastic and CFRP
 Graphite
 X-Heads
 Minmaster Plus
 Minmaster

Cutting data – JS554 Side milling roughing – Inch

SMG		a _e /DC	a _p /DC	f _z							v _c
				1/4	5/16	3/8	1/2	5/8	3/4	1	
P1	M/A/D/E	0.400	1.0	0.065	0.080	0.095	0.12	0.14	0.16	0.19	215 (190 – 240)
		0,400	1,0	0,0026	0,0032	0,0038	0,0048	0,0055	0,0065	0,0075	710 (630 – 780)
P2	M/A/D/E	0.400	1.0	0.065	0.080	0.095	0.13	0.15	0.17	0.20	210 (190 – 240)
		0,400	1,0	0,0026	0,0032	0,0038	0,0050	0,0060	0,0065	0,0080	690 (630 – 780)
P3	M/A/D/E	0.400	1.0	0.060	0.075	0.090	0.12	0.14	0.16	0.18	185 (160 – 200)
		0,400	1,0	0,0024	0,0030	0,0036	0,0048	0,0055	0,0065	0,0070	610 (530 – 650)
P4	M/A/D/E	0.400	1.0	0.060	0.075	0.090	0.12	0.14	0.15	0.18	160 (140 – 180)
		0,400	1,0	0,0024	0,0030	0,0036	0,0048	0,0055	0,0060	0,0070	520 (460 – 590)
P5	M/A/D/E	0.400	1.0	0.060	0.075	0.085	0.11	0.13	0.15	0.18	155 (140 – 170)
		0,400	1,0	0,0024	0,0030	0,0034	0,0044	0,0050	0,0060	0,0070	510 (460 – 550)
P6	M/A/D/E	0.400	1.0	0.060	0.070	0.085	0.11	0.13	0.15	0.18	175 (160 – 200)
		0,400	1,0	0,0024	0,0028	0,0034	0,0044	0,0050	0,0060	0,0070	570 (530 – 650)
P7	M/A/D/E	0.400	1.0	0.060	0.070	0.085	0.11	0.13	0.15	0.18	165 (150 – 180)
		0,400	1,0	0,0024	0,0028	0,0034	0,0044	0,0050	0,0060	0,0070	540 (500 – 590)
P8	M/A/D/E	0.400	1.0	0.060	0.075	0.090	0.12	0.14	0.16	0.18	155 (140 – 170)
		0,400	1,0	0,0024	0,0030	0,0036	0,0048	0,0055	0,0065	0,0070	510 (460 – 550)
P11	M/A/D/E	0.400	1.0	0.055	0.070	0.085	0.11	0.13	0.15	0.17	140 (130 – 150)
		0,400	1,0	0,0022	0,0028	0,0034	0,0044	0,0050	0,0060	0,0065	460 (430 – 490)
P12	M/A/D/E	0.400	1.0	0.038	0.048	0.060	0.075	0.090	0.10	0.12	90 (79 – 100)
		0,400	1,0	0,0015	0,0019	0,0024	0,0030	0,0036	0,0040	0,0048	295 (260 – 320)
M1	E	0.400	1.0	0.042	0.055	0.065	0.085	0.10	0.11	0.13	110 (96 – 120)
		0,400	1,0	0,0017	0,0022	0,0026	0,0034	0,0040	0,0044	0,0050	360 (320 – 390)
M2	E	0.400	1.0	0.038	0.048	0.060	0.075	0.090	0.10	0.12	90 (79 – 100)
		0,400	1,0	0,0015	0,0019	0,0024	0,0030	0,0036	0,0040	0,0048	295 (260 – 320)
M3	E	0.400	0.90	0.032	0.040	0.048	0.065	0.075	0.085	0.10	55 (45 – 66)
		0,400	0,90	0,0013	0,0016	0,0019	0,0026	0,0030	0,0034	0,0040	180 (150 – 210)
M4	E	0.400	0.90	0.028	0.036	0.042	0.055	0.065	0.075	0.085	43 (35 – 51)
		0,400	0,90	0,0011	0,0014	0,0017	0,0022	0,0026	0,0030	0,0034	140 (120 – 160)
M5	E	0.400	0.90	0.028	0.036	0.042	0.055	0.065	0.075	0.085	36 (29 – 42)
		0,400	0,90	0,0011	0,0014	0,0017	0,0022	0,0026	0,0030	0,0034	120 (96 – 130)
K1	E	0.400	1.2	0.050	0.065	0.080	0.10	0.12	0.13	0.16	175 (160 – 190)
		0,400	1,2	0,0020	0,0026	0,0032	0,0040	0,0048	0,0050	0,0065	570 (530 – 620)
K2	E	0.400	1.2	0.048	0.060	0.070	0.090	0.11	0.12	0.14	155 (140 – 170)
		0,400	1,2	0,0019	0,0024	0,0028	0,0036	0,0044	0,0048	0,0055	510 (460 – 550)
K3	E	0.400	1.2	0.048	0.060	0.070	0.090	0.11	0.12	0.14	130 (120 – 140)
		0,400	1,2	0,0019	0,0024	0,0028	0,0036	0,0044	0,0048	0,0055	425 (400 – 450)
K4	E	0.400	1.2	0.048	0.060	0.070	0.090	0.11	0.12	0.14	125 (110 – 140)
		0,400	1,2	0,0019	0,0024	0,0028	0,0036	0,0044	0,0048	0,0055	410 (370 – 450)
K5	E	0.400	1.0	0.050	0.065	0.080	0.10	0.12	0.13	0.16	155 (140 – 170)
		0,400	1,0	0,0020	0,0026	0,0032	0,0040	0,0048	0,0050	0,0065	510 (460 – 550)
K6	E	0.400	1.0	0.055	0.070	0.085	0.11	0.13	0.15	0.17	220 (190 – 250)
		0,400	1,0	0,0022	0,0028	0,0034	0,0044	0,0050	0,0060	0,0065	720 (630 – 820)
K7	E	0.400	1.0	0.050	0.065	0.080	0.10	0.12	0.13	0.16	195 (170 – 220)
		0,400	1,0	0,0020	0,0026	0,0032	0,0040	0,0048	0,0050	0,0065	640 (560 – 720)

For cutting data recalculations, see pages 556 - 563

SMG = Seco material group
Coolant = A=air D=dry E=emulsion M=mist spray
v_c = m/min (sf/min)
f_z = mm/tooth (in/tooth)
a_p = mm/DC (in/DC) = factor
a_e = mm/DC (in/DC) = factor
All cutting data are target values

Cutting data – JS554 Side milling roughing – Inch

SMG		a _e /DC	a _p /DC	f _z							v _c
				1/4	5/16	3/8	1/2	5/8	3/4	1	
N1	E	0.500	0.90	0.050	0.065	0.075	0.10	0.12	0.13	0.15	610 (510 – 710)
		0,500	0,90	0,0020	0,0026	0,0030	0,0040	0,0048	0,0050	0,0060	2000 (1700 – 2300)
N2	E	0.500	0.90	0.050	0.065	0.075	0.10	0.12	0.13	0.15	390 (330 – 450)
		0,500	0,90	0,0020	0,0026	0,0030	0,0040	0,0048	0,0050	0,0060	1275 (1100 – 1400)
N3	E	0.500	0.90	0.050	0.065	0.075	0.10	0.12	0.13	0.15	260 (220 – 300)
		0,500	0,90	0,0020	0,0026	0,0030	0,0040	0,0048	0,0050	0,0060	850 (730 – 980)
N11	E	0.500	1.1	0.050	0.065	0.075	0.10	0.12	0.13	0.15	320 (270 – 370)
		0,500	1,1	0,0020	0,0026	0,0030	0,0040	0,0048	0,0050	0,0060	1050 (890 – 1200)
S1	E	0.150	0.50	0.055	0.070	0.085	0.11	0.13	0.14	0.17	38 (32 – 44)
		0,150	0,50	0,0022	0,0028	0,0034	0,0044	0,0050	0,0055	0,0065	125 (110 – 140)
S2	E	0.150	0.50	0.055	0.070	0.085	0.11	0.13	0.14	0.17	35 (21 – 48)
		0,150	0,50	0,0022	0,0028	0,0034	0,0044	0,0050	0,0055	0,0065	115 (69 – 150)
S3	E	0.150	0.50	0.050	0.065	0.075	0.10	0.12	0.13	0.16	30 (19 – 42)
		0,150	0,50	0,0020	0,0026	0,0030	0,0040	0,0048	0,0050	0,0065	100 (63 – 130)
S11	E	0.400	0.70	0.038	0.048	0.060	0.075	0.090	0.10	0.12	100 (72 – 120)
		0,400	0,70	0,0015	0,0019	0,0024	0,0030	0,0036	0,0040	0,0048	330 (240 – 390)
S12	E	0.400	0.70	0.038	0.048	0.060	0.075	0.090	0.10	0.12	75 (56 – 99)
		0,400	0,70	0,0015	0,0019	0,0024	0,0030	0,0036	0,0040	0,0048	245 (190 – 320)
S13	E	0.400	0.70	0.034	0.042	0.050	0.065	0.080	0.090	0.10	60 (44 – 78)
		0,400	0,70	0,0013	0,0017	0,0020	0,0026	0,0032	0,0036	0,0040	195 (150 – 250)
H5	M/A/D	0.200	0.90	0.048	0.060	0.070	0.095	0.11	0.12	0.15	75 (59 – 88)
		0,200	0,90	0,0019	0,0024	0,0028	0,0038	0,0044	0,0048	0,0060	245 (200 – 280)
H8	M/A/D	0.200	0.90	0.036	0.046	0.055	0.070	0.085	0.095	0.11	80 (63 – 93)
		0,200	0,90	0,0014	0,0018	0,0022	0,0028	0,0034	0,0038	0,0044	260 (210 – 300)
H21	M/A/D	0.200	0.90	0.036	0.046	0.055	0.070	0.085	0.095	0.11	155 (110 – 190)
		0,200	0,90	0,0014	0,0018	0,0022	0,0028	0,0034	0,0038	0,0044	510 (370 – 620)
H31	M/A/D	0.200	0.90	0.032	0.040	0.048	0.060	0.075	0.080	0.095	60 (48 – 71)
		0,200	0,90	0,0013	0,0016	0,0019	0,0024	0,0030	0,0032	0,0038	195 (160 – 230)
TS1	A	0.500	1.0	0.065	0.080	0.095	0.12	0.15	0.16	0.19	285 (180 – 400)
		0,500	1,0	0,0026	0,0032	0,0038	0,0048	0,0060	0,0065	0,0075	940 (600 – 1300)
TP1	A	0.500	1.0	0.065	0.080	0.095	0.12	0.15	0.16	0.19	295 (180 – 410)
		0,500	1,0	0,0026	0,0032	0,0038	0,0048	0,0060	0,0065	0,0075	970 (600 – 1300)
GR1	A	0.500	1.1	0.065	0.080	0.095	0.12	0.15	0.16	0.19	580 (470 – 690)
		0,500	1,1	0,0026	0,0032	0,0038	0,0048	0,0060	0,0065	0,0075	1900 (1600 – 2200)

For cutting data recalculations, see pages 556 - 563

SMG = Seco material group
 Coolant = A=air D=dry E=emulsion M=mist spray
 v_c= m/min (sf/min)
 f_z = mm/tooth (in/tooth)
 a_p = mm/DC (in/DC) = factor
 a_e = mm/DC (in/DC) = factor
 All cutting data are target values

Universal
Steel and cast iron
Stainless steel and S-materials
Non ferrous
Hard
Plastic and CFRP
Graphite
X-Heads
Minimaster Plus
Minimaster

Cutting data – JS554 Slot milling – Inch

SMG		a _p /DC	f _z							v _c
			1/4	5/16	3/8	1/2	5/8	3/4	1	
P1	M/A/D/E	1.0	0.038	0.048	0.055	0.075	0.095	0.11	0.15	195 (170 – 220)
		1,0	0,0015	0,0019	0,0022	0,0030	0,0038	0,0044	0,0060	640 (560 – 720)
P2	M/A/D/E	1.0	0.038	0.048	0.055	0.075	0.095	0.11	0.15	190 (170 – 210)
		1,0	0,0015	0,0019	0,0022	0,0030	0,0038	0,0044	0,0060	620 (560 – 680)
P3	M/A/D/E	1.0	0.038	0.048	0.055	0.075	0.095	0.11	0.15	165 (140 – 180)
		1,0	0,0015	0,0019	0,0022	0,0030	0,0038	0,0044	0,0060	540 (460 – 590)
P4	M/A/D/E	1.0	0.038	0.048	0.055	0.075	0.095	0.11	0.15	145 (130 – 160)
		1,0	0,0015	0,0019	0,0022	0,0030	0,0038	0,0044	0,0060	475 (430 – 520)
P5	M/A/D/E	1.0	0.038	0.048	0.055	0.075	0.095	0.11	0.15	135 (120 – 150)
		1,0	0,0015	0,0019	0,0022	0,0030	0,0038	0,0044	0,0060	445 (400 – 490)
P6	M/A/D/E	1.0	0.038	0.048	0.055	0.075	0.095	0.11	0.15	155 (140 – 170)
		1,0	0,0015	0,0019	0,0022	0,0030	0,0038	0,0044	0,0060	510 (460 – 550)
P7	M/A/D/E	1.0	0.038	0.048	0.055	0.075	0.095	0.11	0.15	145 (130 – 160)
		1,0	0,0015	0,0019	0,0022	0,0030	0,0038	0,0044	0,0060	475 (430 – 520)
P8	M/A/D/E	1.0	0.038	0.048	0.055	0.075	0.095	0.11	0.15	135 (120 – 150)
		1,0	0,0015	0,0019	0,0022	0,0030	0,0038	0,0044	0,0060	445 (400 – 490)
P11	M/A/D/E	0.80	0.025	0.032	0.038	0.050	0.065	0.075	0.10	130 (120 – 140)
		0,80	0,0010	0,0013	0,0015	0,0020	0,0026	0,0030	0,0040	425 (400 – 450)
P12	M/A/D/E	0.80	0.025	0.032	0.038	0.050	0.065	0.075	0.10	80 (69 – 87)
		0,80	0,0010	0,0013	0,0015	0,0020	0,0026	0,0030	0,0040	260 (230 – 280)
M1	E	0.80	0.025	0.032	0.038	0.050	0.065	0.075	0.10	95 (85 – 100)
		0,80	0,0010	0,0013	0,0015	0,0020	0,0026	0,0030	0,0040	310 (280 – 320)
M2	E	0.80	0.025	0.032	0.038	0.050	0.065	0.075	0.10	80 (69 – 87)
		0,80	0,0010	0,0013	0,0015	0,0020	0,0026	0,0030	0,0040	260 (230 – 280)
M3	E	0.60	0.020	0.025	0.030	0.040	0.050	0.060	0.080	48 (39 – 57)
		0,60	0,00080	0,0010	0,0012	0,0016	0,0020	0,0024	0,0032	155 (130 – 180)
M4	E	0.60	0.020	0.025	0.030	0.040	0.050	0.060	0.080	36 (29 – 43)
		0,60	0,00080	0,0010	0,0012	0,0016	0,0020	0,0024	0,0032	120 (96 – 140)
M5	E	0.60	0.020	0.025	0.030	0.040	0.050	0.060	0.080	30 (25 – 36)
		0,60	0,00080	0,0010	0,0012	0,0016	0,0020	0,0024	0,0032	100 (83 – 110)
K1	E	1.0	0.032	0.040	0.048	0.065	0.080	0.095	0.13	155 (140 – 170)
		1,0	0,0013	0,0016	0,0019	0,0026	0,0032	0,0038	0,0050	510 (460 – 550)
K2	E	1.0	0.032	0.040	0.048	0.065	0.080	0.095	0.13	135 (120 – 150)
		1,0	0,0013	0,0016	0,0019	0,0026	0,0032	0,0038	0,0050	445 (400 – 490)
K3	E	1.0	0.032	0.040	0.048	0.065	0.080	0.095	0.13	115 (110 – 120)
		1,0	0,0013	0,0016	0,0019	0,0026	0,0032	0,0038	0,0050	375 (370 – 390)
K4	E	1.0	0.032	0.040	0.048	0.065	0.080	0.095	0.13	110 (96 – 120)
		1,0	0,0013	0,0016	0,0019	0,0026	0,0032	0,0038	0,0050	360 (320 – 390)
K5	E	0.70	0.032	0.040	0.048	0.065	0.080	0.095	0.13	135 (120 – 150)
		0,70	0,0013	0,0016	0,0019	0,0026	0,0032	0,0038	0,0050	445 (400 – 490)
K6	E	0.70	0.032	0.040	0.048	0.065	0.080	0.095	0.13	200 (180 – 220)
		0,70	0,0013	0,0016	0,0019	0,0026	0,0032	0,0038	0,0050	660 (600 – 720)
K7	E	0.70	0.032	0.040	0.048	0.065	0.080	0.095	0.13	175 (150 – 190)
		0,70	0,0013	0,0016	0,0019	0,0026	0,0032	0,0038	0,0050	570 (500 – 620)

For cutting data recalculations, see pages 556 - 563

SMG = Seco material group
Coolant = A=air D=dry E=emulsion M=mist spray
v_c = m/min (sf/min)
f_z = mm/tooth (in/tooth)
a_p = mm/DC (in/DC) = factor
a_e = mm/DC (in/DC) = factor
All cutting data are target values

Cutting data – JS554 Slot milling – Inch

SMG		a _p /DC	f _z							v _c
			1/4	5/16	3/8	1/2	5/8	3/4	1	
N1	E	0.50	0.032	0.040	0.048	0.065	0.080	0.095	0.13	570 (480 – 670)
		0,50	0,0013	0,0016	0,0019	0,0026	0,0032	0,0038	0,0050	1875 (1600 – 2100)
N2	E	0.50	0.032	0.040	0.048	0.065	0.080	0.095	0.13	370 (310 – 430)
		0,50	0,0013	0,0016	0,0019	0,0026	0,0032	0,0038	0,0050	1225 (1100 – 1400)
N3	E	0.50	0.032	0.040	0.048	0.065	0.080	0.095	0.13	245 (210 – 280)
		0,50	0,0013	0,0016	0,0019	0,0026	0,0032	0,0038	0,0050	800 (690 – 910)
N11	E	0.60	0.038	0.048	0.055	0.075	0.095	0.11	0.15	290 (250 – 330)
		0,60	0,0015	0,0019	0,0022	0,0030	0,0038	0,0044	0,0060	950 (830 – 1000)
S1	E	0.30	0.020	0.025	0.030	0.040	0.050	0.060	0.080	30 (25 – 34)
		0,30	0,00080	0,0010	0,0012	0,0016	0,0020	0,0024	0,0032	100 (83 – 110)
S2	E	0.30	0.020	0.025	0.030	0.040	0.050	0.060	0.080	27 (17 – 38)
		0,30	0,00080	0,0010	0,0012	0,0016	0,0020	0,0024	0,0032	90 (56 – 120)
S3	E	0.30	0.020	0.025	0.030	0.040	0.050	0.060	0.080	23 (15 – 32)
		0,30	0,00080	0,0010	0,0012	0,0016	0,0020	0,0024	0,0032	75 (50 – 100)
S11	E	0.50	0.026	0.032	0.038	0.050	0.065	0.080	0.10	85 (63 – 110)
		0,50	0,0010	0,0013	0,0015	0,0020	0,0026	0,0032	0,0040	280 (210 – 360)
S12	E	0.50	0.026	0.032	0.038	0.050	0.065	0.080	0.10	65 (48 – 86)
		0,50	0,0010	0,0013	0,0015	0,0020	0,0026	0,0032	0,0040	215 (160 – 280)
S13	E	0.50	0.026	0.032	0.038	0.050	0.065	0.080	0.10	50 (38 – 66)
		0,50	0,0010	0,0013	0,0015	0,0020	0,0026	0,0032	0,0040	165 (130 – 210)
H5	M/A/D	0.40	0.013	0.016	0.019	0.026	0.032	0.038	0.050	65 (52 – 76)
		0,40	0,00050	0,00065	0,00075	0,0010	0,0013	0,0015	0,0020	215 (180 – 240)
H8	M/A/D	0.40	0.013	0.016	0.019	0.026	0.032	0.038	0.050	65 (52 – 76)
		0,40	0,00050	0,00065	0,00075	0,0010	0,0013	0,0015	0,0020	215 (180 – 240)
H21	M/A/D	0.40	0.013	0.016	0.019	0.026	0.032	0.038	0.050	125 (90 – 160)
		0,40	0,00050	0,00065	0,00075	0,0010	0,0013	0,0015	0,0020	410 (300 – 520)
H31	M/A/D	0.40	0.013	0.016	0.019	0.026	0.032	0.038	0.050	48 (39 – 57)
		0,40	0,00050	0,00065	0,00075	0,0010	0,0013	0,0015	0,0020	155 (130 – 180)
TS1	A	0.70	0.065	0.080	0.095	0.12	0.15	0.16	0.19	240 (150 – 330)
		0,70	0,0026	0,0032	0,0038	0,0048	0,0060	0,0065	0,0075	790 (500 – 1000)
TP1	A	0.70	0.065	0.080	0.095	0.12	0.15	0.16	0.19	250 (150 – 340)
		0,70	0,0026	0,0032	0,0038	0,0048	0,0060	0,0065	0,0075	820 (500 – 1100)
GR1	A	0.80	0.065	0.080	0.095	0.12	0.15	0.16	0.19	485 (390 – 580)
		0,80	0,0026	0,0032	0,0038	0,0048	0,0060	0,0065	0,0075	1600 (1300 – 1900)

For cutting data recalculations, see pages 556 - 563

SMG = Seco material group
 Coolant = A=air D=dry E=emulsion M=mist spray
 v_c = m/min (sf/min)
 f_z = mm/tooth (in/tooth)
 a_p = mm/DC (in/DC) = factor
 a_e = mm/DC (in/DC) = factor
 All cutting data are target values

Universal
 Steel and cast iron
 Stainless steel and S-materials
 Non ferrous
 Hard
 Plastic and CFRP
 Graphite
 X-Heads
 Minmaster Plus
 Minmaster

JS554-3C

Advanced roughing – Universal – Square – 4 Flutes – Cylindrical – Chamfer

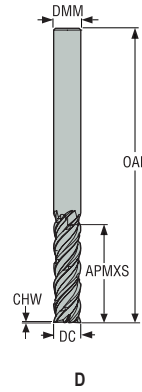

- Tolerances:
- DMM= h5
- DC= e7
- Chip splitters
- Regrind possible

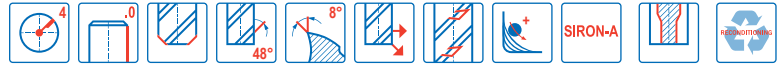

Designation	Item number	Length index	Tool shape	Chip splitters	DC	DMM	APMXS	OAL	CHW	PCEDC	Cylindrical
					mm	mm	mm	mm	mm		
JS554060D3C.0Z4C-SIRA	02810475	3	D	■	6,0	6,0	23,0	65,0	0,075	4	■
JS554080D3C.0Z4C-SIRA	02810477	3	D	■	8,0	8,0	32,0	75,0	0,1	4	■
JS554100D3C.0Z4C-SIRA	02810479	3	D	■	10,0	10,0	40,0	85,0	0,125	4	■
JS554120D3C.0Z4C-SIRA	02810481	3	D	■	12,0	12,0	45,0	100,0	0,15	4	■
JS554160D3C.0Z4C-SIRA	02810483	3	D	■	16,0	16,0	55,0	115,0	0,2	4	■
JS554200D3C.0Z4C-SIRA	02810485	3	D	■	20,0	20,0	65,0	125,0	0,25	4	■
JS554250D3C.0Z4C-SIRA	02810486	3	D	■	25,0	25,0	85,0	150,0	0,3	4	■

■ Stocked standard.

Universal
Steel and cast iron
Stainless steel and S-materials
Non ferrous
Hard
Plastic and cfrp
Graphite
X-Heads
Minimaster Plus
Minimaster

JS554-3C

Advanced roughing – Universal – Square – 4 Flutes – Weldon – Chamfer

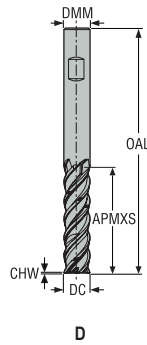

D



- Tolerances:
- DMM= h5
- DC= e7
- Chip splitters
- Regrind possible

Designation	Item number	Length index	Tool shape	Chip splitters	DC	DMM	APMXS	OAL	CHW	PCEDC	Weldon
					mm	mm	mm	mm	mm		
JS554060D3C.3Z4C-SIRA	02810474	3	D	■	6,0	6,0	23,0	65,0	0,075	4	■
JS554080D3C.3Z4C-SIRA	02810476	3	D	■	8,0	8,0	32,0	75,0	0,1	4	■
JS554100D3C.3Z4C-SIRA	02810478	3	D	■	10,0	10,0	40,0	85,0	0,125	4	■
JS554120D3C.3Z4C-SIRA	02810480	3	D	■	12,0	12,0	45,0	100,0	0,15	4	■
JS554160D3C.3Z4C-SIRA	02810482	3	D	■	16,0	16,0	55,0	115,0	0,2	4	■
JS554200D3C.3Z4C-SIRA	02810484	3	D	■	20,0	20,0	65,0	125,0	0,25	4	■
JS554250D3C.3Z4C-SIRA	02810487	3	D	■	25,0	25,0	85,0	150,0	0,3	4	■

■ Stocked standard.

Universal
Steel and cast iron
Stainless steel and S-materials
Non ferrous
Hard
Plastic and CFRP
Graphite
X-Heads
Minimaster Plus
Minimaster

Cutting data – JS554-3C Advanced roughing

SMG		a _e /DC	a _p /DC	f _z							v _c
				6	8	10	12	16	20	25	
P1	M/A/D/E	0.100	3.6	0.065	0.085	0.11	0.13	0.16	0.18	0.20	350 (320 – 380)
		0,100	3,6	0,0026	0,0034	0,0044	0,0050	0,0065	0,0070	0,0080	1150 (1100 – 1200)
P2	M/A/D/E	0.100	3.6	0.065	0.090	0.11	0.13	0.16	0.19	0.22	340 (310 – 370)
		0,100	3,6	0,0026	0,0036	0,0044	0,0050	0,0065	0,0075	0,0085	1125 (1100 – 1200)
P3	M/A/D/E	0.100	3.6	0.060	0.085	0.10	0.12	0.15	0.18	0.20	295 (270 – 320)
		0,100	3,6	0,0024	0,0034	0,0040	0,0048	0,0060	0,0070	0,0080	970 (890 – 1000)
P4	M/A/D/E	0.100	3.6	0.060	0.080	0.10	0.12	0.15	0.17	0.19	260 (240 – 280)
		0,100	3,6	0,0024	0,0032	0,0040	0,0048	0,0060	0,0065	0,0075	850 (790 – 910)
P5	M/A/D/E	0.100	3.6	0.060	0.080	0.10	0.12	0.15	0.17	0.19	250 (230 – 270)
		0,100	3,6	0,0024	0,0032	0,0040	0,0048	0,0060	0,0065	0,0075	820 (760 – 880)
P6	M/A/D/E	0.100	3.6	0.060	0.080	0.10	0.12	0.15	0.17	0.19	280 (260 – 300)
		0,100	3,6	0,0024	0,0032	0,0040	0,0048	0,0060	0,0065	0,0075	920 (860 – 980)
P7	M/A/D/E	0.100	3.6	0.060	0.080	0.10	0.12	0.15	0.17	0.19	265 (240 – 290)
		0,100	3,6	0,0024	0,0032	0,0040	0,0048	0,0060	0,0065	0,0075	870 (790 – 950)
P8	M/A/D/E	0.100	3.6	0.060	0.085	0.10	0.12	0.15	0.18	0.20	250 (230 – 270)
		0,100	3,6	0,0024	0,0034	0,0040	0,0048	0,0060	0,0070	0,0080	820 (760 – 880)
P11	M/A/D/E	0.100	3.6	0.070	0.095	0.12	0.14	0.19	0.24	0.28	245 (230 – 270)
		0,100	3,6	0,0028	0,0038	0,0048	0,0055	0,0075	0,0095	0,011	800 (760 – 880)
P12	M/A/D/E	0.100	3.6	0.060	0.080	0.10	0.12	0.15	0.17	0.19	150 (140 – 160)
		0,100	3,6	0,0024	0,0032	0,0040	0,0048	0,0060	0,0065	0,0075	490 (460 – 520)
M1	E	0.100	3.6	0.065	0.090	0.11	0.13	0.16	0.19	0.22	180 (160 – 210)
		0,100	3,6	0,0026	0,0036	0,0044	0,0050	0,0065	0,0075	0,0085	590 (530 – 680)
M2	E	0.100	3.6	0.060	0.080	0.10	0.12	0.15	0.17	0.19	150 (130 – 170)
		0,100	3,6	0,0024	0,0032	0,0040	0,0048	0,0060	0,0065	0,0075	490 (430 – 550)
M3	E	0.100	3.6	0.060	0.080	0.10	0.12	0.15	0.17	0.19	100 (90 – 100)
		0,100	3,6	0,0024	0,0032	0,0040	0,0048	0,0060	0,0065	0,0075	330 (300 – 320)
M4	E	0.100	3.6	0.050	0.070	0.085	0.10	0.13	0.15	0.17	75 (70 – 85)
		0,100	3,6	0,0020	0,0028	0,0034	0,0040	0,0050	0,0060	0,0065	245 (230 – 270)
M5	E	0.100	3.6	0.050	0.070	0.085	0.10	0.13	0.15	0.17	65 (59 – 71)
		0,100	3,6	0,0020	0,0028	0,0034	0,0040	0,0050	0,0060	0,0065	215 (200 – 230)
K1	E	0.100	3.6	0.065	0.090	0.11	0.13	0.16	0.19	0.22	340 (310 – 370)
		0,100	3,6	0,0026	0,0036	0,0044	0,0050	0,0065	0,0075	0,0085	1125 (1100 – 1200)
K2	E	0.100	3.6	0.060	0.080	0.10	0.12	0.15	0.17	0.19	185 (160 – 210)
		0,100	3,6	0,0024	0,0032	0,0040	0,0048	0,0060	0,0065	0,0075	610 (530 – 680)
K3	E	0.100	3.6	0.060	0.080	0.10	0.12	0.15	0.17	0.19	255 (240 – 280)
		0,100	3,6	0,0024	0,0032	0,0040	0,0048	0,0060	0,0065	0,0075	840 (790 – 910)
K4	E	0.100	3.6	0.060	0.080	0.10	0.12	0.15	0.17	0.19	245 (220 – 260)
		0,100	3,6	0,0024	0,0032	0,0040	0,0048	0,0060	0,0065	0,0075	800 (730 – 850)
K5	E	0.100	3.6	0.055	0.070	0.090	0.11	0.13	0.15	0.17	150 (140 – 160)
		0,100	3,6	0,0022	0,0028	0,0036	0,0044	0,0050	0,0060	0,0065	490 (460 – 520)
K6	E	0.100	3.6	0.060	0.080	0.10	0.12	0.15	0.17	0.19	215 (200 – 230)
		0,100	3,6	0,0024	0,0032	0,0040	0,0048	0,0060	0,0065	0,0075	710 (660 – 750)
K7	E	0.100	3.6	0.055	0.070	0.090	0.11	0.13	0.15	0.17	190 (180 – 200)
		0,100	3,6	0,0022	0,0028	0,0036	0,0044	0,0050	0,0060	0,0065	620 (600 – 650)

For cutting data recalculations, see pages 556 - 563

SMG = Seco material group
Coolant = A=air D=dry E=emulsion M=mist spray
v_c = m/min (sf/min)
f_z = mm (in/tooth)
a_p = mm/DC (in/DC) = factor
a_e = mm/DC (in/DC) = factor
All cutting data are target values

Cutting data – JS554-3C Advanced roughing

SMG	Coolant	a _e /DC	a _p /DC	f _z						v _c	
				6	8	10	12	16	20		25
N1	E	0.100	3.6	0.060	0.080	0.10	0.12	0.15	0.17	0.19	750 (650 – 840)
		0,100	3,6	0,0024	0,0032	0,0040	0,0048	0,0060	0,0065	0,0075	2450 (2200 – 2700)
N2	E	0.100	3.6	0.060	0.080	0.10	0.12	0.15	0.17	0.19	480 (420 – 540)
		0,100	3,6	0,0024	0,0032	0,0040	0,0048	0,0060	0,0065	0,0075	1575 (1400 – 1700)
N3	E	0.100	3.6	0.060	0.080	0.10	0.12	0.15	0.17	0.19	320 (280 – 360)
		0,100	3,6	0,0024	0,0032	0,0040	0,0048	0,0060	0,0065	0,0075	1050 (920 – 1100)
N11	E	0.100	3.6	0.060	0.080	0.10	0.12	0.15	0.17	0.19	375 (330 – 420)
		0,100	3,6	0,0024	0,0032	0,0040	0,0048	0,0060	0,0065	0,0075	1225 (1100 – 1300)
S1	E	0.0500	3.6	0.048	0.065	0.080	0.095	0.12	0.14	0.15	50 (40 – 60)
		0,0500	3,6	0,0019	0,0026	0,0032	0,0038	0,0048	0,0055	0,0060	165 (140 – 190)
S2	E	0.0500	3.6	0.048	0.065	0.080	0.095	0.12	0.14	0.15	40 (33 – 48)
		0,0500	3,6	0,0019	0,0026	0,0032	0,0038	0,0048	0,0055	0,0060	130 (110 – 150)
S3	E	0.0500	3.6	0.048	0.065	0.080	0.095	0.12	0.14	0.15	25 (20 – 29)
		0,0500	3,6	0,0019	0,0026	0,0032	0,0038	0,0048	0,0055	0,0060	80 (66 – 95)
S11	E	0.100	3.6	0.048	0.065	0.080	0.095	0.12	0.14	0.15	195 (130 – 220)
		0,100	3,6	0,0019	0,0026	0,0032	0,0038	0,0048	0,0055	0,0060	640 (430 – 720)
S12	E	0.100	3.6	0.048	0.065	0.080	0.095	0.12	0.14	0.15	150 (100 – 160)
		0,100	3,6	0,0019	0,0026	0,0032	0,0038	0,0048	0,0055	0,0060	490 (330 – 520)
S13	E	0.100	3.6	0.042	0.055	0.070	0.085	0.10	0.12	0.13	120 (80 – 130)
		0,100	3,6	0,0017	0,0022	0,0028	0,0034	0,0040	0,0048	0,0050	395 (270 – 420)
H5	M/A/D	0.0500	3.6	0.030	0.040	0.050	0.060	0.075	0.085	0.095	200 (190 – 220)
		0,0500	3,6	0,0012	0,0016	0,0020	0,0024	0,0030	0,0034	0,0038	660 (630 – 720)
H8	M/A/D	0.0500	3.6	0.022	0.030	0.038	0.046	0.055	0.065	0.075	210 (190 – 220)
		0,0500	3,6	0,00085	0,0012	0,0015	0,0018	0,0022	0,0026	0,0030	690 (630 – 720)
H11	M/A/D	0.0500	3.6	0.030	0.040	0.050	0.060	0.075	0.085	0.095	255 (240 – 280)
		0,0500	3,6	0,0012	0,0016	0,0020	0,0024	0,0030	0,0034	0,0038	840 (790 – 910)
H12	M/A/D	0.100	3.6	0.032	0.042	0.050	0.060	0.075	0.090	0.10	205 (190 – 220)
		0,100	3,6	0,0013	0,0017	0,0020	0,0024	0,0030	0,0036	0,0040	670 (630 – 720)
H21	M/A/D	0.0500	3.6	0.022	0.030	0.038	0.046	0.055	0.065	0.075	210 (190 – 220)
		0,0500	3,6	0,00085	0,0012	0,0015	0,0018	0,0022	0,0026	0,0030	690 (630 – 720)

For cutting data recalculations, see pages 556 - 563

SMG = Seco material group
 Coolant = A=air D=dry E=emulsion M=mist spray
 v_c = m/min (sf/min)
 f_z = mm (in/tooth)
 a_p = mm/DC (in/DC) = factor
 a_e = mm/DC (in/DC) = factor
 All cutting data are target values

Universal
Steel and cast iron
Stainless steel and S-materials
Non ferrous
Hard
Plastic and CFRP
Graphite
X-Heads
Minimaster Plus
Minimaster

JS564

Advanced roughing – Universal – Square – 4 Flutes – Cylindrical – Chamfer

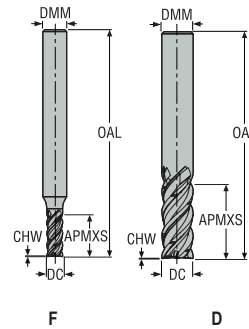

- Tolerances:
- DMM= h5
- DC= e7
- Chip splitters
- Regrind possible if DC is $\geq \varnothing 8$



Designation	Item number	Length index	Tool shape	Chip splitters	DC	DMM	APMXS	OAL	CHW	PCEDC	Cylindrical
					mm	mm	mm	mm	mm		
JS564030F2C.0Z4C-NXT	03067338	2	F	■	3,0	6,0	7,0	57,0	0,04	4	■
JS564040F2C.0Z4C-NXT	03067339	2	F	■	4,0	6,0	10,0	57,0	0,05	4	■
JS564050F2C.0Z4C-NXT	03067340	2	F	■	5,0	6,0	12,5	57,0	0,06	4	■
JS564060D2C.0Z4C-NXT	03067341	2	D	■	6,0	6,0	15,0	57,0	0,075	4	■
JS564080D2C.0Z4C-NXT	03067342	2	D	■	8,0	8,0	20,0	63,0	0,1	4	■
JS564100D2C.0Z4C-NXT	03067343	2	D	■	10,0	10,0	25,0	72,0	0,125	4	■
JS564120D2C.0Z4C-NXT	03067344	2	D	■	12,0	12,0	30,0	83,0	0,15	4	■
JS564160D2C.0Z4C-NXT	03067345	2	D	■	16,0	16,0	40,0	99,0	0,2	4	■
JS564200D2C.0Z4C-NXT	03067346	2	D	■	20,0	20,0	50,0	114,0	0,25	4	■
JS564060D3C.0Z4C-NXT	03067347	3	D	■	6,0	6,0	23,0	64,0	0,075	4	■
JS564080D3C.0Z4C-NXT	03067348	3	D	■	8,0	8,0	32,0	74,0	0,1	4	■
JS564100D3C.0Z4C-NXT	03067349	3	D	■	10,0	10,0	40,0	88,0	0,125	4	■
JS564120D3C.0Z4C-NXT	03067350	3	D	■	12,0	12,0	45,0	99,0	0,15	4	■
JS564160D3C.0Z4C-NXT	03067351	3	D	■	16,0	16,0	55,0	114,0	0,2	4	■
JS564200D3C.0Z4C-NXT	03067352	3	D	■	20,0	20,0	65,0	126,0	0,25	4	■

■ Stocked standard.

Universal

Steel and cast iron

Stainless steel and S-materials

Non ferrous

Hard

Plastic and CFRP

Graphite

X-Heads

Minimaster Plus

Minimaster

JS564

Advanced roughing – Universal – Square – 4 Flutes – Weldon – Chamfer

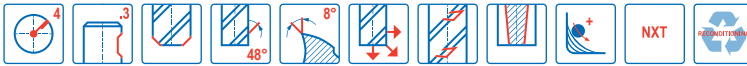
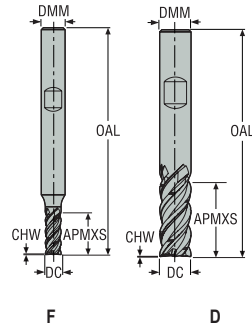

- Tolerances:
- DMM= h5
- DC= e7
- Chip splitters
- Regrind possible if DC is $\geq \varnothing 8$

Designation	Item number	Length index	Tool shape	Chip splitters	DC	DMM	APMXS	OAL	CHW	PCEDC	Weldon
					mm	mm	mm	mm	mm		
JS564030F2C.3Z4C-NXT	03067353	2	F	■	3,0	6,0	7,0	57,0	0,04	4	■
JS564040F2C.3Z4C-NXT	03067354	2	F	■	4,0	6,0	10,0	57,0	0,05	4	■
JS564050F2C.3Z4C-NXT	03067355	2	F	■	5,0	6,0	12,5	57,0	0,06	4	■
JS564060D2C.3Z4C-NXT	03067356	2	D	■	6,0	6,0	15,0	57,0	0,075	4	■
JS564080D2C.3Z4C-NXT	03067357	2	D	■	8,0	8,0	20,0	63,0	0,1	4	■
JS564100D2C.3Z4C-NXT	03067358	2	D	■	10,0	10,0	25,0	72,0	0,125	4	■
JS564120D2C.3Z4C-NXT	03067359	2	D	■	12,0	12,0	30,0	83,0	0,15	4	■
JS564160D2C.3Z4C-NXT	03067360	2	D	■	16,0	16,0	40,0	99,0	0,2	4	■
JS564200D2C.3Z4C-NXT	03067361	2	D	■	20,0	20,0	50,0	114,0	0,25	4	■
JS564060D3C.3Z4C-NXT	03067362	3	D	■	6,0	6,0	23,0	64,0	0,075	4	■
JS564080D3C.3Z4C-NXT	03067363	3	D	■	8,0	8,0	32,0	74,0	0,1	4	■
JS564100D3C.3Z4C-NXT	03067364	3	D	■	10,0	10,0	40,0	88,0	0,125	4	■
JS564120D3C.3Z4C-NXT	03067365	3	D	■	12,0	12,0	45,0	99,0	0,15	4	■
JS564160D3C.3Z4C-NXT	03067366	3	D	■	16,0	16,0	55,0	114,0	0,2	4	■
JS564200D3C.3Z4C-NXT	03067367	3	D	■	20,0	20,0	65,0	126,0	0,25	4	■

■ Stocked standard.

Universal

Steel and cast iron

Stainless steel and S-materials

Non ferrous

Hard

Plastic and CFRP

Graphite

X-Heads

Minimaster Plus

Minimaster

Cutting data – JS564 Side milling advanced roughing

SMG		a _e /DC	a _p /DC	f _z								v _c
				4	5	6	8	10	12	16	20	
P1	E/M/A/D	0.150	2.4	0.042	0.055	0.065	0.085	0.11	0.13	0.16	0.18	305 (270 – 340)
		0,150	2,4	0,0017	0,0022	0,0026	0,0034	0,0044	0,0050	0,0065	0,0070	1000 (890 – 1100)
P2	E/M/A/D	0.150	2.4	0.044	0.055	0.065	0.085	0.11	0.13	0.16	0.18	295 (260 – 330)
		0,150	2,4	0,0017	0,0022	0,0026	0,0034	0,0044	0,0050	0,0065	0,0070	970 (860 – 1000)
P3	E/M/A/D	0.150	2.4	0.040	0.050	0.060	0.080	0.10	0.12	0.15	0.17	260 (230 – 290)
		0,150	2,4	0,0016	0,0020	0,0024	0,0032	0,0040	0,0048	0,0060	0,0065	850 (760 – 950)
P4	E/M/A/D	0.150	2.4	0.040	0.050	0.060	0.080	0.10	0.12	0.15	0.17	230 (200 – 250)
		0,150	2,4	0,0016	0,0020	0,0024	0,0032	0,0040	0,0048	0,0060	0,0065	750 (660 – 820)
P5	E/M/A/D	0.150	2.4	0.040	0.050	0.060	0.080	0.10	0.12	0.15	0.17	215 (190 – 240)
		0,150	2,4	0,0016	0,0020	0,0024	0,0032	0,0040	0,0048	0,0060	0,0065	710 (630 – 780)
P6	E/M/A/D	0.150	2.4	0.040	0.050	0.060	0.080	0.10	0.12	0.15	0.17	240 (210 – 270)
		0,150	2,4	0,0016	0,0020	0,0024	0,0032	0,0040	0,0048	0,0060	0,0065	790 (690 – 880)
P7	E/M/A/D	0.150	2.4	0.040	0.050	0.060	0.080	0.10	0.12	0.15	0.17	230 (200 – 250)
		0,150	2,4	0,0016	0,0020	0,0024	0,0032	0,0040	0,0048	0,0060	0,0065	750 (660 – 820)
P8	E/M/A/D	0.150	2.4	0.042	0.050	0.060	0.085	0.10	0.12	0.15	0.18	215 (190 – 240)
		0,150	2,4	0,0017	0,0020	0,0024	0,0034	0,0040	0,0048	0,0060	0,0070	710 (630 – 780)
P11	E/M/A/D	0.150	2.4	0.060	0.075	0.090	0.12	0.15	0.17	0.22	0.25	200 (180 – 220)
		0,150	2,4	0,0024	0,0030	0,0036	0,0048	0,0060	0,0065	0,0085	0,010	660 (600 – 720)
P12	E/M/A/D	0.150	2.4	0.040	0.050	0.060	0.080	0.10	0.12	0.15	0.17	130 (120 – 140)
		0,150	2,4	0,0016	0,0020	0,0024	0,0032	0,0040	0,0048	0,0060	0,0065	425 (400 – 450)
M1	E	0.150	2.4	0.044	0.055	0.065	0.090	0.11	0.13	0.16	0.19	195 (170 – 210)
		0,150	2,4	0,0017	0,0022	0,0026	0,0036	0,0044	0,0050	0,0065	0,0075	640 (560 – 680)
M2	E	0.150	2.4	0.040	0.050	0.060	0.080	0.10	0.12	0.15	0.17	160 (140 – 170)
		0,150	2,4	0,0016	0,0020	0,0024	0,0032	0,0040	0,0048	0,0060	0,0065	520 (460 – 550)
M3	E	0.100	2.4	0.040	0.050	0.060	0.080	0.10	0.12	0.15	0.17	130 (110 – 140)
		0,100	2,4	0,0016	0,0020	0,0024	0,0032	0,0040	0,0048	0,0060	0,0065	425 (370 – 450)
M4	E	0.100	2.4	0.040	0.050	0.060	0.080	0.10	0.12	0.15	0.17	130 (110 – 140)
		0,100	2,4	0,0016	0,0020	0,0024	0,0032	0,0040	0,0048	0,0060	0,0065	425 (370 – 450)
M5	E	0.100	2.4	0.040	0.050	0.060	0.080	0.10	0.12	0.15	0.17	110 (92 – 120)
		0,100	2,4	0,0016	0,0020	0,0024	0,0032	0,0040	0,0048	0,0060	0,0065	360 (310 – 390)
K1	E	0.150	2.4	0.044	0.055	0.065	0.090	0.11	0.13	0.16	0.19	260 (230 – 290)
		0,150	2,4	0,0017	0,0022	0,0026	0,0036	0,0044	0,0050	0,0065	0,0075	850 (760 – 950)
K2	E	0.150	2.4	0.040	0.050	0.060	0.080	0.10	0.12	0.15	0.17	230 (200 – 250)
		0,150	2,4	0,0016	0,0020	0,0024	0,0032	0,0040	0,0048	0,0060	0,0065	750 (660 – 820)
K3	E	0.150	2.4	0.040	0.050	0.060	0.080	0.10	0.12	0.15	0.17	195 (170 – 210)
		0,150	2,4	0,0016	0,0020	0,0024	0,0032	0,0040	0,0048	0,0060	0,0065	640 (560 – 680)
K4	E	0.150	2.4	0.040	0.050	0.060	0.080	0.10	0.12	0.15	0.17	185 (170 – 200)
		0,150	2,4	0,0016	0,0020	0,0024	0,0032	0,0040	0,0048	0,0060	0,0065	610 (560 – 650)
K5	E	0.150	2.4	0.036	0.044	0.055	0.070	0.090	0.11	0.13	0.15	115 (99 – 120)
		0,150	2,4	0,0014	0,0017	0,0022	0,0028	0,0036	0,0044	0,0050	0,0060	375 (330 – 390)
K6	E	0.150	2.4	0.040	0.050	0.060	0.080	0.10	0.12	0.15	0.17	165 (150 – 180)
		0,150	2,4	0,0016	0,0020	0,0024	0,0032	0,0040	0,0048	0,0060	0,0065	540 (500 – 590)
K7	E	0.150	2.4	0.036	0.044	0.055	0.070	0.090	0.11	0.13	0.15	145 (130 – 160)
		0,150	2,4	0,0014	0,0017	0,0022	0,0028	0,0036	0,0044	0,0050	0,0060	475 (430 – 520)

For cutting data recalculations, see pages 556 - 563

SMG = Seco material group
 Coolant = A=air D=dry E=emulsion M=mist spray
 v_c = m/min (sf/min)
 f_z = mm (in/tooth)
 a_p = mm/DC (in/DC) = factor
 a_e = mm/DC (in/DC) = factor
 All cutting data are target values

Cutting data – JS564 Side milling advanced roughing

SMG		a _p /DC	a _e /DC	f _z								v _c
				4	5	6	8	10	12	16	20	
N1	E	0.150	2.4	0.040	0.050	0.060	0.080	0.10	0.12	0.15	0.17	700 (600 – 790)
		0,150	2,4	0,0016	0,0020	0,0024	0,0032	0,0040	0,0048	0,0060	0,0065	2300 (2000 – 2500)
N2	E	0.150	2.4	0.040	0.050	0.060	0.080	0.10	0.12	0.15	0.17	450 (390 – 510)
		0,150	2,4	0,0016	0,0020	0,0024	0,0032	0,0040	0,0048	0,0060	0,0065	1475 (1300 – 1600)
N3	E	0.100	2.4	0.040	0.050	0.060	0.080	0.10	0.12	0.15	0.17	500 (400 – 590)
		0,100	2,4	0,0016	0,0020	0,0024	0,0032	0,0040	0,0048	0,0060	0,0065	1650 (1400 – 1900)
N11	E	0.150	2.4	0.040	0.050	0.060	0.080	0.10	0.12	0.15	0.17	350 (300 – 390)
		0,150	2,4	0,0016	0,0020	0,0024	0,0032	0,0040	0,0048	0,0060	0,0065	1150 (990 – 1200)
S1	E	0.0300	2.4	0.030	0.038	0.046	0.060	0.075	0.090	0.11	0.13	60 (37 – 86)
		0,0300	2,4	0,0012	0,0015	0,0018	0,0024	0,0030	0,0036	0,0044	0,0050	195 (130 – 280)
S2	E	0.0300	2.4	0.030	0.038	0.046	0.060	0.075	0.090	0.11	0.13	50 (30 – 69)
		0,0300	2,4	0,0012	0,0015	0,0018	0,0024	0,0030	0,0036	0,0044	0,0050	165 (99 – 220)
S3	E	0.0300	2.4	0.028	0.034	0.042	0.055	0.070	0.085	0.10	0.12	43 (26 – 60)
		0,0300	2,4	0,0011	0,0013	0,0017	0,0022	0,0028	0,0034	0,0040	0,0048	140 (86 – 190)
S11	E	0.0800	2.4	0.028	0.034	0.042	0.055	0.070	0.085	0.10	0.12	160 (140 – 180)
		0,0800	2,4	0,0011	0,0013	0,0017	0,0022	0,0028	0,0034	0,0040	0,0048	520 (460 – 590)
S12	E	0.0800	2.4	0.028	0.034	0.042	0.055	0.070	0.085	0.10	0.12	125 (110 – 140)
		0,0800	2,4	0,0011	0,0013	0,0017	0,0022	0,0028	0,0034	0,0040	0,0048	410 (370 – 450)
S13	E	0.0800	2.4	0.028	0.034	0.042	0.055	0.070	0.085	0.10	0.12	125 (110 – 140)
		0,0800	2,4	0,0011	0,0013	0,0017	0,0022	0,0028	0,0034	0,0040	0,0048	410 (370 – 450)
H8	M/A/D	0.0500	2.4	0.022	0.026	0.032	0.042	0.055	0.065	0.080	0.090	160 (140 – 180)
		0,0500	2,4	0,00085	0,0010	0,0013	0,0017	0,0022	0,0026	0,0032	0,0036	520 (460 – 590)
H21	M/A/D	0.0500	2.4	0.022	0.026	0.032	0.042	0.055	0.065	0.080	0.090	160 (140 – 180)
		0,0500	2,4	0,00085	0,0010	0,0013	0,0017	0,0022	0,0026	0,0032	0,0036	520 (460 – 590)
H31	M/A/D	0.0500	2.4	0.018	0.024	0.028	0.036	0.046	0.055	0.070	0.080	125 (110 – 140)
		0,0500	2,4	0,00070	0,00095	0,0011	0,0014	0,0018	0,0022	0,0028	0,0032	410 (370 – 450)

For cutting data recalculations, see pages 556 - 563

SMG = Seco material group
 Coolant = A=air D=dry E=emulsion M=mist spray
 v_c = m/min (sf/min)
 f_z = mm (in/tooth)
 a_p = mm/DC (in/DC) = factor
 a_e = mm/DC (in/DC) = factor
 All cutting data are target values

Universal
Steel and cast iron
Stainless steel and S-materials
Non ferrous
Hard
Plastic and cfrp
Graphite
X-Heads
Minimaster Plus
Minimaster

JS565

Advanced roughing – Universal – Square – 5 Flutes – Cylindrical – Chamfer

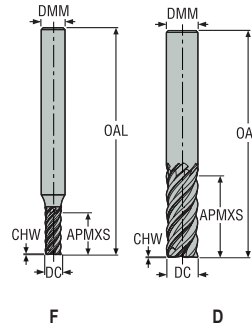

- Tolerances:
- DMM= h5
- DC= e7
- PCEDC5= no chip splitters
- PCEDC5C= with chip splitters
- Regrind possible if DC is ≥Ø8

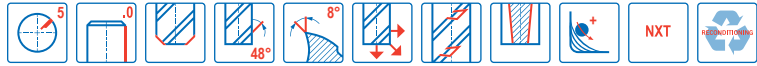

Designation	Item number	Length index	Tool shape	Chip splitters	DC	DMM	APMXS	OAL	CHW	PCEDC	Cylindrical
					mm	mm	mm	mm	mm		
JS565040F2C.0Z5-NXT	03067369	2	F	–	4,0	6,0	10,0	57,0	0,05	5	■
JS565040F2C.0Z5C-NXT	03067378	2	F	■	4,0	6,0	10,0	57,0	0,05	5	■
JS565050F2C.0Z5-NXT	03067370	2	F	–	5,0	6,0	12,5	57,0	0,06	5	■
JS565050F2C.0Z5C-NXT	03067379	2	F	■	5,0	6,0	12,5	57,0	0,06	5	■
JS565060D2C.0Z5-NXT	03067371	2	D	–	6,0	6,0	15,0	57,0	0,075	5	■
JS565060D2C.0Z5C-NXT	03067380	2	D	■	6,0	6,0	15,0	57,0	0,075	5	■
JS565080D2C.0Z5-NXT	03067372	2	D	–	8,0	8,0	20,0	63,0	0,1	5	■
JS565080D2C.0Z5C-NXT	03067381	2	D	■	8,0	8,0	20,0	63,0	0,1	5	■
JS565100D2C.0Z5-NXT	03067373	2	D	–	10,0	10,0	25,0	72,0	0,125	5	■
JS565100D2C.0Z5C-NXT	03067382	2	D	■	10,0	10,0	25,0	72,0	0,125	5	■
JS565120D2C.0Z5-NXT	03067374	2	D	–	12,0	12,0	30,0	83,0	0,15	5	■
JS565120D2C.0Z5C-NXT	03067383	2	D	■	12,0	12,0	30,0	83,0	0,15	5	■
JS565160D2C.0Z5-NXT	03067375	2	D	–	16,0	16,0	40,0	99,0	0,2	5	■
JS565160D2C.0Z5C-NXT	03067384	2	D	■	16,0	16,0	40,0	99,0	0,2	5	■
JS565200D2C.0Z5-NXT	03067376	2	D	–	20,0	20,0	50,0	114,0	0,25	5	■
JS565200D2C.0Z5C-NXT	03067385	2	D	■	20,0	20,0	50,0	114,0	0,25	5	■
JS565060D3C.0Z5C-NXT	03067386	3	D	■	6,0	6,0	23,0	64,0	0,075	5	■
JS565080D3C.0Z5C-NXT	03067387	3	D	■	8,0	8,0	32,0	74,0	0,1	5	■
JS565100D3C.0Z5C-NXT	03067388	3	D	■	10,0	10,0	40,0	88,0	0,125	5	■
JS565120D3C.0Z5C-NXT	03067389	3	D	■	12,0	12,0	45,0	99,0	0,15	5	■
JS565160D3C.0Z5C-NXT	03067390	3	D	■	16,0	16,0	55,0	114,0	0,2	5	■
JS565200D3C.0Z5C-NXT	03067391	3	D	■	20,0	20,0	65,0	126,0	0,25	5	■

■ Stocked standard.

Universal

Steel and cast iron

Stainless steel
and S-materials

Non ferrous

Hard

Plastic and CFRP

Graphite

X-Heads

Minimaster Plus

Minimaster

JS565

Advanced roughing – Universal – Square – 5 Flutes – Weldon – Chamfer

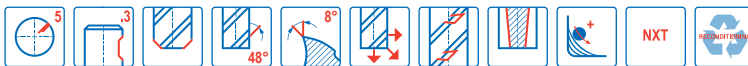
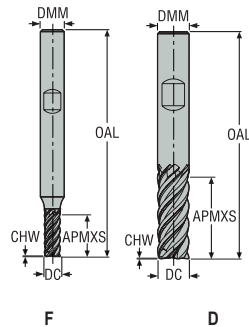

- Tolerances:
- DMM= h5
- DC= e7
- PCEDC5= no chip splitters
- PCEDC5C= with chip splitters
- Regrind possible if DC is ≥Ø8

Designation	Item number	Length index	Tool shape	Chip splitters	DC	DMM	APMXS	OAL	CHW	PCEDC	Weldon
					mm	mm	mm	mm	mm		
JS565040F2C.3Z5-NXT	03067393	2	F	–	4,0	6,0	10,0	57,0	0,05	5	■
JS565040F2C.3Z5C-NXT	03067402	2	F	■	4,0	6,0	10,0	57,0	0,05	5	■
JS565050F2C.3Z5-NXT	03067394	2	F	–	5,0	6,0	12,5	57,0	0,06	5	■
JS565050F2C.3Z5C-NXT	03067403	2	F	■	5,0	6,0	12,5	57,0	0,06	5	■
JS565060D2C.3Z5-NXT	03067395	2	D	–	6,0	6,0	15,0	57,0	0,075	5	■
JS565060D2C.3Z5C-NXT	03067404	2	D	■	6,0	6,0	15,0	57,0	0,075	5	■
JS565080D2C.3Z5-NXT	03067396	2	D	–	8,0	8,0	20,0	63,0	0,1	5	■
JS565080D2C.3Z5C-NXT	03067405	2	D	■	8,0	8,0	20,0	63,0	0,1	5	■
JS565100D2C.3Z5-NXT	03067397	2	D	–	10,0	10,0	25,0	72,0	0,125	5	■
JS565100D2C.3Z5C-NXT	03067406	2	D	■	10,0	10,0	25,0	72,0	0,125	5	■
JS565120D2C.3Z5-NXT	03067398	2	D	–	12,0	12,0	30,0	83,0	0,15	5	■
JS565120D2C.3Z5C-NXT	03067407	2	D	■	12,0	12,0	30,0	83,0	0,15	5	■
JS565160D2C.3Z5-NXT	03067399	2	D	–	16,0	16,0	40,0	99,0	0,2	5	■
JS565160D2C.3Z5C-NXT	03067408	2	D	■	16,0	16,0	40,0	99,0	0,2	5	■
JS565200D2C.3Z5-NXT	03067400	2	D	–	20,0	20,0	50,0	114,0	0,25	5	■
JS565200D2C.3Z5C-NXT	03067409	2	D	■	20,0	20,0	50,0	114,0	0,25	5	■
JS565060D3C.3Z5C-NXT	03067410	3	D	■	6,0	6,0	23,0	64,0	0,075	5	■
JS565080D3C.3Z5C-NXT	03067411	3	D	■	8,0	8,0	32,0	74,0	0,1	5	■
JS565100D3C.3Z5C-NXT	03067412	3	D	■	10,0	10,0	40,0	88,0	0,125	5	■
JS565120D3C.3Z5C-NXT	03067413	3	D	■	12,0	12,0	45,0	99,0	0,15	5	■
JS565160D3C.3Z5C-NXT	03067414	3	D	■	16,0	16,0	55,0	114,0	0,2	5	■
JS565200D3C.3Z5C-NXT	03067415	3	D	■	20,0	20,0	65,0	126,0	0,25	5	■

■ Stocked standard.

Universal

Steel and cast iron

Stainless steel and S-materials

Non ferrous

Hard

Plastic and CFRP

Graphite

X-Heads

Minimaster Plus

Minimaster

Cutting data – JS565 Side milling advanced roughing

SMG		a _e /DC	a _p /DC	f _z								v _c
				4	5	6	8	10	12	16	20	
P1	E/M/A/D	0.100	2.4	0.050	0.065	0.075	0.10	0.13	0.15	0.19	0.22	325 (270 – 340)
		0,100	2,4	0,0020	0,0026	0,0030	0,0040	0,0050	0,0060	0,0075	0,0085	1075 (890 – 1100)
P2	E/M/A/D	0.100	2.4	0.050	0.065	0.080	0.10	0.13	0.15	0.19	0.22	315 (260 – 330)
		0,100	2,4	0,0020	0,0026	0,0032	0,0040	0,0050	0,0060	0,0075	0,0085	1025 (860 – 1000)
P3	E/M/A/D	0.100	2.4	0.048	0.060	0.075	0.10	0.12	0.14	0.18	0.20	280 (230 – 290)
		0,100	2,4	0,0019	0,0024	0,0030	0,0040	0,0048	0,0055	0,0070	0,0080	920 (760 – 950)
P4	E/M/A/D	0.100	2.4	0.048	0.060	0.070	0.095	0.12	0.14	0.18	0.20	245 (200 – 250)
		0,100	2,4	0,0019	0,0024	0,0028	0,0038	0,0048	0,0055	0,0070	0,0080	800 (660 – 820)
P5	E/M/A/D	0.100	2.4	0.048	0.060	0.070	0.095	0.12	0.14	0.18	0.20	230 (190 – 240)
		0,100	2,4	0,0019	0,0024	0,0028	0,0038	0,0048	0,0055	0,0070	0,0080	750 (630 – 780)
P6	E/M/A/D	0.100	2.4	0.048	0.060	0.070	0.095	0.12	0.14	0.17	0.20	260 (210 – 270)
		0,100	2,4	0,0019	0,0024	0,0028	0,0038	0,0048	0,0055	0,0065	0,0080	850 (690 – 880)
P7	E/M/A/D	0.100	2.4	0.048	0.060	0.070	0.095	0.12	0.14	0.17	0.20	245 (200 – 250)
		0,100	2,4	0,0019	0,0024	0,0028	0,0038	0,0048	0,0055	0,0065	0,0080	800 (660 – 820)
P8	E/M/A/D	0.100	2.4	0.050	0.060	0.075	0.10	0.12	0.15	0.18	0.22	230 (190 – 240)
		0,100	2,4	0,0020	0,0024	0,0030	0,0040	0,0048	0,0060	0,0070	0,0085	750 (630 – 780)
P11	E/M/A/D	0.100	2.4	0.060	0.075	0.090	0.12	0.15	0.18	0.24	0.30	225 (190 – 230)
		0,100	2,4	0,0024	0,0030	0,0036	0,0048	0,0060	0,0070	0,0095	0,012	740 (630 – 750)
P12	E/M/A/D	0.100	2.4	0.048	0.060	0.070	0.095	0.12	0.14	0.18	0.20	140 (120 – 140)
		0,100	2,4	0,0019	0,0024	0,0028	0,0038	0,0048	0,0055	0,0070	0,0080	460 (400 – 450)
M1	E	0.100	2.4	0.055	0.065	0.080	0.11	0.13	0.16	0.19	0.22	205 (180 – 210)
		0,100	2,4	0,0022	0,0026	0,0032	0,0044	0,0050	0,0065	0,0075	0,0085	670 (600 – 680)
M2	E	0.100	2.4	0.048	0.060	0.070	0.095	0.12	0.14	0.18	0.20	170 (140 – 170)
		0,100	2,4	0,0019	0,0024	0,0028	0,0038	0,0048	0,0055	0,0070	0,0080	560 (460 – 550)
M3	E	0.100	2.4	0.040	0.050	0.060	0.080	0.10	0.12	0.15	0.17	130 (110 – 140)
		0,100	2,4	0,0016	0,0020	0,0024	0,0032	0,0040	0,0048	0,0060	0,0065	425 (370 – 450)
M4	E	0.100	2.4	0.040	0.050	0.060	0.080	0.10	0.12	0.15	0.17	130 (110 – 140)
		0,100	2,4	0,0016	0,0020	0,0024	0,0032	0,0040	0,0048	0,0060	0,0065	425 (370 – 450)
M5	E	0.100	2.4	0.040	0.050	0.060	0.080	0.10	0.12	0.15	0.17	110 (92 – 120)
		0,100	2,4	0,0016	0,0020	0,0024	0,0032	0,0040	0,0048	0,0060	0,0065	360 (310 – 390)
K1	E	0.100	2.4	0.055	0.065	0.080	0.11	0.13	0.16	0.19	0.22	275 (230 – 290)
		0,100	2,4	0,0022	0,0026	0,0032	0,0044	0,0050	0,0065	0,0075	0,0085	900 (760 – 950)
K2	E	0.100	2.4	0.048	0.060	0.070	0.095	0.12	0.14	0.18	0.20	245 (200 – 250)
		0,100	2,4	0,0019	0,0024	0,0028	0,0038	0,0048	0,0055	0,0070	0,0080	800 (660 – 820)
K3	E	0.100	2.4	0.048	0.060	0.070	0.095	0.12	0.14	0.18	0.20	205 (170 – 210)
		0,100	2,4	0,0019	0,0024	0,0028	0,0038	0,0048	0,0055	0,0070	0,0080	670 (560 – 680)
K4	E	0.100	2.4	0.048	0.060	0.070	0.095	0.12	0.14	0.18	0.20	200 (170 – 200)
		0,100	2,4	0,0019	0,0024	0,0028	0,0038	0,0048	0,0055	0,0070	0,0080	660 (560 – 650)
K5	E	0.100	2.4	0.044	0.055	0.065	0.085	0.11	0.13	0.16	0.18	120 (98 – 120)
		0,100	2,4	0,0017	0,0022	0,0026	0,0034	0,0044	0,0050	0,0065	0,0070	395 (330 – 390)
K6	E	0.100	2.4	0.048	0.060	0.070	0.095	0.12	0.14	0.18	0.20	175 (150 – 180)
		0,100	2,4	0,0019	0,0024	0,0028	0,0038	0,0048	0,0055	0,0070	0,0080	570 (500 – 590)
K7	E	0.100	2.4	0.044	0.055	0.065	0.085	0.11	0.13	0.16	0.18	155 (130 – 160)
		0,100	2,4	0,0017	0,0022	0,0026	0,0034	0,0044	0,0050	0,0065	0,0070	510 (430 – 520)

For cutting data recalculations, see pages 556 - 563

SMG = Seco material group
Coolant = A=air D=dry E=emulsion M=mist spray
v_c = m/min (sf/min)
f_z = mm (in/tooth)
a_p = mm/DC (in/DC) = factor
a_e = mm/DC (in/DC) = factor
All cutting data are target values

Cutting data – JS565 Side milling advanced roughing

SMG		a _p /DC	a _e /DC	f _z								v _c
				4	5	6	8	10	12	16	20	
N1	E	0.100	2.4	0.048	0.060	0.070	0.095	0.12	0.14	0.18	0.20	740 (600 – 790)
		0,100	2,4	0,0019	0,0024	0,0028	0,0038	0,0048	0,0055	0,0070	0,0080	2425 (2000 – 2500)
N2	E	0.100	2.4	0.048	0.060	0.070	0.095	0.12	0.14	0.18	0.20	475 (390 – 510)
		0,100	2,4	0,0019	0,0024	0,0028	0,0038	0,0048	0,0055	0,0070	0,0080	1550 (1300 – 1600)
N3	E	0.100	2.4	0.040	0.050	0.060	0.080	0.10	0.12	0.15	0.17	500 (400 – 590)
		0,100	2,4	0,0016	0,0020	0,0024	0,0032	0,0040	0,0048	0,0060	0,0065	1650 (1400 – 1900)
N11	E	0.100	2.4	0.048	0.060	0.070	0.095	0.12	0.14	0.18	0.20	370 (300 – 390)
		0,100	2,4	0,0019	0,0024	0,0028	0,0038	0,0048	0,0055	0,0070	0,0080	1225 (990 – 1200)
S1	E	0.0300	2.4	0.028	0.034	0.042	0.055	0.070	0.085	0.10	0.12	60 (38 – 86)
		0,0300	2,4	0,0011	0,0013	0,0017	0,0022	0,0028	0,0034	0,0040	0,0048	195 (130 – 280)
S2	E	0.0300	2.4	0.028	0.034	0.042	0.055	0.070	0.085	0.10	0.12	50 (30 – 70)
		0,0300	2,4	0,0011	0,0013	0,0017	0,0022	0,0028	0,0034	0,0040	0,0048	165 (99 – 220)
S3	E	0.0300	2.4	0.026	0.032	0.038	0.050	0.065	0.075	0.095	0.11	43 (27 – 60)
		0,0300	2,4	0,0010	0,0013	0,0015	0,0020	0,0026	0,0030	0,0038	0,0044	140 (89 – 190)
S11	E	0.0800	2.4	0.028	0.034	0.042	0.055	0.070	0.085	0.10	0.12	160 (140 – 180)
		0,0800	2,4	0,0011	0,0013	0,0017	0,0022	0,0028	0,0034	0,0040	0,0048	520 (460 – 590)
S12	E	0.0800	2.4	0.028	0.034	0.042	0.055	0.070	0.085	0.10	0.12	125 (110 – 140)
		0,0800	2,4	0,0011	0,0013	0,0017	0,0022	0,0028	0,0034	0,0040	0,0048	410 (370 – 450)
S13	E	0.0800	2.4	0.028	0.034	0.042	0.055	0.070	0.085	0.10	0.12	125 (110 – 140)
		0,0800	2,4	0,0011	0,0013	0,0017	0,0022	0,0028	0,0034	0,0040	0,0048	410 (370 – 450)
H8	M/A/D	0.0500	2.4	0.022	0.026	0.032	0.042	0.055	0.065	0.080	0.090	160 (140 – 180)
		0,0500	2,4	0,00085	0,0010	0,0013	0,0017	0,0022	0,0026	0,0032	0,0036	520 (460 – 590)
H21	M/A/D	0.0500	2.4	0.024	0.028	0.034	0.046	0.060	0.070	0.085	0.10	155 (140 – 180)
		0,0500	2,4	0,00095	0,0011	0,0013	0,0018	0,0024	0,0028	0,0034	0,0040	510 (460 – 590)
H31	M/A/D	0.0500	2.4	0.020	0.025	0.030	0.040	0.050	0.060	0.075	0.085	120 (110 – 140)
		0,0500	2,4	0,00080	0,0010	0,0012	0,0016	0,0020	0,0024	0,0030	0,0034	395 (370 – 450)

For cutting data recalculations, see pages 556 - 563

SMG = Seco material group
 Coolant = A=air D=dry E=emulsion M=mist spray
 v_c = m/min (sf/min)
 f_z = mm (in/tooth)
 a_p = mm/DC (in/DC) = factor
 a_e = mm/DC (in/DC) = factor
 All cutting data are target values

Universal
Steel and cast iron
Stainless steel and S-materials
Non ferrous
Hard
Plastic and cfrp
Graphite
X-Heads
Minimaster Plus
Minimaster

JS520

High performance – Universal – Square – 5-8 Flutes – Cylindrical – Chamfer

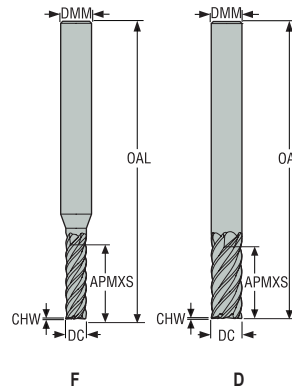

- Tolerances:
- DMM=h5
- DC=e7
- Regrind possible if DC is ≥06

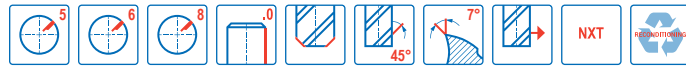

Designation	Item number	Length index	Tool shape	DC	DMM	APMXS	OAL	CHW	PCEDC	Cylindrical
				mm	mm	mm	mm	mm		
JS520040F2C.0Z5-NXT	02927474	2	F	4,0	6,0	10,0	57,0	0,04	5	■
JS520050F2C.0Z5-NXT	02927476	2	F	5,0	6,0	12,0	57,0	0,05	5	■
JS520060D2C.0Z5-NXT	02927478	2	D	6,0	6,0	15,0	57,0	0,06	5	■
JS520060D2C.0Z6-NXT	02927479	2	D	6,0	6,0	15,0	57,0	0,06	6	■
JS520080D2C.0Z5-NXT	02927482	2	D	8,0	8,0	20,0	63,0	0,08	5	■
JS520080D2C.0Z6-NXT	02927483	2	D	8,0	8,0	20,0	63,0	0,08	6	■
JS520100D2C.0Z6-NXT	02927486	2	D	10,0	10,0	25,0	72,0	0,1	6	■
JS520120D2C.0Z6-NXT	02927488	2	D	12,0	12,0	25,0	83,0	0,12	6	■
JS520140D2C.0Z6-NXT	02927490	2	D	14,0	14,0	30,0	83,0	0,14	6	■
JS520160D2C.0Z6-NXT	02927491	2	D	16,0	16,0	30,0	92,0	0,16	6	■
JS520160D2C.0Z8-NXT	02927492	2	D	16,0	16,0	30,0	92,0	0,16	8	■
JS520200D2C.0Z8-NXT	02927495	2	D	20,0	20,0	35,0	104,0	0,2	8	■
JS520250D2C.0Z8-NXT	02927497	2	D	25,0	25,0	50,0	125,0	0,25	8	■
JS520040F3C.0Z5-NXT	02927475	3	F	4,0	6,0	15,0	57,0	0,04	5	■
JS520050F3C.0Z5-NXT	02927477	3	F	5,0	6,0	19,0	57,0	0,05	5	■
JS520060D3C.0Z5-NXT	02927480	3	D	6,0	6,0	20,0	63,0	0,06	5	■
JS520060D3C.0Z6-NXT	02927481	3	D	6,0	6,0	20,0	63,0	0,06	6	■
JS520080D3C.0Z5-NXT	02927484	3	D	8,0	8,0	30,0	80,0	0,08	5	■
JS520080D3C.0Z6-NXT	02927485	3	D	8,0	8,0	30,0	80,0	0,08	6	■
JS520100D3C.0Z6-NXT	02927487	3	D	10,0	10,0	40,0	89,0	0,1	6	■
JS520120D3C.0Z6-NXT	02927489	3	D	12,0	12,0	45,0	100,0	0,12	6	■
JS520160D3C.0Z6-NXT	02927493	3	D	16,0	16,0	65,0	125,0	0,16	6	■
JS520160D3C.0Z8-NXT	02927494	3	D	16,0	16,0	65,0	125,0	0,16	8	■
JS520200D3C.0Z8-NXT	02927496	3	D	20,0	20,0	65,0	125,0	0,2	8	■
JS520250D3C.0Z8-NXT	02927498	3	D	25,0	25,0	75,0	150,0	0,25	8	■

■ Stocked standard.

Universal
Steel and cast iron
Stainless steel and S-materials
Non ferrous
Hard
Plastic and cfrp
Graphite
X-Heads
Minimaster Plus
Minimaster

JS520

High performance – Universal – Square – 5-8 Flutes – Weldon – Chamfer

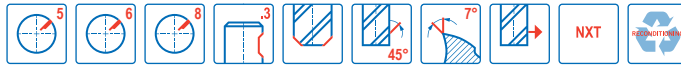
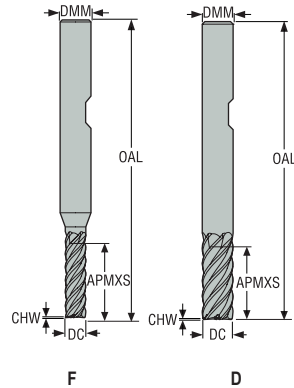

- Tolerances:
- DMM=h5
- DC=e7
- Regrind possible if DC is ≥Ø6

Designation	Item number	Length index	Tool shape	DC	DMM	APMXS	OAL	CHW	PCEDC	Weldon
				mm	mm	mm	mm	mm		
JS520040F2C.3Z5-NXT	02927499	2	F	4,0	6,0	10,0	57,0	0,04	5	<input type="checkbox"/>
JS520050F2C.3Z5-NXT	02927501	2	F	5,0	6,0	12,0	57,0	0,05	5	<input type="checkbox"/>
JS520060D2C.3Z5-NXT	02927503	2	D	6,0	6,0	15,0	57,0	0,06	5	<input type="checkbox"/>
JS520060D2C.3Z6-NXT	02927504	2	D	6,0	6,0	15,0	57,0	0,06	6	<input type="checkbox"/>
JS520080D2C.3Z5-NXT	02927507	2	D	8,0	8,0	20,0	63,0	0,08	5	<input type="checkbox"/>
JS520080D2C.3Z6-NXT	02927508	2	D	8,0	8,0	20,0	63,0	0,08	6	<input type="checkbox"/>
JS520100D2C.3Z6-NXT	02927511	2	D	10,0	10,0	25,0	72,0	0,1	6	<input type="checkbox"/>
JS520120D2C.3Z6-NXT	02927513	2	D	12,0	12,0	25,0	83,0	0,12	6	<input type="checkbox"/>
JS520140D2C.3Z6-NXT	02927515	2	D	14,0	14,0	30,0	83,0	0,14	6	<input type="checkbox"/>
JS520160D2C.3Z6-NXT	02927516	2	D	16,0	16,0	30,0	92,0	0,16	6	<input type="checkbox"/>
JS520160D2C.3Z8-NXT	02927517	2	D	16,0	16,0	30,0	92,0	0,16	8	<input checked="" type="checkbox"/>
JS520200D2C.3Z8-NXT	02927520	2	D	20,0	20,0	35,0	104,0	0,2	8	<input checked="" type="checkbox"/>
JS520250D2C.3Z8-NXT	02927522	2	D	25,0	25,0	50,0	125,0	0,25	8	<input type="checkbox"/>
JS520040F3C.3Z5-NXT	02927500	3	F	4,0	6,0	15,0	57,0	0,04	5	<input type="checkbox"/>
JS520050F3C.3Z5-NXT	02927502	3	F	5,0	6,0	19,0	57,0	0,05	5	<input type="checkbox"/>
JS520060D3C.3Z5-NXT	02927505	3	D	6,0	6,0	20,0	63,0	0,06	5	<input type="checkbox"/>
JS520060D3C.3Z6-NXT	02927506	3	D	6,0	6,0	20,0	63,0	0,06	6	<input type="checkbox"/>
JS520080D3C.3Z5-NXT	02927509	3	D	8,0	8,0	30,0	80,0	0,08	5	<input type="checkbox"/>
JS520080D3C.3Z6-NXT	02927510	3	D	8,0	8,0	30,0	80,0	0,08	6	<input type="checkbox"/>
JS520100D3C.3Z6-NXT	02927512	3	D	10,0	10,0	40,0	89,0	0,1	6	<input type="checkbox"/>
JS520120D3C.3Z6-NXT	02927514	3	D	12,0	12,0	45,0	100,0	0,12	6	<input type="checkbox"/>
JS520160D3C.3Z6-NXT	02927518	3	D	16,0	16,0	65,0	125,0	0,16	6	<input type="checkbox"/>
JS520160D3C.3Z8-NXT	02927519	3	D	16,0	16,0	65,0	125,0	0,16	8	<input type="checkbox"/>
JS520200D3C.3Z8-NXT	02927521	3	D	20,0	20,0	65,0	125,0	0,2	8	<input type="checkbox"/>
JS520250D3C.3Z8-NXT	02927523	3	D	25,0	25,0	75,0	150,0	0,25	8	<input type="checkbox"/>

■ Stocked standard. □ Weldon available. Delivery time is 3 days.

Universal

Steel and cast iron

Stainless steel and S-materials

Non ferrous

Hard

Plastic and CFRP

Graphite

X-Heads

Minimaster Plus

Minimaster

Cutting data – JS520 Side milling

SMG		a _e /DC	a _p /DC	f _z										v _c
				4	5	6	8	10	12	14	16	20	25	
P1	E/M/A	0.100	2.0	0.034	0.044	0.050	0.070	0.085	0.10	0.12	0.13	0.15	0.17	180 (120 – 250)
		0,100	2,0	0,0013	0,0017	0,0020	0,0028	0,0034	0,0040	0,0048	0,0050	0,0060	0,0065	590 (400 – 820)
P2	E/M/A	0.100	2.0	0.036	0.044	0.055	0.070	0.090	0.10	0.12	0.13	0.15	0.17	175 (110 – 240)
		0,100	2,0	0,0014	0,0017	0,0022	0,0028	0,0036	0,0040	0,0048	0,0050	0,0060	0,0065	570 (370 – 780)
P3	E/M/A	0.100	2.0	0.034	0.042	0.050	0.065	0.085	0.10	0.11	0.12	0.14	0.16	155 (95 – 210)
		0,100	2,0	0,0013	0,0017	0,0020	0,0026	0,0034	0,0040	0,0044	0,0048	0,0055	0,0065	510 (320 – 680)
P4	E/M/A	0.100	2.0	0.032	0.040	0.048	0.065	0.080	0.095	0.11	0.12	0.14	0.16	135 (84 – 180)
		0,100	2,0	0,0013	0,0016	0,0019	0,0026	0,0032	0,0038	0,0044	0,0048	0,0055	0,0065	445 (280 – 590)
P5	E/M/A	0.100	2.0	0.032	0.040	0.048	0.065	0.080	0.095	0.11	0.12	0.14	0.15	130 (81 – 180)
		0,100	2,0	0,0013	0,0016	0,0019	0,0026	0,0032	0,0038	0,0044	0,0048	0,0055	0,0060	425 (270 – 590)
P6	E/M/A	0.100	2.0	0.032	0.040	0.048	0.065	0.080	0.095	0.11	0.12	0.13	0.15	145 (90 – 200)
		0,100	2,0	0,0013	0,0016	0,0019	0,0026	0,0032	0,0038	0,0044	0,0048	0,0050	0,0060	475 (300 – 650)
P7	E/M/A	0.100	2.0	0.032	0.040	0.048	0.065	0.080	0.095	0.11	0.12	0.13	0.15	140 (85 – 190)
		0,100	2,0	0,0013	0,0016	0,0019	0,0026	0,0032	0,0038	0,0044	0,0048	0,0050	0,0060	460 (280 – 620)
P8	E/M/A	0.100	2.0	0.034	0.042	0.050	0.065	0.085	0.10	0.11	0.12	0.14	0.16	130 (80 – 170)
		0,100	2,0	0,0013	0,0017	0,0020	0,0026	0,0034	0,0040	0,0044	0,0048	0,0055	0,0065	425 (270 – 550)
P11	E/M/A	0.100	2.0	0.046	0.060	0.070	0.095	0.12	0.14	0.16	0.17	0.20	0.22	195 (160 – 230)
		0,100	2,0	0,0018	0,0024	0,0028	0,0038	0,0048	0,0055	0,0065	0,0065	0,0080	0,0085	640 (530 – 750)
P12	E/M/A	0.100	2.0	0.032	0.040	0.048	0.065	0.080	0.095	0.11	0.12	0.14	0.15	125 (100 – 140)
		0,100	2,0	0,0013	0,0016	0,0019	0,0026	0,0032	0,0038	0,0044	0,0048	0,0055	0,0060	410 (330 – 450)
M1	E/M/A	0.100	2.0	0.036	0.044	0.055	0.070	0.090	0.10	0.12	0.13	0.15	0.17	150 (130 – 180)
		0,100	2,0	0,0014	0,0017	0,0022	0,0028	0,0036	0,0040	0,0048	0,0050	0,0060	0,0065	490 (430 – 590)
M2	E/M/A	0.100	2.0	0.032	0.040	0.048	0.065	0.080	0.095	0.11	0.12	0.14	0.15	125 (100 – 150)
		0,100	2,0	0,0013	0,0016	0,0019	0,0026	0,0032	0,0038	0,0044	0,0048	0,0055	0,0060	410 (330 – 490)
M3	E/M/A	0.100	2.0	0.032	0.040	0.048	0.065	0.080	0.095	0.11	0.12	0.14	0.15	100 (75 – 120)
		0,100	2,0	0,0013	0,0016	0,0019	0,0026	0,0032	0,0038	0,0044	0,0048	0,0055	0,0060	330 (250 – 390)
M4	E/M/A	0.100	2.0	0.028	0.034	0.042	0.055	0.070	0.085	0.095	0.10	0.12	0.13	75 (58 – 96)
		0,100	2,0	0,0011	0,0013	0,0017	0,0022	0,0028	0,0034	0,0038	0,0040	0,0048	0,0050	245 (200 – 310)
M5	E/M/A	0.100	2.0	0.028	0.034	0.042	0.055	0.070	0.085	0.095	0.10	0.12	0.13	65 (49 – 80)
		0,100	2,0	0,0011	0,0013	0,0017	0,0022	0,0028	0,0034	0,0038	0,0040	0,0048	0,0050	215 (170 – 260)
K1	E/M/A	0.100	2.0	0.036	0.044	0.055	0.070	0.090	0.10	0.12	0.13	0.15	0.17	175 (110 – 240)
		0,100	2,0	0,0014	0,0017	0,0022	0,0028	0,0036	0,0040	0,0048	0,0050	0,0060	0,0065	570 (370 – 780)
K2	E/M/A	0.100	2.0	0.032	0.040	0.048	0.065	0.080	0.095	0.11	0.12	0.14	0.15	155 (97 – 210)
		0,100	2,0	0,0013	0,0016	0,0019	0,0026	0,0032	0,0038	0,0044	0,0048	0,0055	0,0060	510 (320 – 680)
K3	E/M/A	0.100	2.0	0.032	0.040	0.048	0.065	0.080	0.095	0.11	0.12	0.14	0.15	135 (82 – 180)
		0,100	2,0	0,0013	0,0016	0,0019	0,0026	0,0032	0,0038	0,0044	0,0048	0,0055	0,0060	445 (270 – 590)
K4	E/M/A	0.100	2.0	0.032	0.040	0.048	0.065	0.080	0.095	0.11	0.12	0.14	0.15	125 (79 – 170)
		0,100	2,0	0,0013	0,0016	0,0019	0,0026	0,0032	0,0038	0,0044	0,0048	0,0055	0,0060	410 (260 – 550)
K5	E/M/A	0.100	2.0	0.028	0.036	0.044	0.060	0.070	0.085	0.095	0.11	0.12	0.14	75 (48 – 100)
		0,100	2,0	0,0011	0,0014	0,0017	0,0024	0,0028	0,0034	0,0038	0,0044	0,0048	0,0055	245 (160 – 320)
K6	E/M/A	0.100	2.0	0.032	0.040	0.048	0.065	0.080	0.095	0.11	0.12	0.14	0.15	110 (69 – 150)
		0,100	2,0	0,0013	0,0016	0,0019	0,0026	0,0032	0,0038	0,0044	0,0048	0,0055	0,0060	360 (230 – 490)
K7	E/M/A	0.100	2.0	0.028	0.036	0.044	0.060	0.070	0.085	0.095	0.11	0.12	0.14	100 (62 – 130)
		0,100	2,0	0,0011	0,0014	0,0017	0,0024	0,0028	0,0034	0,0038	0,0044	0,0048	0,0055	330 (210 – 420)

For cutting data recalculations, see pages 556 - 563

SMG = Seco material group
 Coolant = A=air D=dry E=emulsion M=mist spray
 v_c = m/min (sf/min)
 f_z = mm (in/tooth)
 a_p = mm/DC (in/DC) = factor
 a_e = mm/DC (in/DC) = factor
 All cutting data are target values

Cutting data – JS520 Side milling

SMG		a _e /DC	a _p /DC	f _z										v _c
				4	5	6	8	10	12	14	16	20	25	
N1	E/M/A	0.100	2.0	0.032	0.040	0.048	0.065	0.080	0.095	0.11	0.12	0.14	0.15	500 (450 – 550)
		0,100	2,0	0,0013	0,0016	0,0019	0,0026	0,0032	0,0038	0,0044	0,0048	0,0055	0,0060	1650 (1500 – 1800)
N2	E/M/A	0.100	2.0	0.032	0.040	0.048	0.065	0.080	0.095	0.11	0.12	0.14	0.15	320 (290 – 350)
		0,100	2,0	0,0013	0,0016	0,0019	0,0026	0,0032	0,0038	0,0044	0,0048	0,0055	0,0060	1050 (960 – 1100)
N3	E/M/A	0.100	2.0	0.032	0.040	0.048	0.065	0.080	0.095	0.11	0.12	0.14	0.15	215 (200 – 230)
		0,100	2,0	0,0013	0,0016	0,0019	0,0026	0,0032	0,0038	0,0044	0,0048	0,0055	0,0060	710 (660 – 750)
N11	E/M/A	0.100	2.0	0.032	0.040	0.048	0.065	0.080	0.095	0.11	0.12	0.14	0.15	400 (350 – 450)
		0,100	2,0	0,0013	0,0016	0,0019	0,0026	0,0032	0,0038	0,0044	0,0048	0,0055	0,0060	1300 (1200 – 1400)
S1	E/M/A	0.0600	2.0	0.020	0.025	0.030	0.040	0.050	0.060	0.065	0.075	0.085	0.095	75 (63 – 86)
		0,0600	2,0	0,00080	0,0010	0,0012	0,0016	0,0020	0,0024	0,0026	0,0030	0,0034	0,0038	245 (210 – 280)
S2	E/M/A	0.0600	2.0	0.020	0.025	0.030	0.040	0.050	0.060	0.065	0.075	0.085	0.095	60 (50 – 70)
		0,0600	2,0	0,00080	0,0010	0,0012	0,0016	0,0020	0,0024	0,0026	0,0030	0,0034	0,0038	195 (170 – 220)
S3	E/M/A	0.0600	2.0	0.020	0.025	0.030	0.040	0.050	0.060	0.065	0.075	0.085	0.095	40 (30 – 49)
		0,0600	2,0	0,00080	0,0010	0,0012	0,0016	0,0020	0,0024	0,0026	0,0030	0,0034	0,0038	130 (99 – 160)
S11	E/M/A	0.100	2.0	0.032	0.040	0.048	0.065	0.080	0.095	0.11	0.12	0.14	0.15	105 (92 – 110)
		0,100	2,0	0,0013	0,0016	0,0019	0,0026	0,0032	0,0038	0,0044	0,0048	0,0055	0,0060	345 (310 – 360)
S12	E/M/A	0.100	2.0	0.032	0.040	0.048	0.065	0.080	0.095	0.11	0.12	0.14	0.15	80 (71 – 90)
		0,100	2,0	0,0013	0,0016	0,0019	0,0026	0,0032	0,0038	0,0044	0,0048	0,0055	0,0060	260 (240 – 290)
S13	E/M/A	0.100	2.0	0.028	0.034	0.042	0.055	0.070	0.085	0.095	0.10	0.12	0.13	65 (56 – 71)
		0,100	2,0	0,0011	0,0013	0,0017	0,0022	0,0028	0,0034	0,0038	0,0040	0,0048	0,0050	215 (190 – 230)
H5	M/A	0.0600	2.0	0.030	0.038	0.046	0.060	0.075	0.090	0.10	0.11	0.13	0.14	125 (64 – 180)
		0,0600	2,0	0,0012	0,0015	0,0018	0,0024	0,0030	0,0036	0,0040	0,0044	0,0050	0,0055	410 (210 – 590)
H8	M/A	0.0600	2.0	0.024	0.028	0.034	0.046	0.060	0.070	0.075	0.085	0.10	0.11	130 (66 – 190)
		0,0600	2,0	0,00095	0,0011	0,0013	0,0018	0,0024	0,0028	0,0030	0,0034	0,0040	0,0044	425 (220 – 620)
H11	M/A	0.0600	2.0	0.030	0.038	0.046	0.060	0.075	0.090	0.10	0.11	0.13	0.14	160 (81 – 240)
		0,0600	2,0	0,0012	0,0015	0,0018	0,0024	0,0030	0,0036	0,0040	0,0044	0,0050	0,0055	520 (270 – 780)
H12	M/A	0.0600	2.0	0.024	0.028	0.034	0.046	0.060	0.070	0.075	0.085	0.10	0.11	150 (76 – 220)
		0,0600	2,0	0,00095	0,0011	0,0013	0,0018	0,0024	0,0028	0,0030	0,0034	0,0040	0,0044	490 (250 – 720)
H21	M/A	0.0600	2.0	0.024	0.028	0.034	0.046	0.060	0.070	0.075	0.085	0.10	0.11	130 (66 – 190)
		0,0600	2,0	0,00095	0,0011	0,0013	0,0018	0,0024	0,0028	0,0030	0,0034	0,0040	0,0044	425 (220 – 620)
H31	M/A	0.0600	2.0	0.020	0.025	0.030	0.040	0.050	0.060	0.065	0.075	0.085	0.095	100 (51 – 150)
		0,0600	2,0	0,00080	0,0010	0,0012	0,0016	0,0020	0,0024	0,0026	0,0030	0,0034	0,0038	330 (170 – 490)
TS1	A/D	0.100	2.0	0.032	0.040	0.048	0.065	0.080	0.095	0.11	0.12	0.14	0.15	500 (450 – 550)
		0,100	2,0	0,0013	0,0016	0,0019	0,0026	0,0032	0,0038	0,0044	0,0048	0,0055	0,0060	1650 (1500 – 1800)
TP1	A/D	0.100	2.0	0.032	0.040	0.048	0.065	0.080	0.095	0.11	0.12	0.14	0.15	395 (350 – 440)
		0,100	2,0	0,0013	0,0016	0,0019	0,0026	0,0032	0,0038	0,0044	0,0048	0,0055	0,0060	1300 (1200 – 1400)
GR1	A/D	0.100	2.0	0.032	0.040	0.048	0.065	0.080	0.095	0.11	0.12	0.14	0.15	500 (450 – 550)
		0,100	2,0	0,0013	0,0016	0,0019	0,0026	0,0032	0,0038	0,0044	0,0048	0,0055	0,0060	1650 (1500 – 1800)

For cutting data recalculations, see pages 556 - 563

SMG = Seco material group

Coolant = A=air D=dry E=emulsion M=mist spray

v_c = m/min (sf/min)

f_z = mm (in/tooth)

a_p = mm/DC (in/DC) = factor

a_e = mm/DC (in/DC) = factor

All cutting data are target values

Universal
Steel and cast iron
Stainless steel and S-materials
Non ferrous
Hard
Plastic and CFRP
Graphite
X-Heads
Minimaster Plus
Minimaster

JS522

High performance – Universal – Square – 2 Flutes – High shoulder – Cylindrical – Corner radius

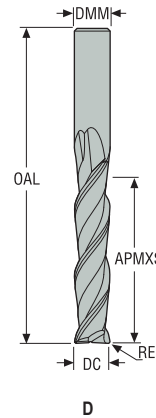

- Tolerances:
- Run-out= Ø6-Ø8 <0,01, Ø10-Ø12 <0,015, Ø16-Ø32 <0,02
- DMM= h5
- DC= -0,02/-0,04 mm
- RE= 0,1+0,1 mm, RE= 0,5 ±0,03 mm
RE= 3,1 ±0,05 mm, RE= 4 ±0,05 mm
RE= 6 ±0,05 mm

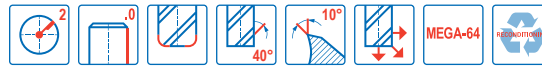

Designation	Item number	Length index	Tool shape	DC	DMM	APMXS	OAL	RE	PCEDC	Cylindrical
				mm	mm	mm	mm	mm		
522060R010Z2.0-MEGA-64	02747756	4	D	6,0	6,0	30,0	80,0	0,1	2	■
522080R010Z2.0-MEGA-64	02747763	4	D	8,0	8,0	40,0	85,0	0,1	2	■
522100R010Z2.0-MEGA-64	02747765	4	D	10,0	10,0	50,0	100,0	0,1	2	■
522120R010Z2.0-MEGA-64	02747766	4	D	12,0	12,0	60,0	115,0	0,1	2	■
522160R050Z2.0-MEGA-64	02747767	4	D	16,0	16,0	80,0	150,0	0,5	2	■
522160R310Z2.0-MEGA-64	02747768	4	D	16,0	16,0	80,0	150,0	3,1	2	■
JS522160D4R600.0Z2-M64	03093681	4	D	16,0	16,0	80,0	150,0	6,0	2	■
522200R050Z2.0-MEGA-64	02747769	4	D	20,0	20,0	100,0	175,0	0,5	2	■
522200R310Z2.0-MEGA-64	02747770	4	D	20,0	20,0	100,0	175,0	3,1	2	■
JS522200D4R600.0Z2-M64	03093682	4	D	20,0	20,0	100,0	175,0	6,0	2	■
522250R050Z2.0-MEGA-64	02747771	4	D	25,0	25,0	125,0	205,0	0,5	2	■
522250R310Z2.0-MEGA-64	02747772	4	D	25,0	25,0	125,0	205,0	3,1	2	■
522250R400Z2.0-MEGA-64	02747773	4	D	25,0	25,0	125,0	205,0	4,0	2	■
JS522250D4R600.0Z2-M64	03093683	4	D	25,0	25,0	125,0	205,0	6,0	2	■
522320R050Z2.0-MEGA-64	02747774	4	D	32,0	32,0	160,0	245,0	0,5	2	■
522320R400Z2.0-MEGA-64	02747775	4	D	32,0	32,0	160,0	245,0	4,0	2	■
JS522320D4R600.0Z2-M64	03093684	4	D	32,0	32,0	160,0	245,0	6,0	2	■

■ Stocked standard.

*JS522 long flute finisher, with its special geometry designed to machine high shoulders with excellent surface finish and perpendicularity.

Universal

Steel and cast iron

Stainless steel and S-materials

Non ferrous

Hard

Plastic and CFRP

Graphite

X-Heads

Minimaster Plus

Minimaster

Cutting data – JS522 Side milling semi finishing

SMG		a _e /DC	a _p /DC	f _z								v _c
				6	8	10	12	16	20	25	32	
P1	E/M/A	0.0500	4.0	0.046	0.060	0.075	0.090	0.11	0.13	0.14	0.16	160 (140 – 170)
		0,0500	4,0	0,0018	0,0024	0,0030	0,0036	0,0044	0,0050	0,0055	0,0065	520 (460 – 550)
P2	E/M/A	0.0500	4.0	0.046	0.060	0.075	0.090	0.11	0.13	0.15	0.17	155 (140 – 170)
		0,0500	4,0	0,0018	0,0024	0,0030	0,0036	0,0044	0,0050	0,0060	0,0065	510 (460 – 550)
P3	E/M/A	0.0500	4.0	0.044	0.060	0.075	0.085	0.11	0.12	0.14	0.16	165 (150 – 180)
		0,0500	4,0	0,0017	0,0024	0,0030	0,0034	0,0044	0,0048	0,0055	0,0065	540 (500 – 590)
P4	E/M/A	0.0500	4.0	0.042	0.055	0.070	0.085	0.10	0.12	0.14	0.15	145 (130 – 160)
		0,0500	4,0	0,0017	0,0022	0,0028	0,0034	0,0040	0,0048	0,0055	0,0060	475 (430 – 520)
P5	E/M/A	0.0500	4.0	0.042	0.055	0.070	0.085	0.10	0.12	0.13	0.15	140 (130 – 160)
		0,0500	4,0	0,0017	0,0022	0,0028	0,0034	0,0040	0,0048	0,0050	0,0060	460 (430 – 520)
P6	E/M/A	0.0500	4.0	0.042	0.055	0.070	0.080	0.10	0.12	0.13	0.15	120 (110 – 140)
		0,0500	4,0	0,0017	0,0022	0,0028	0,0032	0,0040	0,0048	0,0050	0,0060	395 (370 – 450)
P7	E/M/A	0.0500	4.0	0.042	0.055	0.070	0.080	0.10	0.12	0.13	0.15	115 (95 – 130)
		0,0500	4,0	0,0017	0,0022	0,0028	0,0032	0,0040	0,0048	0,0050	0,0060	375 (320 – 420)
P8	E/M/A	0.0500	4.0	0.044	0.060	0.075	0.085	0.11	0.12	0.14	0.16	105 (89 – 120)
		0,0500	4,0	0,0017	0,0024	0,0030	0,0034	0,0044	0,0048	0,0055	0,0065	345 (300 – 390)
P11	E/M/A	0.0500	4.0	0.060	0.080	0.10	0.12	0.15	0.17	0.20	0.22	105 (87 – 120)
		0,0500	4,0	0,0024	0,0032	0,0040	0,0048	0,0060	0,0065	0,0080	0,0085	345 (290 – 390)
P12	E/M/A	0.0500	4.0	0.042	0.055	0.070	0.085	0.10	0.12	0.13	0.15	65 (55 – 75)
		0,0500	4,0	0,0017	0,0022	0,0028	0,0034	0,0040	0,0048	0,0050	0,0060	215 (190 – 240)
M1	E/M/A	0.0500	4.0	0.046	0.060	0.075	0.090	0.11	0.13	0.15	0.17	110 (86 – 130)
		0,0500	4,0	0,0018	0,0024	0,0030	0,0036	0,0044	0,0050	0,0060	0,0065	360 (290 – 420)
M2	E/M/A	0.0500	4.0	0.042	0.055	0.070	0.085	0.10	0.12	0.13	0.15	90 (71 – 110)
		0,0500	4,0	0,0017	0,0022	0,0028	0,0034	0,0040	0,0048	0,0050	0,0060	295 (240 – 360)
M3	E/M/A	0.0500	4.0	0.042	0.055	0.070	0.085	0.10	0.12	0.13	0.15	80 (61 – 100)
		0,0500	4,0	0,0017	0,0022	0,0028	0,0034	0,0040	0,0048	0,0050	0,0060	260 (210 – 320)
M4	E/M/A	0.0500	4.0	0.036	0.048	0.060	0.070	0.090	0.10	0.12	0.13	60 (47 – 76)
		0,0500	4,0	0,0014	0,0019	0,0024	0,0028	0,0036	0,0040	0,0048	0,0050	195 (160 – 240)
M5	E/M/A	0.0500	4.0	0.036	0.048	0.060	0.070	0.090	0.10	0.12	0.13	50 (39 – 63)
		0,0500	4,0	0,0014	0,0019	0,0024	0,0028	0,0036	0,0040	0,0048	0,0050	165 (130 – 200)
K1	E/M/A	0.0500	4.0	0.046	0.060	0.075	0.090	0.11	0.13	0.15	0.17	120 (100 – 130)
		0,0500	4,0	0,0018	0,0024	0,0030	0,0036	0,0044	0,0050	0,0060	0,0065	395 (330 – 420)
K2	E/M/A	0.0500	4.0	0.042	0.055	0.070	0.085	0.10	0.12	0.13	0.15	105 (87 – 120)
		0,0500	4,0	0,0017	0,0022	0,0028	0,0034	0,0040	0,0048	0,0050	0,0060	345 (290 – 390)
K3	E/M/A	0.0500	4.0	0.042	0.055	0.070	0.085	0.10	0.12	0.13	0.15	90 (74 – 100)
		0,0500	4,0	0,0017	0,0022	0,0028	0,0034	0,0040	0,0048	0,0050	0,0060	295 (250 – 320)
K4	E/M/A	0.0500	4.0	0.042	0.055	0.070	0.085	0.10	0.12	0.13	0.15	85 (71 – 98)
		0,0500	4,0	0,0017	0,0022	0,0028	0,0034	0,0040	0,0048	0,0050	0,0060	280 (240 – 320)
K5	E/M/A	0.0500	4.0	0.038	0.050	0.065	0.075	0.090	0.11	0.12	0.14	100 (81 – 120)
		0,0500	4,0	0,0015	0,0020	0,0026	0,0030	0,0036	0,0044	0,0048	0,0055	330 (270 – 390)
K6	E/M/A	0.0500	4.0	0.042	0.055	0.070	0.085	0.10	0.12	0.13	0.15	150 (120 – 170)
		0,0500	4,0	0,0017	0,0022	0,0028	0,0034	0,0040	0,0048	0,0050	0,0060	490 (400 – 550)
K7	E/M/A	0.0500	4.0	0.038	0.050	0.065	0.075	0.090	0.11	0.12	0.14	130 (110 – 150)
		0,0500	4,0	0,0015	0,0020	0,0026	0,0030	0,0036	0,0044	0,0048	0,0055	425 (370 – 490)

For cutting data recalculations, see pages 556 - 563

SMG = Seco material group
 Coolant = A=air D=dry E=emulsion M=mist spray
 v_c = m/min (sf/min)
 f_z = mm (in/tooth)
 a_p = mm/DC (in/DC) = factor
 a_e = mm/DC (in/DC) = factor
 All cutting data are target values

Universal
Steel and cast iron
Stainless steel and S-materials
Non ferrous
Hard
Plastic and CFRP
Graphite
X-Heads
Minimaster Plus
Minimaster

Cutting data – JS522 Side milling semi finishing

Universal	SMG	Coolant	a _e /DC	a _p /DC	f _z							v _c	
					6	8	10	12	16	20	25		32
Steel and cast iron	N1	E/M/A	0.0500	4.0	0.042	0.055	0.070	0.085	0.10	0.12	0.13	0.15	400 (310 – 500)
			0,0500	4,0	0,0017	0,0022	0,0028	0,0034	0,0040	0,0048	0,0050	0,0060	1300 (1100 – 1600)
	N2	E/M/A	0.0500	4.0	0.042	0.055	0.070	0.085	0.10	0.12	0.13	0.15	300 (210 – 400)
			0,0500	4,0	0,0017	0,0022	0,0028	0,0034	0,0040	0,0048	0,0050	0,0060	980 (690 – 1300)
Stainless steel and S-materials	N3	E/M/A	0.0500	4.0	0.042	0.055	0.070	0.085	0.10	0.12	0.13	0.15	200 (140 – 260)
			0,0500	4,0	0,0017	0,0022	0,0028	0,0034	0,0040	0,0048	0,0050	0,0060	660 (460 – 850)
	N11	E/M/A	0.0500	4.0	0.042	0.055	0.070	0.085	0.10	0.12	0.13	0.15	300 (260 – 350)
			0,0500	4,0	0,0017	0,0022	0,0028	0,0034	0,0040	0,0048	0,0050	0,0060	980 (860 – 1100)
Non ferrous	S1	E/M/A	0.0500	4.0	0.018	0.024	0.030	0.036	0.044	0.050	0.055	0.065	48 (39 – 57)
			0,0500	4,0	0,00070	0,00095	0,0012	0,0014	0,0017	0,0020	0,0022	0,0026	155 (130 – 180)
	S2	E/M/A	0.0500	4.0	0.018	0.024	0.030	0.036	0.044	0.050	0.055	0.065	39 (31 – 46)
			0,0500	4,0	0,00070	0,00095	0,0012	0,0014	0,0017	0,0020	0,0022	0,0026	130 (110 – 150)
Hard	S3	E/M/A	0.0300	4.0	0.018	0.024	0.030	0.036	0.044	0.050	0.055	0.065	42 (32 – 51)
			0,0300	4,0	0,00070	0,00095	0,0012	0,0014	0,0017	0,0020	0,0022	0,0026	140 (110 – 160)
	S11	E/M/A	0.0500	4.0	0.042	0.055	0.070	0.085	0.10	0.12	0.13	0.15	125 (100 – 140)
			0,0500	4,0	0,0017	0,0022	0,0028	0,0034	0,0040	0,0048	0,0050	0,0060	410 (330 – 450)
Minimaster Plus	S12	E/M/A	0.0500	4.0	0.042	0.055	0.070	0.085	0.10	0.12	0.13	0.15	95 (77 – 110)
			0,0500	4,0	0,0017	0,0022	0,0028	0,0034	0,0040	0,0048	0,0050	0,0060	310 (260 – 360)
	S13	E/M/A	0.0500	4.0	0.036	0.048	0.060	0.070	0.090	0.10	0.12	0.13	75 (61 – 90)
			0,0500	4,0	0,0014	0,0019	0,0024	0,0028	0,0036	0,0040	0,0048	0,0050	245 (210 – 290)
Minimaster	TS1	A/D	0.0500	4.0	0.042	0.055	0.070	0.085	0.10	0.12	0.13	0.15	500 (410 – 600)
			0,0500	4,0	0,0017	0,0022	0,0028	0,0034	0,0040	0,0048	0,0050	0,0060	1650 (1400 – 1900)
	TP1	A/D	0.0500	4.0	0.042	0.055	0.070	0.085	0.10	0.12	0.13	0.15	400 (310 – 500)
0,0500			4,0	0,0017	0,0022	0,0028	0,0034	0,0040	0,0048	0,0050	0,0060	1300 (1100 – 1600)	
Minimaster Plus	GR1	A/D	0.0500	4.0	0.042	0.055	0.070	0.085	0.10	0.12	0.13	0.15	500 (410 – 600)
			0,0500	4,0	0,0017	0,0022	0,0028	0,0034	0,0040	0,0048	0,0050	0,0060	1650 (1400 – 1900)

For cutting data recalculations, see pages 556 - 563

SMG = Seco material group
Coolant = A=air D=dry E=emulsion M=mist spray
v_c = m/min (sf/min)
f_z = mm (in/tooth)
a_p = mm/DC (in/DC) = factor
a_e = mm/DC (in/DC) = factor
All cutting data are target values

JSB512

General purpose – Universal – Ball nose – 2 Flutes – Cylindrical

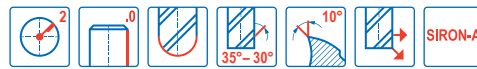
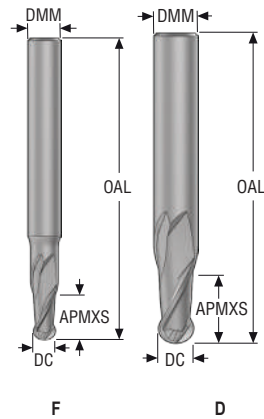

- Tolerances:
- DMM=h5
- DC=e8
- RE= ±0,01 mm

Designation	Grade	Item number	Length index	Tool shape	DC	DMM	APMXS	OAL	PCEDC	Cylindrical
					mm	mm	mm	mm		
JSB512020F2B.0Z2	SIRA	10053561	2	F	2,0	3,0	3,0	40,0	2	■
JSB512030D2B.0Z2	SIRA	10053562	2	D	3,0	3,0	5,0	40,0	2	■
JSB512040D2B.0Z2	SIRA	10053563	2	D	4,0	4,0	6,0	50,0	2	■
JSB512050F2B.0Z2	SIRA	10053564	2	F	5,0	6,0	8,0	57,0	2	■
JSB512060D2B.0Z2	SIRA	10053565	2	D	6,0	6,0	9,0	57,0	2	■
JSB512080D2B.0Z2	SIRA	10053566	2	D	8,0	8,0	12,0	63,0	2	■
JSB512100D2B.0Z2	SIRA	10053567	2	D	10,0	10,0	15,0	72,0	2	■
JSB512120D2B.0Z2	SIRA	10053568	2	D	12,0	12,0	18,0	83,0	2	■

■ Stocked standard.

Universal

Steel and cast iron

Stainless steel and S-materials

Non ferrous

Hard

Plastic and cfrp

Graphite

X-Heads

Minimaster Plus

Minimaster

Cutting data – JSB512 Copy milling roughing

SMG	Coolant	a _e /DC	a _p /DC	f _z								v _c
				2	3	4	5	6	8	10	12	
P1	M/A/D/E	0.150	1.2	0.010	0.015	0.020	0.025	0.030	0.042	0.050	0.060	150 (63 – 180)
		0,150	1,2	0,00040	0,00060	0,00080	0,0010	0,0012	0,0017	0,0020	0,0024	490 (210 – 590)
P2	M/A/D/E	0.150	1.2	0.010	0.016	0.020	0.026	0.032	0.042	0.050	0.060	150 (63 – 180)
		0,150	1,2	0,00040	0,00065	0,00080	0,0010	0,0013	0,0017	0,0020	0,0024	490 (210 – 590)
P3	M/A/D/E	0.150	1.2	0.010	0.016	0.020	0.026	0.032	0.042	0.050	0.060	150 (63 – 180)
		0,150	1,2	0,00040	0,00065	0,00080	0,0010	0,0013	0,0017	0,0020	0,0024	490 (210 – 590)
P4	M/A/D/E	0.150	1.2	0.010	0.016	0.020	0.026	0.032	0.042	0.050	0.060	150 (63 – 180)
		0,150	1,2	0,00040	0,00065	0,00080	0,0010	0,0013	0,0017	0,0020	0,0024	490 (210 – 590)
P5	M/A/D/E	0.150	1.2	0.010	0.016	0.020	0.026	0.032	0.042	0.050	0.060	150 (63 – 180)
		0,150	1,2	0,00040	0,00065	0,00080	0,0010	0,0013	0,0017	0,0020	0,0024	490 (210 – 590)
P6	M/A/D/E	0.150	1.2	0.010	0.016	0.020	0.026	0.032	0.042	0.050	0.060	150 (63 – 180)
		0,150	1,2	0,00040	0,00065	0,00080	0,0010	0,0013	0,0017	0,0020	0,0024	490 (210 – 590)
P7	M/A/D/E	0.150	1.2	0.010	0.016	0.020	0.026	0.032	0.042	0.050	0.060	150 (63 – 180)
		0,150	1,2	0,00040	0,00065	0,00080	0,0010	0,0013	0,0017	0,0020	0,0024	490 (210 – 590)
P8	M/A/D/E	0.150	1.2	0.010	0.016	0.020	0.026	0.032	0.042	0.050	0.060	150 (63 – 180)
		0,150	1,2	0,00040	0,00065	0,00080	0,0010	0,0013	0,0017	0,0020	0,0024	490 (210 – 590)
P11	M/A/D/E	0.150	1.2	0.010	0.016	0.020	0.026	0.032	0.042	0.050	0.060	90 (63 – 120)
		0,150	1,2	0,00040	0,00065	0,00080	0,0010	0,0013	0,0017	0,0020	0,0024	295 (210 – 390)
P12	M/A/D/E	0.150	1.2	0.010	0.016	0.020	0.026	0.032	0.042	0.050	0.060	90 (63 – 120)
		0,150	1,2	0,00040	0,00065	0,00080	0,0010	0,0013	0,0017	0,0020	0,0024	295 (210 – 390)
M1	E/M/A	0.150	1.2	0.010	0.016	0.020	0.026	0.032	0.042	0.050	0.060	90 (63 – 120)
		0,150	1,2	0,00040	0,00065	0,00080	0,0010	0,0013	0,0017	0,0020	0,0024	295 (210 – 390)
M2	E/M/A	0.150	1.2	0.010	0.016	0.020	0.026	0.032	0.042	0.050	0.060	90 (63 – 120)
		0,150	1,2	0,00040	0,00065	0,00080	0,0010	0,0013	0,0017	0,0020	0,0024	295 (210 – 390)
M3	E/M/A	0.150	1.2	0.010	0.016	0.020	0.026	0.032	0.042	0.050	0.060	90 (63 – 120)
		0,150	1,2	0,00040	0,00065	0,00080	0,0010	0,0013	0,0017	0,0020	0,0024	295 (210 – 390)
M4	E/M/A	0.150	1.2	0.010	0.016	0.020	0.026	0.032	0.042	0.050	0.060	90 (63 – 120)
		0,150	1,2	0,00040	0,00065	0,00080	0,0010	0,0013	0,0017	0,0020	0,0024	295 (210 – 390)
M5	E/M/A	0.150	1.2	0.010	0.016	0.020	0.026	0.032	0.042	0.050	0.060	90 (63 – 120)
		0,150	1,2	0,00040	0,00065	0,00080	0,0010	0,0013	0,0017	0,0020	0,0024	295 (210 – 390)
K1	A/D/M/E	0.150	1.2	0.010	0.016	0.020	0.026	0.032	0.042	0.050	0.060	150 (63 – 180)
		0,150	1,2	0,00040	0,00065	0,00080	0,0010	0,0013	0,0017	0,0020	0,0024	490 (210 – 590)
K2	A/D/M/E	0.150	1.2	0.010	0.016	0.020	0.026	0.032	0.042	0.050	0.060	150 (63 – 180)
		0,150	1,2	0,00040	0,00065	0,00080	0,0010	0,0013	0,0017	0,0020	0,0024	490 (210 – 590)
K3	A/D/M/E	0.150	1.2	0.010	0.016	0.020	0.026	0.032	0.042	0.050	0.060	150 (63 – 180)
		0,150	1,2	0,00040	0,00065	0,00080	0,0010	0,0013	0,0017	0,0020	0,0024	490 (210 – 590)
K4	A/D/M/E	0.150	1.2	0.010	0.016	0.020	0.026	0.032	0.042	0.050	0.060	150 (63 – 180)
		0,150	1,2	0,00040	0,00065	0,00080	0,0010	0,0013	0,0017	0,0020	0,0024	490 (210 – 590)
K5	A/D/M/E	0.150	1.2	0.012	0.018	0.025	0.030	0.036	0.050	0.060	0.070	145 (61 – 180)
		0,150	1,2	0,00048	0,00070	0,0010	0,0012	0,0014	0,0020	0,0024	0,0028	475 (210 – 590)
K6	A/D/M/E	0.150	1.2	0.010	0.016	0.020	0.026	0.032	0.042	0.050	0.060	150 (63 – 180)
		0,150	1,2	0,00040	0,00065	0,00080	0,0010	0,0013	0,0017	0,0020	0,0024	490 (210 – 590)
K7	A/D/M/E	0.150	1.2	0.010	0.016	0.020	0.026	0.032	0.042	0.050	0.060	150 (63 – 180)
		0,150	1,2	0,00040	0,00065	0,00080	0,0010	0,0013	0,0017	0,0020	0,0024	490 (210 – 590)
N1	E/M/A	0.150	1.2	0.010	0.015	0.020	0.025	0.030	0.042	0.050	0.060	500 (380 – 620)
		0,150	1,2	0,00040	0,00060	0,00080	0,0010	0,0012	0,0017	0,0020	0,0024	1650 (1300 – 2000)
N11	E/M/A	0.150	1.2	0.010	0.015	0.020	0.025	0.030	0.042	0.050	0.060	375 (260 – 500)
		0,150	1,2	0,00040	0,00060	0,00080	0,0010	0,0012	0,0017	0,0020	0,0024	1225 (860 – 1600)
S11	E	0.150	1.2	0.010	0.016	0.020	0.026	0.032	0.042	0.050	0.060	90 (66 – 130)
		0,150	1,2	0,00040	0,00065	0,00080	0,0010	0,0013	0,0017	0,0020	0,0024	295 (220 – 420)
S12	E	0.150	1.2	0.010	0.016	0.020	0.026	0.032	0.042	0.050	0.060	90 (63 – 120)
		0,150	1,2	0,00040	0,00065	0,00080	0,0010	0,0013	0,0017	0,0020	0,0024	295 (210 – 390)
S13	E	0.150	1.2	0.010	0.016	0.020	0.026	0.032	0.042	0.050	0.060	90 (63 – 120)
		0,150	1,2	0,00040	0,00065	0,00080	0,0010	0,0013	0,0017	0,0020	0,0024	295 (210 – 390)

For cutting data recalculations, see pages 556 - 563

SMG = Seco material group
Coolant = A=air D=dry E=emulsion M=mist spray
v_c = m/min (sf/min)
f_z = mm (in/tooth)
a_p = mm/DC (in/DC) = factor
a_e = mm/DC (in/DC) = factor
All cutting data are target values

JS532

High performance – Universal – Ball nose – 2 Flutes – Cylindrical

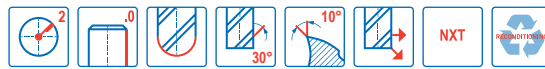
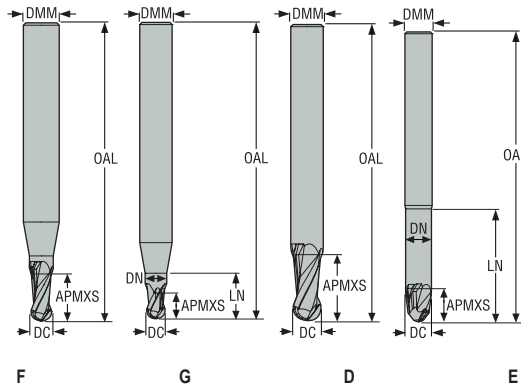

- Tolerances:
- DMM=h5
- DC=e8
- RE= ±0,01 mm
- Regrind possible if DC is ≥Ø6

Designation	Item number	Length index	Tool shape	DC	DMM	APMXS	OAL	LN	DN	RE	PCEDC	Cylindrical
				mm	mm	mm	mm	mm	mm	mm		
JS532010F1B.0Z2-NXT	02928193	1	F	1,0	3,0	2,0	38,0	3,1	1,0	0,5	2	■
JS532015F1B.0Z2-NXT	02928194	1	F	1,5	3,0	3,0	38,0	4,6	1,5	0,75	2	■
JS532020F1B.0Z2-NXT	02928195	1	F	2,0	3,0	4,0	38,0	6,1	2,0	1,0	2	■
JS532025F1B.0Z2-NXT	02928197	1	F	2,5	3,0	5,0	38,0	7,1	2,5	1,25	2	■
JS532030D1B.0Z2-NXT	02928199	1	D	3,0	3,0	6,0	38,0	-	-	1,5	2	■
JS532035F1B.0Z2-NXT	02928202	1	F	3,5	6,0	7,0	57,0	9,6	3,5	1,75	2	■
JS532040F1B.0Z2-NXT	02928203	1	F	4,0	6,0	8,0	57,0	10,75	4,0	2,0	2	■
JS532045F1B.0Z2-NXT	02928206	1	F	4,5	6,0	9,0	57,0	11,75	4,5	2,25	2	■
JS532050F1B.0Z2-NXT	02928207	1	F	5,0	6,0	10,0	57,0	12,75	5,0	2,5	2	■
JS532060D1B.0Z2-NXT	02928210	1	D	6,0	6,0	12,0	57,0	-	-	3,0	2	■
JS532080D1B.0Z2-NXT	02928213	1	D	8,0	8,0	16,0	63,0	-	-	4,0	2	■
JS532100D1B.0Z2-NXT	02928216	1	D	10,0	10,0	20,0	72,0	-	-	5,0	2	■
JS532120D1B.0Z2-NXT	02928219	1	D	12,0	12,0	24,0	83,0	-	-	6,0	2	■
JS532160D1B.0Z2-NXT	02928222	1	D	16,0	16,0	32,0	92,0	-	-	8,0	2	■
JS532200D1B.0Z2-NXT	02928225	1	D	20,0	20,0	40,0	104,0	-	-	10,0	2	■
JS532020G2B.0Z2-NXT	02928196	2	G	2,0	3,0	2,0	38,0	8,0	1,9	1,0	2	■
JS532030E2B.0Z2-NXT	02928200	2	E	3,0	3,0	3,0	38,0	10,0	2,85	1,5	2	■
JS532040G2B.0Z2-NXT	02928204	2	G	4,0	6,0	4,0	57,0	15,0	3,8	2,0	2	■
JS532050G2B.0Z2-NXT	02928208	2	G	5,0	6,0	5,0	57,0	20,0	4,8	2,5	2	■
JS532060E2B.0Z2-NXT	02928211	2	E	6,0	6,0	6,0	63,0	25,0	5,7	3,0	2	■
JS532080E2B.0Z2-NXT	02928214	2	E	8,0	8,0	8,0	80,0	35,0	7,6	4,0	2	■
JS532100E2B.0Z2-NXT	02928217	2	E	10,0	10,0	10,0	82,0	40,0	9,5	5,0	2	■
JS532120E2B.0Z2-NXT	02928220	2	E	12,0	12,0	12,0	100,0	50,0	11,4	6,0	2	■
JS532160E2B.0Z2-NXT	02928223	2	E	16,0	16,0	16,0	125,0	72,0	15,2	8,0	2	■
JS532030E3B.0Z2-NXT	02928201	3	E	3,0	3,0	3,0	52,0	20,0	2,85	1,5	2	■
JS532040G3B.0Z2-NXT	02928205	3	G	4,0	6,0	4,0	63,0	24,0	3,8	2,0	2	■
JS532050G3B.0Z2-NXT	02928209	3	G	5,0	6,0	5,0	75,0	35,0	4,8	2,5	2	■
JS532060E3B.0Z2-NXT	02928212	3	E	6,0	6,0	6,0	80,0	42,0	5,7	3,0	2	■
JS532080E3B.0Z2-NXT	02928215	3	E	8,0	8,0	8,0	100,0	60,0	7,6	4,0	2	■
JS532100E3B.0Z2-NXT	02928218	3	E	10,0	10,0	10,0	125,0	80,0	9,5	5,0	2	■
JS532120E3B.0Z2-NXT	02928221	3	E	12,0	12,0	12,0	125,0	75,0	11,4	6,0	2	■
JS532160E3B.0Z2-NXT	02928224	3	E	16,0	16,0	16,0	150,0	100,0	15,2	8,0	2	■

■ Stocked standard.

Universal

Steel and cast iron

Stainless steel and S-materials

Non ferrous

Hard

Plastic and CFRP

Graphite

X-Heads

Minimaster Plus

Minimaster

JS532

High performance – Universal – Ball nose – 2 Flutes – Weldon

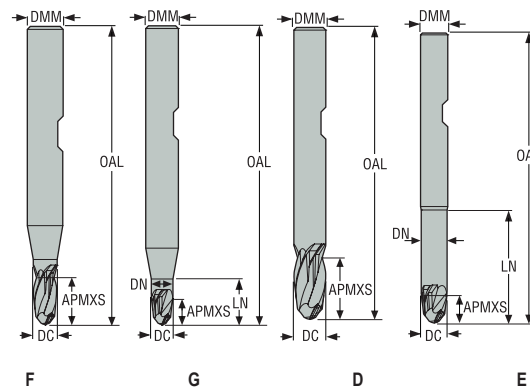

- Tolerances:
- DMM=h5
- DC=e8
- RE= ±0,01 mm
- Regrind possible if DC is ≥Ø6

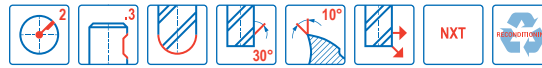

Designation	Item number	Length index	Tool shape	DC	DMM	APMXS	OAL	LN	DN	RE	PCEDC	Weldon
				mm	mm	mm	mm	mm	mm	mm		
JS532035F1B.3Z2-NXT	02928254	1	F	3,5	6,0	7,0	57,0	9,6	3,5	1,75	2	<input type="checkbox"/>
JS532040F1B.3Z2-NXT	02928255	1	F	4,0	6,0	8,0	57,0	10,75	4,0	2,0	2	<input type="checkbox"/>
JS532045F1B.3Z2-NXT	02928258	1	F	4,5	6,0	9,0	57,0	11,75	4,5	2,25	2	<input type="checkbox"/>
JS532050F1B.3Z2-NXT	02928259	1	F	5,0	6,0	10,0	57,0	12,75	5,0	2,5	2	<input type="checkbox"/>
JS532060D1B.3Z2-NXT	02928263	1	D	6,0	6,0	12,0	57,0	-	-	3,0	2	<input type="checkbox"/>
JS532080D1B.3Z2-NXT	02928266	1	D	8,0	8,0	16,0	63,0	-	-	4,0	2	<input type="checkbox"/>
JS532100D1B.3Z2-NXT	02928269	1	D	10,0	10,0	20,0	72,0	-	-	5,0	2	<input type="checkbox"/>
JS532120D1B.3Z2-NXT	02928272	1	D	12,0	12,0	24,0	83,0	-	-	6,0	2	<input type="checkbox"/>
JS532160D1B.3Z2-NXT	02928275	1	D	16,0	16,0	32,0	92,0	-	-	8,0	2	<input type="checkbox"/>
JS532200D1B.3Z2-NXT	02928278	1	D	20,0	20,0	40,0	104,0	-	-	10,0	2	<input type="checkbox"/>
JS532040G2B.3Z2-NXT	02928256	2	G	4,0	6,0	4,0	57,0	18,0	3,8	2,0	2	<input type="checkbox"/>
JS532050G2B.3Z2-NXT	02928260	2	G	5,0	6,0	5,0	57,0	18,0	4,8	2,5	2	<input type="checkbox"/>
JS532060E2B.3Z2-NXT	02928264	2	E	6,0	6,0	6,0	63,0	25,0	5,7	3,0	2	<input type="checkbox"/>
JS532080E2B.3Z2-NXT	02928267	2	E	8,0	8,0	8,0	80,0	35,0	7,6	4,0	2	<input type="checkbox"/>
JS532100E2B.3Z2-NXT	02928270	2	E	10,0	10,0	10,0	82,0	40,0	9,5	5,0	2	<input type="checkbox"/>
JS532120E2B.3Z2-NXT	02928273	2	E	12,0	12,0	12,0	100,0	50,0	11,4	6,0	2	<input type="checkbox"/>
JS532160E2B.3Z2-NXT	02928276	2	E	16,0	16,0	16,0	125,0	70,0	15,2	8,0	2	<input type="checkbox"/>
JS532040G3B.3Z2-NXT	02928257	3	G	4,0	6,0	4,0	63,0	24,0	3,8	2,0	2	<input type="checkbox"/>
JS532050G3B.3Z2-NXT	02928261	3	G	5,0	6,0	5,0	75,0	35,0	4,8	2,5	2	<input type="checkbox"/>
JS532060E3B.3Z2-NXT	02928265	3	E	6,0	6,0	6,0	80,0	42,0	5,7	3,0	2	<input type="checkbox"/>
JS532080E3B.3Z2-NXT	02928268	3	E	8,0	8,0	8,0	100,0	60,0	7,6	4,0	2	<input type="checkbox"/>
JS532100E3B.3Z2-NXT	02928271	3	E	10,0	10,0	10,0	125,0	80,0	9,5	5,0	2	<input type="checkbox"/>
JS532120E3B.3Z2-NXT	02928274	3	E	12,0	12,0	12,0	125,0	75,0	11,4	6,0	2	<input type="checkbox"/>
JS532160E3B.3Z2-NXT	02928277	3	E	16,0	16,0	16,0	150,0	100,0	15,2	8,0	2	<input type="checkbox"/>

Weldon available. Delivery time is 3 days.

Universal

Steel and cast iron

Stainless steel and S-materials

Non ferrous

Hard

Plastic and CFRP

Graphite

X-Heads

Minimaster Plus

Minimaster

Cutting data – JS532 Copy milling roughing

SMG	Coolant	a _e /DC	a _p /DC	f _z												v _c
				1	2	3	4	5	6	8	10	12	16	20		
P1	M/A/D/E	0.200	0.20	0.0060	0.012	0.018	0.024	0.030	0.036	0.048	0.060	0.070	0.095	0.11	205 (140 – 180)	
		0,200	0,20	0,00024	0,00048	0,00070	0,00095	0,0012	0,0014	0,0019	0,0024	0,0028	0,0038	0,0044	670 (460 – 590)	
P2	M/A/D/E	0.200	0.20	0.0060	0.012	0.018	0.024	0.030	0.036	0.048	0.060	0.070	0.095	0.11	200 (130 – 180)	
		0,200	0,20	0,00024	0,00048	0,00070	0,00095	0,0012	0,0014	0,0019	0,0024	0,0028	0,0038	0,0044	660 (430 – 590)	
P3	M/A/D/E	0.200	0.20	0.0060	0.012	0.018	0.024	0.030	0.036	0.048	0.060	0.070	0.095	0.11	170 (110 – 150)	
		0,200	0,20	0,00024	0,00048	0,00070	0,00095	0,0012	0,0014	0,0019	0,0024	0,0028	0,0038	0,0044	560 (370 – 490)	
P4	M/A/D/E	0.200	0.20	0.0060	0.012	0.018	0.024	0.030	0.036	0.048	0.060	0.070	0.095	0.10	150 (97 – 130)	
		0,200	0,20	0,00024	0,00048	0,00070	0,00095	0,0012	0,0014	0,0019	0,0024	0,0028	0,0038	0,0040	490 (320 – 420)	
P5	M/A/D/E	0.200	0.20	0.0060	0.012	0.018	0.024	0.030	0.036	0.048	0.060	0.070	0.090	0.10	145 (93 – 130)	
		0,200	0,20	0,00024	0,00048	0,00070	0,00095	0,0012	0,0014	0,0019	0,0024	0,0028	0,0036	0,0040	475 (310 – 420)	
P6	M/A/D/E	0.200	0.20	0.0060	0.012	0.018	0.024	0.030	0.036	0.048	0.060	0.070	0.090	0.10	160 (110 – 140)	
		0,200	0,20	0,00024	0,00048	0,00070	0,00095	0,0012	0,0014	0,0019	0,0024	0,0028	0,0036	0,0040	520 (370 – 450)	
P7	M/A/D/E	0.200	0.20	0.0060	0.012	0.018	0.024	0.030	0.036	0.048	0.060	0.070	0.090	0.10	150 (98 – 140)	
		0,200	0,20	0,00024	0,00048	0,00070	0,00095	0,0012	0,0014	0,0019	0,0024	0,0028	0,0036	0,0040	490 (330 – 450)	
P8	M/A/D/E	0.200	0.20	0.0060	0.012	0.018	0.024	0.030	0.036	0.048	0.060	0.070	0.095	0.11	145 (93 – 130)	
		0,200	0,20	0,00024	0,00048	0,00070	0,00095	0,0012	0,0014	0,0019	0,0024	0,0028	0,0038	0,0044	475 (310 – 420)	
P11	M/A/D/E	0.100	0.10	0.0060	0.012	0.018	0.024	0.030	0.036	0.048	0.060	0.070	0.095	0.12	170 (110 – 150)	
		0,100	0,10	0,00024	0,00048	0,00070	0,00095	0,0012	0,0014	0,0019	0,0024	0,0028	0,0038	0,0048	560 (370 – 490)	
P12	M/A/D/E	0.100	0.10	0.0060	0.012	0.018	0.024	0.030	0.036	0.048	0.060	0.070	0.095	0.12	100 (64 – 92)	
		0,100	0,10	0,00024	0,00048	0,00070	0,00095	0,0012	0,0014	0,0019	0,0024	0,0028	0,0038	0,0048	330 (210 – 300)	
M1	E	0.100	0.10	0.0060	0.012	0.018	0.024	0.030	0.036	0.048	0.060	0.070	0.095	0.12	195 (170 – 220)	
		0,100	0,10	0,00024	0,00048	0,00070	0,00095	0,0012	0,0014	0,0019	0,0024	0,0028	0,0038	0,0048	640 (560 – 720)	
M2	E	0.100	0.10	0.0060	0.012	0.018	0.024	0.030	0.036	0.048	0.060	0.070	0.095	0.12	115 (93 – 130)	
		0,100	0,10	0,00024	0,00048	0,00070	0,00095	0,0012	0,0014	0,0019	0,0024	0,0028	0,0038	0,0048	375 (310 – 420)	
M3	E	0.100	0.10	0.0050	0.010	0.015	0.020	0.025	0.030	0.040	0.050	0.060	0.080	0.095	95 (73 – 110)	
		0,100	0,10	0,00020	0,00040	0,00060	0,00080	0,0010	0,0012	0,0016	0,0020	0,0024	0,0032	0,0038	310 (240 – 360)	
M4	E	0.100	0.10	0.0048	0.0095	0.014	0.019	0.024	0.028	0.038	0.048	0.055	0.070	0.080	70 (55 – 85)	
		0,100	0,10	0,00019	0,00038	0,00055	0,00075	0,00095	0,0011	0,0015	0,0019	0,0022	0,0028	0,0032	230 (190 – 270)	
M5	E	0.100	0.10	0.0048	0.0095	0.014	0.019	0.024	0.028	0.038	0.048	0.055	0.070	0.080	60 (46 – 71)	
		0,100	0,10	0,00019	0,00038	0,00055	0,00075	0,00095	0,0011	0,0015	0,0019	0,0022	0,0028	0,0032	195 (160 – 230)	
K1	E	0.200	0.20	0.0060	0.012	0.018	0.024	0.030	0.036	0.048	0.060	0.070	0.090	0.10	195 (180 – 210)	
		0,200	0,20	0,00024	0,00048	0,00070	0,00095	0,0012	0,0014	0,0019	0,0024	0,0028	0,0036	0,0040	640 (600 – 680)	
K2	E	0.200	0.20	0.0055	0.011	0.016	0.022	0.028	0.032	0.044	0.055	0.065	0.085	0.095	170 (160 – 180)	
		0,200	0,20	0,00022	0,00044	0,00065	0,00085	0,0011	0,0013	0,0017	0,0022	0,0026	0,0034	0,0038	560 (530 – 590)	
K3	E	0.200	0.20	0.0055	0.011	0.016	0.022	0.028	0.032	0.044	0.055	0.065	0.085	0.095	145 (130 – 150)	
		0,200	0,20	0,00022	0,00044	0,00065	0,00085	0,0011	0,0013	0,0017	0,0022	0,0026	0,0034	0,0038	475 (430 – 490)	
K4	E	0.200	0.20	0.0055	0.011	0.016	0.022	0.028	0.032	0.044	0.055	0.065	0.085	0.095	140 (130 – 150)	
		0,200	0,20	0,00022	0,00044	0,00065	0,00085	0,0011	0,0013	0,0017	0,0022	0,0026	0,0034	0,0038	460 (430 – 490)	
K5	E	0.100	0.10	0.0050	0.010	0.015	0.020	0.025	0.030	0.040	0.050	0.060	0.080	0.095	165 (150 – 180)	
		0,100	0,10	0,00020	0,00040	0,00060	0,00080	0,0010	0,0012	0,0016	0,0020	0,0024	0,0032	0,0038	540 (500 – 590)	
K6	E	0.100	0.10	0.0050	0.010	0.015	0.020	0.025	0.030	0.040	0.050	0.060	0.080	0.10	245 (220 – 270)	
		0,100	0,10	0,00020	0,00040	0,00060	0,00080	0,0010	0,0012	0,0016	0,0020	0,0024	0,0032	0,0040	800 (730 – 880)	
K7	E	0.100	0.10	0.0050	0.010	0.015	0.020	0.025	0.030	0.040	0.050	0.060	0.080	0.095	210 (190 – 230)	
		0,100	0,10	0,00020	0,00040	0,00060	0,00080	0,0010	0,0012	0,0016	0,0020	0,0024	0,0032	0,0038	690 (630 – 750)	

For cutting data recalculations, see pages 556 - 563

SMG = Seco material group
 Coolant = A=air D=dry E=emulsion M=mist spray
 v_c = m/min (sf/min)
 f_z = mm (in/tooth)
 a_p = mm/DC (in/DC) = factor
 a_e = mm/DC (in/DC) = factor
 All cutting data are target values

Universal
 Steel and cast iron
 Stainless steel and S-materials
 Non ferrous
 Hard
 Plastic and CFRP
 Graphite
 X-Heads
 Minimaster Plus
 Minimaster

Cutting data – JS532 Copy milling roughing

Universal	SMG	Coolant	a _e /DC	a _p /DC	f _z										v _c	
					1	2	3	4	5	6	8	10	12	16		20
Steel and cast iron	N1	E	0.200	0.30	0.0080	0.016	0.024	0.032	0.038	0.046	0.060	0.080	0.095	0.11	0.13	610 (520 – 710)
			0.200	0.30	0,00032	0,00065	0,00095	0,0013	0,0015	0,0018	0,0024	0,0032	0,0038	0,0044	0,0050	2000 (1800 – 2300)
	N2	E	0.200	0.30	0.0080	0.016	0.024	0.032	0.038	0.046	0.060	0.080	0.095	0.11	0.13	395 (330 – 450)
Stainless steel and S-materials	N3	E	0.200	0.30	0.0080	0.016	0.024	0.032	0.038	0.046	0.060	0.080	0.095	0.11	0.13	260 (220 – 300)
			0.200	0.30	0,00032	0,00065	0,00095	0,0013	0,0015	0,0018	0,0024	0,0032	0,0038	0,0044	0,0050	850 (730 – 980)
	N11	E	0.200	0.30	0.0050	0.010	0.016	0.020	0.026	0.032	0.040	0.050	0.060	0.075	0.090	415 (370 – 460)
Non ferrous	S1	E	0.150	0.10	0.0040	0.0080	0.012	0.016	0.020	0.024	0.032	0.040	0.048	0.065	0.080	60 (52 – 72)
			0.150	0.10	0,00016	0,00032	0,00048	0,00065	0,00080	0,00095	0,0013	0,0016	0,0019	0,0026	0,0032	195 (180 – 230)
	S2	E	0.150	0.10	0.0040	0.0080	0.012	0.016	0.020	0.024	0.032	0.040	0.048	0.065	0.080	50 (42 – 58)
Hard	S3	E	0.100	0.10	0.0036	0.0070	0.010	0.014	0.018	0.020	0.028	0.036	0.042	0.055	0.060	32 (22 – 42)
			0.100	0.10	0,00014	0,00028	0,00040	0,00055	0,00070	0,00080	0,0011	0,0014	0,0017	0,0022	0,0024	105 (73 – 130)
	S11	E	0.200	0.20	0.0060	0.012	0.018	0.024	0.030	0.036	0.048	0.060	0.070	0.090	0.10	105 (94 – 110)
Plastic and CFRP	S12	E	0.200	0.20	0.0060	0.012	0.018	0.024	0.030	0.036	0.048	0.060	0.070	0.090	0.10	80 (72 – 92)
			0.200	0.20	0,00024	0,00048	0,00070	0,00095	0,0012	0,0014	0,0019	0,0024	0,0028	0,0036	0,0040	260 (240 – 300)
	S13	E	0.200	0.20	0.0055	0.011	0.016	0.022	0.026	0.032	0.042	0.055	0.060	0.080	0.090	65 (57 – 72)
Graphite	TS1	A	0.200	0.40	0.0075	0.015	0.024	0.030	0.038	0.046	0.065	0.075	0.090	0.12	0.13	610 (570 – 660)
			0.200	0.40	0,00030	0,00060	0,00095	0,0012	0,0015	0,0018	0,0026	0,0030	0,0036	0,0048	0,0050	2000 (1900 – 2100)
	TP1	A	0.200	0.40	0.0075	0.015	0.024	0.030	0.038	0.046	0.065	0.075	0.090	0.12	0.13	610 (570 – 660)
X-Heads	GR1	A	0.200	0.40	0.0075	0.015	0.024	0.030	0.038	0.046	0.065	0.075	0.090	0.12	0.13	610 (570 – 660)
			0.200	0.40	0,00030	0,00060	0,00095	0,0012	0,0015	0,0018	0,0026	0,0030	0,0036	0,0048	0,0050	2000 (1900 – 2100)
	GR1	A	0.200	0.40	0.0075	0.015	0.024	0.030	0.038	0.046	0.065	0.075	0.090	0.12	0.13	610 (570 – 660)
Minimaster Plus	GR1	A	0.200	0.40	0.0075	0.015	0.024	0.030	0.038	0.046	0.065	0.075	0.090	0.12	0.13	610 (570 – 660)
			0.200	0.40	0,00030	0,00060	0,00095	0,0012	0,0015	0,0018	0,0026	0,0030	0,0036	0,0048	0,0050	2000 (1900 – 2100)
	GR1	A	0.200	0.40	0.0075	0.015	0.024	0.030	0.038	0.046	0.065	0.075	0.090	0.12	0.13	610 (570 – 660)
Minimaster	GR1	A	0.200	0.40	0.0075	0.015	0.024	0.030	0.038	0.046	0.065	0.075	0.090	0.12	0.13	610 (570 – 660)
			0.200	0.40	0,00030	0,00060	0,00095	0,0012	0,0015	0,0018	0,0026	0,0030	0,0036	0,0048	0,0050	2000 (1900 – 2100)
	GR1	A	0.200	0.40	0.0075	0.015	0.024	0.030	0.038	0.046	0.065	0.075	0.090	0.12	0.13	610 (570 – 660)

For cutting data recalculations, see pages 556 - 563

SMG = Seco material group
Coolant = A=air D=dry E=emulsion M=mist spray
v_c = m/min (sf/min)
f_z = mm (in/tooth)
a_p = mm/DC (in/DC) = factor
a_e = mm/DC (in/DC) = factor
All cutting data are target values

JS533

High performance – Universal – Ball nose – 3 Flutes – Cylindrical

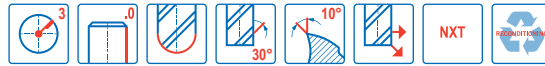
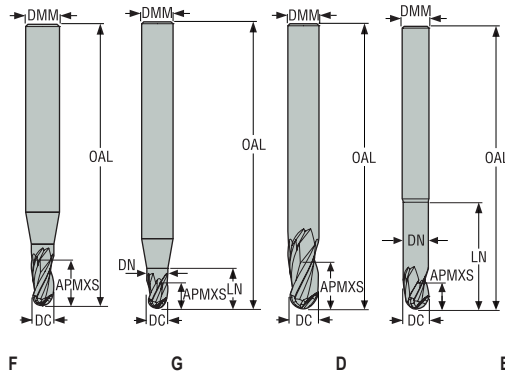

- Tolerances:
- DMM=h5
- DC=e8
- RE= ±0,01 mm
- Regrind possible if DC is ≥Ø6

Designation	Item number	Length index	Tool shape	DC	DMM	APMXS	OAL	LN	DN	RE	PCEDC	Cylindrical
				mm	mm	mm	mm	mm	mm	mm		
JS533010F1B.0Z3-NXT	02928284	1	F	1,0	3,0	2,0	38,0	3,0	1,05	0,5	3	■
JS533015F1B.0Z3-NXT	02928286	1	F	1,5	3,0	3,0	38,0	4,6	1,55	0,75	3	■
JS533020F1B.0Z3-NXT	02928287	1	F	2,0	3,0	4,0	38,0	5,6	2,05	1,0	3	■
JS533030D1B.0Z3-NXT	02928289	1	D	3,0	3,0	6,0	38,0	–	–	1,5	3	■
JS533040F1B.0Z3-NXT	02928291	1	F	4,0	6,0	8,0	57,0	10,75	4,05	2,0	3	■
JS533050F1B.0Z3-NXT	02928293	1	F	5,0	6,0	10,0	57,0	13,75	5,05	2,5	3	■
JS533060D1B.0Z3-NXT	02928295	1	D	6,0	6,0	12,0	57,0	–	–	3,0	3	■
JS533080D1B.0Z3-NXT	02928297	1	D	8,0	8,0	16,0	63,0	–	–	4,0	3	■
JS533100D1B.0Z3-NXT	02928299	1	D	10,0	10,0	20,0	72,0	–	–	5,0	3	■
JS533120D1B.0Z3-NXT	02928301	1	D	12,0	12,0	24,0	83,0	–	–	6,0	3	■
JS533160D1B.0Z3-NXT	02928303	1	D	16,0	16,0	32,0	110,0	–	–	8,0	3	■
JS533200D1B.0Z3-NXT	02928305	1	D	20,0	20,0	40,0	125,0	–	–	10,0	3	■
JS533020G2B.0Z3-NXT	02928288	2	G	2,0	3,0	2,0	38,0	7,0	1,9	1,0	3	■
JS533030E2B.0Z3-NXT	02928290	2	E	3,0	3,0	3,0	38,0	9,0	2,85	1,5	3	■
JS533040G2B.0Z3-NXT	02928292	2	G	4,0	6,0	4,0	57,0	15,0	3,8	2,0	3	■
JS533050G2B.0Z3-NXT	02928294	2	G	5,0	6,0	5,0	57,0	15,0	4,8	2,5	3	■
JS533060E2B.0Z3-NXT	02928296	2	E	6,0	6,0	6,0	63,0	25,0	5,7	3,0	3	■
JS533080E2B.0Z3-NXT	02928298	2	E	8,0	8,0	8,0	80,0	35,0	7,6	4,0	3	■
JS533100E2B.0Z3-NXT	02928300	2	E	10,0	10,0	10,0	89,0	40,0	9,5	5,0	3	■
JS533120E2B.0Z3-NXT	02928302	2	E	12,0	12,0	12,0	100,0	50,0	11,4	6,0	3	■
JS533160E2B.0Z3-NXT	02928304	2	E	16,0	16,0	16,0	125,0	70,0	15,2	8,0	3	■

■ Stocked standard.

Universal

Steel and cast iron

Stainless steel and S-materials

Non ferrous

Hard

Plastic and CFRP

Graphite

X-Heads

Minimaster Plus

Minimaster

JS533

High performance – Universal – Ball nose – 3 Flutes – Weldon

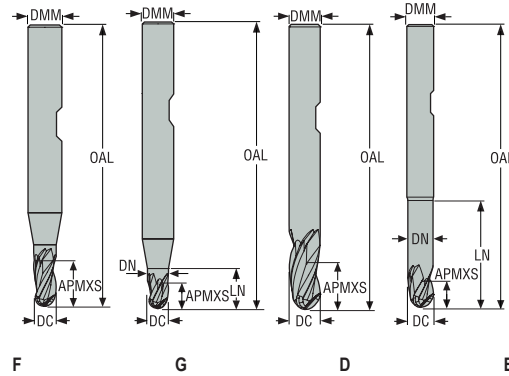

- Tolerances:
- DMM=h5
- DC=e8
- RE= ±0,01 mm
- Regrind possible if DC is ≥Ø6

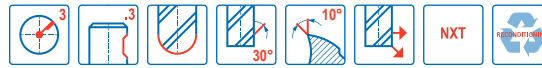

Designation	Item number	Length index	Tool shape	DC	DMM	APMXS	OAL	LN	DN	RE	PCEDC	Weldon
				mm	mm	mm	mm	mm	mm	mm		
JS533040F1B.3Z3-NXT	02928323	1	F	4,0	6,0	8,0	57,0	10,75	4,05	2,0	3	<input type="checkbox"/>
JS533050F1B.3Z3-NXT	02928325	1	F	5,0	6,0	10,0	57,0	13,75	5,05	2,5	3	<input type="checkbox"/>
JS533060D1B.3Z3-NXT	02928326	1	D	6,0	6,0	12,0	57,0	-	-	3,0	3	<input type="checkbox"/>
JS533080D1B.3Z3-NXT	02928328	1	D	8,0	8,0	16,0	63,0	-	-	4,0	3	<input type="checkbox"/>
JS533100D1B.3Z3-NXT	02928330	1	D	10,0	10,0	20,0	72,0	-	-	5,0	3	<input type="checkbox"/>
JS533120D1B.3Z3-NXT	02928332	1	D	12,0	12,0	24,0	83,0	-	-	6,0	3	<input type="checkbox"/>
JS533160D1B.3Z3-NXT	02928334	1	D	16,0	16,0	32,0	109,0	-	-	8,0	3	<input type="checkbox"/>
JS533200D1B.3Z3-NXT	02928336	1	D	20,0	20,0	40,0	125,0	-	-	10,0	3	<input type="checkbox"/>
JS533040G2B.3Z3-NXT	02928324	2	G	4,0	6,0	4,0	57,0	15,0	3,8	2,0	3	<input type="checkbox"/>
JS533050G2B.3Z3-NXT	02928341	2	G	5,0	6,0	5,0	57,0	15,0	4,8	2,5	3	<input type="checkbox"/>
JS533060E2B.3Z3-NXT	02928327	2	E	6,0	6,0	6,0	63,0	25,0	5,7	3,0	3	<input type="checkbox"/>
JS533080E2B.3Z3-NXT	02928329	2	E	8,0	8,0	8,0	80,0	35,0	7,6	4,0	3	<input type="checkbox"/>
JS533100E2B.3Z3-NXT	02928331	2	E	10,0	10,0	10,0	89,0	40,0	9,5	5,0	3	<input type="checkbox"/>
JS533120E2B.3Z3-NXT	02928333	2	E	12,0	12,0	12,0	100,0	50,0	11,4	6,0	3	<input type="checkbox"/>
JS533160E2B.3Z3-NXT	02928335	2	E	16,0	16,0	16,0	122,0	70,0	15,2	8,0	3	<input type="checkbox"/>

Weldon available. Delivery time is 3 days.

Universal

Steel and cast iron

Stainless steel and S-materials

Non ferrous

Hard

Plastic and cfrp

Graphite

X-Heads

Minimaster Plus

Minimaster

Cutting data – JS533 Copy milling roughing

SMG		a _e /DC	a _p /DC	f _z												v _c
				1	2	3	4	5	6	8	10	12	16	20		
P1	M/A/D/E	0.0300	0.80	0.0032	0.0065	0.0095	0.013	0.016	0.019	0.026	0.032	0.038	0.048	0.055	200 (180 – 220)	
		0,0300	0,80	0,00013	0,00026	0,00038	0,00050	0,00065	0,00075	0,0010	0,0013	0,0015	0,0019	0,0022	660 (600 – 720)	
P2	M/A/D/E	0.0300	0.80	0.0034	0.0065	0.010	0.013	0.017	0.020	0.026	0.034	0.038	0.048	0.055	195 (170 – 220)	
		0,0300	0,80	0,00013	0,00026	0,00040	0,00050	0,00065	0,00080	0,0010	0,0013	0,0015	0,0019	0,0022	640 (560 – 720)	
P3	M/A/D/E	0.0300	0.80	0.0032	0.0060	0.0095	0.013	0.016	0.019	0.025	0.032	0.036	0.046	0.055	165 (150 – 180)	
		0,0300	0,80	0,00013	0,00024	0,00038	0,00050	0,00065	0,00075	0,0010	0,0013	0,0014	0,0018	0,0022	540 (500 – 590)	
P4	M/A/D/E	0.0300	0.80	0.0030	0.0060	0.0090	0.012	0.015	0.018	0.025	0.030	0.036	0.044	0.050	145 (130 – 160)	
		0,0300	0,80	0,00012	0,00024	0,00036	0,00048	0,00060	0,00070	0,0010	0,0012	0,0014	0,0017	0,0020	475 (430 – 520)	
P5	M/A/D/E	0.0300	0.80	0.0030	0.0060	0.0090	0.012	0.015	0.018	0.024	0.030	0.036	0.044	0.050	140 (130 – 160)	
		0,0300	0,80	0,00012	0,00024	0,00036	0,00048	0,00060	0,00070	0,00095	0,0012	0,0014	0,0017	0,0020	460 (430 – 520)	
P6	M/A/D/E	0.0300	0.80	0.0030	0.0060	0.0090	0.012	0.015	0.018	0.024	0.030	0.034	0.044	0.050	155 (140 – 170)	
		0,0300	0,80	0,00012	0,00024	0,00036	0,00048	0,00060	0,00070	0,00095	0,0012	0,0013	0,0017	0,0020	510 (460 – 550)	
P7	M/A/D/E	0.0300	0.80	0.0030	0.0060	0.0090	0.012	0.015	0.018	0.024	0.030	0.034	0.044	0.050	150 (130 – 160)	
		0,0300	0,80	0,00012	0,00024	0,00036	0,00048	0,00060	0,00070	0,00095	0,0012	0,0013	0,0017	0,0020	490 (430 – 520)	
P8	M/A/D/E	0.0300	0.80	0.0032	0.0060	0.0095	0.013	0.016	0.019	0.025	0.032	0.036	0.046	0.055	140 (120 – 150)	
		0,0300	0,80	0,00013	0,00024	0,00038	0,00050	0,00065	0,00075	0,0010	0,0013	0,0014	0,0018	0,0022	460 (400 – 490)	
P11	M/A/D/E	0.0300	0.80	0.0044	0.0090	0.013	0.018	0.022	0.026	0.036	0.044	0.050	0.065	0.075	140 (130 – 160)	
		0,0300	0,80	0,00017	0,00036	0,00050	0,00070	0,00085	0,0010	0,0014	0,0017	0,0020	0,0026	0,0030	460 (430 – 520)	
P12	M/A/D/E	0.0300	0.80	0.0030	0.0060	0.0090	0.012	0.015	0.018	0.024	0.030	0.036	0.044	0.050	85 (73 – 97)	
		0,0300	0,80	0,00012	0,00024	0,00036	0,00048	0,00060	0,00070	0,00095	0,0012	0,0014	0,0017	0,0020	280 (240 – 310)	
M1	E	0.0300	0.80	0.0034	0.0065	0.010	0.013	0.017	0.020	0.026	0.034	0.038	0.048	0.055	125 (99 – 140)	
		0,0300	0,80	0,00013	0,00026	0,00040	0,00050	0,00065	0,00080	0,0010	0,0013	0,0015	0,0019	0,0022	410 (330 – 450)	
M2	E	0.0300	0.80	0.0030	0.0060	0.0090	0.012	0.015	0.018	0.024	0.030	0.036	0.044	0.050	100 (80 – 120)	
		0,0300	0,80	0,00012	0,00024	0,00036	0,00048	0,00060	0,00070	0,00095	0,0012	0,0014	0,0017	0,0020	330 (270 – 390)	
M3	E	0.0300	0.80	0.0030	0.0060	0.0090	0.012	0.015	0.018	0.024	0.030	0.036	0.044	0.050	70 (50 – 90)	
		0,0300	0,80	0,00012	0,00024	0,00036	0,00048	0,00060	0,00070	0,00095	0,0012	0,0014	0,0017	0,0020	230 (170 – 290)	
M4	E	0.0300	0.80	0.0026	0.0050	0.0080	0.011	0.013	0.016	0.022	0.026	0.030	0.038	0.044	55 (38 – 67)	
		0,0300	0,80	0,00010	0,00020	0,00032	0,00044	0,00050	0,00065	0,00085	0,0010	0,0012	0,0015	0,0017	180 (130 – 210)	
M5	E	0.0300	0.80	0.0026	0.0050	0.0080	0.011	0.013	0.016	0.022	0.026	0.030	0.038	0.044	44 (32 – 56)	
		0,0300	0,80	0,00010	0,00020	0,00032	0,00044	0,00050	0,00065	0,00085	0,0010	0,0012	0,0015	0,0017	145 (110 – 180)	
K1	E	0.0300	0.80	0.0040	0.0080	0.012	0.016	0.020	0.024	0.032	0.040	0.046	0.060	0.070	145 (130 – 160)	
		0,0300	0,80	0,00016	0,00032	0,00048	0,00065	0,00080	0,00095	0,0013	0,0016	0,0018	0,0024	0,0028	475 (430 – 520)	
K2	E	0.0300	0.80	0.0036	0.0075	0.011	0.015	0.018	0.022	0.030	0.036	0.042	0.055	0.060	125 (110 – 140)	
		0,0300	0,80	0,00014	0,00030	0,00044	0,00060	0,00070	0,00085	0,0012	0,0014	0,0017	0,0022	0,0024	410 (370 – 450)	
K3	E	0.0300	0.80	0.0050	0.010	0.015	0.020	0.025	0.030	0.040	0.050	0.060	0.075	0.085	105 (91 – 110)	
		0,0300	0,80	0,00020	0,00040	0,00060	0,00080	0,0010	0,0012	0,0016	0,0020	0,0024	0,0030	0,0034	345 (300 – 360)	
K4	E	0.0300	0.80	0.0050	0.010	0.015	0.020	0.025	0.030	0.040	0.050	0.060	0.075	0.085	120 (100 – 140)	
		0,0300	0,80	0,00020	0,00040	0,00060	0,00080	0,0010	0,0012	0,0016	0,0020	0,0024	0,0030	0,0034	395 (330 – 450)	
K5	E	0.0300	0.80	0.0044	0.0090	0.013	0.018	0.022	0.026	0.036	0.044	0.055	0.065	0.075	70 (61 – 84)	
		0,0300	0,80	0,00017	0,00036	0,00050	0,00070	0,00085	0,0010	0,0014	0,0017	0,0022	0,0026	0,0030	230 (210 – 270)	
K6	E	0.0300	0.80	0.0050	0.010	0.015	0.020	0.025	0.030	0.040	0.050	0.060	0.075	0.085	105 (89 – 120)	
		0,0300	0,80	0,00020	0,00040	0,00060	0,00080	0,0010	0,0012	0,0016	0,0020	0,0024	0,0030	0,0034	345 (300 – 390)	
K7	E	0.0300	0.80	0.0044	0.0090	0.013	0.018	0.022	0.026	0.036	0.044	0.055	0.065	0.075	155 (130 – 180)	
		0,0300	0,80	0,00017	0,00036	0,00050	0,00070	0,00085	0,0010	0,0014	0,0017	0,0022	0,0026	0,0030	510 (430 – 590)	

For cutting data recalculations, see pages 556 - 563

SMG = Seco material group
 Coolant = A=air D=dry E=emulsion M=mist spray
 v_c = m/min (sf/min)
 f_z = mm (in/tooth)
 a_p = mm/DC (in/DC) = factor
 a_e = mm/DC (in/DC) = factor
 All cutting data are target values

Universal
Steel and cast iron
Stainless steel and S-materials
Non ferrous
Hard
Plastic and CFRP
Graphite
X-Heads
Minimaster Plus
Minimaster

Cutting data – JS533 Copy milling roughing

Universal	SMG		a _e /DC	a _p /DC	f _z										v _c	
					1	2	3	4	5	6	8	10	12	16		20
Steel and cast iron	N1	E	0.0300	0.80	0.0050	0.010	0.015	0.020	0.025	0.030	0.040	0.050	0.060	0.075	0.085	800 (700 – 900)
			<i>0,0300</i>	<i>0,80</i>	<i>0,00020</i>	<i>0,00040</i>	<i>0,00060</i>	<i>0,00080</i>	<i>0,0010</i>	<i>0,0012</i>	<i>0,0016</i>	<i>0,0020</i>	<i>0,0024</i>	<i>0,0030</i>	<i>0,0034</i>	2625 (2300 – 2900)
	N2	E	0.0300	0.80	0.0050	0.010	0.015	0.020	0.025	0.030	0.040	0.050	0.060	0.075	0.085	510 (450 – 570)
			<i>0,0300</i>	<i>0,80</i>	<i>0,00020</i>	<i>0,00040</i>	<i>0,00060</i>	<i>0,00080</i>	<i>0,0010</i>	<i>0,0012</i>	<i>0,0016</i>	<i>0,0020</i>	<i>0,0024</i>	<i>0,0030</i>	<i>0,0034</i>	1675 (1500 – 1800)
	N3	E	0.0300	0.80	0.0050	0.010	0.015	0.020	0.025	0.030	0.040	0.050	0.060	0.075	0.085	345 (300 – 380)
			<i>0,0300</i>	<i>0,80</i>	<i>0,00020</i>	<i>0,00040</i>	<i>0,00060</i>	<i>0,00080</i>	<i>0,0010</i>	<i>0,0012</i>	<i>0,0016</i>	<i>0,0020</i>	<i>0,0024</i>	<i>0,0030</i>	<i>0,0034</i>	1125 (990 – 1200)
	N11	E	0.0300	0.80	0.0040	0.0080	0.012	0.016	0.020	0.024	0.032	0.040	0.046	0.060	0.070	400 (350 – 450)
			<i>0,0300</i>	<i>0,80</i>	<i>0,00016</i>	<i>0,00032</i>	<i>0,00048</i>	<i>0,00065</i>	<i>0,00080</i>	<i>0,00095</i>	<i>0,0013</i>	<i>0,0016</i>	<i>0,0018</i>	<i>0,0024</i>	<i>0,0028</i>	1300 (1200 – 1400)
	S1	E	0.0300	0.80	0.0030	0.0060	0.0090	0.012	0.015	0.018	0.024	0.030	0.036	0.044	0.050	100 (90 – 110)
			<i>0,0300</i>	<i>0,80</i>	<i>0,00012</i>	<i>0,00024</i>	<i>0,00036</i>	<i>0,00048</i>	<i>0,00060</i>	<i>0,00070</i>	<i>0,00095</i>	<i>0,0012</i>	<i>0,0014</i>	<i>0,0017</i>	<i>0,0020</i>	330 (300 – 360)
S2	E	0.0300	0.80	0.0030	0.0060	0.0090	0.012	0.015	0.018	0.024	0.030	0.036	0.044	0.050	80 (73 – 88)	
		<i>0,0300</i>	<i>0,80</i>	<i>0,00012</i>	<i>0,00024</i>	<i>0,00036</i>	<i>0,00048</i>	<i>0,00060</i>	<i>0,00070</i>	<i>0,00095</i>	<i>0,0012</i>	<i>0,0014</i>	<i>0,0017</i>	<i>0,0020</i>	260 (240 – 280)	
S11	E	0.0300	0.80	0.0030	0.0060	0.0090	0.012	0.015	0.018	0.024	0.030	0.036	0.044	0.050	130 (120 – 140)	
		<i>0,0300</i>	<i>0,80</i>	<i>0,00012</i>	<i>0,00024</i>	<i>0,00036</i>	<i>0,00048</i>	<i>0,00060</i>	<i>0,00070</i>	<i>0,00095</i>	<i>0,0012</i>	<i>0,0014</i>	<i>0,0017</i>	<i>0,0020</i>	425 (400 – 450)	
S12	E	0.0300	0.80	0.0030	0.0060	0.0090	0.012	0.015	0.018	0.024	0.030	0.036	0.044	0.050	100 (91 – 110)	
		<i>0,0300</i>	<i>0,80</i>	<i>0,00012</i>	<i>0,00024</i>	<i>0,00036</i>	<i>0,00048</i>	<i>0,00060</i>	<i>0,00070</i>	<i>0,00095</i>	<i>0,0012</i>	<i>0,0014</i>	<i>0,0017</i>	<i>0,0020</i>	330 (300 – 360)	
S13	E	0.0300	0.80	0.0026	0.0050	0.0080	0.011	0.013	0.016	0.022	0.026	0.030	0.038	0.044	80 (70 – 85)	
		<i>0,0300</i>	<i>0,80</i>	<i>0,00010</i>	<i>0,00020</i>	<i>0,00032</i>	<i>0,00044</i>	<i>0,00050</i>	<i>0,00065</i>	<i>0,00085</i>	<i>0,0010</i>	<i>0,0012</i>	<i>0,0015</i>	<i>0,0017</i>	260 (230 – 270)	
Non ferrous	TS1	A	0.0300	0.80	0.0040	0.0080	0.012	0.016	0.020	0.024	0.032	0.040	0.046	0.060	0.070	800 (760 – 850)
			<i>0,0300</i>	<i>0,80</i>	<i>0,00016</i>	<i>0,00032</i>	<i>0,00048</i>	<i>0,00065</i>	<i>0,00080</i>	<i>0,00095</i>	<i>0,0013</i>	<i>0,0016</i>	<i>0,0018</i>	<i>0,0024</i>	<i>0,0028</i>	2625 (2500 – 2700)
	TP1	A	0.0300	0.80	0.0040	0.0080	0.012	0.016	0.020	0.024	0.032	0.040	0.046	0.060	0.070	800 (760 – 850)
			<i>0,0300</i>	<i>0,80</i>	<i>0,00016</i>	<i>0,00032</i>	<i>0,00048</i>	<i>0,00065</i>	<i>0,00080</i>	<i>0,00095</i>	<i>0,0013</i>	<i>0,0016</i>	<i>0,0018</i>	<i>0,0024</i>	<i>0,0028</i>	2625 (2500 – 2700)
	GR1	A	0.0300	0.80	0.0040	0.0080	0.012	0.016	0.020	0.024	0.032	0.040	0.046	0.060	0.070	800 (760 – 850)
			<i>0,0300</i>	<i>0,80</i>	<i>0,00016</i>	<i>0,00032</i>	<i>0,00048</i>	<i>0,00065</i>	<i>0,00080</i>	<i>0,00095</i>	<i>0,0013</i>	<i>0,0016</i>	<i>0,0018</i>	<i>0,0024</i>	<i>0,0028</i>	2625 (2500 – 2700)

For cutting data recalculations, see pages 556 - 563

SMG = Seco material group
 Coolant = A=air D=dry E=emulsion M=mist spray
 v_c = m/min (sf/min)
 f_z = mm (in/tooth)
 a_p = mm/DC (in/DC) = factor
 a_e = mm/DC (in/DC) = factor
 All cutting data are target values

JS534

High performance – Universal – Ball nose – 4 Flutes – Cylindrical

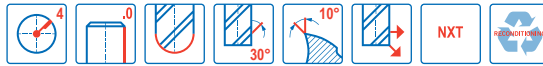
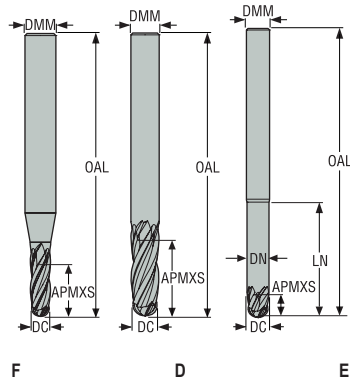

- Tolerances:
- DMM=h5
- DC=e8
- RE= ±0,01 mm
- Regrind possible if DC is ≥Ø6

Designation	Item number	Length index	Tool shape	DC	DMM	APMXS	OAL	LN	DN	RE	PCEDC	Cylindrical
				mm	mm	mm	mm	mm	mm	mm		
JS534020F1B.0Z4-NXT	02928366	1	F	2,0	3,0	6,0	38,0	6,7	2,05	1,0	4	■
JS534030D1B.0Z4-NXT	02928367	1	D	3,0	3,0	9,0	38,0	–	–	1,5	4	■
JS534040F1B.0Z4-NXT	02928368	1	F	4,0	6,0	12,0	57,0	14,0	4,05	2,0	4	■
JS534050F1B.0Z4-NXT	02928370	1	F	5,0	6,0	15,0	57,0	17,0	5,05	2,5	4	■
JS534060D1B.0Z4-NXT	02928372	1	D	6,0	6,0	18,0	57,0	–	–	3,0	4	■
JS534080D1B.0Z4-NXT	02928375	1	D	8,0	8,0	24,0	69,0	–	–	4,0	4	■
JS534100D1B.0Z4-NXT	02928378	1	D	10,0	10,0	30,0	82,0	–	–	5,0	4	■
JS534120D1B.0Z4-NXT	02928381	1	D	12,0	12,0	36,0	100,0	–	–	6,0	4	■
JS534160D1B.0Z4-NXT	02928384	1	D	16,0	16,0	48,0	110,0	–	–	8,0	4	■
JS534200D1B.0Z4-NXT	02928387	1	D	20,0	20,0	60,0	125,0	–	–	10,0	4	■
JS534040F2B.0Z4-NXT	02928369	2	F	4,0	6,0	20,0	63,0	22,0	4,05	2,0	4	■
JS534050F2B.0Z4-NXT	02928371	2	F	5,0	6,0	25,0	75,0	27,0	5,05	2,5	4	■
JS534060D2B.0Z4-NXT	02928373	2	D	6,0	6,0	30,0	75,0	–	–	3,0	4	■
JS534080D2B.0Z4-NXT	02928376	2	D	8,0	8,0	40,0	80,0	–	–	4,0	4	■
JS534100D2B.0Z4-NXT	02928379	2	D	10,0	10,0	50,0	100,0	–	–	5,0	4	■
JS534120D2B.0Z4-NXT	02928382	2	D	12,0	12,0	60,0	125,0	–	–	6,0	4	■
JS534160D2B.0Z4-NXT	02928385	2	D	16,0	16,0	80,0	130,0	–	–	8,0	4	■
JS534060E3B.0Z4-NXT	02928374	3	E	6,0	6,0	6,0	75,0	30,0	5,7	3,0	4	■
JS534080E3B.0Z4-NXT	02928377	3	E	8,0	8,0	8,0	80,0	40,0	7,6	4,0	4	■
JS534100E3B.0Z4-NXT	02928380	3	E	10,0	10,0	10,0	100,0	50,0	9,7	5,0	4	■
JS534120E3B.0Z4-NXT	02928383	3	E	12,0	12,0	12,0	125,0	60,0	11,4	6,0	4	■
JS534160E3B.0Z4-NXT	02928386	3	E	16,0	16,0	16,0	130,0	80,0	15,2	8,0	4	■
JS534200E3B.0Z4-NXT	02928388	3	E	20,0	20,0	20,0	150,0	100,0	19,0	10,0	4	■

■ Stocked standard.

Universal

Steel and cast iron

Stainless steel and S-materials

Non ferrous

Hard

Plastic and CFRP

Graphite

X-Heads

Minimaster Plus

Minimaster

JS534

High performance – Universal – Ball nose – 4 Flutes – Weldon

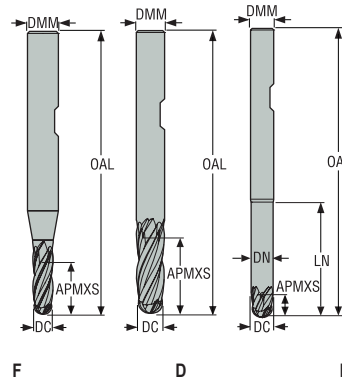

- Tolerances:
- DMM=h5
- DC=e8
- RE= ±0,01 mm
- Regrind possible if DC is ≥Ø6

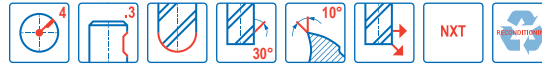

Designation	Item number	Length index	Tool shape	DC	DMM	APMXS	OAL	LN	DN	RE	PCEDC	Weldon
				mm	mm	mm	mm	mm	mm	mm		
JS534040F1B.3Z4-NXT	02928390	1	F	4,0	6,0	12,0	57,0	14,0	4,05	2,0	4	<input type="checkbox"/>
JS534050F1B.3Z4-NXT	02928392	1	F	5,0	6,0	15,0	57,0	17,0	5,05	2,5	4	<input type="checkbox"/>
JS534060D1B.3Z4-NXT	02928394	1	D	6,0	6,0	18,0	57,0	-	-	3,0	4	<input type="checkbox"/>
JS534080D1B.3Z4-NXT	02928397	1	D	8,0	8,0	24,0	69,0	-	-	4,0	4	<input type="checkbox"/>
JS534100D1B.3Z4-NXT	02928400	1	D	10,0	10,0	30,0	82,0	-	-	5,0	4	<input type="checkbox"/>
JS534120D1B.3Z4-NXT	02928403	1	D	12,0	12,0	36,0	100,0	-	-	6,0	4	<input type="checkbox"/>
JS534160D1B.3Z4-NXT	02928406	1	D	16,0	16,0	48,0	110,0	-	-	8,0	4	<input type="checkbox"/>
JS534200D1B.3Z4-NXT	02928409	1	D	20,0	20,0	60,0	125,0	-	-	10,0	4	<input type="checkbox"/>
JS534040F2B.3Z4-NXT	02928391	2	F	4,0	6,0	20,0	63,0	22,0	4,05	2,0	4	<input type="checkbox"/>
JS534050F2B.3Z4-NXT	02928393	2	F	5,0	6,0	25,0	75,0	27,0	5,05	2,5	4	<input type="checkbox"/>
JS534060D2B.3Z4-NXT	02928395	2	D	6,0	6,0	30,0	75,0	-	-	3,0	4	<input type="checkbox"/>
JS534080D2B.3Z4-NXT	02928398	2	D	8,0	8,0	40,0	80,0	-	-	4,0	4	<input type="checkbox"/>
JS534100D2B.3Z4-NXT	02928401	2	D	10,0	10,0	50,0	100,0	-	-	5,0	4	<input type="checkbox"/>
JS534120D2B.3Z4-NXT	02928404	2	D	12,0	12,0	60,0	125,0	-	-	6,0	4	<input type="checkbox"/>
JS534160D2B.3Z4-NXT	02928407	2	D	16,0	16,0	80,0	130,0	-	-	8,0	4	<input type="checkbox"/>
JS534060E3B.3Z4-NXT	02928396	3	E	6,0	6,0	6,0	75,0	30,0	5,7	3,0	4	<input type="checkbox"/>
JS534080E3B.3Z4-NXT	02928399	3	E	8,0	8,0	8,0	80,0	40,0	7,6	4,0	4	<input type="checkbox"/>
JS534100E3B.3Z4-NXT	02928402	3	E	10,0	10,0	10,0	100,0	50,0	9,7	5,0	4	<input type="checkbox"/>
JS534120E3B.3Z4-NXT	02928405	3	E	12,0	12,0	12,0	125,0	60,0	11,4	6,0	4	<input type="checkbox"/>
JS534160E3B.3Z4-NXT	02928408	3	E	16,0	16,0	16,0	130,0	80,0	15,2	8,0	4	<input type="checkbox"/>
JS534200E3B.3Z4-NXT	02928410	3	E	20,0	20,0	20,0	150,0	100,0	19,0	10,0	4	<input type="checkbox"/>

Weldon available. Delivery time is 3 days.

Universal

Steel and cast iron

Stainless steel and S-materials

Non ferrous

Hard

Plastic and CFRP

Graphite

X-Heads

Minimaster Plus

Minimaster

Cutting data – JS534 Copy milling roughing

SMG		a _e /DC	a _p /DC	f _z										v _c
				2	3	4	5	6	8	10	12	16	20	
P1	M/A/D/E	0.0300	4.0	0.0085	0.013	0.017	0.022	0.026	0.034	0.044	0.050	0.065	0.075	345 (310 – 370)
		0,0300	4,0	0,00034	0,00050	0,00065	0,00085	0,0010	0,0013	0,0017	0,0020	0,0026	0,0030	1125 (1100 – 1200)
P2	M/A/D/E	0.0300	4.0	0.0090	0.013	0.018	0.022	0.026	0.036	0.044	0.050	0.065	0.075	335 (300 – 360)
		0,0300	4,0	0,00036	0,00050	0,00070	0,00085	0,0010	0,0014	0,0017	0,0020	0,0026	0,0030	1100 (990 – 1100)
P3	M/A/D/E	0.0300	4.0	0.0085	0.012	0.017	0.020	0.025	0.034	0.042	0.050	0.060	0.070	290 (260 – 310)
		0,0300	4,0	0,00034	0,00048	0,00065	0,00080	0,0010	0,0013	0,0017	0,0020	0,0024	0,0028	950 (860 – 1000)
P4	M/A/D/E	0.0300	4.0	0.0080	0.012	0.016	0.020	0.024	0.032	0.040	0.048	0.060	0.070	255 (230 – 280)
		0,0300	4,0	0,00032	0,00048	0,00065	0,00080	0,00095	0,0013	0,0016	0,0019	0,0024	0,0028	840 (760 – 910)
P5	M/A/D/E	0.0300	4.0	0.0080	0.012	0.016	0.020	0.024	0.032	0.040	0.048	0.060	0.070	245 (220 – 260)
		0,0300	4,0	0,00032	0,00048	0,00065	0,00080	0,00095	0,0013	0,0016	0,0019	0,0024	0,0028	800 (730 – 850)
P6	M/A/D/E	0.0300	4.0	0.0080	0.012	0.016	0.020	0.024	0.032	0.040	0.046	0.060	0.065	230 (210 – 250)
		0,0300	4,0	0,00032	0,00048	0,00065	0,00080	0,00095	0,0013	0,0016	0,0018	0,0024	0,0026	750 (690 – 820)
P7	M/A/D/E	0.0300	4.0	0.0080	0.012	0.016	0.020	0.024	0.032	0.040	0.046	0.060	0.065	220 (200 – 240)
		0,0300	4,0	0,00032	0,00048	0,00065	0,00080	0,00095	0,0013	0,0016	0,0018	0,0024	0,0026	720 (660 – 780)
P8	M/A/D/E	0.0300	4.0	0.0085	0.012	0.017	0.020	0.025	0.034	0.042	0.050	0.060	0.070	205 (190 – 220)
		0,0300	4,0	0,00034	0,00048	0,00065	0,00080	0,0010	0,0013	0,0017	0,0020	0,0024	0,0028	670 (630 – 720)
P11	M/A/D/E	0.0300	4.0	0.010	0.015	0.020	0.025	0.030	0.040	0.050	0.060	0.080	0.10	210 (190 – 230)
		0,0300	4,0	0,00040	0,00060	0,00080	0,0010	0,0012	0,0016	0,0020	0,0024	0,0032	0,0040	690 (630 – 750)
P12	M/A/D/E	0.0300	4.0	0.0080	0.012	0.016	0.020	0.024	0.032	0.040	0.048	0.060	0.070	125 (120 – 130)
		0,0300	4,0	0,00032	0,00048	0,00065	0,00080	0,00095	0,0013	0,0016	0,0019	0,0024	0,0028	410 (400 – 420)
M1	E	0.0300	4.0	0.0090	0.013	0.018	0.022	0.026	0.036	0.044	0.050	0.065	0.075	180 (160 – 200)
		0,0300	4,0	0,00036	0,00050	0,00070	0,00085	0,0010	0,0014	0,0017	0,0020	0,0026	0,0030	590 (530 – 650)
M2	E	0.0300	4.0	0.0080	0.012	0.016	0.020	0.024	0.032	0.040	0.048	0.060	0.070	145 (130 – 160)
		0,0300	4,0	0,00032	0,00048	0,00065	0,00080	0,00095	0,0013	0,0016	0,0019	0,0024	0,0028	475 (430 – 520)
M3	E	0.0300	4.0	0.0080	0.012	0.016	0.020	0.024	0.032	0.040	0.048	0.060	0.070	155 (140 – 180)
		0,0300	4,0	0,00032	0,00048	0,00065	0,00080	0,00095	0,0013	0,0016	0,0019	0,0024	0,0028	510 (460 – 590)
M4	E	0.0300	4.0	0.0070	0.010	0.014	0.017	0.020	0.028	0.034	0.042	0.050	0.060	120 (100 – 130)
		0,0300	4,0	0,00028	0,00040	0,00055	0,00065	0,00080	0,0011	0,0013	0,0017	0,0020	0,0024	395 (330 – 420)
M5	E	0.0300	4.0	0.0070	0.010	0.014	0.017	0.020	0.028	0.034	0.042	0.050	0.060	100 (83 – 110)
		0,0300	4,0	0,00028	0,00040	0,00055	0,00065	0,00080	0,0011	0,0013	0,0017	0,0020	0,0024	330 (280 – 360)
K1	E	0.0300	4.0	0.0080	0.012	0.016	0.020	0.024	0.032	0.040	0.048	0.060	0.070	245 (220 – 260)
		0,0300	4,0	0,00032	0,00048	0,00065	0,00080	0,00095	0,0013	0,0016	0,0019	0,0024	0,0028	800 (730 – 850)
K2	E	0.0300	4.0	0.0075	0.011	0.015	0.018	0.022	0.030	0.036	0.042	0.055	0.060	215 (200 – 230)
		0,0300	4,0	0,00030	0,00044	0,00060	0,00070	0,00085	0,0012	0,0014	0,0017	0,0022	0,0024	710 (660 – 750)
K3	E	0.0300	4.0	0.0080	0.012	0.016	0.020	0.024	0.032	0.040	0.048	0.060	0.070	180 (160 – 190)
		0,0300	4,0	0,00032	0,00048	0,00065	0,00080	0,00095	0,0013	0,0016	0,0019	0,0024	0,0028	590 (530 – 620)
K4	E	0.0300	4.0	0.0080	0.012	0.016	0.020	0.024	0.032	0.040	0.048	0.060	0.070	170 (160 – 180)
		0,0300	4,0	0,00032	0,00048	0,00065	0,00080	0,00095	0,0013	0,0016	0,0019	0,0024	0,0028	560 (530 – 590)
K5	E	0.0300	4.0	0.0070	0.011	0.014	0.018	0.022	0.028	0.036	0.042	0.055	0.060	200 (180 – 220)
		0,0300	4,0	0,00028	0,00044	0,00055	0,00070	0,00085	0,0011	0,0014	0,0017	0,0022	0,0024	660 (600 – 720)
K6	E	0.0300	4.0	0.0080	0.012	0.016	0.020	0.024	0.032	0.040	0.048	0.060	0.070	295 (260 – 330)
		0,0300	4,0	0,00032	0,00048	0,00065	0,00080	0,00095	0,0013	0,0016	0,0019	0,0024	0,0028	970 (860 – 1000)
K7	E	0.0300	4.0	0.0070	0.011	0.014	0.018	0.022	0.028	0.036	0.042	0.055	0.060	260 (230 – 280)
		0,0300	4,0	0,00028	0,00044	0,00055	0,00070	0,00085	0,0011	0,0014	0,0017	0,0022	0,0024	850 (760 – 910)

For cutting data recalculations, see pages 556 - 563

SMG = Seco material group
 Coolant = A=air D=dry E=emulsion M=mist spray
 v_c = m/min (sf/min)
 f_z = mm (in/tooth)
 a_p = mm/DC (in/DC) = factor
 a_e = mm/DC (in/DC) = factor
 All cutting data are target values

Universal
Steel and cast iron
Stainless steel and S-materials
Non ferrous
Hard
Plastic and CFRP
Graphite
X-Heads
Minimaster Plus
Minimaster

Cutting data – JS534 Copy milling roughing

Universal	SMG	Coolant	a _e /DC	a _p /DC	f _z										v _c	
					2	3	4	5	6	8	10	12	16	20		
Steel and cast iron	N1	E	0.0300	4.0	0.0080	0.012	0.016	0.020	0.024	0.032	0.040	0.048	0.060	0.070	1025 (910 – 1100)	
			0,0300	4,0	0,00032	0,00048	0,00065	0,00080	0,00095	0,0013	0,0016	0,0019	0,0024	0,0028	3375 (3000 – 3600)	
	N2	E	0.0300	4.0	0.0080	0.012	0.016	0.020	0.024	0.032	0.040	0.048	0.060	0.070	910 (780 – 1000)	
			0,0300	4,0	0,00032	0,00048	0,00065	0,00080	0,00095	0,0013	0,0016	0,0019	0,0024	0,0028	2975 (2600 – 3200)	
	N3	E	0.0300	4.0	0.0080	0.012	0.016	0.020	0.024	0.032	0.040	0.048	0.060	0.070	600 (520 – 690)	
			0,0300	4,0	0,00032	0,00048	0,00065	0,00080	0,00095	0,0013	0,0016	0,0019	0,0024	0,0028	1975 (1800 – 2200)	
	N11	E	0.0300	4.0	0.0080	0.012	0.016	0.020	0.024	0.032	0.040	0.048	0.060	0.070	500 (440 – 560)	
			0,0300	4,0	0,00032	0,00048	0,00065	0,00080	0,00095	0,0013	0,0016	0,0019	0,0024	0,0028	1650 (1500 – 1800)	
	Stainless steel and S-materials	S1	E	0.0300	4.0	0.0080	0.012	0.016	0.020	0.024	0.032	0.040	0.048	0.060	0.070	110 (88 – 110)
				0,0300	4,0	0,00032	0,00048	0,00065	0,00080	0,00095	0,0013	0,0016	0,0019	0,0024	0,0028	360 (290 – 360)
		S2	E	0.0300	4.0	0.0080	0.012	0.016	0.020	0.024	0.032	0.040	0.048	0.060	0.070	90 (71 – 90)
				0,0300	4,0	0,00032	0,00048	0,00065	0,00080	0,00095	0,0013	0,0016	0,0019	0,0024	0,0028	295 (240 – 290)
S3		E	0.0300	4.0	0.0080	0.012	0.016	0.020	0.024	0.032	0.040	0.048	0.060	0.070	85 (63 – 87)	
			0,0300	4,0	0,00032	0,00048	0,00065	0,00080	0,00095	0,0013	0,0016	0,0019	0,0024	0,0028	280 (210 – 280)	
S11		E	0.0300	4.0	0.0080	0.012	0.016	0.020	0.024	0.032	0.040	0.048	0.060	0.070	185 (150 – 180)	
			0,0300	4,0	0,00032	0,00048	0,00065	0,00080	0,00095	0,0013	0,0016	0,0019	0,0024	0,0028	610 (500 – 590)	
S12		E	0.0300	4.0	0.0080	0.012	0.016	0.020	0.024	0.032	0.040	0.048	0.060	0.070	140 (120 – 140)	
			0,0300	4,0	0,00032	0,00048	0,00065	0,00080	0,00095	0,0013	0,0016	0,0019	0,0024	0,0028	460 (400 – 450)	
S13		E	0.0300	4.0	0.0070	0.010	0.014	0.017	0.020	0.028	0.034	0.042	0.050	0.060	110 (91 – 110)	
			0,0300	4,0	0,00028	0,00040	0,00055	0,00065	0,00080	0,0011	0,0013	0,0017	0,0020	0,0024	360 (300 – 360)	
Non ferrous	TS1	A	0.0300	4.0	0.0080	0.012	0.016	0.020	0.024	0.032	0.040	0.048	0.060	0.070	900 (840 – 960)	
			0,0300	4,0	0,00032	0,00048	0,00065	0,00080	0,00095	0,0013	0,0016	0,0019	0,0024	0,0028	2950 (2800 – 3100)	
	TP1	A	0.0300	4.0	0.0080	0.012	0.016	0.020	0.024	0.032	0.040	0.048	0.060	0.070	900 (840 – 960)	
			0,0300	4,0	0,00032	0,00048	0,00065	0,00080	0,00095	0,0013	0,0016	0,0019	0,0024	0,0028	2950 (2800 – 3100)	
	GR1	A	0.0300	4.0	0.0080	0.012	0.016	0.020	0.024	0.032	0.040	0.048	0.060	0.070	900 (840 – 960)	
			0,0300	4,0	0,00032	0,00048	0,00065	0,00080	0,00095	0,0013	0,0016	0,0019	0,0024	0,0028	2950 (2800 – 3100)	

For cutting data recalculations, see pages 556 - 563

SMG = Seco material group
Coolant = A=air D=dry E=emulsion M=mist spray
v_c = m/min (sf/min)
f_z = mm (in/tooth)
a_p = mm/DC (in/DC) = factor
a_e = mm/DC (in/DC) = factor
All cutting data are target values

JS506

General purpose – Universal – Chamfer – 3-4 Flutes – Cylindrical

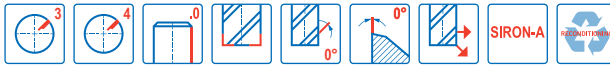
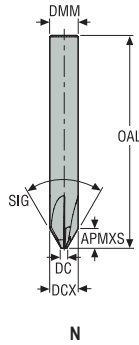

- Tolerances:
- DMM=h5
- SIG= ±0,5°
- Regrind possible if DMM is ≥Ø6

Designation	Item number	Length index	Tool shape	DC	DCX	DMM	APMXS	OAL	SIG°	PCEDC	Cylindrical
				mm	mm	mm	mm	mm			
JS506030N2CZ3.0-SIRA	02881622	2	N	0,6	3,0	3,0	2,0	50,0	60,0	3	■
JS506040N2CZ3.0-SIRA	02881623	2	N	0,8	4,0	4,0	2,7	50,0	60,0	3	■
JS506060N2CZ4.0-SIRA	02881624	2	N	1,2	6,0	6,0	4,1	57,0	60,0	4	■
JS506080N2CZ4.0-SIRA	02881626	2	N	1,6	8,0	8,0	5,5	63,0	60,0	4	■
JS506100N2CZ4.0-SIRA	02881628	2	N	2,0	10,0	10,0	6,9	72,0	60,0	4	■
JS506120N2CZ4.0-SIRA	02881630	2	N	2,4	12,0	12,0	8,3	83,0	60,0	4	■

■ Stocked standard.

Universal

Steel and cast iron

Stainless steel and S-materials

Non ferrous

Hard

Plastic and CFRP

Graphite

X-Heads

Minimaster Plus

Minimaster

JS506

General purpose – Universal – Chamfer – 3-4 Flutes – Weldon

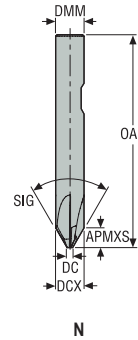

- Tolerances:
- DMM=h5
- SIG= ±0,5°
- Regrind possible

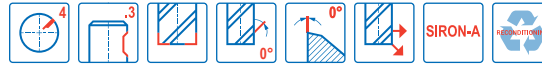

Designation	Item number	Length index	Tool shape	DC	DCX	DMM	APMXS	OAL	SIG°	PCEDC	Weldon
				mm	mm	mm	mm	mm			
JS506060N2CZ4.3-SIRA	02881625	2	N	1,2	6,0	6,0	4,1	57,0	60,0	4	■
JS506080N2CZ4.3-SIRA	02881627	2	N	1,6	8,0	8,0	5,5	63,0	60,0	4	■
JS506100N2CZ4.3-SIRA	02881629	2	N	2,0	10,0	10,0	6,9	72,0	60,0	4	■
JS506120N2CZ4.3-SIRA	02881631	2	N	2,4	12,0	12,0	8,3	83,0	60,0	4	■

■ Stocked standard.

Universal

Steel and cast iron

Stainless steel and S-materials

Non ferrous

Hard

Plastic and CFRP

Graphite

X-Heads

Minimaster Plus

Minimaster

Cutting data – JS506 Chamfering

SMG		a _e /DC	a _p /DC	f _z						v _c
				3	4	6	8	10	12	
P1	M/A/D/E	0.100	0.55	0.022	0.028	0.042	0.055	0.070	0.080	200 (180 – 220)
		0,100	0,55	0,00085	0,0011	0,0017	0,0022	0,0028	0,0032	660 (600 – 720)
P2	M/A/D/E	0.100	0.55	0.022	0.028	0.042	0.055	0.070	0.085	195 (180 – 220)
		0,100	0,55	0,00085	0,0011	0,0017	0,0022	0,0028	0,0034	640 (600 – 720)
P3	M/A/D/E	0.100	0.55	0.020	0.026	0.040	0.055	0.065	0.080	170 (150 – 190)
		0,100	0,55	0,00080	0,0010	0,0016	0,0022	0,0026	0,0032	560 (500 – 620)
P4	M/A/D/E	0.100	0.55	0.020	0.026	0.040	0.055	0.065	0.080	150 (130 – 160)
		0,100	0,55	0,00080	0,0010	0,0016	0,0022	0,0026	0,0032	490 (430 – 520)
P5	M/A/D/E	0.100	0.55	0.019	0.026	0.038	0.050	0.065	0.075	140 (130 – 160)
		0,100	0,55	0,00075	0,0010	0,0015	0,0020	0,0026	0,0030	460 (430 – 520)
P6	M/A/D/E	0.100	0.55	0.019	0.025	0.038	0.050	0.065	0.075	160 (140 – 180)
		0,100	0,55	0,00075	0,0010	0,0015	0,0020	0,0026	0,0030	520 (460 – 590)
P7	M/A/D/E	0.100	0.55	0.019	0.025	0.038	0.050	0.065	0.075	150 (140 – 170)
		0,100	0,55	0,00075	0,0010	0,0015	0,0020	0,0026	0,0030	490 (460 – 550)
P8	M/A/D/E	0.100	0.55	0.020	0.026	0.040	0.055	0.065	0.080	140 (130 – 160)
		0,100	0,55	0,00080	0,0010	0,0016	0,0022	0,0026	0,0032	460 (430 – 520)
P11	M/A/D/E	0.100	0.55	0.019	0.025	0.038	0.050	0.065	0.075	145 (130 – 160)
		0,100	0,55	0,00075	0,0010	0,0015	0,0020	0,0026	0,0030	475 (430 – 520)
P12	M/A/D/E	0.100	0.55	0.013	0.017	0.026	0.034	0.044	0.050	85 (75 – 97)
		0,100	0,55	0,00050	0,00065	0,0010	0,0013	0,0017	0,0020	280 (250 – 310)
M1	E/M/A	0.100	0.55	0.022	0.028	0.042	0.055	0.070	0.085	120 (95 – 140)
		0,100	0,55	0,00085	0,0011	0,0017	0,0022	0,0028	0,0034	395 (320 – 450)
M2	E/M/A	0.100	0.55	0.019	0.026	0.038	0.050	0.065	0.075	95 (76 – 110)
		0,100	0,55	0,00075	0,0010	0,0015	0,0020	0,0026	0,0030	310 (250 – 360)
M3	E/M/A	0.100	0.55	0.019	0.026	0.038	0.050	0.065	0.075	60 (43 – 80)
		0,100	0,55	0,00075	0,0010	0,0015	0,0020	0,0026	0,0030	195 (150 – 260)
M4	E/M/A	0.100	0.55	0.017	0.022	0.034	0.046	0.055	0.065	46 (33 – 60)
		0,100	0,55	0,00065	0,00085	0,0013	0,0018	0,0022	0,0026	150 (110 – 190)
M5	E/M/A	0.100	0.55	0.017	0.022	0.034	0.046	0.055	0.065	39 (27 – 50)
		0,100	0,55	0,00065	0,00085	0,0013	0,0018	0,0022	0,0026	130 (89 – 160)
K1	A/D/M/E	0.100	0.55	0.022	0.028	0.042	0.055	0.070	0.085	200 (180 – 220)
		0,100	0,55	0,00085	0,0011	0,0017	0,0022	0,0028	0,0034	660 (600 – 720)
K2	A/D/M/E	0.100	0.55	0.019	0.026	0.038	0.050	0.065	0.075	170 (150 – 190)
		0,100	0,55	0,00075	0,0010	0,0015	0,0020	0,0026	0,0030	560 (500 – 620)
K3	A/D/M/E	0.100	0.55	0.019	0.026	0.038	0.050	0.065	0.075	145 (130 – 160)
		0,100	0,55	0,00075	0,0010	0,0015	0,0020	0,0026	0,0030	475 (430 – 520)
K4	A/D/M/E	0.100	0.55	0.019	0.026	0.038	0.050	0.065	0.075	140 (130 – 150)
		0,100	0,55	0,00075	0,0010	0,0015	0,0020	0,0026	0,0030	460 (430 – 490)
K5	A/D/M/E	0.100	0.55	0.018	0.024	0.034	0.046	0.060	0.070	85 (72 – 93)
		0,100	0,55	0,00070	0,00095	0,0013	0,0018	0,0024	0,0028	280 (240 – 300)
K6	A/D/M/E	0.100	0.55	0.019	0.026	0.038	0.050	0.065	0.075	125 (110 – 130)
		0,100	0,55	0,00075	0,0010	0,0015	0,0020	0,0026	0,0030	410 (370 – 420)
K7	A/D/M/E	0.100	0.55	0.018	0.024	0.034	0.046	0.060	0.070	105 (92 – 120)
		0,100	0,55	0,00070	0,00095	0,0013	0,0018	0,0024	0,0028	345 (310 – 390)

For cutting data recalculations, see pages 556 - 563

SMG = Seco material group
 Coolant = A=air D=dry E=emulsion M=mist spray
 v_c = m/min (sf/min)
 f_z = mm (in/tooth)
 a_p = mm/DC (in/DC) = factor
 a_e = mm/DC (in/DC) = factor
 All cutting data are target values

Universal
Steel and cast iron
Stainless steel and S-materials
Non ferrous
Hard
Plastic and cfrp
Graphite
X-Heads
Minimaster Plus
Minimaster

Cutting data – JS506 Chamfering

SMG	Coolant	a _p /DC	a _e /DC	f _z						v _c
				3	4	6	8	10	12	
N1	E/M/A	0.100	0.55	0.019	0.026	0.038	0.050	0.065	0.075	475 (430 – 520)
		0,100	0,55	0,00075	0,0010	0,0015	0,0020	0,0026	0,0030	1550 (1500 – 1700)
N2	E/M/A	0.100	0.55	0.019	0.026	0.038	0.050	0.065	0.075	305 (280 – 330)
		0,100	0,55	0,00075	0,0010	0,0015	0,0020	0,0026	0,0030	1000 (920 – 1000)
N3	E/M/A	0.100	0.55	0.019	0.026	0.038	0.050	0.065	0.075	205 (190 – 220)
		0,100	0,55	0,00075	0,0010	0,0015	0,0020	0,0026	0,0030	670 (630 – 720)
N11	E/M/A	0.100	0.55	0.019	0.026	0.038	0.050	0.065	0.075	270 (250 – 290)
		0,100	0,55	0,00075	0,0010	0,0015	0,0020	0,0026	0,0030	890 (830 – 950)
S1	E	0.100	0.55	0.020	0.028	0.042	0.055	0.070	0.080	41 (14 – 68)
		0,100	0,55	0,00080	0,0011	0,0017	0,0022	0,0028	0,0032	135 (46 – 220)
S2	E	0.100	0.55	0.020	0.028	0.042	0.055	0.070	0.080	33 (12 – 55)
		0,100	0,55	0,00080	0,0011	0,0017	0,0022	0,0028	0,0032	110 (40 – 180)
S3	E	0.100	0.55	0.019	0.026	0.038	0.050	0.065	0.075	28 (9.5 – 47)
		0,100	0,55	0,00075	0,0010	0,0015	0,0020	0,0026	0,0030	90 (32 – 150)
S11	E	0.100	0.55	0.019	0.026	0.038	0.050	0.065	0.075	95 (68 – 110)
		0,100	0,55	0,00075	0,0010	0,0015	0,0020	0,0026	0,0030	310 (230 – 360)
S12	E	0.100	0.55	0.019	0.026	0.038	0.050	0.065	0.075	70 (53 – 90)
		0,100	0,55	0,00075	0,0010	0,0015	0,0020	0,0026	0,0030	230 (180 – 290)
S13	E	0.100	0.55	0.017	0.022	0.034	0.046	0.055	0.065	55 (41 – 69)
		0,100	0,55	0,00065	0,00085	0,0013	0,0018	0,0022	0,0026	180 (140 – 220)
H5	M/A/D	0.0500	1.5	0.015	0.020	0.030	0.040	0.050	0.060	65 (45 – 83)
		0,0500	1,5	0,00060	0,00080	0,0012	0,0016	0,0020	0,0024	215 (150 – 270)
H8	M/A/D	0.0500	1.5	0.011	0.015	0.022	0.030	0.038	0.044	60 (44 – 81)
		0,0500	1,5	0,00044	0,00060	0,00085	0,0012	0,0015	0,0017	195 (150 – 260)
H11	M/A/D	0.0500	1.5	0.015	0.020	0.030	0.040	0.050	0.060	80 (57 – 100)
		0,0500	1,5	0,00060	0,00080	0,0012	0,0016	0,0020	0,0024	260 (190 – 320)
H12	M/A/D	0.0500	1.5	0.011	0.015	0.022	0.030	0.038	0.044	70 (51 – 94)
		0,0500	1,5	0,00044	0,00060	0,00085	0,0012	0,0015	0,0017	230 (170 – 300)
H21	M/A/D	0.0500	1.5	0.011	0.015	0.022	0.030	0.038	0.044	60 (44 – 81)
		0,0500	1,5	0,00044	0,00060	0,00085	0,0012	0,0015	0,0017	195 (150 – 260)
TS1	A/D	0.100	0.55	0.019	0.026	0.038	0.050	0.065	0.075	475 (430 – 520)
		0,100	0,55	0,00075	0,0010	0,0015	0,0020	0,0026	0,0030	1550 (1500 – 1700)
TP1	A/D	0.100	0.55	0.019	0.026	0.038	0.050	0.065	0.075	475 (430 – 520)
		0,100	0,55	0,00075	0,0010	0,0015	0,0020	0,0026	0,0030	1550 (1500 – 1700)
GR1	A/D	0.100	0.55	0.019	0.026	0.038	0.050	0.065	0.075	475 (430 – 520)
		0,100	0,55	0,00075	0,0010	0,0015	0,0020	0,0026	0,0030	1550 (1500 – 1700)

For cutting data recalculations, see pages 556 - 563

SMG = Seco material group
Coolant = A=air D=dry E=emulsion M=mist spray
v_c = m/min (sf/min)
f_z = mm (in/tooth)
a_p = mm/DC (in/DC) = factor
a_e = mm/DC (in/DC) = factor
All cutting data are target values

JS509

General purpose – Universal – Chamfer – 3-4 Flutes – Cylindrical

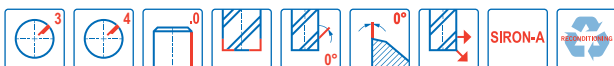
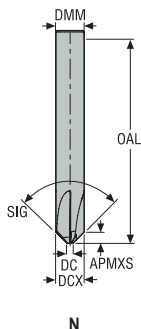

- Tolerances:
- DMM=h5
- SIG= ±0,5°
- Regrind possible if DMM is ≥Ø6

Designation	Item number	Length index	Tool shape	DC	DCX	DMM	APMXS	OAL	SIG°	PCEDC	Cylindrical
				mm	mm	mm	mm	mm			
JS509030N2CZ3.0-SIRA	02881634	2	N	0,6	3,0	3,0	1,2	50,0	90,0	3	■
JS509040N2CZ3.0-SIRA	02881635	2	N	0,8	4,0	4,0	1,6	50,0	90,0	3	■
JS509060N2CZ4.0-SIRA	02881636	2	N	1,2	6,0	6,0	2,4	57,0	90,0	4	■
JS509080N2CZ4.0-SIRA	02881638	2	N	1,6	8,0	8,0	3,2	63,0	90,0	4	■
JS509100N2CZ4.0-SIRA	02881640	2	N	2,0	10,0	10,0	4,0	72,0	90,0	4	■
JS509120N2CZ4.0-SIRA	02881642	2	N	2,4	12,0	12,0	4,8	83,0	90,0	4	■

■ Stocked standard.

Universal

Steel and cast iron

Stainless steel and S-materials

Non ferrous

Hard

Plastic and CFRP

Graphite

X-Heads

Minimaster Plus

Minimaster

JS509

General purpose – Universal – Chamfer – 3-4 Flutes – Weldon

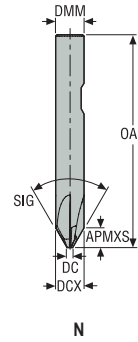

- Tolerances:
- DMM=h5
- SIG= ±0,5°
- Regrind possible

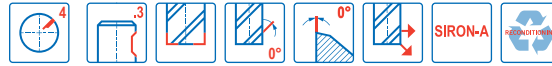

Designation	Item number	Length index	Tool shape	DC	DCX	DMM	APMXS	OAL	SIG°	PCEDC	Weldon
				mm	mm	mm	mm	mm			
JS509060N2CZ4.3-SIRA	02881637	2	N	1,2	6,0	6,0	2,4	57,0	90,0	4	■
JS509080N2CZ4.3-SIRA	02881639	2	N	1,6	8,0	8,0	3,2	63,0	90,0	4	■
JS509100N2CZ4.3-SIRA	02881641	2	N	2,0	10,0	10,0	4,0	72,0	90,0	4	■
JS509120N2CZ4.3-SIRA	02881643	2	N	2,4	12,0	12,0	4,8	83,0	90,0	4	■

■ Stocked standard.

Universal

Steel and cast iron

Stainless steel and S-materials

Non ferrous

Hard

Plastic and CFRP

Graphite

X-Heads

Minimaster Plus

Minimaster

Cutting data – JS509 Chamfering

SMG		a _e /DC	a _p /DC	f _z						v _c
				3	4	6	8	10	12	
P1	M/A/D/E	0.100	0.55	0.034	0.044	0.065	0.090	0.11	0.13	380 (340 – 430)
		0,100	0,55	0,0013	0,0017	0,0026	0,0036	0,0044	0,0050	1250 (1200 – 1400)
P2	M/A/D/E	0.100	0.55	0.034	0.044	0.065	0.090	0.11	0.13	370 (330 – 420)
		0,100	0,55	0,0013	0,0017	0,0026	0,0036	0,0044	0,0050	1225 (1100 – 1300)
P3	M/A/D/E	0.100	0.55	0.032	0.042	0.065	0.085	0.11	0.12	320 (280 – 360)
		0,100	0,55	0,0013	0,0017	0,0026	0,0034	0,0044	0,0048	1050 (920 – 1100)
P4	M/A/D/E	0.100	0.55	0.032	0.042	0.060	0.085	0.10	0.12	280 (250 – 310)
		0,100	0,55	0,0013	0,0017	0,0024	0,0034	0,0040	0,0048	920 (830 – 1000)
P5	M/A/D/E	0.100	0.55	0.030	0.040	0.060	0.085	0.10	0.12	270 (240 – 300)
		0,100	0,55	0,0012	0,0016	0,0024	0,0034	0,0040	0,0048	890 (790 – 980)
P6	M/A/D/E	0.100	0.55	0.030	0.040	0.060	0.080	0.10	0.12	305 (270 – 340)
		0,100	0,55	0,0012	0,0016	0,0024	0,0032	0,0040	0,0048	1000 (890 – 1100)
P7	M/A/D/E	0.100	0.55	0.030	0.040	0.060	0.080	0.10	0.12	285 (250 – 320)
		0,100	0,55	0,0012	0,0016	0,0024	0,0032	0,0040	0,0048	940 (830 – 1000)
P8	M/A/D/E	0.100	0.55	0.032	0.042	0.065	0.085	0.11	0.12	270 (240 – 300)
		0,100	0,55	0,0013	0,0017	0,0026	0,0034	0,0044	0,0048	890 (790 – 980)
P11	M/A/D/E	0.100	0.55	0.030	0.040	0.060	0.080	0.10	0.12	280 (250 – 310)
		0,100	0,55	0,0012	0,0016	0,0024	0,0032	0,0040	0,0048	920 (830 – 1000)
P12	M/A/D/E	0.100	0.55	0.020	0.028	0.042	0.055	0.070	0.080	165 (150 – 180)
		0,100	0,55	0,00080	0,0011	0,0017	0,0022	0,0028	0,0032	540 (500 – 590)
M1	E/M/A	0.100	0.55	0.034	0.044	0.065	0.090	0.11	0.13	220 (180 – 260)
		0,100	0,55	0,0013	0,0017	0,0026	0,0036	0,0044	0,0050	720 (600 – 850)
M2	E/M/A	0.100	0.55	0.030	0.040	0.060	0.085	0.10	0.12	180 (150 – 210)
		0,100	0,55	0,0012	0,0016	0,0024	0,0034	0,0040	0,0048	590 (500 – 680)
M3	E/M/A	0.100	0.55	0.030	0.040	0.060	0.085	0.10	0.12	115 (81 – 150)
		0,100	0,55	0,0012	0,0016	0,0024	0,0034	0,0040	0,0048	375 (270 – 490)
M4	E/M/A	0.100	0.55	0.026	0.036	0.055	0.070	0.090	0.10	90 (61 – 110)
		0,100	0,55	0,0010	0,0014	0,0022	0,0028	0,0036	0,0040	295 (210 – 360)
M5	E/M/A	0.100	0.55	0.026	0.036	0.055	0.070	0.090	0.10	75 (51 – 95)
		0,100	0,55	0,0010	0,0014	0,0022	0,0028	0,0036	0,0040	245 (170 – 310)
K1	A/D/M/E	0.100	0.55	0.034	0.044	0.065	0.090	0.11	0.13	375 (330 – 420)
		0,100	0,55	0,0013	0,0017	0,0026	0,0036	0,0044	0,0050	1225 (1100 – 1300)
K2	A/D/M/E	0.100	0.55	0.030	0.040	0.060	0.085	0.10	0.12	325 (290 – 360)
		0,100	0,55	0,0012	0,0016	0,0024	0,0034	0,0040	0,0048	1075 (960 – 1100)
K3	A/D/M/E	0.100	0.55	0.030	0.040	0.060	0.085	0.10	0.12	275 (240 – 310)
		0,100	0,55	0,0012	0,0016	0,0024	0,0034	0,0040	0,0048	900 (790 – 1000)
K4	A/D/M/E	0.100	0.55	0.030	0.040	0.060	0.085	0.10	0.12	265 (230 – 290)
		0,100	0,55	0,0012	0,0016	0,0024	0,0034	0,0040	0,0048	870 (760 – 950)
K5	A/D/M/E	0.100	0.55	0.028	0.036	0.055	0.075	0.090	0.11	155 (140 – 170)
		0,100	0,55	0,0011	0,0014	0,0022	0,0030	0,0036	0,0044	510 (460 – 550)
K6	A/D/M/E	0.100	0.55	0.030	0.040	0.060	0.085	0.10	0.12	230 (210 – 260)
		0,100	0,55	0,0012	0,0016	0,0024	0,0034	0,0040	0,0048	750 (690 – 850)
K7	A/D/M/E	0.100	0.55	0.028	0.036	0.055	0.075	0.090	0.11	200 (180 – 220)
		0,100	0,55	0,0011	0,0014	0,0022	0,0030	0,0036	0,0044	660 (600 – 720)

For cutting data recalculations, see pages 556 - 563

SMG = Seco material group
Coolant = A=air D=dry E=emulsion M=mist spray
v_c = m/min (sf/min)
f_z = mm (in/tooth)
a_p = mm/DC (in/DC) = factor
a_e = mm/DC (in/DC) = factor
All cutting data are target values

Universal
Steel and cast iron
Stainless steel and S-materials
Non ferrous
Hard
Plastic and CFRP
Graphite
X-Heads
Minimaster Plus
Minimaster

Cutting data – JS509 Chamfering

Universal	SMG	Coolant	a _p /DC	a _e /DC	f _z						v _c
					3	4	6	8	10	12	
Steel and cast iron	N1	E/M/A	0.100	0.55	0.030	0.040	0.060	0.085	0.10	0.12	900 (810 – 980)
			0,100	0,55	0,0012	0,0016	0,0024	0,0034	0,0040	0,0048	2950 (2700 – 3200)
	N2	E/M/A	0.100	0.55	0.030	0.040	0.060	0.085	0.10	0.12	580 (530 – 630)
			0,100	0,55	0,0012	0,0016	0,0024	0,0034	0,0040	0,0048	1900 (1800 – 2000)
Stainless steel and S-materials	N3	E/M/A	0.100	0.55	0.030	0.040	0.060	0.085	0.10	0.12	385 (350 – 420)
			0,100	0,55	0,0012	0,0016	0,0024	0,0034	0,0040	0,0048	1275 (1200 – 1300)
	N11	E/M/A	0.100	0.55	0.030	0.040	0.060	0.085	0.10	0.12	510 (470 – 560)
			0,100	0,55	0,0012	0,0016	0,0024	0,0034	0,0040	0,0048	1675 (1600 – 1800)
Non ferrous	S1	E	0.100	0.55	0.017	0.022	0.032	0.044	0.055	0.065	70 (24 – 110)
			0,100	0,55	0,00065	0,00085	0,0013	0,0017	0,0022	0,0026	230 (79 – 360)
	S2	E	0.100	0.55	0.017	0.022	0.032	0.044	0.055	0.065	55 (19 – 94)
			0,100	0,55	0,00065	0,00085	0,0013	0,0017	0,0022	0,0026	180 (63 – 300)
Hard	S3	E	0.100	0.55	0.015	0.020	0.030	0.042	0.050	0.060	49 (17 – 80)
			0,100	0,55	0,00060	0,00080	0,0012	0,0017	0,0020	0,0024	160 (56 – 260)
	S11	E	0.100	0.55	0.030	0.040	0.060	0.085	0.10	0.12	175 (130 – 220)
			0,100	0,55	0,0012	0,0016	0,0024	0,0034	0,0040	0,0048	570 (430 – 720)
Plastic and cfrp	S12	E	0.100	0.55	0.030	0.040	0.060	0.085	0.10	0.12	135 (99 – 170)
			0,100	0,55	0,0012	0,0016	0,0024	0,0034	0,0040	0,0048	445 (330 – 550)
	S13	E	0.100	0.55	0.026	0.036	0.055	0.070	0.090	0.10	105 (77 – 130)
			0,100	0,55	0,0010	0,0014	0,0022	0,0028	0,0036	0,0040	345 (260 – 420)
Mimimaster Plus	H5	M/A/D	0.0500	1.2	0.020	0.026	0.040	0.050	0.065	0.075	115 (80 – 140)
			0,0500	1,2	0,00080	0,0010	0,0016	0,0020	0,0026	0,0030	375 (270 – 450)
	H8	M/A/D	0.0500	1.2	0.015	0.020	0.030	0.040	0.050	0.060	110 (78 – 140)
			0,0500	1,2	0,00060	0,00080	0,0012	0,0016	0,0020	0,0024	360 (260 – 450)
Mimimaster	H11	M/A/D	0.0500	1.2	0.020	0.026	0.040	0.050	0.065	0.075	145 (110 – 190)
			0,0500	1,2	0,00080	0,0010	0,0016	0,0020	0,0026	0,0030	475 (370 – 620)
	H12	M/A/D	0.0500	1.2	0.015	0.020	0.030	0.040	0.050	0.060	130 (91 – 170)
			0,0500	1,2	0,00060	0,00080	0,0012	0,0016	0,0020	0,0024	425 (300 – 550)
X-Heads	H21	M/A/D	0.0500	1.2	0.015	0.020	0.030	0.040	0.050	0.060	110 (78 – 140)
			0,0500	1,2	0,00060	0,00080	0,0012	0,0016	0,0020	0,0024	360 (260 – 450)
	TS1	A/D	0.100	0.55	0.030	0.040	0.060	0.085	0.10	0.12	900 (810 – 980)
			0,100	0,55	0,0012	0,0016	0,0024	0,0034	0,0040	0,0048	2950 (2700 – 3200)
Graphite	TP1	A/D	0.100	0.55	0.030	0.040	0.060	0.085	0.10	0.12	900 (810 – 980)
			0,100	0,55	0,0012	0,0016	0,0024	0,0034	0,0040	0,0048	2950 (2700 – 3200)
Minimaster	GR1	A/D	0.100	0.55	0.030	0.040	0.060	0.085	0.10	0.12	900 (810 – 980)
			0,100	0,55	0,0012	0,0016	0,0024	0,0034	0,0040	0,0048	2950 (2700 – 3200)

For cutting data recalculations, see pages 556 - 563

SMG = Seco material group
Coolant = A=air D=dry E=emulsion M=mist spray
v_c = m/min (sf/min)
f_z = mm (in/tooth)
a_p = mm/DC (in/DC) = factor
a_e = mm/DC (in/DC) = factor
All cutting data are target values

JH910

High speed – Universal – Square – 3 Flutes – Cylindrical – Corner radius

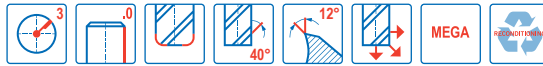
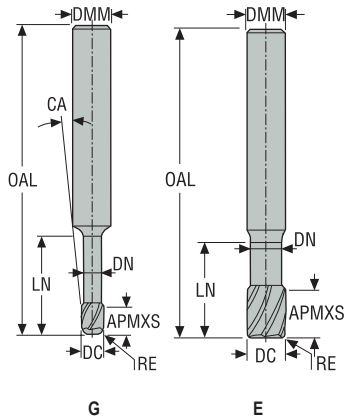

- Tolerances:
- DMM= h5
- DC= -0,02/-0,03 mm
- RE= ±0,01 mm
- Regrind possible if DC is ≥Ø6

Designation	Item number	Length index	Tool shape	DC	DMM	APMXS	OAL	LN	DN	RE	CA°	PCEDC	Cylindrical
				mm	mm	mm	mm	mm	mm	mm			
910020R020-MEGA	00020058	2	G	2,0	3,0	3,0	40,0	6,0	1,9	0,2	3,5	3	■
910025R020-MEGA	00020065	2	G	2,5	3,0	4,0	40,0	6,0	2,4	0,2	2,0	3	■
910030R010-MEGA	00020073	2	E	3,0	3,0	4,0	40,0	7,0	2,8	0,1	-	3	■
910030R020-MEGA	00020142	2	E	3,0	3,0	4,0	40,0	7,0	2,8	0,2	-	3	■
910035R020-MEGA	00020144	2	G	3,5	6,0	5,0	50,0	9,0	3,2	0,2	6,0	3	■
910040R020-MEGA	00020151	2	G	4,0	6,0	5,0	50,0	9,0	3,7	0,2	5,0	3	■
910040R030-MEGA	00020152	2	G	4,0	6,0	5,0	50,0	9,0	3,7	0,3	5,0	3	■
910040R050-MEGA	00020155	2	G	4,0	6,0	5,0	50,0	9,0	3,7	0,5	5,0	3	■
910050R020-MEGA	00020159	2	G	5,0	6,0	6,0	50,0	11,0	4,6	0,2	2,5	3	■
910060R020-MEGA	00020160	2	E	6,0	6,0	7,0	60,0	14,0	5,6	0,2	-	3	■
910060R030-MEGA	00020161	2	E	6,0	6,0	7,0	60,0	14,0	5,6	0,3	-	3	■
910060R050-MEGA	00020162	2	E	6,0	6,0	7,0	60,0	14,0	5,6	0,5	-	3	■
910080R020-MEGA	00020163	2	E	8,0	8,0	9,0	60,0	18,0	7,4	0,2	-	3	■
910080R050-MEGA	00020164	2	E	8,0	8,0	9,0	60,0	18,0	7,4	0,5	-	3	■
910100R020-MEGA	00020165	2	E	10,0	10,0	12,0	70,0	25,0	9,4	0,2	-	3	■
910100R050-MEGA	00020166	2	E	10,0	10,0	12,0	70,0	25,0	9,4	0,5	-	3	■
910100R100-MEGA	00020167	2	E	10,0	10,0	12,0	70,0	25,0	9,4	1,0	-	3	■
910120R050-MEGA	00020168	2	E	12,0	12,0	15,0	80,0	30,0	11,4	0,5	-	3	■
910120R100-MEGA	00020169	2	E	12,0	12,0	15,0	80,0	30,0	11,4	1,0	-	3	■

■ Stocked standard.

Universal

Steel and cast iron

Stainless steel and S-materials

Non ferrous

Hard

Plastic and CFRP

Graphite

X-Heads

Minimaster Plus

Minimaster

JH910

High speed – Universal – Square – 3 Flutes – Cylindrical – Corner radius

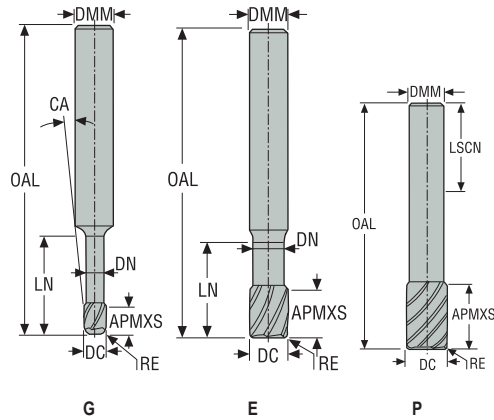

- Tolerances:
- DMM= h5
- DC= -0,02/-0,03 mm
- RE= ±0,01 mm
- Regrind possible if DC is ≥Ø6

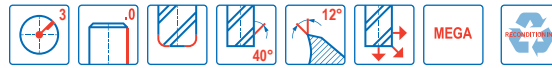

Designation	Item number	Length index	Tool shape	DC	DMM	APMXS	OAL	LN	DN	RE	CA°	LSCN	PCEDC	Cylindrical
				mm	mm	mm	mm	mm	mm	mm	mm	mm	mm	
910L020-MEGA	00022002	3	G	2,0	3,0	3,0	60,0	10,0	1,9	0,2	2,5	28,0	3	■
910L030-MEGA	00022003	3	E	3,0	3,0	4,0	60,0	14,0	2,8	0,2	–	28,0	3	■
910L040-MEGA	00022004	3	G	4,0	6,0	5,0	65,0	18,0	3,7	0,2	3,0	36,0	3	■
910L050-MEGA	00022005	3	G	5,0	6,0	6,0	65,0	22,0	4,6	0,2	1,5	36,0	3	■
910L060-MEGA	00022006	3	E	6,0	6,0	7,0	80,0	26,0	5,6	0,3	–	36,0	3	■
910L080-MEGA	00022007	3	E	8,0	8,0	9,0	85,0	36,0	7,4	0,5	–	36,0	3	■
910L100-MEGA	00022009	3	E	10,0	10,0	12,0	100,0	45,0	9,4	0,5	–	40,0	3	■
910L120-MEGA	00022011	3	E	12,0	12,0	15,0	125,0	54,0	11,4	0,5	–	45,0	3	■
910L160-MEGA	00022013	3	E	16,0	16,0	18,0	125,0	65,0	15,4	1,0	–	48,0	3	■
910RS070-MEGA	00021772	4	P	7,0	6,0	8,0	100,0	–	–	0,3	–	36,0	3	■
910RS090-MEGA	00021781	4	P	9,0	8,0	11,0	100,0	–	–	0,5	–	36,0	3	■
910RS110-MEGA	00021782	4	P	11,0	10,0	13,0	125,0	–	–	0,5	–	40,0	3	■
910RS130-MEGA	00021784	4	P	13,0	12,0	16,0	150,0	–	–	0,6	–	45,0	3	■
910RS170-MEGA	00021800	4	P	17,0	16,0	20,0	150,0	–	–	0,6	–	48,0	3	■

■ Stocked standard.

Universal

Steel and cast iron

Stainless steel and S-materials

Non ferrous

Hard

Plastic and CFRP

Graphite

X-Heads

Minimaster Plus

Minimaster

Cutting data – JH910 Side milling roughing

SMG	Coolant	a _e /DC	a _p /DC	f _z														v _c
				2	3	4	5	6	7	8	9	10	11	12	13	16	17	
P1	M/E/A	0.0400	1.1	0.020	0.030	0.040	0.050	0.060	0.070	0.080	0.090	0.10	0.11	0.12	0.13	0.16	0.17	455 (410 – 500)
		0,0400	1,1	0,00080	0,0012	0,0016	0,0020	0,0024	0,0028	0,0032	0,0036	0,0040	0,0044	0,0048	0,0050	0,0065	0,0065	1500 (1400 – 1600)
P2	M/E/A	0.0400	1.1	0.020	0.030	0.040	0.050	0.060	0.070	0.080	0.090	0.10	0.11	0.12	0.13	0.16	0.17	445 (400 – 490)
		0,0400	1,1	0,00080	0,0012	0,0016	0,0020	0,0024	0,0028	0,0032	0,0036	0,0040	0,0044	0,0048	0,0050	0,0065	0,0065	1450 (1400 – 1600)
P3	M/E/A	0.0400	1.1	0.020	0.030	0.040	0.050	0.060	0.070	0.080	0.090	0.10	0.11	0.12	0.13	0.16	0.17	385 (350 – 420)
		0,0400	1,1	0,00080	0,0012	0,0016	0,0020	0,0024	0,0028	0,0032	0,0036	0,0040	0,0044	0,0048	0,0050	0,0065	0,0065	1275 (1200 – 1300)
P4	M/E/A	0.0400	1.1	0.020	0.030	0.040	0.050	0.060	0.070	0.080	0.090	0.10	0.11	0.12	0.13	0.16	0.17	335 (300 – 370)
		0,0400	1,1	0,00080	0,0012	0,0016	0,0020	0,0024	0,0028	0,0032	0,0036	0,0040	0,0044	0,0048	0,0050	0,0065	0,0065	1100 (990 – 1200)
P5	M/E/A	0.0400	1.1	0.020	0.030	0.040	0.050	0.060	0.070	0.080	0.090	0.10	0.11	0.12	0.13	0.16	0.17	320 (290 – 350)
		0,0400	1,1	0,00080	0,0012	0,0016	0,0020	0,0024	0,0028	0,0032	0,0036	0,0040	0,0044	0,0048	0,0050	0,0065	0,0065	1050 (960 – 1100)
P6	M/E/A	0.0400	1.1	0.020	0.030	0.040	0.050	0.060	0.070	0.080	0.090	0.10	0.11	0.12	0.13	0.16	0.17	360 (330 – 400)
		0,0400	1,1	0,00080	0,0012	0,0016	0,0020	0,0024	0,0028	0,0032	0,0036	0,0040	0,0044	0,0048	0,0050	0,0065	0,0065	1175 (1100 – 1300)
P7	M/E/A	0.0400	1.1	0.020	0.030	0.040	0.050	0.060	0.070	0.080	0.090	0.10	0.11	0.12	0.13	0.16	0.17	340 (310 – 370)
		0,0400	1,1	0,00080	0,0012	0,0016	0,0020	0,0024	0,0028	0,0032	0,0036	0,0040	0,0044	0,0048	0,0050	0,0065	0,0065	1125 (1100 – 1200)
P8	M/E/A	0.0400	1.1	0.020	0.030	0.040	0.050	0.060	0.070	0.080	0.090	0.10	0.11	0.12	0.13	0.16	0.17	320 (290 – 350)
		0,0400	1,1	0,00080	0,0012	0,0016	0,0020	0,0024	0,0028	0,0032	0,0036	0,0040	0,0044	0,0048	0,0050	0,0065	0,0065	1050 (960 – 1100)
P11	M/E/A	0.0400	1.0	0.020	0.030	0.040	0.050	0.060	0.070	0.080	0.090	0.10	0.11	0.12	0.13	0.16	0.17	330 (300 – 360)
		0,0400	1,0	0,00080	0,0012	0,0016	0,0020	0,0024	0,0028	0,0032	0,0036	0,0040	0,0044	0,0048	0,0050	0,0065	0,0065	1075 (990 – 1100)
P12	M/E/A	0.0400	1.0	0.020	0.030	0.040	0.050	0.060	0.070	0.080	0.090	0.10	0.11	0.12	0.13	0.16	0.17	195 (180 – 210)
		0,0400	1,0	0,00080	0,0012	0,0016	0,0020	0,0024	0,0028	0,0032	0,0036	0,0040	0,0044	0,0048	0,0050	0,0065	0,0065	640 (600 – 680)
M1	M/E/A	0.0400	1.0	0.020	0.030	0.040	0.050	0.060	0.070	0.080	0.090	0.10	0.11	0.12	0.13	0.16	0.17	200 (180 – 220)
		0,0400	1,0	0,00080	0,0012	0,0016	0,0020	0,0024	0,0028	0,0032	0,0036	0,0040	0,0044	0,0048	0,0050	0,0065	0,0065	660 (600 – 720)
M2	M/E/A	0.0400	1.0	0.020	0.030	0.040	0.050	0.060	0.070	0.080	0.090	0.10	0.11	0.12	0.13	0.16	0.17	160 (150 – 170)
		0,0400	1,0	0,00080	0,0012	0,0016	0,0020	0,0024	0,0028	0,0032	0,0036	0,0040	0,0044	0,0048	0,0050	0,0065	0,0065	520 (500 – 550)
M3	M/E/A	0.0300	0.80	0.020	0.030	0.040	0.050	0.060	0.070	0.080	0.090	0.10	0.11	0.12	0.13	0.16	0.17	110 (91 – 120)
		0,0300	0,80	0,00080	0,0012	0,0016	0,0020	0,0024	0,0028	0,0032	0,0036	0,0040	0,0044	0,0048	0,0050	0,0065	0,0065	360 (300 – 390)
M4	M/E/A	0.0300	0.80	0.020	0.030	0.040	0.050	0.060	0.070	0.080	0.090	0.10	0.11	0.12	0.13	0.16	0.17	80 (68 – 94)
		0,0300	0,80	0,00080	0,0012	0,0016	0,0020	0,0024	0,0028	0,0032	0,0036	0,0040	0,0044	0,0048	0,0050	0,0065	0,0065	260 (230 – 300)
M5	M/E/A	0.0300	0.80	0.020	0.030	0.040	0.050	0.060	0.070	0.080	0.090	0.10	0.11	0.12	0.13	0.16	0.17	70 (57 – 78)
		0,0300	0,80	0,00080	0,0012	0,0016	0,0020	0,0024	0,0028	0,0032	0,0036	0,0040	0,0044	0,0048	0,0050	0,0065	0,0065	230 (190 – 250)
K1	A/E	0.0400	1.0	0.020	0.030	0.040	0.050	0.060	0.070	0.080	0.090	0.10	0.11	0.12	0.13	0.16	0.17	315 (270 – 350)
		0,0400	1,0	0,00080	0,0012	0,0016	0,0020	0,0024	0,0028	0,0032	0,0036	0,0040	0,0044	0,0048	0,0050	0,0065	0,0065	1025 (890 – 1100)
K2	A/E	0.0400	1.0	0.020	0.030	0.040	0.050	0.060	0.070	0.080	0.090	0.10	0.11	0.12	0.13	0.16	0.17	270 (240 – 310)
		0,0400	1,0	0,00080	0,0012	0,0016	0,0020	0,0024	0,0028	0,0032	0,0036	0,0040	0,0044	0,0048	0,0050	0,0065	0,0065	890 (790 – 1000)
K3	A/E	0.0400	1.0	0.020	0.030	0.040	0.050	0.060	0.070	0.080	0.090	0.10	0.11	0.12	0.13	0.16	0.17	230 (200 – 260)
		0,0400	1,0	0,00080	0,0012	0,0016	0,0020	0,0024	0,0028	0,0032	0,0036	0,0040	0,0044	0,0048	0,0050	0,0065	0,0065	750 (660 – 850)
K4	A/E	0.0400	1.0	0.020	0.030	0.040	0.050	0.060	0.070	0.080	0.090	0.10	0.11	0.12	0.13	0.16	0.17	220 (190 – 250)
		0,0400	1,0	0,00080	0,0012	0,0016	0,0020	0,0024	0,0028	0,0032	0,0036	0,0040	0,0044	0,0048	0,0050	0,0065	0,0065	720 (630 – 820)
K5	A/E	0.0300	0.80	0.020	0.030	0.040	0.050	0.060	0.070	0.080	0.090	0.10	0.11	0.12	0.13	0.16	0.17	280 (240 – 320)
		0,0300	0,80	0,00080	0,0012	0,0016	0,0020	0,0024	0,0028	0,0032	0,0036	0,0040	0,0044	0,0048	0,0050	0,0065	0,0065	920 (790 – 1000)
K6	A/E	0.0300	0.80	0.020	0.030	0.040	0.050	0.060	0.070	0.080	0.090	0.10	0.11	0.12	0.13	0.16	0.17	415 (350 – 480)
		0,0300	0,80	0,00080	0,0012	0,0016	0,0020	0,0024	0,0028	0,0032	0,0036	0,0040	0,0044	0,0048	0,0050	0,0065	0,0065	1350 (1200 – 1500)
K7	A/E	0.0300	0.80	0.020	0.030	0.040	0.050	0.060	0.070	0.080	0.090	0.10	0.11	0.12	0.13	0.16	0.17	355 (300 – 410)
		0,0300	0,80	0,00080	0,0012	0,0016	0,0020	0,0024	0,0028	0,0032	0,0036	0,0040	0,0044	0,0048	0,0050	0,0065	0,0065	1175 (990 – 1300)
S1	E/M/A	0.0300	0.70	0.020	0.030	0.040	0.050	0.060	0.070	0.080	0.090	0.10	0.11	0.12	0.13	0.16	0.17	115 (93 – 130)
		0,0300	0,70	0,00080	0,0012	0,0016	0,0020	0,0024	0,0028	0,0032	0,0036	0,0040	0,0044	0,0048	0,0050	0,0065	0,0065	375 (310 – 420)
S2	E/M/A	0.0300	0.70	0.020	0.030	0.040	0.050	0.060	0.070	0.080	0.090	0.10	0.11	0.12	0.13	0.16	0.17	95 (75 – 110)
		0,0300	0,70	0,00080	0,0012	0,0016	0,0020	0,0024	0,0028	0,0032	0,0036	0,0040	0,0044	0,0048	0,0050	0,0065	0,0065	310 (250 – 360)
S3	E/M/A	0.0200	0.50	0.016	0.024	0.032	0.040	0.048	0.055	0.065	0.070	0.080	0.090	0.095	0.10	0.13	0.14	50 (40 – 59)
		0,0200	0,50	0,00065	0,00095	0,0013	0,0016	0,0019	0,0022	0,0026	0,0028	0,0032	0,0036	0,0038	0,0040	0,0050	0,0055	165 (140 – 190)
S11	E/M/A	0.0400	1.0	0.020	0.030	0.040	0.050	0.060	0.070	0.080	0.090	0.10	0.11	0.12	0.13	0.16	0.17	175 (160 – 190)
		0,0400	1,0	0,00080	0,0012	0,0016	0,0020	0,0024	0,0028	0,0032	0,0036	0,0040	0,0044	0,0048	0,0050	0,0065	0,0065	570 (530 – 620)
S12	E/M/A	0.0400	1.0	0.020	0.030	0.040	0.050	0.060	0.070	0.080	0.090	0.10	0.11	0.12	0.13	0.16	0.17	135 (120 – 150)
		0,0400	1,0	0,00080	0,0012	0,0016	0,0020	0,0024	0,0028	0,0032	0,0036	0,0040	0,0044	0,0048	0,0050	0,0065	0,0065	445 (400 – 490)
S13	E/M/A	0.0400	1.0	0.020	0.030	0.040	0.050	0.060	0.070	0.080	0.090	0.10	0.11	0.12	0.13	0.16	0.17	105 (90 – 110)
		0,0400	1,0	0,00080	0,0012	0,0016	0,0020	0										

JH930

High speed – Universal – Square – 5-8 Flutes – Cylindrical – Corner radius

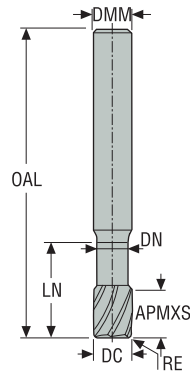

E

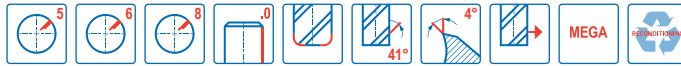

- Tolerances:
- DMM= h5
- DC= -0,02/-0,04 mm
- RE= ±0,05 mm
- Regrind possible



Designation	Item number	Length index	Tool shape	DC	DMM	APMXS	OAL	LN	DN	RE	PCEDC	Cylindrical
				mm	mm	mm	mm	mm	mm	mm		
930060R020-MEGA	00022026	2	E	6,0	6,0	9,0	55,0	15,0	5,6	0,2	5	■
930060R050-MEGA	00022027	2	E	6,0	6,0	9,0	55,0	15,0	5,6	0,5	5	■
930080R020-MEGA	00022028	2	E	8,0	8,0	12,0	60,0	18,0	7,4	0,2	5	■
930080R050-MEGA	00022029	2	E	8,0	8,0	12,0	60,0	18,0	7,4	0,5	5	■
930100R030-MEGA	00022030	2	E	10,0	10,0	15,0	70,0	25,0	9,4	0,3	6	■
930100R100-MEGA	00022031	2	E	10,0	10,0	15,0	70,0	25,0	9,4	1,0	6	■
930120R050-MEGA	00022033	2	E	12,0	12,0	18,0	80,0	30,0	11,4	0,5	6	■
930120R100-MEGA	00022034	2	E	12,0	12,0	18,0	80,0	30,0	11,4	1,0	6	■
930160R050-MEGA	00022035	2	E	16,0	16,0	24,0	90,0	35,0	15,4	0,5	8	■
930160R100-MEGA	00022040	2	E	16,0	16,0	24,0	90,0	35,0	15,4	1,0	8	■
930200R050-MEGA	00022044	2	E	20,0	20,0	30,0	100,0	38,0	19,2	0,5	8	■

■ Stocked standard.

Universal

Steel and cast iron

Stainless steel and S-materials

Non ferrous

Hard

Plastic and cfrp

Graphite

X-Heads

Minimaster Plus

Minimaster

Cutting data – JH930 Side milling

SMG		a _p /DC	a _e /DC	f _z						v _c
				6	8	10	12	16	20	
P1	M/E/A	0.0400	0.70	0.065	0.085	0.11	0.13	0.16	0.18	440 (370 – 490)
		0,0400	0,70	0,0026	0,0034	0,0044	0,0050	0,0065	0,0070	1450 (1300 – 1600)
P2	M/E/A	0.0400	0.70	0.065	0.090	0.11	0.13	0.16	0.19	430 (360 – 480)
		0,0400	0,70	0,0026	0,0036	0,0044	0,0050	0,0065	0,0075	1400 (1200 – 1500)
P3	M/E/A	0.0400	0.70	0.060	0.085	0.10	0.12	0.15	0.18	375 (320 – 420)
		0,0400	0,70	0,0024	0,0034	0,0040	0,0048	0,0060	0,0070	1225 (1100 – 1300)
P4	M/E/A	0.0400	0.70	0.060	0.080	0.10	0.12	0.15	0.17	330 (280 – 370)
		0,0400	0,70	0,0024	0,0032	0,0040	0,0048	0,0060	0,0065	1075 (920 – 1200)
P5	M/E/A	0.0400	0.70	0.060	0.080	0.10	0.12	0.15	0.17	315 (270 – 350)
		0,0400	0,70	0,0024	0,0032	0,0040	0,0048	0,0060	0,0065	1025 (890 – 1100)
P6	M/E/A	0.0400	0.70	0.060	0.080	0.10	0.12	0.15	0.17	355 (300 – 390)
		0,0400	0,70	0,0024	0,0032	0,0040	0,0048	0,0060	0,0065	1175 (990 – 1200)
P7	M/E/A	0.0400	0.70	0.060	0.080	0.10	0.12	0.15	0.17	335 (280 – 370)
		0,0400	0,70	0,0024	0,0032	0,0040	0,0048	0,0060	0,0065	1100 (920 – 1200)
P8	M/E/A	0.0400	0.70	0.060	0.085	0.10	0.12	0.15	0.18	315 (270 – 350)
		0,0400	0,70	0,0024	0,0034	0,0040	0,0048	0,0060	0,0070	1025 (890 – 1100)
P11	M/E/A	0.0400	0.70	0.060	0.080	0.10	0.12	0.15	0.17	325 (280 – 360)
		0,0400	0,70	0,0024	0,0032	0,0040	0,0048	0,0060	0,0065	1075 (920 – 1100)
P12	M/E/A	0.0400	0.70	0.040	0.055	0.070	0.080	0.10	0.11	200 (170 – 220)
		0,0400	0,70	0,0016	0,0022	0,0028	0,0032	0,0040	0,0044	660 (560 – 720)
K1	E/M/A	0.0400	0.70	0.060	0.080	0.10	0.12	0.15	0.17	255 (210 – 300)
		0,0400	0,70	0,0024	0,0032	0,0040	0,0048	0,0060	0,0065	840 (690 – 980)
K2	E/M/A	0.0400	0.70	0.055	0.075	0.090	0.11	0.13	0.15	225 (180 – 260)
		0,0400	0,70	0,0022	0,0030	0,0036	0,0044	0,0050	0,0060	740 (600 – 850)
K3	E/M/A	0.0400	0.70	0.055	0.075	0.090	0.11	0.13	0.15	190 (160 – 220)
		0,0400	0,70	0,0022	0,0030	0,0036	0,0044	0,0050	0,0060	620 (530 – 720)
K4	E/M/A	0.0400	0.70	0.055	0.075	0.090	0.11	0.13	0.15	180 (150 – 210)
		0,0400	0,70	0,0022	0,0030	0,0036	0,0044	0,0050	0,0060	590 (500 – 680)
K5	E/M/A	0.0300	0.50	0.060	0.080	0.10	0.12	0.15	0.17	205 (160 – 250)
		0,0300	0,50	0,0024	0,0032	0,0040	0,0048	0,0060	0,0065	670 (530 – 820)
K6	E/M/A	0.0300	0.50	0.065	0.090	0.11	0.13	0.16	0.19	300 (230 – 370)
		0,0300	0,50	0,0026	0,0036	0,0044	0,0050	0,0065	0,0075	980 (760 – 1200)
K7	E/M/A	0.0300	0.50	0.060	0.080	0.10	0.12	0.15	0.17	260 (200 – 320)
		0,0300	0,50	0,0024	0,0032	0,0040	0,0048	0,0060	0,0065	850 (660 – 1000)
S1	E/M/A	0.0300	0.44	0.055	0.070	0.090	0.11	0.13	0.15	80 (62 – 100)
		0,0300	0,44	0,0022	0,0028	0,0036	0,0044	0,0050	0,0060	260 (210 – 320)
S2	E/M/A	0.0300	0.44	0.055	0.070	0.090	0.11	0.13	0.15	65 (50 – 82)
		0,0300	0,44	0,0022	0,0028	0,0036	0,0044	0,0050	0,0060	215 (170 – 260)
S3	E/M/A	0.0200	0.70	0.055	0.070	0.090	0.11	0.13	0.15	41 (31 – 50)
		0,0200	0,70	0,0022	0,0028	0,0036	0,0044	0,0050	0,0060	135 (110 – 160)
S11	E/M/A	0.0400	0.70	0.060	0.080	0.10	0.12	0.15	0.17	160 (140 – 180)
		0,0400	0,70	0,0024	0,0032	0,0040	0,0048	0,0060	0,0065	520 (460 – 590)
S12	E/M/A	0.0400	0.70	0.060	0.080	0.10	0.12	0.15	0.17	120 (110 – 140)
		0,0400	0,70	0,0024	0,0032	0,0040	0,0048	0,0060	0,0065	395 (370 – 450)
S13	E/M/A	0.0400	0.70	0.050	0.070	0.085	0.10	0.13	0.15	95 (81 – 110)
		0,0400	0,70	0,0020	0,0028	0,0034	0,0040	0,0050	0,0060	310 (270 – 360)
H3	M/A	0.0200	0.50	0.018	0.024	0.030	0.036	0.044	0.050	55 (41 – 71)
		0,0200	0,50	0,00070	0,00095	0,0012	0,0014	0,0017	0,0020	180 (140 – 230)
H5	M/A	0.0300	0.50	0.024	0.032	0.040	0.048	0.060	0.070	250 (210 – 300)
		0,0300	0,50	0,00095	0,0013	0,0016	0,0019	0,0024	0,0028	820 (690 – 980)
H7	M/A	0.0200	0.50	0.018	0.024	0.030	0.036	0.044	0.050	55 (41 – 71)
		0,0200	0,50	0,00070	0,00095	0,0012	0,0014	0,0017	0,0020	180 (140 – 230)
H8	M/A	0.0300	0.50	0.018	0.024	0.030	0.036	0.044	0.050	255 (210 – 300)
		0,0300	0,50	0,00070	0,00095	0,0012	0,0014	0,0017	0,0020	840 (690 – 980)
H11	M/A	0.0300	0.50	0.024	0.032	0.040	0.048	0.060	0.070	320 (260 – 380)
		0,0300	0,50	0,00095	0,0013	0,0016	0,0019	0,0024	0,0028	1050 (860 – 1200)
H12	M/A	0.0400	0.70	0.030	0.042	0.050	0.060	0.075	0.085	270 (220 – 320)
		0,0400	0,70	0,0012	0,0017	0,0020	0,0024	0,0030	0,0034	890 (730 – 1000)
H21	M/A	0.0300	0.50	0.018	0.024	0.030	0.036	0.044	0.050	255 (210 – 300)
		0,0300	0,50	0,00070	0,00095	0,0012	0,0014	0,0017	0,0020	840 (690 – 980)
H31	M/A	0.0300	0.50	0.024	0.032	0.040	0.048	0.060	0.070	155 (130 – 180)
		0,0300	0,50	0,00095	0,0013	0,0016	0,0019	0,0024	0,0028	510 (430 – 590)

For cutting data recalculations, see pages 556 - 563

SMG = Seco material group
Coolant = A=air D=dry E=emulsion M=mist spray
v_c = m/min (sf/min)
f_z = mm (in/tooth)
a_p = mm/DC (in/DC) = factor
a_e = mm/DC (in/DC) = factor
All cutting data are target values

JHB970

High speed – Universal – Ball nose – 2 Flutes – Cylindrical

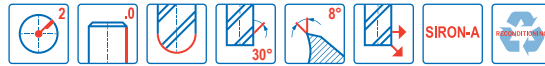
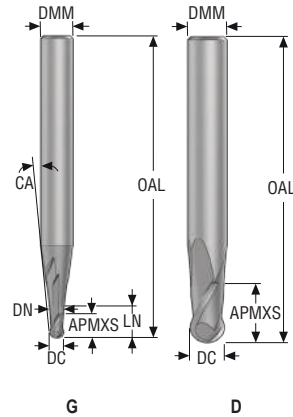

- Tolerances:
- DMM= h5
- DC= -0,02/-0,04 mm
- RE= ±0,01 mm
- Regrind possible if DC is ≥Ø6

Designation	Grade	Item number	Length index	Tool shape	DC	DMM	APMXS	OAL	LN	DN	CA°	PCEDC	Cylindrical
					mm	mm	mm	mm	mm	mm			
JHB970020G1B.0Z2	SIRA	10072058	1	G	2,0	3,0	3,0	50,0	10,0	1,9	2,5	2	■
JHB970030D1B.0Z2	SIRA	10072059	1	D	3,0	3,0	4,5	50,0	–	–	–	2	■
JHB970040D1B.0Z2	SIRA	10072060	1	D	4,0	4,0	6,0	60,0	–	–	–	2	■
JHB970050D1B.0Z2	SIRA	10072061	1	D	5,0	5,0	7,5	60,0	–	–	–	2	■
JHB970060D1B.0Z2	SIRA	10072062	1	D	6,0	6,0	9,0	75,0	–	–	–	2	■
JHB970020G2B.0Z2	SIRA	10072063	2	G	2,0	6,0	3,0	60,0	4,0	1,9	8,0	2	■
JHB970025G2B.0Z2	SIRA	10072064	2	G	2,5	6,0	4,0	60,0	5,0	2,4	7,5	2	■
JHB970030G2B.0Z2	SIRA	10072065	2	G	3,0	6,0	4,5	60,0	6,0	2,8	5,5	2	■
JHB970035G2B.0Z2	SIRA	10072066	2	G	3,5	6,0	5,0	60,0	7,0	3,2	4,5	2	■
JHB970040G2B.0Z2	SIRA	10072067	2	G	4,0	6,0	6,0	60,0	8,0	3,7	3,0	2	■
JHB970050G2B.0Z2	SIRA	10072068	2	G	5,0	6,0	7,5	60,0	10,0	4,6	2,0	2	■
JHB970060G2B.0Z2	SIRA	10072069	2	G	6,0	8,0	9,0	75,0	12,0	5,6	2,5	2	■
JHB970080D2B.0Z2	SIRA	10072070	2	D	8,0	8,0	12,0	75,0	–	–	–	2	■
JHB970100D2B.0Z2	SIRA	10072071	2	D	10,0	10,0	15,0	80,0	–	–	–	2	■
JHB970120D2B.0Z2	SIRA	10072072	2	D	12,0	12,0	18,0	90,0	–	–	–	2	■
JHB970160D2B.0Z2	SIRA	10072073	2	D	16,0	16,0	24,0	100,0	–	–	–	2	■
JHB970020G3B.0Z2	SIRA	10072074	3	G	2,0	6,0	3,0	80,0	4,0	1,9	8,0	2	■
JHB970030G3B.0Z2	SIRA	10072075	3	G	3,0	6,0	4,5	80,0	6,0	2,8	5,5	2	■
JHB970040G3B.0Z2	SIRA	10072076	3	G	4,0	6,0	6,0	80,0	8,0	3,7	3,0	2	■
JHB970060G3B.0Z2	SIRA	10072077	3	G	6,0	8,0	9,0	100,0	12,0	5,6	2,5	2	■
JHB970080D3B.0Z2	SIRA	10072078	3	D	8,0	8,0	12,0	108,0	–	–	–	2	■
JHB970100D3B.0Z2	SIRA	10072079	3	D	10,0	10,0	15,0	125,0	–	–	–	2	■
JHB970120D3B.0Z2	SIRA	10072080	3	D	12,0	12,0	18,0	125,0	–	–	–	2	■

■ Stocked standard.

Universal

Steel and cast iron

Stainless steel and S-materials

Non ferrous

Hard

Plastic and CFRP

Graphite

X-Heads

Minimaster Plus

Minimaster

Cutting data – JHB970 Copy milling roughing

SMG		a _e /DC	a _p /DC	f _z											v _c
				2	2.5	3	3.5	4	5	6	8	10	12	16	
P1	M	0.200	1.0	0.011	0.014	0.016	0.019	0.022	0.028	0.032	0.044	0.055	0.065	0.080	210 (190 – 230)
		0,200	1,0	0,00044	0,00055	0,00065	0,00075	0,00085	0,0011	0,0013	0,0017	0,0022	0,0026	0,0032	690 (630 – 750)
P2	M	0.200	1.0	0.011	0.014	0.017	0.019	0.022	0.028	0.034	0.044	0.055	0.065	0.080	205 (180 – 230)
		0,200	1,0	0,00044	0,00055	0,00065	0,00075	0,00085	0,0011	0,0013	0,0017	0,0022	0,0026	0,0032	670 (600 – 750)
P3	M	0.200	1.0	0.010	0.013	0.016	0.018	0.020	0.026	0.032	0.042	0.050	0.060	0.075	180 (160 – 200)
		0,200	1,0	0,00040	0,00050	0,00065	0,00070	0,00080	0,0010	0,0013	0,0017	0,0020	0,0024	0,0030	590 (530 – 650)
P4	M	0.200	1.0	0.010	0.013	0.015	0.018	0.020	0.026	0.030	0.040	0.050	0.060	0.075	155 (140 – 170)
		0,200	1,0	0,00040	0,00050	0,00060	0,00070	0,00080	0,0010	0,0012	0,0016	0,0020	0,0024	0,0030	510 (460 – 550)
P5	M	0.200	1.0	0.010	0.012	0.015	0.018	0.020	0.025	0.030	0.040	0.050	0.060	0.075	150 (140 – 170)
		0,200	1,0	0,00040	0,00048	0,00060	0,00065	0,00080	0,0010	0,0012	0,0016	0,0020	0,0024	0,0030	490 (460 – 550)
P6	M	0.200	1.0	0.010	0.012	0.015	0.017	0.020	0.025	0.030	0.040	0.050	0.060	0.075	170 (150 – 190)
		0,200	1,0	0,00040	0,00048	0,00060	0,00065	0,00080	0,0010	0,0012	0,0016	0,0020	0,0024	0,0030	560 (500 – 620)
P7	M	0.200	1.0	0.010	0.012	0.015	0.017	0.020	0.025	0.030	0.040	0.050	0.060	0.075	160 (140 – 180)
		0,200	1,0	0,00040	0,00048	0,00060	0,00065	0,00080	0,0010	0,0012	0,0016	0,0020	0,0024	0,0030	520 (460 – 590)
P8	M	0.200	1.0	0.010	0.013	0.016	0.018	0.020	0.026	0.032	0.042	0.050	0.060	0.075	150 (140 – 170)
		0,200	1,0	0,00040	0,00050	0,00065	0,00070	0,00080	0,0010	0,0013	0,0017	0,0020	0,0024	0,0030	490 (460 – 550)
P11	M	0.200	1.0	0.010	0.012	0.015	0.017	0.020	0.025	0.030	0.040	0.050	0.060	0.075	75 (67 – 86)
		0,200	1,0	0,00040	0,00048	0,00060	0,00065	0,00080	0,0010	0,0012	0,0016	0,0020	0,0024	0,0030	245 (220 – 280)
P12	M	0.200	1.0	0.0070	0.0085	0.010	0.012	0.014	0.017	0.020	0.028	0.034	0.040	0.050	48 (42 – 53)
		0,200	1,0	0,00028	0,00034	0,00040	0,00048	0,00055	0,00065	0,00080	0,0011	0,0013	0,0016	0,0020	155 (140 – 170)
M1	E	0.200	1.0	0.0090	0.011	0.013	0.015	0.018	0.022	0.026	0.036	0.044	0.050	0.065	90 (80 – 100)
		0,200	1,0	0,00036	0,00044	0,00050	0,00060	0,00070	0,00085	0,0010	0,0014	0,0017	0,0020	0,0026	295 (270 – 320)
M2	E	0.200	1.0	0.0080	0.010	0.012	0.014	0.016	0.020	0.024	0.032	0.040	0.048	0.060	75 (65 – 85)
		0,200	1,0	0,00032	0,00040	0,00048	0,00055	0,00065	0,00080	0,00095	0,0013	0,0016	0,0019	0,0024	245 (220 – 270)
M3	E	0.150	1.0	0.0060	0.0075	0.0090	0.010	0.012	0.015	0.018	0.024	0.030	0.036	0.044	65 (55 – 75)
		0,150	1,0	0,00024	0,00030	0,00036	0,00040	0,00048	0,00060	0,00070	0,00095	0,0012	0,0014	0,0017	215 (190 – 240)
M4	E	0.150	1.0	0.0050	0.0065	0.0080	0.0090	0.010	0.013	0.016	0.020	0.026	0.032	0.038	49 (42 – 56)
		0,150	1,0	0,00020	0,00026	0,00032	0,00036	0,00040	0,00050	0,00065	0,00080	0,0010	0,0013	0,0015	160 (140 – 180)
M5	E	0.150	1.0	0.0050	0.0065	0.0080	0.0090	0.010	0.013	0.016	0.020	0.026	0.032	0.038	41 (35 – 47)
		0,150	1,0	0,00020	0,00026	0,00032	0,00036	0,00040	0,00050	0,00065	0,00080	0,0010	0,0013	0,0015	135 (120 – 150)
S1	E	0.100	0.80	0.0060	0.0075	0.0090	0.010	0.012	0.015	0.018	0.024	0.030	0.036	0.044	50 (40 – 59)
		0,100	0,80	0,00024	0,00030	0,00036	0,00040	0,00048	0,00060	0,00070	0,00095	0,0012	0,0014	0,0017	165 (140 – 190)
S2	E	0.100	0.80	0.0060	0.0075	0.0090	0.010	0.012	0.015	0.018	0.024	0.030	0.036	0.044	40 (33 – 48)
		0,100	0,80	0,00024	0,00030	0,00036	0,00040	0,00048	0,00060	0,00070	0,00095	0,0012	0,0014	0,0017	130 (110 – 150)
S3	E	0.100	0.60	0.0040	0.0050	0.0060	0.0070	0.0080	0.010	0.012	0.016	0.020	0.024	0.028	30 (20 – 39)
		0,100	0,60	0,00016	0,00020	0,00024	0,00028	0,00032	0,00040	0,00048	0,00065	0,00080	0,00095	0,0011	100 (66 – 120)
S11	E	0.200	1.0	0.010	0.012	0.015	0.018	0.020	0.025	0.030	0.040	0.050	0.060	0.075	90 (79 – 100)
		0,200	1,0	0,00040	0,00048	0,00060	0,00065	0,00080	0,0010	0,0012	0,0016	0,0020	0,0024	0,0030	295 (260 – 320)
S12	E	0.200	1.0	0.010	0.012	0.015	0.018	0.020	0.025	0.030	0.040	0.050	0.060	0.075	70 (61 – 80)
		0,200	1,0	0,00040	0,00048	0,00060	0,00065	0,00080	0,0010	0,0012	0,0016	0,0020	0,0024	0,0030	230 (210 – 260)
S13	E	0.200	1.0	0.0085	0.011	0.013	0.015	0.017	0.022	0.026	0.034	0.044	0.050	0.065	55 (48 – 63)
		0,200	1,0	0,00034	0,00044	0,00050	0,00060	0,00065	0,00085	0,0010	0,0013	0,0017	0,0020	0,0026	180 (160 – 200)

For cutting data recalculations, see pages 556 - 563

SMG = Seco material group
Coolant = A=air D=dry E=emulsion M=mist spray
v_c = m/min (sf/min)
f_z = mm (in/tooth)
a_p = mm/DC (in/DC) = factor
a_e = mm/DC (in/DC) = factor
All cutting data are target values

JHF980

High feed – Universal – 2-5 Flutes – Cylindrical – Corner radius

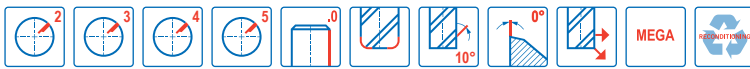
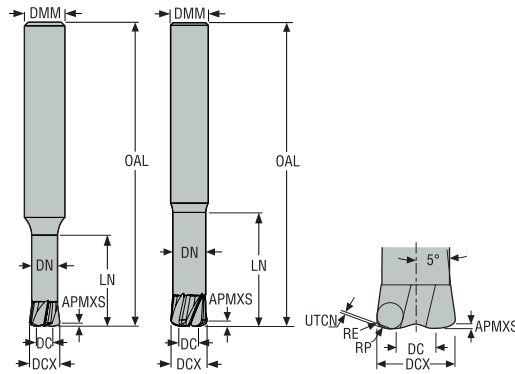

- Tolerances:
- DMM= h5
- DC= -0,02/-0,05 mm
- RE= ±0,05 mm
- Re grind possible if DC is ≥Ø6

Designation	Item number	Length index	Tool shape	DCX	DC	DMM	APMXS	OAL	LN	DN	RE	RP	UTCN	CA°	PCEDC	Cylindrical
				mm	mm	mm	mm	mm	mm	mm	mm	mm	mm			
980K080Z3-MEGA	02587115	1	E	8,0	4,0	8,0	0,4	70,0	12,0	3,0	0,6	0,935	0,198	-	3	■
JHF980080E1H.0Z5-MEGA	03003384	1	E	8,0	4,0	8,0	0,4	70,0	12,0	7,0	0,6	0,935	0,198	-	5	■
980K100Z3-MEGA	02587117	1	E	10,0	5,0	10,0	0,45	80,0	15,0	3,8	0,8	1,176	0,232	-	3	■
JHF980100E1H.0Z5-MEGA	03003385	1	E	10,0	5,0	10,0	0,45	80,0	15,0	8,8	0,8	1,176	0,232	-	5	■
980K120Z3-MEGA	02587118	1	E	12,0	6,0	12,0	0,5	80,0	18,0	4,6	1,0	1,417	0,265	-	3	■
JHF980120E1H.0Z5-MEGA	03003386	1	E	12,0	6,0	12,0	0,5	80,0	18,0	10,6	1,0	1,417	0,265	-	5	■
980010-MEGA	02587111	2	G	1,0	0,5	6,0	0,07	40,0	3,0	0,7	0,07	0,127	0,028	19,5	2	■
980015-MEGA	02511199	2	G	1,5	0,75	6,0	0,1	40,0	4,5	1,2	0,1	0,183	0,043	14,0	2	■
980020-MEGA	02511221	2	G	2,0	1,0	6,0	0,15	40,0	6,0	1,7	0,15	0,269	0,055	11,0	2	■
980030-MEGA	02511224	2	G	3,0	1,5	6,0	0,2	50,0	9,0	2,6	0,2	0,366	0,085	7,0	2	■
JHF980030G2H.0Z4-MEGA	03003387	2	G	3,0	1,5	6,0	0,2	50,0	9,0	2,6	0,2	0,366	0,085	7,12	4	■
980040-MEGA	02511229	2	G	4,0	2,0	6,0	0,25	60,0	12,0	3,5	0,3	0,503	0,107	4,0	2	■
JHF980040G2H.0Z4-MEGA	03003388	2	G	4,0	2,0	6,0	0,25	60,0	12,0	3,5	0,3	0,503	0,107	4,0	4	■
980050-MEGA	02511233	2	G	5,0	2,5	6,0	0,3	60,0	15,0	4,4	0,4	0,641	0,128	2,0	2	■
JHF980050G2H.0Z4-MEGA	03003389	2	G	5,0	2,5	6,0	0,3	60,0	15,0	4,4	0,4	0,641	0,128	1,77	4	■
980060-MEGA	02511314	2	G	6,0	3,0	8,0	0,35	60,0	18,0	5,2	0,5	0,778	0,15	3,0	2	■
JHF980060G2H.0Z4-MEGA	03003390	2	G	6,0	3,0	8,0	0,35	60,0	18,0	5,2	0,5	0,778	0,15	2,86	4	■
980080-MEGA	02511322	2	E	8,0	4,0	8,0	0,4	70,0	24,0	7,0	0,6	0,935	0,198	-	2	■
JHF980080E2H.0Z5-MEGA	03003391	2	E	8,0	4,0	8,0	0,4	70,0	24,0	7,0	0,6	0,935	0,198	-	5	■
980100-MEGA	02511341	2	E	10,0	5,0	10,0	0,45	80,0	30,0	8,8	0,8	1,176	0,232	-	2	■
980100Z3-MEGA	02511342	2	E	10,0	5,0	10,0	0,45	80,0	30,0	8,8	0,8	1,176	0,232	-	3	■
JHF980100E2H.0Z5-MEGA	03003392	2	E	10,0	5,0	10,0	0,45	80,0	30,0	8,8	0,8	1,176	0,232	-	5	■
980120-MEGA	02511346	2	E	12,0	6,0	12,0	0,5	80,0	36,0	10,6	1,0	1,417	0,265	-	2	■
980120Z3-MEGA	02511347	2	E	12,0	6,0	12,0	0,5	80,0	36,0	10,6	1,0	1,417	0,265	-	3	■
JHF980120E2H.0Z5-MEGA	03003393	2	E	12,0	6,0	12,0	0,5	80,0	36,0	10,6	1,0	1,417	0,265	-	5	■

■ Stocked standard.
*UTCN=uncut-thickness

Universal

Steel and cast iron

Stainless steel and S-materials

Non ferrous

Hard

Plastic and CFRP

Graphite

X-Heads

Minimaster Plus

Minimaster

JHF980

High feed – Universal – 2-5 Flutes – Cylindrical – Corner radius

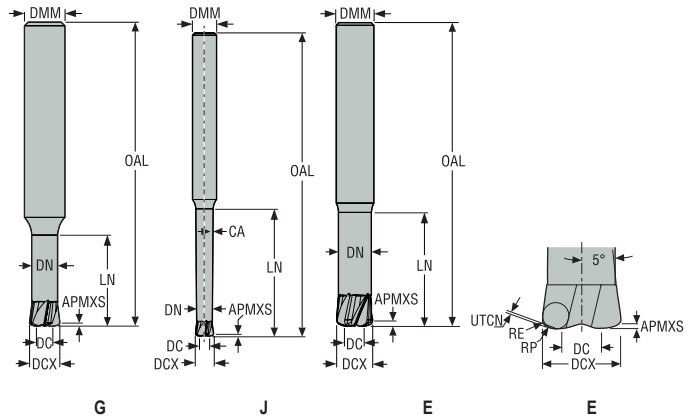

- Tolerances:
- DMM= h5
- DC= -0,02/-0,05 mm
- RE= ±0,05 mm
- Regrind possible if DC is ≥Ø6

Designation	Item number	Length index	Tool shape	DCX	DC	DMM	APMXS	OAL	LN	DN	RE	RP	UTCN	CA°	NA	PCEDC	Cylindrical
				mm	mm	mm	mm	mm	mm	mm	mm	mm	mm	mm	mm	mm	mm
980ML010-MEGA	02587113	3	G	1,0	0,5	6,0	0,07	40,0	5,0	0,7	0,07	0,127	0,028	15,5	0,0	2	■
980ML015-MEGA	02511219	3	G	1,5	0,75	6,0	0,1	40,0	7,5	1,2	0,1	0,183	0,043	10,5	0,0	2	■
980ML020-MEGA	02511222	3	G	2,0	1,0	6,0	0,15	40,0	10,0	1,7	0,15	0,269	0,055	8,0	0,0	2	■
JHF980020G3H.0Z4-MEGA	03003394	3	G	2,0	1,0	6,0	0,15	40,0	10,0	1,7	0,15	0,269	0,055	8,46	0,0	4	■
980ML030-MEGA	02511225	3	G	3,0	1,5	6,0	0,2	50,0	15,0	2,6	0,2	0,366	0,085	5,0	0,0	2	■
JHF980030G3H.0Z4-MEGA	03003395	3	G	3,0	1,5	6,0	0,2	50,0	15,0	2,6	0,2	0,366	0,085	4,79	0,0	4	■
980ML040-MEGA	02511231	3	G	4,0	2,0	6,0	0,25	70,0	20,0	3,5	0,3	0,503	0,107	2,5	0,0	2	■
JHF980040G3H.0Z4-MEGA	03003396	3	G	4,0	2,0	6,0	0,25	70,0	20,0	3,5	0,3	0,503	0,107	2,59	0,0	4	■
980ML050-MEGA	02511234	3	G	5,0	2,5	6,0	0,3	80,0	25,0	4,4	0,4	0,641	0,128	1,5	0,0	2	■
JHF980050G3H.0Z4-MEGA	03003397	3	G	5,0	2,5	6,0	0,3	80,0	25,0	4,4	0,4	0,641	0,128	1,12	0,0	4	■
980ML060-MEGA	02511315	3	G	6,0	3,0	8,0	0,35	80,0	30,0	5,2	0,5	0,778	0,15	2,0	0,0	2	■
JHF980060G3H.0Z4-MEGA	03003398	3	G	6,0	3,0	8,0	0,35	80,0	30,0	5,2	0,5	0,778	0,15	1,8	0,0	4	■
980ML080-MEGA	02511338	3	E	8,0	4,0	8,0	0,4	80,0	40,0	7,0	0,6	0,935	0,198	-	0,0	2	■
JHF980080E3H.0Z5-MEGA	03003399	3	E	8,0	4,0	8,0	0,4	80,0	40,0	7,0	0,6	0,935	0,198	-	0,0	5	■
980ML100-MEGA	02511344	3	E	10,0	5,0	10,0	0,45	90,0	50,0	8,8	0,8	1,176	0,232	-	0,0	2	■
JHF980100E3H.0Z5-MEGA	03003400	3	E	10,0	5,0	10,0	0,45	90,0	50,0	8,8	0,8	1,176	0,232	-	0,0	5	■
980ML120-MEGA	02511348	3	E	12,0	6,0	12,0	0,5	110,0	60,0	10,6	1,0	1,417	0,265	-	0,0	2	■
JHF980120E3H.0Z5-MEGA	03003401	3	E	12,0	6,0	12,0	0,5	110,0	60,0	10,6	1,0	1,417	0,265	-	0,0	5	■
980TL010-MEGA	02587114	4	J	1,0	0,5	6,0	0,07	40,0	7,0	0,7	0,07	0,127	0,028	13,0	0,5	2	■
980TL015-MEGA	02511220	4	J	1,5	0,75	6,0	0,1	40,0	10,5	1,2	0,1	0,183	0,043	8,5	0,5	2	■
980TL020-MEGA	02511223	4	J	2,0	1,0	6,0	0,15	50,0	14,0	1,7	0,15	0,269	0,055	6,5	0,5	2	■
980TL030-MEGA	02511226	4	J	3,0	1,5	6,0	0,2	60,0	21,0	2,6	0,2	0,366	0,085	3,5	0,5	2	■
JHF980030J4H.0Z4-MEGA	03003402	4	J	3,0	1,5	6,0	0,2	60,0	21,0	2,6	0,2	0,366	0,085	3,63	0,5	4	■
980TL040-MEGA	02511232	4	J	4,0	2,0	6,0	0,25	80,0	28,0	3,5	0,3	0,503	0,107	2,0	0,5	2	■
JHF980040J4H.0Z4-MEGA	03003403	4	J	4,0	2,0	6,0	0,25	80,0	28,0	3,5	0,3	0,503	0,107	1,93	0,5	4	■
980TL050-MEGA	02511240	4	J	5,0	2,5	6,0	0,3	90,0	35,0	4,4	0,4	0,641	0,128	1,0	0,5	2	■
JHF980050J4H.0Z4-MEGA	03003404	4	J	5,0	2,5	6,0	0,3	90,0	35,0	4,4	0,4	0,641	0,128	0,82	0,5	4	■
980TL060-MEGA	02511321	4	J	6,0	3,0	8,0	0,35	100,0	42,0	5,2	0,5	0,778	0,15	1,5	0,5	2	■
JHF980060J4H.0Z4-MEGA	03003405	4	J	6,0	3,0	8,0	0,35	100,0	42,0	5,2	0,5	0,778	0,15	1,33	0,5	4	■
980TL080-MEGA	02511340	4	E	8,0	4,0	8,0	0,4	100,0	56,0	7,0	0,6	0,935	0,198	-	0,5	2	■
JHF980080E4H.0Z5-MEGA	03003406	4	E	8,0	4,0	8,0	0,4	100,0	56,0	7,0	0,6	0,935	0,198	-	0,0	5	■
980TL100-MEGA	02511345	4	E	10,0	5,0	10,0	0,45	110,0	70,0	8,8	0,8	1,176	0,232	-	0,5	2	■
JHF980100E4H.0Z5-MEGA	03003407	4	E	10,0	5,0	10,0	0,45	110,0	70,0	8,8	0,8	1,176	0,232	-	0,0	5	■
980TL120-MEGA	02511349	4	E	12,0	6,0	12,0	0,5	130,0	84,0	10,6	1,0	1,417	0,265	-	0,5	2	■
JHF980120E4H.0Z5-MEGA	03003408	4	E	12,0	6,0	12,0	0,5	130,0	84,0	10,6	1,0	1,417	0,265	-	0,0	5	■

■ Stocked standard. *UTCN=uncut-thickness

Cutting data – JHF980 Side milling

SMG		a _p /DCX	a _e /DCX	f _z										v _c
				1	1.5	2	3	4	5	6	8	10	12	
P1	E/M/A	0.30	0.040	0.050	0.075	0.10	0.15	0.20	0.25	0.30	0.40	0.50	0.60	385 (350 – 430)
		0.30	0.040	0.0020	0.0030	0.0040	0.0060	0.0080	0.010	0.012	0.016	0.020	0.024	1275 (1200 – 1400)
P2	E/M/A	0.30	0.040	0.050	0.075	0.10	0.15	0.20	0.25	0.30	0.40	0.50	0.60	375 (340 – 410)
		0.30	0.040	0.0020	0.0030	0.0040	0.0060	0.0080	0.010	0.012	0.016	0.020	0.024	1225 (1200 – 1300)
P3	E/M/A	0.30	0.040	0.050	0.075	0.10	0.15	0.20	0.25	0.30	0.40	0.50	0.60	325 (290 – 360)
		0.30	0.040	0.0020	0.0030	0.0040	0.0060	0.0080	0.010	0.012	0.016	0.020	0.024	1075 (960 – 1100)
P4	E/M/A	0.30	0.040	0.050	0.075	0.10	0.15	0.20	0.25	0.30	0.40	0.50	0.60	285 (260 – 310)
		0.30	0.040	0.0020	0.0030	0.0040	0.0060	0.0080	0.010	0.012	0.016	0.020	0.024	940 (860 – 1000)
P5	E/M/A	0.30	0.040	0.050	0.075	0.10	0.15	0.20	0.25	0.30	0.40	0.50	0.60	275 (250 – 300)
		0.30	0.040	0.0020	0.0030	0.0040	0.0060	0.0080	0.010	0.012	0.016	0.020	0.024	900 (830 – 980)
P6	E/M/A	0.30	0.040	0.044	0.070	0.090	0.14	0.18	0.22	0.28	0.36	0.44	0.55	215 (190 – 240)
		0.30	0.040	0.0017	0.0028	0.0036	0.0055	0.0070	0.0085	0.011	0.014	0.017	0.022	710 (630 – 780)
P7	E/M/A	0.30	0.040	0.044	0.070	0.090	0.14	0.18	0.22	0.28	0.36	0.44	0.55	205 (180 – 230)
		0.30	0.040	0.0017	0.0028	0.0036	0.0055	0.0070	0.0085	0.011	0.014	0.017	0.022	670 (600 – 750)
P8	E/M/A	0.30	0.040	0.044	0.070	0.090	0.14	0.18	0.22	0.28	0.36	0.44	0.55	190 (170 – 210)
		0.30	0.040	0.0017	0.0028	0.0036	0.0055	0.0070	0.0085	0.011	0.014	0.017	0.022	620 (560 – 680)
P11	E/M/A	0.30	0.040	0.044	0.070	0.090	0.14	0.18	0.22	0.28	0.36	0.44	0.55	195 (170 – 220)
		0.30	0.040	0.0017	0.0028	0.0036	0.0055	0.0070	0.0085	0.011	0.014	0.017	0.022	640 (560 – 720)
P12	E/M/A	0.30	0.036	0.040	0.060	0.080	0.12	0.16	0.20	0.24	0.32	0.40	0.48	120 (110 – 130)
		0.30	0.036	0.0016	0.0024	0.0032	0.0048	0.0065	0.0080	0.0095	0.013	0.016	0.019	395 (370 – 420)
M1	E/M/A	0.30	0.036	0.040	0.060	0.080	0.12	0.16	0.20	0.24	0.32	0.40	0.48	190 (170 – 210)
		0.30	0.036	0.0016	0.0024	0.0032	0.0048	0.0065	0.0080	0.0095	0.013	0.016	0.019	620 (560 – 680)
M2	E/M/A	0.30	0.036	0.040	0.060	0.080	0.12	0.16	0.20	0.24	0.32	0.40	0.48	150 (140 – 160)
		0.30	0.036	0.0016	0.0024	0.0032	0.0048	0.0065	0.0080	0.0095	0.013	0.016	0.019	490 (460 – 520)
M3	E/M/A	0.30	0.036	0.040	0.060	0.080	0.12	0.16	0.20	0.24	0.32	0.40	0.48	115 (98 – 130)
		0.30	0.036	0.0016	0.0024	0.0032	0.0048	0.0065	0.0080	0.0095	0.013	0.016	0.019	375 (330 – 420)
M4	E/M/A	0.30	0.036	0.040	0.060	0.080	0.12	0.16	0.20	0.24	0.32	0.40	0.48	85 (73 – 100)
		0.30	0.036	0.0016	0.0024	0.0032	0.0048	0.0065	0.0080	0.0095	0.013	0.016	0.019	280 (240 – 320)
M5	E/M/A	0.30	0.036	0.040	0.060	0.080	0.12	0.16	0.20	0.24	0.32	0.40	0.48	70 (61 – 83)
		0.30	0.036	0.0016	0.0024	0.0032	0.0048	0.0065	0.0080	0.0095	0.013	0.016	0.019	230 (210 – 270)
K1	E/M/A	0.30	0.040	0.040	0.060	0.080	0.12	0.16	0.20	0.24	0.32	0.40	0.48	225 (200 – 250)
		0.30	0.040	0.0016	0.0024	0.0032	0.0048	0.0065	0.0080	0.0095	0.013	0.016	0.019	740 (660 – 820)
K2	E/M/A	0.30	0.040	0.040	0.060	0.080	0.12	0.16	0.20	0.24	0.32	0.40	0.48	195 (170 – 220)
		0.30	0.040	0.0016	0.0024	0.0032	0.0048	0.0065	0.0080	0.0095	0.013	0.016	0.019	640 (560 – 720)
K3	E/M/A	0.30	0.040	0.040	0.060	0.080	0.12	0.16	0.20	0.24	0.32	0.40	0.48	165 (150 – 180)
		0.30	0.040	0.0016	0.0024	0.0032	0.0048	0.0065	0.0080	0.0095	0.013	0.016	0.019	540 (500 – 590)
K4	E/M/A	0.30	0.040	0.040	0.060	0.080	0.12	0.16	0.20	0.24	0.32	0.40	0.48	155 (140 – 170)
		0.30	0.040	0.0016	0.0024	0.0032	0.0048	0.0065	0.0080	0.0095	0.013	0.016	0.019	510 (460 – 550)
K5	E/M/A	0.30	0.040	0.032	0.050	0.065	0.10	0.13	0.16	0.20	0.26	0.32	0.40	165 (140 – 190)
		0.30	0.040	0.0013	0.0020	0.0026	0.0040	0.0050	0.0065	0.0080	0.010	0.013	0.016	540 (460 – 620)
K6	E/M/A	0.30	0.040	0.032	0.050	0.065	0.10	0.13	0.16	0.20	0.26	0.32	0.40	245 (200 – 290)
		0.30	0.040	0.0013	0.0020	0.0026	0.0040	0.0050	0.0065	0.0080	0.010	0.013	0.016	800 (660 – 950)
K7	E/M/A	0.30	0.040	0.032	0.050	0.065	0.10	0.13	0.16	0.20	0.26	0.32	0.40	210 (170 – 250)
		0.30	0.040	0.0013	0.0020	0.0026	0.0040	0.0050	0.0065	0.0080	0.010	0.013	0.016	690 (560 – 820)
S1	E	0.30	0.022	0.024	0.036	0.048	0.070	0.095	0.12	0.14	0.19	0.24	0.28	60 (50 – 74)
		0.30	0.022	0.00095	0.0014	0.0019	0.0028	0.0038	0.0048	0.0055	0.0075	0.0095	0.011	195 (170 – 240)
S2	E	0.30	0.022	0.024	0.036	0.048	0.070	0.095	0.12	0.14	0.19	0.24	0.28	50 (41 – 60)
		0.30	0.022	0.00095	0.0014	0.0019	0.0028	0.0038	0.0048	0.0055	0.0075	0.0095	0.011	165 (140 – 190)
S3	E	0.30	0.022	0.024	0.036	0.048	0.070	0.095	0.12	0.14	0.19	0.24	0.28	37 (25 – 49)
		0.30	0.022	0.00095	0.0014	0.0019	0.0028	0.0038	0.0048	0.0055	0.0075	0.0095	0.011	120 (83 – 160)
S11	E	0.30	0.022	0.036	0.050	0.070	0.10	0.14	0.18	0.20	0.28	0.36	0.42	175 (160 – 190)
		0.30	0.022	0.0014	0.0020	0.0028	0.0040	0.0055	0.0070	0.0080	0.011	0.014	0.017	570 (530 – 620)
S12	E	0.30	0.022	0.036	0.050	0.070	0.10	0.14	0.18	0.20	0.28	0.36	0.42	135 (120 – 150)
		0.30	0.022	0.0014	0.0020	0.0028	0.0040	0.0055	0.0070	0.0080	0.011	0.014	0.017	445 (400 – 490)
S13	E	0.30	0.022	0.036	0.050	0.070	0.10	0.14	0.18	0.20	0.28	0.36	0.42	105 (90 – 110)
		0.30	0.022	0.0014	0.0020	0.0028	0.0040	0.0055	0.0070	0.0080	0.011	0.014	0.017	345 (300 – 360)
H5	M/A/D	0.30	0.036	0.040	0.060	0.080	0.12	0.16	0.20	0.24	0.32	0.40	0.48	115 (98 – 130)
		0.30	0.036	0.0016	0.0024	0.0032	0.0048	0.0065	0.0080	0.0095	0.013	0.016	0.019	375 (330 – 420)
H8	M/A/D	0.30	0.036	0.040	0.060	0.080	0.12	0.16	0.20	0.24	0.32	0.40	0.48	115 (98 – 130)
		0.30	0.036	0.0016	0.0024	0.0032	0.0048	0.0065	0.0080	0.0095	0.013	0.016	0.019	375 (330 – 420)
H21	M/A/D	0.30	0.036	0.040	0.060	0.080	0.12	0.16	0.20	0.24	0.32	0.40	0.48	115 (98 – 130)
		0.30	0.036	0.0016	0.0024	0.0032	0.0048	0.0065	0.0080	0.0095	0.013	0.016	0.019	375 (330 – 420)
H31	M/A/D	0.30	0.036	0.040	0.060	0.080	0.12	0.16	0.20	0.24	0.32	0.40	0.48	90 (74 – 100)
		0.30	0.036	0.0016	0.0024	0.0032	0.0048	0.0065	0.0080	0.0095	0.013	0.016	0.019	295 (250 – 320)

For cutting data recalculations, see pages 556 - 563

SMG = Seco material group
Coolant = A=air D=dry E=emulsion M=mist spray
v_c = m/min (sf/min)
f_z = mm (in/tooth)
a_p = mm/DC (in/DC) = factor
a_e = mm/DC (in/DC) = factor
All cutting data are target values

Universal
Steel and cast iron
Stainless steel and S-materials
Non ferrous
Hard
Plastic and CFRP
Graphite
X-Heads
Minimaster Plus
Minimaster

Cutting data – JHF980 Slot milling

SMG	Coolant	a _p /DCX	f _z										v _c		
			1	1.5	2	3	4	5	6	8	10	12			
Universal Steel and cast iron	P1	E/M/A 0,040	0.040	0.030	0.046	0.060	0.090	0.12	0.15	0.18	0.24	0.30	0.36	340 (310 – 370)	
			0,040	0,0012	0,0018	0,0024	0,0036	0,0048	0,0060	0,0070	0,0095	0,012	0,014	1125 (1100 – 1200)	
	P2	E/M/A 0,040	0.040	0.030	0.046	0.060	0.090	0.12	0.15	0.18	0.24	0.30	0.36	330 (300 – 360)	
			0,040	0,0012	0,0018	0,0024	0,0036	0,0048	0,0060	0,0070	0,0095	0,012	0,014	1075 (990 – 1100)	
	P3	E/M/A 0,040	0.040	0.030	0.046	0.060	0.090	0.12	0.15	0.18	0.24	0.30	0.36	285 (260 – 310)	
			0,040	0,0012	0,0018	0,0024	0,0036	0,0048	0,0060	0,0070	0,0095	0,012	0,014	940 (860 – 1000)	
	P4	E/M/A 0,040	0.040	0.030	0.046	0.060	0.090	0.12	0.15	0.18	0.24	0.30	0.36	250 (230 – 270)	
			0,040	0,0012	0,0018	0,0024	0,0036	0,0048	0,0060	0,0070	0,0095	0,012	0,014	820 (760 – 880)	
	P5	E/M/A 0,040	0.040	0.030	0.046	0.060	0.090	0.12	0.15	0.18	0.24	0.30	0.36	240 (220 – 260)	
			0,040	0,0012	0,0018	0,0024	0,0036	0,0048	0,0060	0,0070	0,0095	0,012	0,014	790 (730 – 850)	
	P6	E/M/A 0,040	0.040	0.028	0.040	0.055	0.080	0.11	0.14	0.16	0.22	0.28	0.32	185 (160 – 210)	
			0,040	0,0011	0,0016	0,0022	0,0032	0,0044	0,0055	0,0065	0,0085	0,011	0,013	610 (530 – 680)	
P7	E/M/A 0,040	0.040	0.028	0.040	0.055	0.080	0.11	0.14	0.16	0.22	0.28	0.32	175 (160 – 200)		
		0,040	0,0011	0,0016	0,0022	0,0032	0,0044	0,0055	0,0065	0,0085	0,011	0,013	570 (530 – 650)		
P8	E/M/A 0,040	0.040	0.028	0.040	0.055	0.080	0.11	0.14	0.16	0.22	0.28	0.32	165 (150 – 180)		
		0,040	0,0011	0,0016	0,0022	0,0032	0,0044	0,0055	0,0065	0,0085	0,011	0,013	540 (500 – 590)		
P11	E/M/A 0,040	0.040	0.028	0.040	0.055	0.080	0.11	0.14	0.16	0.22	0.28	0.32	170 (150 – 190)		
		0,040	0,0011	0,0016	0,0022	0,0032	0,0044	0,0055	0,0065	0,0085	0,011	0,013	560 (500 – 620)		
P12	E/M/A 0,036	0.036	0.024	0.036	0.048	0.070	0.095	0.12	0.14	0.19	0.24	0.28	105 (90 – 110)		
		0,036	0,00095	0,0014	0,0019	0,0028	0,0038	0,0048	0,0055	0,0075	0,0095	0,011	345 (300 – 360)		
Non ferrous	M1	E/M/A 0,036	0.036	0.024	0.036	0.048	0.070	0.095	0.12	0.14	0.19	0.24	0.28	165 (150 – 180)	
			0,036	0,00095	0,0014	0,0019	0,0028	0,0038	0,0048	0,0055	0,0075	0,0095	0,011	540 (500 – 590)	
	M2	E/M/A 0,036	0.036	0.024	0.036	0.048	0.070	0.095	0.12	0.14	0.19	0.24	0.28	130 (120 – 140)	
			0,036	0,00095	0,0014	0,0019	0,0028	0,0038	0,0048	0,0055	0,0075	0,0095	0,011	425 (400 – 450)	
	M3	E/M/A 0,036	0.036	0.024	0.036	0.048	0.070	0.095	0.12	0.14	0.19	0.24	0.28	100 (85 – 110)	
			0,036	0,00095	0,0014	0,0019	0,0028	0,0038	0,0048	0,0055	0,0075	0,0095	0,011	330 (280 – 360)	
	M4	E/M/A 0,036	0.036	0.024	0.036	0.048	0.070	0.095	0.12	0.14	0.19	0.24	0.28	75 (64 – 87)	
			0,036	0,00095	0,0014	0,0019	0,0028	0,0038	0,0048	0,0055	0,0075	0,0095	0,011	245 (210 – 280)	
	M5	E/M/A 0,036	0.036	0.024	0.036	0.048	0.070	0.095	0.12	0.14	0.19	0.24	0.28	65 (53 – 72)	
			0,036	0,00095	0,0014	0,0019	0,0028	0,0038	0,0048	0,0055	0,0075	0,0095	0,011	215 (180 – 230)	
	Hard	K1	E/M/A 0,040	0.040	0.030	0.046	0.060	0.090	0.12	0.15	0.18	0.24	0.30	0.36	185 (160 – 210)
				0,040	0,0012	0,0018	0,0024	0,0036	0,0048	0,0060	0,0070	0,0095	0,012	0,014	610 (530 – 680)
K2		E/M/A 0,040	0.040	0.030	0.046	0.060	0.090	0.12	0.15	0.18	0.24	0.30	0.36	160 (140 – 180)	
			0,040	0,0012	0,0018	0,0024	0,0036	0,0048	0,0060	0,0070	0,0095	0,012	0,014	520 (460 – 590)	
K3		E/M/A 0,040	0.040	0.030	0.046	0.060	0.090	0.12	0.15	0.18	0.24	0.30	0.36	135 (120 – 150)	
			0,040	0,0012	0,0018	0,0024	0,0036	0,0048	0,0060	0,0070	0,0095	0,012	0,014	445 (400 – 490)	
K4		E/M/A 0,040	0.040	0.030	0.046	0.060	0.090	0.12	0.15	0.18	0.24	0.30	0.36	130 (120 – 140)	
			0,040	0,0012	0,0018	0,0024	0,0036	0,0048	0,0060	0,0070	0,0095	0,012	0,014	425 (400 – 450)	
K5		E/M/A 0,040	0.040	0.028	0.040	0.055	0.080	0.11	0.14	0.16	0.22	0.28	0.32	135 (110 – 150)	
			0,040	0,0011	0,0016	0,0022	0,0032	0,0044	0,0055	0,0065	0,0085	0,011	0,013	445 (370 – 490)	
K6		E/M/A 0,040	0.040	0.028	0.040	0.055	0.080	0.11	0.14	0.16	0.22	0.28	0.32	195 (160 – 230)	
			0,040	0,0011	0,0016	0,0022	0,0032	0,0044	0,0055	0,0065	0,0085	0,011	0,013	640 (530 – 750)	
K7	E/M/A 0,040	0.040	0.028	0.040	0.055	0.080	0.11	0.14	0.16	0.22	0.28	0.32	170 (140 – 200)		
		0,040	0,0011	0,0016	0,0022	0,0032	0,0044	0,0055	0,0065	0,0085	0,011	0,013	560 (460 – 650)		
Plastic and cfrp	S1	E 0,022	0.018	0.028	0.036	0.055	0.070	0.090	0.11	0.14	0.18	0.22	50 (42 – 62)		
			0,00070	0,0011	0,0014	0,0022	0,0028	0,0036	0,0044	0,0055	0,0070	0,0085	0,011	165 (140 – 200)	
	S2	E 0,022	0.018	0.028	0.036	0.055	0.070	0.090	0.11	0.14	0.18	0.22	42 (34 – 50)		
			0,00070	0,0011	0,0014	0,0022	0,0028	0,0036	0,0044	0,0055	0,0070	0,0085	0,011	140 (120 – 160)	
	S3	E 0,022	0.018	0.028	0.036	0.055	0.070	0.090	0.11	0.14	0.18	0.22	31 (21 – 41)		
			0,00070	0,0011	0,0014	0,0022	0,0028	0,0036	0,0044	0,0055	0,0070	0,0085	0,011	100 (69 – 130)	
	S11	E 0,022	0.018	0.028	0.036	0.055	0.070	0.090	0.11	0.14	0.18	0.22	155 (140 – 170)		
			0,00070	0,0011	0,0014	0,0022	0,0028	0,0036	0,0044	0,0055	0,0070	0,0085	0,011	510 (460 – 550)	
	S12	E 0,022	0.018	0.028	0.036	0.055	0.070	0.090	0.11	0.14	0.18	0.22	120 (110 – 130)		
			0,00070	0,0011	0,0014	0,0022	0,0028	0,0036	0,0044	0,0055	0,0070	0,0085	0,011	395 (370 – 420)	
	S13	E 0,022	0.018	0.028	0.036	0.055	0.070	0.090	0.11	0.14	0.18	0.22	95 (82 – 100)		
			0,00070	0,0011	0,0014	0,0022	0,0028	0,0036	0,0044	0,0055	0,0070	0,0085	0,011	310 (270 – 320)	
X-Heads	H5	M/A/D 0,036	0.024	0.036	0.048	0.070	0.095	0.12	0.14	0.19	0.24	0.28	100 (86 – 110)		
			0,00095	0,0014	0,0019	0,0028	0,0038	0,0048	0,0055	0,0075	0,0095	0,011	330 (290 – 360)		
	H8	M/A/D 0,036	0.024	0.036	0.048	0.070	0.095	0.12	0.14	0.19	0.24	0.28	100 (86 – 110)		
			0,00095	0,0014	0,0019	0,0028	0,0038	0,0048	0,0055	0,0075	0,0095	0,011	330 (290 – 360)		
	H21	M/A/D 0,036	0.024	0.036	0.048	0.070	0.095	0.12	0.14	0.19	0.24	0.28	100 (86 – 110)		
			0,00095	0,0014	0,0019	0,0028	0,0038	0,0048	0,0055	0,0075	0,0095	0,011	330 (290 – 360)		
	H31	M/A/D 0,036	0.024	0.036	0.048	0.070	0.095	0.12	0.14	0.19	0.24	0.28	75 (65 – 88)		
			0,00095	0,0014	0,0019	0,0028	0,0038	0,0048	0,0055	0,0075	0,0095	0,011	245 (220 – 280)		

For cutting data recalculations, see pages 556 - 563

SMG = Seco material group
Coolant = A=air D=dry E=emulsion M=mist spray
v_c = m/min (sf/min)
f_z = mm/tooth (in/tooth)
a_p = mm/DC (in/DC) = factor
a_e = mm/DC (in/DC) = factor
All cutting data are target values

J29

General purpose – Universal – Engraving – 1 Flute – Cylindrical

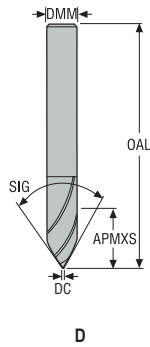

D

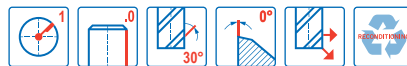

- Tolerances:
- DMM=h5
- Re grind possible if DMM is $\geq \varnothing 6$

Designation	Item number	Length index	Tool shape	DC	DMM	APMXS	OAL	SIG°	PCEDC	Cylindrical
				mm	mm	mm	mm			
29030	00029373	2	D	0,2	3,0	2,6	40,0	60,0	1	■
29040	00029381	2	D	0,2	4,0	3,5	50,0	60,0	1	■
29060	00029396	2	D	0,2	6,0	5,2	50,0	60,0	1	■

■ Stocked standard.

Universal

Steel and cast iron

Stainless steel and S-materials

Non ferrous

Hard

Plastic and CFRP

Graphite

X-Heads

Minimaster Plus

Minimaster

Cutting data – J29 Slot milling

Universal	SMG		a _p /DC	f _z			v _c
				3	4	6	
Steel and cast iron	P1	E	0.50	0.24	0.26	0.28	42 (32 – 63)
			0.50	0,0095	0,010	0,011	140 (110 – 200)
	P2	E	0.50	0.24	0.26	0.30	41 (32 – 61)
			0.50	0,0095	0,010	0,012	135 (110 – 200)
	P3	E	0.50	0.24	0.25	0.28	36 (28 – 54)
			0.50	0,0095	0,010	0,011	120 (92 – 170)
P4	E	0.50	0.22	0.24	0.26	31 (24 – 47)	
		0.50	0,0085	0,0095	0,010	100 (79 – 150)	
P5	E	0.50	0.22	0.24	0.26	30 (23 – 45)	
		0.50	0,0085	0,0095	0,010	100 (76 – 140)	
Stainless steel and S-materials	P6	E	0.50	0.22	0.24	0.26	34 (26 – 51)
			0.50	0,0085	0,0095	0,010	110 (86 – 160)
	P7	E	0.50	0.22	0.24	0.26	32 (25 – 48)
			0.50	0,0085	0,0095	0,010	105 (83 – 150)
	P8	E	0.50	0.24	0.25	0.28	30 (23 – 45)
			0.50	0,0095	0,010	0,011	100 (76 – 140)
P11	E	0.50	0.22	0.24	0.26	31 (24 – 46)	
		0.50	0,0085	0,0095	0,010	100 (79 – 150)	
Non ferrous	P12	E	0.50	0.15	0.16	0.18	19 (15 – 29)
			0.50	0,0060	0,0065	0,0070	60 (50 – 95)
	M1	E	0.50	0.22	0.24	0.26	30 (23 – 45)
			0.50	0,0085	0,0095	0,010	100 (76 – 140)
	M2	E	0.50	0.22	0.24	0.26	30 (23 – 45)
			0.50	0,0085	0,0095	0,010	100 (76 – 140)
M3	E	0.50	0.18	0.19	0.22	24 (18 – 35)	
		0.50	0,0070	0,0075	0,0085	80 (60 – 110)	
M4	E	0.50	0.16	0.17	0.18	18 (14 – 27)	
		0.50	0,0065	0,0065	0,0070	60 (46 – 88)	
M5	E	0.50	0.16	0.17	0.18	15 (12 – 22)	
		0.50	0,0065	0,0065	0,0070	49 (40 – 72)	
Hard	K1	E	0.50	0.22	0.24	0.26	30 (23 – 45)
			0.50	0,0085	0,0095	0,010	100 (76 – 140)
	K2	E	0.50	0.20	0.22	0.24	26 (21 – 40)
			0.50	0,0080	0,0085	0,0095	85 (69 – 130)
	K3	E	0.50	0.20	0.22	0.24	22 (17 – 33)
			0.50	0,0080	0,0085	0,0095	70 (56 – 100)
K4	E	0.50	0.20	0.22	0.24	21 (17 – 32)	
		0.50	0,0080	0,0085	0,0095	70 (56 – 100)	
K5	E	0.50	0.18	0.20	0.22	13 (9.8 – 19)	
		0.50	0,0070	0,0080	0,0085	43 (33 – 62)	
K6	E	0.50	0.20	0.22	0.24	19 (15 – 28)	
		0.50	0,0080	0,0085	0,0095	60 (50 – 91)	
K7	E	0.50	0.18	0.20	0.22	16 (13 – 25)	
		0.50	0,0070	0,0080	0,0085	50 (43 – 82)	

For cutting data recalculations, see pages 556 - 563

SMG = Seco material group
Coolant = A=air D=dry E=emulsion M=mist spray
v_c = m/min (sf/min)
f_z = mm/tooth (in/tooth)
a_p = mm/DC (in/DC) = factor
a_e = mm/DC (in/DC) = factor
All cutting data are target values

Cutting data – J29 Slot milling

SMG		a _p /DC	f _z			v _c
			3	4	6	
N1	E	0.50	0.22	0.24	0.26	30 (23 – 45)
		0,50	0,0085	0,0095	0,010	100 (76 – 140)
N2	E	0.50	0.22	0.24	0.26	19 (15 – 29)
		0,50	0,0085	0,0095	0,010	60 (50 – 95)
N3	E	0.50	0.22	0.24	0.26	13 (9.8 – 19)
		0,50	0,0085	0,0095	0,010	43 (33 – 62)
N11	E	0.50	0.22	0.24	0.26	17 (14 – 26)
		0,50	0,0085	0,0095	0,010	55 (46 – 85)
S1	E	0.50	0.24	0.26	0.28	43 (33 – 64)
		0,50	0,0095	0,010	0,011	140 (110 – 200)
S2	E	0.50	0.24	0.26	0.28	34 (27 – 51)
		0,50	0,0095	0,010	0,011	110 (89 – 160)
S3	E	0.50	0.22	0.24	0.26	30 (23 – 45)
		0,50	0,0085	0,0095	0,010	100 (76 – 140)
S11	E	0.50	0.22	0.24	0.26	39 (30 – 59)
		0,50	0,0085	0,0095	0,010	130 (99 – 190)
S12	E	0.50	0.22	0.24	0.26	30 (23 – 45)
		0,50	0,0085	0,0095	0,010	100 (76 – 140)
S13	E	0.50	0.19	0.20	0.24	24 (18 – 35)
		0,50	0,0075	0,0080	0,0095	80 (60 – 110)
H5	M/A/D	0.50	0.22	0.24	0.26	30 (23 – 45)
		0,50	0,0085	0,0095	0,010	100 (76 – 140)
H8	M/A/D	0.50	0.17	0.18	0.20	32 (24 – 47)
		0,50	0,0065	0,0070	0,0080	105 (79 – 150)
H11	M/A/D	0.50	0.22	0.24	0.26	39 (30 – 58)
		0,50	0,0085	0,0095	0,010	130 (99 – 190)
H12	M/A/D	0.50	0.12	0.12	0.14	12 (9.1 – 18)
		0,50	0,0048	0,0048	0,0055	39 (30 – 59)
H21	M/A/D	0.50	0.17	0.18	0.20	32 (24 – 47)
		0,50	0,0065	0,0070	0,0080	105 (79 – 150)
H31	M/A/D	0.50	0.15	0.16	0.17	24 (19 – 36)
		0,50	0,0060	0,0065	0,0065	80 (63 – 110)
TS1	E	0.50	0.22	0.24	0.26	30 (23 – 45)
		0,50	0,0085	0,0095	0,010	100 (76 – 140)
TP1	E	0.50	0.22	0.24	0.26	30 (23 – 45)
		0,50	0,0085	0,0095	0,010	100 (76 – 140)
GR1	D	0.50	0.22	0.24	0.26	30 (23 – 45)
		0,50	0,0085	0,0095	0,010	100 (76 – 140)

For cutting data recalculations, see pages 556 - 563

SMG = Seco material group
 Coolant = A=air D=dry E=emulsion M=mist spray
 v_c = m/min (sf/min)
 f_z = mm/tooth (in/tooth)
 a_p = mm/DC (in/DC) = factor
 a_e = mm/DC (in/DC) = factor
 All cutting data are target values

Universal
 Steel and cast iron
 Stainless steel and S-materials
 Non ferrous
 Hard
 Plastic and CFRP
 Graphite
 X-Heads
 Minmaster Plus
 Minmaster

J36

General purpose – Universal – Square – 3 Flutes – Cylindrical – Corner radius

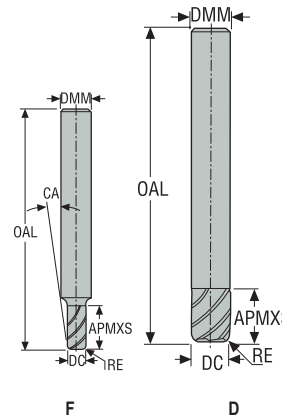

- Tolerances:
- DMM= h5
- DC= Ø2-Ø6= -0,02/-0,034 mm
- DC= Ø8-Ø20= -0,02/-0,044 mm
- RE= Ø2-Ø12= +0,05 mm
- RE= Ø14-Ø20= +0,1 mm
- Regrind possible if DC is ≥Ø6

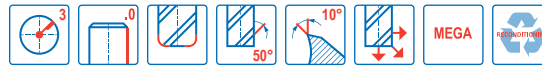

Designation	Item number	Length index	Tool shape	DC	DMM	APMXS	OAL	RE	CA°	PCEDC	Cylindrical
				mm	mm	mm	mm	mm	mm		
36020-MEGA	00025621	2	F	2,0	3,0	9,0	40,0	0,1	2,5	3	■
36030-MEGA	00025626	2	D	3,0	3,0	12,0	40,0	0,1	-	3	■
36040-MEGA	00025628	2	D	4,0	4,0	14,0	50,0	0,1	-	3	■
36050-MEGA	00025651	2	D	5,0	5,0	20,0	50,0	0,1	-	3	■
36060-MEGA	00025663	2	D	6,0	6,0	20,0	65,0	0,1	-	3	■
36080-MEGA	00025674	2	D	8,0	8,0	20,0	65,0	0,2	-	3	■
36100-MEGA	00025680	2	D	10,0	10,0	25,0	75,0	0,2	-	3	■
36120-MEGA	00025681	2	D	12,0	12,0	25,0	75,0	0,2	-	3	■
36160-MEGA	00025689	2	D	16,0	16,0	30,0	90,0	0,5	-	3	■
36200-MEGA	00025692	2	D	20,0	20,0	40,0	100,0	0,5	-	3	■

■ Stocked standard.

Universal

Steel and cast iron

Stainless steel and S-materials

Non ferrous

Hard

Plastic and cfrp

Graphite

X-Heads

Minimaster Plus

Minimaster

Cutting data – J36 Side milling

SMG		a _e /DC	a _p /DC	f _z										v _c
				2	3	4	5	6	8	10	12	16	20	
P1	E	0.200	1.0	0.013	0.019	0.026	0.032	0.038	0.050	0.065	0.075	0.095	0.11	200 (170 – 220)
		0,200	1,0	0,00050	0,00075	0,0010	0,0013	0,0015	0,0020	0,0026	0,0030	0,0038	0,0044	660 (560 – 720)
P2	E	0.200	1.0	0.013	0.020	0.026	0.034	0.040	0.055	0.065	0.080	0.095	0.11	190 (170 – 210)
		0,200	1,0	0,00050	0,00080	0,0010	0,0013	0,0016	0,0022	0,0026	0,0032	0,0038	0,0044	620 (560 – 680)
P3	E	0.200	1.0	0.012	0.019	0.025	0.032	0.038	0.050	0.060	0.075	0.090	0.11	170 (150 – 190)
		0,200	1,0	0,00048	0,00075	0,0010	0,0013	0,0015	0,0020	0,0024	0,0030	0,0036	0,0044	560 (500 – 620)
P4	E	0.200	1.0	0.012	0.018	0.024	0.030	0.036	0.048	0.060	0.070	0.090	0.10	150 (130 – 160)
		0,200	1,0	0,00048	0,00070	0,00095	0,0012	0,0014	0,0019	0,0024	0,0028	0,0036	0,0040	490 (430 – 520)
P5	E	0.200	1.0	0.012	0.018	0.024	0.030	0.036	0.048	0.060	0.070	0.090	0.10	140 (130 – 160)
		0,200	1,0	0,00048	0,00070	0,00095	0,0012	0,0014	0,0019	0,0024	0,0028	0,0036	0,0040	460 (430 – 520)
P6	E	0.200	1.0	0.012	0.018	0.024	0.030	0.036	0.048	0.060	0.070	0.085	0.10	160 (140 – 180)
		0,200	1,0	0,00048	0,00070	0,00095	0,0012	0,0014	0,0019	0,0024	0,0028	0,0034	0,0040	520 (460 – 590)
P7	E	0.200	1.0	0.012	0.018	0.024	0.030	0.036	0.048	0.060	0.070	0.085	0.10	150 (130 – 170)
		0,200	1,0	0,00048	0,00070	0,00095	0,0012	0,0014	0,0019	0,0024	0,0028	0,0034	0,0040	490 (430 – 550)
P8	E	0.200	1.0	0.012	0.019	0.025	0.032	0.038	0.050	0.060	0.075	0.090	0.11	140 (130 – 160)
		0,200	1,0	0,00048	0,00075	0,0010	0,0013	0,0015	0,0020	0,0024	0,0030	0,0036	0,0044	460 (430 – 520)
P11	E	0.200	1.0	0.012	0.018	0.024	0.030	0.036	0.048	0.060	0.070	0.085	0.10	145 (130 – 160)
		0,200	1,0	0,00048	0,00070	0,00095	0,0012	0,0014	0,0019	0,0024	0,0028	0,0034	0,0040	475 (430 – 520)
P12	E	0.200	1.0	0.0080	0.012	0.016	0.020	0.024	0.032	0.040	0.048	0.060	0.070	90 (79 – 100)
		0,200	1,0	0,00032	0,00048	0,00065	0,00080	0,00095	0,0013	0,0016	0,0019	0,0024	0,0028	295 (260 – 320)
M1	E	0.200	1.0	0.015	0.024	0.030	0.038	0.046	0.060	0.075	0.090	0.11	0.13	115 (92 – 140)
		0,200	1,0	0,00060	0,00095	0,0012	0,0015	0,0018	0,0024	0,0030	0,0036	0,0044	0,0050	375 (310 – 450)
M2	E	0.200	1.0	0.014	0.020	0.028	0.034	0.042	0.055	0.070	0.085	0.10	0.12	95 (76 – 110)
		0,200	1,0	0,00055	0,00080	0,0011	0,0013	0,0017	0,0022	0,0028	0,0034	0,0040	0,0048	310 (250 – 360)
M3	E	0.100	1.0	0.010	0.015	0.020	0.025	0.030	0.040	0.050	0.060	0.075	0.085	75 (56 – 95)
		0,100	1,0	0,00040	0,00060	0,00080	0,0010	0,0012	0,0016	0,0020	0,0024	0,0030	0,0034	245 (190 – 310)
M4	E	0.100	1.0	0.0085	0.013	0.017	0.022	0.026	0.034	0.044	0.050	0.065	0.075	60 (43 – 73)
		0,100	1,0	0,00034	0,00050	0,00065	0,00085	0,0010	0,0013	0,0017	0,0020	0,0026	0,0030	195 (150 – 230)
M5	E	0.100	1.0	0.0085	0.013	0.017	0.022	0.026	0.034	0.044	0.050	0.065	0.075	48 (36 – 60)
		0,100	1,0	0,00034	0,00050	0,00065	0,00085	0,0010	0,0013	0,0017	0,0020	0,0026	0,0030	155 (120 – 190)
K1	E	0.200	1.0	0.012	0.018	0.024	0.030	0.036	0.048	0.060	0.070	0.090	0.10	140 (130 – 160)
		0,200	1,0	0,00048	0,00070	0,00095	0,0012	0,0014	0,0019	0,0024	0,0028	0,0036	0,0040	460 (430 – 520)
K2	E	0.200	1.0	0.011	0.016	0.022	0.028	0.032	0.044	0.055	0.065	0.080	0.090	125 (110 – 140)
		0,200	1,0	0,00044	0,00065	0,00085	0,0011	0,0013	0,0017	0,0022	0,0026	0,0032	0,0036	410 (370 – 450)
K3	E	0.200	1.0	0.011	0.016	0.022	0.028	0.032	0.044	0.055	0.065	0.080	0.090	105 (91 – 120)
		0,200	1,0	0,00044	0,00065	0,00085	0,0011	0,0013	0,0017	0,0022	0,0026	0,0032	0,0036	345 (300 – 390)
K4	E	0.200	1.0	0.011	0.016	0.022	0.028	0.032	0.044	0.055	0.065	0.080	0.090	100 (87 – 110)
		0,200	1,0	0,00044	0,00065	0,00085	0,0011	0,0013	0,0017	0,0022	0,0026	0,0032	0,0036	330 (290 – 360)
K5	E	0.200	1.0	0.010	0.015	0.020	0.025	0.030	0.040	0.050	0.060	0.070	0.085	60 (53 – 69)
		0,200	1,0	0,00040	0,00060	0,00080	0,0010	0,0012	0,0016	0,0020	0,0024	0,0028	0,0034	195 (180 – 220)
K6	E	0.200	1.0	0.011	0.016	0.022	0.028	0.032	0.044	0.055	0.065	0.080	0.090	90 (76 – 100)
		0,200	1,0	0,00044	0,00065	0,00085	0,0011	0,0013	0,0017	0,0022	0,0026	0,0032	0,0036	295 (250 – 320)
K7	E	0.200	1.0	0.010	0.015	0.020	0.025	0.030	0.040	0.050	0.060	0.070	0.085	80 (67 – 89)
		0,200	1,0	0,00040	0,00060	0,00080	0,0010	0,0012	0,0016	0,0020	0,0024	0,0028	0,0034	260 (220 – 290)

For cutting data recalculations, see pages 556 - 563

SMG = Seco material group
 Coolant = A=air D=dry E=emulsion M=mist spray
 v_c = m/min (sf/min)
 f_z = mm (in/tooth)
 a_p = mm/DC (in/DC) = factor
 a_e = mm/DC (in/DC) = factor
 All cutting data are target values

Universal
Steel and cast iron
Stainless steel and S-materials
Non ferrous
Hard
Plastic and CFRP
Graphite
X-Heads
Minimaster Plus
Minimaster

Cutting data – J36 Side milling

SMG		a _e /DC	a _p /DC	f _z										v _c
				2	3	4	5	6	8	10	12	16	20	
N1	E	0.300	1.2	0.022	0.032	0.042	0.055	0.065	0.085	0.11	0.13	0.16	0.18	650 (540 – 750)
		0,300	1,2	0,00085	0,0013	0,0017	0,0022	0,0026	0,0034	0,0044	0,0050	0,0065	0,0070	2125 (1800 – 2400)
N2	E	0.300	1.2	0.022	0.032	0.042	0.055	0.065	0.085	0.11	0.13	0.16	0.18	415 (350 – 480)
		0,300	1,2	0,00085	0,0013	0,0017	0,0022	0,0026	0,0034	0,0044	0,0050	0,0065	0,0070	1350 (1200 – 1500)
N3	E	0.300	1.2	0.022	0.032	0.042	0.055	0.065	0.085	0.11	0.13	0.16	0.18	275 (240 – 320)
		0,300	1,2	0,00085	0,0013	0,0017	0,0022	0,0026	0,0034	0,0044	0,0050	0,0065	0,0070	900 (790 – 1000)
N11	E	0.300	1.0	0.012	0.018	0.024	0.030	0.036	0.048	0.060	0.070	0.090	0.10	305 (260 – 350)
		0,300	1,0	0,00048	0,00070	0,00095	0,0012	0,0014	0,0019	0,0024	0,0028	0,0036	0,0040	1000 (860 – 1100)
S1	E	0.120	0.90	0.0055	0.0080	0.011	0.014	0.016	0.022	0.028	0.032	0.040	0.046	70 (60 – 83)
		0,120	0,90	0,00022	0,00032	0,00044	0,00055	0,00065	0,00085	0,0011	0,0013	0,0016	0,0018	230 (200 – 270)
S2	E	0.120	0.90	0.0055	0.0080	0.011	0.014	0.016	0.022	0.028	0.032	0.040	0.046	60 (48 – 67)
		0,120	0,90	0,00022	0,00032	0,00044	0,00055	0,00065	0,00085	0,0011	0,0013	0,0016	0,0018	195 (160 – 210)
S3	E	0.120	0.90	0.0036	0.0055	0.0075	0.0090	0.011	0.015	0.018	0.022	0.028	0.032	39 (30 – 48)
		0,120	0,90	0,00014	0,00022	0,00030	0,00036	0,00044	0,00060	0,00070	0,00085	0,0011	0,0013	130 (99 – 150)
S11	E	0.300	1.0	0.010	0.015	0.020	0.025	0.030	0.040	0.050	0.060	0.075	0.085	100 (89 – 110)
		0,300	0,90	0,00040	0,00060	0,00080	0,0010	0,0012	0,0016	0,0020	0,0024	0,0030	0,0034	330 (300 – 360)
S12	E	0.300	1.0	0.010	0.015	0.020	0.025	0.030	0.040	0.050	0.060	0.075	0.085	80 (68 – 87)
		0,300	0,90	0,00040	0,00060	0,00080	0,0010	0,0012	0,0016	0,0020	0,0024	0,0030	0,0034	260 (230 – 280)
S13	E	0.300	1.0	0.0085	0.013	0.017	0.022	0.026	0.034	0.044	0.050	0.065	0.075	60 (54 – 69)
		0,300	0,90	0,00036	0,00050	0,00070	0,00085	0,0010	0,0014	0,0017	0,0020	0,0026	0,0030	195 (180 – 220)
TS1	A	0.400	1.0	0.020	0.030	0.040	0.050	0.060	0.080	0.10	0.12	0.15	0.17	500 (460 – 550)
		0,400	1,0	0,00080	0,0012	0,0016	0,0020	0,0024	0,0032	0,0040	0,0048	0,0060	0,0065	1650 (1600 – 1800)
TP1	A	0.400	1.0	0.020	0.030	0.040	0.050	0.060	0.080	0.10	0.12	0.15	0.17	500 (460 – 550)
		0,400	1,0	0,00080	0,0012	0,0016	0,0020	0,0024	0,0032	0,0040	0,0048	0,0060	0,0065	1650 (1600 – 1800)

For cutting data recalculations, see pages 556 - 563

SMG = Seco material group

Coolant = A=air D=dry E=emulsion M=mist spray

v_c = m/min (sf/min)

f_z = mm (in/tooth)

a_p = mm/DC (in/DC) = factor

a_e = mm/DC (in/DC) = factor

All cutting data are target values

HK

General purpose – Universal – Conical – 3-4 Flutes – Cylindrical – Tapered sharp

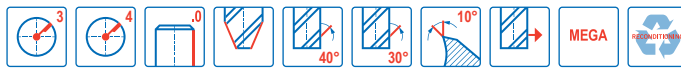
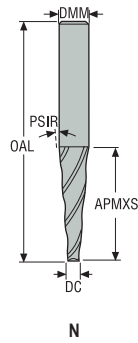

- Tolerances:
- DMM= h5
- DC= +0,1/0 mm
- PSIR= ±0,1°
- Re grind possible

Designation	Item number	Length index	Tool shape	DC	DMM	APMXS	OAL	PSIR°	PCEDC	Cylindrical
				mm	mm	mm	mm			
HK020-040-MEGA	00028666	2	N	4,0	6,0	20,0	65,0	2,0	3	■
HK020-050-MEGA	00028669	2	N	5,0	8,0	30,0	75,0	2,0	3	■
HK020-100-MEGA	00028694	2	N	10,0	12,0	28,0	80,0	2,0	4	■

■ Stocked standard.

For cutting data, please see My Pages – Suggest on www.secotools.com

Universal

Steel and cast iron

Stainless steel and S-materials

Non ferrous

Hard

Plastic and cfrp

Graphite

X-Heads

Minimaster Plus

Minimaster

HKM-HK

General purpose – Universal – Conical – 2-4 Flutes – Cylindrical – Tapered sharp

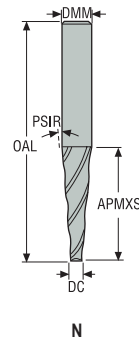

- Tolerances:
- DMM= h5
- DC= HKM= +0,07/+0,03 mm
- DC= HK= +0,1/0 mm
- PSIR= ±0,1°
- Regrind possible if DC is ≥Ø6

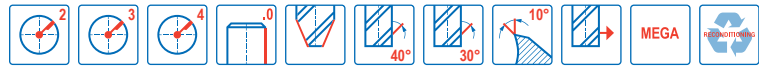

Designation	Item number	Length index	Tool shape	DC	DMM	APMXS	OAL	PSIR°	PCEDC	Cylindrical
				mm	mm	mm	mm			
HKM030-015-MEGA	00028738	2	N	1,5	3,0	6,0	40,0	3,0	2	■
HK030-025-MEGA	00028741	2	N	2,5	6,0	20,0	65,0	3,0	3	■
HK030-033-MEGA	00028744	2	N	3,0	8,0	30,0	75,0	3,0	3	■
HK030-065-MEGA	00028759	2	N	6,0	12,0	55,0	110,0	3,0	3	■
HK030-083-MEGA	00028771	2	N	8,0	12,0	30,0	80,0	3,0	4	■

■ Stocked standard.

For cutting data, please see My Pages – Suggest on www.secotools.com

Universal

Steel and cast iron

Stainless steel and S-materials

Non ferrous

Hard

Plastic and cfrp

Graphite

X-Heads

Minimaster Plus

Minimaster

HKM-HK

General purpose – Universal – Conical – 2-4 Flutes – Cylindrical – Tapered sharp

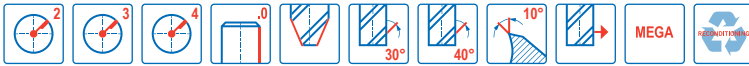
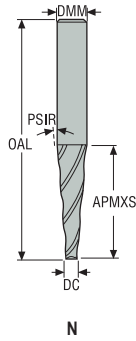

- Tolerances:
- DMM= h5
- DC= HKM= +0,07/+0,03 mm
- DC= HK= +0,1/0 mm
- PSIR= ±0,1°
- Regrind possible if DC is ≥Ø6

Designation	Item number	Length index	Tool shape	DC	DMM	APMXS	OAL	PSIR°	PCEDC	Cylindrical
				mm	mm	mm	mm			
HKM050-010-MEGA	00028947	2	N	1,0	3,0	4,0	40,0	5,0	2	■
HKM050-015-MEGA	00028952	2	N	1,5	3,0	6,0	40,0	5,0	2	■
HKM050-020-MEGA	00028954	2	N	2,0	4,0	10,0	50,0	5,0	2	■
HKM050-025-MEGA	00028958	2	N	2,5	5,0	10,0	50,0	5,0	2	■
HK050-025-MEGA	00028960	2	N	2,5	6,0	20,0	65,0	5,0	3	■
HK050-032-MEGA	00028972	2	N	3,0	8,0	28,0	70,0	5,0	3	■
HK050-0420-MEGA	00028998	2	N	4,0	8,0	22,0	65,0	5,0	3	■
HK050-050-MEGA	00029012	2	N	5,0	12,0	40,0	100,0	5,0	3	■
HK050-063-MEGA	00029014	2	N	6,0	12,0	32,0	90,0	5,0	3	■
HK050-065-MEGA	00029017	2	N	6,0	16,0	55,0	110,0	5,0	3	■
HK050-103-MEGA	00029020	2	N	10,0	16,0	32,0	90,0	5,0	4	■
HK050-105-MEGA	00029025	2	N	10,0	20,0	55,0	115,0	5,0	4	■

■ Stocked standard.
For cutting data, please see My Pages – Suggest on www.secotools.com

Universal

Steel and cast iron

Stainless steel and S-materials

Non ferrous

Hard

Plastic and cfrp

Graphite

X-Heads

Minimaster Plus

Minimaster

HK

General purpose – Universal – Conical – 3 Flutes – Cylindrical – Tapered sharp

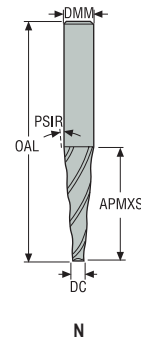

- Tolerances:
- DMM= h5
- DC= +0,1/0 mm
- PSIR= ±0,1°
- Regrind possible

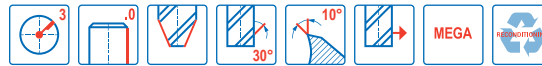

Designation	Item number	Length index	Tool shape	DC	DMM	APMXS	OAL	PSIR°	PCEDC	Cylindrical
				mm	mm	mm	mm			
HK070-025-MEGA	00029030	2	N	2,5	8,0	22,0	65,0	7,0	3	■
HK070-050-MEGA	00029034	2	N	5,0	12,0	28,0	80,0	7,0	3	■

■ Stocked standard.

For cutting data, please see My Pages – Suggest on www.secotools.com

Universal

Steel and cast iron

Stainless steel and S-materials

Non ferrous

Hard

Plastic and CFRP

Graphite

X-Heads

Minimaster Plus

Minimaster

HK

General purpose – Universal – Conical – 4 Flutes – Cylindrical – Tapered sharp

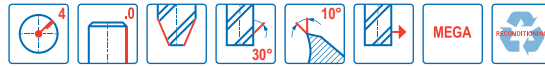
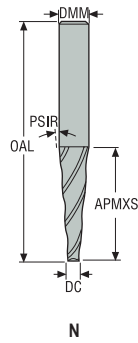

- Tolerances:
- DMM= h5
- DC= +0,1/0 mm
- PSIR= ±0,1°
- Regrind possible

Designation	Item number	Length index	Tool shape	DC	DMM	APMXS	OAL	PSIR°	PCEDC	Cylindrical
				mm	mm	mm	mm			
HK080-083-MEGA	00029041	2	N	8,0	18,0	35,0	90,0	8,0	4	■

■ Stocked standard.

For cutting data, please see My Pages – Suggest on www.secotools.com

Universal

Steel and cast iron

Stainless steel and S-materials

Non ferrous

Hard

Plastic and cfrp

Graphite

X-Heads

Minimaster Plus

Minimaster

HK

General purpose – Universal – Conical – 3-4 Flutes – Cylindrical – Tapered sharp

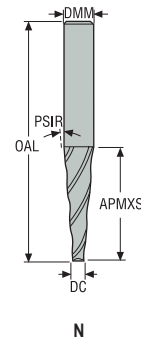

- Tolerances:
- DMM= h5
- DC= +0,1/0 mm
- PSIR= ±0,1°
- Regrind possible

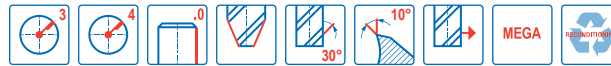

Designation	Item number	Length index	Tool shape	DC	DMM	APMXS	OAL	PSIR°	PCEDC	Cylindrical
				mm	mm	mm	mm			
HK100-025-MEGA	00029052	2	N	2,5	10,0	20,0	75,0	10,0	3	■
HK100-030-MEGA	00029066	2	N	3,0	14,0	30,0	90,0	10,0	3	■
HK100-050-MEGA	00029069	2	N	5,0	16,0	30,0	90,0	10,0	3	■
HK100-080-MEGA	00029083	2	N	8,0	20,0	32,0	90,0	10,0	4	■

■ Stocked standard.

For cutting data, please see My Pages – Suggest on www.secotools.com

Universal

Steel and cast iron

Stainless steel and S-materials

Non ferrous

Hard

Plastic and CFRP

Graphite

X-Heads

Minimaster Plus

Minimaster

HK

General purpose – Universal – Conical – 3 Flutes – Cylindrical – Tapered sharp

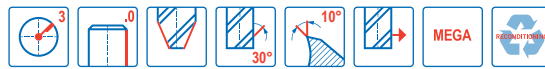
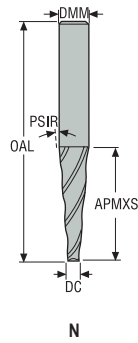

- Tolerances:
- DMM= h5
- DC= +0,1/0 mm
- PSIR= ±0,1°
- Re grind possible

Designation	Item number	Length index	Tool shape	DC	DMM	APMXS	OAL	PSIR°	PCEDC	Cylindrical
				mm	mm	mm	mm			
HK110-020-MEGA	00029110	2	N	2,0	10,0	20,0	75,0	11,0	3	■
HK110-050-MEGA	00029117	2	N	5,0	14,0	20,0	80,0	11,0	3	■

■ Stocked standard.

For cutting data, please see My Pages – Suggest on www.secotools.com

Universal

Steel and cast iron

Stainless steel and S-materials

Non ferrous

Hard

Plastic and cfrp

Graphite

X-Heads

Minimaster Plus

Minimaster

HK

General purpose – Universal – Conical – 3-4 Flutes – Cylindrical – Tapered sharp

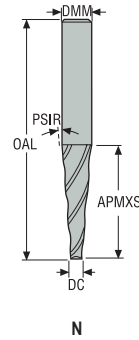

- Tolerances:
- DMM= h5
- DC= +0,1/0 mm
- PSIR= ±0,1°
- Regrind possible

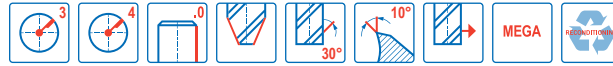

Designation	Item number	Length index	Tool shape	DC	DMM	APMXS	OAL	PSIR°	PCEDC	Cylindrical
				mm	mm	mm	mm			
HK150-025	00029119	2	N	2,5	14,0	20,0	80,0	15,0	3	■
HK150-025-MEGA	00029151	2	N	2,5	14,0	20,0	80,0	15,0	3	■
HK150-040	00029124	2	N	4,0	12,0	15,0	65,0	15,0	3	■
HK150-040-MEGA	00029154	2	N	4,0	12,0	15,0	65,0	15,0	3	■
HK150-0651	00029133	2	N	6,5	12,0	10,0	65,0	15,0	3	■
HK150-0651-MEGA	00029160	2	N	6,5	12,0	10,0	65,0	15,0	3	■
HK150-0652	00029138	2	N	6,5	20,0	25,0	90,0	15,0	3	■
HK150-0652-MEGA	00029161	2	N	6,5	20,0	25,0	90,0	15,0	3	■
HK150-080	00029149	2	N	8,0	20,0	20,0	80,0	15,0	4	■
HK150-080-MEGA	00029162	2	N	8,0	20,0	20,0	80,0	15,0	4	■

■ Stocked standard.

For cutting data, please see My Pages – Suggest on www.secotools.com

Universal

Steel and cast iron

Stainless steel and S-materials

Non ferrous

Hard

Plastic and CFRP

Graphite

X-Heads

Minimaster Plus

Minimaster

HK

General purpose – Universal – Conical – 3-4 Flutes – Cylindrical – Tapered sharp

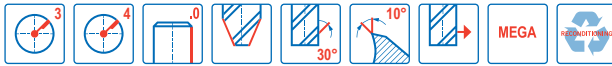
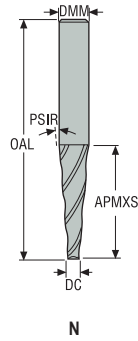

- Tolerances:
- DMM= h5
- DC= +0,1/0 mm
- PSIR= ±0,1°
- Re grind possible

Designation	Item number	Length index	Tool shape	DC	DMM	APMXS	OAL	PSIR°	PCEDC	Cylindrical
				mm	mm	mm	mm			
HK200-025	00029165	2	N	2,5	10,0	10,0	75,0	20,0	3	■
HK200-025-MEGA	00029168	2	N	2,5	10,0	10,0	75,0	20,0	3	■
HK200-045	00029166	2	N	4,5	16,0	15,0	90,0	20,0	4	■
HK200-045-MEGA	00029203	2	N	4,5	16,0	15,0	90,0	20,0	4	■

■ Stocked standard.

For cutting data, please see My Pages – Suggest on www.secotools.com

Universal

Steel and cast iron

Stainless steel and S-materials

Non ferrous

Hard

Plastic and CFRP

Graphite

X-Heads

Minimaster Plus

Minimaster

HK

General purpose – Universal – Conical – 3-4 Flutes – Cylindrical – Tapered sharp

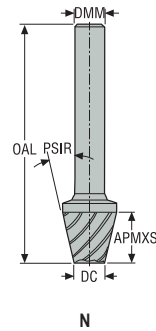

- Tolerances:
- DMM= h5
- DC= +0,1/0 mm
- PSIR= ±0,1°
- Regrind possible

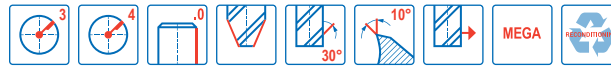

Designation	Item number	Length index	Tool shape	DC	DMM	APMXS	OAL	PSIR°	PCEDC	Cylindrical
				mm	mm	mm	mm			
HK300-025	00029208	2	N	2,5	10,0	10,0	75,0	30,0	3	■
HK300-025-MEGA	00029211	2	N	2,5	10,0	10,0	75,0	30,0	3	■
HK300-045	00029210	2	N	4,5	16,0	16,0	90,0	30,0	4	■
HK300-045-MEGA	00029212	2	N	4,5	16,0	16,0	90,0	30,0	4	■

■ Stocked standard.

For cutting data, please see My Pages – Suggest on www.secotools.com

Universal

Steel and cast iron

Stainless steel and S-materials

Non ferrous

Hard

Plastic and CFRP

Graphite

X-Heads

Minimaster Plus

Minimaster

HK

General purpose – Universal – Conical – 3-4 Flutes – Cylindrical – Tapered sharp

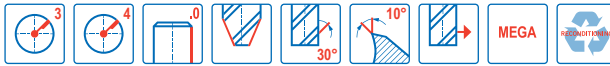
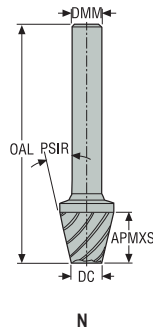

- Tolerances:
- DMM= h5
- DC= +0,1/0 mm
- PSIR= ±0,1°
- Re grind possible

Designation	Item number	Length index	Tool shape	DC	DMM	APMXS	OAL	PSIR°	PCEDC	Cylindrical
				mm	mm	mm	mm			
HK450-025	00029215	2	N	2,5	12,0	10,0	75,0	45,0	3	■
HK450-025-MEGA	00029229	2	N	2,5	12,0	10,0	75,0	45,0	3	■
HK450-045	00029217	2	N	4,5	16,0	16,0	90,0	45,0	4	■
HK450-045-MEGA	00029232	2	N	4,5	16,0	16,0	90,0	45,0	4	■

■ Stocked standard.

For cutting data, please see My Pages – Suggest on www.secotools.com

Universal

Steel and cast iron

Stainless steel and S-materials

Non ferrous

Hard

Plastic and CFRP

Graphite

X-Heads

Minimaster Plus

Minimaster

V31

General purpose – Universal – Concave – 4 Flutes – Cylindrical

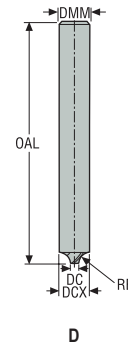

- Tolerances:
- DMM= h5
- DC= ±0,04 mm
- RE= ±0,02 mm
- Regrind possible

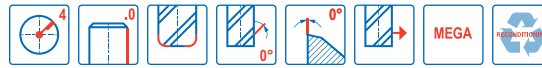

Designation	Item number	Length index	Tool shape	DC	DCX	DMM	APMXS	OAL	RE	PCEDC	Cylindrical
				mm	mm	mm	mm	mm	mm		
31100-MEGA	00029307	2	D	4,0	6,0	6,0	1,0	64,0	1,0	4	■
31200-MEGA	00029315	2	D	4,0	8,0	8,0	2,0	75,0	2,0	4	■
31300-MEGA	00029326	2	D	4,0	10,0	10,0	3,0	75,0	3,0	4	■
31400-MEGA	00029328	2	D	4,0	12,0	12,0	4,0	75,0	4,0	4	■
31050-MEGA	00029285	2	D	5,0	6,0	6,0	0,5	64,0	0,5	4	■
31150-MEGA	00029313	2	D	5,0	8,0	8,0	1,5	75,0	1,5	4	■
31250-MEGA	00029324	2	D	5,0	10,0	10,0	2,5	75,0	2,5	4	■
31350-MEGA	00029327	2	D	5,0	12,0	12,0	3,5	75,0	3,5	4	■
31500-MEGA	00029330	2	D	6,0	16,0	16,0	5,0	75,0	5,0	4	■
31600-MEGA	00029331	2	D	8,0	20,0	20,0	6,0	80,0	6,0	4	■
31999-MEGA	00029335	2	D	8,0	28,0	25,0	10,0	80,0	10,0	4	■
31800-MEGA	00029333	2	D	9,0	25,0	25,0	8,0	75,0	8,0	4	■

■ Stocked standard.

Universal

Steel and cast iron

Stainless steel and S-materials

Non ferrous

Hard

Plastic and cfrp

Graphite

X-Heads

Minimaster Plus

Minimaster

Cutting data – V31 Side milling roughing

SMG		a _p /D _c		f _z							v _c	
		0,24	0,024	6	8	10	12	16	20	25		28
P1	E/M/A	0,24	0,024	0,024	0,032	0,040	0,048	0,065	0,080	0,095	0,10	290 (195 – 310)
		0,24	0,00095	0,0013	0,0016	0,0019	0,0026	0,0032	0,0038	0,004	950 (640 – 1100)	
P2	E/M/A	0,24	0,024	0,024	0,034	0,042	0,050	0,065	0,080	0,095	0,10	280 (190 – 305)
		0,24	0,00095	0,0013	0,0017	0,0022	0,0026	0,0032	0,0038	0,004	910 (620 – 1000)	
P3	E/M/A	0,24	0,024	0,024	0,032	0,040	0,046	0,060	0,075	0,090	0,095	240 (165 – 260)
		0,24	0,00095	0,0013	0,0016	0,0018	0,0024	0,003	0,0036	0,0038	790 (540 – 850)	
P4	E/M/A	0,24	0,022	0,022	0,030	0,038	0,046	0,060	0,075	0,090	0,095	210 (145 – 230)
		0,24	0,00085	0,0012	0,0015	0,0018	0,0024	0,003	0,0036	0,0038	680 (475 – 760)	
P5	E/M/A	0,24	0,022	0,022	0,030	0,038	0,046	0,060	0,075	0,085	0,095	205 (135 – 220)
		0,24	0,00085	0,0012	0,0015	0,0018	0,0024	0,003	0,0034	0,0038	670 (445 – 730)	
P6	E/M/A	0,24	0,022	0,022	0,030	0,038	0,044	0,060	0,075	0,085	0,095	230 (155 – 245)
		0,24	0,00085	0,0012	0,0015	0,0017	0,0024	0,003	0,0050	0,0038	760 (510 – 800)	
P7	E/M/A	0,24	0,022	0,022	0,030	0,038	0,044	0,060	0,075	0,085	0,095	215 (145 – 230)
		0,24	0,00085	0,0012	0,0015	0,0017	0,0024	0,003	0,0050	0,0038	710 (475 – 760)	
P8	E/M/A	0,24	0,024	0,024	0,032	0,040	0,046	0,060	0,075	0,090	0,095	205 (140 – 220)
		0,24	0,00095	0,0013	0,0016	0,0018	0,0024	0,003	0,0036	0,0038	670 (460 – 730)	
P11	E/M/A	0,24	0,022	0,022	0,030	0,038	0,044	0,060	0,075	0,085	0,095	210 (140 – 225)
		0,24	0,00085	0,0012	0,0015	0,0017	0,0024	0,003	0,0050	0,0038	680 (460 – 740)	
M1	E/M/A	0,24	0,024	0,024	0,034	0,042	0,050	0,065	0,080	0,095	0,10	255 (170 – 270)
		0,24	0,00095	0,0013	0,0017	0,0022	0,0026	0,0032	0,0038	0,004	840 (560 – 890)	
M2	E/M/A	0,24	0,022	0,022	0,030	0,038	0,046	0,060	0,075	0,085	0,095	205 (135 – 220)
		0,24	0,00085	0,0012	0,0015	0,0018	0,0024	0,003	0,0050	0,0038	670 (445 – 730)	
M3	E/M/A	0,24	0,018	0,018	0,024	0,030	0,036	0,048	0,060	0,070	0,075	150 (105 – 165)
		0,24	0,0007	0,00095	0,0012	0,0014	0,0019	0,0024	0,0028	0,003	490 (345 – 540)	
M4	E/M/A	0,24	0,016	0,016	0,020	0,026	0,032	0,042	0,050	0,060	0,065	110 (75 – 120)
		0,24	0,00065	0,0008	0,0010	0,0013	0,0017	0,0022	0,0024	0,0026	360 (250 – 400)	
M5	E/M/A	0,24	0,016	0,016	0,020	0,026	0,032	0,042	0,050	0,060	0,065	95 (65 – 100)
		0,24	0,00065	0,0008	0,0010	0,0013	0,0017	0,0022	0,0024	0,0026	310 (220 – 320)	
K1	E/M/A	0,24	0,022	0,022	0,030	0,038	0,046	0,060	0,075	0,085	0,095	205 (135 – 220)
		0,24	0,00085	0,0012	0,0015	0,0018	0,0024	0,003	0,0050	0,0038	670 (445 – 730)	
K2	E/M/A	0,24	0,020	0,020	0,028	0,034	0,040	0,055	0,065	0,080	0,085	175 (120 – 190)
		0,24	0,0008	0,0011	0,0013	0,0016	0,0022	0,0026	0,0032	0,0050	570 (400 – 620)	
K3	E/M/A	0,24	0,020	0,020	0,028	0,034	0,040	0,055	0,065	0,080	0,085	150 (100 – 160)
		0,24	0,0008	0,0011	0,0013	0,0016	0,0022	0,0026	0,0032	0,0050	490 (320 – 530)	
K4	E/M/A	0,24	0,020	0,020	0,028	0,034	0,040	0,055	0,065	0,080	0,085	140 (95 – 150)
		0,24	0,0008	0,0011	0,0013	0,0016	0,0022	0,0026	0,0032	0,0050	460 (310 – 490)	
K5	E/M/A	0,24	0,018	0,018	0,024	0,030	0,036	0,050	0,060	0,070	0,075	85 (55 – 90)
		0,24	0,0007	0,00095	0,0012	0,0014	0,0022	0,0024	0,0028	0,003	280 (180 – 300)	
K6	E/M/A	0,24	0,020	0,020	0,028	0,034	0,040	0,055	0,065	0,080	0,085	125 (85 – 135)
		0,24	0,0008	0,0011	0,0013	0,0016	0,0022	0,0026	0,0032	0,0050	410 (280 – 445)	
K7	E/M/A	0,24	0,018	0,018	0,024	0,030	0,036	0,050	0,060	0,070	0,075	105 (70 – 115)
		0,24	0,0007	0,00095	0,0012	0,0014	0,0022	0,0024	0,0028	0,003	345 (220 – 375)	

For cutting data recalculations, see pages 556 - 563

SMG = Seco material group
 Coolant = A=air D=dry E=emulsion M=mist spray
 v_c = m/min (sf/min)
 f_z = mm (in/tooth)
 a_p = mm/DC (in/DC) = factor
 a_e = mm/DC (in/DC) = factor
 All cutting data are target values

Universal
Steel and cast iron
Stainless steel and S-materials
Non ferrous
Hard
Plastic and cfrp
Graphite
X-Heads
Minimaster Plus
Minimaster

Cutting data – V31 Side milling roughing

Universal	SMG	a _p /D _c	f _z								v _c	
			6	8	10	12	16	20	25	28		
Steel and cast iron	N1	E/M/A	0,24	0,022	0,030	0,038	0,046	0,060	0,075	0,085	0,095	315 (215 – 340)
			0,24	0,00085	0,0012	0,0015	0,0018	0,0024	0,003	0,0050	0,0038	1025 (710 – 1125)
Steel and cast iron	N2	E/M/A	0,24	0,022	0,030	0,038	0,046	0,060	0,075	0,085	0,095	205 (135 – 220)
			0,24	0,00085	0,0012	0,0015	0,0018	0,0024	0,003	0,0050	0,0038	670 (445 – 730)
Steel and cast iron	N3	E/M/A	0,24	0,022	0,030	0,038	0,046	0,060	0,075	0,085	0,095	135 (90 – 145)
			0,24	0,00085	0,0012	0,0015	0,0018	0,0024	0,003	0,0050	0,0038	445 (300 – 475)
Steel and cast iron	N11	E/M/A	0,24	0,022	0,030	0,038	0,046	0,060	0,075	0,085	0,095	205 (135 – 220)
			0,24	0,00085	0,0012	0,0015	0,0018	0,0024	0,003	0,0050	0,0038	670 (445 – 730)
Stainless steel and S-materials	S1	E/M/A	0,24	0,024	0,032	0,040	0,048	0,065	0,080	0,095	0,10	205 (140 – 220)
			0,24	0,00095	0,0013	0,0016	0,0019	0,0026	0,0032	0,0038	0,004	670 (460 – 730)
Stainless steel and S-materials	S2	E/M/A	0,24	0,024	0,032	0,040	0,048	0,065	0,080	0,095	0,10	205 (140 – 220)
			0,24	0,00095	0,0013	0,0016	0,0019	0,0026	0,0032	0,0038	0,004	670 (460 – 730)
Stainless steel and S-materials	S3	E/M/A	0,24	0,022	0,030	0,038	0,046	0,060	0,075	0,085	0,095	205 (135 – 220)
			0,24	0,00085	0,0012	0,0015	0,0018	0,0024	0,003	0,0050	0,0038	670 (445 – 730)
Stainless steel and S-materials	S11	E/M/A	0,24	0,022	0,030	0,038	0,046	0,060	0,075	0,085	0,095	265 (180 – 285)
			0,24	0,00085	0,0012	0,0015	0,0018	0,0024	0,003	0,0050	0,0038	870 (590 – 940)
Stainless steel and S-materials	S12	E/M/A	0,24	0,022	0,030	0,038	0,046	0,060	0,075	0,085	0,095	205 (135 – 220)
			0,24	0,00085	0,0012	0,0015	0,0018	0,0024	0,003	0,0050	0,0038	670 (445 – 730)
Stainless steel and S-materials	S13	E/M/A	0,24	0,020	0,026	0,032	0,040	0,050	0,065	0,075	0,080	155 (105 – 165)
			0,24	0,0008	0,0010	0,0013	0,0016	0,0022	0,0026	0,003	0,0032	510 (345 – 540)
Non ferrous	H5	M/A	0,24	0,034	0,046	0,055	0,070	0,090	0,11	0,13	0,14	275 (185 – 295)
			0,24	0,0013	0,0018	0,0022	0,0028	0,0036	0,0044	0,0050	0,0055	900 (610 – 950)
Non ferrous	H8	M/A	0,24	0,026	0,034	0,044	0,050	0,070	0,085	0,10	0,11	270 (185 – 290)
			0,24	0,0010	0,0013	0,0017	0,0022	0,0028	0,0050	0,004	0,0044	890 (610 – 950)
Non ferrous	H21	M/A	0,24	0,026	0,034	0,044	0,050	0,070	0,085	0,10	0,11	270 (185 – 290)
			0,24	0,0010	0,0013	0,0017	0,0022	0,0028	0,0050	0,004	0,0044	890 (610 – 950)
Non ferrous	H31	M/A	0,24	0,022	0,030	0,038	0,046	0,060	0,075	0,085	0,095	205 (135 – 220)
			0,24	0,00085	0,0012	0,0015	0,0018	0,0024	0,003	0,0050	0,0038	670 (445 – 730)
Hard	TS1	A/D	0,24	0,022	0,030	0,038	0,046	0,060	0,075	0,085	0,095	205 (135 – 220)
			0,24	0,00085	0,0012	0,0015	0,0018	0,0024	0,003	0,0050	0,0038	670 (445 – 730)
Hard	TP1	A/D	0,24	0,022	0,030	0,038	0,046	0,060	0,075	0,085	0,095	205 (135 – 220)
			0,24	0,00085	0,0012	0,0015	0,0018	0,0024	0,003	0,0050	0,0038	670 (445 – 730)
Hard	GR1	A/D	0,24	0,022	0,030	0,038	0,046	0,060	0,075	0,085	0,095	205 (135 – 220)
			0,24	0,00085	0,0012	0,0015	0,0018	0,0024	0,003	0,0050	0,0038	670 (445 – 730)

For cutting data recalculations, see pages 556 - 563

SMG = Seco material group
Coolant = A=air D=dry E=emulsion M=mist spray
v_c = m/min (sf/min)
f_z = mm (in/tooth)
a_p = mm/DC (in/DC) = factor
a_b = mm/DC (in/DC) = factor
All cutting data are target values

JME542

Miniature – Universal – Square – 2 Flutes – DMM 4 – Cylindrical – Sharp or corner radius

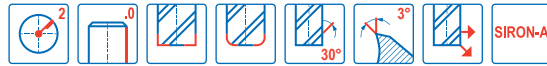
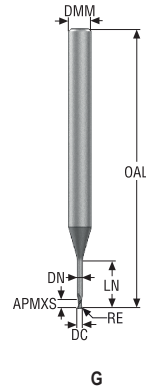

- Tolerances:
- Run-out= <0,007 mm
- DMM= h5
- DC= Ø0,2-Ø0,4= 0,-0,01 mm
- DC= Ø0,5-Ø3,0= 0,-0,013 mm
- RE= ±0,005 mm

Designation	Item number	Length index	Tool shape	DC	DMM	APMXS	OAL	LN	DN	RE	CA°	PCEDC	Cylindrical
				mm	mm	mm	mm	mm	mm	mm	mm		
JME542002G1S.0Z2-SIRA	03171095	1	G	0,2	4,0	0,3	45,0	0,4	0,18	–	14,41	2	■
JME542003G1S.0Z2-SIRA	03171096	1	G	0,3	4,0	0,45	45,0	0,6	0,28	–	14,0	2	■
JME542004G1S.0Z2-SIRA	03171128	1	G	0,4	4,0	0,6	45,0	0,8	0,37	–	13,5	2	■
JME542005G1R005.0Z2-SIRA	03171097	1	G	0,5	4,0	0,8	45,0	1,0	0,46	0,05	13,17	2	■
JME542006G1R005.0Z2-SIRA	03171098	1	G	0,6	4,0	0,9	45,0	1,2	0,56	0,05	12,76	2	■
JME542008G1R005.0Z2-SIRA	03171129	1	G	0,8	4,0	1,2	45,0	1,6	0,76	0,05	11,96	2	■
JME542010G1R010.0Z2-SIRA	03171099	1	G	1,0	4,0	1,5	50,0	2,0	0,95	0,1	11,22	2	■
JME542012G1R010.0Z2-SIRA	03171100	1	G	1,2	4,0	1,8	50,0	2,4	1,15	0,1	10,43	2	■
JME542015G1R015.0Z2-SIRA	03171130	1	G	1,5	4,0	2,3	50,0	3,0	1,45	0,15	9,2	2	■
JME542005G3R005.0Z2-SIRA	03171102	3	G	0,5	4,0	0,8	45,0	2,5	0,46	0,05	11,03	2	■
JME542006G3R005.0Z2-SIRA	03171103	3	G	0,6	4,0	0,9	45,0	3,0	0,56	0,05	10,36	2	■
JME542008G3R005.0Z2-SIRA	03171131	3	G	0,8	4,0	1,2	45,0	4,0	0,76	0,05	9,14	2	■
JME542010G3R010.0Z2-SIRA	03171104	3	G	1,0	4,0	1,5	50,0	5,0	0,95	0,1	8,09	2	■
JME542012G3R010.0Z2-SIRA	03171105	3	G	1,2	4,0	1,8	50,0	6,0	1,15	0,1	7,13	2	■
JME542015G3R015.0Z2-SIRA	03171132	3	G	1,5	4,0	2,3	50,0	7,5	1,45	0,15	5,89	2	■
JME542020G3R015.0Z2-SIRA	03171106	3	G	2,0	4,0	3,0	50,0	10,0	1,94	0,15	4,14	2	■
JME542025G3R015.0Z2-SIRA	03171108	3	G	2,5	4,0	3,8	50,0	12,5	2,4	0,15	2,79	2	■
JME542030G3R015.0Z2-SIRA	03171134	3	G	3,0	4,0	4,5	60,0	15,0	2,85	0,15	1,67	2	■
JME542005G4R005.0Z2-SIRA	03171109	4	G	0,5	4,0	0,8	45,0	4,0	0,46	0,05	9,49	2	■
JME542006G4R005.0Z2-SIRA	03171110	4	G	0,6	4,0	0,9	45,0	5,0	0,56	0,05	8,56	2	■
JME542008G4R005.0Z2-SIRA	03171135	4	G	0,8	4,0	1,2	45,0	7,0	0,76	0,05	7,05	2	■
JME542010G4R010.0Z2-SIRA	03171111	4	G	1,0	4,0	1,5	50,0	8,5	0,95	0,1	6,1	2	■
JME542012G4R010.0Z2-SIRA	03171112	4	G	1,2	4,0	1,8	50,0	10,0	1,15	0,1	5,27	2	■
JME542015G4R015.0Z2-SIRA	03171136	4	G	1,5	4,0	2,3	50,0	12,0	1,45	0,15	4,29	2	■
JME542020G4R015.0Z2-SIRA	03171113	4	G	2,0	4,0	3,0	60,0	16,0	1,94	0,15	2,9	2	■
JME542025G4R015.0Z2-SIRA	03171114	4	G	2,5	4,0	3,8	60,0	20,0	2,4	0,15	1,88	2	■
JME542030G4R015.0Z2-SIRA	03171137	4	G	3,0	4,0	4,5	70,0	24,0	2,85	0,15	1,1	2	■
JME542015G5R015.0Z2-SIRA	03171115	5	G	1,5	4,0	2,3	60,0	15,0	1,45	0,15	3,64	2	■
JME542020G5R015.0Z2-SIRA	03171116	5	G	2,0	4,0	3,0	60,0	20,0	1,94	0,15	2,41	2	■
JME542025G5R015.0Z2-SIRA	03171138	5	G	2,5	4,0	3,8	70,0	25,0	2,4	0,15	1,54	2	■
JME542030G5R015.0Z2-SIRA	03171117	5	G	3,0	4,0	4,5	70,0	30,0	2,85	0,15	0,9	2	■
JME542015G6R015.0Z2-SIRA	03171118	6	G	1,5	4,0	2,3	70,0	22,5	1,45	0,15	2,64	2	■
JME542020G6R015.0Z2-SIRA	03171139	6	G	2,0	4,0	3,0	70,0	30,0	1,94	0,15	1,7	2	■
JME542025G6R015.0Z2-SIRA	03171119	6	G	2,5	4,0	3,8	80,0	37,5	2,4	0,15	1,07	2	■
JME542030G6R015.0Z2-SIRA	03171120	6	G	3,0	4,0	4,5	90,0	45,0	2,85	0,15	0,61	2	■

■ Stocked standard.

Universal

Steel and cast iron

Stainless steel and S-materials

Non ferrous

Hard

Plastic and CFRP

Graphite

X-Heads

Minimaster Plus

Minimaster

JME562

Miniature – Universal – Square – 2 Flutes – DMM 6 – Cylindrical – Corner radius

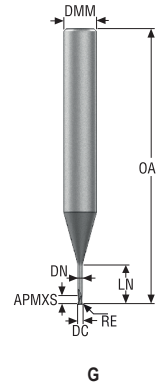

- Tolerances:
- Run-out= <0,007 mm
- DMM= h5
- DC= 0,-,0,013 mm
- RE= ±0,005 mm

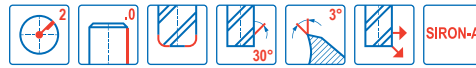

Designation	Item number	Length index	Tool shape	DC	DMM	APMXS	OAL	LN	DN	RE	CA°	PCEDC Cylindrical	
				mm	mm	mm	mm	mm	mm	mm	mm		
JME562005G2R005.0Z2-SIRA	03171145	2	G	0,5	6,0	0,8	50,0	1,5	0,46	0,05	13,48	2	■
JME562006G2R005.0Z2-SIRA	03171146	2	G	0,6	6,0	0,9	50,0	2,0	0,56	0,05	12,9	2	■
JME562008G2R005.0Z2-SIRA	03171147	2	G	0,8	6,0	1,2	50,0	2,5	0,76	0,05	12,28	2	■
JME562010G2R010.0Z2-SIRA	03171148	2	G	1,0	6,0	1,5	50,0	4,0	0,95	0,1	10,85	2	■
JME562012G2R010.0Z2-SIRA	03171150	2	G	1,2	6,0	1,8	50,0	4,5	1,15	0,1	10,31	2	■
JME562015G2R015.0Z2-SIRA	03171151	2	G	1,5	6,0	2,3	50,0	5,0	1,45	0,15	9,67	2	■
JME562018G2R015.0Z2-SIRA	03171152	2	G	1,8	6,0	2,7	50,0	5,4	1,75	0,15	9,12	2	■
JME562020G2R015.0Z2-SIRA	03171153	2	G	2,0	6,0	3,0	50,0	6,0	1,94	0,15	8,53	2	■
JME562025G2R015.0Z2-SIRA	03171154	2	G	2,5	6,0	3,8	60,0	7,5	2,4	0,15	7,15	2	■
JME562030G2R015.0Z2-SIRA	03171155	2	G	3,0	6,0	4,5	60,0	9,0	2,85	0,15	5,81	2	■
JME562005G4R005.0Z2-SIRA	03171156	4	G	0,5	6,0	0,8	50,0	3,5	0,46	0,05	11,54	2	■
JME562006G4R005.0Z2-SIRA	03171157	4	G	0,6	6,0	0,9	50,0	4,2	0,56	0,05	10,93	2	■
JME562008G4R005.0Z2-SIRA	03171158	4	G	0,8	6,0	1,2	50,0	5,6	0,76	0,05	9,81	2	■
JME562010G4R010.0Z2-SIRA	03171159	4	G	1,0	6,0	1,5	50,0	7,0	0,95	0,1	8,86	2	■
JME562012G4R010.0Z2-SIRA	03171160	4	G	1,2	6,0	1,8	50,0	8,4	1,15	0,1	8,0	2	■
JME562015G4R015.0Z2-SIRA	03171162	4	G	1,5	6,0	2,3	50,0	10,5	1,45	0,15	6,86	2	■
JME562020G4R015.0Z2-SIRA	03171163	4	G	2,0	6,0	3,0	60,0	14,0	1,94	0,15	5,36	2	■
JME562025G4R015.0Z2-SIRA	03171164	4	G	2,5	6,0	3,8	65,0	17,5	2,4	0,15	4,18	2	■
JME562030G4R015.0Z2-SIRA	03171165	4	G	3,0	6,0	4,5	70,0	21,0	2,85	0,15	3,22	2	■
JME562005G5R005.0Z2-SIRA	03171166	5	G	0,5	6,0	0,8	50,0	5,0	0,46	0,05	10,42	2	■
JME562006G5R005.0Z2-SIRA	03171167	5	G	0,6	6,0	0,9	50,0	6,0	0,56	0,05	9,71	2	■
JME562008G5R005.0Z2-SIRA	03171168	5	G	0,8	6,0	1,2	50,0	8,0	0,76	0,05	8,48	2	■
JME562010G5R010.0Z2-SIRA	03171169	5	G	1,0	6,0	1,5	50,0	10,0	0,95	0,1	7,48	2	■
JME562012G5R010.0Z2-SIRA	03171170	5	G	1,2	6,0	1,8	50,0	12,0	1,15	0,1	6,62	2	■
JME562015G5R015.0Z2-SIRA	03171171	5	G	1,5	6,0	2,3	60,0	15,0	1,45	0,15	5,54	2	■
JME562020G5R015.0Z2-SIRA	03171172	5	G	2,0	6,0	3,0	60,0	20,0	1,94	0,15	4,19	2	■
JME562025G5R015.0Z2-SIRA	03171173	5	G	2,5	6,0	3,8	70,0	25,0	2,4	0,15	3,19	2	■
JME562030G5R015.0Z2-SIRA	03171174	5	G	3,0	6,0	4,5	70,0	30,0	2,85	0,15	2,41	2	■

■ Stocked standard.

Universal

Steel and cast iron

Stainless steel and S-materials

Non ferrous

Hard

Plastic and CFRP

Graphite

X-Heads

Minimaster Plus

Minimaster

JME562

Miniature – Universal – Square – 2 Flutes – DMM 6 – Cylindrical – Corner radius

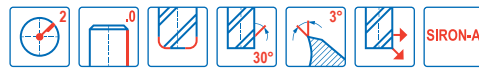
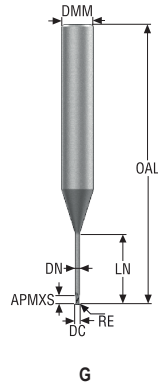

- Tolerances:
- Run-out= <0,007 mm
- DMM= h5
- DC= 0,-0,013 mm
- RE= ±0,005 mm

Designation	Item number	Length index	Tool shape	DC	DMM	APMXS	OAL	LN	DN	RE	CA°	PCEDC Cylindrical
				mm	mm	mm	mm	mm	mm	mm		
JME562010G6R010.0Z2-SIRA	03171175	6	G	1,0	6,0	1,5	60,0	15,0	0,95	0,1	5,94	2 ■
JME562012G6R010.0Z2-SIRA	03171176	6	G	1,2	6,0	1,8	60,0	18,0	1,15	0,1	5,14	2 ■
JME562015G6R015.0Z2-SIRA	03171177	6	G	1,5	6,0	2,3	70,0	22,5	1,45	0,15	4,2	2 ■
JME562020G6R015.0Z2-SIRA	03171178	6	G	2,0	6,0	3,0	80,0	30,0	1,94	0,15	3,07	2 ■
JME562025G6R015.0Z2-SIRA	03171179	6	G	2,5	6,0	3,8	80,0	37,5	2,4	0,15	2,28	2 ■
JME562030G6R015.0Z2-SIRA	03171180	6	G	3,0	6,0	4,5	90,0	45,0	2,85	0,15	1,7	2 ■
JME562010G7R010.0Z2-SIRA	03171181	7	G	1,0	6,0	1,5	60,0	20,0	0,95	0,1	4,93	2 ■
JME562012G7R010.0Z2-SIRA	03171182	7	G	1,2	6,0	1,8	80,0	24,0	1,15	0,1	4,2	2 ■
JME562015G7R015.0Z2-SIRA	03171183	7	G	1,5	6,0	2,3	80,0	30,0	1,45	0,15	3,38	2 ■
JME562020G7R015.0Z2-SIRA	03171184	7	G	2,0	6,0	3,0	80,0	40,0	1,94	0,15	2,42	2 ■
JME562025G7R015.0Z2-SIRA	03171185	7	G	2,5	6,0	3,8	90,0	50,0	2,4	0,15	1,78	2 ■
JME562030G7R015.0Z2-SIRA	03171186	7	G	3,0	6,0	4,5	100,0	60,0	2,85	0,15	1,31	2 ■

■ Stocked standard.

Universal

Steel and cast iron

Stainless steel and S-materials

Non ferrous

Hard

Plastic and cfrp

Graphite

X-Heads

Minimaster Plus

Minimaster

Cutting data – JME562 Slot milling

SMG		a _p /DC	f _z												v _c
			0.2	0.3	0.4	0.5	0.6	0.8	1.0	1.2	1.8	2.0	2.5	3.0	
P1	M/E/A	0.32	0.0026	0.0040	0.0050	0.0065	0.0080	0.010	0.013	0.016	0.024	0.026	0.032	0.040	255 (230 – 280)
		0.32	0.00010	0.00016	0.00020	0.00026	0.00032	0.00040	0.00050	0.00065	0.00095	0.0010	0.0013	0.0016	840 (760 – 910)
P2	M/E/A	0.32	0.0026	0.0040	0.0050	0.0065	0.0080	0.010	0.013	0.016	0.024	0.026	0.032	0.040	250 (230 – 270)
		0.32	0.00010	0.00016	0.00020	0.00026	0.00032	0.00040	0.00050	0.00065	0.00095	0.0010	0.0013	0.0016	820 (760 – 880)
P3	M/E/A	0.32	0.0026	0.0040	0.0050	0.0065	0.0080	0.010	0.013	0.016	0.024	0.026	0.032	0.040	215 (200 – 230)
		0.32	0.00010	0.00016	0.00020	0.00026	0.00032	0.00040	0.00050	0.00065	0.00095	0.0010	0.0013	0.0016	710 (660 – 750)
P4	M/E/A	0.32	0.0026	0.0040	0.0050	0.0065	0.0080	0.010	0.013	0.016	0.024	0.026	0.032	0.040	190 (170 – 200)
		0.32	0.00010	0.00016	0.00020	0.00026	0.00032	0.00040	0.00050	0.00065	0.00095	0.0010	0.0013	0.0016	620 (560 – 650)
P5	M/E/A	0.32	0.0026	0.0040	0.0050	0.0065	0.0080	0.010	0.013	0.016	0.024	0.026	0.032	0.040	180 (170 – 200)
		0.32	0.00010	0.00016	0.00020	0.00026	0.00032	0.00040	0.00050	0.00065	0.00095	0.0010	0.0013	0.0016	590 (560 – 650)
P6	M/E/A	0.32	0.0026	0.0040	0.0050	0.0065	0.0080	0.010	0.013	0.016	0.024	0.026	0.032	0.040	200 (180 – 220)
		0.32	0.00010	0.00016	0.00020	0.00026	0.00032	0.00040	0.00050	0.00065	0.00095	0.0010	0.0013	0.0016	660 (600 – 720)
P7	M/E/A	0.32	0.0026	0.0040	0.0050	0.0065	0.0080	0.010	0.013	0.016	0.024	0.026	0.032	0.040	190 (170 – 210)
		0.32	0.00010	0.00016	0.00020	0.00026	0.00032	0.00040	0.00050	0.00065	0.00095	0.0010	0.0013	0.0016	620 (560 – 680)
P8	M/E/A	0.32	0.0026	0.0040	0.0050	0.0065	0.0080	0.010	0.013	0.016	0.024	0.026	0.032	0.040	180 (170 – 200)
		0.32	0.00010	0.00016	0.00020	0.00026	0.00032	0.00040	0.00050	0.00065	0.00095	0.0010	0.0013	0.0016	590 (560 – 650)
P11	M/E/A	0.32	0.0026	0.0040	0.0050	0.0065	0.0080	0.010	0.013	0.016	0.024	0.026	0.032	0.040	185 (170 – 200)
		0.32	0.00010	0.00016	0.00020	0.00026	0.00032	0.00040	0.00050	0.00065	0.00095	0.0010	0.0013	0.0016	610 (560 – 650)
P12	M/E/A	0.32	0.0026	0.0040	0.0050	0.0065	0.0080	0.010	0.013	0.016	0.022	0.022	0.026	0.028	110 (98 – 120)
		0.32	0.00010	0.00016	0.00020	0.00026	0.00032	0.00040	0.00050	0.00065	0.00085	0.00085	0.0010	0.0011	360 (330 – 390)
M1	E/M/A	0.32	0.0026	0.0040	0.0050	0.0065	0.0080	0.010	0.013	0.016	0.024	0.026	0.032	0.040	135 (120 – 160)
		0.32	0.00010	0.00016	0.00020	0.00026	0.00032	0.00040	0.00050	0.00065	0.00095	0.0010	0.0013	0.0016	445 (400 – 520)
M2	E/M/A	0.32	0.0026	0.0040	0.0050	0.0065	0.0080	0.010	0.013	0.016	0.024	0.026	0.032	0.040	110 (91 – 130)
		0.32	0.00010	0.00016	0.00020	0.00026	0.00032	0.00040	0.00050	0.00065	0.00095	0.0010	0.0013	0.0016	360 (300 – 420)
M3	E/M/A	0.32	0.0026	0.0040	0.0050	0.0065	0.0080	0.010	0.013	0.016	0.024	0.026	0.032	0.040	110 (91 – 130)
		0.32	0.00010	0.00016	0.00020	0.00026	0.00032	0.00040	0.00050	0.00065	0.00095	0.0010	0.0013	0.0016	360 (300 – 420)
M4	E/M/A	0.32	0.0026	0.0040	0.0050	0.0065	0.0080	0.010	0.013	0.016	0.024	0.026	0.032	0.036	80 (68 – 97)
		0.32	0.00010	0.00016	0.00020	0.00026	0.00032	0.00040	0.00050	0.00065	0.00095	0.0010	0.0013	0.0014	260 (230 – 310)
M5	E/M/A	0.32	0.0026	0.0040	0.0050	0.0065	0.0080	0.010	0.013	0.016	0.024	0.026	0.032	0.036	70 (57 – 81)
		0.32	0.00010	0.00016	0.00020	0.00026	0.00032	0.00040	0.00050	0.00065	0.00095	0.0010	0.0013	0.0014	230 (190 – 260)
N1	E/M/A	0.24	0.0026	0.0040	0.0050	0.0065	0.0080	0.010	0.013	0.016	0.024	0.026	0.032	0.040	400 (350 – 440)
		0.24	0.00010	0.00016	0.00020	0.00026	0.00032	0.00040	0.00050	0.00065	0.00095	0.0010	0.0013	0.0016	1300 (1200 – 1400)
N2	E/M/A	0.24	0.0026	0.0040	0.0050	0.0065	0.0080	0.010	0.013	0.016	0.024	0.026	0.032	0.040	400 (350 – 440)
		0.24	0.00010	0.00016	0.00020	0.00026	0.00032	0.00040	0.00050	0.00065	0.00095	0.0010	0.0013	0.0016	1300 (1200 – 1400)
N3	E/M/A	0.24	0.0026	0.0040	0.0050	0.0065	0.0080	0.010	0.013	0.016	0.024	0.026	0.032	0.040	265 (240 – 290)
		0.24	0.00010	0.00016	0.00020	0.00026	0.00032	0.00040	0.00050	0.00065	0.00095	0.0010	0.0013	0.0016	870 (790 – 950)
N11	E/M/A	0.24	0.0040	0.0060	0.0080	0.010	0.012	0.016	0.020	0.024	0.036	0.040	0.048	0.050	350 (300 – 400)
		0.24	0.00016	0.00024	0.00032	0.00040	0.00048	0.00065	0.00080	0.00095	0.0014	0.0016	0.0019	0.0020	1150 (990 – 1300)
S11	E/M/A	0.36	0.0026	0.0040	0.0050	0.0065	0.0080	0.010	0.013	0.016	0.024	0.026	0.032	0.040	180 (160 – 200)
		0.36	0.00010	0.00016	0.00020	0.00026	0.00032	0.00040	0.00050	0.00065	0.00095	0.0010	0.0013	0.0016	590 (530 – 650)
S12	E/M/A	0.36	0.0026	0.0040	0.0050	0.0065	0.0080	0.010	0.013	0.016	0.024	0.026	0.032	0.040	140 (120 – 150)
		0.36	0.00010	0.00016	0.00020	0.00026	0.00032	0.00040	0.00050	0.00065	0.00095	0.0010	0.0013	0.0016	460 (400 – 490)
S13	E/M/A	0.36	0.0026	0.0040	0.0050	0.0065	0.0080	0.010	0.013	0.016	0.024	0.026	0.032	0.036	110 (93 – 120)
		0.36	0.00010	0.00016	0.00020	0.00026	0.00032	0.00040	0.00050	0.00065	0.00095	0.0010	0.0013	0.0014	360 (310 – 390)
H3	M/A	0.095	0.0024	0.0036	0.0048	0.0060	0.0070	0.0095	0.012	0.014	0.022	0.024	0.030	0.036	80 (61 – 100)
		0.095	0.000095	0.00014	0.00019	0.00024	0.00028	0.00038	0.00048	0.00055	0.00085	0.00095	0.0012	0.0014	260 (210 – 320)
H5	M/A	0.20	0.0026	0.0040	0.0050	0.0065	0.0080	0.010	0.013	0.016	0.024	0.026	0.032	0.040	160 (150 – 180)
		0.20	0.00010	0.00016	0.00020	0.00026	0.00032	0.00040	0.00050	0.00065	0.00095	0.0010	0.0013	0.0016	520 (500 – 590)
H7	M/A	0.095	0.0024	0.0036	0.0048	0.0060	0.0070	0.0095	0.012	0.014	0.022	0.024	0.030	0.036	80 (61 – 100)
		0.095	0.000095	0.00014	0.00019	0.00024	0.00028	0.00038	0.00048	0.00055	0.00085	0.00095	0.0012	0.0014	260 (210 – 320)
H8	M/A	0.20	0.0026	0.0040	0.0050	0.0065	0.0080	0.010	0.013	0.016	0.024	0.026	0.032	0.040	160 (150 – 180)
		0.20	0.00010	0.00016	0.00020	0.00026	0.00032	0.00040	0.00050	0.00065	0.00095	0.0010	0.0013	0.0016	520 (500 – 590)
H11	M/A	0.20	0.0026	0.0040	0.0050	0.0065	0.0080	0.010	0.013	0.016	0.024	0.026	0.032	0.040	205 (180 – 230)
		0.20	0.00010	0.00016	0.00020	0.00026	0.00032	0.00040	0.00050	0.00065	0.00095	0.0010	0.0013	0.0016	670 (600 – 750)
H12	M/A	0.20	0.0026	0.0040	0.0050	0.0065	0.0080	0.010	0.013	0.016	0.024	0.026	0.032	0.040	190 (170 – 210)
		0.20	0.00010	0.00016	0.00020	0.00026	0.00032	0.00040	0.00050	0.00065	0.00095	0.0010	0.0013	0.0016	620 (560 – 680)
H21	M/A	0.20	0.0026	0.0040	0.0050	0.0065	0.0080	0.010	0.013	0.016	0.024	0.026	0.032	0.040	160 (150 – 180)
		0.20	0.00010	0.00016	0.00020	0.00026	0.00032	0.00040	0.00050	0.00065	0.00095	0.0010	0.0013	0.0016	520 (500 – 590)
H31	M/A	0.20	0.0026	0.0040	0.0050	0.0065	0.0080	0.010	0.013	0.016	0.024	0.026	0.032	0.036	120 (110 – 130)
		0.20	0.00010	0.00016	0.00020	0.00026	0.00032	0.00040	0.00050	0.00065	0.00095	0.0010	0.0013	0.0014	395 (370 – 420)
GR1	A	0.50	0.0020	0.0030	0.0040	0.0050	0.0060	0.0080	0.010	0.012	0.018	0.020	0.025	0.030	350 (300 – 400)
		0.50	0.000080	0.00012	0.00016	0.00020	0.00024	0.00032	0.00040	0.00048	0.00070	0.00080	0.0010	0.0012	1150 (990 – 1300)

Table based on LV1, please recal based on length version chosen. See page(s) 556 - 563

JME564

Miniature – Universal – Square – 4 Flutes – DMM 6 – Cylindrical – Corner radius

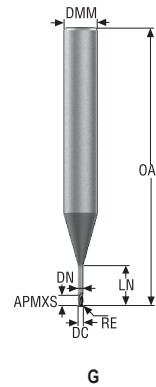

- Tolerances:
- Run-out= <0-0,007 mm
- DMM= h5
- DC= 0,-0,013 mm
- RE= ±0,005 mm

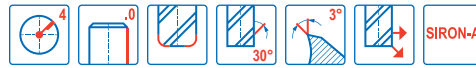

Designation	Item number	Length index	Tool shape	DC	DMM	APMXS	OAL	LN	DN	RE	CA°	PCEDC Cylindrical	
				mm	mm	mm	mm	mm	mm	mm	mm		
JME564005G2R005.0Z4-SIRA	03227166	2	G	0,5	6,0	1,0	50,0	1,5	0,46	0,05	13,48	4	■
JME564006G2R005.0Z4-SIRA	03227271	2	G	0,6	6,0	1,2	50,0	2,0	0,56	0,05	12,9	4	■
JME564008G2R005.0Z4-SIRA	03171194	2	G	0,8	6,0	1,6	50,0	2,5	0,76	0,05	12,28	4	■
JME564010G2R010.0Z4-SIRA	03171195	2	G	1,0	6,0	2,0	50,0	4,0	0,95	0,1	10,85	4	■
JME564012G2R010.0Z4-SIRA	03171196	2	G	1,2	6,0	2,4	50,0	4,5	1,15	0,1	10,31	4	■
JME564015G2R015.0Z4-SIRA	03171197	2	G	1,5	6,0	3,0	50,0	5,0	1,45	0,15	9,67	4	■
JME564020G2R015.0Z4-SIRA	03171198	2	G	2,0	6,0	4,0	50,0	6,0	1,94	0,15	8,53	4	■
JME564025G2R015.0Z4-SIRA	03171199	2	G	2,5	6,0	5,0	60,0	7,5	2,4	0,15	7,15	4	■
JME564030G2R015.0Z4-SIRA	03171200	2	G	3,0	6,0	6,0	60,0	9,0	2,85	0,15	5,81	4	■
JME564005G4R005.0Z4-SIRA	03171201	4	G	0,5	6,0	1,0	50,0	3,5	0,46	0,05	11,54	4	■
JME564006G4R005.0Z4-SIRA	03171202	4	G	0,6	6,0	1,2	50,0	4,2	0,56	0,05	10,93	4	■
JME564008G4R005.0Z4-SIRA	03171203	4	G	0,8	6,0	1,6	50,0	5,6	0,76	0,05	9,81	4	■
JME564010G4R010.0Z4-SIRA	03171204	4	G	1,0	6,0	2,0	50,0	7,0	0,95	0,1	8,86	4	■
JME564012G4R010.0Z4-SIRA	03171205	4	G	1,2	6,0	2,4	50,0	8,4	1,15	0,1	8,0	4	■
JME564015G4R015.0Z4-SIRA	03171206	4	G	1,5	6,0	3,0	50,0	10,5	1,45	0,15	6,86	4	■
JME564020G4R015.0Z4-SIRA	03171207	4	G	2,0	6,0	4,0	60,0	14,0	1,94	0,15	5,36	4	■
JME564025G4R015.0Z4-SIRA	03171208	4	G	2,5	6,0	5,0	60,0	17,5	2,4	0,15	4,18	4	■
JME564030G4R015.0Z4-SIRA	03171209	4	G	3,0	6,0	6,0	70,0	21,0	2,85	0,15	3,22	4	■

■ Stocked standard.

Universal

Steel and cast iron

Stainless steel and S-materials

Non ferrous

Hard

Plastic and CFRP

Graphite

X-Heads

Minimaster Plus

Minimaster

Cutting data – JME564 Side milling roughing

SMG		a _p /DC	a _p /DC	f _z									v _c
				0.5	0.6	0.8	1.0	1.2	1.5	2.0	2.5	3	
P1	M/E/A	0.0500	0.50	0.010	0.012	0.016	0.020	0.024	0.030	0.040	0.050	0.060	395 (360 – 430)
		0,0500	0,50	0,00040	0,00048	0,00065	0,00080	0,00095	0,0012	0,0016	0,0020	0,0024	1300 (1200 – 1400)
P2	M/E/A	0.0500	0.50	0.010	0.012	0.016	0.020	0.024	0.030	0.040	0.050	0.060	385 (350 – 420)
		0,0500	0,50	0,00040	0,00048	0,00065	0,00080	0,00095	0,0012	0,0016	0,0020	0,0024	1275 (1200 – 1300)
P3	M/E/A	0.0500	0.50	0.010	0.012	0.016	0.020	0.024	0.030	0.040	0.050	0.060	330 (300 – 360)
		0,0500	0,50	0,00040	0,00048	0,00065	0,00080	0,00095	0,0012	0,0016	0,0020	0,0024	1075 (990 – 1100)
P4	M/E/A	0.0500	0.50	0.010	0.012	0.016	0.020	0.024	0.030	0.040	0.050	0.060	290 (260 – 320)
		0,0500	0,50	0,00040	0,00048	0,00065	0,00080	0,00095	0,0012	0,0016	0,0020	0,0024	950 (860 – 1000)
P5	M/E/A	0.0500	0.50	0.010	0.012	0.016	0.020	0.024	0.030	0.040	0.050	0.060	280 (250 – 300)
		0,0500	0,50	0,00040	0,00048	0,00065	0,00080	0,00095	0,0012	0,0016	0,0020	0,0024	920 (860 – 980)
P6	M/E/A	0.0500	0.50	0.010	0.012	0.016	0.020	0.024	0.030	0.040	0.050	0.060	310 (280 – 340)
		0,0500	0,50	0,00040	0,00048	0,00065	0,00080	0,00095	0,0012	0,0016	0,0020	0,0024	1025 (920 – 1100)
P7	M/E/A	0.0500	0.50	0.010	0.012	0.016	0.020	0.024	0.030	0.040	0.050	0.060	295 (270 – 320)
		0,0500	0,50	0,00040	0,00048	0,00065	0,00080	0,00095	0,0012	0,0016	0,0020	0,0024	970 (890 – 1000)
P8	M/E/A	0.0500	0.50	0.010	0.012	0.016	0.020	0.024	0.030	0.040	0.050	0.060	280 (250 – 300)
		0,0500	0,50	0,00040	0,00048	0,00065	0,00080	0,00095	0,0012	0,0016	0,0020	0,0024	920 (830 – 980)
P11	M/E/A	0.0500	0.50	0.010	0.012	0.016	0.020	0.024	0.030	0.040	0.050	0.060	285 (260 – 310)
		0,0500	0,50	0,00040	0,00048	0,00065	0,00080	0,00095	0,0012	0,0016	0,0020	0,0024	940 (860 – 1000)
P12	M/E/A	0.0500	0.50	0.010	0.012	0.016	0.020	0.024	0.030	0.040	0.050	0.060	170 (160 – 180)
		0,0500	0,50	0,00040	0,00048	0,00065	0,00080	0,00095	0,0012	0,0016	0,0020	0,0024	560 (530 – 590)
M1	E/M/A	0.0250	0.50	0.010	0.012	0.016	0.020	0.024	0.030	0.040	0.050	0.060	235 (200 – 280)
		0,0250	0,50	0,00040	0,00048	0,00065	0,00080	0,00095	0,0012	0,0016	0,0020	0,0024	770 (660 – 910)
M2	E/M/A	0.0250	0.50	0.010	0.012	0.016	0.020	0.024	0.030	0.040	0.050	0.060	190 (160 – 220)
		0,0250	0,50	0,00040	0,00048	0,00065	0,00080	0,00095	0,0012	0,0016	0,0020	0,0024	620 (530 – 720)
M3	E/M/A	0.0250	0.50	0.010	0.012	0.016	0.020	0.024	0.030	0.040	0.050	0.060	190 (160 – 220)
		0,0250	0,50	0,00040	0,00048	0,00065	0,00080	0,00095	0,0012	0,0016	0,0020	0,0024	620 (530 – 720)
M4	E/M/A	0.0250	0.50	0.010	0.012	0.016	0.020	0.024	0.030	0.040	0.050	0.060	145 (120 – 160)
		0,0250	0,50	0,00040	0,00048	0,00065	0,00080	0,00095	0,0012	0,0016	0,0020	0,0024	475 (400 – 520)
M5	E/M/A	0.0250	0.50	0.010	0.012	0.016	0.020	0.024	0.030	0.040	0.050	0.060	120 (99 – 140)
		0,0250	0,50	0,00040	0,00048	0,00065	0,00080	0,00095	0,0012	0,0016	0,0020	0,0024	395 (330 – 450)
N1	E/M/A	0.100	0.90	0.010	0.012	0.016	0.020	0.024	0.030	0.040	0.050	0.060	550 (490 – 610)
		0,100	0,90	0,00040	0,00048	0,00065	0,00080	0,00095	0,0012	0,0016	0,0020	0,0024	1800 (1700 – 2000)
N2	E/M/A	0.100	0.90	0.010	0.012	0.016	0.020	0.024	0.030	0.040	0.050	0.060	550 (490 – 610)
		0,100	0,90	0,00040	0,00048	0,00065	0,00080	0,00095	0,0012	0,0016	0,0020	0,0024	1800 (1700 – 2000)
N3	E/M/A	0.100	0.90	0.010	0.012	0.016	0.020	0.024	0.030	0.040	0.050	0.060	365 (330 – 410)
		0,100	0,90	0,00040	0,00048	0,00065	0,00080	0,00095	0,0012	0,0016	0,0020	0,0024	1200 (1100 – 1300)
N11	E/M/A	0.100	0.90	0.012	0.015	0.020	0.025	0.030	0.038	0.050	0.060	0.075	490 (430 – 560)
		0,100	0,90	0,00048	0,00060	0,00080	0,0010	0,0012	0,0015	0,0020	0,0024	0,0030	1600 (1500 – 1800)
S11	E/M/A	0.0500	0.60	0.010	0.012	0.016	0.020	0.024	0.030	0.040	0.050	0.060	285 (250 – 320)
		0,0500	0,60	0,00040	0,00048	0,00065	0,00080	0,00095	0,0012	0,0016	0,0020	0,0024	940 (830 – 1000)
S12	E/M/A	0.0500	0.60	0.010	0.012	0.016	0.020	0.024	0.030	0.040	0.050	0.060	220 (190 – 250)
		0,0500	0,60	0,00040	0,00048	0,00065	0,00080	0,00095	0,0012	0,0016	0,0020	0,0024	720 (630 – 820)
S13	E/M/A	0.0500	0.60	0.010	0.012	0.016	0.020	0.024	0.030	0.040	0.050	0.060	170 (150 – 190)
		0,0500	0,60	0,00040	0,00048	0,00065	0,00080	0,00095	0,0012	0,0016	0,0020	0,0024	560 (500 – 620)
H3	M/A	0.0500	0.060	0.0090	0.011	0.014	0.018	0.022	0.026	0.036	0.038	0.042	125 (95 – 150)
		0,0500	0,060	0,00036	0,00044	0,00055	0,00070	0,00085	0,0010	0,0014	0,0015	0,0017	410 (320 – 490)
H5	M/A	0.0500	0.28	0.010	0.012	0.016	0.020	0.024	0.030	0.040	0.050	0.060	240 (210 – 260)
		0,0500	0,28	0,00040	0,00048	0,00065	0,00080	0,00095	0,0012	0,0016	0,0020	0,0024	790 (690 – 850)
H7	M/A	0.0500	0.060	0.0090	0.011	0.014	0.018	0.022	0.026	0.036	0.038	0.042	125 (95 – 150)
		0,0500	0,060	0,00036	0,00044	0,00055	0,00070	0,00085	0,0010	0,0014	0,0015	0,0017	410 (320 – 490)
H8	M/A	0.0500	0.28	0.010	0.012	0.016	0.020	0.024	0.030	0.040	0.050	0.055	240 (210 – 260)
		0,0500	0,28	0,00040	0,00048	0,00065	0,00080	0,00095	0,0012	0,0016	0,0020	0,0022	790 (690 – 850)
H11	M/A	0.0500	0.28	0.010	0.012	0.016	0.020	0.024	0.030	0.040	0.050	0.060	305 (270 – 340)
		0,0500	0,28	0,00040	0,00048	0,00065	0,00080	0,00095	0,0012	0,0016	0,0020	0,0024	1000 (890 – 1100)
H12	M/A	0.0500	0.28	0.010	0.012	0.016	0.020	0.024	0.030	0.040	0.050	0.055	275 (250 – 310)
		0,0500	0,28	0,00040	0,00048	0,00065	0,00080	0,00095	0,0012	0,0016	0,0020	0,0022	900 (830 – 1000)
H21	M/A	0.0500	0.28	0.010	0.012	0.016	0.020	0.024	0.030	0.040	0.050	0.055	240 (210 – 260)
		0,0500	0,28	0,00040	0,00048	0,00065	0,00080	0,00095	0,0012	0,0016	0,0020	0,0022	790 (690 – 850)
H31	M/A	0.0500	0.28	0.010	0.012	0.016	0.020	0.024	0.030	0.038	0.044	0.048	180 (160 – 200)
		0,0500	0,28	0,00040	0,00048	0,00065	0,00080	0,00095	0,0012	0,0015	0,0017	0,0019	590 (530 – 650)
GR1	A	0.500	0.65	0.0075	0.0090	0.012	0.015	0.018	0.020	0.025	0.028	0.032	390 (340 – 440)
		0,500	0,50	0,00030	0,00036	0,00048	0,00060	0,00070	0,00085	0,0010	0,0011	0,0013	1300 (1200 – 1400)

Table based on LV1, please recal based on length version chosen. See page(s) 556 - 563

SMG = Seco material group
 Coolant = A=air D=dry E=emulsion M=mist spray
 v_c = m/min (sf/min)
 f_z = mm (in/tooth)
 a_p = mm/DC (in/DC) = factor
 a_e = mm/DC (in/DC) = factor
 All cutting data are target values

Universal
Steel and cast iron
Stainless steel and S-materials
Non ferrous
Hard
Plastic and cfrp
Graphite
X-Heads
Minimaster Plus
Minimaster

Cutting data – JME564 Slot milling

SMG	Coolant	a _p /DC	f _z									v _c
			0.5	0.6	0.8	1.0	1.2	1.5	2.0	2.5	3	
P1	M/E/A	0.038	0.0065	0.0080	0.010	0.013	0.016	0.020	0.026	0.032	0.040	250 (230 – 270)
		0,038	0,00026	0,00032	0,00040	0,00050	0,00065	0,00080	0,0010	0,0013	0,0016	820 (760 – 880)
P2	M/E/A	0.038	0.0065	0.0080	0.010	0.013	0.016	0.020	0.026	0.032	0.040	245 (220 – 270)
		0,038	0,00026	0,00032	0,00040	0,00050	0,00065	0,00080	0,0010	0,0013	0,0016	800 (730 – 880)
P3	M/E/A	0.038	0.0065	0.0080	0.010	0.013	0.016	0.020	0.026	0.032	0.040	210 (190 – 230)
		0,038	0,00026	0,00032	0,00040	0,00050	0,00065	0,00080	0,0010	0,0013	0,0016	690 (630 – 750)
P4	M/E/A	0.038	0.0065	0.0080	0.010	0.013	0.016	0.020	0.026	0.032	0.040	185 (170 – 200)
		0,038	0,00026	0,00032	0,00040	0,00050	0,00065	0,00080	0,0010	0,0013	0,0016	610 (560 – 650)
P5	M/E/A	0.038	0.0065	0.0080	0.010	0.013	0.016	0.020	0.026	0.032	0.040	175 (160 – 190)
		0,038	0,00026	0,00032	0,00040	0,00050	0,00065	0,00080	0,0010	0,0013	0,0016	570 (530 – 620)
P6	M/E/A	0.038	0.0065	0.0080	0.010	0.013	0.016	0.020	0.026	0.032	0.040	200 (180 – 220)
		0,038	0,00026	0,00032	0,00040	0,00050	0,00065	0,00080	0,0010	0,0013	0,0016	660 (600 – 720)
P7	M/E/A	0.038	0.0065	0.0080	0.010	0.013	0.016	0.020	0.026	0.032	0.040	185 (170 – 200)
		0,038	0,00026	0,00032	0,00040	0,00050	0,00065	0,00080	0,0010	0,0013	0,0016	610 (560 – 650)
P8	M/E/A	0.038	0.0065	0.0080	0.010	0.013	0.016	0.020	0.026	0.032	0.040	175 (160 – 190)
		0,038	0,00026	0,00032	0,00040	0,00050	0,00065	0,00080	0,0010	0,0013	0,0016	570 (530 – 620)
P11	M/E/A	0.038	0.0065	0.0080	0.010	0.013	0.016	0.020	0.026	0.032	0.040	180 (170 – 200)
		0,038	0,00026	0,00032	0,00040	0,00050	0,00065	0,00080	0,0010	0,0013	0,0016	590 (560 – 650)
P12	M/E/A	0.038	0.0065	0.0080	0.010	0.013	0.016	0.019	0.024	0.026	0.030	105 (96 – 110)
		0,038	0,00026	0,00032	0,00040	0,00050	0,00065	0,00075	0,00095	0,0010	0,0012	345 (320 – 360)
M1	E/M/A	0.038	0.0065	0.0080	0.010	0.013	0.016	0.020	0.026	0.032	0.040	135 (110 – 150)
		0,038	0,00026	0,00032	0,00040	0,00050	0,00065	0,00080	0,0010	0,0013	0,0016	445 (370 – 490)
M2	E/M/A	0.038	0.0065	0.0080	0.010	0.013	0.016	0.020	0.026	0.032	0.040	110 (89 – 120)
		0,038	0,00026	0,00032	0,00040	0,00050	0,00065	0,00080	0,0010	0,0013	0,0016	360 (300 – 390)
M3	E/M/A	0.038	0.0065	0.0080	0.010	0.013	0.016	0.020	0.026	0.032	0.040	110 (89 – 120)
		0,038	0,00026	0,00032	0,00040	0,00050	0,00065	0,00080	0,0010	0,0013	0,0016	360 (300 – 390)
M4	E/M/A	0.038	0.0065	0.0080	0.010	0.013	0.016	0.020	0.026	0.032	0.038	80 (67 – 95)
		0,038	0,00026	0,00032	0,00040	0,00050	0,00065	0,00080	0,0010	0,0013	0,0015	260 (220 – 310)
M5	E/M/A	0.038	0.0065	0.0080	0.010	0.013	0.016	0.020	0.026	0.032	0.038	65 (56 – 79)
		0,038	0,00026	0,00032	0,00040	0,00050	0,00065	0,00080	0,0010	0,0013	0,0015	215 (190 – 250)
N1	E/M/A	0.15	0.0065	0.0080	0.010	0.013	0.016	0.020	0.026	0.032	0.040	390 (350 – 440)
		0,15	0,00026	0,00032	0,00040	0,00050	0,00065	0,00080	0,0010	0,0013	0,0016	1275 (1200 – 1400)
N2	E/M/A	0.15	0.0065	0.0080	0.010	0.013	0.016	0.020	0.026	0.032	0.040	390 (350 – 440)
		0,15	0,00026	0,00032	0,00040	0,00050	0,00065	0,00080	0,0010	0,0013	0,0016	1275 (1200 – 1400)
N3	E/M/A	0.15	0.0065	0.0080	0.010	0.013	0.016	0.020	0.026	0.032	0.040	260 (230 – 290)
		0,15	0,00026	0,00032	0,00040	0,00050	0,00065	0,00080	0,0010	0,0013	0,0016	850 (760 – 950)
N11	E/M/A	0.15	0.010	0.012	0.016	0.020	0.024	0.030	0.040	0.048	0.055	345 (300 – 390)
		0,15	0,00040	0,00048	0,00065	0,00080	0,00095	0,0012	0,0016	0,0019	0,0022	1125 (990 – 1200)
S11	E/M/A	0.11	0.0065	0.0080	0.010	0.013	0.016	0.020	0.026	0.032	0.040	180 (160 – 200)
		0,11	0,00026	0,00032	0,00040	0,00050	0,00065	0,00080	0,0010	0,0013	0,0016	590 (530 – 650)
S12	E/M/A	0.11	0.0065	0.0080	0.010	0.013	0.016	0.020	0.026	0.032	0.040	135 (120 – 150)
		0,11	0,00026	0,00032	0,00040	0,00050	0,00065	0,00080	0,0010	0,0013	0,0016	445 (400 – 490)
S13	E/M/A	0.11	0.0065	0.0080	0.010	0.013	0.016	0.020	0.026	0.032	0.036	105 (92 – 120)
		0,11	0,00026	0,00032	0,00040	0,00050	0,00065	0,00080	0,0010	0,0013	0,0014	345 (310 – 390)
H3	M/A	0.0060	0.0060	0.0070	0.0095	0.012	0.014	0.018	0.024	0.030	0.036	80 (59 – 98)
		0,0060	0,00024	0,00028	0,00038	0,00048	0,00055	0,00070	0,00095	0,0012	0,0014	260 (200 – 320)
H5	M/A	0.020	0.0065	0.0080	0.010	0.013	0.016	0.020	0.026	0.032	0.040	160 (140 – 170)
		0,020	0,00026	0,00032	0,00040	0,00050	0,00065	0,00080	0,0010	0,0013	0,0016	520 (460 – 550)
H7	M/A	0.0060	0.0060	0.0070	0.0095	0.012	0.014	0.018	0.024	0.030	0.036	80 (59 – 98)
		0,0060	0,00024	0,00028	0,00038	0,00048	0,00055	0,00070	0,00095	0,0012	0,0014	260 (200 – 320)
H8	M/A	0.020	0.0065	0.0080	0.010	0.013	0.016	0.020	0.026	0.030	0.032	160 (140 – 170)
		0,020	0,00026	0,00032	0,00040	0,00050	0,00065	0,00080	0,0010	0,0012	0,0013	520 (460 – 550)
H11	M/A	0.020	0.0065	0.0080	0.010	0.013	0.016	0.020	0.026	0.032	0.040	200 (180 – 220)
		0,020	0,00026	0,00032	0,00040	0,00050	0,00065	0,00080	0,0010	0,0013	0,0016	660 (600 – 720)
H12	M/A	0.020	0.0065	0.0080	0.010	0.013	0.016	0.020	0.026	0.030	0.032	185 (170 – 200)
		0,020	0,00026	0,00032	0,00040	0,00050	0,00065	0,00080	0,0010	0,0012	0,0013	610 (560 – 650)
H21	M/A	0.020	0.0065	0.0080	0.010	0.013	0.016	0.020	0.026	0.030	0.032	160 (140 – 170)
		0,020	0,00026	0,00032	0,00040	0,00050	0,00065	0,00080	0,0010	0,0012	0,0013	520 (460 – 550)
H31	M/A	0.020	0.0065	0.0080	0.010	0.013	0.016	0.019	0.022	0.025	0.028	120 (110 – 130)
		0,020	0,00026	0,00032	0,00040	0,00050	0,00065	0,00075	0,00085	0,0010	0,0011	395 (370 – 420)
GR1	A	0.20	0.0050	0.0060	0.0080	0.010	0.012	0.015	0.020	0.024	0.026	325 (280 – 370)
		0,20	0,00020	0,00024	0,00032	0,00040	0,00048	0,00060	0,00080	0,00095	0,0010	1075 (920 – 1200)

Table based on LV1, please recalc based on length version chosen. See page(s) 556 - 563

SMG = Seco material group
Coolant = A=air D=dry E=emulsion M=mist spray
v_c = m/min (sf/min)
f_z = mm (in/tooth)
a_p = mm/DC (in/DC) = factor
a_e = mm/DC (in/DC) = factor
All cutting data are target values

JMB542

Miniature – Universal – Ball nose – 2 Flutes – DMM 4 – Cylindrical

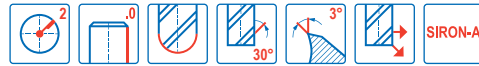
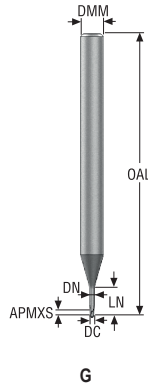

- Tolerances:
- Run-out=<0,007 mm
- DMM= h5
- DC= 0,-0,01 mm
- RE= ±0,005 mm

Designation	Item number	Length index	Tool shape	DC	DMM	APMXS	OAL	LN	DN	RE	CA°	PCEDC Cylindrical
				mm	mm	mm	mm	mm	mm	mm	mm	
JMB542002G1B.0Z2-SIRA	03171221	1	G	0,2	4,0	0,2	45,0	0,4	0,18	0,1	14,57	2 ■
JMB542003G1B.0Z2-SIRA	03171222	1	G	0,3	4,0	0,3	45,0	0,6	0,28	0,15	14,24	2 ■
JMB542004G1B.0Z2-SIRA	03171223	1	G	0,4	4,0	0,4	45,0	0,8	0,37	0,2	13,81	2 ■
JMB542005G1B.0Z2-SIRA	03171224	1	G	0,5	4,0	0,5	45,0	1,0	0,46	0,25	13,47	2 ■
JMB542006G1B.0Z2-SIRA	03171225	1	G	0,6	4,0	0,6	45,0	1,2	0,56	0,3	13,14	2 ■
JMB542008G1B.0Z2-SIRA	03171226	1	G	0,8	4,0	0,8	45,0	1,6	0,76	0,4	12,46	2 ■
JMB542010G1B.0Z2-SIRA	03171228	1	G	1,0	4,0	1,0	50,0	2,0	0,95	0,5	11,77	2 ■
JMB542012G1B.0Z2-SIRA	03171229	1	G	1,2	4,0	1,2	50,0	2,4	1,15	0,6	11,07	2 ■
JMB542015G1B.0Z2-SIRA	03171230	1	G	1,5	4,0	1,5	50,0	3,0	1,45	0,75	9,88	2 ■
JMB542005G3B.0Z2-SIRA	03171231	3	G	0,5	4,0	0,5	45,0	2,5	0,46	0,25	11,25	2 ■
JMB542006G3B.0Z2-SIRA	03171233	3	G	0,6	4,0	0,6	45,0	3,0	0,56	0,3	10,61	2 ■
JMB542008G3B.0Z2-SIRA	03171234	3	G	0,8	4,0	0,8	45,0	4,0	0,76	0,4	9,44	2 ■
JMB542010G3B.0Z2-SIRA	03171235	3	G	1,0	4,0	1,0	50,0	5,0	0,95	0,5	8,38	2 ■
JMB542012G3B.0Z2-SIRA	03171236	3	G	1,2	4,0	1,2	50,0	6,0	1,15	0,6	7,44	2 ■
JMB542015G3B.0Z2-SIRA	03171237	3	G	1,5	4,0	1,5	50,0	7,5	1,45	0,75	6,13	2 ■
JMB542020G3B.0Z2-SIRA	03171238	3	G	2,0	4,0	2,0	50,0	10,0	1,94	1,0	4,4	2 ■
JMB542025G3B.0Z2-SIRA	03171239	3	G	2,5	4,0	2,5	50,0	12,5	2,4	1,25	3,0	2 ■
JMB542030G3B.0Z2-SIRA	03171240	3	G	3,0	4,0	3,0	60,0	15,0	2,85	1,5	1,81	2 ■
JMB542005G4B.0Z2-SIRA	03171241	4	G	0,5	4,0	0,5	45,0	4,0	0,46	0,25	9,65	2 ■
JMB542006G4B.0Z2-SIRA	03171242	4	G	0,6	4,0	0,6	45,0	5,0	0,56	0,3	8,74	2 ■
JMB542008G4B.0Z2-SIRA	03171243	4	G	0,8	4,0	0,8	45,0	7,0	0,76	0,4	7,23	2 ■
JMB542010G4B.0Z2-SIRA	03171244	4	G	1,0	4,0	1,0	50,0	8,5	0,95	0,5	6,27	2 ■
JMB542012G4B.0Z2-SIRA	03171245	4	G	1,2	4,0	1,2	50,0	10,0	1,15	0,6	5,44	2 ■
JMB542015G4B.0Z2-SIRA	03171246	4	G	1,5	4,0	1,5	50,0	12,0	1,45	0,75	4,44	2 ■
JMB542020G4B.0Z2-SIRA	03171247	4	G	2,0	4,0	2,0	60,0	16,0	1,94	1,0	3,02	2 ■
JMB542025G4B.0Z2-SIRA	03171248	4	G	2,5	4,0	2,5	60,0	20,0	2,4	1,25	1,97	2 ■
JMB542030G4B.0Z2-SIRA	03171249	4	G	3,0	4,0	3,0	70,0	24,0	2,85	1,5	1,16	2 ■
JMB542015G5B.0Z2-SIRA	03171250	5	G	1,5	4,0	1,5	60,0	15,0	1,45	0,75	3,75	2 ■
JMB542020G5B.0Z2-SIRA	03171251	5	G	2,0	4,0	2,0	60,0	20,0	1,94	1,0	2,5	2 ■
JMB542025G5B.0Z2-SIRA	03171252	5	G	2,5	4,0	2,5	70,0	25,0	2,4	1,25	1,61	2 ■
JMB542030G5B.0Z2-SIRA	03171253	5	G	3,0	4,0	3,0	70,0	30,0	2,85	1,5	0,93	2 ■
JMB542015G6B.0Z2-SIRA	03171254	6	G	1,5	4,0	1,5	70,0	22,5	1,45	0,75	2,7	2 ■
JMB542020G6B.0Z2-SIRA	03171255	6	G	2,0	4,0	2,0	70,0	30,0	1,94	1,0	1,74	2 ■
JMB542025G6B.0Z2-SIRA	03171256	6	G	2,5	4,0	2,5	80,0	37,5	2,4	1,25	1,1	2 ■
JMB542030G6B.0Z2-SIRA	03171257	6	G	3,0	4,0	3,0	90,0	45,0	2,85	1,5	0,63	2 ■

■ Stocked standard.

Universal

Steel and cast iron

Stainless steel and S-materials

Non ferrous

Hard

Plastic and CFRP

Graphite

X-Heads

Minimaster Plus

Minimaster

JMB562

Miniature – Universal – Ball nose – 2 Flutes – DMM6 – Cylindrical



- Tolerances:
- Run-out=<0,007 mm
- DMM= h5
- DC= 0,-0,01 mm
- RE= ±0,005 mm

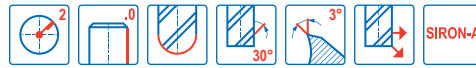

Designation	Item number	Length index	Tool shape	DC	DMM	APMXS	OAL	LN	DN	RE	CA°	PCEDC Cylindrical	
				mm	mm	mm	mm	mm	mm	mm	mm		
JMB562005G2B.0Z2-SIRA	03171261	2	G	0,5	6,0	0,5	50,0	1,5	0,46	0,25	13,69	2	■
JMB562006G2B.0Z2-SIRA	03171262	2	G	0,6	6,0	0,6	50,0	2,0	0,56	0,3	13,13	2	■
JMB562008G2B.0Z2-SIRA	03171263	2	G	0,8	6,0	0,8	50,0	2,5	0,76	0,4	12,6	2	■
JMB562010G2B.0Z2-SIRA	03171264	2	G	1,0	6,0	1,0	50,0	4,0	0,95	0,5	11,15	2	■
JMB562012G2B.0Z2-SIRA	03171265	2	G	1,2	6,0	1,2	50,0	4,5	1,15	0,6	10,67	2	■
JMB562015G2B.0Z2-SIRA	03171266	2	G	1,5	6,0	1,5	50,0	5,0	1,45	0,75	10,07	2	■
JMB562018G2B.0Z2-SIRA	03171267	2	G	1,8	6,0	1,8	50,0	5,4	1,75	0,9	9,61	2	■
JMB562020G2B.0Z2-SIRA	03171268	2	G	2,0	6,0	2,0	50,0	6,0	1,94	1,0	9,05	2	■
JMB562025G2B.0Z2-SIRA	03171269	2	G	2,5	6,0	2,5	60,0	7,5	2,4	1,25	7,71	2	■
JMB562030G2B.0Z2-SIRA	03171270	2	G	3,0	6,0	3,0	60,0	9,0	2,85	1,5	6,35	2	■
JMB562005G4B.0Z2-SIRA	03171271	4	G	0,5	6,0	0,5	50,0	3,5	0,46	0,25	11,7	2	■
JMB562006G4B.0Z2-SIRA	03171272	4	G	0,6	6,0	0,6	50,0	4,2	0,56	0,3	11,1	2	■
JMB562008G4B.0Z2-SIRA	03171273	4	G	0,8	6,0	0,8	50,0	5,6	0,76	0,4	10,02	2	■
JMB562010G4B.0Z2-SIRA	03171274	4	G	1,0	6,0	1,0	50,0	7,0	0,95	0,5	9,06	2	■
JMB562012G4B.0Z2-SIRA	03171275	4	G	1,2	6,0	1,2	50,0	8,4	1,15	0,6	8,22	2	■
JMB562015G4B.0Z2-SIRA	03171276	4	G	1,5	6,0	1,5	50,0	10,5	1,45	0,75	7,07	2	■
JMB562020G4B.0Z2-SIRA	03171277	4	G	2,0	6,0	2,0	60,0	14,0	1,94	1,0	5,57	2	■
JMB562025G4B.0Z2-SIRA	03171278	4	G	2,5	6,0	2,5	65,0	17,5	2,4	1,25	4,38	2	■
JMB562030G4B.0Z2-SIRA	03171279	4	G	3,0	6,0	3,0	70,0	21,0	2,85	1,5	3,38	2	■
JMB562005G5B.0Z2-SIRA	03171280	5	G	0,5	6,0	0,5	50,0	5,0	0,46	0,25	10,54	2	■
JMB562006G5B.0Z2-SIRA	03171281	5	G	0,6	6,0	0,6	50,0	6,0	0,56	0,3	9,85	2	■
JMB562008G5B.0Z2-SIRA	03171282	5	G	0,8	6,0	0,8	50,0	8,0	0,76	0,4	8,64	2	■
JMB562010G5B.0Z2-SIRA	03171283	5	G	1,0	6,0	1,0	50,0	10,0	0,95	0,5	7,63	2	■
JMB562012G5B.0Z2-SIRA	03171284	5	G	1,2	6,0	1,2	50,0	12,0	1,15	0,6	6,77	2	■
JMB562015G5B.0Z2-SIRA	03171285	5	G	1,5	6,0	1,5	60,0	15,0	1,45	0,75	5,68	2	■
JMB562020G5B.0Z2-SIRA	03171287	5	G	2,0	6,0	2,0	60,0	20,0	1,94	1,0	4,32	2	■
JMB562025G5B.0Z2-SIRA	03171288	5	G	2,5	6,0	2,5	70,0	25,0	2,4	1,25	3,3	2	■
JMB562030G5B.0Z2-SIRA	03171289	5	G	3,0	6,0	3,0	70,0	30,0	2,85	1,5	2,5	2	■

■ Stocked standard.

Universal
Steel and cast iron
Stainless steel and S-materials
Non ferrous
Hard
Plastic and cfrp
Graphite
X-Heads
Minimaster Plus
Minimaster

JMB562

Miniature – Universal – Ball nose – 2 Flutes – DMM 6 – Cylindrical



G

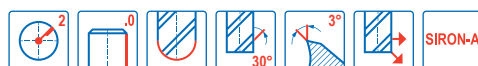

- Tolerances:
- Run-out=<0,007 mm
- DMM= h5
- DC= 0,-0,01 mm
- RE= ±0,005 mm

Designation	Item number	Length index	Tool shape	DC	DMM	APMXS	OAL	LN	DN	RE	CA°	PCEDC Cylindrical
				mm	mm	mm	mm	mm	mm	mm		
JMB562010G6B.0Z2-SIRA	03171290	6	G	1,0	6,0	1,0	60,0	15,0	0,95	0,5	6,04	2 ■
JMB562012G6B.0Z2-SIRA	03171291	6	G	1,2	6,0	1,2	60,0	18,0	1,15	0,6	5,24	2 ■
JMB562015G6B.0Z2-SIRA	03171292	6	G	1,5	6,0	1,5	70,0	22,5	1,45	0,75	4,28	2 ■
JMB562020G6B.0Z2-SIRA	03171293	6	G	2,0	6,0	2,0	80,0	30,0	1,94	1,0	3,14	2 ■
JMB562025G6B.0Z2-SIRA	03171294	6	G	2,5	6,0	2,5	80,0	37,5	2,4	1,25	2,34	2 ■
JMB562030G6B.0Z2-SIRA	03171295	6	G	3,0	6,0	3,0	90,0	45,0	2,85	1,5	1,74	2 ■
JMB562010G7B.0Z2-SIRA	03171296	7	G	1,0	6,0	1,0	60,0	20,0	0,95	0,5	4,99	2 ■
JMB562012G7B.0Z2-SIRA	03171297	7	G	1,2	6,0	1,2	80,0	24,0	1,15	0,6	4,27	2 ■
JMB562015G7B.0Z2-SIRA	03171298	7	G	1,5	6,0	1,5	80,0	30,0	1,45	0,75	3,43	2 ■
JMB562020G7B.0Z2-SIRA	03171299	7	G	2,0	6,0	2,0	80,0	40,0	1,94	1,0	2,47	2 ■
JMB562025G7B.0Z2-SIRA	03171300	7	G	2,5	6,0	2,5	90,0	50,0	2,4	1,25	1,81	2 ■
JMB562030G7B.0Z2-SIRA	03171301	7	G	3,0	6,0	3,0	100,0	60,0	2,85	1,5	1,34	2 ■

■ Stocked standard.

Universal

Steel and cast iron

Stainless steel and S-materials

Non ferrous

Hard

Plastic and CFRP

Graphite

X-Heads

Minimaster Plus

Minimaster

Cutting data – JMB562 Copy milling roughing

SMG		a_e /DC	a_p /DC	f_z												v_c
				0.2	0.3	0.4	0.5	0.6	0.8	1.0	1.2	1.8	2.0	2.5	3.0	
				[Values in the body of the table]												
P1	M/E/A	0.0500	0.60	0.0040	0.0060	0.0080	0.010	0.012	0.016	0.020	0.024	0.036	0.040	0.050	0.060	365 (330 – 400)
P2	M/E/A	0.0500	0.60	0.0040	0.0060	0.0080	0.010	0.012	0.016	0.020	0.024	0.036	0.040	0.050	0.060	1200 (1100 – 1300)
P3	M/E/A	0.0500	0.60	0.0040	0.0060	0.0080	0.010	0.012	0.016	0.020	0.024	0.036	0.040	0.050	0.060	305 (280 – 330)
P4	M/E/A	0.0500	0.60	0.0040	0.0060	0.0080	0.010	0.012	0.016	0.020	0.024	0.036	0.040	0.050	0.060	270 (240 – 290)
P5	M/E/A	0.0500	0.60	0.0040	0.0060	0.0080	0.010	0.012	0.016	0.020	0.024	0.036	0.040	0.050	0.060	255 (230 – 280)
P6	M/E/A	0.0500	0.60	0.0040	0.0060	0.0080	0.010	0.012	0.016	0.020	0.024	0.036	0.040	0.050	0.060	840 (760 – 910)
P7	M/E/A	0.0500	0.60	0.0040	0.0060	0.0080	0.010	0.012	0.016	0.020	0.024	0.036	0.040	0.050	0.060	270 (250 – 300)
P8	M/E/A	0.0500	0.60	0.0040	0.0060	0.0080	0.010	0.012	0.016	0.020	0.024	0.036	0.040	0.050	0.060	255 (230 – 280)
P11	M/E/A	0.0500	0.60	0.0040	0.0060	0.0080	0.010	0.012	0.016	0.020	0.024	0.036	0.040	0.050	0.060	265 (240 – 290)
P12	M/E/A	0.0500	0.60	0.0040	0.0060	0.0080	0.010	0.012	0.016	0.020	0.024	0.036	0.040	0.050	0.060	155 (140 – 170)
M1	E/M/A	0.0250	0.60	0.0040	0.0060	0.0080	0.010	0.012	0.016	0.020	0.024	0.036	0.040	0.050	0.060	215 (180 – 250)
M2	E/M/A	0.0250	0.60	0.0040	0.0060	0.0080	0.010	0.012	0.016	0.020	0.024	0.036	0.040	0.050	0.060	175 (150 – 200)
M3	E/M/A	0.0250	0.60	0.0040	0.0060	0.0080	0.010	0.012	0.016	0.020	0.024	0.036	0.040	0.050	0.060	175 (150 – 200)
M4	E/M/A	0.0250	0.60	0.0040	0.0060	0.0080	0.010	0.012	0.016	0.020	0.024	0.036	0.040	0.050	0.060	130 (110 – 150)
M5	E/M/A	0.0250	0.60	0.0040	0.0060	0.0080	0.010	0.012	0.016	0.020	0.024	0.036	0.040	0.050	0.060	425 (370 – 490)
N1	E/M/A	0.100	0.75	0.0040	0.0060	0.0080	0.010	0.012	0.016	0.020	0.024	0.036	0.040	0.050	0.060	485 (430 – 540)
N2	E/M/A	0.100	0.75	0.0040	0.0060	0.0080	0.010	0.012	0.016	0.020	0.024	0.036	0.040	0.050	0.060	485 (430 – 540)
N3	E/M/A	0.100	0.75	0.0040	0.0060	0.0080	0.010	0.012	0.016	0.020	0.024	0.036	0.040	0.050	0.060	325 (290 – 360)
N11	E/M/A	0.100	0.75	0.0050	0.0075	0.010	0.012	0.015	0.020	0.025	0.030	0.046	0.050	0.060	0.075	430 (370 – 480)
S11	E/M/A	0.0250	0.60	0.0040	0.0060	0.0080	0.010	0.012	0.016	0.020	0.024	0.036	0.040	0.050	0.060	290 (250 – 330)
S12	E/M/A	0.0250	0.60	0.0040	0.0060	0.0080	0.010	0.012	0.016	0.020	0.024	0.036	0.040	0.050	0.060	225 (200 – 250)
S13	E/M/A	0.0250	0.60	0.0040	0.0060	0.0080	0.010	0.012	0.016	0.020	0.024	0.036	0.040	0.050	0.060	175 (150 – 190)
H3	M/A	0.0500	0.30	0.0036	0.0055	0.0070	0.0090	0.011	0.014	0.018	0.022	0.032	0.036	0.044	0.055	120 (90 – 140)
H5	M/A	0.0500	0.44	0.0040	0.0060	0.0080	0.010	0.012	0.016	0.020	0.024	0.036	0.040	0.050	0.060	395 (300 – 450)
H7	M/A	0.0500	0.30	0.0036	0.0055	0.0070	0.0090	0.011	0.014	0.018	0.022	0.032	0.036	0.044	0.055	235 (210 – 260)
H8	M/A	0.0500	0.44	0.0040	0.0060	0.0080	0.010	0.012	0.016	0.020	0.024	0.036	0.040	0.050	0.060	770 (690 – 850)
H11	M/A	0.0500	0.44	0.0040	0.0060	0.0080	0.010	0.012	0.016	0.020	0.024	0.036	0.040	0.050	0.060	300 (270 – 330)
H12	M/A	0.0500	0.44	0.0040	0.0060	0.0080	0.010	0.012	0.016	0.020	0.024	0.036	0.040	0.050	0.060	980 (890 – 1000)
H21	M/A	0.0500	0.44	0.0040	0.0060	0.0080	0.010	0.012	0.016	0.020	0.024	0.036	0.040	0.050	0.060	275 (240 – 300)
H31	M/A	0.0500	0.44	0.0040	0.0060	0.0080	0.010	0.012	0.016	0.020	0.024	0.036	0.040	0.050	0.060	235 (210 – 260)
GR1	A	0.500	0.50	0.0030	0.0044	0.0060	0.0075	0.0090	0.012	0.015	0.018	0.028	0.030	0.038	0.040	405 (350 – 460)

Table based on LV1, please recal based on length version chosen. See page(s) 556 - 563

SMG = Seco material group
 Coolant = A=air D=dry E=emulsion M=mist spray
 v_c = m/min (sf/min)
 f_z = mm (in/tooth)
 a_p = mm/DC (in/DC) = factor
 a_e = mm/DC (in/DC) = factor
 All cutting data are target values

Cutting data – JMB562 Slot milling

SMG		a _p /DC	f _z												v _c
			0.2	0.3	0.4	0.5	0.6	0.8	1.0	1.2	1.8	2.0	2.5	3.0	
P1	M/E/A	0.32	0.0026	0.0040	0.0050	0.0065	0.0080	0.010	0.013	0.016	0.024	0.026	0.032	0.040	255 (230 — 280)
		0.32	0.00010	0.00016	0.00020	0.00026	0.00032	0.00040	0.00050	0.00065	0.00095	0.0010	0.0013	0.0016	840 (760 — 910)
P2	M/E/A	0.32	0.0026	0.0040	0.0050	0.0065	0.0080	0.010	0.013	0.016	0.024	0.026	0.032	0.040	250 (230 — 270)
		0.32	0.00010	0.00016	0.00020	0.00026	0.00032	0.00040	0.00050	0.00065	0.00095	0.0010	0.0013	0.0016	820 (760 — 880)
P3	M/E/A	0.32	0.0026	0.0040	0.0050	0.0065	0.0080	0.010	0.013	0.016	0.024	0.026	0.032	0.040	215 (200 — 230)
		0.32	0.00010	0.00016	0.00020	0.00026	0.00032	0.00040	0.00050	0.00065	0.00095	0.0010	0.0013	0.0016	710 (660 — 750)
P4	M/E/A	0.32	0.0026	0.0040	0.0050	0.0065	0.0080	0.010	0.013	0.016	0.024	0.026	0.032	0.040	190 (170 — 200)
		0.32	0.00010	0.00016	0.00020	0.00026	0.00032	0.00040	0.00050	0.00065	0.00095	0.0010	0.0013	0.0016	620 (560 — 650)
P5	M/E/A	0.32	0.0026	0.0040	0.0050	0.0065	0.0080	0.010	0.013	0.016	0.024	0.026	0.032	0.040	180 (170 — 200)
		0.32	0.00010	0.00016	0.00020	0.00026	0.00032	0.00040	0.00050	0.00065	0.00095	0.0010	0.0013	0.0016	590 (560 — 650)
P6	M/E/A	0.32	0.0026	0.0040	0.0050	0.0065	0.0080	0.010	0.013	0.016	0.024	0.026	0.032	0.040	200 (180 — 220)
		0.32	0.00010	0.00016	0.00020	0.00026	0.00032	0.00040	0.00050	0.00065	0.00095	0.0010	0.0013	0.0016	660 (600 — 720)
P7	M/E/A	0.32	0.0026	0.0040	0.0050	0.0065	0.0080	0.010	0.013	0.016	0.024	0.026	0.032	0.040	190 (170 — 210)
		0.32	0.00010	0.00016	0.00020	0.00026	0.00032	0.00040	0.00050	0.00065	0.00095	0.0010	0.0013	0.0016	620 (560 — 680)
P8	M/E/A	0.32	0.0026	0.0040	0.0050	0.0065	0.0080	0.010	0.013	0.016	0.024	0.026	0.032	0.040	180 (170 — 200)
		0.32	0.00010	0.00016	0.00020	0.00026	0.00032	0.00040	0.00050	0.00065	0.00095	0.0010	0.0013	0.0016	590 (560 — 650)
P11	M/E/A	0.32	0.0026	0.0040	0.0050	0.0065	0.0080	0.010	0.013	0.016	0.024	0.026	0.032	0.040	185 (170 — 200)
		0.32	0.00010	0.00016	0.00020	0.00026	0.00032	0.00040	0.00050	0.00065	0.00095	0.0010	0.0013	0.0016	610 (560 — 650)
P12	M/E/A	0.32	0.0026	0.0040	0.0050	0.0065	0.0080	0.010	0.013	0.016	0.024	0.026	0.032	0.040	110 (98 — 120)
		0.32	0.00010	0.00016	0.00020	0.00026	0.00032	0.00040	0.00050	0.00065	0.00095	0.0010	0.0013	0.0016	360 (320 — 390)
M1	E/M/A	0.32	0.0026	0.0040	0.0050	0.0065	0.0080	0.010	0.013	0.016	0.024	0.026	0.032	0.040	135 (120 — 160)
		0.32	0.00010	0.00016	0.00020	0.00026	0.00032	0.00040	0.00050	0.00065	0.00095	0.0010	0.0013	0.0016	445 (400 — 520)
M2	E/M/A	0.32	0.0026	0.0040	0.0050	0.0065	0.0080	0.010	0.013	0.016	0.024	0.026	0.032	0.040	110 (90 — 130)
		0.32	0.00010	0.00016	0.00020	0.00026	0.00032	0.00040	0.00050	0.00065	0.00095	0.0010	0.0013	0.0016	360 (300 — 420)
M3	E/M/A	0.32	0.0026	0.0040	0.0050	0.0065	0.0080	0.010	0.013	0.016	0.024	0.026	0.032	0.040	110 (90 — 130)
		0.32	0.00010	0.00016	0.00020	0.00026	0.00032	0.00040	0.00050	0.00065	0.00095	0.0010	0.0013	0.0016	360 (300 — 420)
M4	E/M/A	0.32	0.0026	0.0040	0.0050	0.0065	0.0080	0.010	0.013	0.016	0.024	0.026	0.032	0.040	80 (68 — 97)
		0.32	0.00010	0.00016	0.00020	0.00026	0.00032	0.00040	0.00050	0.00065	0.00095	0.0010	0.0013	0.0016	260 (230 — 310)
M5	E/M/A	0.32	0.0026	0.0040	0.0050	0.0065	0.0080	0.010	0.013	0.016	0.024	0.026	0.032	0.040	70 (57 — 81)
		0.32	0.00010	0.00016	0.00020	0.00026	0.00032	0.00040	0.00050	0.00065	0.00095	0.0010	0.0013	0.0016	230 (190 — 260)
N1	E/M/A	0.24	0.0026	0.0040	0.0050	0.0065	0.0080	0.010	0.013	0.016	0.024	0.026	0.032	0.040	400 (350 — 440)
		0.24	0.00010	0.00016	0.00020	0.00026	0.00032	0.00040	0.00050	0.00065	0.00095	0.0010	0.0013	0.0016	1300 (1200 — 1400)
N2	E/M/A	0.26	0.0026	0.0040	0.0050	0.0065	0.0080	0.010	0.013	0.016	0.024	0.026	0.032	0.040	400 (350 — 440)
		0.26	0.00010	0.00016	0.00020	0.00026	0.00032	0.00040	0.00050	0.00065	0.00095	0.0010	0.0013	0.0016	1300 (1200 — 1400)
N3	E/M/A	0.26	0.0026	0.0040	0.0050	0.0065	0.0080	0.010	0.013	0.016	0.024	0.026	0.032	0.040	265 (240 — 290)
		0.26	0.00010	0.00016	0.00020	0.00026	0.00032	0.00040	0.00050	0.00065	0.00095	0.0010	0.0013	0.0016	870 (790 — 950)
N11	E/M/A	0.24	0.0040	0.0060	0.0080	0.010	0.012	0.016	0.020	0.024	0.036	0.040	0.050	0.060	350 (300 — 390)
		0.24	0.00016	0.00024	0.00032	0.00040	0.00048	0.00065	0.00080	0.00095	0.0014	0.0016	0.0020	0.0024	1150 (990 — 1200)
S11	E/M/A	0.36	0.0026	0.0040	0.0050	0.0065	0.0080	0.010	0.013	0.016	0.024	0.026	0.032	0.040	180 (160 — 200)
		0.36	0.00010	0.00016	0.00020	0.00026	0.00032	0.00040	0.00050	0.00065	0.00095	0.0010	0.0013	0.0016	590 (530 — 650)
S12	E/M/A	0.36	0.0026	0.0040	0.0050	0.0065	0.0080	0.010	0.013	0.016	0.024	0.026	0.032	0.040	140 (120 — 150)
		0.36	0.00010	0.00016	0.00020	0.00026	0.00032	0.00040	0.00050	0.00065	0.00095	0.0010	0.0013	0.0016	460 (400 — 490)
S13	E/M/A	0.36	0.0026	0.0040	0.0050	0.0065	0.0080	0.010	0.013	0.016	0.024	0.026	0.032	0.040	105 (93 — 120)
		0.36	0.00010	0.00016	0.00020	0.00026	0.00032	0.00040	0.00050	0.00065	0.00095	0.0010	0.0013	0.0016	345 (310 — 390)
H3	M/A	0.10	0.0024	0.0036	0.0048	0.0060	0.0070	0.0095	0.012	0.014	0.022	0.024	0.030	0.036	80 (61 — 100)
		0.10	0.000095	0.00014	0.00019	0.00024	0.00028	0.00038	0.00048	0.00055	0.00085	0.00095	0.0012	0.0014	260 (210 — 320)
H5	M/A	0.20	0.0026	0.0040	0.0050	0.0065	0.0080	0.010	0.013	0.016	0.024	0.026	0.032	0.040	160 (150 — 180)
		0.20	0.00010	0.00016	0.00020	0.00026	0.00032	0.00040	0.00050	0.00065	0.00095	0.0010	0.0013	0.0016	520 (500 — 590)
H7	M/A	0.10	0.0024	0.0036	0.0048	0.0060	0.0070	0.0095	0.012	0.014	0.022	0.024	0.030	0.036	80 (61 — 100)
		0.10	0.000095	0.00014	0.00019	0.00024	0.00028	0.00038	0.00048	0.00055	0.00085	0.00095	0.0012	0.0014	260 (210 — 320)
H8	M/A	0.20	0.0026	0.0040	0.0050	0.0065	0.0080	0.010	0.013	0.016	0.024	0.026	0.032	0.040	160 (150 — 180)
		0.20	0.00010	0.00016	0.00020	0.00026	0.00032	0.00040	0.00050	0.00065	0.00095	0.0010	0.0013	0.0016	520 (500 — 590)
H11	M/A	0.20	0.0026	0.0040	0.0050	0.0065	0.0080	0.010	0.013	0.016	0.024	0.026	0.032	0.040	205 (180 — 230)
		0.20	0.00010	0.00016	0.00020	0.00026	0.00032	0.00040	0.00050	0.00065	0.00095	0.0010	0.0013	0.0016	670 (600 — 750)
H12	M/A	0.20	0.0026	0.0040	0.0050	0.0065	0.0080	0.010	0.013	0.016	0.024	0.026	0.032	0.040	190 (170 — 210)
		0.20	0.00010	0.00016	0.00020	0.00026	0.00032	0.00040	0.00050	0.00065	0.00095	0.0010	0.0013	0.0016	620 (560 — 680)
H21	M/A	0.20	0.0026	0.0040	0.0050	0.0065	0.0080	0.010	0.013	0.016	0.024	0.026	0.032	0.040	160 (150 — 180)
		0.20	0.00010	0.00016	0.00020	0.00026	0.00032	0.00040	0.00050	0.00065	0.00095	0.0010	0.0013	0.0016	520 (500 — 590)
H31	M/A	0.20	0.0026	0.0040	0.0050	0.0065	0.0080	0.010	0.013	0.016	0.024	0.026	0.032	0.040	120 (110 — 130)
		0.20	0.00010	0.00016	0.00020	0.00026	0.00032	0.00040	0.00050	0.00065	0.00095	0.0010	0.0013	0.0016	395 (370 — 420)
GR1	A	0.50	0.0020	0.0030	0.0040	0.0050	0.0060	0.0080	0.010	0.012	0.018	0.020	0.025	0.030	350 (300 — 390)
		0.50	0.000080	0.00012	0.00016	0.00020	0.00024	0.00032	0.00040	0.00048	0.00070	0.00080	0.0010	0.0012	1150 (990 — 1200)

Table based on LV1, please recalcal based on length version chosen. See page(s) 556 - 563

SMG = Seco material group
Coolant

JMB563

Miniature – Universal – Ball nose – 3 Flutes – DMM 6 – Cylindrical

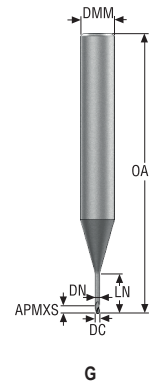

- Tolerances:
- Run-out=<0,007 mm
- DMM= h5
- DC= 0,-0,02 mm
- RE= ±0,01 mm

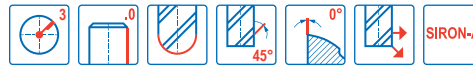

Designation	Item number	Length index	Tool shape	DC	DMM	APMXS	OAL	LN	DN	RE	CA°	PCEDC	Cylindrical
				mm	mm	mm	mm	mm	mm	mm			
JMB563010G2B.0Z3-SIRA	03171307	2	G	1,0	6,0	1,0	50,0	4,0	0,95	0,5	11,15	3	■
JMB563012G2B.0Z3-SIRA	03171308	2	G	1,2	6,0	1,2	50,0	4,5	1,15	0,6	10,67	3	■
JMB563015G2B.0Z3-SIRA	03171309	2	G	1,5	6,0	1,5	50,0	5,0	1,45	0,75	10,07	3	■
JMB563020G2B.0Z3-SIRA	03171310	2	G	2,0	6,0	2,0	50,0	6,0	1,94	1,0	9,05	3	■
JMB563025G2B.0Z3-SIRA	03171311	2	G	2,5	6,0	2,5	60,0	7,5	2,4	1,25	7,71	3	■
JMB563030G2B.0Z3-SIRA	03171312	2	G	3,0	6,0	3,0	60,0	9,0	2,85	1,5	6,35	3	■
JMB563010G4B.0Z3-SIRA	03171316	4	G	1,0	6,0	1,0	50,0	7,0	0,95	0,5	9,06	3	■
JMB563012G4B.0Z3-SIRA	03171317	4	G	1,2	6,0	1,2	50,0	8,4	1,15	0,6	8,22	3	■
JMB563015G4B.0Z3-SIRA	03171318	4	G	1,5	6,0	1,5	50,0	10,5	1,45	0,75	7,07	3	■
JMB563020G4B.0Z3-SIRA	03171319	4	G	2,0	6,0	2,0	60,0	14,0	1,94	1,0	5,57	3	■
JMB563025G4B.0Z3-SIRA	03171320	4	G	2,5	6,0	2,5	60,0	17,5	2,4	1,25	4,38	3	■
JMB563030G4B.0Z3-SIRA	03171321	4	G	3,0	6,0	3,0	70,0	21,0	2,85	1,5	3,38	3	■

■ Stocked standard.

Universal

Steel and cast iron

Stainless steel and S-materials

Non ferrous

Hard

Plastic and CFRP

Graphite

X-Heads

Minimaster Plus

Minimaster

Cutting data – JMB563 Copy milling roughing

SMG		a _e /DC	a _p /DC	f _z						v _c
				1	1.2	1.5	2.0	2.5	3.0	
P1	M/E/A	0.0500	0.38	0.020	0.024	0.030	0.040	0.050	0.060	460 (410 – 500)
		0,0500	0,38	0,00080	0,00095	0,0012	0,0016	0,0020	0,0024	1500 (1400 – 1600)
P2	M/E/A	0.0500	0.38	0.020	0.024	0.030	0.040	0.050	0.060	445 (400 – 490)
		0,0500	0,38	0,00080	0,00095	0,0012	0,0016	0,0020	0,0024	1450 (1400 – 1600)
P3	M/E/A	0.0500	0.38	0.020	0.024	0.030	0.040	0.050	0.060	385 (350 – 420)
		0,0500	0,38	0,00080	0,00095	0,0012	0,0016	0,0020	0,0024	1275 (1200 – 1300)
P4	M/E/A	0.0500	0.38	0.020	0.024	0.030	0.040	0.050	0.060	340 (310 – 370)
		0,0500	0,38	0,00080	0,00095	0,0012	0,0016	0,0020	0,0024	1125 (1100 – 1200)
P5	M/E/A	0.0500	0.38	0.020	0.024	0.030	0.040	0.050	0.060	325 (290 – 350)
		0,0500	0,38	0,00080	0,00095	0,0012	0,0016	0,0020	0,0024	1075 (960 – 1100)
P6	M/E/A	0.0500	0.38	0.020	0.024	0.030	0.040	0.050	0.060	365 (330 – 400)
		0,0500	0,38	0,00080	0,00095	0,0012	0,0016	0,0020	0,0024	1200 (1100 – 1300)
P7	M/E/A	0.0500	0.38	0.020	0.024	0.030	0.040	0.050	0.060	340 (310 – 380)
		0,0500	0,38	0,00080	0,00095	0,0012	0,0016	0,0020	0,0024	1125 (1100 – 1200)
P8	M/E/A	0.0500	0.38	0.020	0.024	0.030	0.040	0.050	0.060	325 (290 – 350)
		0,0500	0,38	0,00080	0,00095	0,0012	0,0016	0,0020	0,0024	1075 (960 – 1100)
P11	M/E/A	0.0250	0.38	0.020	0.024	0.030	0.040	0.050	0.060	230 (190 – 270)
		0,0250	0,38	0,00080	0,00095	0,0012	0,0016	0,0020	0,0024	750 (630 – 880)
P12	M/E/A	0.0250	0.38	0.020	0.024	0.030	0.040	0.050	0.060	135 (120 – 160)
		0,0250	0,38	0,00080	0,00095	0,0012	0,0016	0,0020	0,0024	445 (400 – 520)
M1	E/M/A	0.0250	0.38	0.020	0.024	0.030	0.040	0.050	0.060	270 (230 – 320)
		0,0250	0,38	0,00080	0,00095	0,0012	0,0016	0,0020	0,0024	890 (760 – 1000)
M2	E/M/A	0.0250	0.38	0.020	0.024	0.030	0.040	0.050	0.060	220 (180 – 250)
		0,0250	0,38	0,00080	0,00095	0,0012	0,0016	0,0020	0,0024	720 (600 – 820)
M3	E/M/A	0.0250	0.38	0.020	0.024	0.030	0.040	0.050	0.060	220 (180 – 250)
		0,0250	0,38	0,00080	0,00095	0,0012	0,0016	0,0020	0,0024	720 (600 – 820)
M4	E/M/A	0.0250	0.38	0.020	0.024	0.030	0.040	0.050	0.060	165 (140 – 190)
		0,0250	0,38	0,00080	0,00095	0,0012	0,0016	0,0020	0,0024	540 (460 – 620)
M5	E/M/A	0.0250	0.38	0.020	0.024	0.030	0.040	0.050	0.060	135 (120 – 160)
		0,0250	0,38	0,00080	0,00095	0,0012	0,0016	0,0020	0,0024	445 (400 – 520)
N1	E/M/A	0.100	0.65	0.020	0.024	0.030	0.040	0.050	0.060	590 (520 – 660)
		0,100	0,65	0,00080	0,00095	0,0012	0,0016	0,0020	0,0024	1925 (1800 – 2100)
N2	E/M/A	0.100	0.65	0.020	0.024	0.030	0.040	0.050	0.060	590 (520 – 660)
		0,100	0,65	0,00080	0,00095	0,0012	0,0016	0,0020	0,0024	1925 (1800 – 2100)
N3	E/M/A	0.100	0.65	0.020	0.024	0.030	0.040	0.050	0.060	395 (350 – 440)
		0,100	0,65	0,00080	0,00095	0,0012	0,0016	0,0020	0,0024	1300 (1200 – 1400)
N11	E/M/A	0.100	0.65	0.025	0.030	0.038	0.050	0.060	0.075	520 (450 – 590)
		0,100	0,65	0,0010	0,0012	0,0015	0,0020	0,0024	0,0030	1700 (1500 – 1900)
S11	E/M/A	0.0250	0.46	0.020	0.024	0.030	0.040	0.050	0.060	345 (300 – 390)
		0,0250	0,46	0,00080	0,00095	0,0012	0,0016	0,0020	0,0024	1125 (990 – 1200)
S12	E/M/A	0.0250	0.46	0.020	0.024	0.030	0.040	0.050	0.060	265 (230 – 300)
		0,0250	0,46	0,00080	0,00095	0,0012	0,0016	0,0020	0,0024	870 (760 – 980)
S13	E/M/A	0.0250	0.46	0.020	0.024	0.030	0.040	0.050	0.060	205 (180 – 230)
		0,0250	0,46	0,00080	0,00095	0,0012	0,0016	0,0020	0,0024	670 (600 – 750)
H3	M/A	0.0250	0.095	0.018	0.022	0.026	0.036	0.044	0.055	155 (120 – 190)
		0,0250	0,095	0,00070	0,00085	0,0010	0,0014	0,0017	0,0022	510 (400 – 620)
H5	M/A	0.0500	0.22	0.020	0.024	0.030	0.040	0.050	0.060	295 (260 – 330)
		0,0500	0,22	0,00080	0,00095	0,0012	0,0016	0,0020	0,0024	970 (860 – 1000)
H7	M/A	0.0250	0.095	0.018	0.022	0.026	0.036	0.044	0.055	155 (120 – 190)
		0,0250	0,095	0,00070	0,00085	0,0010	0,0014	0,0017	0,0022	510 (400 – 620)
H8	M/A	0.0500	0.22	0.020	0.024	0.030	0.040	0.050	0.060	295 (260 – 330)
		0,0500	0,22	0,00080	0,00095	0,0012	0,0016	0,0020	0,0024	970 (860 – 1000)
H11	M/A	0.0500	0.22	0.020	0.024	0.030	0.040	0.050	0.060	375 (330 – 420)
		0,0500	0,22	0,00080	0,00095	0,0012	0,0016	0,0020	0,0024	1225 (1100 – 1300)
H12	M/A	0.0500	0.22	0.020	0.024	0.030	0.040	0.050	0.060	345 (310 – 380)
		0,0500	0,22	0,00080	0,00095	0,0012	0,0016	0,0020	0,0024	1125 (1100 – 1200)
H21	M/A	0.0500	0.22	0.020	0.024	0.030	0.040	0.050	0.060	295 (260 – 330)
		0,0500	0,22	0,00080	0,00095	0,0012	0,0016	0,0020	0,0024	970 (860 – 1000)
H31	M/A	0.0500	0.22	0.020	0.024	0.030	0.040	0.050	0.060	225 (200 – 250)
		0,0500	0,22	0,00080	0,00095	0,0012	0,0016	0,0020	0,0024	740 (660 – 820)
GR1	A	0.500	0.50	0.015	0.018	0.022	0.030	0.038	0.040	450 (390 – 510)
		0,500	0,50	0,00060	0,00070	0,00085	0,0012	0,0015	0,0016	1475 (1300 – 1600)

Table based on LV1, please recalc based on length version chosen. See page(s)

SMG = Seco material group
 Coolant = A=air D=dry E=emulsion M=mist spray
 v_c = m/min (sf/min)
 f_z = mm (in/tooth)
 a_p = mm/DC (in/DC) = factor
 a_e = mm/DC (in/DC) = factor
 All cutting data are target values

Universal
Steel and cast iron
Stainless steel and S-materials
Non ferrous
Hard
Plastic and CFRP
Graphite
X-Heads
Minimaster Plus
Minimaster

Universal
Steel and cast iron
Stainless steel and S-materials
Non ferrous
Hard
Plastic and cfrp
Graphite
X-Heads
Minimaster Plus
Minimaster



STEEL AND CAST IRON

Seco offers a complete range of high performance solid carbide square shoulder end mills, ballnose cutters and finish end mills for high productivity in steel and cast iron.

- JHP993, JHP951 and JH142 for chamfer or radius type.
- JHB970, JH112, JH150, JH160 for ball-nose type.

Tool selection Steel and cast iron









					
Name		JHP993	JHP951	JH142	JHB970
Page(s)		185	191	195, 382	137, 198
Family name		HPM	HPM	HSM/TORNADO	HSM/TORNADO
Type of mill					
Shank	Cylindrical	■	■	■	■
	Weldon	■	■		
Number of Flutes		3,4,5	3,4,5	2-4-5-6	2
ICC					
Diameter range	Metric	4-25	3-20	2-12	2-16
	Inch				
Length availability		2,3	2	2,3,6	1,2,3
Operation					
					
					
SMG					
P1		●	●	●	●
P2		●	●	●	●
P3		●	●	●	●
P4		●	●	●	●
P5		●	●	●	●
P6		●	●	●	●
P7		●	●	●	●
P8		●	●	●	●
P11-12		○	○	●	○
K1		●	●	●	●
K2		●	●	●	●
K3		●	●	●	●
K4		●	●	●	●
K5		●	●	●	●
K6		●	●	●	●
K7		●	●	●	●

■ Stock standard □ Weldon available, delivery time is 3 days.
● Preferred choice ○ Alternative choice

Universal
Steel and cast iron
Stainless steel and S-materials
Non ferrous
Hard
Plastic and cfrp
Graphite
X-Heads
Minimaster Plus
Minimaster

Universal
 Steel and cast iron
 Stainless steel and S-materials
 Non ferrous
 Hard
 Plastic and cfrp
 Graphite
 X-Heads
 Minimaster Plus
 Minimaster

Tool selection Steel and cast iron

				
Name		JH112	JH150	JH160
Page(s)		200, 385	388	390
Family name		HSM/TORNADO	HSM/TORNADO	HSM/TORNADO
Type of mill				
Shank	Cylindrical	■	■	■
	Weldon			
Number of Flutes		2	4	4
ICC				
Diameter range	Metric	2-12	6-12	3-12
	Inch			
Length availability		1,2,3,4,5,6	2	2
Operation				
				
SMG				
P1				●
P2				●
P3				●
P4				●
P5				●
P6				●
P7				●
P8				●
P11-12				○
K1		●	●	
K2		●	●	
K3		●	●	
K4		●	●	
K5		●	●	
K6		●	●	
K7		●	●	

■ Stock standard □ Weldon available, delivery time is 3 days.
 ● Preferred choice ○ Alternative choice

JHP993

High performance – Steel – Square – 3-5 Flutes – Cylindrical – Chamfer

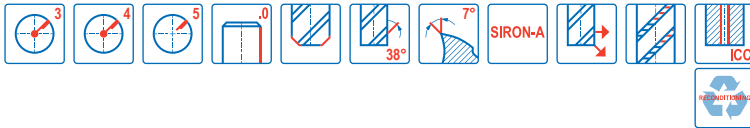
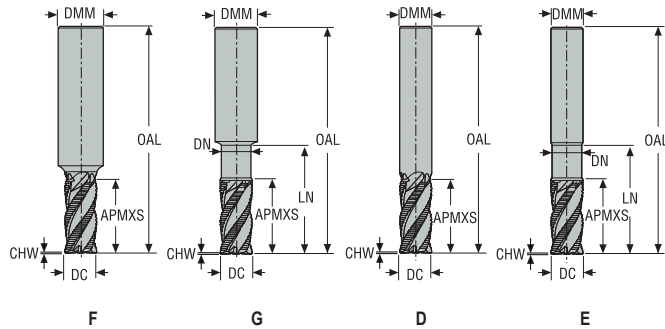

- Tolerances:
- DMM=h5
- DC=-0,02/-0,1 mm
- CHW= ±0,05 mm
- Regrind possible if DC is ≥Ø6

Designation	Item number	Length index	Tool shape	ICC	DC	DMM	APMXS	OAL	LN	DN	CHW	PCEDC	Cylindrical
					mm	mm	mm	mm	mm	mm	mm	mm	
JHP993040F2C.0Z3-SIRA	02826806	2	F	-	4,0	6,0	10,0	50,0	12,56	4,0	0,15	3	■
JHP993050F2C.0Z4-SIRA	02826808	2	F	-	5,0	6,0	12,0	55,0	14,75	5,0	0,15	4	■
JHP993060D2C.0Z4-SIRA	02826809	2	D	-	6,0	6,0	14,0	55,0	-	-	0,2	4	■
JHP993075F2C.0Z4-SIRA	02826811	2	F	-	7,5	8,0	17,0	60,0	20,0	7,5	0,2	4	■
JHP993080D2C.0Z4A-SIRA	02826814	2	D	■	8,0	8,0	18,0	60,0	-	-	0,2	4	■
JHP993080D2C.0Z4-SIRA	02826812	2	D	-	8,0	8,0	18,0	60,0	-	-	0,2	4	■
JHP993095F2C.0Z4-SIRA	02826816	2	F	-	9,5	10,0	20,0	70,0	23,0	9,5	0,2	4	■
JHP993100D2C.0Z4A-SIRA	02826818	2	D	■	10,0	10,0	22,0	70,0	-	-	0,2	4	■
JHP993100D2C.0Z4-SIRA	02826817	2	D	-	10,0	10,0	22,0	70,0	-	-	0,2	4	■
JHP993115F2C.0Z4-SIRA	02826820	2	F	-	11,5	12,0	25,0	80,0	28,0	11,5	0,2	4	■
JHP993120D2C.0Z4A-SIRA	02826822	2	D	■	12,0	12,0	26,0	80,0	-	-	0,2	4	■
JHP993120D2C.0Z4-SIRA	02826821	2	D	-	12,0	12,0	26,0	80,0	-	-	0,2	4	■
JHP993140D2C.0Z4-SIRA	02826824	2	D	-	14,0	14,0	30,0	80,0	-	-	0,3	4	■
JHP993160D2C.0Z4A-SIRA	02856501	2	D	■	16,0	16,0	34,0	90,0	-	-	0,3	4	■
JHP993160D2C.0Z4-SIRA	02856499	2	D	-	16,0	16,0	34,0	90,0	-	-	0,3	4	■
JHP993160D2C.0Z5-SIRA	02826825	2	D	-	16,0	16,0	34,0	90,0	-	-	0,3	5	■
JHP993200D2C.0Z4A-SIRA	02856506	2	D	■	20,0	20,0	42,0	100,0	-	-	0,5	4	■
JHP993200D2C.0Z4-SIRA	02856505	2	D	-	20,0	20,0	42,0	100,0	-	-	0,5	4	■
JHP993200D2C.0Z5-SIRA	02826828	2	D	-	20,0	20,0	42,0	100,0	-	-	0,5	5	■
JHP993250D2C.0Z4A-SIRA	02856510	2	D	■	25,0	25,0	52,0	125,0	-	-	0,5	4	■
JHP993040G3C.0Z3-SIRA	02826807	3	G	-	4,0	6,0	10,0	55,0	15,0	3,7	0,15	3	■
JHP993060E3C.0Z4-SIRA	02826810	3	E	-	6,0	6,0	14,0	65,0	24,0	5,6	0,2	4	■
JHP993080E3C.0Z4-SIRA	02826815	3	E	-	8,0	8,0	18,0	70,0	32,0	7,4	0,2	4	■
JHP993100E3C.0Z4-SIRA	02826819	3	E	-	10,0	10,0	22,0	85,0	40,0	9,4	0,2	4	■
JHP993120E3C.0Z4-SIRA	02826823	3	E	-	12,0	12,0	26,0	100,0	50,0	11,4	0,2	4	■
JHP993160E3C.0Z4-SIRA	02856502	3	E	-	16,0	16,0	34,0	110,0	60,0	15,4	0,3	4	■
JHP993200E3C.0Z4-SIRA	02856507	3	E	-	20,0	20,0	42,0	125,0	70,0	19,2	0,5	4	■

■ Stocked standard.

Universal

Steel and cast iron

Stainless steel and S-materials

Non ferrous

Hard

Plastic and cfrp

Graphite

X-Heads

Minimaster Plus

Minimaster

JHP993

High performance – Steel – Square – 3-5 Flutes – Weldon – Chamfer

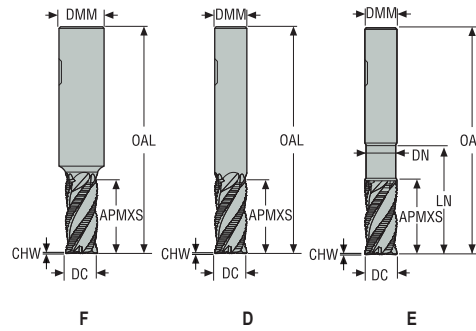

- Tolerances:
- DMM=h5
- DC=-0,02/-0,1 mm
- CHW= ±0,05 mm
- Regrind possible if DC is ≥06

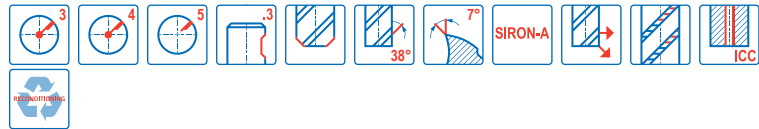

Designation	Item number	Length index	Tool shape	ICC	DC	DMM	APMXS	OAL	LN	DN	CHW	PCEDC	Weldon
					mm	mm	mm	mm	mm	mm	mm		
JHP993040F2C.3Z3-SIRA	02828150	2	F	-	4,0	6,0	10,0	50,0	12,56	4,0	0,15	3	■
JHP993050F2C.3Z4-SIRA	02828152	2	F	-	5,0	6,0	12,0	55,0	14,75	5,0	0,15	4	■
JHP993060D2C.3Z4-SIRA	02828153	2	D	-	6,0	6,0	14,0	55,0	-	-	0,2	4	■
JHP993075F2C.3Z4-SIRA	02828155	2	F	-	7,5	8,0	17,0	60,0	20,0	7,5	0,2	4	■
JHP993080D2C.3Z4-SIRA	02828246	2	D	■	8,0	8,0	16,0	60,0	-	-	0,2	4	□
JHP993080D2C.3Z4-SIRA	02828156	2	D	-	8,0	8,0	18,0	60,0	-	-	0,2	4	■
JHP993095F2C.3Z4-SIRA	02828158	2	F	-	9,5	10,0	20,0	70,0	23,0	9,5	0,2	4	■
JHP993100D2C.3Z4-SIRA	02828247	2	D	■	10,0	10,0	22,0	70,0	-	-	0,2	4	□
JHP993100D2C.3Z4-SIRA	02828159	2	D	-	10,0	10,0	22,0	70,0	-	-	0,2	4	■
JHP993120D2C.3Z4-SIRA	02828248	2	D	■	12,0	12,0	26,0	80,0	-	-	0,2	4	□
JHP993120D2C.3Z4-SIRA	02828162	2	D	-	12,0	12,0	26,0	80,0	-	-	0,2	4	■
JHP993140D2C.3Z4-SIRA	02828164	2	D	-	14,0	14,0	30,0	80,0	-	-	0,3	4	■
JHP993160D2C.3Z4-SIRA	02856512	2	D	■	16,0	16,0	34,0	90,0	-	-	0,3	4	□
JHP993160D2C.3Z4-SIRA	02856500	2	D	-	16,0	16,0	34,0	90,0	-	-	0,3	4	■
JHP993160D2C.3Z5-SIRA	02828165	2	D	-	16,0	16,0	34,0	90,0	-	-	0,3	5	■
JHP993200D2C.3Z4-SIRA	02856513	2	D	■	20,0	20,0	42,0	100,0	-	-	0,5	4	■
JHP993200D2C.3Z4-SIRA	02856504	2	D	-	20,0	20,0	42,0	100,0	-	-	0,5	4	■
JHP993200D2C.3Z5-SIRA	02828167	2	D	-	20,0	20,0	42,0	100,0	-	-	0,5	5	■
JHP993250D2C.3Z4-SIRA	02856514	2	D	■	25,0	25,0	52,0	125,0	-	-	0,5	4	□
JHP993250D2C.3Z4-SIRA	02856509	2	D	-	25,0	25,0	52,0	125,0	-	-	0,5	4	■
JHP993060E3C.3Z4-SIRA	02828154	3	E	-	6,0	6,0	14,0	65,0	24,0	5,6	0,2	4	■
JHP993080E3C.3Z4-SIRA	02828157	3	E	-	8,0	8,0	18,0	70,0	32,0	7,4	0,2	4	■
JHP993100E3C.3Z4-SIRA	02828160	3	E	-	10,0	10,0	22,0	85,0	40,0	9,4	0,2	4	■
JHP993120E3C.3Z4-SIRA	02828163	3	E	-	12,0	12,0	26,0	100,0	50,0	11,4	0,2	4	■
JHP993160E3C.3Z4-SIRA	02856503	3	E	-	16,0	16,0	34,0	110,0	60,0	15,4	0,3	4	■
JHP993200E3C.3Z4-SIRA	02856508	3	E	-	20,0	20,0	42,0	125,0	70,0	19,2	0,5	4	■
JHP993200E3C.3Z5-SIRA	02828168	3	E	-	20,0	20,0	42,0	125,0	70,0	19,2	0,5	5	■
JHP993250E3C.3Z4-SIRA	02856511	3	E	-	25,0	25,0	52,0	150,0	90,0	24,0	0,5	4	■

■ Stocked standard. □ Weldon available. Delivery time is 3 days.

Universal
Steel and cast iron
Stainless steel and S-materials
Non ferrous
Hard
Plastic and CFRP
Graphite
X-Heads
Minimaster Plus
Minimaster

Cutting data – JHP993 Side milling PCEDC=3 and PCEDC=4

SMG		a _e /DC	a _p /DC	f _z										v _c
				4	5	6	8	10	12	14	16	20	25	
P1	E/M/A	0.400	1.7	0.044	0.055	0.065	0.090	0.11	0.13	0.15	0.16	0.19	0.22	230 (200 – 260)
		0,400	1,7	0,0017	0,0022	0,0026	0,0036	0,0044	0,0050	0,0060	0,0065	0,0075	0,0085	750 (660 – 850)
P2	E/M/A	0.400	1.7	0.044	0.055	0.065	0.090	0.11	0.13	0.15	0.17	0.19	0.22	225 (200 – 250)
		0,400	1,7	0,0017	0,0022	0,0026	0,0036	0,0044	0,0050	0,0060	0,0065	0,0075	0,0085	740 (660 – 820)
P3	E/M/A	0.400	1.7	0.042	0.055	0.065	0.085	0.11	0.13	0.14	0.16	0.18	0.20	195 (170 – 220)
		0,400	1,7	0,0017	0,0022	0,0026	0,0034	0,0044	0,0050	0,0055	0,0065	0,0070	0,0080	640 (560 – 720)
P4	E/M/A	0.400	1.7	0.042	0.050	0.060	0.085	0.10	0.12	0.14	0.15	0.18	0.20	175 (150 – 190)
		0,400	1,7	0,0017	0,0020	0,0024	0,0034	0,0040	0,0048	0,0055	0,0060	0,0070	0,0080	570 (500 – 620)
P5	E/M/A	0.400	1.7	0.040	0.050	0.060	0.080	0.10	0.12	0.14	0.15	0.17	0.20	165 (150 – 190)
		0,400	1,7	0,0016	0,0020	0,0024	0,0032	0,0040	0,0048	0,0055	0,0060	0,0065	0,0080	540 (500 – 620)
P6	E/M/A	0.400	1.7	0.040	0.050	0.060	0.080	0.10	0.12	0.14	0.15	0.17	0.19	185 (160 – 210)
		0,400	1,7	0,0016	0,0020	0,0024	0,0032	0,0040	0,0048	0,0055	0,0060	0,0065	0,0075	610 (530 – 680)
P7	E/M/A	0.400	1.7	0.040	0.050	0.060	0.080	0.10	0.12	0.14	0.15	0.17	0.19	175 (160 – 200)
		0,400	1,7	0,0016	0,0020	0,0024	0,0032	0,0040	0,0048	0,0055	0,0060	0,0065	0,0075	570 (530 – 650)
P8	E/M/A	0.400	1.7	0.042	0.055	0.065	0.085	0.11	0.13	0.14	0.16	0.18	0.20	160 (140 – 180)
		0,400	1,7	0,0017	0,0022	0,0026	0,0034	0,0044	0,0050	0,0055	0,0065	0,0070	0,0080	520 (460 – 590)
P11	E/M/A	0.400	1.7	0.040	0.050	0.060	0.080	0.10	0.12	0.14	0.15	0.17	0.19	170 (150 – 190)
		0,400	1,7	0,0016	0,0020	0,0024	0,0032	0,0040	0,0048	0,0055	0,0060	0,0065	0,0075	560 (500 – 620)
P12	E/M/A	0.400	1.7	0.028	0.034	0.042	0.055	0.070	0.080	0.095	0.10	0.12	0.13	110 (95 – 120)
		0,400	1,7	0,0011	0,0013	0,0017	0,0022	0,0028	0,0032	0,0038	0,0040	0,0048	0,0050	360 (320 – 390)
K1	E/M/A	0.400	1.7	0.044	0.055	0.065	0.090	0.11	0.13	0.15	0.17	0.19	0.22	225 (200 – 250)
		0,400	1,7	0,0017	0,0022	0,0026	0,0036	0,0044	0,0050	0,0060	0,0065	0,0075	0,0085	740 (660 – 820)
K2	E/M/A	0.400	1.7	0.040	0.050	0.060	0.080	0.10	0.12	0.14	0.15	0.17	0.20	200 (180 – 220)
		0,400	1,7	0,0016	0,0020	0,0024	0,0032	0,0040	0,0048	0,0055	0,0060	0,0065	0,0080	660 (600 – 720)
K3	E/M/A	0.400	1.7	0.040	0.050	0.060	0.080	0.10	0.12	0.14	0.15	0.17	0.20	170 (150 – 190)
		0,400	1,7	0,0016	0,0020	0,0024	0,0032	0,0040	0,0048	0,0055	0,0060	0,0065	0,0080	560 (500 – 620)
K4	E/M/A	0.400	1.7	0.040	0.050	0.060	0.080	0.10	0.12	0.14	0.15	0.17	0.20	160 (140 – 180)
		0,400	1,7	0,0016	0,0020	0,0024	0,0032	0,0040	0,0048	0,0055	0,0060	0,0065	0,0080	520 (460 – 590)
K5	E/M/A	0.400	1.7	0.036	0.046	0.055	0.075	0.090	0.11	0.12	0.14	0.16	0.18	100 (86 – 110)
		0,400	1,7	0,0014	0,0018	0,0022	0,0030	0,0036	0,0044	0,0048	0,0055	0,0065	0,0070	330 (290 – 360)
K6	E/M/A	0.400	1.7	0.040	0.050	0.060	0.080	0.10	0.12	0.14	0.15	0.17	0.20	145 (130 – 160)
		0,400	1,7	0,0016	0,0020	0,0024	0,0032	0,0040	0,0048	0,0055	0,0060	0,0065	0,0080	475 (430 – 520)
K7	E/M/A	0.400	1.7	0.036	0.046	0.055	0.075	0.090	0.11	0.12	0.14	0.16	0.18	125 (110 – 140)
		0,400	1,7	0,0014	0,0018	0,0022	0,0030	0,0036	0,0044	0,0048	0,0055	0,0065	0,0070	410 (370 – 450)

For cutting data recalculations, see pages 556 - 563

SMG = Seco material group
 Coolant = A=air D=dry E=emulsion M=mist spray
 v_c= m/min (sf/min)
 f_z = mm (in/tooth)
 a_p = mm/DC (in/DC) = factor
 a_e = mm/DC (in/DC) = factor
 All cutting data are target values

Universal
 Steel and cast iron
 Stainless steel and S-materials
 Non ferrous
 Hard
 Plastic and CFRP
 Graphite
 X-Heads
 Minmaster Plus
 Minmaster

Cutting data – JHP993 Side milling PCEDC=5 and PCEDC=6

SMG		a _e /DC	a _p /DC	f _z		v _c
				16	20	
P1	E/M/A	0,376	1,0	0,17	0,22	205 (180 – 230)
		0,376	1,0	0,0065	0,0085	670 (600 – 750)
P2	E/M/A	0,376	1,0	0,18	0,22	195 (170 – 220)
		0,376	1,0	0,0070	0,0085	640 (560 – 720)
P3	E/M/A	0,376	1,0	0,17	0,20	170 (150 – 190)
		0,376	1,0	0,0065	0,0080	560 (500 – 620)
P4	E/M/A	0,376	1,0	0,16	0,20	155 (140 – 170)
		0,376	1,0	0,0065	0,0080	510 (460 – 550)
P5	E/M/A	0,376	1,0	0,16	0,20	145 (130 – 160)
		0,376	1,0	0,0065	0,0080	475 (430 – 520)
P6	E/M/A	0,376	1,0	0,16	0,20	165 (150 – 180)
		0,376	1,0	0,0065	0,0080	540 (500 – 590)
P7	E/M/A	0,376	1,0	0,16	0,20	155 (140 – 170)
		0,376	1,0	0,0065	0,0080	510 (460 – 550)
P8	E/M/A	0,376	1,0	0,17	0,20	145 (130 – 160)
		0,376	1,0	0,0065	0,0080	475 (430 – 520)
P11	E/M/A	0,376	1,0	0,16	0,20	150 (130 – 170)
		0,376	1,0	0,0065	0,0080	490 (430 – 550)
P12	E/M/A	0,376	1,0	0,11	0,13	100 (85 – 110)
		0,376	1,0	0,0044	0,0050	330 (280 – 360)
K1	E/M/A	0,376	1,0	0,18	0,22	195 (170 – 220)
		0,376	1,0	0,0070	0,0085	640 (560 – 720)
K2	E/M/A	0,376	1,0	0,16	0,20	175 (160 – 200)
		0,376	1,0	0,0065	0,0080	570 (530 – 650)
K3	E/M/A	0,376	1,0	0,16	0,20	150 (130 – 170)
		0,376	1,0	0,0065	0,0080	490 (430 – 550)
K4	E/M/A	0,376	1,0	0,16	0,20	145 (130 – 160)
		0,376	1,0	0,0065	0,0080	475 (430 – 520)
K5	E/M/A	0,376	1,0	0,15	0,18	85 (75 – 99)
		0,376	1,0	0,0060	0,0070	280 (250 – 320)
K6	E/M/A	0,376	1,0	0,16	0,20	125 (110 – 140)
		0,376	1,0	0,0065	0,0080	410 (370 – 450)
K7	E/M/A	0,376	1,0	0,15	0,18	110 (96 – 120)
		0,376	1,0	0,0060	0,0070	360 (320 – 390)

For cutting data recalculations, see pages 556 - 563

SMG = Seco material group
Coolant = A=air D=dry E=emulsion M=mist spray
v_c = m/min (sf/min)
f_z = mm (in/tooth)
a_p = mm/DC (in/DC) = factor
a_e = mm/DC (in/DC) = factor
All cutting data are target values

Cutting data – JHP993 Slot milling PCEDC=3 and PCEDC=4

SMG		a _p /DC	f _z										v _c
			4	5	6	8	10	12	14	16	20	25	
P1	E/M/A	1.5	0.032	0.040	0.048	0.065	0.080	0.095	0.11	0.13	0.16	0.20	200 (180 – 220)
		1.5	0,0013	0,0016	0,0019	0,0026	0,0032	0,0038	0,0044	0,0050	0,0065	0,0080	660 (600 – 720)
P2	E/M/A	1.5	0.032	0.040	0.048	0.065	0.080	0.095	0.11	0.13	0.16	0.20	195 (170 – 220)
		1.5	0,0013	0,0016	0,0019	0,0026	0,0032	0,0038	0,0044	0,0050	0,0065	0,0080	640 (560 – 720)
P3	E/M/A	1.5	0.032	0.040	0.048	0.065	0.080	0.095	0.11	0.13	0.16	0.20	165 (150 – 190)
		1.5	0,0013	0,0016	0,0019	0,0026	0,0032	0,0038	0,0044	0,0050	0,0065	0,0080	540 (500 – 620)
P4	E/M/A	1.5	0.032	0.040	0.048	0.065	0.080	0.095	0.11	0.13	0.16	0.20	145 (130 – 160)
		1.5	0,0013	0,0016	0,0019	0,0026	0,0032	0,0038	0,0044	0,0050	0,0065	0,0080	475 (430 – 520)
P5	E/M/A	1.5	0.032	0.040	0.048	0.065	0.080	0.095	0.11	0.13	0.16	0.19	140 (130 – 160)
		1.5	0,0013	0,0016	0,0019	0,0026	0,0032	0,0038	0,0044	0,0050	0,0065	0,0075	460 (430 – 520)
P6	E/M/A	1.5	0.032	0.040	0.048	0.065	0.080	0.095	0.11	0.13	0.16	0.19	155 (140 – 170)
		1.5	0,0013	0,0016	0,0019	0,0026	0,0032	0,0038	0,0044	0,0050	0,0065	0,0075	510 (460 – 550)
P7	E/M/A	1.5	0.032	0.040	0.048	0.065	0.080	0.095	0.11	0.13	0.16	0.19	150 (130 – 160)
		1.5	0,0013	0,0016	0,0019	0,0026	0,0032	0,0038	0,0044	0,0050	0,0065	0,0075	490 (430 – 520)
P8	E/M/A	1.5	0.032	0.040	0.048	0.065	0.080	0.095	0.11	0.13	0.16	0.20	140 (130 – 160)
		1.5	0,0013	0,0016	0,0019	0,0026	0,0032	0,0038	0,0044	0,0050	0,0065	0,0080	460 (430 – 520)
P11	E/M/A	1.5	0.032	0.040	0.048	0.065	0.080	0.095	0.11	0.13	0.16	0.19	145 (130 – 160)
		1.5	0,0013	0,0016	0,0019	0,0026	0,0032	0,0038	0,0044	0,0050	0,0065	0,0075	475 (430 – 520)
P12	E/M/A	1.5	0.028	0.034	0.040	0.055	0.070	0.080	0.090	0.10	0.12	0.13	90 (76 – 100)
		1.5	0,0011	0,0013	0,0016	0,0022	0,0028	0,0032	0,0036	0,0040	0,0048	0,0050	295 (250 – 320)
K1	E/M/A	1.5	0.032	0.040	0.048	0.065	0.080	0.095	0.11	0.13	0.16	0.20	195 (170 – 220)
		1.5	0,0013	0,0016	0,0019	0,0026	0,0032	0,0038	0,0044	0,0050	0,0065	0,0080	640 (560 – 720)
K2	E/M/A	1.5	0.032	0.040	0.048	0.065	0.080	0.095	0.11	0.13	0.16	0.19	170 (150 – 190)
		1.5	0,0013	0,0016	0,0019	0,0026	0,0032	0,0038	0,0044	0,0050	0,0065	0,0075	560 (500 – 620)
K3	E/M/A	1.5	0.032	0.040	0.048	0.065	0.080	0.095	0.11	0.13	0.16	0.19	145 (130 – 160)
		1.5	0,0013	0,0016	0,0019	0,0026	0,0032	0,0038	0,0044	0,0050	0,0065	0,0075	475 (430 – 520)
K4	E/M/A	1.5	0.032	0.040	0.048	0.065	0.080	0.095	0.11	0.13	0.16	0.19	135 (120 – 150)
		1.5	0,0013	0,0016	0,0019	0,0026	0,0032	0,0038	0,0044	0,0050	0,0065	0,0075	445 (400 – 490)
K5	E/M/A	1.5	0.032	0.040	0.048	0.065	0.080	0.095	0.11	0.13	0.15	0.17	80 (70 – 93)
		1.5	0,0013	0,0016	0,0019	0,0026	0,0032	0,0038	0,0044	0,0050	0,0060	0,0065	260 (230 – 300)
K6	E/M/A	1.5	0.032	0.040	0.048	0.065	0.080	0.095	0.11	0.13	0.16	0.19	120 (110 – 130)
		1.5	0,0013	0,0016	0,0019	0,0026	0,0032	0,0038	0,0044	0,0050	0,0065	0,0075	395 (370 – 420)
K7	E/M/A	1.5	0.032	0.040	0.048	0.065	0.080	0.095	0.11	0.13	0.15	0.17	105 (90 – 110)
		1.5	0,0013	0,0016	0,0019	0,0026	0,0032	0,0038	0,0044	0,0050	0,0060	0,0065	345 (300 – 360)

For cutting data recalculations, see pages 556 - 563

SMG = Seco material group
 Coolant = A=air D=dry E=emulsion M=mist spray
 v_c= m/min (sf/min)
 f_z = mm (in/tooth)
 a_p = mm/DC (in/DC) = factor
 a_e = mm/DC (in/DC) = factor
 All cutting data are target values

Universal
 Steel and cast iron
 Stainless steel and S-materials
 Non ferrous
 Hard
 Plastic and CFRP
 Graphite
 X-Heads
 Minmaster Plus
 Minmaster

Cutting data – JHP993 Slot milling PCEDC=5 and PCEDC=6

SMG		a _p /DC	f _z		v _c
			16	20	
P1	E/M/A	0.44	0.17	0.20	160 (140 – 180)
		0.44	0.0065	0.0080	520 (460 – 590)
P2	E/M/A	0.44	0.17	0.22	155 (140 – 170)
		0.44	0.0065	0.0085	510 (460 – 550)
P3	E/M/A	0.44	0.16	0.20	135 (120 – 150)
		0.44	0.0065	0.0080	445 (400 – 490)
P4	E/M/A	0.44	0.16	0.20	120 (110 – 130)
		0.44	0.0065	0.0080	395 (370 – 420)
P5	E/M/A	0.44	0.16	0.19	115 (99 – 130)
		0.44	0.0065	0.0075	375 (330 – 420)
P6	E/M/A	0.44	0.16	0.19	130 (120 – 140)
		0.44	0.0065	0.0075	425 (400 – 450)
P7	E/M/A	0.44	0.16	0.19	120 (110 – 130)
		0.44	0.0065	0.0075	395 (370 – 420)
P8	E/M/A	0.44	0.16	0.20	115 (99 – 130)
		0.44	0.0065	0.0080	375 (330 – 420)
P11	E/M/A	0.44	0.16	0.19	120 (110 – 130)
		0.44	0.0065	0.0075	395 (370 – 420)
P12	E/M/A	0.44	0.11	0.13	80 (68 – 89)
		0.44	0.0044	0.0050	260 (230 – 290)
K1	E/M/A	0.44	0.17	0.22	160 (140 – 180)
		0.44	0.0065	0.0085	520 (460 – 590)
K2	E/M/A	0.44	0.16	0.19	140 (120 – 150)
		0.44	0.0065	0.0075	460 (400 – 490)
K3	E/M/A	0.44	0.16	0.19	120 (110 – 130)
		0.44	0.0065	0.0075	395 (370 – 420)
K4	E/M/A	0.44	0.16	0.19	115 (97 – 120)
		0.44	0.0065	0.0075	375 (320 – 390)
K5	E/M/A	0.44	0.14	0.17	70 (60 – 79)
		0.44	0.0055	0.0065	230 (200 – 250)
K6	E/M/A	0.44	0.16	0.19	100 (86 – 110)
		0.44	0.0065	0.0075	330 (290 – 360)
K7	E/M/A	0.44	0.14	0.17	90 (77 – 100)
		0.44	0.0055	0.0065	295 (260 – 320)

For cutting data recalculations, see pages 556 - 563

SMG = Seco material group
Coolant = A=air D=dry E=emulsion M=mist spray
v_c = m/min (sf/min)
f_z = mm (in/tooth)
a_p = mm/DC (in/DC) = factor
a_b = mm/DC (in/DC) = factor
All cutting data are target values

JHP951

High performance – Square – Steel – 3-5 Flutes – Cylindrical – Corner radius or chamfer

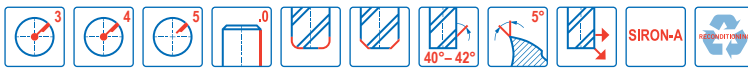
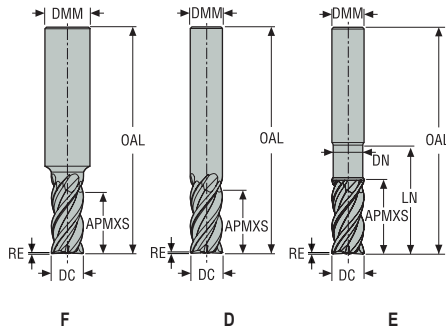

- Tolerances:
- DMM=h5
- DC=e7
- RE= ±0,02 mm
- Regrind possible if DC is ≥Ø6

Designation	Item number	Length index	Tool shape	DC	DMM	APMXS	OAL	LN	DN	CHW	RE	PCEDC	Cylindrical
				mm	mm	mm	mm	mm	mm	mm	mm		
JHP951030F2C.0Z3-SIRA	02828192	2	F	3,0	6,0	8,0	50,0	10,25	3,0	0,1	-	3	■
JHP951030F2R020.0Z3-SIRA	02828191	2	F	3,0	6,0	8,0	50,0	10,25	3,0	-	0,2	3	■
JHP951030F2R050.0Z3-SIRA	02828190	2	F	3,0	6,0	8,0	50,0	10,25	3,0	-	0,5	3	■
JHP951040F2C.0Z4-SIRA	02828197	2	F	4,0	6,0	10,0	55,0	13,25	4,0	0,15	-	4	■
JHP951040F2R020.0Z4-SIRA	02828194	2	F	4,0	6,0	10,0	55,0	13,25	4,0	-	0,2	4	■
JHP951040F2R050.0Z4-SIRA	02828195	2	F	4,0	6,0	10,0	55,0	13,25	4,0	-	0,5	4	■
JHP951050F2C.0Z4-SIRA	02828201	2	F	5,0	6,0	12,0	55,0	15,25	5,0	0,2	-	4	■
JHP951050F2R020.0Z4-SIRA	02828199	2	F	5,0	6,0	12,0	55,0	15,25	5,0	-	0,2	4	■
JHP951050F2R050.0Z4-SIRA	02828198	2	F	5,0	6,0	12,0	55,0	15,25	5,0	-	0,5	4	■
JHP951060D2C.0Z4-SIRA	02828205	2	D	6,0	6,0	14,0	55,0	-	-	0,2	-	4	■
JHP951060D2R020.0Z4-SIRA	02828203	2	D	6,0	6,0	14,0	55,0	-	-	-	0,2	4	■
JHP951060D2R050.0Z4-SIRA	02828202	2	D	6,0	6,0	14,0	55,0	-	-	-	0,5	4	■
JHP951080D2C.0Z4-SIRA	02828212	2	D	8,0	8,0	18,0	60,0	-	-	0,3	-	4	■
JHP951080D2R020.0Z4-SIRA	02828209	2	D	8,0	8,0	18,0	60,0	-	-	-	0,2	4	■
JHP951080D2R050.0Z4-SIRA	02828207	2	D	8,0	8,0	18,0	60,0	-	-	-	0,5	4	■
JHP951080D2R100.0Z4-SIRA	02828208	2	D	8,0	8,0	18,0	60,0	-	-	-	1,0	4	■
JHP951100E2C.0Z4-SIRA	02828218	2	E	10,0	10,0	22,0	70,0	28,0	9,4	0,3	-	4	■
JHP951100E2R050.0Z4-SIRA	02828216	2	E	10,0	10,0	22,0	70,0	28,0	9,4	-	0,5	4	■
JHP951100E2R100.0Z4-SIRA	02828214	2	E	10,0	10,0	22,0	70,0	28,0	9,4	-	1,0	4	■
JHP951120E2C.0Z4-SIRA	02828226	2	E	12,0	12,0	26,0	80,0	33,0	11,4	0,4	-	4	■
JHP951120E2R050.0Z4-SIRA	02828224	2	E	12,0	12,0	26,0	80,0	33,0	11,4	-	0,5	4	■
JHP951120E2R100.0Z4-SIRA	02828222	2	E	12,0	12,0	26,0	80,0	33,0	11,4	-	1,0	4	■
JHP951160E2C.0Z4-SIRA	02927873	2	E	16,0	16,0	34,0	90,0	40,0	15,0	0,5	-	4	■
JHP951160E2C.0Z5-SIRA	02828232	2	E	16,0	16,0	34,0	90,0	40,0	15,4	0,5	-	5	■
JHP951160E2R050.0Z4-SIRA	02927875	2	E	16,0	16,0	34,0	90,0	40,0	15,0	-	0,5	4	■
JHP951160E2R050.0Z5-SIRA	02828230	2	E	16,0	16,0	34,0	90,0	40,0	15,4	-	0,5	5	■
JHP951160E2R100.0Z4-SIRA	02927876	2	E	16,0	16,0	34,0	90,0	40,0	15,0	-	1,0	4	■
JHP951160E2R100.0Z5-SIRA	02828231	2	E	16,0	16,0	34,0	90,0	40,0	15,4	-	1,0	5	■

■ Stocked standard.

Universal

Steel and cast iron

Stainless steel and S-materials

Non ferrous

Hard

Plastic and CFRP

Graphite

X-Heads

Minimaster Plus

Minimaster

JHP951

High performance – Square – Steel – 3-5 Flutes – Weldon – Corner radius or chamfer

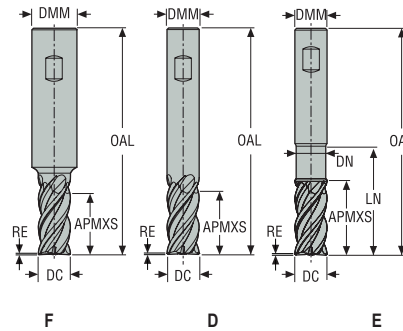

- Tolerances:
- DMM=h5
- DC=e7
- RE= ±0,02 mm
- Regrind possible if DC is ≥Ø6



Designation	Item number	Length index	Tool shape	DC	DMM	APMXS	OAL	LN	DN	CHW	RE	PCEDC	Weldon
				mm	mm	mm	mm	mm	mm	mm	mm		
JHP951030F2C.3Z3-SIRA	02828193	2	F	3,0	6,0	8,0	50,0	10,25	3,0	0,1	–	3	■
JHP951030F2R020.3Z3-SIRA	02828260	2	F	3,0	6,0	8,0	50,0	10,25	3,0	–	0,2	3	■
JHP951030F2R050.3Z3-SIRA	02828259	2	F	3,0	6,0	8,0	50,0	10,25	3,0	–	0,5	3	□
JHP951040F2C.3Z4-SIRA	02828196	2	F	4,0	6,0	10,0	55,0	13,25	4,0	0,15	–	4	■
JHP951040F2R020.3Z4-SIRA	02828261	2	F	4,0	6,0	10,0	55,0	13,25	4,0	–	0,2	4	□
JHP951040F2R050.3Z4-SIRA	02828262	2	F	4,0	6,0	10,0	55,0	13,25	4,0	–	0,5	4	□
JHP951050F2C.3Z4-SIRA	02828200	2	F	5,0	6,0	12,0	55,0	15,25	5,0	0,2	–	4	■
JHP951050F2R020.3Z4-SIRA	02828264	2	F	5,0	6,0	12,0	55,0	15,25	5,0	–	0,2	4	□
JHP951050F2R050.3Z4-SIRA	02828263	2	F	5,0	6,0	12,0	55,0	15,25	5,0	–	0,5	4	□
JHP951060D2C.3Z4-SIRA	02828206	2	D	6,0	6,0	14,0	55,0	–	–	0,2	–	4	■
JHP951060D2R020.3Z4-SIRA	02828266	2	D	6,0	6,0	14,0	55,0	–	–	–	0,2	4	□
JHP951060D2R050.3Z4-SIRA	02828265	2	D	6,0	6,0	14,0	55,0	–	–	–	0,5	4	□
JHP951080D2C.3Z4-SIRA	02828210	2	D	8,0	8,0	18,0	60,0	–	–	0,3	–	4	■
JHP951080D2R020.3Z4-SIRA	02828269	2	D	8,0	8,0	18,0	60,0	–	–	–	0,2	4	□
JHP951080D2R050.3Z4-SIRA	02828267	2	D	8,0	8,0	18,0	60,0	–	–	–	0,5	4	■
JHP951080D2R100.3Z4-SIRA	02828268	2	D	8,0	8,0	18,0	60,0	–	–	–	1,0	4	□
JHP951100E2C.3Z4-SIRA	02828220	2	E	10,0	10,0	22,0	70,0	28,0	9,4	0,3	–	4	■
JHP951100E2R050.3Z4-SIRA	02828271	2	E	10,0	10,0	22,0	70,0	28,0	9,4	–	0,5	4	□
JHP951100E2R100.3Z4-SIRA	02828270	2	E	10,0	10,0	22,0	70,0	28,0	9,4	–	1,0	4	□
JHP951120E2C.3Z4-SIRA	02828228	2	E	12,0	12,0	26,0	80,0	33,0	11,4	0,4	–	4	■
JHP951120E2R050.3Z4-SIRA	02828273	2	E	12,0	12,0	26,0	80,0	33,0	11,4	–	0,5	4	□
JHP951120E2R100.3Z4-SIRA	02828272	2	E	12,0	12,0	26,0	80,0	33,0	11,4	–	1,0	4	□
JHP951160E2C.3Z4-SIRA	02927874	2	E	16,0	16,0	34,0	90,0	40,0	15,0	0,5	–	4	■
JHP951160E2C.3Z5-SIRA	02828233	2	E	16,0	16,0	34,0	90,0	40,0	15,4	0,5	–	5	■
JHP951160E2R050.3Z4-SIRA	02927879	2	E	16,0	16,0	34,0	90,0	40,0	15,0	–	0,5	4	□
JHP951160E2R050.3Z5-SIRA	02828275	2	E	16,0	16,0	34,0	90,0	40,0	15,4	–	0,5	5	□
JHP951160E2R100.3Z4-SIRA	02927880	2	E	16,0	16,0	34,0	90,0	40,0	15,0	–	1,0	4	□
JHP951160E2R100.3Z5-SIRA	02828276	2	E	16,0	16,0	34,0	90,0	40,0	15,4	–	1,0	5	□
JHP951200E2R050.3Z4-SIRA	02927877	2	E	20,0	20,0	42,0	100,0	48,0	19,0	–	0,5	4	■
JHP951200E2R050.3Z5-SIRA	02828235	2	E	20,0	20,0	42,0	100,0	48,0	19,4	–	0,5	5	■
JHP951200E2R100.3Z4-SIRA	02927878	2	E	20,0	20,0	42,0	100,0	48,0	19,0	–	1,0	4	■
JHP951200E2R100.3Z5-SIRA	02828234	2	E	20,0	20,0	42,0	100,0	48,0	19,4	–	1,0	5	■

■ Stocked standard. □ Weldon available. Delivery time is 3 days.

Universal

Steel and cast iron

Stainless steel and S-materials

Non ferrous

Hard

Plastic and CFRP

Graphite

X-Heads

Minimaster Plus

Minimaster

Cutting data – JHP951 Side milling

SMG		a _e /DC	a _p /DC	f _z									v _c
				3	4	5	6	8	10	12	16	20	
P1	E/M/A	0.400	1.7	0.034	0.044	0.055	0.065	0.090	0.11	0.13	0.16	0.19	230 (200 – 260)
		0,400	1,7	0,0013	0,0017	0,0022	0,0026	0,0036	0,0044	0,0050	0,0065	0,0075	750 (660 – 850)
P2	E/M/A	0.400	1.7	0.034	0.044	0.055	0.065	0.090	0.11	0.13	0.17	0.19	220 (200 – 250)
		0,400	1,7	0,0013	0,0017	0,0022	0,0026	0,0036	0,0044	0,0050	0,0065	0,0075	720 (660 – 820)
P3	E/M/A	0.400	1.7	0.032	0.042	0.055	0.065	0.085	0.11	0.13	0.16	0.18	190 (170 – 210)
		0,400	1,7	0,0013	0,0017	0,0022	0,0026	0,0034	0,0044	0,0050	0,0065	0,0070	620 (560 – 680)
P4	E/M/A	0.400	1.7	0.032	0.042	0.050	0.060	0.085	0.10	0.12	0.15	0.18	170 (150 – 190)
		0,400	1,7	0,0013	0,0017	0,0020	0,0024	0,0034	0,0040	0,0048	0,0060	0,0070	560 (500 – 620)
P5	E/M/A	0.400	1.7	0.030	0.040	0.050	0.060	0.080	0.10	0.12	0.15	0.17	165 (150 – 180)
		0,400	1,7	0,0012	0,0016	0,0020	0,0024	0,0032	0,0040	0,0048	0,0060	0,0065	540 (500 – 590)
P6	E/M/A	0.400	1.7	0.030	0.040	0.050	0.060	0.080	0.10	0.12	0.15	0.17	185 (160 – 210)
		0,400	1,7	0,0012	0,0016	0,0020	0,0024	0,0032	0,0040	0,0048	0,0060	0,0065	610 (530 – 680)
P7	E/M/A	0.400	1.7	0.030	0.040	0.050	0.060	0.080	0.10	0.12	0.15	0.17	175 (150 – 190)
		0,400	1,7	0,0012	0,0016	0,0020	0,0024	0,0032	0,0040	0,0048	0,0060	0,0065	570 (500 – 620)
P8	E/M/A	0.400	1.7	0.032	0.042	0.055	0.065	0.085	0.11	0.13	0.16	0.18	160 (140 – 180)
		0,400	1,7	0,0013	0,0017	0,0022	0,0026	0,0034	0,0044	0,0050	0,0065	0,0070	520 (460 – 590)
P11	E/M/A	0.400	1.7	0.030	0.040	0.050	0.060	0.080	0.10	0.12	0.15	0.17	170 (150 – 190)
		0,400	1,7	0,0012	0,0016	0,0020	0,0024	0,0032	0,0040	0,0048	0,0060	0,0065	560 (500 – 620)
P12	E/M/A	0.400	1.7	0.020	0.028	0.034	0.042	0.055	0.070	0.080	0.10	0.12	110 (94 – 120)
		0,400	1,7	0,00080	0,0011	0,0013	0,0017	0,0022	0,0028	0,0032	0,0040	0,0048	360 (310 – 390)
K1	E/M/A	0.400	1.7	0.034	0.044	0.055	0.065	0.090	0.11	0.13	0.17	0.19	225 (200 – 250)
		0,400	1,7	0,0013	0,0017	0,0022	0,0026	0,0036	0,0044	0,0050	0,0065	0,0075	740 (660 – 820)
K2	E/M/A	0.400	1.7	0.030	0.040	0.050	0.060	0.080	0.10	0.12	0.15	0.17	200 (180 – 220)
		0,400	1,7	0,0012	0,0016	0,0020	0,0024	0,0032	0,0040	0,0048	0,0060	0,0065	660 (600 – 720)
K3	E/M/A	0.400	1.7	0.030	0.040	0.050	0.060	0.080	0.10	0.12	0.15	0.17	170 (150 – 190)
		0,400	1,7	0,0012	0,0016	0,0020	0,0024	0,0032	0,0040	0,0048	0,0060	0,0065	560 (500 – 620)
K4	E/M/A	0.400	1.7	0.030	0.040	0.050	0.060	0.080	0.10	0.12	0.15	0.17	160 (140 – 180)
		0,400	1,7	0,0012	0,0016	0,0020	0,0024	0,0032	0,0040	0,0048	0,0060	0,0065	520 (460 – 590)
K5	E/M/A	0.400	1.7	0.028	0.036	0.046	0.055	0.075	0.090	0.11	0.14	0.16	100 (85 – 110)
		0,400	1,7	0,0011	0,0014	0,0018	0,0022	0,0030	0,0036	0,0044	0,0055	0,0065	330 (280 – 360)
K6	E/M/A	0.400	1.7	0.030	0.040	0.050	0.060	0.080	0.10	0.12	0.15	0.17	140 (130 – 160)
		0,400	1,7	0,0012	0,0016	0,0020	0,0024	0,0032	0,0040	0,0048	0,0060	0,0065	460 (430 – 520)
K7	E/M/A	0.400	1.7	0.028	0.036	0.046	0.055	0.075	0.090	0.11	0.14	0.16	125 (110 – 140)
		0,400	1,7	0,0011	0,0014	0,0018	0,0022	0,0030	0,0036	0,0044	0,0055	0,0065	410 (370 – 450)

For cutting data recalculations, see pages 556 - 563

SMG = Seco material group
 Coolant = A=air D=dry E=emulsion M=mist spray
 v_c = m/min (sf/min)
 f_z = mm (in/tooth)
 a_p = mm/DC (in/DC) = factor
 a_e = mm/DC (in/DC) = factor
 All cutting data are target values

Universal
 Steel and cast iron
 Stainless steel and S-materials
 Non ferrous
 Hard
 Plastic and CFRP
 Graphite
 X-Heads
 Minmaster Plus
 Minmaster

Cutting data – JHP951 Slot milling

SMG		a _p /DC	f _z									v _c
			3	4	5	6	8	10	12	16	20	
P1	E/M/A	1.5	0.024	0.032	0.040	0.048	0.065	0.080	0.095	0.13	0.16	195 (170 – 220)
		1.5	0,00095	0,0013	0,0016	0,0019	0,0026	0,0032	0,0038	0,0050	0,0065	640 (560 – 720)
P2	E/M/A	1.5	0.024	0.032	0.040	0.048	0.065	0.080	0.095	0.13	0.16	190 (170 – 210)
		1.5	0,00095	0,0013	0,0016	0,0019	0,0026	0,0032	0,0038	0,0050	0,0065	620 (560 – 680)
P3	E/M/A	1.5	0.024	0.032	0.040	0.048	0.065	0.080	0.095	0.13	0.16	165 (150 – 180)
		1.5	0,00095	0,0013	0,0016	0,0019	0,0026	0,0032	0,0038	0,0050	0,0065	540 (500 – 590)
P4	E/M/A	1.5	0.024	0.032	0.040	0.048	0.065	0.080	0.095	0.13	0.16	145 (130 – 160)
		1.5	0,00095	0,0013	0,0016	0,0019	0,0026	0,0032	0,0038	0,0050	0,0065	475 (430 – 520)
P5	E/M/A	1.5	0.024	0.032	0.040	0.048	0.065	0.080	0.095	0.13	0.16	140 (120 – 150)
		1.5	0,00095	0,0013	0,0016	0,0019	0,0026	0,0032	0,0038	0,0050	0,0065	460 (400 – 490)
P6	E/M/A	1.5	0.024	0.032	0.040	0.048	0.065	0.080	0.095	0.13	0.16	155 (140 – 170)
		1.5	0,00095	0,0013	0,0016	0,0019	0,0026	0,0032	0,0038	0,0050	0,0065	510 (460 – 550)
P7	E/M/A	1.5	0.024	0.032	0.040	0.048	0.065	0.080	0.095	0.13	0.16	145 (130 – 160)
		1.5	0,00095	0,0013	0,0016	0,0019	0,0026	0,0032	0,0038	0,0050	0,0065	475 (430 – 520)
P8	E/M/A	1.5	0.024	0.032	0.040	0.048	0.065	0.080	0.095	0.13	0.16	140 (120 – 150)
		1.5	0,00095	0,0013	0,0016	0,0019	0,0026	0,0032	0,0038	0,0050	0,0065	460 (400 – 490)
P11	E/M/A	1.5	0.024	0.032	0.040	0.048	0.065	0.080	0.095	0.13	0.16	145 (130 – 160)
		1.5	0,00095	0,0013	0,0016	0,0019	0,0026	0,0032	0,0038	0,0050	0,0065	475 (430 – 520)
P12	E/M/A	1.5	0.020	0.028	0.034	0.040	0.055	0.070	0.080	0.10	0.12	85 (75 – 99)
		1.5	0,00080	0,0011	0,0013	0,0016	0,0022	0,0028	0,0032	0,0040	0,0048	280 (250 – 320)
K1	E/M/A	1.5	0.024	0.032	0.040	0.048	0.065	0.080	0.095	0.13	0.16	195 (170 – 220)
		1.5	0,00095	0,0013	0,0016	0,0019	0,0026	0,0032	0,0038	0,0050	0,0065	640 (560 – 720)
K2	E/M/A	1.5	0.024	0.032	0.040	0.048	0.065	0.080	0.095	0.13	0.16	170 (150 – 190)
		1.5	0,00095	0,0013	0,0016	0,0019	0,0026	0,0032	0,0038	0,0050	0,0065	560 (500 – 620)
K3	E/M/A	1.5	0.024	0.032	0.040	0.048	0.065	0.080	0.095	0.13	0.16	140 (130 – 160)
		1.5	0,00095	0,0013	0,0016	0,0019	0,0026	0,0032	0,0038	0,0050	0,0065	460 (430 – 520)
K4	E/M/A	1.5	0.024	0.032	0.040	0.048	0.065	0.080	0.095	0.13	0.16	135 (120 – 150)
		1.5	0,00095	0,0013	0,0016	0,0019	0,0026	0,0032	0,0038	0,0050	0,0065	445 (400 – 490)
K5	E/M/A	1.5	0.024	0.032	0.040	0.048	0.065	0.080	0.095	0.13	0.15	80 (70 – 92)
		1.5	0,00095	0,0013	0,0016	0,0019	0,0026	0,0032	0,0038	0,0050	0,0060	260 (230 – 300)
K6	E/M/A	1.5	0.024	0.032	0.040	0.048	0.065	0.080	0.095	0.13	0.16	120 (110 – 130)
		1.5	0,00095	0,0013	0,0016	0,0019	0,0026	0,0032	0,0038	0,0050	0,0065	395 (370 – 420)
K7	E/M/A	1.5	0.024	0.032	0.040	0.048	0.065	0.080	0.095	0.13	0.15	105 (89 – 110)
		1.5	0,00095	0,0013	0,0016	0,0019	0,0026	0,0032	0,0038	0,0050	0,0060	345 (300 – 360)

For cutting data recalculations, see pages 556 - 563

SMG = Seco material group
Coolant = A=air D=dry E=emulsion M=mist spray
v_c = m/min (sf/min)
f_z = mm (in/tooth)
a_p = mm/DC (in/DC) = factor
a_e = mm/DC (in/DC) = factor
All cutting data are target values

Universal

Steel and cast iron

Stainless steel and S-materials

Non ferrous

Hard

Plastic and CFRP

Graphite

X-Heads

Minimaster Plus

Minimaster

JH142

High speed – High precision – Torical – Hardened steel – 2-6 Flutes – Cylindrical – Corner radius

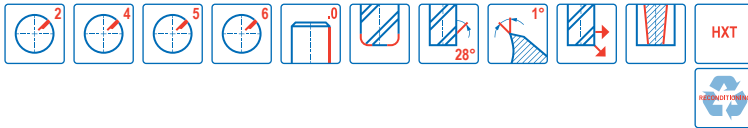
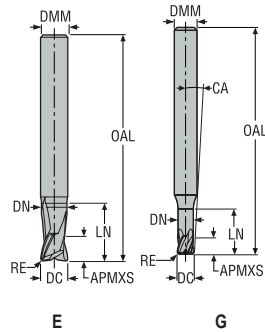

- Tolerances:
- Run-out= <0,005 mm
- DMM= h5
- DC= 0-0,01 mm
- RE= ±0,005 mm
- Regrind possible if DC is ≥Ø6

Designation	Item number	Length index	Tool shape	DC	DMM	APMXS	OAL	LN	DN	RE	CA°	PCEDC Cylindrical	
				mm	mm	mm	mm	mm	mm	mm			
JH142020G2R030.0Z2-HXT	02968223	2	G	2,0	4,0	2,0	40,0	6,0	1,9	0,3	6,64	2	■
JH142020G2R030.0Z4-HXT	02968224	2	G	2,0	4,0	2,0	40,0	6,0	1,9	0,3	6,64	4	■
JH142020G2R050.0Z2-HXT	02968225	2	G	2,0	4,0	2,0	40,0	6,0	1,9	0,5	6,79	2	■
JH142020G2R050.0Z4-HXT	02968226	2	G	2,0	4,0	2,0	40,0	6,0	1,9	0,5	6,79	4	■
JH142030G2R050.0Z2-HXT	02968227	2	G	3,0	4,0	3,0	40,0	8,0	2,8	0,5	2,95	2	■
JH142030G2R050.0Z4-HXT	02968228	2	G	3,0	4,0	3,0	40,0	8,0	2,8	0,5	2,95	4	■
JH142030G2R100.0Z2-HXT	02968229	2	G	3,0	4,0	3,0	40,0	8,0	2,8	1,0	3,1	2	■
JH142030G2R100.0Z4-HXT	02968230	2	G	3,0	4,0	3,0	40,0	8,0	2,8	1,0	3,1	4	■
JH142040G2R030.0Z2-HXT	02968231	2	G	4,0	6,0	4,0	50,0	8,0	3,7	0,3	5,34	2	■
JH142040G2R030.0Z4-HXT	02970110	2	G	4,0	6,0	4,0	50,0	8,0	3,7	0,3	5,34	4	■
JH142040G2R050.0Z4-HXT	02968232	2	G	4,0	6,0	4,0	50,0	8,0	3,7	0,5	5,44	4	■
JH142040G2R100.0Z4-HXT	02968233	2	G	4,0	6,0	4,0	50,0	8,0	3,7	1,0	5,69	4	■
JH142060E2R050.0Z4-HXT	02968235	2	E	6,0	6,0	6,0	50,0	12,0	5,6	0,5	-	4	■
JH142060E2R100.0Z4-HXT	02968237	2	E	6,0	6,0	6,0	50,0	12,0	5,6	1,0	-	4	■
JH142060E2R100.0Z5-HXT	02968238	2	E	6,0	6,0	6,0	50,0	12,0	5,6	1,0	-	5	■
JH142060E2R150.0Z5-HXT	02968240	2	E	6,0	6,0	6,0	50,0	12,0	5,6	1,5	-	5	■
JH142060E2R200.0Z5-HXT	02968241	2	E	6,0	6,0	6,0	50,0	12,0	5,6	2,0	-	5	■
JH142080E2R050.0Z5-HXT	02968242	2	E	8,0	8,0	8,0	60,0	16,0	7,4	0,5	-	5	■
JH142080E2R100.0Z5-HXT	02968243	2	E	8,0	8,0	8,0	60,0	16,0	7,4	1,0	-	5	■
JH142080E2R150.0Z5-HXT	02968244	2	E	8,0	8,0	8,0	60,0	16,0	7,4	1,5	-	5	■
JH142080E2R200.0Z5-HXT	02968245	2	E	8,0	8,0	8,0	60,0	16,0	7,4	2,0	-	5	■
JH142080E2R300.0Z5-HXT	02968246	2	E	8,0	8,0	8,0	60,0	16,0	7,4	3,0	-	5	■
JH142100E2R050.0Z5-HXT	02968247	2	E	10,0	10,0	10,0	70,0	20,0	9,4	0,5	-	5	■
JH142100E2R100.0Z5-HXT	02968248	2	E	10,0	10,0	10,0	70,0	20,0	9,4	1,0	-	5	■
JH142100E2R200.0Z5-HXT	02968249	2	E	10,0	10,0	10,0	70,0	20,0	9,4	2,0	-	5	■
JH142100E2R250.0Z5-HXT	02968250	2	E	10,0	10,0	10,0	70,0	20,0	9,4	2,5	-	5	■
JH142120E2R100.0Z6-HXT	02968251	2	E	12,0	12,0	12,0	75,0	24,0	11,4	1,0	-	6	■
JH142120E2R200.0Z6-HXT	02968252	2	E	12,0	12,0	12,0	75,0	24,0	11,4	2,0	-	6	■
JH142120E2R300.0Z6-HXT	02968253	2	E	12,0	12,0	12,0	75,0	24,0	11,4	3,0	-	6	■

■ Stocked standard.

Universal

Steel and cast iron

Stainless steel and S-materials

Non ferrous

Hard

Plastic and CFRP

Graphite

X-Heads

Minimaster Plus

Minimaster

JH142

High speed – High precision – Torical – Hardened steel – 2-5 Flutes – Cylindrical – Corner radius

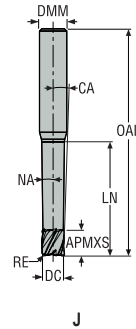

- Tolerances:
- Run-out= <0,005 mm
- DMM= h5
- DC= 0-0,01 mm
- RE= ±0,005 mm
- Regrind possible if DC is ≥Ø6



Designation	Item number	Length index	Tool shape	DC	DMM	APMXS	OAL	LN	DN	RE	CA°	PCEDC Cylindrical	
				mm	mm	mm	mm	mm	mm	mm	mm		
JH142020J3R030.0Z2-HXT	02968255	3	J	2,0	6,0	2,0	60,0	10,0	1,9	0,3	6,72	2	■
JH142020J3R030.0Z4-HXT	02968256	3	J	2,0	6,0	2,0	60,0	10,0	1,9	0,3	6,72	4	■
JH142020J3R050.0Z2-HXT	02968257	3	J	2,0	6,0	2,0	60,0	10,0	1,9	0,5	6,79	2	■
JH142020J3R050.0Z4-HXT	02968258	3	J	2,0	6,0	2,0	60,0	10,0	1,9	0,5	6,79	4	■
JH142030J3R050.0Z2-HXT	02968259	3	J	3,0	6,0	3,0	60,0	15,0	2,8	0,5	4,3	2	■
JH142030J3R050.0Z4-HXT	02968260	3	J	3,0	6,0	3,0	60,0	15,0	2,8	0,5	4,3	4	■
JH142030J3R100.0Z2-HXT	02968261	3	J	3,0	6,0	3,0	60,0	15,0	2,8	1,0	4,4	2	■
JH142030J3R100.0Z4-HXT	02968262	3	J	3,0	6,0	3,0	60,0	15,0	2,8	1,0	4,4	4	■
JH142040J3R030.0Z2-HXT	02968263	3	J	4,0	6,0	4,0	60,0	20,0	3,7	0,3	2,45	2	■
JH142040J3R030.0Z4-HXT	02970111	3	J	4,0	6,0	4,0	60,0	20,0	3,7	0,3	2,45	4	■
JH142040J3R050.0Z2-HXT	02968265	3	J	4,0	6,0	4,0	60,0	20,0	3,7	0,5	2,48	2	■
JH142040J3R050.0Z4-HXT	02968264	3	J	4,0	6,0	4,0	60,0	20,0	3,7	0,5	2,48	4	■
JH142040J3R100.0Z2-HXT	02968266	3	J	4,0	6,0	4,0	60,0	20,0	3,7	1,0	2,53	2	■
JH142040J3R100.0Z4-HXT	02968267	3	J	4,0	6,0	4,0	60,0	20,0	3,7	1,0	2,53	4	■
JH142060J3R050.0Z4-HXT	02968268	3	J	6,0	8,0	6,0	75,0	30,0	5,6	0,5	1,75	4	■
JH142060J3R050.0Z5-HXT	02968269	3	J	6,0	8,0	6,0	75,0	30,0	5,6	0,5	1,75	5	■
JH142060J3R100.0Z4-HXT	02968270	3	J	6,0	8,0	6,0	75,0	30,0	5,6	1,0	1,77	4	■
JH142060J3R100.0Z5-HXT	02968271	3	J	6,0	8,0	6,0	75,0	30,0	5,6	1,0	1,77	5	■
JH142060J3R150.0Z5-HXT	02968272	3	J	6,0	8,0	6,0	75,0	30,0	5,6	1,5	1,8	5	■
JH142060J3R200.0Z5-HXT	02968273	3	J	6,0	8,0	6,0	75,0	30,0	5,6	2,0	1,83	5	■
JH142080J3R050.0Z5-HXT	02968274	3	J	8,0	10,0	8,0	85,0	40,0	7,4	0,5	1,34	5	■
JH142080J3R100.0Z5-HXT	02968275	3	J	8,0	10,0	8,0	85,0	40,0	7,4	1,0	1,36	5	■
JH142080J3R150.0Z5-HXT	02968276	3	J	8,0	10,0	8,0	85,0	40,0	7,4	1,5	1,37	5	■
JH142080J3R200.0Z5-HXT	02968277	3	J	8,0	10,0	8,0	85,0	40,0	7,4	2,0	1,39	5	■
JH142100J3R050.0Z5-HXT	02968278	3	J	10,0	12,0	10,0	100,0	50,0	9,4	0,5	1,1	5	■
JH142100J3R100.0Z5-HXT	02968279	3	J	10,0	12,0	10,0	100,0	50,0	9,4	1,0	1,11	5	■
JH142100J3R200.0Z5-HXT	02968280	3	J	10,0	12,0	10,0	100,0	50,0	9,4	2,0	1,13	5	■
JH142020J6R030.0Z4-HXT	02968282	6	J	2,0	6,0	2,0	75,0	20,0	1,9	0,3	4,33	4	■
JH142020J6R050.0Z4-HXT	02968283	6	J	2,0	6,0	2,0	75,0	20,0	1,9	0,5	4,36	4	■
JH142030J6R050.0Z4-HXT	02968284	6	J	3,0	6,0	3,0	75,0	30,0	2,8	0,5	2,52	4	■
JH142030J6R100.0Z4-HXT	02968285	6	J	3,0	6,0	3,0	75,0	30,0	2,8	1,0	2,56	4	■
JH142040J6R030.0Z4-HXT	02968286	6	J	4,0	6,0	4,0	80,0	40,0	3,7	0,3	1,36	4	■
JH142040J6R050.0Z4-HXT	02968287	6	J	4,0	6,0	4,0	80,0	40,0	3,7	0,5	1,37	4	■
JH142040J6R100.0Z4-HXT	02968288	6	J	4,0	6,0	4,0	80,0	40,0	3,7	1,0	1,38	4	■

■ Stocked standard.

Universal

Steel and cast iron

Stainless steel and S-materials

Non ferrous

Hard

Plastic and CFRP

Graphite

X-Heads

Minimaster Plus

Minimaster

Cutting data – JH142 Copy milling roughing

SMG		a _p /DC	a _e /DC	f _z								v _c
				2	3	4	6	8	10	12	16	
P1	M/E	0.0500	0.050	0.020	0.030	0.040	0.060	0.080	0.10	0.12	0.14	485 (460 – 530)
		0,0500	0,050	0,00080	0,0012	0,0016	0,0024	0,0032	0,0040	0,0048	0,0055	1600 (1600 – 1700)
P2	M/E	0.0500	0.050	0.020	0.030	0.040	0.060	0.080	0.10	0.12	0.15	470 (450 – 520)
		0,0500	0,050	0,00080	0,0012	0,0016	0,0024	0,0032	0,0040	0,0048	0,0060	1550 (1500 – 1700)
P3	M/E	0.0500	0.050	0.019	0.028	0.038	0.055	0.075	0.095	0.11	0.14	405 (390 – 450)
		0,0500	0,050	0,00075	0,0011	0,0015	0,0022	0,0030	0,0038	0,0044	0,0055	1325 (1300 – 1400)
P4	M/E	0.0500	0.050	0.019	0.028	0.038	0.055	0.075	0.095	0.11	0.14	360 (340 – 390)
		0,0500	0,050	0,00075	0,0011	0,0015	0,0022	0,0030	0,0038	0,0044	0,0055	1175 (1200 – 1200)
P5	M/E	0.0500	0.050	0.018	0.028	0.036	0.055	0.075	0.090	0.11	0.13	345 (330 – 380)
		0,0500	0,050	0,00070	0,0011	0,0014	0,0022	0,0030	0,0036	0,0044	0,0050	1125 (1100 – 1200)
P6	M/E	0.0500	0.050	0.018	0.028	0.036	0.055	0.070	0.090	0.11	0.13	385 (370 – 420)
		0,0500	0,050	0,00070	0,0011	0,0014	0,0022	0,0028	0,0036	0,0044	0,0050	1275 (1300 – 1300)
P7	M/E	0.0500	0.050	0.018	0.028	0.036	0.055	0.070	0.090	0.11	0.13	365 (350 – 400)
		0,0500	0,050	0,00070	0,0011	0,0014	0,0022	0,0028	0,0036	0,0044	0,0050	1200 (1200 – 1300)
P8	M/E	0.0500	0.050	0.019	0.028	0.038	0.055	0.075	0.095	0.11	0.14	340 (330 – 380)
		0,0500	0,050	0,00075	0,0011	0,0015	0,0022	0,0030	0,0038	0,0044	0,0055	1125 (1100 – 1200)
P11	M/E	0.0500	0.050	0.018	0.028	0.036	0.055	0.070	0.090	0.11	0.13	355 (340 – 390)
		0,0500	0,050	0,00070	0,0011	0,0014	0,0022	0,0028	0,0036	0,0044	0,0050	1175 (1200 – 1200)
K1	A/E	0.0500	0.050	0.018	0.028	0.036	0.055	0.075	0.090	0.11	0.13	345 (330 – 380)
		0,0500	0,050	0,00070	0,0011	0,0014	0,0022	0,0030	0,0036	0,0044	0,0050	1125 (1100 – 1200)
K2	A/E	0.0500	0.050	0.017	0.025	0.034	0.050	0.065	0.085	0.10	0.12	300 (290 – 330)
		0,0500	0,050	0,00065	0,0010	0,0013	0,0020	0,0026	0,0034	0,0040	0,0048	980 (960 – 1000)
K3	A/E	0.0500	0.050	0.017	0.025	0.034	0.050	0.065	0.085	0.10	0.12	255 (240 – 280)
		0,0500	0,050	0,00065	0,0010	0,0013	0,0020	0,0026	0,0034	0,0040	0,0048	840 (790 – 910)
K4	A/E	0.0500	0.050	0.017	0.025	0.034	0.050	0.065	0.085	0.10	0.12	245 (230 – 260)
		0,0500	0,050	0,00065	0,0010	0,0013	0,0020	0,0026	0,0034	0,0040	0,0048	800 (760 – 850)
K5	A/E	0.0500	0.050	0.018	0.028	0.036	0.055	0.075	0.090	0.11	0.13	345 (330 – 380)
		0,0500	0,050	0,00070	0,0011	0,0014	0,0022	0,0030	0,0036	0,0044	0,0050	1125 (1100 – 1200)
K6	A/E	0.0500	0.050	0.020	0.030	0.040	0.060	0.080	0.10	0.12	0.15	500 (480 – 550)
		0,0500	0,050	0,00080	0,0012	0,0016	0,0024	0,0032	0,0040	0,0048	0,0060	1650 (1600 – 1800)
K7	A/E	0.0500	0.050	0.018	0.028	0.036	0.055	0.075	0.090	0.11	0.13	440 (420 – 490)
		0,0500	0,050	0,00070	0,0011	0,0014	0,0022	0,0030	0,0036	0,0044	0,0050	1450 (1400 – 1600)
H3	M/A	0.0200	0.020	0.014	0.020	0.028	0.042	0.055	0.070	0.080	0.10	95 (72 – 110)
		0,0200	0,020	0,00055	0,00080	0,0011	0,0017	0,0022	0,0028	0,0032	0,0040	310 (240 – 360)
H5	M/A	0.0400	0.040	0.014	0.022	0.028	0.042	0.055	0.070	0.085	0.10	305 (290 – 330)
		0,0400	0,040	0,00055	0,00085	0,0011	0,0017	0,0022	0,0028	0,0034	0,0040	1000 (960 – 1000)
H7	M/A	0.0200	0.020	0.014	0.020	0.028	0.042	0.055	0.070	0.080	0.10	95 (72 – 110)
		0,0200	0,020	0,00055	0,00080	0,0011	0,0017	0,0022	0,0028	0,0032	0,0040	310 (240 – 360)
H8	M/A	0.0400	0.040	0.011	0.016	0.022	0.032	0.042	0.055	0.065	0.080	310 (290 – 330)
		0,0400	0,040	0,00044	0,00065	0,00085	0,0013	0,0017	0,0022	0,0026	0,0032	1025 (960 – 1000)
H11	M/A	0.0400	0.040	0.014	0.022	0.028	0.042	0.055	0.070	0.085	0.10	390 (360 – 420)
		0,0400	0,040	0,00055	0,00085	0,0011	0,0017	0,0022	0,0028	0,0034	0,0040	1275 (1200 – 1300)
H12	M/A	0.0500	0.050	0.0095	0.014	0.019	0.028	0.038	0.046	0.055	0.070	345 (320 – 370)
		0,0500	0,050	0,00038	0,00055	0,00075	0,0011	0,0015	0,0018	0,0022	0,0028	1125 (1100 – 1200)
H21	M/A	0.0400	0.040	0.011	0.016	0.022	0.032	0.042	0.055	0.065	0.080	310 (290 – 330)
		0,0400	0,040	0,00044	0,00065	0,00085	0,0013	0,0017	0,0022	0,0026	0,0032	1025 (960 – 1000)
H31	M/A	0.0300	0.030	0.013	0.019	0.025	0.038	0.050	0.065	0.075	0.090	140 (120 – 160)
		0,0300	0,030	0,00050	0,00075	0,0010	0,0015	0,0020	0,0026	0,0030	0,0036	460 (400 – 520)

For cutting data recalculations, see pages 556 - 563

SMG = Seco material group
 Coolant = A=air D=dry E=emulsion M=mist spray
 v_c = m/min (sf/min)
 f_z = mm (in/tooth)
 a_p = mm/DC (in/DC) = factor
 a_e = mm/DC (in/DC) = factor
 All cutting data are target values

Universal
 Steel and cast iron
 Stainless steel and S-materials
 Non ferrous
 Hard
 Plastic and cfrp
 Graphite
 X-Heads
 Minmaster Plus
 Minmaster

JHB970

High speed – Universal – Ball nose – 2 Flutes – Cylindrical

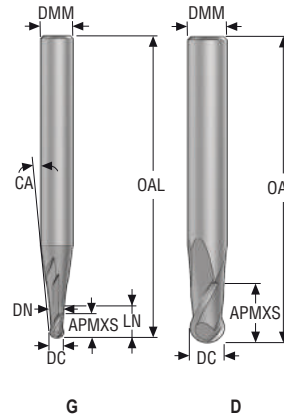

- Tolerances:
- DMM= h5
- DC= -0,02/-0,04 mm
- RE= ±0,01 mm
- Regrind possible if DC is ≥Ø6

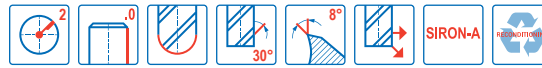

Designation	Grade	Item number	Length index	Tool shape	DC	DMM	APMXS	OAL	LN	DN	CA°	PCEDC	Cylindrical
					mm	mm	mm	mm	mm	mm			
JHB970020G1B.0Z2	SIRA	10072058	1	G	2,0	3,0	3,0	50,0	10,0	1,9	2,5	2	■
JHB970030D1B.0Z2	SIRA	10072059	1	D	3,0	3,0	4,5	50,0	-	-	-	2	■
JHB970040D1B.0Z2	SIRA	10072060	1	D	4,0	4,0	6,0	60,0	-	-	-	2	■
JHB970050D1B.0Z2	SIRA	10072061	1	D	5,0	5,0	7,5	60,0	-	-	-	2	■
JHB970060D1B.0Z2	SIRA	10072062	1	D	6,0	6,0	9,0	75,0	-	-	-	2	■
JHB970020G2B.0Z2	SIRA	10072063	2	G	2,0	6,0	3,0	60,0	4,0	1,9	8,0	2	■
JHB970025G2B.0Z2	SIRA	10072064	2	G	2,5	6,0	4,0	60,0	5,0	2,4	7,5	2	■
JHB970030G2B.0Z2	SIRA	10072065	2	G	3,0	6,0	4,5	60,0	6,0	2,8	5,5	2	■
JHB970035G2B.0Z2	SIRA	10072066	2	G	3,5	6,0	5,0	60,0	7,0	3,2	4,5	2	■
JHB970040G2B.0Z2	SIRA	10072067	2	G	4,0	6,0	6,0	60,0	8,0	3,7	3,0	2	■
JHB970050G2B.0Z2	SIRA	10072068	2	G	5,0	6,0	7,5	60,0	10,0	4,6	2,0	2	■
JHB970060G2B.0Z2	SIRA	10072069	2	G	6,0	8,0	9,0	75,0	12,0	5,6	2,5	2	■
JHB970080D2B.0Z2	SIRA	10072070	2	D	8,0	8,0	12,0	75,0	-	-	-	2	■
JHB970100D2B.0Z2	SIRA	10072071	2	D	10,0	10,0	15,0	80,0	-	-	-	2	■
JHB970120D2B.0Z2	SIRA	10072072	2	D	12,0	12,0	18,0	90,0	-	-	-	2	■
JHB970160D2B.0Z2	SIRA	10072073	2	D	16,0	16,0	24,0	100,0	-	-	-	2	■
JHB970020G3B.0Z2	SIRA	10072074	3	G	2,0	6,0	3,0	80,0	4,0	1,9	8,0	2	■
JHB970030G3B.0Z2	SIRA	10072075	3	G	3,0	6,0	4,5	80,0	6,0	2,8	5,5	2	■
JHB970040G3B.0Z2	SIRA	10072076	3	G	4,0	6,0	6,0	80,0	8,0	3,7	3,0	2	■
JHB970060G3B.0Z2	SIRA	10072077	3	G	6,0	8,0	9,0	100,0	12,0	5,6	2,5	2	■
JHB970080D3B.0Z2	SIRA	10072078	3	D	8,0	8,0	12,0	108,0	-	-	-	2	■
JHB970100D3B.0Z2	SIRA	10072079	3	D	10,0	10,0	15,0	125,0	-	-	-	2	■
JHB970120D3B.0Z2	SIRA	10072080	3	D	12,0	12,0	18,0	125,0	-	-	-	2	■

■ Stocked standard.

Universal

Steel and cast iron

Stainless steel and S-materials

Non ferrous

Hard

Plastic and CFRP

Graphite

X-Heads

Minimaster Plus

Minimaster

Cutting data – JHB970 Copy milling roughing

SMG		a _e /DC		f _z											v _c
		a _p /DC		2	2.5	3	3.5	4	5	6	8	10	12	16	
P1	M	0.200	1.0	0.011	0.014	0.016	0.019	0.022	0.028	0.032	0.044	0.055	0.065	0.080	210 (190 – 230)
		0.200	1.0	0.00044	0.00055	0.00065	0.00075	0.00085	0.0011	0.0013	0.0017	0.0022	0.0026	0.0032	690 (630 – 750)
P2	M	0.200	1.0	0.011	0.014	0.017	0.019	0.022	0.028	0.034	0.044	0.055	0.065	0.080	205 (180 – 230)
		0.200	1.0	0.00044	0.00055	0.00065	0.00075	0.00085	0.0011	0.0013	0.0017	0.0022	0.0026	0.0032	670 (600 – 750)
P3	M	0.200	1.0	0.010	0.013	0.016	0.018	0.020	0.026	0.032	0.042	0.050	0.060	0.075	180 (160 – 200)
		0.200	1.0	0.00040	0.00050	0.00065	0.00070	0.00080	0.0010	0.0013	0.0017	0.0020	0.0024	0.0030	590 (530 – 650)
P4	M	0.200	1.0	0.010	0.013	0.015	0.018	0.020	0.026	0.030	0.040	0.050	0.060	0.075	155 (140 – 170)
		0.200	1.0	0.00040	0.00050	0.00060	0.00070	0.00080	0.0010	0.0012	0.0016	0.0020	0.0024	0.0030	510 (460 – 550)
P5	M	0.200	1.0	0.010	0.012	0.015	0.018	0.020	0.025	0.030	0.040	0.050	0.060	0.075	150 (140 – 170)
		0.200	1.0	0.00040	0.00048	0.00060	0.00065	0.00080	0.0010	0.0012	0.0016	0.0020	0.0024	0.0030	490 (460 – 550)
P6	M	0.200	1.0	0.010	0.012	0.015	0.017	0.020	0.025	0.030	0.040	0.050	0.060	0.075	170 (150 – 190)
		0.200	1.0	0.00040	0.00048	0.00060	0.00065	0.00080	0.0010	0.0012	0.0016	0.0020	0.0024	0.0030	560 (500 – 620)
P7	M	0.200	1.0	0.010	0.012	0.015	0.017	0.020	0.025	0.030	0.040	0.050	0.060	0.075	160 (140 – 180)
		0.200	1.0	0.00040	0.00048	0.00060	0.00065	0.00080	0.0010	0.0012	0.0016	0.0020	0.0024	0.0030	520 (460 – 590)
P8	M	0.200	1.0	0.010	0.013	0.016	0.018	0.020	0.026	0.032	0.042	0.050	0.060	0.075	150 (140 – 170)
		0.200	1.0	0.00040	0.00050	0.00065	0.00070	0.00080	0.0010	0.0013	0.0017	0.0020	0.0024	0.0030	490 (460 – 550)
P11	M	0.200	1.0	0.010	0.012	0.015	0.017	0.020	0.025	0.030	0.040	0.050	0.060	0.075	75 (67 – 86)
		0.200	1.0	0.00040	0.00048	0.00060	0.00065	0.00080	0.0010	0.0012	0.0016	0.0020	0.0024	0.0030	245 (220 – 280)
P12	M	0.200	1.0	0.0070	0.0085	0.010	0.012	0.014	0.017	0.020	0.028	0.034	0.040	0.050	48 (42 – 53)
		0.200	1.0	0.00028	0.00034	0.00040	0.00048	0.00055	0.00065	0.00080	0.0011	0.0013	0.0016	0.0020	155 (140 – 170)
M1	E	0.200	1.0	0.0090	0.011	0.013	0.015	0.018	0.022	0.026	0.036	0.044	0.050	0.065	90 (80 – 100)
		0.200	1.0	0.00036	0.00044	0.00050	0.00060	0.00070	0.00085	0.0010	0.0014	0.0017	0.0020	0.0026	295 (270 – 320)
M2	E	0.200	1.0	0.0080	0.010	0.012	0.014	0.016	0.020	0.024	0.032	0.040	0.048	0.060	75 (65 – 85)
		0.200	1.0	0.00032	0.00040	0.00048	0.00055	0.00065	0.00080	0.00095	0.0013	0.0016	0.0019	0.0024	245 (220 – 270)
M3	E	0.150	1.0	0.0060	0.0075	0.0090	0.010	0.012	0.015	0.018	0.024	0.030	0.036	0.044	65 (55 – 75)
		0.150	1.0	0.00024	0.00030	0.00036	0.00040	0.00048	0.00060	0.00070	0.00095	0.0012	0.0014	0.0017	215 (190 – 240)
M4	E	0.150	1.0	0.0050	0.0065	0.0080	0.0090	0.010	0.013	0.016	0.020	0.026	0.032	0.038	49 (42 – 56)
		0.150	1.0	0.00020	0.00026	0.00032	0.00036	0.00040	0.00050	0.00065	0.00080	0.0010	0.0013	0.0015	160 (140 – 180)
M5	E	0.150	1.0	0.0050	0.0065	0.0080	0.0090	0.010	0.013	0.016	0.020	0.026	0.032	0.038	41 (35 – 47)
		0.150	1.0	0.00020	0.00026	0.00032	0.00036	0.00040	0.00050	0.00065	0.00080	0.0010	0.0013	0.0015	135 (120 – 150)
S1	E	0.100	0.80	0.0060	0.0075	0.0090	0.010	0.012	0.015	0.018	0.024	0.030	0.036	0.044	50 (40 – 59)
		0.100	0.80	0.00024	0.00030	0.00036	0.00040	0.00048	0.00060	0.00070	0.00095	0.0012	0.0014	0.0017	165 (140 – 190)
S2	E	0.100	0.80	0.0060	0.0075	0.0090	0.010	0.012	0.015	0.018	0.024	0.030	0.036	0.044	40 (33 – 48)
		0.100	0.80	0.00024	0.00030	0.00036	0.00040	0.00048	0.00060	0.00070	0.00095	0.0012	0.0014	0.0017	130 (110 – 150)
S3	E	0.100	0.60	0.0040	0.0050	0.0060	0.0070	0.0080	0.010	0.012	0.016	0.020	0.024	0.028	30 (20 – 39)
		0.100	0.60	0.00016	0.00020	0.00024	0.00028	0.00032	0.00040	0.00048	0.00065	0.00080	0.00095	0.0011	100 (66 – 120)
S11	E	0.200	1.0	0.010	0.012	0.015	0.018	0.020	0.025	0.030	0.040	0.050	0.060	0.075	90 (79 – 100)
		0.200	1.0	0.00040	0.00048	0.00060	0.00065	0.00080	0.0010	0.0012	0.0016	0.0020	0.0024	0.0030	295 (260 – 320)
S12	E	0.200	1.0	0.010	0.012	0.015	0.018	0.020	0.025	0.030	0.040	0.050	0.060	0.075	70 (61 – 80)
		0.200	1.0	0.00040	0.00048	0.00060	0.00065	0.00080	0.0010	0.0012	0.0016	0.0020	0.0024	0.0030	230 (210 – 260)
S13	E	0.200	1.0	0.0085	0.011	0.013	0.015	0.017	0.022	0.026	0.034	0.044	0.050	0.065	55 (48 – 63)
		0.200	1.0	0.00034	0.00044	0.00050	0.00060	0.00065	0.00085	0.0010	0.0013	0.0017	0.0020	0.0026	180 (160 – 200)

For cutting data recalculations, see pages 556 - 563

SMG = Seco material group
Coolant = A=air D=dry E=emulsion M=mist spray
v_c = m/min (sf/min)
f_z = mm (in/tooth)
a_p = mm/DC (in/DC) = factor
a_e = mm/DC (in/DC) = factor
All cutting data are target values

Universal
Steel and cast iron
Stainless steel and S-materials
Non ferrous
Hard
Plastic and CFRP
Graphite
X-Heads
Minimaster Plus
Minimaster

JH112

High speed – High precision – Hardened steel – Ball nose – 2 Flutes – Cylindrical

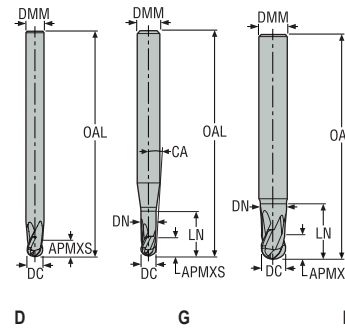

- Tolerances:
- Run-out= <0,005 mm
- DMM= h5
- DC= 0-0,01 mm
- RE= ±0,005 mm
- Regrind possible if DC is ≥Ø6

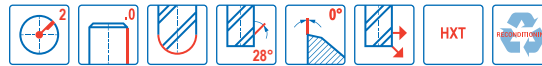

Designation	Item number	Length index	Tool shape	DC	DMM	APMXS	OAL	LN	DN	CA°	PCEDC	Cylindrical
				mm	mm	mm	mm	mm	mm			
JH112020G1B.0Z2-HXT	02970112	1	G	2,0	4,0	2,0	40,0	4,0	1,9	6,45	2	■
JH112030G1B.0Z2-HXT	02970113	1	G	3,0	4,0	3,0	40,0	6,0	2,8	3,3	2	■
JH112040D1B.0Z2-HXT	02970114	1	D	4,0	4,0	4,0	40,0	-	-	-	2	■
JH112050G1B.0Z2-HXT	02970115	1	G	5,0	6,0	5,0	50,0	10,0	4,6	2,0	2	■
JH112060D1B.0Z2-HXT	02970116	1	D	6,0	6,0	6,0	50,0	-	-	-	2	■
JH112080D1B.0Z2-HXT	02970117	1	D	8,0	8,0	8,0	65,0	-	-	-	2	■
JH112100D1B.0Z2-HXT	02970118	1	D	10,0	10,0	10,0	65,0	-	-	-	2	■
JH112020G2B.0Z2-HXT	02970119	2	G	2,0	3,0	2,0	50,0	10,0	1,9	2,5	2	■
JH112030D2B.0Z2-HXT	02970120	2	D	3,0	3,0	3,0	50,0	-	-	-	2	■
JH112040D2B.0Z2-HXT	02970121	2	D	4,0	4,0	4,0	60,0	-	-	-	2	■
JH112050D2B.0Z2-HXT	02970122	2	D	5,0	5,0	5,0	60,0	-	-	-	2	■
JH112060D2B.0Z2-HXT	02970123	2	D	6,0	6,0	6,0	75,0	-	-	-	2	■
JH112020G3B.0Z2-HXT	02970124	3	G	2,0	6,0	2,0	60,0	4,0	1,9	8,12	2	■
JH112025G3B.0Z2-HXT	02970125	3	G	2,5	6,0	2,5	60,0	5,0	2,4	7,39	2	■
JH112030G3B.0Z2-HXT	02970126	3	G	3,0	6,0	3,0	60,0	6,0	2,8	5,5	2	■
JH112035G3B.0Z2-HXT	02968289	3	G	3,5	6,0	3,5	65,0	7,0	3,2	3,81	2	■
JH112040G3B.0Z2-HXT	02970127	3	G	4,0	6,0	4,0	65,0	8,0	3,7	3,34	2	■
JH112050G3B.0Z2-HXT	02970128	3	G	5,0	6,0	5,0	65,0	10,0	4,6	2,0	2	■
JH112060G3B.0Z2-HXT	02970129	3	G	6,0	8,0	6,0	75,0	12,0	5,6	2,78	2	■
JH112080E3B.0Z2-HXT	02968290	3	E	8,0	8,0	8,0	75,0	16,0	7,4	-	2	■
JH112100E3B.0Z2-HXT	02968291	3	E	10,0	10,0	10,0	80,0	20,0	9,4	-	2	■
JH112120E3B.0Z2-HXT	02968292	3	E	12,0	12,0	12,0	90,0	24,0	11,4	-	2	■
JH112020G4B.0Z2-HXT	02970130	4	G	2,0	6,0	2,0	80,0	20,0	1,9	3,82	2	■
JH112030G4B.0Z2-HXT	02970131	4	G	3,0	6,0	3,0	80,0	20,0	2,8	2,91	2	■
JH112040G4B.0Z2-HXT	02970132	4	G	4,0	6,0	4,0	80,0	20,0	3,7	1,97	2	■
JH112050G4B.0Z2-HXT	02970133	4	G	5,0	6,0	5,0	100,0	50,0	4,6	0,53	2	■
JH112060D4B.0Z2-HXT	02968293	4	D	6,0	6,0	6,0	100,0	-	-	-	2	■
JH112080D4B.0Z2-HXT	02968294	4	D	8,0	8,0	8,0	110,0	-	-	-	2	■
JH112100D4B.0Z2-HXT	02968295	4	D	10,0	10,0	10,0	125,0	-	-	-	2	■
JH112120D4B.0Z2-HXT	02968296	4	D	12,0	12,0	12,0	125,0	-	-	-	2	■

■ Stocked standard.

Universal

Steel and cast iron

Stainless steel and S-materials

Non ferrous

Hard

Plastic and CFRP

Graphite

X-Heads

Minimaster Plus

Minimaster

JH112

High speed – High precision – Hardened steel – Ball nose – 2 Flutes – Cylindrical

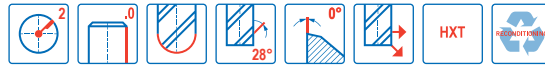
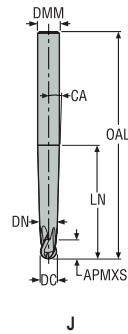

- Tolerances:
- Run-out= <0,005 mm
- DMM= h5
- DC= 0-0,01 mm
- RE= ±0,005 mm
- Re grind possible

Designation	Item number	Length index	Tool shape	DC	DMM	APMXS	OAL	LN	DN	CA°	PCEDC	Cylindrical
				mm	mm	mm	mm	mm	mm			
JH112020J5B.0Z2-HXT	02970134	5	J	2,0	6,0	2,0	80,0	35,0	1,9	3,3	2	■
JH112030J5B.0Z2-HXT	02970135	5	J	3,0	6,0	3,0	80,0	40,0	2,8	2,2	2	■
JH112040J5B.0Z2-HXT	02970136	5	J	4,0	6,0	4,0	80,0	52,0	3,7	1,2	2	■
JH112050J5B.0Z2-HXT	02970137	5	J	5,0	8,0	5,0	100,0	56,0	4,6	1,6	2	■
JH112060J5B.0Z2-HXT	02970138	5	J	6,0	8,0	6,0	100,0	56,0	5,6	1,1	2	■
JH112080J5B.0Z2-HXT	02970139	5	J	8,0	10,0	8,0	125,0	62,0	7,4	1,0	2	■
JH112100J5B.0Z2-HXT	02970140	5	J	10,0	12,0	10,0	125,0	61,0	9,4	1,0	2	■
JH112060J6B.0Z2-HXT	02970141	6	J	6,0	10,0	6,0	125,0	62,0	5,6	2,0	2	■
JH112080J6B.0Z2-HXT	02970142	6	J	8,0	12,0	8,0	150,0	67,0	7,4	1,8	2	■
JH112100J6B.0Z2-HXT	02970143	6	J	10,0	12,0	10,0	150,0	79,0	9,4	0,8	2	■

■ Stocked standard.

Universal

Steel and cast iron

Stainless steel and S-materials

Non ferrous

Hard

Plastic and CFRP

Graphite

X-Heads

Minimaster Plus

Minimaster

Cutting data – JH112 Copy milling finishing

SMG		a _p /DC	f _z										v _c
			2	2.5	3	3.5	4	5	6	8	10	12	
K1	E	0.30	0.030	0.038	0.044	0.050	0.060	0.075	0.090	0.12	0.15	0.18	520 (500 – 730)
		0.30	0.0012	0.0015	0.0017	0.0020	0.0024	0.0030	0.0036	0.0048	0.0060	0.0070	1700 (1700 – 2300)
K2	E	0.30	0.030	0.038	0.044	0.050	0.060	0.075	0.090	0.12	0.15	0.18	445 (430 – 630)
		0.30	0.0012	0.0015	0.0017	0.0020	0.0024	0.0030	0.0036	0.0048	0.0060	0.0070	1450 (1500 – 2000)
K3	E	0.30	0.030	0.038	0.044	0.050	0.060	0.075	0.090	0.12	0.15	0.18	380 (360 – 530)
		0.30	0.0012	0.0015	0.0017	0.0020	0.0024	0.0030	0.0036	0.0048	0.0060	0.0070	1250 (1200 – 1700)
K4	E	0.30	0.030	0.038	0.044	0.050	0.060	0.075	0.090	0.12	0.15	0.18	360 (350 – 510)
		0.30	0.0012	0.0015	0.0017	0.0020	0.0024	0.0030	0.0036	0.0048	0.0060	0.0070	1175 (1200 – 1600)
K5	E	0.30	0.030	0.038	0.044	0.050	0.060	0.075	0.090	0.12	0.15	0.18	415 (370 – 610)
		0.30	0.0012	0.0015	0.0017	0.0020	0.0024	0.0030	0.0036	0.0048	0.0060	0.0070	1350 (1300 – 2000)
K6	E	0.30	0.030	0.038	0.044	0.050	0.060	0.075	0.090	0.12	0.15	0.18	610 (550 – 900)
		0.30	0.0012	0.0015	0.0017	0.0020	0.0024	0.0030	0.0036	0.0048	0.0060	0.0070	2000 (1900 – 2900)
K7	E	0.30	0.030	0.038	0.044	0.050	0.060	0.075	0.090	0.12	0.15	0.18	680 (560 – 790)
		0.30	0.0012	0.0015	0.0017	0.0020	0.0024	0.0030	0.0036	0.0048	0.0060	0.0070	2225 (1900 – 2500)
H3	M	0.16	0.028	0.036	0.042	0.048	0.055	0.070	0.085	0.11	0.14	0.17	155 (150 – 230)
		0.16	0.0011	0.0014	0.0017	0.0019	0.0022	0.0028	0.0034	0.0044	0.0055	0.0065	510 (500 – 750)
H5	M	0.30	0.030	0.038	0.044	0.050	0.060	0.075	0.090	0.12	0.15	0.18	285 (240 – 330)
		0.30	0.0012	0.0015	0.0017	0.0020	0.0024	0.0030	0.0036	0.0048	0.0060	0.0070	940 (790 – 1000)
H7	M	0.16	0.028	0.036	0.042	0.048	0.055	0.070	0.085	0.11	0.14	0.17	155 (150 – 230)
		0.16	0.0011	0.0014	0.0017	0.0019	0.0022	0.0028	0.0034	0.0044	0.0055	0.0065	510 (500 – 750)
H8	M	0.30	0.030	0.038	0.044	0.050	0.060	0.075	0.090	0.12	0.15	0.18	285 (240 – 330)
		0.30	0.0012	0.0015	0.0017	0.0020	0.0024	0.0030	0.0036	0.0048	0.0060	0.0070	940 (790 – 1000)
H11	M	0.30	0.030	0.038	0.044	0.050	0.060	0.075	0.090	0.12	0.15	0.18	360 (300 – 420)
		0.30	0.0012	0.0015	0.0017	0.0020	0.0024	0.0030	0.0036	0.0048	0.0060	0.0070	1175 (990 – 1300)
H12	M	0.30	0.030	0.038	0.044	0.050	0.060	0.075	0.090	0.12	0.15	0.18	330 (280 – 380)
		0.30	0.0012	0.0015	0.0017	0.0020	0.0024	0.0030	0.0036	0.0048	0.0060	0.0070	1075 (920 – 1200)
H21	M	0.30	0.030	0.038	0.044	0.050	0.060	0.075	0.090	0.12	0.15	0.18	285 (240 – 330)
		0.30	0.0012	0.0015	0.0017	0.0020	0.0024	0.0030	0.0036	0.0048	0.0060	0.0070	940 (790 – 1000)
H31	M	0.30	0.026	0.032	0.040	0.046	0.050	0.065	0.080	0.10	0.13	0.16	300 (290 – 430)
		0.30	0.0010	0.0013	0.0016	0.0018	0.0020	0.0026	0.0032	0.0040	0.0050	0.0065	980 (960 – 1400)

For cutting data recalculations, see pages 556 - 563

SMG = Seco material group

Coolant = A=air D=dry E=emulsion M=mist spray

v_c = m/min (sf/min)

f_z = mm (in/tooth)

a_p = mm/DC (in/DC) = factor

a_e = mm/DC (in/DC) = factor

All cutting data are target values

Cutting data – JH112 Copy milling roughing

SMG		a _e /DC	a _p /DC	f _z										v _c
				2	2.5	3	3.5	4	5	6	8	10	12	
K1	E	0.250	0.15	0.030	0.038	0.044	0.050	0.060	0.075	0.090	0.12	0.15	0.18	315 (310 – 450)
		0,250	0,15	0,0012	0,0015	0,0017	0,0020	0,0024	0,0030	0,0036	0,0048	0,0060	0,0070	1025 (1100 – 1400)
K2	E	0.250	0.15	0.028	0.036	0.044	0.050	0.060	0.070	0.085	0.12	0.14	0.17	280 (270 – 390)
		0,250	0,15	0,0011	0,0014	0,0017	0,0020	0,0024	0,0028	0,0034	0,0048	0,0055	0,0065	920 (890 – 1200)
K3	E	0.250	0.15	0.028	0.036	0.044	0.050	0.060	0.070	0.085	0.12	0.14	0.17	235 (230 – 330)
		0,250	0,15	0,0011	0,0014	0,0017	0,0020	0,0024	0,0028	0,0034	0,0048	0,0055	0,0065	770 (760 – 1000)
K4	E	0.250	0.15	0.028	0.036	0.044	0.050	0.060	0.070	0.085	0.12	0.14	0.17	225 (220 – 320)
		0,250	0,15	0,0011	0,0014	0,0017	0,0020	0,0024	0,0028	0,0034	0,0048	0,0055	0,0065	740 (730 – 1000)
K5	E	0.160	0.15	0.030	0.038	0.044	0.050	0.060	0.075	0.090	0.12	0.15	0.18	280 (250 – 410)
		0,160	0,15	0,0012	0,0015	0,0017	0,0020	0,0024	0,0030	0,0036	0,0048	0,0060	0,0070	920 (830 – 1300)
K6	E	0.160	0.15	0.030	0.038	0.044	0.050	0.060	0.075	0.090	0.12	0.15	0.18	415 (370 – 610)
		0,160	0,15	0,0012	0,0015	0,0017	0,0020	0,0024	0,0030	0,0036	0,0048	0,0060	0,0070	1350 (1300 – 2000)
K7	E	0.250	0.10	0.030	0.038	0.044	0.050	0.060	0.075	0.090	0.12	0.15	0.18	420 (350 – 490)
		0,250	0,10	0,0012	0,0015	0,0017	0,0020	0,0024	0,0030	0,0036	0,0048	0,0060	0,0070	1375 (1200 – 1600)
H3	M	0.120	0.040	0.028	0.036	0.042	0.048	0.055	0.070	0.085	0.11	0.14	0.17	110 (100 – 160)
		0,120	0,040	0,0011	0,0014	0,0017	0,0019	0,0022	0,0028	0,0034	0,0044	0,0055	0,0065	360 (330 – 520)
H5	M	0.250	0.10	0.030	0.038	0.044	0.050	0.060	0.075	0.090	0.12	0.15	0.18	175 (150 – 200)
		0,250	0,10	0,0012	0,0015	0,0017	0,0020	0,0024	0,0030	0,0036	0,0048	0,0060	0,0070	570 (500 – 650)
H7	M	0.120	0.040	0.028	0.036	0.042	0.048	0.055	0.070	0.085	0.11	0.14	0.17	110 (100 – 160)
		0,120	0,040	0,0011	0,0014	0,0017	0,0019	0,0022	0,0028	0,0034	0,0044	0,0055	0,0065	360 (330 – 520)
H8	M	0.250	0.10	0.030	0.038	0.044	0.050	0.060	0.075	0.090	0.12	0.15	0.18	175 (150 – 200)
		0,250	0,10	0,0012	0,0015	0,0017	0,0020	0,0024	0,0030	0,0036	0,0048	0,0060	0,0070	570 (500 – 650)
H11	M	0.250	0.10	0.030	0.038	0.044	0.050	0.060	0.075	0.090	0.12	0.15	0.18	225 (190 – 260)
		0,250	0,10	0,0012	0,0015	0,0017	0,0020	0,0024	0,0030	0,0036	0,0048	0,0060	0,0070	740 (630 – 850)
H12	M	0.250	0.10	0.030	0.038	0.044	0.050	0.060	0.075	0.090	0.12	0.15	0.18	205 (170 – 240)
		0,250	0,10	0,0012	0,0015	0,0017	0,0020	0,0024	0,0030	0,0036	0,0048	0,0060	0,0070	670 (560 – 780)
H21	M	0.250	0.10	0.030	0.038	0.044	0.050	0.060	0.075	0.090	0.12	0.15	0.18	175 (150 – 200)
		0,250	0,10	0,0012	0,0015	0,0017	0,0020	0,0024	0,0030	0,0036	0,0048	0,0060	0,0070	570 (500 – 650)
H31	M	0.200	0.10	0.026	0.032	0.040	0.046	0.050	0.065	0.080	0.10	0.13	0.16	200 (200 – 280)
		0,200	0,10	0,0010	0,0013	0,0016	0,0018	0,0020	0,0026	0,0032	0,0040	0,0050	0,0065	660 (660 – 910)

For cutting data recalculations, see pages 556 - 563

SMG = Seco material group
 Coolant = A=air D=dry E=emulsion M=mist spray
 v_c = m/min (sf/min)
 f_z = mm (in/tooth)
 a_p = mm/DC (in/DC) = factor
 a_e = mm/DC (in/DC) = factor
 All cutting data are target values

Universal
 Steel and cast iron
 Stainless steel and S-materials
 Non ferrous
 Hard
 Plastic and cfrp
 Graphite
 X-Heads
 Minmaster Plus
 Minmaster

JH150

High speed – Hardened steel – Ball nose – 4 Flutes – Cylindrical

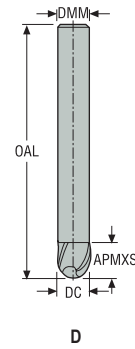

- Tolerances:
- DMM= h5
- DC= -0,02/-0,04 mm
- RE= ±0,01 mm
- Regrind possible

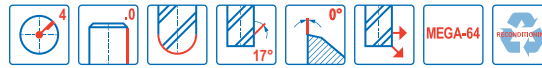

Designation	Item number	Length index	Tool shape	DC	DMM	APMXS	OAL	PCEDC	Cylindrical
				mm	mm	mm	mm		
150060-MEGA-64	00019198	2	D	6,0	6,0	6,0	80,0	4	■
150080-MEGA-64	00019208	2	D	8,0	8,0	8,0	85,0	4	■
150100-MEGA-64	00019219	2	D	10,0	10,0	10,0	100,0	4	■
150120-MEGA-64	00019254	2	D	12,0	12,0	12,0	100,0	4	■

■ Stocked standard.

Universal
Steel and cast iron
Stainless steel and S-materials
Non ferrous
Hard
Plastic and cfrp
Graphite
X-Heads
Minimaster Plus
Minimaster

Cutting data – JH150 Copy milling roughing

SMG		a _e /DC	a _p /DC	f _z				v _c
				6	8	10	12	
K1	A	0.300	0.15	0.10	0.14	0.17	0.20	290 (310 – 370)
		0,300	0,15	0,0040	0,0055	0,0065	0,0080	950 (1100 – 1200)
K2	A	0.300	0.15	0.10	0.14	0.17	0.20	250 (270 – 320)
		0,300	0,15	0,0040	0,0055	0,0065	0,0080	820 (890 – 1000)
K3	A	0.300	0.15	0.10	0.14	0.17	0.20	210 (230 – 270)
		0,300	0,15	0,0040	0,0055	0,0065	0,0080	690 (760 – 880)
K5	A	0.200	0.15	0.10	0.14	0.17	0.20	255 (270 – 330)
		0,200	0,15	0,0040	0,0055	0,0065	0,0080	840 (890 – 1000)
K6	A	0.200	0.15	0.10	0.14	0.17	0.20	375 (390 – 500)
		0,200	0,15	0,0040	0,0055	0,0065	0,0080	1225 (1300 – 1600)
K7	A	0.200	0.15	0.10	0.14	0.17	0.20	325 (340 – 430)
		0,200	0,15	0,0040	0,0055	0,0065	0,0080	1075 (1200 – 1400)
H3	M	0.0500	0.020	0.085	0.11	0.14	0.17	85 (88 – 120)
		0,0500	0,020	0,0034	0,0044	0,0055	0,0065	280 (290 – 390)
H5	M	0.200	0.060	0.10	0.14	0.17	0.20	180 (160 – 200)
		0,200	0,060	0,0040	0,0055	0,0065	0,0080	590 (530 – 650)
H7	M	0.0500	0.020	0.085	0.11	0.14	0.17	85 (88 – 120)
		0,0500	0,020	0,0034	0,0044	0,0055	0,0065	280 (290 – 390)
H8	M	0.200	0.060	0.10	0.14	0.17	0.20	180 (160 – 200)
		0,200	0,060	0,0040	0,0055	0,0065	0,0080	590 (530 – 650)
H11	M	0.200	0.060	0.10	0.14	0.17	0.20	230 (210 – 250)
		0,200	0,060	0,0040	0,0055	0,0065	0,0080	750 (690 – 820)
H12	M	0.200	0.060	0.10	0.14	0.17	0.20	210 (190 – 230)
		0,200	0,060	0,0040	0,0055	0,0065	0,0080	690 (630 – 750)
H21	M	0.200	0.060	0.10	0.14	0.17	0.20	180 (160 – 200)
		0,200	0,060	0,0040	0,0055	0,0065	0,0080	590 (530 – 650)
H31	M	0.150	0.060	0.090	0.12	0.15	0.18	125 (130 – 180)
		0,150	0,060	0,0036	0,0048	0,0060	0,0070	410 (430 – 590)

For cutting data recalculations, see pages 556 - 563

SMG = Seco material group
Coolant = A=air D=dry E=emulsion M=mist spray
v_c = m/min (sf/min)
f_z = mm (in/tooth)
a_p = mm/DC (in/DC) = factor
a_e = mm/DC (in/DC) = factor
All cutting data are target values

Universal
Steel and cast iron
Stainless steel and S-materials
Non ferrous
Hard
Plastic and cfrp
Graphite
X-Heads
Minimaster Plus
Minimaster

JH160

High speed – Hardened steel – Ball nose – 4 Flutes – Cylindrical

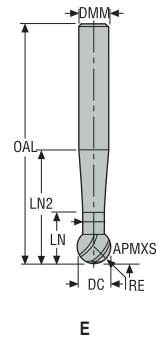

- Tolerances:
- DMM= h5
- DC= 0,02/-0,06 mm
- SA=250°

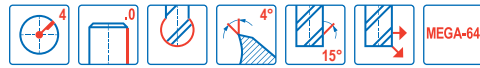

Designation	Item number	Length index	Tool shape	DC	DMM	APMXS	OAL	LN	LN2	DN	RE	PCEDC	Cylindrical
				mm	mm	mm	mm	mm	mm	mm	mm		
160030-MEGA-64	00040365	2	E	3,0	3,0	2,3	60,0	4,5	9,0	1,8	1,5	4	■
160040-MEGA-64	00040366	2	E	4,0	4,0	3,1	60,0	5,6	11,0	2,4	2,0	4	■
160050-MEGA-64	00040367	2	E	5,0	5,0	3,9	70,0	6,4	13,0	3,0	2,5	4	■
160060-MEGA-64	00040368	2	E	6,0	6,0	4,7	80,0	9,7	17,3	3,6	3,0	4	■
160080-MEGA-64	00040369	2	E	8,0	8,0	6,2	85,0	11,2	21,3	4,8	4,0	4	■
160100-MEGA-64	00040370	2	E	10,0	10,0	7,8	100,0	15,6	27,9	6,0	5,0	4	■
160120-MEGA-64	00040371	2	E	12,0	12,0	9,4	125,0	17,2	31,8	7,2	6,0	4	■

■ Stocked standard.

Universal

Steel and cast iron

Stainless steel and S-materials

Non ferrous

Hard

Plastic and CFRP

Graphite

X-Heads

Minimaster Plus

Minimaster

Cutting data – JH160 Copy milling finishing

SMG		a _e /DC	a _p /DC	f _z							v _c
				3	4	5	6	8	10	12	
P1	M/E/A	0.0200	0.024	0.050	0.070	0.085	0.10	0.14	0.17	0.20	550 (450 — 700)
		0,0200	0,024	0,0020	0,0028	0,0034	0,0040	0,0055	0,0065	0,0080	1800 (1500 — 2200)
P2	M/E/A	0.0200	0.024	0.050	0.070	0.085	0.10	0.14	0.17	0.20	530 (440 — 680)
		0,0200	0,024	0,0020	0,0028	0,0034	0,0040	0,0055	0,0065	0,0080	1750 (1500 — 2200)
P3	M/E/A	0.0200	0.024	0.050	0.070	0.085	0.10	0.14	0.17	0.20	460 (380 — 590)
		0,0200	0,024	0,0020	0,0028	0,0034	0,0040	0,0055	0,0065	0,0080	1500 (1300 — 1900)
P4	M/E/A	0.0200	0.024	0.050	0.070	0.085	0.10	0.14	0.17	0.20	405 (340 — 520)
		0,0200	0,024	0,0020	0,0028	0,0034	0,0040	0,0055	0,0065	0,0080	1325 (1200 — 1700)
P5	M/E/A	0.0200	0.024	0.050	0.070	0.085	0.10	0.14	0.17	0.20	385 (320 — 490)
		0,0200	0,024	0,0020	0,0028	0,0034	0,0040	0,0055	0,0065	0,0080	1275 (1100 — 1600)
P6	M/E/A	0.0200	0.024	0.050	0.070	0.085	0.10	0.14	0.17	0.20	430 (360 — 560)
		0,0200	0,024	0,0020	0,0028	0,0034	0,0040	0,0055	0,0065	0,0080	1400 (1200 — 1800)
P7	M/E/A	0.0200	0.024	0.050	0.070	0.085	0.10	0.14	0.17	0.20	410 (340 — 520)
		0,0200	0,024	0,0020	0,0028	0,0034	0,0040	0,0055	0,0065	0,0080	1350 (1200 — 1700)
P8	M/E/A	0.0200	0.024	0.050	0.070	0.085	0.10	0.14	0.17	0.20	385 (320 — 490)
		0,0200	0,024	0,0020	0,0028	0,0034	0,0040	0,0055	0,0065	0,0080	1275 (1100 — 1600)
P11	M/E/A	0.0200	0.024	0.050	0.070	0.085	0.10	0.14	0.17	0.20	395 (330 — 510)
		0,0200	0,024	0,0020	0,0028	0,0034	0,0040	0,0055	0,0065	0,0080	1300 (1100 — 1600)
P12	M/E/A	0.0200	0.024	0.050	0.070	0.085	0.10	0.14	0.17	0.20	235 (200 — 300)
		0,0200	0,024	0,0020	0,0028	0,0034	0,0040	0,0055	0,0065	0,0080	770 (660 — 980)
H3	M/E/A	0.0100	0.0075	0.040	0.050	0.065	0.080	0.10	0.13	0.16	85 (91 — 110)
		0,0100	0,0075	0,0016	0,0020	0,0026	0,0032	0,0040	0,0050	0,0065	280 (300 — 360)
H5	M/E/A	0.0100	0.016	0.040	0.050	0.065	0.080	0.10	0.13	0.16	340 (320 — 360)
		0,0100	0,016	0,0016	0,0020	0,0026	0,0032	0,0040	0,0050	0,0065	1125 (1100 — 1100)
H7	M/E/A	0.0100	0.0075	0.040	0.050	0.065	0.080	0.10	0.13	0.16	85 (91 — 110)
		0,0100	0,0075	0,0016	0,0020	0,0026	0,0032	0,0040	0,0050	0,0065	280 (300 — 360)
H8	M/E/A	0.0100	0.016	0.040	0.050	0.065	0.080	0.10	0.13	0.16	340 (320 — 360)
		0,0100	0,016	0,0016	0,0020	0,0026	0,0032	0,0040	0,0050	0,0065	1125 (1100 — 1100)
H11	M/E/A	0.0100	0.016	0.040	0.050	0.065	0.080	0.10	0.13	0.16	430 (400 — 460)
		0,0100	0,016	0,0016	0,0020	0,0026	0,0032	0,0040	0,0050	0,0065	1400 (1400 — 1500)
H12	M/E/A	0.0200	0.024	0.050	0.070	0.085	0.10	0.14	0.17	0.20	355 (340 — 380)
		0,0200	0,024	0,0020	0,0028	0,0034	0,0040	0,0055	0,0065	0,0080	1175 (1200 — 1200)
H21	M/E/A	0.0100	0.016	0.040	0.050	0.065	0.080	0.10	0.13	0.16	340 (320 — 360)
		0,0100	0,016	0,0016	0,0020	0,0026	0,0032	0,0040	0,0050	0,0065	1125 (1100 — 1100)
H31	M/E/A	0.0100	0.016	0.040	0.050	0.065	0.080	0.10	0.13	0.16	165 (180 — 210)
		0,0100	0,016	0,0016	0,0020	0,0026	0,0032	0,0040	0,0050	0,0065	540 (600 — 680)

For cutting data recalculations, see pages 556 - 563

SMG = Seco material group
Coolant = A=air D=dry E=emulsion M=mist spray
v_c = m/min (sf/min)
f_z = mm (in/tooth)
a_p = mm/DC (in/DC) = factor
a_e = mm/DC (in/DC) = factor
All cutting data are target values

Universal
Steel and cast iron
Stainless steel and S-materials
Non ferrous
Hard
Plastic and cfrp
Graphite
X-Heads
Minimaster Plus
Minimaster

Universal
Steel and cast iron
Stainless steel and S-materials
Non ferrous
Hard
Plastic and CFRP
Graphite
X-Heads
Minimaster Plus
Minimaster







































STAINLESS AND S-MATERIALS

Seco offers a complete range of high performance solid carbide square shoulder end mills, ballnose cutters and finish end mills for high productivity in stainless steel and ISO S-materials.

- JS754, JS755, JS720, JHP751, JHP760, JHP770, JHP780, JHP794, JCG790, JH770, JH740, JH710, JH790, JH730, JHP994, SHF712, SME714, SME716 and JCO710 for chamfer or radius type.
- JS730, JH780, JHB720, JH721, JH722, SMB713, SMB714 and SMB716 for ball-nose type.
- JH724, JH726, JH734, JH736, JH744, JH746 for barrel type.

Tool selection Stainless and S-materials



































								
								
Name		JS754	JS755	JS720	JS730	JHP751	JHP760	JHP770
Page(s)		213	230	241	254	258	261	265
Family name		SOLID ²	SOLID ²	SOLID ²	SOLID ²	HPM	HPM	HPM
Type of mill								
Shank	Cylindrical	■	■	■	■	■	■	■
	Weldon	■	■	■	□	■	■	■
	SafeLock	□	□	□	□			□
Number of Flutes		4	5	6,9	6	2,3,4	2,4	4-5
ICC		■					■	■
Diameter range	Metric	3-25	6-25	6-25	6-25	2-20	4-25	6-25
	Inch							
Length availability		1,2,3	2,3	2,3	2,3	1,2	2,3	2
Operation								
								
								
								
SMG								
M1		●	●	●	●		●	
M2		●	●	●	●		●	
M3		●	●	●	●		●	
M4		●	●	●	●		●	
M5		●	●	●	●		●	
S1		●	●	●	●	●		
S2		●	●	●	●	●		
S3		●	●	●	●	●		
S11		●	●	●	●	●		●
S12		●	●	●	●	●		●
S13		●	●	●	●	●		●

■ Stock standard □ Weldon available, delivery time is 3 days. □ Safe-Lock available, delivery time is 6 days
 ● Preferred choice ○ Alternative choice

Universal
 Steel and cast iron
 Stainless steel and S-materials
 Non ferrous
 Hard
 Plastic and CFRP
 Graphite
 X-Heads
 Minimax Plus
 Minimax





























Universal
 Steel and cast iron
 Stainless steel and S-materials
 Non ferrous
 Hard
 Plastic and CFRP
 Graphite
 X-Heads
 Minimaster Plus
 Minimaster

Tool selection Stainless and S-materials

										
Name		JHP780	JHP794	JCG790	JH724	JH726	JH734	JH736	JH744	JH746
Page(s)		272	277	279	281	283	285	287	289	291
Family name		HPM	HPM	Ceramic	HSM/ TORNADO	HSM/ TORNADO	HSM/ TORNADO	HSM/ TORNADO	HSM/ TORNADO	HSM/ TORNADO
Type of mill										
Shank	Cylindrical	■		■	■	■	■	■	■	■
	Weldon	■	■							
	SafeLock	□								
Number of Flutes		4	4	5-6	4	6	4	6	4	6
ICC		■	■						■	■
Diameter range	Metric	6-25	6-25	6-25	10	10	6-16	10-16	4-16	10-16
	Inch									
Length availability		2	2	2	2	2	2	2	2,4	2
Operation										
										
										
SMG										
M1			●		●	●	●	●	●	●
M2			●		●	●	●	●	●	●
M3			●		●	●	●	●	●	●
M4			●		●	●				
M5			●		●	●				
S1		●		●	●	●				
S2		●		●	●	●				
S3		●		●	●	●				
S11					●	●	●	●	●	●
S12					●	●	●	●	●	●
S13					●	●	●	●	●	●

■ Stock standard □ Weldon available, delivery time is 3 days. □ Safe-Lock available, delivery time is 6 days
 ● Preferred choice ○ Alternative choice

Tool selection Stainless and S-materials





























								
								
Name	JH770	JH740	JH710	JH790	JH730	JHP994	JH780	
Page(s)	293	289	297	299	301	303	305	
Family name	HSM/TORNADO	HSM/TORNADO	HSM/TORNADO	HSM/TORNADO	HSM/TORNADO	HPM	HSM/TORNADO	
Type of mill								
Shank	Cylindrical	■	■	■	■	■	■	
	Weldon							
	Safelock							
Number of Flutes	3,4,5,6	4-5	5	6	6-7	4	4	
ICC								
Diameter range	Metric	3-10	6-10	6-8	9,5	8-10	6-10	1,83-4,89
	Inch							
Length availability	2	2	2	2-3	2	3	2	
Operation								
								
SMG								
M1								
M2								
M3								
M4								
M5								
S1								
S2	●	●	●	●	●	●	●	
S3								
S11	●	●	●	●	●	●	●	
S12	●	●	●	●	●	●	●	
S13								

■ Stock standard □ Weldon available, delivery time is 3 days. □ Safe-Lock available, delivery time is 6 days
 ● Preferred choice ○ Alternative choice

Universal
 Steel and cast iron
 Stainless steel and S-materials
 Non ferrous
 Hard
 Plastic and cfrp
 Graphite
 X-Heads
 Minimaster Plus
 Minimaster

Universal
 Steel and cast iron
 Stainless steel and S-materials
 Non ferrous
 Hard
 Plastic and cfrp
 Graphite
 X-Heads
 Minimaster Plus
 Minimaster

Tool selection Stainless and S-materials

								
Name		JHB720	JH721	JH722	SHF712	SME714/716	SMB713/714/416	JCO710
Page(s)		307	309	311	313	315	170	319
Family name		HSM/TORNADO	HSM/TORNADO	HSM/TORNADO	HFM	MINI	MINI	HSS-Co
Type of mill								
Shank	Cylindrical	■	■	■	■	■	■	
	Weldon							■
	Safelock							
Number of Flutes		3	6	6	2	2	2	4-6
ICC								
Diameter range	Metric	2-16	6-8	10	3-6	0,5-2	0,3-3	16-40
	Inch							
Length availability		2	2	2	2,3,4	1,3,4,5,6,7	2,3,4,5,6,7	2,4
Operation								
								
								
SMG								
M1		●						●
M2		●						●
M3		●						●
M4		●						●
M5		●						●
S1		○						
S2		○	●	●	●	●	●	
S3		○						
S11		●	●	●				●
S12		●	●	●	●	●	●	●
S13		●						●

■ Stock standard □ Weldon available, delivery time is 3 days.
 ● Preferred choice ○ Alternative choice

JS754

High performance – Square – ISO– M and ISO– S – 4 Flutes – Cylindrical – Chamfer

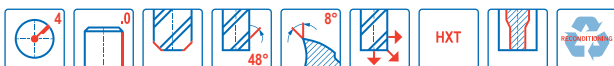
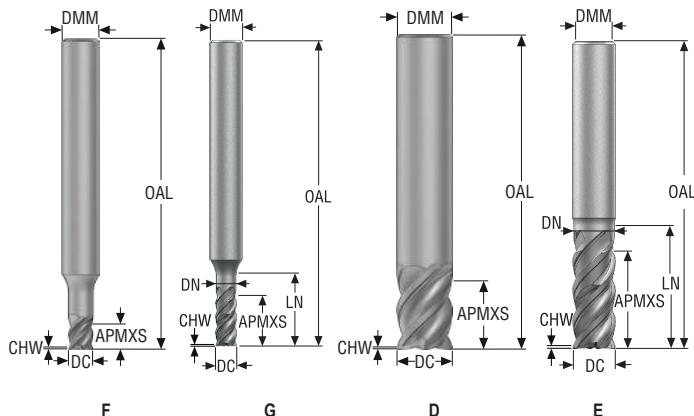

- Tolerances:
- DMM= h5
- DC= e7
- Regrind possible if DC is $\geq \varnothing 6$

Designation	Item number	Length index	Tool shape	DC	DMM	APMXS	OAL	LN	DN	CHW	PCEDC	Cylindrical
				mm	mm	mm	mm	mm	mm	mm		
JS754030F1C.0Z4-HXT	10165556	1	F	3,0	6,0	4,0	50,0	6,0	3,05	0,035	4	■
JS754040F1C.0Z4-HXT	10164855	1	F	4,0	6,0	5,0	50,0	9,0	4,05	0,045	4	■
JS754050F1C.0Z4-HXT	10165557	1	F	5,0	6,0	7,0	50,0	10,0	5,05	0,055	4	■
JS754060D1C.0Z4-HXT	10164856	1	D	6,0	6,0	8,0	50,0	–	–	0,075	4	■
JS754080D1C.0Z4-HXT	10164857	1	D	8,0	8,0	11,0	58,0	–	–	0,1	4	■
JS754100D1C.0Z4-HXT	10164858	1	D	10,0	10,0	13,0	58,0	–	–	0,125	4	■
JS754120D1C.0Z4-HXT	10164859	1	D	12,0	12,0	15,0	67,0	–	–	0,15	4	■
JS754160D1C.0Z4-HXT	10164860	1	D	16,0	16,0	19,0	73,0	–	–	0,2	4	■
JS754030G2C.0Z4-HXT	03186807	2	G	3,0	6,0	6,0	57,0	10,0	2,85	0,035	4	■
JS754040G2C.0Z4-HXT	03186808	2	G	4,0	6,0	8,0	57,0	13,0	3,8	0,045	4	■
JS754050G2C.0Z4-HXT	03186809	2	G	5,0	6,0	10,0	57,0	16,0	4,75	0,055	4	■
JS754060E2C.0Z4-HXT	03186810	2	E	6,0	6,0	12,0	57,0	18,0	5,7	0,075	4	■
JS754080E2C.0Z4-HXT	03186811	2	E	8,0	8,0	16,0	63,0	25,0	7,6	0,1	4	■
JS754100E2C.0Z4-HXT	03186812	2	E	10,0	10,0	20,0	72,0	29,0	9,5	0,125	4	■
JS754120E2C.0Z4-HXT	03186813	2	E	12,0	12,0	24,0	83,0	35,0	11,4	0,15	4	■
JS754160E2C.0Z4-HXT	03186814	2	E	16,0	16,0	32,0	92,0	42,0	15,2	0,2	4	■
JS754200E2C.0Z4-HXT	03186815	2	E	20,0	20,0	40,0	104,0	51,0	19,0	0,25	4	■
JS754250E2C.0Z4-HXT	03186816	2	E	25,0	25,0	50,0	121,0	65,0	23,8	0,3	4	■
JS754060E3C.0Z4-HXT	03186823	3	E	6,0	6,0	21,0	65,0	26,0	5,7	0,075	4	■
JS754080E3C.0Z4-HXT	03186824	3	E	8,0	8,0	32,0	75,0	37,0	7,6	0,1	4	■
JS754100E3C.0Z4-HXT	03186825	3	E	10,0	10,0	40,0	89,0	47,0	9,5	0,125	4	■
JS754120E3C.0Z4-HXT	03186826	3	E	12,0	12,0	45,0	100,0	53,0	11,4	0,15	4	■
JS754160E3C.0Z4-HXT	03186827	3	E	16,0	16,0	55,0	115,0	65,0	15,2	0,2	4	■
JS754200E3C.0Z4-HXT	03186828	3	E	20,0	20,0	61,0	125,0	72,0	19,0	0,25	4	■
JS754250E3C.0Z4-HXT	03186829	3	E	25,0	25,0	85,0	153,0	94,0	23,8	0,3	4	■

■ Stocked standard.

Universal

Steel and cast iron

Stainless steel and S-materials

Non ferrous

Hard

Plastic and CFRP

Graphite

X-Heads

Minimaster Plus

Minimaster

JS754

High performance – Square – ISO– M and ISO– S – 4 Flutes – Cylindrical – Chamfer – Chip splitters

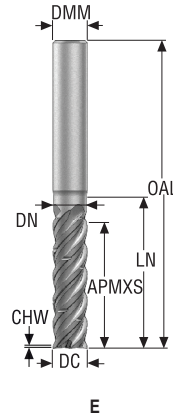

E

- Tolerances:
- DMM= h5
- DC= e7
- Chip splitters
- Regrind possible

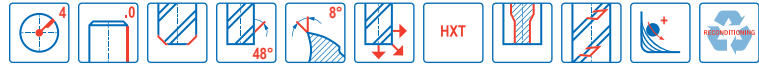

Designation	Item number	Length index	Tool shape	Chip splitters	DC	DMM	APMXS	OAL	LN	DN	CHW	PCEDC	Cylindrical
					mm	mm	mm	mm	mm	mm	mm		
JS754100E2C.0Z4C-HXT	03186817	2	E	■	10,0	10,0	20,0	72,0	29,0	9,5	0,125	4	■
JS754120E2C.0Z4C-HXT	03186818	2	E	■	12,0	12,0	24,0	83,0	35,0	11,4	0,15	4	■
JS754060E3C.0Z4C-HXT	03200550	3	E	■	6,0	6,0	21,0	65,0	26,0	5,7	0,075	4	■
JS754080E3C.0Z4C-HXT	03200551	3	E	■	8,0	8,0	32,0	75,0	37,0	7,6	0,1	4	■
JS754100E3C.0Z4C-HXT	03186830	3	E	■	10,0	10,0	40,0	89,0	47,0	9,5	0,125	4	■
JS754120E3C.0Z4C-HXT	03186831	3	E	■	12,0	12,0	45,0	100,0	53,0	11,4	0,15	4	■
JS754160E3C.0Z4C-HXT	03186832	3	E	■	16,0	16,0	55,0	115,0	65,0	15,2	0,2	4	■
JS754200E3C.0Z4C-HXT	03186833	3	E	■	20,0	20,0	61,0	125,0	72,0	19,0	0,25	4	■

■ Stocked standard.

Universal

Steel and cast iron

Stainless steel and S-materials

Non ferrous

Hard

Plastic and CFRP

Graphite

X-Heads

Minimaster Plus

Minimaster

JS754

High performance – Square – ISO– M and ISO– S – 4 Flutes – Cylindrical – Chamfer – ICC

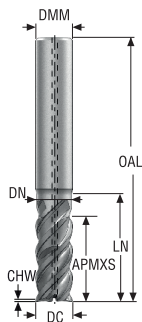

E



- Tolerances:
- DMM= h5
- DC= e7
- Regrind possible

Designation	Item number	Length index	Tool shape	ICC	DC	DMM	APMXS	OAL	LN	DN	CHW	PCEDC	Cylindrical
					mm	mm	mm	mm	mm	mm	mm		
JS754060E2C.0Z4A-HXT	03186834	2	E	■	6,0	6,0	12,0	57,0	18,0	5,7	0,075	4	■
JS754080E2C.0Z4A-HXT	03186835	2	E	■	8,0	8,0	16,0	63,0	25,0	7,6	0,1	4	■
JS754100E2C.0Z4A-HXT	03186836	2	E	■	10,0	10,0	20,0	72,0	29,0	9,5	0,125	4	■
JS754120E2C.0Z4A-HXT	03186837	2	E	■	12,0	12,0	24,0	83,0	35,0	11,4	0,15	4	■
JS754160E2C.0Z4A-HXT	03186838	2	E	■	16,0	16,0	32,0	92,0	42,0	15,2	0,2	4	■
JS754200E2C.0Z4A-HXT	03186839	2	E	■	20,0	20,0	40,0	104,0	51,0	19,0	0,25	4	■

■ Stocked standard.

Universal

Steel and cast iron

Stainless steel and S-materials

Non ferrous

Hard

Plastic and CFRP

Graphite

X-Heads

Minimaster Plus

Minimaster

JS754

High performance – Square – ISO– M and ISO– S – 4 Flutes – Cylindrical – Corner radius

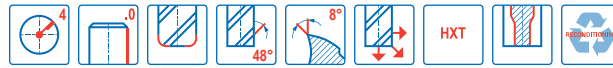
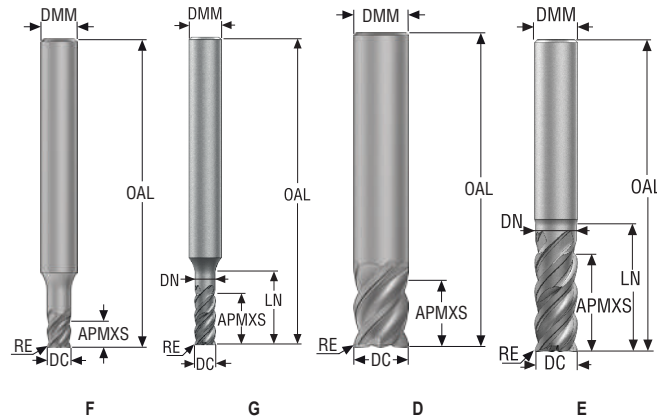

- Tolerances:
- DMM= h5
- DC= e7
- RE= ±0,02 mm
- Regrind possible if DC is ≥Ø6

Designation	Item number	Length index	Tool shape	DC	DMM	APMXS	OAL	LN	DN	RE	PCEDC	Cylindrical
				mm	mm	mm	mm	mm	mm	mm		
JS754030F1R020.0Z4-HXT	10165558	1	F	3,0	6,0	4,0	50,0	6,0	3,05	0,2	4	■
JS754040F1R020.0Z4-HXT	10164867	1	F	4,0	6,0	5,0	50,0	9,0	4,05	0,2	4	■
JS754050F1R020.0Z4-HXT	10165559	1	F	5,0	6,0	7,0	50,0	10,0	5,05	0,2	4	■
JS754060D1R020.0Z4-HXT	10164868	1	D	6,0	6,0	8,0	50,0	–	–	0,2	4	■
JS754060D1R050.0Z4-HXT	10164869	1	D	6,0	6,0	8,0	50,0	–	–	0,5	4	■
JS754080D1R050.0Z4-HXT	10164871	1	D	8,0	8,0	11,0	58,0	–	–	0,5	4	■
JS754100D1R050.0Z4-HXT	10164873	1	D	10,0	10,0	13,0	58,0	–	–	0,5	4	■
JS754100D1R100.0Z4-HXT	10164874	1	D	10,0	10,0	13,0	58,0	–	–	1,0	4	■
JS754120D1R050.0Z4-HXT	10164875	1	D	12,0	12,0	15,0	67,0	–	–	0,5	4	■
JS754120D1R100.0Z4-HXT	10164876	1	D	12,0	12,0	15,0	67,0	–	–	1,0	4	■
JS754160D1R050.0Z4-HXT	10164877	1	D	16,0	16,0	19,0	73,0	–	–	0,5	4	■
JS754160D1R100.0Z4-HXT	10164878	1	D	16,0	16,0	19,0	73,0	–	–	1,0	4	■
JS754030G2R020.0Z4-HXT	03186840	2	G	3,0	6,0	6,0	57,0	10,0	2,85	0,2	4	■
JS754040G2R020.0Z4-HXT	03186841	2	G	4,0	6,0	8,0	57,0	13,0	3,8	0,2	4	■
JS754050G2R020.0Z4-HXT	03186842	2	G	5,0	6,0	10,0	57,0	16,0	4,75	0,2	4	■
JS754060E2R020.0Z4-HXT	03186843	2	E	6,0	6,0	12,0	57,0	18,0	5,7	0,2	4	■
JS754060E2R050.0Z4-HXT	03186844	2	E	6,0	6,0	12,0	57,0	18,0	5,7	0,5	4	■
JS754060E2R100.0Z4-HXT	03186845	2	E	6,0	6,0	12,0	57,0	18,0	5,7	1,0	4	■
JS754080E2R050.0Z4-HXT	03186846	2	E	8,0	8,0	16,0	63,0	25,0	7,6	0,5	4	■
JS754080E2R100.0Z4-HXT	03186847	2	E	8,0	8,0	16,0	63,0	25,0	7,6	1,0	4	■
JS754100E2R050.0Z4-HXT	03186848	2	E	10,0	10,0	20,0	72,0	29,0	9,5	0,5	4	■
JS754100E2R100.0Z4-HXT	03186849	2	E	10,0	10,0	20,0	72,0	29,0	9,5	1,0	4	■
JS754100E2R150.0Z4-HXT	03200552	2	E	10,0	10,0	20,0	72,0	29,0	9,5	1,5	4	■
JS754100E2R200.0Z4-HXT	03186850	2	E	10,0	10,0	20,0	72,0	29,0	9,5	2,0	4	■
JS754100E2R300.0Z4-HXT	03186851	2	E	10,0	10,0	20,0	72,0	29,0	9,5	3,0	4	■
JS754120E2R050.0Z4-HXT	03186852	2	E	12,0	12,0	24,0	83,0	35,0	11,4	0,5	4	■
JS754120E2R100.0Z4-HXT	03186853	2	E	12,0	12,0	24,0	83,0	35,0	11,4	1,0	4	■
JS754120E2R150.0Z4-HXT	03200553	2	E	12,0	12,0	24,0	83,0	35,0	11,4	1,5	4	■
JS754120E2R200.0Z4-HXT	03186854	2	E	12,0	12,0	24,0	83,0	35,0	11,4	2,0	4	■
JS754120E2R300.0Z4-HXT	03186855	2	E	12,0	12,0	24,0	83,0	35,0	11,4	3,0	4	■
JS754160E2R050.0Z4-HXT	03186856	2	E	16,0	16,0	32,0	92,0	42,0	15,2	0,5	4	■
JS754160E2R100.0Z4-HXT	03186857	2	E	16,0	16,0	32,0	92,0	42,0	15,2	1,0	4	■
JS754160E2R200.0Z4-HXT	03186858	2	E	16,0	16,0	32,0	92,0	42,0	15,2	2,0	4	■

■ Stocked standard.

Universal

Steel and cast iron

Stainless steel and S-materials

Non ferrous

Hard

Plastic and CFRP

Graphite

X-Heads

Minimaster Plus

Minimaster

JS754

High performance – Square – ISO– M and ISO– S – 4 Flutes – Cylindrical – Corner radius

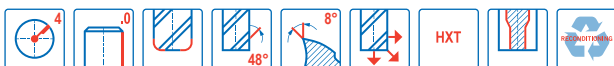
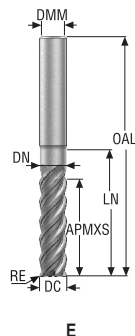

- Tolerances:
- DMM= h5
- DC= e7
- RE= ±0,02 mm
- Regrind possible

Designation	Item number	Length index	Tool shape	DC	DMM	APMXS	OAL	LN	DN	RE	PCEDC	Cylindrical
				mm	mm	mm	mm	mm	mm	mm		
JS754160E2R300.0Z4-HXT	03186859	2	E	16,0	16,0	32,0	92,0	42,0	15,2	3,0	4	■
JS754160E2R400.0Z4-HXT	03186860	2	E	16,0	16,0	32,0	92,0	42,0	15,2	4,0	4	■
JS754160E2R600.0Z4-HXT	03186861	2	E	16,0	16,0	32,0	92,0	42,0	15,2	6,0	4	■
JS754200E2R050.0Z4-HXT	03186862	2	E	20,0	20,0	40,0	104,0	51,0	19,0	0,5	4	■
JS754200E2R100.0Z4-HXT	03186863	2	E	20,0	20,0	40,0	104,0	51,0	19,0	1,0	4	■
JS754200E2R200.0Z4-HXT	03186864	2	E	20,0	20,0	40,0	104,0	51,0	19,0	2,0	4	■
JS754200E2R300.0Z4-HXT	03186865	2	E	20,0	20,0	40,0	104,0	51,0	19,0	3,0	4	■
JS754200E2R400.0Z4-HXT	03186866	2	E	20,0	20,0	40,0	104,0	51,0	19,0	4,0	4	■
JS754200E2R600.0Z4-HXT	03186867	2	E	20,0	20,0	40,0	104,0	51,0	19,0	6,0	4	■
JS754060E3R020.0Z4-HXT	03186873	3	E	6,0	6,0	21,0	65,0	26,0	5,7	0,2	4	■
JS754060E3R050.0Z4-HXT	03186874	3	E	6,0	6,0	21,0	65,0	26,0	5,7	0,5	4	■
JS754060E3R100.0Z4-HXT	03186875	3	E	6,0	6,0	21,0	65,0	26,0	5,7	1,0	4	■
JS754080E3R050.0Z4-HXT	03186876	3	E	8,0	8,0	32,0	75,0	37,0	7,6	0,5	4	■
JS754080E3R100.0Z4-HXT	03186877	3	E	8,0	8,0	32,0	75,0	37,0	7,6	1,0	4	■
JS754100E3R050.0Z4-HXT	03186878	3	E	10,0	10,0	40,0	89,0	47,0	9,5	0,5	4	■
JS754100E3R100.0Z4-HXT	03186879	3	E	10,0	10,0	40,0	89,0	47,0	9,5	1,0	4	■
JS754100E3R200.0Z4-HXT	03186880	3	E	10,0	10,0	40,0	89,0	47,0	9,5	2,0	4	■
JS754100E3R300.0Z4-HXT	03186881	3	E	10,0	10,0	40,0	89,0	47,0	9,5	3,0	4	■
JS754120E3R050.0Z4-HXT	03186882	3	E	12,0	12,0	45,0	100,0	53,0	11,4	0,5	4	■
JS754120E3R100.0Z4-HXT	03186883	3	E	12,0	12,0	45,0	100,0	53,0	11,4	1,0	4	■
JS754120E3R200.0Z4-HXT	03186884	3	E	12,0	12,0	45,0	100,0	53,0	11,4	2,0	4	■
JS754120E3R300.0Z4-HXT	03186885	3	E	12,0	12,0	45,0	100,0	53,0	11,4	3,0	4	■
JS754160E3R050.0Z4-HXT	03186886	3	E	16,0	16,0	55,0	115,0	65,0	15,2	0,5	4	■
JS754160E3R100.0Z4-HXT	03186887	3	E	16,0	16,0	55,0	115,0	65,0	15,2	1,0	4	■
JS754160E3R200.0Z4-HXT	03186888	3	E	16,0	16,0	55,0	115,0	65,0	15,2	2,0	4	■
JS754160E3R300.0Z4-HXT	03186889	3	E	16,0	16,0	55,0	115,0	65,0	15,2	3,0	4	■
JS754160E3R400.0Z4-HXT	03186890	3	E	16,0	16,0	55,0	115,0	65,0	15,2	4,0	4	■
JS754160E3R600.0Z4-HXT	03186891	3	E	16,0	16,0	55,0	115,0	65,0	15,2	6,0	4	■
JS754200E3R050.0Z4-HXT	03186892	3	E	20,0	20,0	61,0	125,0	72,0	19,0	0,5	4	■
JS754200E3R100.0Z4-HXT	03186893	3	E	20,0	20,0	61,0	125,0	72,0	19,0	1,0	4	■
JS754200E3R200.0Z4-HXT	03186894	3	E	20,0	20,0	61,0	125,0	72,0	19,0	2,0	4	■
JS754200E3R300.0Z4-HXT	03186895	3	E	20,0	20,0	61,0	125,0	72,0	19,0	3,0	4	■
JS754200E3R400.0Z4-HXT	03186896	3	E	20,0	20,0	61,0	125,0	72,0	19,0	4,0	4	■
JS754200E3R600.0Z4-HXT	03186897	3	E	20,0	20,0	61,0	125,0	72,0	19,0	6,0	4	■

■ Stocked standard.

Universal

Steel and cast iron

Stainless steel and S-materials

Non ferrous

Hard

Plastic and CFRP

Graphite

X-Heads

Minimaster Plus

Minimaster

JS754

High performance – Square – ISO– M and ISO– S – 4 Flutes – Weldon – Chamfer

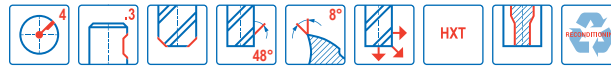
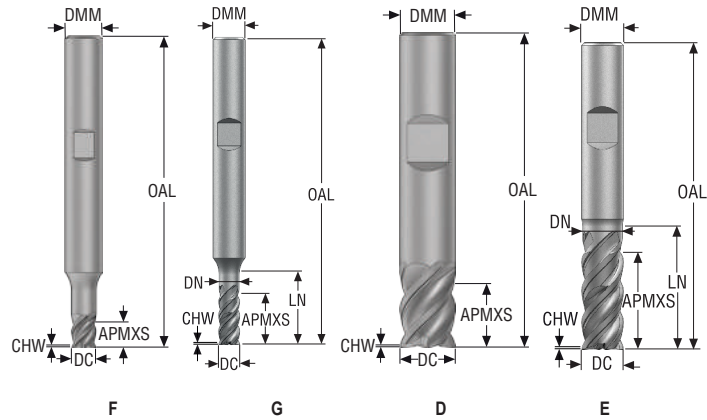

- Tolerances:
- DMM= h5
- DC= e7
- Regrind possible if DC is ≥ 06

Designation	Item number	Length index	Tool shape	DC	DMM	APMXS	OAL	LN	DN	CHW	PCEDC	Weldon
				mm	mm	mm	mm	mm	mm	mm		
JS754030F1C.3Z4-HXT	10165658	1	F	3,0	6,0	4,0	50,0	6,0	3,05	0,035	4	<input type="checkbox"/>
JS754040F1C.3Z4-HXT	10164861	1	F	4,0	6,0	5,0	50,0	9,0	4,05	0,045	4	<input type="checkbox"/>
JS754050F1C.3Z4-HXT	10165660	1	F	5,0	6,0	7,0	50,0	10,0	5,05	0,055	4	<input type="checkbox"/>
JS754060D1C.3Z4-HXT	10164862	1	D	6,0	6,0	8,0	50,0	–	–	0,075	4	<input type="checkbox"/>
JS754080D1C.3Z4-HXT	10164863	1	D	8,0	8,0	11,0	58,0	–	–	0,1	4	<input type="checkbox"/>
JS754100D1C.3Z4-HXT	10164864	1	D	10,0	10,0	13,0	58,0	–	–	0,125	4	<input type="checkbox"/>
JS754120D1C.3Z4-HXT	10164865	1	D	12,0	12,0	15,0	67,0	–	–	0,15	4	<input type="checkbox"/>
JS754160D1C.3Z4-HXT	10164866	1	D	16,0	16,0	19,0	73,0	–	–	0,2	4	<input type="checkbox"/>
JS754030G2C.3Z4-HXT	03186975	2	G	3,0	6,0	6,0	57,0	10,0	2,85	0,035	4	<input type="checkbox"/>
JS754040G2C.3Z4-HXT	03186976	2	G	4,0	6,0	8,0	57,0	13,0	3,8	0,045	4	<input type="checkbox"/>
JS754050G2C.3Z4-HXT	03186977	2	G	5,0	6,0	10,0	57,0	16,0	4,75	0,055	4	<input type="checkbox"/>
JS754060E2C.3Z4-HXT	03186978	2	E	6,0	6,0	12,0	57,0	18,0	5,7	0,075	4	<input checked="" type="checkbox"/>
JS754080E2C.3Z4-HXT	03186979	2	E	8,0	8,0	16,0	63,0	25,0	7,6	0,1	4	<input checked="" type="checkbox"/>
JS754100E2C.3Z4-HXT	03186980	2	E	10,0	10,0	20,0	72,0	29,0	9,5	0,125	4	<input checked="" type="checkbox"/>
JS754120E2C.3Z4-HXT	03186981	2	E	12,0	12,0	24,0	83,0	35,0	11,4	0,15	4	<input checked="" type="checkbox"/>
JS754160E2C.3Z4-HXT	03186982	2	E	16,0	16,0	32,0	92,0	42,0	15,2	0,2	4	<input checked="" type="checkbox"/>
JS754200E2C.3Z4-HXT	03186983	2	E	20,0	20,0	40,0	104,0	51,0	19,0	0,25	4	<input checked="" type="checkbox"/>
JS754250E2C.3Z4-HXT	03186984	2	E	25,0	25,0	50,0	121,0	65,0	23,8	0,3	4	<input checked="" type="checkbox"/>
JS754060E3C.3Z4-HXT	03186990	3	E	6,0	6,0	21,0	65,0	26,0	5,7	0,075	4	<input checked="" type="checkbox"/>
JS754080E3C.3Z4-HXT	03186991	3	E	8,0	8,0	32,0	75,0	37,0	7,6	0,1	4	<input checked="" type="checkbox"/>
JS754100E3C.3Z4-HXT	03186992	3	E	10,0	10,0	40,0	89,0	47,0	9,5	0,125	4	<input checked="" type="checkbox"/>
JS754120E3C.3Z4-HXT	03186993	3	E	12,0	12,0	45,0	100,0	53,0	11,4	0,15	4	<input checked="" type="checkbox"/>
JS754160E3C.3Z4-HXT	03186994	3	E	16,0	16,0	55,0	115,0	65,0	15,2	0,2	4	<input checked="" type="checkbox"/>
JS754200E3C.3Z4-HXT	03186995	3	E	20,0	20,0	61,0	125,0	72,0	19,0	0,25	4	<input checked="" type="checkbox"/>
JS754250E3C.3Z4-HXT	03186996	3	E	25,0	25,0	85,0	153,0	94,0	23,8	0,3	4	<input checked="" type="checkbox"/>

■ Stocked standard. □ Weldon available. Delivery time is 3 days.

Universal

Steel and cast iron

Stainless steel and S-materials

Non ferrous

Hard

Plastic and CFRP

Graphite

X-Heads

Minimaster Plus

Minimaster

JS754

High performance – Square – ISO– M and ISO– S – 4 Flutes – Weldon – Chamfer – Chip splitters

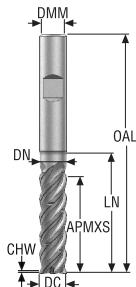

E



- Tolerances:
- DMM= h5
- DC= e7
- Chip splitters
- Regrind possible

Designation	Item number	Length index	Tool shape	Chip splitters	DC	DMM	APMXS	OAL	LN	DN	CHW	PCEDC	Weldon
					mm	mm	mm	mm	mm	mm	mm		
JS754100E2C.3Z4C-HXT	03186985	2	E	■	10,0	10,0	20,0	72,0	29,0	9,5	0,125	4	■
JS754120E2C.3Z4C-HXT	03186986	2	E	■	12,0	12,0	24,0	83,0	35,0	11,4	0,15	4	■
JS754060E3C.3Z4C-HXT	03200562	3	E	■	6,0	6,0	21,0	65,0	26,0	5,7	0,075	4	■
JS754080E3C.3Z4C-HXT	03200563	3	E	■	8,0	8,0	32,0	75,0	37,0	7,6	0,1	4	■
JS754100E3C.3Z4C-HXT	03186997	3	E	■	10,0	10,0	40,0	89,0	47,0	9,5	0,125	4	■
JS754120E3C.3Z4C-HXT	03186998	3	E	■	12,0	12,0	45,0	100,0	53,0	11,4	0,15	4	■
JS754160E3C.3Z4C-HXT	03186999	3	E	■	16,0	16,0	55,0	115,0	65,0	15,2	0,2	4	■
JS754200E3C.3Z4C-HXT	03187000	3	E	■	20,0	20,0	61,0	125,0	72,0	19,0	0,25	4	■

■ Stocked standard.

Universal

Steel and cast iron

Stainless steel and S-materials

Non ferrous

Hard

Plastic and CFRP

Graphite

X-Heads

Minimaster Plus

Minimaster

JS754

High performance – Square – ISO– M and ISO– S – 4 Flutes – Weldon – Chamfer – ICC

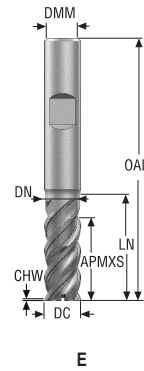

- Tolerances:
- DMM= h5
- DC= e7
- Regrind possible

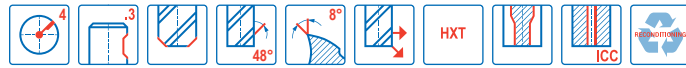

Designation	Item number	Length index	Tool shape	ICC	DC	DMM	APMXS	OAL	LN	DN	CHW	PCEDC	Weldon
					mm	mm	mm	mm	mm	mm	mm		
JS754060E2C.3Z4A-HXT	03187001	2	E	■	6,0	6,0	12,0	57,0	18,0	5,7	0,075	4	■
JS754080E2C.3Z4A-HXT	03187002	2	E	■	8,0	8,0	16,0	63,0	25,0	7,6	0,1	4	■
JS754100E2C.3Z4A-HXT	03187003	2	E	■	10,0	10,0	20,0	72,0	29,0	9,5	0,125	4	■
JS754120E2C.3Z4A-HXT	03187004	2	E	■	12,0	12,0	24,0	83,0	35,0	11,4	0,15	4	■
JS754160E2C.3Z4A-HXT	03187005	2	E	■	16,0	16,0	32,0	92,0	42,0	15,2	0,2	4	■
JS754200E2C.3Z4A-HXT	03187006	2	E	■	20,0	20,0	40,0	104,0	51,0	19,0	0,25	4	■

■ Stocked standard.

Universal
 Steel and cast iron
 Stainless steel and S-materials
 Non ferrous
 Hard
 Plastic and CFRP
 Graphite
 X-Heads
 Minimaster Plus
 Minimaster

JS754

High performance – Square – ISO– M and ISO– S – 4 Flutes – Weldon – Corner radius

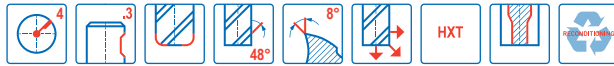
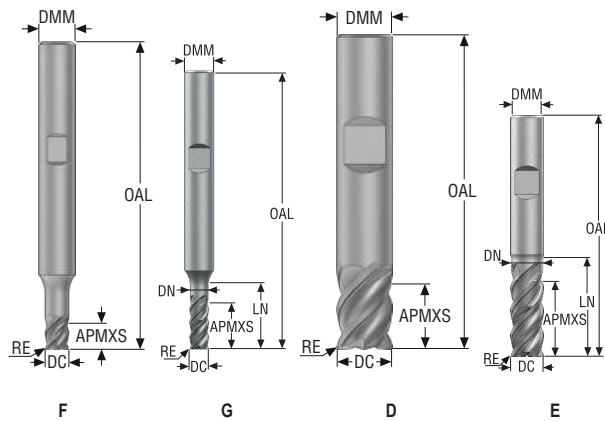

- Tolerances:
- DMM= h5
- DC= e7
- RE= ±0,02 mm
- Regrind possible if DC is ≥Ø6

Designation	Item number	Length index	Tool shape	DC	DMM	APMXS	OAL	LN	DN	RE	PCEDC	Weldon
				mm	mm	mm	mm	mm	mm	mm		
JS754030F1R020.3Z4-HXT	10165560	1	F	3,0	6,0	4,0	50,0	6,0	3,05	0,2	4	□
JS754040F1R020.3Z4-HXT	10164879	1	F	4,0	6,0	5,0	50,0	9,0	4,05	0,2	4	□
JS754050F1R020.3Z4-HXT	10165561	1	F	5,0	6,0	7,0	50,0	10,0	5,05	0,2	4	□
JS754060D1R020.3Z4-HXT	10164880	1	D	6,0	6,0	8,0	50,0	–	–	0,2	4	□
JS754060D1R050.3Z4-HXT	10164881	1	D	6,0	6,0	8,0	50,0	–	–	0,5	4	□
JS754080D1R050.3Z4-HXT	10164883	1	D	8,0	8,0	11,0	58,0	–	–	0,5	4	□
JS754100D1R050.3Z4-HXT	10164885	1	D	10,0	10,0	13,0	58,0	–	–	0,5	4	□
JS754100D1R100.3Z4-HXT	10164886	1	D	10,0	10,0	13,0	58,0	–	–	1,0	4	□
JS754120D1R050.3Z4-HXT	10164887	1	D	12,0	12,0	15,0	67,0	–	–	0,5	4	□
JS754120D1R100.3Z4-HXT	10164888	1	D	12,0	12,0	15,0	67,0	–	–	1,0	4	□
JS754160D1R050.3Z4-HXT	10164889	1	D	16,0	16,0	19,0	73,0	–	–	0,5	4	□
JS754160D1R100.3Z4-HXT	10164890	1	D	16,0	16,0	19,0	73,0	–	–	1,0	4	□
JS754030G2R020.3Z4-HXT	03187007	2	G	3,0	6,0	6,0	57,0	10,0	2,85	0,2	4	□
JS754040G2R020.3Z4-HXT	03187008	2	G	4,0	6,0	8,0	57,0	13,0	3,8	0,2	4	□
JS754050G2R020.3Z4-HXT	03187009	2	G	5,0	6,0	10,0	57,0	16,0	4,75	0,2	4	□
JS754060E2R020.3Z4-HXT	03187010	2	E	6,0	6,0	12,0	57,0	18,0	5,7	0,2	4	■
JS754060E2R050.3Z4-HXT	03187011	2	E	6,0	6,0	12,0	57,0	18,0	5,7	0,5	4	■
JS754060E2R100.3Z4-HXT	03187012	2	E	6,0	6,0	12,0	57,0	18,0	5,7	1,0	4	■
JS754080E2R050.3Z4-HXT	03187013	2	E	8,0	8,0	16,0	63,0	25,0	7,6	0,5	4	■
JS754080E2R100.3Z4-HXT	03187014	2	E	8,0	8,0	16,0	63,0	25,0	7,6	1,0	4	■
JS754100E2R050.3Z4-HXT	03187015	2	E	10,0	10,0	20,0	72,0	29,0	9,5	0,5	4	■
JS754100E2R100.3Z4-HXT	03187016	2	E	10,0	10,0	20,0	72,0	29,0	9,5	1,0	4	■
JS754100E2R150.3Z4-HXT	03200564	2	E	10,0	10,0	20,0	72,0	29,0	9,5	1,5	4	■
JS754100E2R200.3Z4-HXT	03187017	2	E	10,0	10,0	20,0	72,0	29,0	9,5	2,0	4	■
JS754100E2R300.3Z4-HXT	03187018	2	E	10,0	10,0	20,0	72,0	29,0	9,5	3,0	4	■
JS754120E2R050.3Z4-HXT	03187019	2	E	12,0	12,0	24,0	83,0	35,0	11,4	0,5	4	■
JS754120E2R100.3Z4-HXT	03187020	2	E	12,0	12,0	24,0	83,0	35,0	11,4	1,0	4	■
JS754120E2R150.3Z4-HXT	03200565	2	E	12,0	12,0	24,0	83,0	35,0	11,4	1,5	4	■
JS754120E2R200.3Z4-HXT	03187021	2	E	12,0	12,0	24,0	83,0	35,0	11,4	2,0	4	■
JS754120E2R300.3Z4-HXT	03187022	2	E	12,0	12,0	24,0	83,0	35,0	11,4	3,0	4	■
JS754160E2R050.3Z4-HXT	03187023	2	E	16,0	16,0	32,0	92,0	42,0	15,2	0,5	4	■
JS754160E2R100.3Z4-HXT	03187024	2	E	16,0	16,0	32,0	92,0	42,0	15,2	1,0	4	■
JS754160E2R200.3Z4-HXT	03187025	2	E	16,0	16,0	32,0	92,0	42,0	15,2	2,0	4	■
JS754160E2R300.3Z4-HXT	03187026	2	E	16,0	16,0	32,0	92,0	42,0	15,2	3,0	4	■
JS754160E2R400.3Z4-HXT	03187027	2	E	16,0	16,0	32,0	92,0	42,0	15,2	4,0	4	■
JS754160E2R600.3Z4-HXT	03187028	2	E	16,0	16,0	32,0	92,0	42,0	15,2	6,0	4	■

■ Stocked standard. □ Weldon available. Delivery time is 3 days.

Universal
Steel and cast iron
Stainless steel and S-materials
Non ferrous
Hard
Plastic and CFRP
Graphite
X-Heads
Minimaster Plus
Minimaster

JS754

High performance – Square – ISO– M and ISO– S – 4 Flutes – Weldon – Corner radius

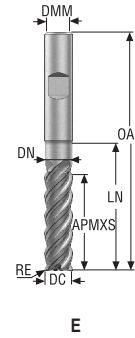

- Tolerances:
- DMM= h5
- DC= e7
- RE= ±0,02 mm
- Regrind possible

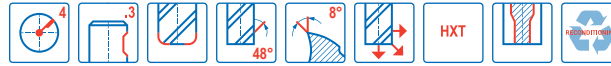

Designation	Item number	Length index	Tool shape	DC	DMM	APMXS	OAL	LN	DN	RE	PCEDC	Weldon
				mm	mm	mm	mm	mm	mm	mm		
JS754200E2R050.3Z4-HXT	03187029	2	E	20,0	20,0	40,0	104,0	51,0	19,0	0,5	4	■
JS754200E2R100.3Z4-HXT	03187030	2	E	20,0	20,0	40,0	104,0	51,0	19,0	1,0	4	■
JS754200E2R200.3Z4-HXT	03187031	2	E	20,0	20,0	40,0	104,0	51,0	19,0	2,0	4	■
JS754200E2R300.3Z4-HXT	03187032	2	E	20,0	20,0	40,0	104,0	51,0	19,0	3,0	4	■
JS754200E2R400.3Z4-HXT	03187033	2	E	20,0	20,0	40,0	104,0	51,0	19,0	4,0	4	■
JS754200E2R600.3Z4-HXT	03187034	2	E	20,0	20,0	40,0	104,0	51,0	19,0	6,0	4	■
JS754060E3R020.3Z4-HXT	03187040	3	E	6,0	6,0	21,0	65,0	26,0	5,7	0,2	4	□
JS754060E3R050.3Z4-HXT	03187041	3	E	6,0	6,0	21,0	65,0	26,0	5,7	0,5	4	□
JS754060E3R100.3Z4-HXT	03187042	3	E	6,0	6,0	21,0	65,0	26,0	5,7	1,0	4	□
JS754080E3R050.3Z4-HXT	03187043	3	E	8,0	8,0	32,0	75,0	37,0	7,6	0,5	4	□
JS754080E3R100.3Z4-HXT	03187044	3	E	8,0	8,0	32,0	75,0	37,0	7,6	1,0	4	□
JS754100E3R050.3Z4-HXT	03187045	3	E	10,0	10,0	40,0	89,0	47,0	9,5	0,5	4	□
JS754100E3R100.3Z4-HXT	03187046	3	E	10,0	10,0	40,0	89,0	47,0	9,5	1,0	4	□
JS754100E3R200.3Z4-HXT	03187047	3	E	10,0	10,0	40,0	89,0	47,0	9,5	2,0	4	□
JS754100E3R300.3Z4-HXT	03187049	3	E	10,0	10,0	40,0	89,0	47,0	9,5	3,0	4	□
JS754120E3R050.3Z4-HXT	03187050	3	E	12,0	12,0	45,0	100,0	53,0	11,4	0,5	4	□
JS754120E3R100.3Z4-HXT	03187051	3	E	12,0	12,0	45,0	100,0	53,0	11,4	1,0	4	□
JS754120E3R200.3Z4-HXT	03187052	3	E	12,0	12,0	45,0	100,0	53,0	11,4	2,0	4	□
JS754120E3R300.3Z4-HXT	03187053	3	E	12,0	12,0	45,0	100,0	53,0	11,4	3,0	4	□
JS754160E3R050.3Z4-HXT	03187054	3	E	16,0	16,0	55,0	115,0	65,0	15,2	0,5	4	□
JS754160E3R100.3Z4-HXT	03187055	3	E	16,0	16,0	55,0	115,0	65,0	15,2	1,0	4	□
JS754160E3R200.3Z4-HXT	03187056	3	E	16,0	16,0	55,0	115,0	65,0	15,2	2,0	4	□
JS754160E3R300.3Z4-HXT	03187057	3	E	16,0	16,0	55,0	115,0	65,0	15,2	3,0	4	□
JS754160E3R400.3Z4-HXT	03187058	3	E	16,0	16,0	55,0	115,0	65,0	15,2	4,0	4	□
JS754160E3R600.3Z4-HXT	03187059	3	E	16,0	16,0	55,0	115,0	65,0	15,2	6,0	4	□
JS754200E3R050.3Z4-HXT	03187060	3	E	20,0	20,0	61,0	125,0	72,0	19,0	0,5	4	□
JS754200E3R100.3Z4-HXT	03187061	3	E	20,0	20,0	61,0	125,0	72,0	19,0	1,0	4	□
JS754200E3R200.3Z4-HXT	03187062	3	E	20,0	20,0	61,0	125,0	72,0	19,0	2,0	4	□
JS754200E3R300.3Z4-HXT	03187063	3	E	20,0	20,0	61,0	125,0	72,0	19,0	3,0	4	□
JS754200E3R400.3Z4-HXT	03187064	3	E	20,0	20,0	61,0	125,0	72,0	19,0	4,0	4	□
JS754200E3R600.3Z4-HXT	03187065	3	E	20,0	20,0	61,0	125,0	72,0	19,0	6,0	4	□

□ Weldon available. Delivery time is 3 days.

Universal

Steel and cast iron

Stainless steel and S-materials

Non ferrous

Hard

Plastic and CFRP

Graphite

X-Heads

Minimaster Plus

Minimaster

JS754

High performance – Square – ISO– M and ISO– S – 4 Flutes – Safelock – Chamfer

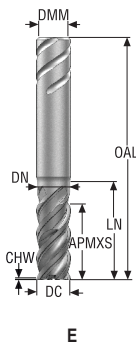

E

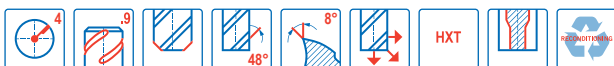

- Tolerances:
- DMM= h5
- DC= e7
- Regrind possible

Designation	Item number	Length index	Tool shape	DC	DMM	APMXS	OAL	LN	DN	CHW	PCEDC	Safelock
				mm	mm	mm	mm	mm	mm	mm		
JS754060E2C.9Z4-HXT	03187144	2	E	6,0	6,0	12,0	57,0	18,0	5,7	0,075	4	<input type="checkbox"/>
JS754080E2C.9Z4-HXT	03187145	2	E	8,0	8,0	16,0	63,0	25,0	7,6	0,1	4	<input type="checkbox"/>
JS754100E2C.9Z4-HXT	03187146	2	E	10,0	10,0	20,0	72,0	29,0	9,5	0,125	4	<input type="checkbox"/>
JS754120E2C.9Z4-HXT	03187147	2	E	12,0	12,0	24,0	83,0	35,0	11,4	0,15	4	<input type="checkbox"/>
JS754160E2C.9Z4-HXT	03187148	2	E	16,0	16,0	32,0	92,0	42,0	15,2	0,2	4	<input type="checkbox"/>
JS754200E2C.9Z4-HXT	03187149	2	E	20,0	20,0	40,0	104,0	51,0	19,0	0,25	4	<input type="checkbox"/>
JS754250E2C.9Z4-HXT	03187150	2	E	25,0	25,0	50,0	121,0	65,0	23,8	0,3	4	<input type="checkbox"/>
JS754060E3C.9Z4-HXT	03187153	3	E	6,0	6,0	21,0	65,0	26,0	5,7	0,075	4	<input type="checkbox"/>
JS754080E3C.9Z4-HXT	03187154	3	E	8,0	8,0	32,0	75,0	37,0	7,6	0,1	4	<input type="checkbox"/>
JS754100E3C.9Z4-HXT	03187155	3	E	10,0	10,0	40,0	89,0	47,0	9,5	0,125	4	<input type="checkbox"/>
JS754120E3C.9Z4-HXT	03187156	3	E	12,0	12,0	45,0	100,0	53,0	11,4	0,15	4	<input type="checkbox"/>
JS754160E3C.9Z4-HXT	03187157	3	E	16,0	16,0	55,0	115,0	65,0	15,2	0,2	4	<input type="checkbox"/>
JS754200E3C.9Z4-HXT	03187158	3	E	20,0	20,0	61,0	125,0	72,0	19,0	0,25	4	<input type="checkbox"/>
JS754250E3C.9Z4-HXT	03187159	3	E	25,0	25,0	85,0	153,0	94,0	23,8	0,3	4	<input type="checkbox"/>

Safelock available. Delivery time is 6 days.

Universal

Steel and cast iron

Stainless steel and S-materials

Non ferrous

Hard

Plastic and cfrp

Graphite

X-Heads

Minimaster Plus

Minimaster

JS754

High performance – Square – ISO– M and ISO– S – 4 Flutes – Safelock – Chamfer – Chip splitters

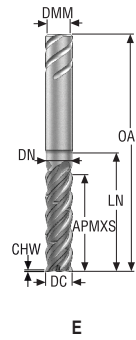

- Tolerances:
- DMM= h5
- DC= e7
- Chip splitters
- Regrind possible

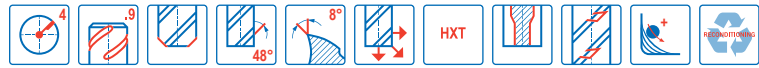

Designation	Item number	Length index	Tool shape	Chip splitters	DC	DMM	APMXS	OAL	LN	DN	CHW	PCEDC	Safelock
					mm	mm	mm	mm	mm	mm	mm		
JS754100E2C.9Z4C-HXT	03187151	2	E	■	10,0	10,0	20,0	72,0	29,0	9,5	0,125	4	<input type="checkbox"/>
JS754120E2C.9Z4C-HXT	03187152	2	E	■	12,0	12,0	24,0	83,0	35,0	11,4	0,15	4	<input type="checkbox"/>
JS754060E3C.9Z4C-HXT	03200571	3	E	■	6,0	6,0	21,0	65,0	26,0	5,7	0,075	4	<input type="checkbox"/>
JS754080E3C.9Z4C-HXT	03200572	3	E	■	8,0	8,0	32,0	75,0	37,0	7,6	0,1	4	<input type="checkbox"/>
JS754100E3C.9Z4C-HXT	03187160	3	E	■	10,0	10,0	40,0	89,0	47,0	9,5	0,125	4	<input type="checkbox"/>
JS754120E3C.9Z4C-HXT	03187161	3	E	■	12,0	12,0	45,0	100,0	53,0	11,4	0,15	4	<input type="checkbox"/>
JS754160E3C.9Z4C-HXT	03187162	3	E	■	16,0	16,0	55,0	115,0	65,0	15,2	0,2	4	<input type="checkbox"/>
JS754200E3C.9Z4C-HXT	03187163	3	E	■	20,0	20,0	61,0	125,0	72,0	19,0	0,25	4	<input type="checkbox"/>

Safelock available. Delivery time is 6 days.

Universal
Steel and cast iron
Stainless steel and S-materials
Non ferrous
Hard
Plastic and CFRP
Graphite
X-Heads
Minimaster Plus
Minimaster

JS754

High performance – Square – ISO– M and ISO– S – 4 Flutes – Safelock – Chamfer – ICC

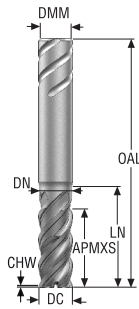

E

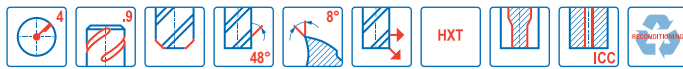

- Tolerances:
- DMM= h5
- DC= e7
- Regrind possible

Designation	Item number	Length index	Tool shape	ICC	DC	DMM	APMXS	OAL	LN	DN	CHW	PCEDC	Safelock
					mm	mm	mm	mm	mm	mm	mm		
JS754060E2C.9Z4A-HXT	03187164	2	E	■	6,0	6,0	12,0	57,0	18,0	5,7	0,075	4	<input type="checkbox"/>
JS754080E2C.9Z4A-HXT	03187165	2	E	■	8,0	8,0	16,0	63,0	25,0	7,6	0,1	4	<input type="checkbox"/>
JS754100E2C.9Z4A-HXT	03187166	2	E	■	10,0	10,0	20,0	72,0	29,0	9,5	0,125	4	<input type="checkbox"/>
JS754120E2C.9Z4A-HXT	03187167	2	E	■	12,0	12,0	24,0	83,0	35,0	11,4	0,15	4	<input type="checkbox"/>
JS754160E2C.9Z4A-HXT	03187168	2	E	■	16,0	16,0	32,0	92,0	42,0	15,2	0,2	4	<input type="checkbox"/>
JS754200E2C.9Z4A-HXT	03187169	2	E	■	20,0	20,0	40,0	104,0	51,0	19,0	0,25	4	<input type="checkbox"/>

Safelock available. Delivery time is 6 days.

Universal

Steel and cast iron

Stainless steel and S-materials

Non ferrous

Hard

Plastic and cfrp

Graphite

X-Heads

Minimaster Plus

Minimaster

JS754

High performance – Square – ISO– M and ISO– S – 4 Flutes – Safelock – Corner radius

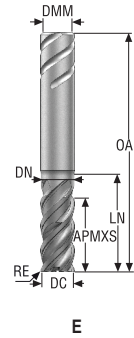

- Tolerances:
- DMM= h5
- DC= e7
- RE= ±0,02 mm
- Regrind possible

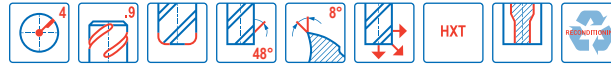

Designation	Item number	Length index	Tool shape	DC	DMM	APMXS	OAL	LN	DN	RE	PCEDC	Safelock
				mm	mm	mm	mm	mm	mm	mm		
JS754060E2R020.9Z4-HXT	03187170	2	E	6,0	6,0	12,0	57,0	18,0	5,7	0,2	4	<input type="checkbox"/>
JS754060E2R050.9Z4-HXT	03187171	2	E	6,0	6,0	12,0	57,0	18,0	5,7	0,5	4	<input type="checkbox"/>
JS754060E2R100.9Z4-HXT	03187172	2	E	6,0	6,0	12,0	57,0	18,0	5,7	1,0	4	<input type="checkbox"/>
JS754080E2R050.9Z4-HXT	03187173	2	E	8,0	8,0	16,0	63,0	25,0	7,6	0,5	4	<input type="checkbox"/>
JS754080E2R100.9Z4-HXT	03187174	2	E	8,0	8,0	16,0	63,0	25,0	7,6	1,0	4	<input type="checkbox"/>
JS754100E2R050.9Z4-HXT	03187175	2	E	10,0	10,0	20,0	72,0	29,0	9,5	0,5	4	<input type="checkbox"/>
JS754100E2R100.9Z4-HXT	03187176	2	E	10,0	10,0	20,0	72,0	29,0	9,5	1,0	4	<input type="checkbox"/>
JS754100E2R150.9Z4-HXT	03200573	2	E	10,0	10,0	20,0	72,0	29,0	9,5	1,5	4	<input type="checkbox"/>
JS754100E2R200.9Z4-HXT	03187177	2	E	10,0	10,0	20,0	72,0	29,0	9,5	2,0	4	<input type="checkbox"/>
JS754100E2R300.9Z4-HXT	03187178	2	E	10,0	10,0	20,0	72,0	29,0	9,5	3,0	4	<input type="checkbox"/>
JS754120E2R050.9Z4-HXT	03187179	2	E	12,0	12,0	24,0	83,0	35,0	11,4	0,5	4	<input type="checkbox"/>
JS754120E2R100.9Z4-HXT	03187180	2	E	12,0	12,0	24,0	83,0	35,0	11,4	1,0	4	<input type="checkbox"/>
JS754120E2R150.9Z4-HXT	03200832	2	E	12,0	12,0	24,0	83,0	35,0	11,4	1,5	4	<input type="checkbox"/>
JS754120E2R200.9Z4-HXT	03187181	2	E	12,0	12,0	24,0	83,0	35,0	11,4	2,0	4	<input type="checkbox"/>
JS754120E2R300.9Z4-HXT	03187182	2	E	12,0	12,0	24,0	83,0	35,0	11,4	3,0	4	<input type="checkbox"/>
JS754160E2R050.9Z4-HXT	03187183	2	E	16,0	16,0	32,0	92,0	42,0	15,2	0,5	4	<input type="checkbox"/>
JS754160E2R100.9Z4-HXT	03187184	2	E	16,0	16,0	32,0	92,0	42,0	15,2	1,0	4	<input type="checkbox"/>
JS754160E2R200.9Z4-HXT	03187185	2	E	16,0	16,0	32,0	92,0	42,0	15,2	2,0	4	<input type="checkbox"/>
JS754160E2R300.9Z4-HXT	03187186	2	E	16,0	16,0	32,0	92,0	42,0	15,2	3,0	4	<input type="checkbox"/>
JS754160E2R400.9Z4-HXT	03187187	2	E	16,0	16,0	32,0	92,0	42,0	15,2	4,0	4	<input type="checkbox"/>
JS754160E2R600.9Z4-HXT	03187188	2	E	16,0	16,0	32,0	92,0	42,0	15,2	6,0	4	<input type="checkbox"/>
JS754200E2R050.9Z4-HXT	03187189	2	E	20,0	20,0	40,0	104,0	51,0	19,0	0,5	4	<input type="checkbox"/>
JS754200E2R100.9Z4-HXT	03187190	2	E	20,0	20,0	40,0	104,0	51,0	19,0	1,0	4	<input type="checkbox"/>
JS754200E2R200.9Z4-HXT	03187191	2	E	20,0	20,0	40,0	104,0	51,0	19,0	2,0	4	<input type="checkbox"/>
JS754200E2R300.9Z4-HXT	03187192	2	E	20,0	20,0	40,0	104,0	51,0	19,0	3,0	4	<input type="checkbox"/>
JS754200E2R400.9Z4-HXT	03187193	2	E	20,0	20,0	40,0	104,0	51,0	19,0	4,0	4	<input type="checkbox"/>
JS754200E2R600.9Z4-HXT	03187194	2	E	20,0	20,0	40,0	104,0	51,0	19,0	6,0	4	<input type="checkbox"/>

Safelock available. Delivery time is 6 days.

Universal

Steel and cast iron

Stainless steel and S-materials

Non ferrous

Hard

Plastic and CFRP

Graphite

X-Heads

Minimaster Plus

Minimaster

JS754

High performance – Square – ISO– M and ISO– S – 4 Flutes – Safelock – Corner radius

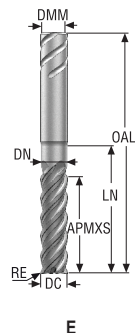

- Tolerances:
- DMM= h5
- DC= e7
- RE= ±0,02 mm
- Regrind possible

Designation	Item number	Length index	Tool shape	DC	DMM	APMXS	OAL	LN	DN	RE	PCEDC	Safelock
				mm	mm	mm	mm	mm	mm	mm		
JS754060E3R020.9Z4-HXT	03187197	3	E	6,0	6,0	21,0	65,0	26,0	5,7	0,2	4	<input type="checkbox"/>
JS754060E3R050.9Z4-HXT	03187198	3	E	6,0	6,0	21,0	65,0	26,0	5,7	0,5	4	<input type="checkbox"/>
JS754060E3R100.9Z4-HXT	03187199	3	E	6,0	6,0	21,0	65,0	26,0	5,7	1,0	4	<input type="checkbox"/>
JS754080E3R050.9Z4-HXT	03187200	3	E	8,0	8,0	32,0	75,0	37,0	7,6	0,5	4	<input type="checkbox"/>
JS754080E3R100.9Z4-HXT	03187201	3	E	8,0	8,0	32,0	75,0	37,0	7,6	1,0	4	<input type="checkbox"/>
JS754100E3R050.9Z4-HXT	03187202	3	E	10,0	10,0	40,0	89,0	47,0	9,5	0,5	4	<input type="checkbox"/>
JS754100E3R100.9Z4-HXT	03187203	3	E	10,0	10,0	40,0	89,0	47,0	9,5	1,0	4	<input type="checkbox"/>
JS754100E3R200.9Z4-HXT	03187204	3	E	10,0	10,0	40,0	89,0	47,0	9,5	2,0	4	<input type="checkbox"/>
JS754100E3R300.9Z4-HXT	03187205	3	E	10,0	10,0	40,0	89,0	47,0	9,5	3,0	4	<input type="checkbox"/>
JS754120E3R050.9Z4-HXT	03187206	3	E	12,0	12,0	45,0	100,0	53,0	11,4	0,5	4	<input type="checkbox"/>
JS754120E3R100.9Z4-HXT	03187207	3	E	12,0	12,0	45,0	100,0	53,0	11,4	1,0	4	<input type="checkbox"/>
JS754120E3R200.9Z4-HXT	03187208	3	E	12,0	12,0	45,0	100,0	53,0	11,4	2,0	4	<input type="checkbox"/>
JS754120E3R300.9Z4-HXT	03187209	3	E	12,0	12,0	45,0	100,0	53,0	11,4	3,0	4	<input type="checkbox"/>
JS754160E3R050.9Z4-HXT	03187210	3	E	16,0	16,0	55,0	115,0	65,0	15,2	0,5	4	<input type="checkbox"/>
JS754160E3R100.9Z4-HXT	03187211	3	E	16,0	16,0	55,0	115,0	65,0	15,2	1,0	4	<input type="checkbox"/>
JS754160E3R200.9Z4-HXT	03187212	3	E	16,0	16,0	55,0	115,0	65,0	15,2	2,0	4	<input type="checkbox"/>
JS754160E3R300.9Z4-HXT	03187213	3	E	16,0	16,0	55,0	115,0	65,0	15,2	3,0	4	<input type="checkbox"/>
JS754160E3R400.9Z4-HXT	03187214	3	E	16,0	16,0	55,0	115,0	65,0	15,2	4,0	4	<input type="checkbox"/>
JS754160E3R600.9Z4-HXT	03187215	3	E	16,0	16,0	55,0	115,0	65,0	15,2	6,0	4	<input type="checkbox"/>
JS754200E3R050.9Z4-HXT	03187216	3	E	20,0	20,0	61,0	125,0	72,0	19,0	0,5	4	<input type="checkbox"/>
JS754200E3R100.9Z4-HXT	03187217	3	E	20,0	20,0	61,0	125,0	72,0	19,0	1,0	4	<input type="checkbox"/>
JS754200E3R200.9Z4-HXT	03187218	3	E	20,0	20,0	61,0	125,0	72,0	19,0	2,0	4	<input type="checkbox"/>
JS754200E3R300.9Z4-HXT	03187219	3	E	20,0	20,0	61,0	125,0	72,0	19,0	3,0	4	<input type="checkbox"/>
JS754200E3R400.9Z4-HXT	03187220	3	E	20,0	20,0	61,0	125,0	72,0	19,0	4,0	4	<input type="checkbox"/>
JS754200E3R600.9Z4-HXT	03187221	3	E	20,0	20,0	61,0	125,0	72,0	19,0	6,0	4	<input type="checkbox"/>

Safelock available. Delivery time is 6 days.

Universal

Steel and cast iron

Stainless steel and S-materials

Non ferrous

Hard

Plastic and CFRP

Graphite

X-Heads

Minimaster Plus

Minimaster

Cutting data – JS754 Side milling roughing

SMG		a _e /DC	a _p /DC	f _z										v _c
				3	4	5	6	8	10	12	16	20	25	
P11	M/A/D/E	0.400	0.80	0.026	0.036	0.044	0.055	0.070	0.090	0.11	0.13	0.15	0.17	165 (130 – 180)
		0.400	0.80	0.0010	0.0014	0.0017	0.0022	0.0028	0.0036	0.0044	0.0050	0.0060	0.0065	540 (430 – 590)
P12	M/A/D/E	0.400	0.80	0.018	0.024	0.030	0.036	0.048	0.060	0.070	0.090	0.10	0.12	105 (83 – 120)
		0.400	0.80	0.00070	0.00095	0.0012	0.0014	0.0019	0.0024	0.0028	0.0036	0.0040	0.0048	345 (280 – 390)
M1	E	0.400	1.0	0.020	0.026	0.034	0.040	0.055	0.065	0.080	0.10	0.11	0.13	110 (96 – 130)
		0.400	1.0	0.00080	0.0010	0.0013	0.0016	0.0022	0.0026	0.0032	0.0040	0.0044	0.0050	360 (320 – 420)
M2	E	0.400	1.0	0.018	0.024	0.030	0.036	0.048	0.060	0.070	0.090	0.10	0.12	90 (79 – 110)
		0.400	1.0	0.00070	0.00095	0.0012	0.0014	0.0019	0.0024	0.0028	0.0036	0.0040	0.0048	295 (260 – 360)
M3	E	0.400	0.90	0.015	0.020	0.025	0.030	0.040	0.050	0.060	0.075	0.085	0.095	60 (44 – 76)
		0.400	0.90	0.00060	0.00080	0.0010	0.0012	0.0016	0.0020	0.0024	0.0030	0.0034	0.0038	195 (150 – 240)
M4	E	0.400	0.90	0.013	0.018	0.022	0.026	0.036	0.044	0.055	0.065	0.075	0.085	46 (34 – 59)
		0.400	0.90	0.00050	0.00070	0.00085	0.0010	0.0014	0.0017	0.0022	0.0026	0.0030	0.0034	150 (120 – 190)
M5	E	0.400	0.90	0.013	0.018	0.022	0.026	0.036	0.044	0.055	0.065	0.075	0.085	39 (29 – 49)
		0.400	0.90	0.00050	0.00070	0.00085	0.0010	0.0014	0.0017	0.0022	0.0026	0.0030	0.0034	130 (96 – 160)
S1	E	0.150	0.50	0.026	0.034	0.044	0.050	0.070	0.085	0.10	0.13	0.15	0.17	50 (26 – 68)
		0.150	0.50	0.0010	0.0013	0.0017	0.0020	0.0028	0.0034	0.0040	0.0050	0.0060	0.0065	165 (86 – 220)
S2	E	0.150	0.50	0.026	0.034	0.044	0.050	0.070	0.085	0.10	0.13	0.15	0.17	41 (21 – 55)
		0.150	0.50	0.0010	0.0013	0.0017	0.0020	0.0028	0.0034	0.0040	0.0050	0.0060	0.0065	135 (69 – 180)
S3	E	0.150	0.50	0.024	0.032	0.040	0.048	0.065	0.080	0.095	0.12	0.14	0.15	36 (19 – 48)
		0.150	0.50	0.00095	0.0013	0.0016	0.0019	0.0026	0.0032	0.0038	0.0048	0.0055	0.0060	120 (63 – 150)
S11	E	0.400	0.70	0.018	0.024	0.030	0.036	0.048	0.060	0.070	0.090	0.10	0.12	110 (73 – 140)
		0.400	0.70	0.00070	0.00095	0.0012	0.0014	0.0019	0.0024	0.0028	0.0036	0.0040	0.0048	360 (240 – 450)
S12	E	0.400	0.70	0.018	0.024	0.030	0.036	0.048	0.060	0.070	0.090	0.10	0.12	85 (56 – 110)
		0.400	0.70	0.00070	0.00095	0.0012	0.0014	0.0019	0.0024	0.0028	0.0036	0.0040	0.0048	280 (190 – 360)
S13	E	0.400	0.70	0.016	0.022	0.026	0.032	0.042	0.055	0.065	0.080	0.090	0.10	65 (44 – 87)
		0.400	0.70	0.00065	0.00085	0.0010	0.0013	0.0017	0.0022	0.0026	0.0032	0.0036	0.0040	215 (150 – 280)

Cutting data – JS754 Slot milling

SMG		a _p /DC	f _z										v _c
			3	4	5	6	8	10	12	16	20	25	
P11	M/A/D/E	0.80	0.015	0.020	0.025	0.030	0.040	0.050	0.060	0.080	0.10	0.13	150 (120 – 170)
		0.80	0.00060	0.00080	0.0010	0.0012	0.0016	0.0020	0.0024	0.0032	0.0040	0.0050	490 (400 – 550)
P12	M/A/D/E	0.80	0.015	0.020	0.025	0.030	0.040	0.050	0.060	0.080	0.10	0.11	90 (69 – 100)
		0.80	0.00060	0.00080	0.0010	0.0012	0.0016	0.0020	0.0024	0.0032	0.0040	0.0044	295 (230 – 320)
M1	E	0.80	0.012	0.016	0.020	0.024	0.032	0.040	0.048	0.065	0.080	0.10	95 (85 – 120)
		0.80	0.00048	0.00065	0.00080	0.00095	0.0013	0.0016	0.0019	0.0026	0.0032	0.0040	310 (280 – 390)
M2	E	0.80	0.012	0.016	0.020	0.024	0.032	0.040	0.048	0.065	0.080	0.10	80 (69 – 97)
		0.80	0.00048	0.00065	0.00080	0.00095	0.0013	0.0016	0.0019	0.0026	0.0032	0.0040	260 (230 – 310)
M3	E	0.60	0.0095	0.012	0.015	0.019	0.025	0.030	0.038	0.050	0.060	0.075	55 (39 – 67)
		0.60	0.00038	0.00048	0.00060	0.00075	0.0010	0.0012	0.0015	0.0020	0.0024	0.0030	180 (130 – 210)
M4	E	0.60	0.0095	0.012	0.015	0.019	0.025	0.030	0.038	0.050	0.060	0.075	40 (29 – 50)
		0.60	0.00038	0.00048	0.00060	0.00075	0.0010	0.0012	0.0015	0.0020	0.0024	0.0030	130 (96 – 160)
M5	E	0.60	0.0095	0.012	0.015	0.019	0.025	0.030	0.038	0.050	0.060	0.075	33 (25 – 42)
		0.60	0.00038	0.00048	0.00060	0.00075	0.0010	0.0012	0.0015	0.0020	0.0024	0.0030	110 (83 – 130)
S1	E	0.30	0.0095	0.012	0.015	0.019	0.025	0.030	0.038	0.050	0.060	0.075	41 (21 – 54)
		0.30	0.00038	0.00048	0.00060	0.00075	0.0010	0.0012	0.0015	0.0020	0.0024	0.0030	135 (69 – 170)
S2	E	0.30	0.0095	0.012	0.015	0.019	0.025	0.030	0.038	0.050	0.060	0.075	33 (17 – 43)
		0.30	0.00038	0.00048	0.00060	0.00075	0.0010	0.0012	0.0015	0.0020	0.0024	0.0030	110 (56 – 140)
S3	E	0.30	0.0095	0.012	0.015	0.019	0.025	0.030	0.038	0.050	0.060	0.075	28 (15 – 37)
		0.30	0.00038	0.00048	0.00060	0.00075	0.0010	0.0012	0.0015	0.0020	0.0024	0.0030	90 (50 – 120)
S11	E	0.50	0.012	0.016	0.020	0.025	0.032	0.042	0.050	0.065	0.080	0.10	95 (63 – 120)
		0.50	0.00048	0.00065	0.00080	0.0010	0.0013	0.0017	0.0020	0.0026	0.0032	0.0040	310 (210 – 390)
S12	E	0.50	0.012	0.016	0.020	0.025	0.032	0.042	0.050	0.065	0.080	0.10	70 (48 – 95)
		0.50	0.00048	0.00065	0.00080	0.0010	0.0013	0.0017	0.0020	0.0026	0.0032	0.0040	230 (160 – 310)
S13	E	0.50	0.012	0.016	0.020	0.025	0.032	0.042	0.050	0.065	0.080	0.10	55 (38 – 74)
		0.50	0.00048	0.00065	0.00080	0.0010	0.0013	0.0017	0.0020	0.0026	0.0032	0.0040	180 (130 – 240)

If radius exceeds 15% of value DC please reduce fz with 20%

For cutting data recalculations, see pages 556 - 563

SMG = Seco material group

Coolant = A=air D=dry E=emulsion M=mist spray

v_c = m/min (sf/min)

f_z = mm (in/tooth)

a_p = mm/DC (in/DC) = factor

a_e = mm/DC (in/DC) = factor

All cutting data are target values

Cutting data – JS754_2C Advanced roughing $a_p/DC=0,05-0,1$

SMG		a_e/DC	a_p/DC	f_z		v_c
				10	12	
P11	M/A/D/E	0.100	2.0	0.15	0.17	265 (220 – 290)
		0,100	2,0	0,0060	0,0065	870 (730 – 950)
P12	M/A/D/E	0.100	2.0	0.10	0.12	170 (150 – 190)
		0,100	2,0	0,0040	0,0048	560 (500 – 620)
M1	E	0.100	2.0	0.11	0.13	205 (180 – 230)
		0,100	2,0	0,0044	0,0050	670 (600 – 750)
M2	E	0.100	2.0	0.10	0.12	170 (150 – 190)
		0,100	2,0	0,0040	0,0048	560 (500 – 620)
M3	E	0.100	2.0	0.10	0.12	130 (120 – 150)
		0,100	2,0	0,0040	0,0048	425 (400 – 490)
M4	E	0.100	2.0	0.085	0.10	100 (86 – 110)
		0,100	2,0	0,0034	0,0040	330 (290 – 360)
M5	E	0.100	2.0	0.085	0.10	85 (72 – 96)
		0,100	2,0	0,0034	0,0040	280 (240 – 310)
S1	E	0.0500	2.0	0.085	0.10	70 (43 – 99)
		0,0500	2,0	0,0034	0,0040	230 (150 – 320)
S2	E	0.0500	2.0	0.085	0.10	60 (35 – 80)
		0,0500	2,0	0,0034	0,0040	195 (120 – 260)
S3	E	0.0500	2.0	0.080	0.095	50 (31 – 70)
		0,0500	2,0	0,0032	0,0038	165 (110 – 220)
S11	E	0.0800	2.0	0.070	0.085	165 (140 – 190)
		0,0800	2,0	0,0028	0,0034	540 (460 – 620)
S12	E	0.0800	2.0	0.070	0.085	125 (110 – 150)
		0,0800	2,0	0,0028	0,0034	410 (370 – 490)
S13	E	0.0800	2.0	0.060	0.070	100 (84 – 110)
		0,0800	2,0	0,0024	0,0028	330 (280 – 360)

Cutting data – JS754_3C Advanced roughing $a_p/DC=0,05-0,1$

SMG		a_e/DC	a_p/DC	f_z						v_c
				6	8	10	12	16	20	
P11	M/A/D/E	0.100	4.0	0.090	0.12	0.15	0.17	0.22	0.25	265 (220 – 290)
		0,100	4,0	0,0036	0,0048	0,0060	0,0065	0,0085	0,010	870 (730 – 950)
P12	M/A/D/E	0.100	4.0	0.060	0.080	0.10	0.12	0.15	0.17	170 (140 – 180)
		0,100	4,0	0,0024	0,0032	0,0040	0,0048	0,0060	0,0065	560 (460 – 590)
M1	E	0.100	4.0	0.065	0.090	0.11	0.13	0.16	0.19	205 (170 – 230)
		0,100	4,0	0,0026	0,0036	0,0044	0,0050	0,0065	0,0075	670 (560 – 750)
M2	E	0.100	4.0	0.060	0.080	0.10	0.12	0.15	0.17	170 (140 – 190)
		0,100	4,0	0,0024	0,0032	0,0040	0,0048	0,0060	0,0065	560 (460 – 620)
M3	E	0.100	4.0	0.060	0.080	0.10	0.12	0.15	0.17	130 (110 – 150)
		0,100	4,0	0,0024	0,0032	0,0040	0,0048	0,0060	0,0065	425 (370 – 490)
M4	E	0.100	4.0	0.050	0.070	0.085	0.10	0.13	0.15	100 (86 – 110)
		0,100	4,0	0,0020	0,0028	0,0034	0,0040	0,0050	0,0060	330 (290 – 360)
M5	E	0.100	4.0	0.050	0.070	0.085	0.10	0.13	0.15	85 (72 – 96)
		0,100	4,0	0,0020	0,0028	0,0034	0,0040	0,0050	0,0060	280 (240 – 310)
S1	E	0.0500	4.0	0.050	0.070	0.085	0.10	0.13	0.15	70 (43 – 99)
		0,0500	4,0	0,0020	0,0028	0,0034	0,0040	0,0050	0,0060	230 (150 – 320)
S2	E	0.0500	4.0	0.050	0.070	0.085	0.10	0.13	0.15	55 (35 – 80)
		0,0500	4,0	0,0020	0,0028	0,0034	0,0040	0,0050	0,0060	180 (120 – 260)
S3	E	0.0500	4.0	0.048	0.065	0.080	0.095	0.12	0.14	50 (30 – 70)
		0,0500	4,0	0,0019	0,0026	0,0032	0,0038	0,0048	0,0055	165 (99 – 220)
S11	E	0.0800	4.0	0.042	0.055	0.070	0.085	0.10	0.12	165 (140 – 190)
		0,0800	4,0	0,0017	0,0022	0,0028	0,0034	0,0040	0,0048	540 (460 – 620)
S12	E	0.0800	4.0	0.042	0.055	0.070	0.085	0.10	0.12	125 (110 – 150)
		0,0800	4,0	0,0017	0,0022	0,0028	0,0034	0,0040	0,0048	410 (370 – 490)
S13	E	0.0800	4.0	0.036	0.048	0.060	0.070	0.090	0.10	100 (84 – 110)
		0,0800	4,0	0,0014	0,0019	0,0024	0,0028	0,0036	0,0040	330 (280 – 360)

If radius exceeds 15% of value DC please reduce fz with 20%

For cutting data recalculations, see pages 556 - 563

SMG = Seco material group
Coolant = A=air D=dry E=emulsion M=mist spray
 v_c = m/min (sf/min)
 f_z = mm (in/tooth)
 a_p = mm/DC (in/DC) = factor
 a_e = mm/DC (in/DC) = factor
All cutting data are target values

JS755

High performance – Square – ISO– M and ISO– S – 5 Flutes – Cylindrical – Chamfer

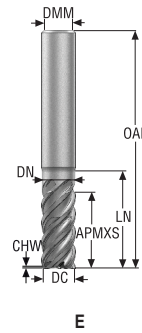

- Tolerances:
- DMM= h5
- DC= e7
- Regrind possible

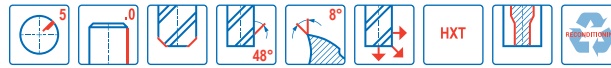

Designation	Item number	Length index	Tool shape	DC	DMM	APMXS	OAL	LN	DN	CHW	PCEDC	Cylindrical
				mm	mm	mm	mm	mm	mm	mm		
JS755060E2C.0Z5-HXT	03186907	2	E	6,0	6,0	12,0	57,0	18,0	5,7	0,075	5	■
JS755080E2C.0Z5-HXT	03186908	2	E	8,0	8,0	16,0	63,0	25,0	7,6	0,1	5	■
JS755100E2C.0Z5-HXT	03186909	2	E	10,0	10,0	20,0	72,0	29,0	9,5	0,125	5	■
JS755120E2C.0Z5-HXT	03186910	2	E	12,0	12,0	24,0	83,0	35,0	11,4	0,15	5	■
JS755160E2C.0Z5-HXT	03186911	2	E	16,0	16,0	32,0	92,0	42,0	15,2	0,2	5	■
JS755200E2C.0Z5-HXT	03186912	2	E	20,0	20,0	40,0	104,0	51,0	19,0	0,25	5	■
JS755250E2C.0Z5-HXT	03186913	2	E	25,0	25,0	50,0	121,0	65,0	23,8	0,3	5	■
JS755060E3C.0Z5-HXT	03186914	3	E	6,0	6,0	21,0	65,0	26,0	5,7	0,075	5	■
JS755080E3C.0Z5-HXT	03186915	3	E	8,0	8,0	32,0	75,0	37,0	7,6	0,1	5	■
JS755100E3C.0Z5-HXT	03186916	3	E	10,0	10,0	40,0	89,0	47,0	9,5	0,125	5	■
JS755120E3C.0Z5-HXT	03186917	3	E	12,0	12,0	45,0	100,0	53,0	11,4	0,15	5	■
JS755160E3C.0Z5-HXT	03186918	3	E	16,0	16,0	55,0	115,0	65,0	15,2	0,2	5	■
JS755200E3C.0Z5-HXT	03186919	3	E	20,0	20,0	61,0	125,0	72,0	19,0	0,25	5	■
JS755250E3C.0Z5-HXT	03186920	3	E	25,0	25,0	85,0	153,0	94,0	23,8	0,3	5	■

■ Stocked standard.

Universal

Steel and cast iron

Stainless steel and S-materials

Non ferrous

Hard

Plastic and CFRP

Graphite

X-Heads

Minimaster Plus

Minimaster

JS755

High performance - Square – ISO– M and ISO– S – 5 Flutes – Cylindrical – Chamfer – Chip splitters

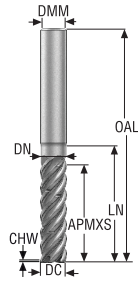

E

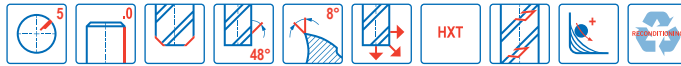

- Tolerances:
- DMM= h5
- DC= e7
- Chip splitters
- Regrind possible

Designation	Item number	Length index	Tool shape	Chip splitters	DC	DMM	APMXS	OAL	LN	DN	CHW	PCEDC	Cylindrical
					mm	mm	mm	mm	mm	mm	mm		
JS755100E3C.0Z5C-HXT	03186921	3	E	■	10,0	10,0	40,0	89,0	47,0	9,5	0,125	5	■
JS755120E3C.0Z5C-HXT	03186922	3	E	■	12,0	12,0	45,0	100,0	53,0	11,4	0,15	5	■
JS755160E3C.0Z5C-HXT	03186923	3	E	■	16,0	16,0	55,0	115,0	65,0	15,2	0,2	5	■
JS755200E3C.0Z5C-HXT	03186924	3	E	■	20,0	20,0	61,0	125,0	72,0	19,0	0,25	5	■

■ Stocked standard.

Universal

Steel and cast iron

Stainless steel and S-materials

Non ferrous

Hard

Plastic and cfrp

Graphite

X-Heads

Minimaster Plus

Minimaster

JS755

High performance – Square – ISO– M and ISO– S – 5 Flutes – Cylindrical – Corner radius

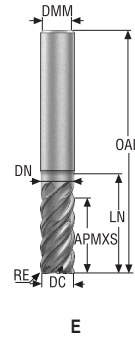

- Tolerances:
- DMM= h5
- DC= e7
- RE= ±0,02 mm
- Regrind possible

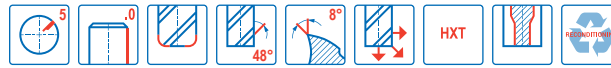

Designation	Item number	Length index	Tool shape	DC	DMM	APMXS	OAL	LN	DN	RE	PCEDC	Cylindrical
				mm	mm	mm	mm	mm	mm	mm		
JS755060E2R020.0Z5-HXT	03186925	2	E	6,0	6,0	12,0	57,0	18,0	5,7	0,2	5	■
JS755060E2R050.0Z5-HXT	03186926	2	E	6,0	6,0	12,0	57,0	18,0	5,7	0,5	5	■
JS755060E2R100.0Z5-HXT	03186927	2	E	6,0	6,0	12,0	57,0	18,0	5,7	1,0	5	■
JS755080E2R050.0Z5-HXT	03186928	2	E	8,0	8,0	16,0	63,0	25,0	7,6	0,5	5	■
JS755080E2R100.0Z5-HXT	03186929	2	E	8,0	8,0	16,0	63,0	25,0	7,6	1,0	5	■
JS755100E2R050.0Z5-HXT	03186930	2	E	10,0	10,0	20,0	72,0	29,0	9,5	0,5	5	■
JS755100E2R100.0Z5-HXT	03186931	2	E	10,0	10,0	20,0	72,0	29,0	9,5	1,0	5	■
JS755100E2R200.0Z5-HXT	03186932	2	E	10,0	10,0	20,0	72,0	29,0	9,5	2,0	5	■
JS755100E2R300.0Z5-HXT	03186933	2	E	10,0	10,0	20,0	72,0	29,0	9,5	3,0	5	■
JS755120E2R050.0Z5-HXT	03186934	2	E	12,0	12,0	24,0	83,0	35,0	11,4	0,5	5	■
JS755120E2R100.0Z5-HXT	03186935	2	E	12,0	12,0	24,0	83,0	35,0	11,4	1,0	5	■
JS755120E2R200.0Z5-HXT	03186936	2	E	12,0	12,0	24,0	83,0	35,0	11,4	2,0	5	■
JS755120E2R300.0Z5-HXT	03186937	2	E	12,0	12,0	24,0	83,0	35,0	11,4	3,0	5	■
JS755160E2R050.0Z5-HXT	03186938	2	E	16,0	16,0	32,0	92,0	42,0	15,2	0,5	5	■
JS755160E2R100.0Z5-HXT	03186939	2	E	16,0	16,0	32,0	92,0	42,0	15,2	1,0	5	■
JS755160E2R600.0Z5-HXT	03186940	2	E	16,0	16,0	32,0	92,0	42,0	15,2	6,0	5	■
JS755200E2R050.0Z5-HXT	03186941	2	E	20,0	20,0	40,0	104,0	51,0	19,0	0,5	5	■
JS755200E2R100.0Z5-HXT	03186942	2	E	20,0	20,0	40,0	104,0	51,0	19,0	1,0	5	■
JS755200E2R600.0Z5-HXT	03186943	2	E	20,0	20,0	40,0	104,0	51,0	19,0	6,0	5	■

■ Stocked standard.

Universal

Steel and cast iron

Stainless steel and S-materials

Non ferrous

Hard

Plastic and CFRP

Graphite

X-Heads

Minimaster Plus

Minimaster

JS755

High performance – Square – ISO– M and ISO– S – 5 Flutes – Cylindrical – Corner radius

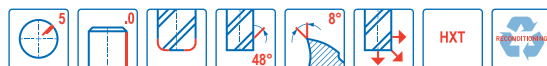
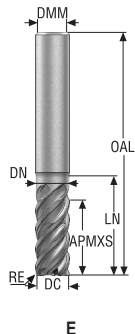

- Tolerances:
- DMM= h5
- DC= e7
- RE= ±0,02 mm
- Regrind possible

Designation	Item number	Length index	Tool shape	DC	DMM	APMXS	OAL	LN	DN	RE	PCEDC	Cylindrical
				mm	mm	mm	mm	mm	mm	mm		
JS755060E3R020.0Z5-HXT	03186946	3	E	6,0	6,0	21,0	65,0	26,0	5,7	0,2	5	■
JS755060E3R050.0Z5-HXT	03186947	3	E	6,0	6,0	21,0	65,0	26,0	5,7	0,5	5	■
JS755060E3R100.0Z5-HXT	03186948	3	E	6,0	6,0	21,0	65,0	26,0	5,7	1,0	5	■
JS755080E3R050.0Z5-HXT	03186949	3	E	8,0	8,0	32,0	75,0	37,0	7,6	0,5	5	■
JS755080E3R100.0Z5-HXT	03186950	3	E	8,0	8,0	32,0	75,0	37,0	7,6	1,0	5	■
JS755100E3R050.0Z5-HXT	03186951	3	E	10,0	10,0	40,0	89,0	47,0	9,5	0,5	5	■
JS755100E3R100.0Z5-HXT	03186952	3	E	10,0	10,0	40,0	89,0	47,0	9,5	1,0	5	■
JS755100E3R200.0Z5-HXT	03186953	3	E	10,0	10,0	40,0	89,0	47,0	9,5	2,0	5	■
JS755100E3R300.0Z5-HXT	03186954	3	E	10,0	10,0	40,0	89,0	47,0	9,5	3,0	5	■
JS755120E3R050.0Z5-HXT	03186955	3	E	12,0	12,0	45,0	100,0	53,0	11,4	0,5	5	■
JS755120E3R100.0Z5-HXT	03186956	3	E	12,0	12,0	45,0	100,0	53,0	11,4	1,0	5	■
JS755120E3R200.0Z5-HXT	03186957	3	E	12,0	12,0	45,0	100,0	53,0	11,4	2,0	5	■
JS755120E3R300.0Z5-HXT	03186958	3	E	12,0	12,0	45,0	100,0	53,0	11,4	3,0	5	■
JS755160E3R050.0Z5-HXT	03186959	3	E	16,0	16,0	55,0	115,0	65,0	15,2	0,5	5	■
JS755160E3R600.0Z5-HXT	03186960	3	E	16,0	16,0	55,0	115,0	65,0	15,2	6,0	5	■
JS755200E3R050.0Z5-HXT	03186961	3	E	20,0	20,0	61,0	125,0	72,0	19,0	0,5	5	■
JS755200E3R600.0Z5-HXT	03186962	3	E	20,0	20,0	61,0	125,0	72,0	19,0	6,0	5	■

■ Stocked standard.

Universal

Steel and cast iron

Stainless steel and S-materials

Non ferrous

Hard

Plastic and cfrp

Graphite

X-Heads

Minimaster Plus

Minimaster

JS755

High performance – Square – ISO– M and ISO– S – 5 Flutes – Weldon – Chamfer

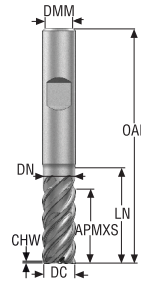

E

- Tolerances:
- DMM= h5
- DC= e7
- Regrind possible

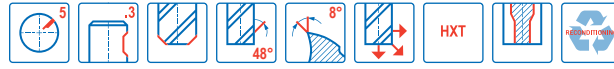

Designation	Item number	Length index	Tool shape	DC	DMM	APMXS	OAL	LN	DN	CHW	PCEDC	Weldon
				mm	mm	mm	mm	mm	mm	mm		
JS755060E2C.3Z5-HXT	03187083	2	E	6,0	6,0	12,0	57,0	18,0	5,7	0,075	5	■
JS755080E2C.3Z5-HXT	03187084	2	E	8,0	8,0	16,0	63,0	25,0	7,6	0,1	5	■
JS755100E2C.3Z5-HXT	03187085	2	E	10,0	10,0	20,0	72,0	29,0	9,5	0,125	5	■
JS755120E2C.3Z5-HXT	03187086	2	E	12,0	12,0	24,0	83,0	35,0	11,4	0,15	5	■
JS755160E2C.3Z5-HXT	03187087	2	E	16,0	16,0	32,0	92,0	42,0	15,2	0,2	5	■
JS755200E2C.3Z5-HXT	03187088	2	E	20,0	20,0	40,0	104,0	51,0	19,0	0,25	5	■
JS755250E2C.3Z5-HXT	03187089	2	E	25,0	25,0	50,0	121,0	65,0	23,8	0,3	5	■
JS755060E3C.3Z5-HXT	03187090	3	E	6,0	6,0	21,0	65,0	26,0	5,7	0,075	5	■
JS755080E3C.3Z5-HXT	03187091	3	E	8,0	8,0	32,0	75,0	37,0	7,6	0,1	5	■
JS755100E3C.3Z5-HXT	03187092	3	E	10,0	10,0	40,0	89,0	47,0	9,5	0,125	5	■
JS755120E3C.3Z5-HXT	03187093	3	E	12,0	12,0	45,0	100,0	53,0	11,4	0,15	5	■
JS755160E3C.3Z5-HXT	03187094	3	E	16,0	16,0	55,0	115,0	65,0	15,2	0,2	5	■
JS755200E3C.3Z5-HXT	03187095	3	E	20,0	20,0	61,0	125,0	72,0	19,0	0,25	5	■
JS755250E3C.3Z5-HXT	03187096	3	E	25,0	25,0	85,0	153,0	94,0	23,8	0,3	5	■

■ Stocked standard.

Universal

Steel and cast iron

Stainless steel and S-materials

Non ferrous

Hard

Plastic and CFRP

Graphite

X-Heads

Minimaster Plus

Minimaster

JS755

High performance – Square – ISO– M and ISO– S – 5 Flutes – Weldon – Chamfer – Chip splitters

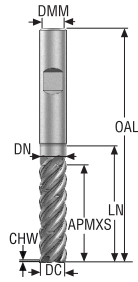

E



- Tolerances:
- DMM= h5
- DC= e7
- Chip splitters
- Regrind possible

Designation	Item number	Length index	Tool shape	Chip splitters	DC	DMM	APMXS	OAL	LN	DN	CHW	PCEDC	Weldon
					mm	mm	mm	mm	mm	mm	mm		
JS755100E3C.3Z5C-HXT	03187097	3	E	■	10,0	10,0	40,0	89,0	47,0	9,5	0,125	5	■
JS755120E3C.3Z5C-HXT	03187098	3	E	■	12,0	12,0	45,0	100,0	53,0	11,4	0,15	5	■
JS755160E3C.3Z5C-HXT	03187099	3	E	■	16,0	16,0	55,0	115,0	65,0	15,2	0,2	5	■
JS755200E3C.3Z5C-HXT	03187100	3	E	■	20,0	20,0	61,0	125,0	72,0	19,0	0,25	5	■

■ Stocked standard.

Universal

Steel and cast iron

Stainless steel and S-materials

Non ferrous

Hard

Plastic and CFRP

Graphite

X-Heads

Minimaster Plus

Minimaster

JS755

High performance – Square – ISO– M and ISO– S – 5 Flutes – Weldon – Corner radius

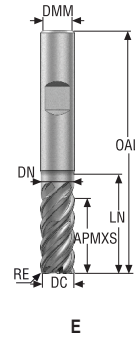

- Tolerances:
- DMM= h5
- DC= e7
- RE= ±0,02 mm
- Regrind possible

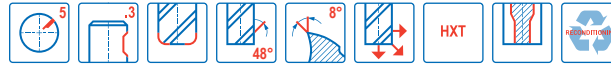

Designation	Item number	Length index	Tool shape	DC	DMM	APMXS	OAL	LN	DN	RE	PCEDC	Weldon
				mm	mm	mm	mm	mm	mm	mm		
JS755060E2R020.3Z5-HXT	03187101	2	E	6,0	6,0	12,0	57,0	18,0	5,7	0,2	5	■
JS755060E2R050.3Z5-HXT	03187102	2	E	6,0	6,0	12,0	57,0	18,0	5,7	0,5	5	■
JS755060E2R100.3Z5-HXT	03187103	2	E	6,0	6,0	12,0	57,0	18,0	5,7	1,0	5	■
JS755080E2R050.3Z5-HXT	03187104	2	E	8,0	8,0	16,0	63,0	25,0	7,6	0,5	5	■
JS755080E2R100.3Z5-HXT	03187105	2	E	8,0	8,0	16,0	63,0	25,0	7,6	1,0	5	■
JS755100E2R050.3Z5-HXT	03187106	2	E	10,0	10,0	20,0	72,0	29,0	9,5	0,5	5	■
JS755100E2R100.3Z5-HXT	03187107	2	E	10,0	10,0	20,0	72,0	29,0	9,5	1,0	5	■
JS755100E2R200.3Z5-HXT	03187108	2	E	10,0	10,0	20,0	72,0	29,0	9,5	2,0	5	■
JS755100E2R300.3Z5-HXT	03187109	2	E	10,0	10,0	20,0	72,0	29,0	9,5	3,0	5	■
JS755120E2R050.3Z5-HXT	03187110	2	E	12,0	12,0	24,0	83,0	35,0	11,4	0,5	5	■
JS755120E2R100.3Z5-HXT	03187111	2	E	12,0	12,0	24,0	83,0	35,0	11,4	1,0	5	■
JS755120E2R200.3Z5-HXT	03187112	2	E	12,0	12,0	24,0	83,0	35,0	11,4	2,0	5	■
JS755120E2R300.3Z5-HXT	03187113	2	E	12,0	12,0	24,0	83,0	35,0	11,4	3,0	5	■
JS755160E2R050.3Z5-HXT	03187114	2	E	16,0	16,0	32,0	92,0	42,0	15,2	0,5	5	■
JS755160E2R100.3Z5-HXT	03187115	2	E	16,0	16,0	32,0	92,0	42,0	15,2	1,0	5	■
JS755160E2R600.3Z5-HXT	03187116	2	E	16,0	16,0	32,0	92,0	42,0	15,2	6,0	5	■
JS755200E2R050.3Z5-HXT	03187117	2	E	20,0	20,0	40,0	104,0	51,0	19,0	0,5	5	■
JS755200E2R100.3Z5-HXT	03187118	2	E	20,0	20,0	40,0	104,0	51,0	19,0	1,0	5	■
JS755200E2R600.3Z5-HXT	03187119	2	E	20,0	20,0	40,0	104,0	51,0	19,0	6,0	5	■
JS755060E3R020.3Z5-HXT	03187122	3	E	6,0	6,0	21,0	65,0	26,0	5,7	0,2	5	□
JS755060E3R050.3Z5-HXT	03187123	3	E	6,0	6,0	21,0	65,0	26,0	5,7	0,5	5	□
JS755060E3R100.3Z5-HXT	03187124	3	E	6,0	6,0	21,0	65,0	26,0	5,7	1,0	5	□
JS755080E3R050.3Z5-HXT	03187125	3	E	8,0	8,0	32,0	75,0	37,0	7,6	0,5	5	□
JS755080E3R100.3Z5-HXT	03187126	3	E	8,0	8,0	32,0	75,0	37,0	7,6	1,0	5	□
JS755100E3R050.3Z5-HXT	03187127	3	E	10,0	10,0	40,0	89,0	47,0	9,5	0,5	5	□
JS755100E3R100.3Z5-HXT	03187128	3	E	10,0	10,0	40,0	89,0	47,0	9,5	1,0	5	□
JS755100E3R200.3Z5-HXT	03187129	3	E	10,0	10,0	40,0	89,0	47,0	9,5	2,0	5	□
JS755100E3R300.3Z5-HXT	03187130	3	E	10,0	10,0	40,0	89,0	47,0	9,5	3,0	5	□
JS755120E3R050.3Z5-HXT	03187131	3	E	12,0	12,0	45,0	100,0	53,0	11,4	0,5	5	□
JS755120E3R100.3Z5-HXT	03187132	3	E	12,0	12,0	45,0	100,0	53,0	11,4	1,0	5	□
JS755120E3R200.3Z5-HXT	03187133	3	E	12,0	12,0	45,0	100,0	53,0	11,4	2,0	5	□
JS755120E3R300.3Z5-HXT	03187134	3	E	12,0	12,0	45,0	100,0	53,0	11,4	3,0	5	□
JS755160E3R050.3Z5-HXT	03187135	3	E	16,0	16,0	55,0	115,0	65,0	15,2	0,5	5	□
JS755160E3R600.3Z5-HXT	03187136	3	E	16,0	16,0	55,0	115,0	65,0	15,2	6,0	5	□
JS755200E3R050.3Z5-HXT	03187137	3	E	20,0	20,0	61,0	125,0	72,0	19,0	0,5	5	□
JS755200E3R600.3Z5-HXT	03187138	3	E	20,0	20,0	61,0	125,0	72,0	19,0	6,0	5	□

■ Stocked standard. □ Weldon available. Delivery time is 3 days.

JS755

High performance – Square – ISO– M and ISO– S – 5 Flutes – Safelock – Chamfer

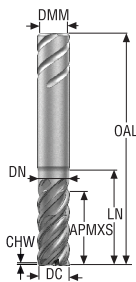

E

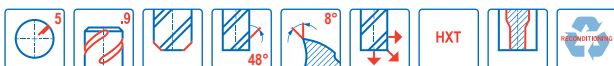

- Tolerances:
- DMM= h5
- DC= e7
- Regrind possible

Designation	Item number	Length index	Tool shape	DC	DMM	APMXS	OAL	LN	DN	CHW	PCEDC	Safelock
				mm	mm	mm	mm	mm	mm	mm		
JS755060E2C.9Z5-HXT	03187235	2	E	6,0	6,0	12,0	57,0	18,0	5,7	0,075	5	<input type="checkbox"/>
JS755080E2C.9Z5-HXT	03187236	2	E	8,0	8,0	16,0	63,0	25,0	7,6	0,1	5	<input type="checkbox"/>
JS755100E2C.9Z5-HXT	03187237	2	E	10,0	10,0	20,0	72,0	29,0	9,5	0,125	5	<input type="checkbox"/>
JS755120E2C.9Z5-HXT	03187238	2	E	12,0	12,0	24,0	83,0	35,0	11,4	0,15	5	<input type="checkbox"/>
JS755160E2C.9Z5-HXT	03187239	2	E	16,0	16,0	32,0	92,0	42,0	15,2	0,2	5	<input type="checkbox"/>
JS755200E2C.9Z5-HXT	03187240	2	E	20,0	20,0	40,0	104,0	51,0	19,0	0,25	5	<input type="checkbox"/>
JS755250E2C.9Z5-HXT	03187241	2	E	25,0	25,0	50,0	121,0	65,0	23,8	0,3	5	<input type="checkbox"/>
JS755060E3C.9Z5-HXT	03187242	3	E	6,0	6,0	21,0	65,0	26,0	5,7	0,075	5	<input type="checkbox"/>
JS755080E3C.9Z5-HXT	03187243	3	E	8,0	8,0	32,0	75,0	37,0	7,6	0,1	5	<input type="checkbox"/>
JS755100E3C.9Z5-HXT	03187244	3	E	10,0	10,0	40,0	89,0	47,0	9,5	0,125	5	<input type="checkbox"/>
JS755120E3C.9Z5-HXT	03187245	3	E	12,0	12,0	45,0	100,0	53,0	11,4	0,15	5	<input type="checkbox"/>
JS755160E3C.9Z5-HXT	03187246	3	E	16,0	16,0	55,0	115,0	65,0	15,2	0,2	5	<input type="checkbox"/>
JS755200E3C.9Z5-HXT	03187247	3	E	20,0	20,0	61,0	125,0	72,0	19,0	0,25	5	<input type="checkbox"/>
JS755250E3C.9Z5-HXT	03187248	3	E	25,0	25,0	85,0	153,0	94,0	23,8	0,3	5	<input type="checkbox"/>

Safelock available. Delivery time is 6 days.

Universal

Steel and cast iron

Stainless steel and S-materials

Non ferrous

Hard

Plastic and cfrp

Graphite

X-Heads

Minimaster Plus

Minimaster

JS755

High performance – Square – ISO– M and ISO– S – 5 Flutes – Safelock – Chamfer – Chip splitters

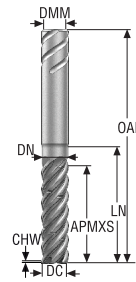

E

- Tolerances:
- DMM= h5
- DC= e7
- Chip splitters
- Regrind possible

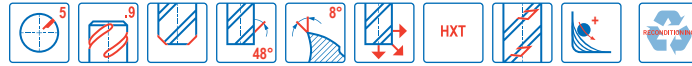

Designation	Item number	Length index	Tool shape	Chip splitters	DC	DMM	APMXS	OAL	LN	DN	CHW	PCEDC	Safelock
					mm	mm	mm	mm	mm	mm	mm		
JS755100E3C.9Z5C-HXT	03187249	3	E	■	10,0	10,0	40,0	89,0	47,0	9,5	0,125	5	<input type="checkbox"/>
JS755120E3C.9Z5C-HXT	03187250	3	E	■	12,0	12,0	45,0	100,0	53,0	11,4	0,15	5	<input type="checkbox"/>
JS755160E3C.9Z5C-HXT	03187252	3	E	■	16,0	16,0	55,0	115,0	65,0	15,2	0,2	5	<input type="checkbox"/>
JS755200E3C.9Z5C-HXT	03187253	3	E	■	20,0	20,0	61,0	125,0	72,0	19,0	0,25	5	<input type="checkbox"/>

Safelock available. Delivery time is 6 days.

Universal
Steel and cast iron
Stainless steel and S-materials
Non ferrous
Hard
Plastic and CFRP
Graphite
X-Heads
Minimaster Plus
Minimaster

JS755

High performance – Square – ISO– M and ISO– S – 5 Flutes – Safelock – Corner radius

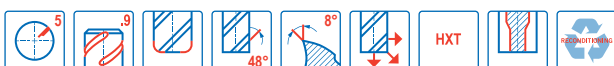
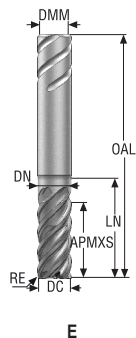

- Tolerances:
- DMM= h5
- DC= e7
- RE= ±0,02 mm
- Re grind possible

Designation	Item number	Length index	Tool shape	DC	DMM	APMXS	OAL	LN	DN	RE	PCEDC	Safelock
				mm	mm	mm	mm	mm	mm	mm		
JS755060E2R020.9Z5-HXT	03187254	2	E	6,0	6,0	12,0	57,0	18,0	5,7	0,2	5	<input type="checkbox"/>
JS755060E2R050.9Z5-HXT	03187255	2	E	6,0	6,0	12,0	57,0	18,0	5,7	0,5	5	<input type="checkbox"/>
JS755060E2R100.9Z5-HXT	03187256	2	E	6,0	6,0	12,0	57,0	18,0	5,7	1,0	5	<input type="checkbox"/>
JS755080E2R050.9Z5-HXT	03187257	2	E	8,0	8,0	16,0	63,0	25,0	7,6	0,5	5	<input type="checkbox"/>
JS755080E2R100.9Z5-HXT	03187258	2	E	8,0	8,0	16,0	63,0	25,0	7,6	1,0	5	<input type="checkbox"/>
JS755100E2R050.9Z5-HXT	03187259	2	E	10,0	10,0	20,0	72,0	29,0	9,5	0,5	5	<input type="checkbox"/>
JS755100E2R100.9Z5-HXT	03187260	2	E	10,0	10,0	20,0	72,0	29,0	9,5	1,0	5	<input type="checkbox"/>
JS755100E2R200.9Z5-HXT	03187261	2	E	10,0	10,0	20,0	72,0	29,0	9,5	2,0	5	<input type="checkbox"/>
JS755100E2R300.9Z5-HXT	03187262	2	E	10,0	10,0	20,0	72,0	29,0	9,5	3,0	5	<input type="checkbox"/>
JS755120E2R050.9Z5-HXT	03187263	2	E	12,0	12,0	24,0	83,0	35,0	11,4	0,5	5	<input type="checkbox"/>
JS755120E2R100.9Z5-HXT	03187264	2	E	12,0	12,0	24,0	83,0	35,0	11,4	1,0	5	<input type="checkbox"/>
JS755120E2R200.9Z5-HXT	03187265	2	E	12,0	12,0	24,0	83,0	35,0	11,4	2,0	5	<input type="checkbox"/>
JS755120E2R300.9Z5-HXT	03187266	2	E	12,0	12,0	24,0	83,0	35,0	11,4	3,0	5	<input type="checkbox"/>
JS755160E2R050.9Z5-HXT	03187267	2	E	16,0	16,0	32,0	92,0	42,0	15,2	0,5	5	<input type="checkbox"/>
JS755160E2R100.9Z5-HXT	03187269	2	E	16,0	16,0	32,0	92,0	42,0	15,2	1,0	5	<input type="checkbox"/>
JS755160E2R600.9Z5-HXT	03187270	2	E	16,0	16,0	32,0	92,0	42,0	15,2	6,0	5	<input type="checkbox"/>
JS755200E2R050.9Z5-HXT	03187271	2	E	20,0	20,0	40,0	104,0	51,0	19,0	0,5	5	<input type="checkbox"/>
JS755200E2R100.9Z5-HXT	03187272	2	E	20,0	20,0	40,0	104,0	51,0	19,0	1,0	5	<input type="checkbox"/>
JS755200E2R600.9Z5-HXT	03187273	2	E	20,0	20,0	40,0	104,0	51,0	19,0	6,0	5	<input type="checkbox"/>
JS755060E3R020.9Z5-HXT	03187276	3	E	6,0	6,0	21,0	65,0	26,0	5,7	0,2	5	<input type="checkbox"/>
JS755060E3R050.9Z5-HXT	03187277	3	E	6,0	6,0	21,0	65,0	26,0	5,7	0,5	5	<input type="checkbox"/>
JS755060E3R100.9Z5-HXT	03187279	3	E	6,0	6,0	21,0	65,0	26,0	5,7	1,0	5	<input type="checkbox"/>
JS755080E3R050.9Z5-HXT	03187280	3	E	8,0	8,0	32,0	75,0	37,0	7,6	0,5	5	<input type="checkbox"/>
JS755080E3R100.9Z5-HXT	03187281	3	E	8,0	8,0	32,0	75,0	37,0	7,6	1,0	5	<input type="checkbox"/>
JS755100E3R050.9Z5-HXT	03187282	3	E	10,0	10,0	40,0	89,0	47,0	9,5	0,5	5	<input type="checkbox"/>
JS755100E3R100.9Z5-HXT	03187283	3	E	10,0	10,0	40,0	89,0	47,0	9,5	1,0	5	<input type="checkbox"/>
JS755100E3R200.9Z5-HXT	03187284	3	E	10,0	10,0	40,0	89,0	47,0	9,5	2,0	5	<input type="checkbox"/>
JS755100E3R300.9Z5-HXT	03187285	3	E	10,0	10,0	40,0	89,0	47,0	9,5	3,0	5	<input type="checkbox"/>
JS755120E3R050.9Z5-HXT	03187286	3	E	12,0	12,0	45,0	100,0	53,0	11,4	0,5	5	<input type="checkbox"/>
JS755120E3R100.9Z5-HXT	03187287	3	E	12,0	12,0	45,0	100,0	53,0	11,4	1,0	5	<input type="checkbox"/>
JS755120E3R200.9Z5-HXT	03187288	3	E	12,0	12,0	45,0	100,0	53,0	11,4	2,0	5	<input type="checkbox"/>
JS755120E3R300.9Z5-HXT	03187289	3	E	12,0	12,0	45,0	100,0	53,0	11,4	3,0	5	<input type="checkbox"/>
JS755160E3R050.9Z5-HXT	03187290	3	E	16,0	16,0	55,0	115,0	65,0	15,2	0,5	5	<input type="checkbox"/>
JS755160E3R600.9Z5-HXT	03187291	3	E	16,0	16,0	55,0	115,0	65,0	15,2	6,0	5	<input type="checkbox"/>
JS755200E3R050.9Z5-HXT	03187292	3	E	20,0	20,0	61,0	125,0	72,0	19,0	0,5	5	<input type="checkbox"/>
JS755200E3R600.9Z5-HXT	03187293	3	E	20,0	20,0	61,0	125,0	72,0	19,0	6,0	5	<input type="checkbox"/>

Safelock available. Delivery time is 6 days.

Universal
Steel and cast iron
Stainless steel and S-materials
Non ferrous
Hard
Plastic and CFRP
Graphite
X-Heads
Minimaster Plus
Minimaster

Cutting data – JS755 Side milling roughing

SMG		a _e /DC	a _p /DC	f _z							v _c
				6	8	10	12	16	20	25	
P11	M/A/D/E	0.400	1.1	0.044	0.060	0.075	0.085	0.11	0.12	0.14	135 (97 – 150)
		0,400	1,1	0,0017	0,0024	0,0030	0,0034	0,0044	0,0048	0,0055	445 (320 – 490)
P12	M/A/D/E	0.400	1.1	0.030	0.040	0.050	0.060	0.075	0.085	0.095	85 (63 – 99)
		0,400	1,1	0,0012	0,0016	0,0020	0,0024	0,0030	0,0034	0,0038	280 (210 – 320)
M1	E	0.400	1.1	0.032	0.044	0.055	0.065	0.080	0.095	0.11	170 (150 – 190)
		0,400	1,1	0,0013	0,0017	0,0022	0,0026	0,0032	0,0038	0,0044	560 (500 – 620)
M2	E	0.400	1.1	0.030	0.040	0.050	0.060	0.075	0.085	0.095	140 (120 – 150)
		0,400	1,1	0,0012	0,0016	0,0020	0,0024	0,0030	0,0034	0,0038	460 (400 – 490)
M3	E	0.400	1.1	0.030	0.040	0.050	0.060	0.075	0.085	0.095	110 (92 – 120)
		0,400	1,1	0,0012	0,0016	0,0020	0,0024	0,0030	0,0034	0,0038	360 (310 – 390)
M4	E	0.400	1.1	0.026	0.034	0.044	0.050	0.065	0.075	0.085	75 (71 – 95)
		0,400	1,1	0,0010	0,0013	0,0017	0,0020	0,0026	0,0030	0,0034	280 (240 – 310)
M5	E	0.400	1.1	0.026	0.034	0.044	0.050	0.065	0.075	0.085	70 (59 – 79)
		0,400	1,1	0,0010	0,0013	0,0017	0,0020	0,0026	0,0030	0,0034	230 (200 – 250)
S1	E	0.0300	2.0	0.046	0.060	0.075	0.090	0.11	0.13	0.14	70 (48 – 110)
		0,0300	2,0	0,0018	0,0024	0,0030	0,0036	0,0044	0,0050	0,0055	230 (160 – 360)
S2	E	0.0300	2.0	0.046	0.060	0.075	0.090	0.11	0.13	0.14	60 (39 – 89)
		0,0300	2,0	0,0018	0,0024	0,0030	0,0036	0,0044	0,0050	0,0055	195 (130 – 290)
S3	E	0.0300	2.0	0.042	0.055	0.070	0.085	0.10	0.12	0.13	50 (34 – 78)
		0,0300	2,0	0,0017	0,0022	0,0028	0,0034	0,0040	0,0048	0,0050	165 (120 – 250)
S11	E	0.400	1.1	0.030	0.040	0.050	0.060	0.075	0.085	0.095	140 (120 – 160)
		0,400	1,1	0,0012	0,0016	0,0020	0,0024	0,0030	0,0034	0,0038	460 (400 – 520)
S12	E	0.400	1.1	0.030	0.040	0.050	0.060	0.075	0.085	0.095	110 (91 – 120)
		0,400	1,1	0,0012	0,0016	0,0020	0,0024	0,0030	0,0034	0,0038	360 (300 – 390)
S13	E	0.400	1.1	0.026	0.034	0.044	0.050	0.065	0.075	0.085	85 (73 – 100)
		0,400	1,1	0,0010	0,0013	0,0017	0,0020	0,0026	0,0030	0,0034	280 (240 – 320)

Cutting data – JS755_3C Advanced roughing a_e/DC=0,05-0,1

SMG		a _e /DC	a _p /DC	f _z				v _c
				10	12	16	20	
P11	M/A/D/E	0.100	4.0	0.15	0.17	0.22	0.25	265 (220 – 290)
		0,100	4,0	0,0060	0,0065	0,0085	0,010	870 (730 – 950)
P12	M/A/D/E	0.100	4.0	0.10	0.12	0.15	0.17	170 (140 – 180)
		0,100	4,0	0,0040	0,0048	0,0060	0,0065	560 (460 – 590)
M1	E	0.100	4.0	0.11	0.13	0.16	0.19	205 (170 – 220)
		0,100	4,0	0,0044	0,0050	0,0065	0,0075	670 (560 – 720)
M2	E	0.100	4.0	0.10	0.12	0.15	0.17	170 (140 – 180)
		0,100	4,0	0,0040	0,0048	0,0060	0,0065	560 (460 – 590)
M3	E	0.100	4.0	0.10	0.12	0.15	0.17	130 (110 – 140)
		0,100	4,0	0,0040	0,0048	0,0060	0,0065	425 (370 – 450)
M4	E	0.100	4.0	0.085	0.10	0.13	0.15	100 (85 – 110)
		0,100	4,0	0,0034	0,0040	0,0050	0,0060	330 (280 – 360)
M5	E	0.100	4.0	0.085	0.10	0.13	0.15	85 (71 – 96)
		0,100	4,0	0,0034	0,0040	0,0050	0,0060	280 (240 – 310)
S1	E	0.0500	4.0	0.085	0.10	0.13	0.15	70 (43 – 99)
		0,0500	4,0	0,0034	0,0040	0,0050	0,0060	230 (150 – 320)
S2	E	0.0500	4.0	0.085	0.10	0.13	0.15	55 (35 – 80)
		0,0500	4,0	0,0034	0,0040	0,0050	0,0060	180 (120 – 260)
S3	E	0.0500	4.0	0.080	0.095	0.12	0.14	50 (31 – 70)
		0,0500	4,0	0,0032	0,0038	0,0048	0,0055	165 (110 – 220)
S11	E	0.0800	4.0	0.070	0.085	0.10	0.12	160 (140 – 190)
		0,0800	4,0	0,0028	0,0034	0,0040	0,0048	520 (460 – 620)
S12	E	0.0800	4.0	0.070	0.085	0.10	0.12	125 (110 – 140)
		0,0800	4,0	0,0028	0,0034	0,0040	0,0048	410 (370 – 450)
S13	E	0.0800	4.0	0.060	0.070	0.090	0.10	100 (83 – 110)
		0,0800	4,0	0,0024	0,0028	0,0036	0,0040	330 (280 – 360)

If radius exceeds 15% of value DC please reduce fz with 20%

For cutting data recalculations, see pages 556 - 563

SMG = Seco material group
Coolant = A=air D=dry E=emulsion M=mist spray
v_c = m/min (sf/min)
f_z = mm (in/tooth)
a_p = mm/DC (in/DC) = factor
a_e = mm/DC (in/DC) = factor
All cutting data are target values

JS720

High performance – Titanium – Square – 6 Flutes – Cylindrical – Corner radius

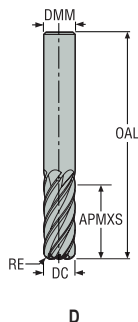

- Tolerances:
- DMM= h5
- DC= e7
- RE= ±0,02 mm
- Regrind possible

Designation	Item number	Length index	Tool shape	DC	DMM	APMXS	OAL	RE	PCEDC	Cylindrical
				mm	mm	mm	mm	mm		
JS720060D2R050.0Z6-HXT	03060293	2	D	6,0	6,0	17,0	57,0	0,5	6	■
JS720060D2R100.0Z6-HXT	03060294	2	D	6,0	6,0	17,0	57,0	1,0	6	■
JS720080D2R050.0Z6-HXT	03060295	2	D	8,0	8,0	23,0	63,0	0,5	6	■
JS720080D2R100.0Z6-HXT	03061294	2	D	8,0	8,0	23,0	63,0	1,0	6	■
JS720100D2R050.0Z6-HXT	03060296	2	D	10,0	10,0	26,0	72,0	0,5	6	■
JS720100D2R100.0Z6-HXT	03060298	2	D	10,0	10,0	26,0	72,0	1,0	6	■
JS720100D2R200.0Z6-HXT	03060299	2	D	10,0	10,0	26,0	72,0	2,0	6	■
JS720100D2R300.0Z6-HXT	03060300	2	D	10,0	10,0	26,0	72,0	3,0	6	■
JS720120D2R050.0Z6-HXT	03060301	2	D	12,0	12,0	30,0	83,0	0,5	6	■
JS720120D2R100.0Z6-HXT	03060304	2	D	12,0	12,0	30,0	83,0	1,0	6	■
JS720120D2R200.0Z6-HXT	03060305	2	D	12,0	12,0	30,0	83,0	2,0	6	■
JS720120D2R300.0Z6-HXT	03060306	2	D	12,0	12,0	30,0	83,0	3,0	6	■
JS720160D2R050.0Z6-HXT	03060307	2	D	16,0	16,0	44,0	99,0	0,5	6	■
JS720160D2R100.0Z6-HXT	03060309	2	D	16,0	16,0	44,0	99,0	1,0	6	■
JS720160D2R200.0Z6-HXT	03060310	2	D	16,0	16,0	44,0	99,0	2,0	6	■
JS720160D2R300.0Z6-HXT	03060311	2	D	16,0	16,0	44,0	99,0	3,0	6	■
JS720160D2R400.0Z6-HXT	03060312	2	D	16,0	16,0	44,0	99,0	4,0	6	■
JS720160D2R600.0Z6-HXT	03060313	2	D	16,0	16,0	44,0	99,0	6,0	6	■
JS720250D2R300.0Z6-HXT	03169498	2	D	25,0	25,0	50,0	125,0	3,0	6	■
JS720160D3R300.0Z6-HXT	03169497	3	D	16,0	16,0	65,0	130,0	3,0	6	■
JS720200D3R050.0Z6-HXT	03060314	3	D	20,0	20,0	62,0	121,0	0,5	6	■
JS720200D3R100.0Z6-HXT	03060316	3	D	20,0	20,0	62,0	121,0	1,0	6	■
JS720200D3R200.0Z6-HXT	03060317	3	D	20,0	20,0	62,0	121,0	2,0	6	■
JS720200D3R300.0Z6-HXT	03060318	3	D	20,0	20,0	62,0	121,0	3,0	6	■
JS720200D3R400.0Z6-HXT	03060319	3	D	20,0	20,0	62,0	121,0	4,0	6	■
JS720200D3R500.0Z6-HXT	03060320	3	D	20,0	20,0	62,0	121,0	5,0	6	■
JS720200D3R600.0Z6-HXT	03060321	3	D	20,0	20,0	62,0	121,0	6,0	6	■
JS720250D3R050.0Z6-HXT	03060322	3	D	25,0	25,0	78,0	146,0	0,5	6	■
JS720250D3R100.0Z6-HXT	03060323	3	D	25,0	25,0	78,0	146,0	1,0	6	■
JS720250D3R200.0Z6-HXT	03060324	3	D	25,0	25,0	78,0	146,0	2,0	6	■
JS720250D3R300.0Z6-HXT	03060325	3	D	25,0	25,0	78,0	146,0	3,0	6	■
JS720250D3R400.0Z6-HXT	03060326	3	D	25,0	25,0	78,0	146,0	4,0	6	■
JS720250D3R600.0Z6-HXT	03060327	3	D	25,0	25,0	78,0	146,0	6,0	6	■

■ Stocked standard.

Universal

Steel and cast iron

Stainless steel and S-materials

Non ferrous

Hard

Plastic and CFRP

Graphite

X-Heads

Minimaster Plus

Minimaster

JS720

High performance – Titanium – Square – 6 Flutes – Cylindrical – Corner radius – Chip splitters

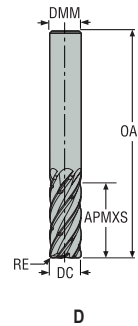

- Tolerances:
- DMM= h5
- DC= e7
- RE= ±0,02 mm
- Chip splitters
- Regrind possible

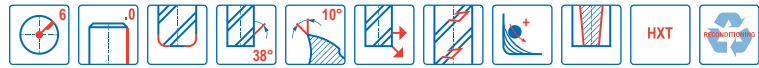

Designation	Item number	Length index	Tool shape	Chip splitters	DC	DMM	APMXS	OAL	RE	PCEDC	Cylindrical
					mm	mm	mm	mm	mm		
JS720100D2R050.0Z6C-HXT	03060297	2	D	■	10,0	10,0	26,0	72,0	0,5	6	■
JS720120D2R050.0Z6C-HXT	03060302	2	D	■	12,0	12,0	30,0	83,0	0,5	6	■
JS720120D2R100.0Z6C-HXT	03298280	2	D	■	12,0	12,0	30,0	83,0	1,0	6	■
JS720120D2R200.0Z6C-HXT	03298281	2	D	■	12,0	12,0	30,0	83,0	2,0	6	■
JS720120D2R250.0Z6C-HXT	03298282	2	D	■	12,0	12,0	30,0	83,0	2,5	6	■
JS720120D2R300.0Z6C-HXT	03298283	2	D	■	12,0	12,0	30,0	83,0	3,0	6	■
JS720120D2R310.0Z6C-HXT	03298284	2	D	■	12,0	12,0	30,0	83,0	3,1	6	■
JS720160D2R050.0Z6C-HXT	03060308	2	D	■	16,0	16,0	44,0	99,0	0,5	6	■
JS720160D2R100.0Z6C-HXT	03298285	2	D	■	16,0	16,0	44,0	99,0	1,0	6	■
JS720160D2R200.0Z6C-HXT	03298286	2	D	■	16,0	16,0	44,0	99,0	2,0	6	■
JS720160D2R250.0Z6C-HXT	03298287	2	D	■	16,0	16,0	44,0	99,0	2,5	6	■
JS720160D2R300.0Z6C-HXT	03298288	2	D	■	16,0	16,0	44,0	99,0	3,0	6	■
JS720160D2R310.0Z6C-HXT	03298289	2	D	■	16,0	16,0	44,0	99,0	3,1	6	■
JS720160D2R400.0Z6C-HXT	03298290	2	D	■	16,0	16,0	44,0	99,0	4,0	6	■
JS720160D2R600.0Z6C-HXT	03298291	2	D	■	16,0	16,0	44,0	99,0	6,0	6	■
JS720200D3R050.0Z6C-HXT	03060315	3	D	■	20,0	20,0	62,0	121,0	0,5	6	■
JS720200D3R100.0Z6C-HXT	03298292	3	D	■	20,0	20,0	62,0	121,0	1,0	6	■
JS720200D3R200.0Z6C-HXT	03298293	3	D	■	20,0	20,0	62,0	121,0	2,0	6	■
JS720200D3R250.0Z6C-HXT	03298294	3	D	■	20,0	20,0	62,0	121,0	2,5	6	■
JS720200D3R300.0Z6C-HXT	03298295	3	D	■	20,0	20,0	62,0	121,0	3,0	6	■
JS720200D3R310.0Z6C-HXT	03298296	3	D	■	20,0	20,0	62,0	121,0	3,1	6	■
JS720200D3R400.0Z6C-HXT	03298297	3	D	■	20,0	20,0	62,0	121,0	4,0	6	■
JS720200D3R500.0Z6C-HXT	03298298	3	D	■	20,0	20,0	62,0	121,0	5,0	6	■
JS720200D3R600.0Z6C-HXT	03298299	3	D	■	20,0	20,0	62,0	121,0	6,0	6	■
JS720250D3R050.0Z6C-HXT	03066270	3	D	■	25,0	25,0	78,0	146,0	0,5	6	■
JS720250D3R100.0Z6C-HXT	03298300	3	D	■	25,0	25,0	78,0	146,0	1,0	6	■
JS720250D3R200.0Z6C-HXT	03298301	3	D	■	25,0	25,0	78,0	146,0	2,0	6	■
JS720250D3R300.0Z6C-HXT	03298302	3	D	■	25,0	25,0	78,0	146,0	3,0	6	■
JS720250D3R400.0Z6C-HXT	03298303	3	D	■	25,0	25,0	78,0	146,0	4,0	6	■
JS720250D3R600.0Z6C-HXT	03298304	3	D	■	25,0	25,0	78,0	146,0	6,0	6	■

■ Stocked standard.

Universal

Steel and cast iron

Stainless steel and S-materials

Non ferrous

Hard

Plastic and CFRP

Graphite

X-Heads

Mimimaster Plus

Mimimaster

JS720

High performance – Titanium – Square – 9 Flutes – Cylindrical – Corner radius

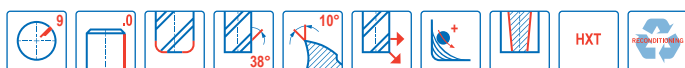
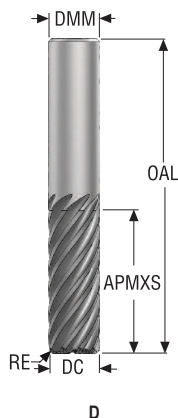

- Tolerances:
- DMM= h5
- DC= e7
- RE= ±0,02 mm
- Regrind possible

Designation	Item number	Length index	Tool shape	DC	DMM	APMXS	OAL	RE	PCEDC	Cylindrical
				mm	mm	mm	mm	mm		
JS720100D2R050.0Z9-HXT	10067510	2	D	10,0	10,0	26,0	72,0	0,5	9	■
JS720100D2R100.0Z9-HXT	10067511	2	D	10,0	10,0	26,0	72,0	1,0	9	■
JS720100D2R200.0Z9-HXT	10067512	2	D	10,0	10,0	26,0	72,0	2,0	9	■
JS720120D2R050.0Z9-HXT	10067513	2	D	12,0	12,0	30,0	83,0	0,5	9	■
JS720120D2R100.0Z9-HXT	10067514	2	D	12,0	12,0	30,0	83,0	1,0	9	■
JS720120D2R200.0Z9-HXT	10067515	2	D	12,0	12,0	30,0	83,0	2,0	9	■
JS720160D2R100.0Z9-HXT	10008152	2	D	16,0	16,0	44,0	99,0	1,0	9	■
JS720160D2R200.0Z9-HXT	10008153	2	D	16,0	16,0	44,0	99,0	2,0	9	■
JS720160D2R300.0Z9-HXT	10008154	2	D	16,0	16,0	44,0	99,0	3,0	9	■
JS720250D2R100.0Z9-HXT	10008155	2	D	25,0	25,0	50,0	125,0	1,0	9	■
JS720250D2R200.0Z9-HXT	10008156	2	D	25,0	25,0	50,0	125,0	2,0	9	■
JS720250D2R300.0Z9-HXT	10008157	2	D	25,0	25,0	50,0	125,0	3,0	9	■
JS720100D3R050.0Z9-HXT	10067516	3	D	10,0	10,0	40,0	89,0	0,5	9	■
JS720100D3R100.0Z9-HXT	10067517	3	D	10,0	10,0	40,0	89,0	1,0	9	■
JS720100D3R200.0Z9-HXT	10067518	3	D	10,0	10,0	40,0	89,0	2,0	9	■
JS720120D3R050.0Z9-HXT	10067519	3	D	12,0	12,0	45,0	100,0	0,5	9	■
JS720120D3R100.0Z9-HXT	10067520	3	D	12,0	12,0	45,0	100,0	1,0	9	■
JS720120D3R200.0Z9-HXT	10067521	3	D	12,0	12,0	45,0	100,0	2,0	9	■
JS720160D3R100.0Z9-HXT	10008158	3	D	16,0	16,0	65,0	130,0	1,0	9	■
JS720160D3R200.0Z9-HXT	10008159	3	D	16,0	16,0	65,0	130,0	2,0	9	■
JS720160D3R300.0Z9-HXT	10008160	3	D	16,0	16,0	65,0	130,0	3,0	9	■
JS720200D3R100.0Z9-HXT	10008161	3	D	20,0	20,0	62,0	121,0	1,0	9	■
JS720200D3R200.0Z9-HXT	10008162	3	D	20,0	20,0	62,0	121,0	2,0	9	■
JS720200D3R300.0Z9-HXT	10008163	3	D	20,0	20,0	62,0	121,0	3,0	9	■
JS720250D3R100.0Z9-HXT	10008164	3	D	25,0	25,0	78,0	146,0	1,0	9	■
JS720250D3R200.0Z9-HXT	10008165	3	D	25,0	25,0	78,0	146,0	2,0	9	■
JS720250D3R300.0Z9-HXT	10008166	3	D	25,0	25,0	78,0	146,0	3,0	9	■

■ Stocked standard.

Universal

Steel and cast iron

Stainless steel and S-materials

Non ferrous

Hard

Plastic and CFRP

Graphite

X-Heads

Minimaster Plus

Minimaster

JS720

High performance – Titanium – Square – 9 Flutes – Cylindrical – Corner radius – Chip splitters

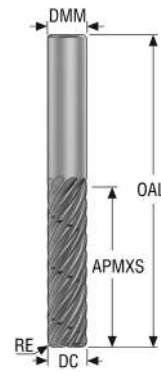

D

- Tolerances:
- DMM= h5
- DC= e7
- RE= ±0,02 mm
- Regrind possible



Designation	Item number	Length index	Tool shape	Chip splitters	DC	DMM	APMXS	OAL	RE	PCEDC	Cylindrical
					mm	mm	mm	mm	mm		
JS720100D3R050.0Z9C-HXT	10067522	3	D	■	10,0	10,0	40,0	89,0	0,5	9	■
JS720100D3R100.0Z9C-HXT	10067523	3	D	■	10,0	10,0	40,0	89,0	1,0	9	■
JS720100D3R200.0Z9C-HXT	10067524	3	D	■	10,0	10,0	40,0	89,0	2,0	9	■
JS720120D3R050.0Z9C-HXT	10067525	3	D	■	12,0	12,0	45,0	100,0	0,5	9	■
JS720120D3R100.0Z9C-HXT	10067526	3	D	■	12,0	12,0	45,0	100,0	1,0	9	■
JS720120D3R200.0Z9C-HXT	10067527	3	D	■	12,0	12,0	45,0	100,0	2,0	9	■
JS720160D3R100.0Z9C-HXT	10067528	3	D	■	16,0	16,0	65,0	130,0	1,0	9	■
JS720160D3R200.0Z9C-HXT	10067529	3	D	■	16,0	16,0	65,0	130,0	2,0	9	■
JS720160D3R300.0Z9C-HXT	10067530	3	D	■	16,0	16,0	65,0	130,0	3,0	9	■
JS720200D3R100.0Z9C-HXT	10067531	3	D	■	20,0	20,0	62,0	121,0	1,0	9	■
JS720200D3R200.0Z9C-HXT	10067532	3	D	■	20,0	20,0	62,0	121,0	2,0	9	■
JS720200D3R300.0Z9C-HXT	10067533	3	D	■	20,0	20,0	62,0	121,0	3,0	9	■
JS720250D3R100.0Z9C-HXT	10067534	3	D	■	25,0	25,0	78,0	146,0	1,0	9	■
JS720250D3R200.0Z9C-HXT	10067535	3	D	■	25,0	25,0	78,0	146,0	2,0	9	■
JS720250D3R300.0Z9C-HXT	10067536	3	D	■	25,0	25,0	78,0	146,0	3,0	9	■

■ Stocked standard.

Universal

Steel and cast iron

Stainless steel and S-materials

Non ferrous

Hard

Plastic and CFRP

Graphite

X-Heads

Minimaster Plus

Minimaster

JS720

High performance – Titanium – Square – 6 Flutes – Weldon – Corner radius

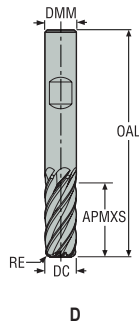

- Tolerances:
- DMM= h5
- DC= e7
- RE= ±0,02 mm
- Regrind possible

Designation	Item number	Length index	Tool shape	DC	DMM	APMXS	OAL	RE	PCEDC	Weldon
				mm	mm	mm	mm	mm		
JS720060D2R050.3Z6-HXT	03060339	2	D	6,0	6,0	17,0	57,0	0,5	6	<input type="checkbox"/>
JS720060D2R100.3Z6-HXT	03060340	2	D	6,0	6,0	17,0	57,0	1,0	6	<input type="checkbox"/>
JS720080D2R050.3Z6-HXT	03060341	2	D	8,0	8,0	23,0	63,0	0,5	6	<input type="checkbox"/>
JS720080D2R100.3Z6-HXT	03061295	2	D	8,0	8,0	23,0	63,0	1,0	6	<input type="checkbox"/>
JS720100D2R050.3Z6-HXT	03060342	2	D	10,0	10,0	26,0	72,0	0,5	6	<input type="checkbox"/>
JS720100D2R100.3Z6-HXT	03060344	2	D	10,0	10,0	26,0	72,0	1,0	6	<input type="checkbox"/>
JS720100D2R200.3Z6-HXT	03060345	2	D	10,0	10,0	26,0	72,0	2,0	6	<input type="checkbox"/>
JS720100D2R300.3Z6-HXT	03060346	2	D	10,0	10,0	26,0	72,0	3,0	6	<input type="checkbox"/>
JS720120D2R050.3Z6-HXT	03060347	2	D	12,0	12,0	30,0	83,0	0,5	6	<input type="checkbox"/>
JS720120D2R100.3Z6-HXT	03060349	2	D	12,0	12,0	30,0	83,0	1,0	6	<input type="checkbox"/>
JS720120D2R200.3Z6-HXT	03060350	2	D	12,0	12,0	30,0	83,0	2,0	6	<input type="checkbox"/>
JS720120D2R300.3Z6-HXT	03060351	2	D	12,0	12,0	30,0	83,0	3,0	6	<input type="checkbox"/>
JS720160D2R050.3Z6-HXT	03060352	2	D	16,0	16,0	44,0	99,0	0,5	6	<input type="checkbox"/>
JS720160D2R100.3Z6-HXT	03060354	2	D	16,0	16,0	44,0	99,0	1,0	6	<input type="checkbox"/>
JS720160D2R200.3Z6-HXT	03060355	2	D	16,0	16,0	44,0	99,0	2,0	6	<input type="checkbox"/>
JS720160D2R300.3Z6-HXT	03060356	2	D	16,0	16,0	44,0	99,0	3,0	6	<input type="checkbox"/>
JS720160D2R400.3Z6-HXT	03060357	2	D	16,0	16,0	44,0	99,0	4,0	6	<input type="checkbox"/>
JS720160D2R600.3Z6-HXT	03060358	2	D	16,0	16,0	44,0	99,0	6,0	6	<input type="checkbox"/>
JS720200D3R050.3Z6-HXT	03060359	3	D	20,0	20,0	62,0	121,0	0,5	6	<input type="checkbox"/>
JS720200D3R100.3Z6-HXT	03060361	3	D	20,0	20,0	62,0	121,0	1,0	6	<input type="checkbox"/>
JS720200D3R200.3Z6-HXT	03060362	3	D	20,0	20,0	62,0	121,0	2,0	6	<input type="checkbox"/>
JS720200D3R300.3Z6-HXT	03060363	3	D	20,0	20,0	62,0	121,0	3,0	6	<input checked="" type="checkbox"/>
JS720200D3R400.3Z6-HXT	03060364	3	D	20,0	20,0	62,0	121,0	4,0	6	<input type="checkbox"/>
JS720200D3R500.3Z6-HXT	03060365	3	D	20,0	20,0	62,0	121,0	5,0	6	<input type="checkbox"/>
JS720200D3R600.3Z6-HXT	03060366	3	D	20,0	20,0	62,0	121,0	6,0	6	<input type="checkbox"/>
JS720250D3R050.3Z6-HXT	03060367	3	D	25,0	25,0	78,0	146,0	0,5	6	<input type="checkbox"/>
JS720250D3R100.3Z6-HXT	03060368	3	D	25,0	25,0	78,0	146,0	1,0	6	<input type="checkbox"/>
JS720250D3R200.3Z6-HXT	03060369	3	D	25,0	25,0	78,0	146,0	2,0	6	<input type="checkbox"/>
JS720250D3R300.3Z6-HXT	03060370	3	D	25,0	25,0	78,0	146,0	3,0	6	<input type="checkbox"/>
JS720250D3R400.3Z6-HXT	03060371	3	D	25,0	25,0	78,0	146,0	4,0	6	<input checked="" type="checkbox"/>
JS720250D3R600.3Z6-HXT	03060372	3	D	25,0	25,0	78,0	146,0	6,0	6	<input type="checkbox"/>

■ Stocked standard. □ Weldon available. Delivery time is 3 days.

Universal

Steel and cast iron

Stainless steel and S-materials

Non ferrous

Hard

Plastic and CFRP

Graphite

X-Heads

Minimaster Plus

Minimaster

JS720

High performance – Titanium – Square – 6 Flutes – Weldon – Corner radius – Chip splitters

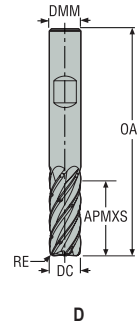

- Tolerances:
- DMM= h5
- DC= e7
- RE= ±0,02 mm
- Chip splitters
- Regrind possible



Designation	Item number	Length index	Tool shape	Chip splitters	DC	DMM	APMXS	OAL	RE	PCEDC	Weldon
					mm	mm	mm	mm	mm		
JS720100D2R050.3Z6C-HXT	03060343	2	D	■	10,0	10,0	26,0	72,0	0,5	6	□
JS720120D2R050.3Z6C-HXT	03060348	2	D	■	12,0	12,0	30,0	83,0	0,5	6	□
JS720120D2R100.3Z6C-HXT	03298308	2	D	■	12,0	12,0	30,0	83,0	1,0	6	□
JS720120D2R200.3Z6C-HXT	03298309	2	D	■	12,0	12,0	30,0	83,0	2,0	6	□
JS720120D2R250.3Z6C-HXT	03298310	2	D	■	12,0	12,0	30,0	83,0	2,5	6	□
JS720120D2R300.3Z6C-HXT	03298311	2	D	■	12,0	12,0	30,0	83,0	3,0	6	□
JS720120D2R310.3Z6C-HXT	03298312	2	D	■	12,0	12,0	30,0	83,0	3,1	6	□
JS720160D2R050.3Z6C-HXT	03060353	2	D	■	16,0	16,0	44,0	99,0	0,5	6	■
JS720160D2R100.3Z6C-HXT	03298313	2	D	■	16,0	16,0	44,0	99,0	1,0	6	■
JS720160D2R200.3Z6C-HXT	03298314	2	D	■	16,0	16,0	44,0	99,0	2,0	6	■
JS720160D2R250.3Z6C-HXT	03298315	2	D	■	16,0	16,0	44,0	99,0	2,5	6	■
JS720160D2R300.3Z6C-HXT	03298316	2	D	■	16,0	16,0	44,0	99,0	3,0	6	■
JS720160D2R310.3Z6C-HXT	03298317	2	D	■	16,0	16,0	44,0	99,0	3,1	6	■
JS720160D2R400.3Z6C-HXT	03298318	2	D	■	16,0	16,0	44,0	99,0	4,0	6	■
JS720160D2R600.3Z6C-HXT	03298319	2	D	■	16,0	16,0	44,0	99,0	6,0	6	■
JS720200D3R050.3Z6C-HXT	03060360	3	D	■	20,0	20,0	62,0	121,0	0,5	6	■
JS720200D3R100.3Z6C-HXT	03298320	3	D	■	20,0	20,0	62,0	121,0	1,0	6	■
JS720200D3R200.3Z6C-HXT	03298321	3	D	■	20,0	20,0	62,0	121,0	2,0	6	■
JS720200D3R250.3Z6C-HXT	03298322	3	D	■	20,0	20,0	62,0	121,0	2,5	6	■
JS720200D3R300.3Z6C-HXT	03298323	3	D	■	20,0	20,0	62,0	121,0	3,0	6	■
JS720200D3R310.3Z6C-HXT	03298324	3	D	■	20,0	20,0	62,0	121,0	3,1	6	■
JS720200D3R400.3Z6C-HXT	03298325	3	D	■	20,0	20,0	62,0	121,0	4,0	6	■
JS720200D3R500.3Z6C-HXT	03298326	3	D	■	20,0	20,0	62,0	121,0	5,0	6	■
JS720200D3R600.3Z6C-HXT	03298327	3	D	■	20,0	20,0	62,0	121,0	6,0	6	■
JS720250D3R050.3Z6C-HXT	03066460	3	D	■	25,0	25,0	78,0	146,0	0,5	6	■
JS720250D3R100.3Z6C-HXT	03298328	3	D	■	25,0	25,0	78,0	146,0	1,0	6	■
JS720250D3R200.3Z6C-HXT	03298329	3	D	■	25,0	25,0	78,0	146,0	2,0	6	■
JS720250D3R300.3Z6C-HXT	03298330	3	D	■	25,0	25,0	78,0	146,0	3,0	6	■
JS720250D3R400.3Z6C-HXT	03298331	3	D	■	25,0	25,0	78,0	146,0	4,0	6	■
JS720250D3R600.3Z6C-HXT	03298332	3	D	■	25,0	25,0	78,0	146,0	6,0	6	■

■ Stocked standard. □ Weldon available. Delivery time is 3 days.

JS720

High performance – Titanium – Square – 9 Flutes – Weldon – Corner radius

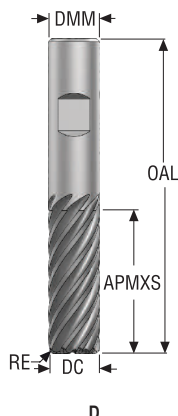

- Tolerances:
- DMM= h5
- DC= e7
- RE= ±0,02 mm
- Regrind possible

Designation	Item number	Length index	Tool shape	DC	DMM	APMXS	OAL	RE	PCEDC	Weldon
				mm	mm	mm	mm	mm		
JS720100D2R050.3Z9-HXT	10067881	2	D	10,0	10,0	26,0	72,0	0,5	9	<input type="checkbox"/>
JS720100D2R100.3Z9-HXT	10067882	2	D	10,0	10,0	26,0	72,0	1,0	9	<input type="checkbox"/>
JS720100D2R200.3Z9-HXT	10067883	2	D	10,0	10,0	26,0	72,0	2,0	9	<input type="checkbox"/>
JS720120D2R050.3Z9-HXT	10067884	2	D	12,0	12,0	30,0	83,0	0,5	9	<input type="checkbox"/>
JS720120D2R100.3Z9-HXT	10067885	2	D	12,0	12,0	30,0	83,0	1,0	9	<input type="checkbox"/>
JS720120D2R200.3Z9-HXT	10067886	2	D	12,0	12,0	30,0	83,0	2,0	9	<input type="checkbox"/>
JS720160D2R100.3Z9-HXT	10008279	2	D	16,0	16,0	44,0	99,0	1,0	9	<input type="checkbox"/>
JS720160D2R200.3Z9-HXT	10008280	2	D	16,0	16,0	44,0	99,0	2,0	9	<input type="checkbox"/>
JS720160D2R300.3Z9-HXT	10008281	2	D	16,0	16,0	44,0	99,0	3,0	9	<input type="checkbox"/>
JS720250D2R100.3Z9-HXT	10008282	2	D	25,0	25,0	50,0	125,0	1,0	9	<input type="checkbox"/>
JS720250D2R200.3Z9-HXT	10008283	2	D	25,0	25,0	50,0	125,0	2,0	9	<input type="checkbox"/>
JS720250D2R300.3Z9-HXT	10008284	2	D	25,0	25,0	50,0	125,0	3,0	9	<input type="checkbox"/>
JS720100D3R050.3Z9-HXT	10067887	3	D	10,0	10,0	40,0	89,0	0,5	9	<input type="checkbox"/>
JS720100D3R100.3Z9-HXT	10067888	3	D	10,0	10,0	40,0	89,0	1,0	9	<input type="checkbox"/>
JS720100D3R200.3Z9-HXT	10067889	3	D	10,0	10,0	40,0	89,0	2,0	9	<input type="checkbox"/>
JS720120D3R050.3Z9-HXT	10067890	3	D	12,0	12,0	45,0	100,0	0,5	9	<input type="checkbox"/>
JS720120D3R100.3Z9-HXT	10067891	3	D	12,0	12,0	45,0	100,0	1,0	9	<input type="checkbox"/>
JS720120D3R200.3Z9-HXT	10067892	3	D	12,0	12,0	45,0	100,0	2,0	9	<input type="checkbox"/>
JS720160D3R100.3Z9-HXT	10008285	3	D	16,0	16,0	65,0	130,0	1,0	9	<input type="checkbox"/>
JS720160D3R200.3Z9-HXT	10008286	3	D	16,0	16,0	65,0	130,0	2,0	9	<input type="checkbox"/>
JS720160D3R300.3Z9-HXT	10008287	3	D	16,0	16,0	65,0	130,0	3,0	9	<input type="checkbox"/>
JS720200D3R100.3Z9-HXT	10008288	3	D	20,0	20,0	62,0	121,0	1,0	9	<input type="checkbox"/>
JS720200D3R200.3Z9-HXT	10008289	3	D	20,0	20,0	62,0	121,0	2,0	9	<input type="checkbox"/>
JS720200D3R300.3Z9-HXT	10008290	3	D	20,0	20,0	62,0	121,0	3,0	9	<input type="checkbox"/>
JS720250D3R100.3Z9-HXT	10008292	3	D	25,0	25,0	78,0	146,0	1,0	9	<input type="checkbox"/>
JS720250D3R200.3Z9-HXT	10008293	3	D	25,0	25,0	78,0	146,0	2,0	9	<input type="checkbox"/>
JS720250D3R300.3Z9-HXT	10008294	3	D	25,0	25,0	78,0	146,0	3,0	9	<input type="checkbox"/>

Weldon available. Delivery time is 3 days.

Universal

Steel and cast iron

Stainless steel and S-materials

Non ferrous

Hard

Plastic and CFRP

Graphite

X-Heads

Minimaster Plus

Minimaster

JS720

High performance – Titanium – Square – 9 Flutes – Weldon – Corner radius – Chip splitters

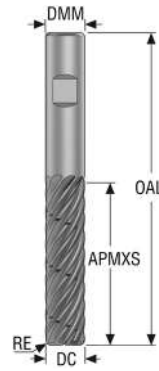

D

- Tolerances:
- DMM= h5
- DC= e7
- RE= ±0,02 mm
- Regrind possible



Designation	Item number	Length index	Tool shape	Chip splitters	DC	DMM	APMXS	OAL	RE	PCEDC	Weldon
					mm	mm	mm	mm	mm		
JS720100D3R050.3Z9C-HXT	10067893	3	D	■	10,0	10,0	40,0	89,0	0,5	9	<input type="checkbox"/>
JS720100D3R100.3Z9C-HXT	10067894	3	D	■	10,0	10,0	40,0	89,0	1,0	9	<input type="checkbox"/>
JS720100D3R200.3Z9C-HXT	10067895	3	D	■	10,0	10,0	40,0	89,0	2,0	9	<input type="checkbox"/>
JS720120D3R050.3Z9C-HXT	10067897	3	D	■	12,0	12,0	45,0	100,0	0,5	9	<input type="checkbox"/>
JS720120D3R100.3Z9C-HXT	10067898	3	D	■	12,0	12,0	45,0	100,0	1,0	9	<input type="checkbox"/>
JS720120D3R200.3Z9C-HXT	10067899	3	D	■	12,0	12,0	45,0	100,0	2,0	9	<input type="checkbox"/>
JS720160D3R100.3Z9C-HXT	10067900	3	D	■	16,0	16,0	65,0	130,0	1,0	9	<input type="checkbox"/>
JS720160D3R200.3Z9C-HXT	10067901	3	D	■	16,0	16,0	65,0	130,0	2,0	9	<input type="checkbox"/>
JS720160D3R300.3Z9C-HXT	10067902	3	D	■	16,0	16,0	65,0	130,0	3,0	9	<input type="checkbox"/>
JS720200D3R100.3Z9C-HXT	10067903	3	D	■	20,0	20,0	62,0	121,0	1,0	9	<input type="checkbox"/>
JS720200D3R200.3Z9C-HXT	10067904	3	D	■	20,0	20,0	62,0	121,0	2,0	9	<input type="checkbox"/>
JS720200D3R300.3Z9C-HXT	10067905	3	D	■	20,0	20,0	62,0	121,0	3,0	9	<input type="checkbox"/>
JS720250D3R100.3Z9C-HXT	10067906	3	D	■	25,0	25,0	78,0	146,0	1,0	9	<input type="checkbox"/>
JS720250D3R200.3Z9C-HXT	10067907	3	D	■	25,0	25,0	78,0	146,0	2,0	9	<input type="checkbox"/>
JS720250D3R300.3Z9C-HXT	10067908	3	D	■	25,0	25,0	78,0	146,0	3,0	9	<input type="checkbox"/>

■ Stocked standard.

Universal

Steel and cast iron

Stainless steel and S-materials

Non ferrous

Hard

Plastic and CFRP

Graphite

X-Heads

Minimaster Plus

Minimaster

JS720

High performance – Titanium – Square – 6 Flutes – Safelock – Corner radius

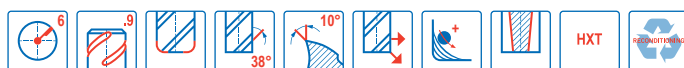
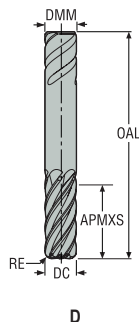

- Tolerances:
- DMM= h5
- DC= e7
- RE= ±0,02 mm
- Regrind possible

Designation	Item number	Length index	Tool shape	DC	DMM	APMXS	OAL	RE	PCEDC	Safelock
				mm	mm	mm	mm	mm		
JS720060D2R050.9Z6-HXT	03060374	2	D	6,0	6,0	17,0	57,0	0,5	6	<input type="checkbox"/>
JS720060D2R100.9Z6-HXT	03060375	2	D	6,0	6,0	17,0	57,0	1,0	6	<input type="checkbox"/>
JS720080D2R050.9Z6-HXT	03060376	2	D	8,0	8,0	23,0	63,0	0,5	6	<input type="checkbox"/>
JS720080D2R100.9Z6-HXT	03061296	2	D	8,0	8,0	23,0	63,0	1,0	6	<input type="checkbox"/>
JS720100D2R050.9Z6-HXT	03060377	2	D	10,0	10,0	26,0	72,0	0,5	6	<input type="checkbox"/>
JS720100D2R100.9Z6-HXT	03060379	2	D	10,0	10,0	26,0	72,0	1,0	6	<input type="checkbox"/>
JS720100D2R200.9Z6-HXT	03060380	2	D	10,0	10,0	26,0	72,0	2,0	6	<input type="checkbox"/>
JS720100D2R300.9Z6-HXT	03060381	2	D	10,0	10,0	26,0	72,0	3,0	6	<input type="checkbox"/>
JS720120D2R050.9Z6-HXT	03060382	2	D	12,0	12,0	30,0	83,0	0,5	6	<input type="checkbox"/>
JS720120D2R100.9Z6-HXT	03060384	2	D	12,0	12,0	30,0	83,0	1,0	6	<input type="checkbox"/>
JS720120D2R200.9Z6-HXT	03060385	2	D	12,0	12,0	30,0	83,0	2,0	6	<input type="checkbox"/>
JS720120D2R300.9Z6-HXT	03060386	2	D	12,0	12,0	30,0	83,0	3,0	6	<input type="checkbox"/>
JS720160D2R050.9Z6-HXT	03060387	2	D	16,0	16,0	44,0	99,0	0,5	6	<input type="checkbox"/>
JS720160D2R100.9Z6-HXT	03060389	2	D	16,0	16,0	44,0	99,0	1,0	6	<input type="checkbox"/>
JS720160D2R200.9Z6-HXT	03060390	2	D	16,0	16,0	44,0	99,0	2,0	6	<input type="checkbox"/>
JS720160D2R300.9Z6-HXT	03060391	2	D	16,0	16,0	44,0	99,0	3,0	6	<input type="checkbox"/>
JS720160D2R400.9Z6-HXT	03060392	2	D	16,0	16,0	44,0	99,0	4,0	6	<input type="checkbox"/>
JS720160D2R600.9Z6-HXT	03060393	2	D	16,0	16,0	44,0	99,0	6,0	6	<input type="checkbox"/>
JS720200D3R050.9Z6-HXT	03060394	3	D	20,0	20,0	62,0	121,0	0,5	6	<input type="checkbox"/>
JS720200D3R100.9Z6-HXT	03060396	3	D	20,0	20,0	62,0	121,0	1,0	6	<input type="checkbox"/>
JS720200D3R200.9Z6-HXT	03060397	3	D	20,0	20,0	62,0	121,0	2,0	6	<input type="checkbox"/>
JS720200D3R300.9Z6-HXT	03060398	3	D	20,0	20,0	62,0	121,0	3,0	6	<input type="checkbox"/>
JS720200D3R400.9Z6-HXT	03060399	3	D	20,0	20,0	62,0	121,0	4,0	6	<input type="checkbox"/>
JS720200D3R500.9Z6-HXT	03060400	3	D	20,0	20,0	62,0	121,0	5,0	6	<input type="checkbox"/>
JS720200D3R600.9Z6-HXT	03060401	3	D	20,0	20,0	62,0	121,0	6,0	6	<input type="checkbox"/>
JS720250D3R050.9Z6-HXT	03060402	3	D	25,0	25,0	78,0	146,0	0,5	6	<input type="checkbox"/>
JS720250D3R100.9Z6-HXT	03060403	3	D	25,0	25,0	78,0	146,0	1,0	6	<input type="checkbox"/>
JS720250D3R200.9Z6-HXT	03060404	3	D	25,0	25,0	78,0	146,0	2,0	6	<input type="checkbox"/>
JS720250D3R300.9Z6-HXT	03060405	3	D	25,0	25,0	78,0	146,0	3,0	6	<input type="checkbox"/>
JS720250D3R400.9Z6-HXT	03060406	3	D	25,0	25,0	78,0	146,0	4,0	6	<input type="checkbox"/>
JS720250D3R600.9Z6-HXT	03060407	3	D	25,0	25,0	78,0	146,0	6,0	6	<input type="checkbox"/>

Safelock available. Delivery time is 6 days.

Universal

Steel and cast iron

Stainless steel and S-materials

Non ferrous

Hard

Plastic and CFRP

Graphite

X-Heads

Minimaster Plus

Minimaster

JS720

High performance – Titanium – Square – 6 Flutes – Safelock – Corner radius – Chip splitters

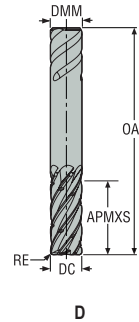

- Tolerances:
- DMM= h5
- DC= e7
- RE= ±0,02 mm
- Chip splitters
- Regrind possible



Designation	Item number	Length index	Tool shape	Chip splitters	DC	DMM	APMXS	OAL	RE	PCEDC	Safelock
					mm	mm	mm	mm	mm		
JS720100D2R050.9Z6C-HXT	03060378	2	D	■	10,0	10,0	26,0	72,0	0,5	6	<input type="checkbox"/>
JS720120D2R050.9Z6C-HXT	03060383	2	D	■	12,0	12,0	30,0	83,0	0,5	6	<input type="checkbox"/>
JS720120D2R100.9Z6C-HXT	03298334	2	D	■	12,0	12,0	30,0	83,0	1,0	6	<input type="checkbox"/>
JS720120D2R200.9Z6C-HXT	03298335	2	D	■	12,0	12,0	30,0	83,0	2,0	6	<input type="checkbox"/>
JS720120D2R250.9Z6C-HXT	03298336	2	D	■	12,0	12,0	30,0	83,0	2,5	6	<input type="checkbox"/>
JS720120D2R300.9Z6C-HXT	03298337	2	D	■	12,0	12,0	30,0	83,0	3,0	6	<input type="checkbox"/>
JS720120D2R310.9Z6C-HXT	03298338	2	D	■	12,0	12,0	30,0	83,0	3,1	6	<input type="checkbox"/>
JS720160D2R050.9Z6C-HXT	03060388	2	D	■	16,0	16,0	44,0	99,0	0,5	6	<input type="checkbox"/>
JS720160D2R100.9Z6C-HXT	03298339	2	D	■	16,0	16,0	44,0	99,0	1,0	6	<input type="checkbox"/>
JS720160D2R200.9Z6C-HXT	03298340	2	D	■	16,0	16,0	44,0	99,0	2,0	6	<input type="checkbox"/>
JS720160D2R250.9Z6C-HXT	03298341	2	D	■	16,0	16,0	44,0	99,0	2,5	6	<input type="checkbox"/>
JS720160D2R300.9Z6C-HXT	03298342	2	D	■	16,0	16,0	44,0	99,0	3,0	6	<input type="checkbox"/>
JS720160D2R310.9Z6C-HXT	03298343	2	D	■	16,0	16,0	44,0	99,0	3,1	6	<input type="checkbox"/>
JS720160D2R400.9Z6C-HXT	03298344	2	D	■	16,0	16,0	44,0	99,0	4,0	6	<input type="checkbox"/>
JS720160D2R600.9Z6C-HXT	03298345	2	D	■	16,0	16,0	44,0	99,0	6,0	6	<input type="checkbox"/>
JS720200D3R050.9Z6C-HXT	03060395	3	D	■	20,0	20,0	62,0	121,0	0,5	6	<input type="checkbox"/>
JS720200D3R100.9Z6C-HXT	03298346	3	D	■	20,0	20,0	62,0	121,0	1,0	6	<input type="checkbox"/>
JS720200D3R200.9Z6C-HXT	03298347	3	D	■	20,0	20,0	62,0	121,0	2,0	6	<input type="checkbox"/>
JS720200D3R250.9Z6C-HXT	03298348	3	D	■	20,0	20,0	62,0	121,0	2,5	6	<input type="checkbox"/>
JS720200D3R300.9Z6C-HXT	03298349	3	D	■	20,0	20,0	62,0	121,0	3,0	6	<input type="checkbox"/>
JS720200D3R310.9Z6C-HXT	03298350	3	D	■	20,0	20,0	62,0	121,0	3,1	6	<input type="checkbox"/>
JS720200D3R400.9Z6C-HXT	03298351	3	D	■	20,0	20,0	62,0	121,0	4,0	6	<input type="checkbox"/>
JS720200D3R500.9Z6C-HXT	03298352	3	D	■	20,0	20,0	62,0	121,0	5,0	6	<input type="checkbox"/>
JS720200D3R600.9Z6C-HXT	03298353	3	D	■	20,0	20,0	62,0	121,0	6,0	6	<input type="checkbox"/>
JS720250D3R050.9Z6C-HXT	03066461	3	D	■	25,0	25,0	78,0	146,0	0,5	6	<input type="checkbox"/>
JS720250D3R100.9Z6C-HXT	03298354	3	D	■	25,0	25,0	78,0	146,0	1,0	6	<input type="checkbox"/>
JS720250D3R200.9Z6C-HXT	03298355	3	D	■	25,0	25,0	78,0	146,0	2,0	6	<input type="checkbox"/>
JS720250D3R300.9Z6C-HXT	03298356	3	D	■	25,0	25,0	78,0	146,0	3,0	6	<input type="checkbox"/>
JS720250D3R400.9Z6C-HXT	03298357	3	D	■	25,0	25,0	78,0	146,0	4,0	6	<input type="checkbox"/>
JS720250D3R600.9Z6C-HXT	03298358	3	D	■	25,0	25,0	78,0	146,0	6,0	6	<input type="checkbox"/>

■ Stocked standard.

Universal

Steel and cast iron

Stainless steel and S-materials

Non ferrous

Hard

Plastic and CFRP

Graphite

X-Heads

Mimimaster Plus

Mimimaster

JS720

High performance – Titanium – Square – 9 Flutes – Safelock – Corner radius

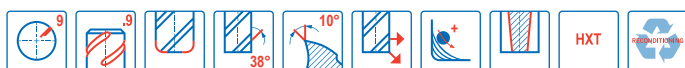
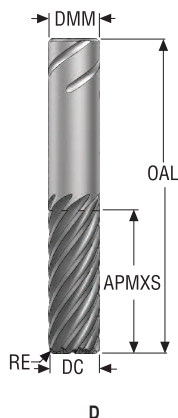

- Tolerances:
- DMM= h5
- DC= e7
- RE= ±0,02 mm
- Regrind possible

Designation	Item number	Length index	Tool shape	DC	DMM	APMXS	OAL	RE	PCEDC	Safelock
				mm	mm	mm	mm	mm		
JS720100D2R050.9Z9-HXT	10067909	2	D	10,0	10,0	26,0	72,0	0,5	9	<input type="checkbox"/>
JS720100D2R100.9Z9-HXT	10067910	2	D	10,0	10,0	26,0	72,0	1,0	9	<input type="checkbox"/>
JS720100D2R200.9Z9-HXT	10067911	2	D	10,0	10,0	26,0	72,0	2,0	9	<input type="checkbox"/>
JS720120D2R050.9Z9-HXT	10067912	2	D	12,0	12,0	30,0	83,0	0,5	9	<input type="checkbox"/>
JS720120D2R100.9Z9-HXT	10067913	2	D	12,0	12,0	30,0	83,0	1,0	9	<input type="checkbox"/>
JS720120D2R200.9Z9-HXT	10067914	2	D	12,0	12,0	30,0	83,0	2,0	9	<input type="checkbox"/>
JS720160D2R100.9Z9-HXT	10008295	2	D	16,0	16,0	44,0	99,0	1,0	9	<input type="checkbox"/>
JS720160D2R200.9Z9-HXT	10008296	2	D	16,0	16,0	44,0	99,0	2,0	9	<input type="checkbox"/>
JS720160D2R300.9Z9-HXT	10008297	2	D	16,0	16,0	44,0	99,0	3,0	9	<input type="checkbox"/>
JS720250D2R100.9Z9-HXT	10008298	2	D	25,0	25,0	50,0	125,0	1,0	9	<input type="checkbox"/>
JS720250D2R200.9Z9-HXT	10008299	2	D	25,0	25,0	50,0	125,0	2,0	9	<input type="checkbox"/>
JS720250D2R300.9Z9-HXT	10008300	2	D	25,0	25,0	50,0	125,0	3,0	9	<input type="checkbox"/>
JS720100D3R050.9Z9-HXT	10067915	3	D	10,0	10,0	40,0	89,0	0,5	9	<input type="checkbox"/>
JS720100D3R100.9Z9-HXT	10067916	3	D	10,0	10,0	40,0	89,0	1,0	9	<input type="checkbox"/>
JS720100D3R200.9Z9-HXT	10067917	3	D	10,0	10,0	40,0	89,0	2,0	9	<input type="checkbox"/>
JS720120D3R050.9Z9-HXT	10067918	3	D	12,0	12,0	45,0	100,0	0,5	9	<input type="checkbox"/>
JS720120D3R100.9Z9-HXT	10067919	3	D	12,0	12,0	45,0	100,0	1,0	9	<input type="checkbox"/>
JS720120D3R200.9Z9-HXT	10067921	3	D	12,0	12,0	45,0	100,0	2,0	9	<input type="checkbox"/>
JS720160D3R100.9Z9-HXT	10008301	3	D	16,0	16,0	65,0	130,0	1,0	9	<input type="checkbox"/>
JS720160D3R200.9Z9-HXT	10008302	3	D	16,0	16,0	65,0	130,0	2,0	9	<input type="checkbox"/>
JS720160D3R300.9Z9-HXT	10008303	3	D	16,0	16,0	65,0	130,0	3,0	9	<input type="checkbox"/>
JS720200D3R100.9Z9-HXT	10008304	3	D	20,0	20,0	62,0	121,0	1,0	9	<input type="checkbox"/>
JS720200D3R200.9Z9-HXT	10008305	3	D	20,0	20,0	62,0	121,0	2,0	9	<input type="checkbox"/>
JS720200D3R300.9Z9-HXT	10008306	3	D	20,0	20,0	62,0	121,0	3,0	9	<input type="checkbox"/>
JS720250D3R100.9Z9-HXT	10008307	3	D	25,0	25,0	78,0	146,0	1,0	9	<input type="checkbox"/>
JS720250D3R200.9Z9-HXT	10008308	3	D	25,0	25,0	78,0	146,0	2,0	9	<input type="checkbox"/>
JS720250D3R300.9Z9-HXT	10008309	3	D	25,0	25,0	78,0	146,0	3,0	9	<input type="checkbox"/>

Safelock available. Delivery time is 6 days.

Universal

Steel and cast iron

Stainless steel and S-materials

Non ferrous

Hard

Plastic and CFRP

Graphite

X-Heads

Minimaster Plus

Minimaster

Cutting data – JS720 Side milling PCEDC =6

SMG		a _e /DC	a _p /DC	f _z							v _c
				6	8	10	12	16	20	25	
M1	E	0.400	1.1	0.032	0.044	0.055	0.065	0.080	0.095	0.11	110 (85 – 140)
		0,400	1,1	0,0013	0,0017	0,0022	0,0026	0,0032	0,0038	0,0044	360 (280 – 450)
M2	E	0.400	1.1	0.030	0.040	0.050	0.060	0.075	0.085	0.095	90 (70 – 110)
		0,400	1,1	0,0012	0,0016	0,0020	0,0024	0,0030	0,0034	0,0038	295 (230 – 360)
M3	E	0.400	1.1	0.030	0.040	0.050	0.060	0.075	0.085	0.095	70 (55 – 99)
		0,400	1,1	0,0012	0,0016	0,0020	0,0024	0,0030	0,0034	0,0038	230 (190 – 320)
M4	E	0.400	1.1	0.030	0.040	0.050	0.060	0.075	0.085	0.095	80 (60 – 99)
		0,400	1,1	0,0012	0,0016	0,0020	0,0024	0,0030	0,0034	0,0038	260 (200 – 320)
M5	E	0.400	1.1	0.030	0.040	0.050	0.060	0.075	0.085	0.095	65 (50 – 83)
		0,400	1,1	0,0012	0,0016	0,0020	0,0024	0,0030	0,0034	0,0038	215 (170 – 270)
S1	E	0.0500	2.6	0.046	0.060	0.075	0.090	0.11	0.13	0.14	43 (29 – 71)
		0,0500	2,6	0,0018	0,0024	0,0030	0,0036	0,0044	0,0050	0,0055	140 (96 – 230)
S2	E	0.0500	2.6	0.046	0.060	0.075	0.090	0.11	0.13	0.14	34 (23 – 57)
		0,0500	2,6	0,0018	0,0024	0,0030	0,0036	0,0044	0,0050	0,0055	110 (76 – 180)
S3	E	0.0500	2.6	0.042	0.055	0.070	0.085	0.10	0.12	0.13	30 (20 – 49)
		0,0500	2,6	0,0017	0,0022	0,0028	0,0034	0,0040	0,0048	0,0050	100 (66 – 160)
S11	E	0.400	1.1	0.030	0.040	0.050	0.060	0.075	0.085	0.095	105 (78 – 120)
		0,400	1,1	0,0012	0,0016	0,0020	0,0024	0,0030	0,0034	0,0038	345 (260 – 390)
S12	E	0.400	1.1	0.030	0.040	0.050	0.060	0.075	0.085	0.095	80 (60 – 99)
		0,400	1,1	0,0012	0,0016	0,0020	0,0024	0,0030	0,0034	0,0038	260 (200 – 320)
S13	E	0.400	1.1	0.030	0.040	0.050	0.060	0.075	0.085	0.095	80 (60 – 99)
		0,400	1,1	0,0012	0,0016	0,0020	0,0024	0,0030	0,0034	0,0038	260 (200 – 320)

For cutting data recalculations, see pages 556 - 563

SMG = Seco material group
 Coolant = A=air D=dry E=emulsion M=mist spray
 v_c = m/min (sf/min)
 f_z = mm (in/tooth)
 a_p = mm/DC (in/DC) = factor
 a_e = mm/DC (in/DC) = factor
 All cutting data are target values

Cutting data – JS720 Side milling advanced roughing $a_p/DC=0,07$ PCEDC =6

SMG		a_p/DC	f_z						v_c	
			6	8	10	12	16	20		25
M1	E	1,9	0,065	0,085	0,11	0,13	0,16	0,18	0,20	140 (110 – 180)
		1,9	0,0026	0,0034	0,0044	0,0050	0,0065	0,0070	0,0080	460 (370 – 590)
M2	E	1,9	0,060	0,080	0,095	0,12	0,14	0,16	0,19	115 (91 – 150)
		1,9	0,0024	0,0032	0,0038	0,0048	0,0055	0,0065	0,0075	375 (300 – 490)
M3	E	1,9	0,060	0,080	0,095	0,12	0,14	0,16	0,19	90 (72 – 120)
		1,9	0,0024	0,0032	0,0038	0,0048	0,0055	0,0065	0,0075	295 (240 – 390)
M4	E	1,9	0,060	0,080	0,095	0,12	0,14	0,16	0,19	105 (78 – 120)
		1,9	0,0024	0,0032	0,0038	0,0048	0,0055	0,0065	0,0075	345 (260 – 390)
M5	E	1,9	0,060	0,080	0,095	0,12	0,14	0,16	0,19	85 (65 – 100)
		1,9	0,0024	0,0032	0,0038	0,0048	0,0055	0,0065	0,0075	280 (220 – 320)
S1	E	2,6	0,038	0,050	0,065	0,075	0,095	0,11	0,12	41 (28 – 68)
		2,6	0,0015	0,0020	0,0026	0,0030	0,0038	0,0044	0,0048	135 (92 – 220)
S2	E	2,6	0,038	0,050	0,065	0,075	0,095	0,11	0,12	33 (22 – 54)
		2,6	0,0015	0,0020	0,0026	0,0030	0,0038	0,0044	0,0048	110 (73 – 170)
S3	E	2,6	0,036	0,048	0,060	0,070	0,085	0,10	0,11	29 (20 – 47)
		2,6	0,0014	0,0019	0,0024	0,0028	0,0034	0,0040	0,0044	95 (66 – 150)
S11	E	1,9	0,060	0,080	0,095	0,12	0,14	0,16	0,19	135 (110 – 160)
		1,9	0,0024	0,0032	0,0038	0,0048	0,0055	0,0065	0,0075	445 (370 – 520)
S12	E	1,9	0,060	0,080	0,095	0,12	0,14	0,16	0,19	105 (78 – 120)
		1,9	0,0024	0,0032	0,0038	0,0048	0,0055	0,0065	0,0075	345 (260 – 390)
S13	E	1,9	0,060	0,080	0,095	0,12	0,14	0,16	0,19	105 (78 – 120)
		1,9	0,0024	0,0032	0,0038	0,0048	0,0055	0,0065	0,0075	345 (260 – 390)

Cutting data – JS720 Side milling advanced roughing $a_p/DC=0,07$ PCEDC =9

SMG		a_p/DC	f_z					v_c
			10	12	16	20	25	
M1	E	2,0	0,11	0,13	0,16	0,18	0,20	125 (98 – 160)
		2,0	0,0044	0,0050	0,0065	0,0070	0,0080	410 (330 – 520)
M2	E	2,0	0,095	0,12	0,14	0,16	0,19	105 (82 – 130)
		2,0	0,0038	0,0048	0,0055	0,0065	0,0075	345 (270 – 420)
M3	E	2,0	0,095	0,12	0,14	0,16	0,19	80 (64 – 110)
		2,0	0,0038	0,0048	0,0055	0,0065	0,0075	260 (210 – 360)
M4	E	2,0	0,095	0,12	0,14	0,16	0,19	95 (70 – 110)
		2,0	0,0038	0,0048	0,0055	0,0065	0,0075	310 (230 – 360)
M5	E	2,0	0,095	0,12	0,14	0,16	0,19	75 (59 – 96)
		2,0	0,0038	0,0048	0,0055	0,0065	0,0075	245 (200 – 310)
S1	E	2,8	0,065	0,075	0,095	0,11	0,12	37 (25 – 61)
		2,8	0,0026	0,0030	0,0038	0,0044	0,0048	120 (83 – 200)
S2	E	2,8	0,065	0,075	0,095	0,11	0,12	30 (20 – 49)
		2,8	0,0026	0,0030	0,0038	0,0044	0,0048	100 (66 – 160)
S3	E	2,8	0,060	0,070	0,085	0,10	0,11	26 (18 – 43)
		2,8	0,0024	0,0028	0,0034	0,0040	0,0044	85 (60 – 140)
S11	E	2,0	0,095	0,12	0,14	0,16	0,19	120 (91 – 150)
		2,0	0,0038	0,0048	0,0055	0,0065	0,0075	395 (300 – 490)
S12	E	2,0	0,095	0,12	0,14	0,16	0,19	95 (70 – 110)
		2,0	0,0038	0,0048	0,0055	0,0065	0,0075	310 (230 – 360)
S13	E	2,0	0,095	0,12	0,14	0,16	0,19	95 (70 – 110)
		2,0	0,0038	0,0048	0,0055	0,0065	0,0075	310 (230 – 360)

For cutting data recalculations, see pages 556 - 563

SMG = Seco material group
Coolant = A=air D=dry E=emulsion M=mist spray
 v_c = m/min (sf/min)
 f_z = mm (in/tooth)
 a_p = mm/DC (in/DC) = factor
 a_e = mm/DC (in/DC) = factor
All cutting data are target values

Universal
Steel and cast iron
Stainless steel and S-materials
Non ferrous
Hard
Plastic and CFRP
Graphite
X-Heads
Minimaster Plus
Minimaster

JS730

High performance – Titanium – Ball nose – 6 Flutes – Cylindrical

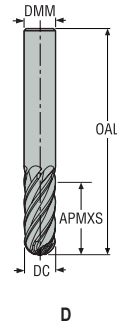

Universal
Steel and cast iron
Stainless steel and S-materials
Non ferrous
Hard
Plastic and cfrp
Graphite
X-Heads
Minimaster Plus
Minimaster

- Tolerances:
- DMM= h5
- DC= e7
- RE= ±0,02 mm
- Two flutes to centre
- Regrind possible

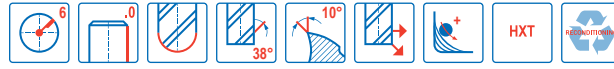

Designation	Item number	Length index	Tool shape	DC	DMM	APMXS	OAL	PCEDC	Cylindrical
				mm	mm	mm	mm		
JS730060D2B.0Z6-HXT	03067605	2	D	6,0	6,0	17,0	57,0	6	■
JS730080D2B.0Z6-HXT	03067606	2	D	8,0	8,0	23,0	63,0	6	■
JS730100D2B.0Z6-HXT	03067607	2	D	10,0	10,0	26,0	72,0	6	■
JS730120D2B.0Z6-HXT	03067608	2	D	12,0	12,0	30,0	83,0	6	■
JS730160D2B.0Z6-HXT	03067609	2	D	16,0	16,0	44,0	99,0	6	■
JS730200D3B.0Z6-HXT	03067610	3	D	20,0	20,0	62,0	121,0	6	■
JS730250D3B.0Z6-HXT	03067611	3	D	25,0	25,0	78,0	146,0	6	■

■ Stocked standard.

JS730

High performance – Titanium – Ball nose – 6 Flutes – Weldon

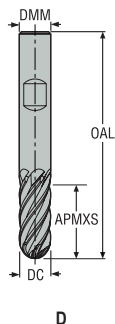

D

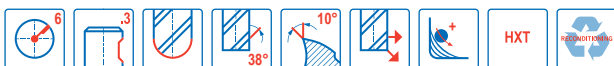

- Tolerances:
- DMM= h5
- DC= e7
- RE= ±0,02 mm
- Two flutes to centre
- Regrind possible

Designation	Item number	Length index	Tool shape	DC	DMM	APMXS	OAL	PCEDC	Weldon
				mm	mm	mm	mm		
JS730060D2B.3Z6-HXT	03067778	2	D	6,0	6,0	17,0	57,0	6	<input type="checkbox"/>
JS730080D2B.3Z6-HXT	03067779	2	D	8,0	8,0	23,0	63,0	6	<input type="checkbox"/>
JS730100D2B.3Z6-HXT	03067780	2	D	10,0	10,0	26,0	72,0	6	<input type="checkbox"/>
JS730120D2B.3Z6-HXT	03067781	2	D	12,0	12,0	30,0	83,0	6	<input type="checkbox"/>
JS730160D2B.3Z6-HXT	03067782	2	D	16,0	16,0	44,0	99,0	6	<input type="checkbox"/>
JS730200D3B.3Z6-HXT	03067783	3	D	20,0	20,0	62,0	121,0	6	<input type="checkbox"/>
JS730250D3B.3Z6-HXT	03067784	3	D	25,0	25,0	78,0	146,0	6	<input type="checkbox"/>

Weldon available. Delivery time is 3 days.

Universal

Steel and cast iron

Stainless steel and S-materials

Non ferrous

Hard

Plastic and CFRP

Graphite

X-Heads

Minimaster Plus

Minimaster

JS730

High performance – Titanium – Ball nose – 6 Flutes – Safelock

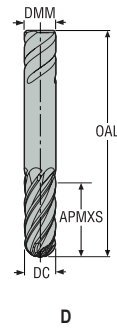

Universal
Steel and cast iron
Stainless steel and S-materials
Non ferrous
Hard
Plastic and cfrp
Graphite
X-Heads
Minimaster Plus
Minimaster

- Tolerances:
- DMM= h5
- DC= e7
- RE= ±0,02 mm
- Two flutes to centre
- Regrind possible

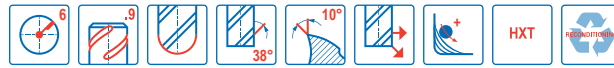

Designation	Item number	Length index	Tool shape	DC	DMM	APMXS	OAL	PCEDC	Safelock
				mm	mm	mm	mm		
JS730060D2B.9Z6-HXT	03067785	2	D	6,0	6,0	17,0	57,0	6	<input type="checkbox"/>
JS730080D2B.9Z6-HXT	03067786	2	D	8,0	8,0	23,0	63,0	6	<input type="checkbox"/>
JS730100D2B.9Z6-HXT	03067787	2	D	10,0	10,0	26,0	72,0	6	<input type="checkbox"/>
JS730120D2B.9Z6-HXT	03067788	2	D	12,0	12,0	30,0	83,0	6	<input type="checkbox"/>
JS730160D2B.9Z6-HXT	03067789	2	D	16,0	16,0	44,0	99,0	6	<input type="checkbox"/>
JS730200D3B.9Z6-HXT	03067790	3	D	20,0	20,0	62,0	121,0	6	<input type="checkbox"/>
JS730250D3B.9Z6-HXT	03067791	3	D	25,0	25,0	78,0	146,0	6	<input type="checkbox"/>

Safelock available. Delivery time is 6 days.

Cutting data – JS730 Side milling roughing

SMG		a _e /DC	a _p /DC	f _z						v _c	
				6	8	10	12	16	20		25
M1	E	0.100	1.8	0.048	0.065	0.080	0.095	0.12	0.14	0.15	140 (89 – 150)
		0,100	1,8	0,0019	0,0026	0,0032	0,0038	0,0048	0,0055	0,0060	460 (300 – 490)
M2	E	0.150	2.2	0.030	0.040	0.050	0.060	0.075	0.085	0.095	110 (70 – 120)
		0,150	2,2	0,0012	0,0016	0,0020	0,0024	0,0030	0,0034	0,0038	360 (230 – 390)
M3	E	0.100	1.8	0.048	0.065	0.080	0.095	0.12	0.14	0.15	85 (55 – 99)
		0,100	1,8	0,0019	0,0026	0,0032	0,0038	0,0048	0,0055	0,0060	280 (190 – 320)
M4	E	0.100	1.8	0.042	0.055	0.070	0.085	0.10	0.12	0.13	90 (57 – 100)
		0,100	1,8	0,0017	0,0022	0,0028	0,0034	0,0040	0,0048	0,0050	295 (190 – 320)
M5	E	0.100	1.8	0.042	0.055	0.070	0.085	0.10	0.12	0.13	75 (47 – 85)
		0,100	1,8	0,0017	0,0022	0,0028	0,0034	0,0040	0,0048	0,0050	245 (160 – 270)
S1	E	0.150	2.2	0.032	0.044	0.055	0.065	0.080	0.090	0.10	43 (29 – 70)
		0,150	2,2	0,0013	0,0017	0,0022	0,0026	0,0032	0,0036	0,0040	140 (96 – 220)
S2	E	0.150	2.2	0.032	0.044	0.055	0.065	0.080	0.090	0.10	34 (23 – 57)
		0,150	2,2	0,0013	0,0017	0,0022	0,0026	0,0032	0,0036	0,0040	110 (76 – 180)
S3	E	0.150	2.2	0.030	0.040	0.050	0.060	0.075	0.085	0.095	30 (20 – 49)
		0,150	2,2	0,0012	0,0016	0,0020	0,0024	0,0030	0,0034	0,0038	100 (66 – 160)
S11	E	0.300	1.2	0.030	0.040	0.050	0.060	0.075	0.085	0.095	130 (79 – 130)
		0,300	1,2	0,0012	0,0016	0,0020	0,0024	0,0030	0,0034	0,0038	425 (260 – 420)
S12	E	0.300	1.2	0.030	0.040	0.050	0.060	0.075	0.085	0.095	100 (61 – 100)
		0,300	1,2	0,0012	0,0016	0,0020	0,0024	0,0030	0,0034	0,0038	330 (210 – 320)
S13	E	0.300	1.2	0.026	0.034	0.044	0.050	0.065	0.075	0.085	100 (62 – 100)
		0,300	1,2	0,0010	0,0013	0,0017	0,0020	0,0026	0,0030	0,0034	330 (210 – 320)

Cutting data – JS730 Side milling advanced roughing a_e/DC=0,07

SMG		a _p /DC	f _z						v _c	
			6	8	10	12	16	20		25
M1	E	1.9	0.055	0.075	0.095	0.11	0.14	0.16	0.18	145 (93 – 150)
		1,9	0,0022	0,0030	0,0038	0,0044	0,0055	0,0065	0,0070	475 (310 – 490)
M2	E	2.2	0.042	0.055	0.070	0.085	0.10	0.12	0.13	125 (78 – 130)
		2,2	0,0017	0,0022	0,0028	0,0034	0,0040	0,0048	0,0050	410 (260 – 420)
M3	E	1.9	0.055	0.075	0.095	0.11	0.14	0.16	0.18	90 (58 – 100)
		1,9	0,0022	0,0030	0,0038	0,0044	0,0055	0,0065	0,0070	295 (200 – 320)
M4	E	1.9	0.050	0.065	0.080	0.095	0.12	0.14	0.16	95 (59 – 100)
		1,9	0,0020	0,0026	0,0032	0,0038	0,0048	0,0055	0,0065	310 (200 – 320)
M5	E	1.9	0.050	0.065	0.080	0.095	0.12	0.14	0.16	80 (50 – 89)
		1,9	0,0020	0,0026	0,0032	0,0038	0,0048	0,0055	0,0065	260 (170 – 290)
S1	E	2.2	0.046	0.060	0.075	0.090	0.11	0.13	0.15	47 (32 – 79)
		2,2	0,0018	0,0024	0,0030	0,0036	0,0044	0,0050	0,0060	155 (110 – 250)
S2	E	2.2	0.046	0.060	0.075	0.090	0.11	0.13	0.15	38 (26 – 63)
		2,2	0,0018	0,0024	0,0030	0,0036	0,0044	0,0050	0,0060	125 (86 – 200)
S3	E	2.2	0.042	0.055	0.070	0.085	0.10	0.12	0.13	33 (23 – 55)
		2,2	0,0017	0,0022	0,0028	0,0034	0,0040	0,0048	0,0050	110 (76 – 180)
S11	E	1.9	0.050	0.070	0.085	0.10	0.13	0.15	0.17	150 (94 – 150)
		1,9	0,0020	0,0028	0,0034	0,0040	0,0050	0,0060	0,0065	490 (310 – 490)
S12	E	1.9	0.050	0.070	0.085	0.10	0.13	0.15	0.17	115 (72 – 110)
		1,9	0,0020	0,0028	0,0034	0,0040	0,0050	0,0060	0,0065	375 (240 – 360)
S13	E	1.9	0.046	0.060	0.075	0.090	0.11	0.13	0.15	120 (74 – 120)
		1,9	0,0018	0,0024	0,0030	0,0036	0,0044	0,0050	0,0060	395 (250 – 390)

For cutting data recalculations, see pages 556 - 563

SMG = Seco material group
Coolant = A=air D=dry E=emulsion M=mist spray
v_c = m/min (sf/min)
f_z = mm (in/tooth)
a_p = mm/DC (in/DC) = factor
a_e = mm/DC (in/DC) = factor
All cutting data are target values

Universal
Steel and cast iron
Stainless steel and S-materials
Non ferrous
Hard
Plastic and CFRP
Graphite
X-Heads
Minimaster Plus
Minimaster

JHP751

High performance – Titanium – Square – 2-4 Flutes – Cylindrical – Corner radius

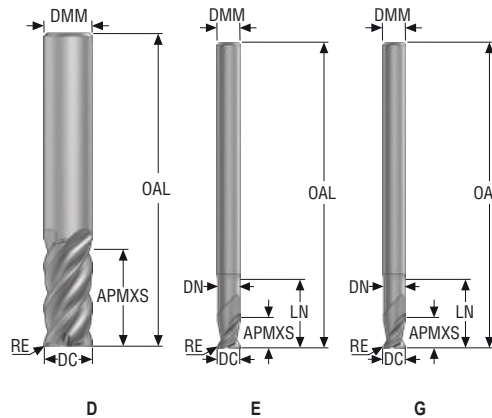

- Tolerances:
- DMM=h5
- DC=-0,02/-0,04 mm
- RE= ±0,02 mm
- Regrind possible if DC is ≥Ø6

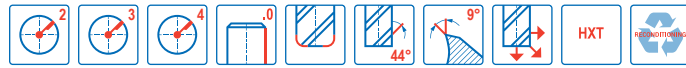

Designation	Grade	Item number	Length index	Tool shape	DC	DMM	APMXS	OAL	LN	DN	RE	PCEDC	Cylindrical
					mm	mm	mm	mm	mm	mm	mm		
JHP751080D1R040.0Z4	HXT	10105487	1	D	8,0	8,0	16,0	58,0	-	-	0,4	4	■
JHP751100D1R040.0Z4	HXT	10105548	1	D	10,0	10,0	20,0	66,0	-	-	0,4	4	■
JHP751100D1R150.0Z4	HXT	10105549	1	D	10,0	10,0	20,0	66,0	-	-	1,5	4	■
JHP751120D1R040.0Z4	HXT	10105550	1	D	12,0	12,0	24,0	75,0	-	-	0,4	4	■
JHP751120D1R150.0Z4	HXT	10105552	1	D	12,0	12,0	24,0	75,0	-	-	1,5	4	■
JHP751160D1R040.0Z4	HXT	10105581	1	D	16,0	16,0	32,0	92,0	-	-	0,4	4	■
JHP751160D1R150.0Z4	HXT	10105582	1	D	16,0	16,0	32,0	92,0	-	-	1,5	4	■
JHP751200D1R080.0Z4	HXT	10105583	1	D	20,0	20,0	40,0	104,0	-	-	0,8	4	■
JHP751020G2R020.0Z2	HXT	10105584	2	G	2,0	3,0	3,0	38,0	6,0	1,9	0,2	2	■
JHP751030G2R020.0Z2	HXT	10105585	2	E	3,0	3,0	4,5	38,0	9,0	2,8	0,2	2	■
JHP751040G2R020.0Z2	HXT	10105586	2	G	4,0	6,0	6,0	50,0	9,0	3,7	0,2	2	■
JHP751050G2R030.0Z2	HXT	10105587	2	G	5,0	6,0	7,5	50,0	9,0	4,6	0,3	2	■
JHP751060E2R030.0Z3	HXT	10105588	2	E	6,0	6,0	9,0	57,0	19,0	5,6	0,3	3	■
JHP751080E2R040.0Z4	HXT	10105589	2	E	8,0	8,0	16,0	63,0	24,0	7,4	0,4	4	■
JHP751100E2R040.0Z4	HXT	10105590	2	E	10,0	10,0	20,0	72,0	30,0	9,4	0,4	4	■
JHP751100E2R080.0Z4	HXT	10105591	2	E	10,0	10,0	20,0	72,0	30,0	9,4	0,8	4	■
JHP751100E2R200.0Z4	HXT	10105593	2	E	10,0	10,0	20,0	72,0	30,0	9,4	2,0	4	■
JHP751120E2R040.0Z4	HXT	10105594	2	E	12,0	12,0	24,0	83,0	35,0	11,4	0,4	4	■
JHP751120E2R080.0Z4	HXT	10105595	2	E	12,0	12,0	24,0	83,0	35,0	11,4	0,8	4	■
JHP751120E2R310.0Z4	HXT	10105596	2	E	12,0	12,0	24,0	83,0	35,0	11,4	3,1	4	■
JHP751140E2R080.0Z4	HXT	10105597	2	E	14,0	14,0	28,0	92,0	45,0	13,4	0,8	4	■
JHP751160E2R040.0Z4	HXT	10105598	2	E	16,0	16,0	32,0	104,0	52,0	15,4	0,4	4	■
JHP751160E2R080.0Z4	HXT	10105599	2	E	16,0	16,0	32,0	104,0	52,0	15,4	0,8	4	■
JHP751160E2R200.0Z4	HXT	10105600	2	E	16,0	16,0	32,0	104,0	52,0	15,4	2,0	4	■
JHP751200E2R080.0Z4	HXT	10105601	2	E	20,0	20,0	40,0	129,0	75,0	19,4	0,8	4	■

■ Stocked standard.

Universal

Steel and cast iron

Stainless steel and S-materials

Non ferrous

Hard

Plastic and CFRP

Graphite

X-Heads

Minimaster Plus

Minimaster

JHP751

High performance – Titanium – Square – 2-4 Flutes – Weldon – Corner radius

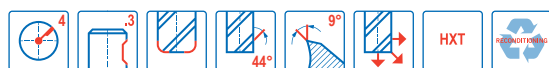
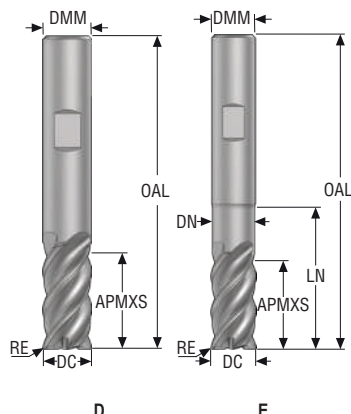

- Tolerances:
- DMM=h5
- DC=-0,02/-0,04 mm
- RE= ±0,02 mm
- Regrind possible if DC is ≥Ø6

Designation	Grade	Item number	Length index	Tool shape	DC	DMM	APMXS	OAL	LN	DN	RE	PCEDC	Weldon
					mm	mm	mm	mm	mm	mm	mm		
JHP751080D1R040.3Z4	HXT	10105739	1	D	8,0	8,0	16,0	58,0	-	-	0,4	4	■
JHP751100D1R040.3Z4	HXT	10105740	1	D	10,0	10,0	20,0	66,0	-	-	0,4	4	■
JHP751100D1R150.3Z4	HXT	10105742	1	D	10,0	10,0	20,0	66,0	-	-	1,5	4	■
JHP751120D1R040.3Z4	HXT	10105743	1	D	12,0	12,0	24,0	75,0	-	-	0,4	4	■
JHP751120D1R150.3Z4	HXT	10105744	1	D	12,0	12,0	24,0	75,0	-	-	1,5	4	■
JHP751160D1R040.3Z4	HXT	10105745	1	D	16,0	16,0	32,0	92,0	-	-	0,4	4	■
JHP751160D1R150.3Z4	HXT	10105746	1	D	16,0	16,0	32,0	92,0	-	-	1,5	4	■
JHP751200D1R080.3Z4	HXT	10105747	1	D	20,0	20,0	40,0	104,0	-	-	0,8	4	■
JHP751080E2R040.3Z4	HXT	10105748	2	E	8,0	8,0	16,0	63,0	24,0	7,4	0,4	4	■
JHP751100E2R040.3Z4	HXT	10105749	2	E	10,0	10,0	20,0	72,0	30,0	9,4	0,4	4	■
JHP751100E2R080.3Z4	HXT	10105750	2	E	10,0	10,0	20,0	72,0	30,0	9,4	0,8	4	■
JHP751100E2R200.3Z4	HXT	10105751	2	E	10,0	10,0	20,0	72,0	30,0	9,4	2,0	4	■
JHP751120E2R040.3Z4	HXT	10105752	2	E	12,0	12,0	24,0	83,0	35,0	11,4	0,4	4	■
JHP751120E2R080.3Z4	HXT	10105753	2	E	12,0	12,0	24,0	83,0	35,0	11,4	0,8	4	■
JHP751120E2R310.3Z4	HXT	10105754	2	E	12,0	12,0	24,0	83,0	35,0	11,4	3,1	4	■
JHP751140E2R080.3Z4	HXT	10105755	2	E	14,0	14,0	28,0	92,0	45,0	13,4	0,8	4	■
JHP751160E2R040.3Z4	HXT	10105756	2	E	16,0	16,0	32,0	104,0	52,0	15,4	0,4	4	■
JHP751160E2R080.3Z4	HXT	10105757	2	E	16,0	16,0	32,0	104,0	52,0	15,4	0,8	4	■
JHP751160E2R200.3Z4	HXT	10105758	2	E	16,0	16,0	32,0	104,0	52,0	15,4	2,0	4	■
JHP751200E2R080.3Z4	HXT	10105759	2	E	20,0	20,0	40,0	129,0	75,0	19,4	0,8	4	■

■ Stocked standard.

Universal

Steel and cast iron

Stainless steel and S-materials

Non ferrous

Hard

Plastic and CFRP

Graphite

X-Heads

Minimaster Plus

Minimaster

Cutting data – JHP751 Side milling

SMG		a _e /DC	a _p /DC	f _z											v _c
				2	3	4	5	6	8	10	12	14	16	20	
S1	E/M/A	0.0600	1.2	0.016	0.024	0.032	0.040	0.048	0.065	0.080	0.095	0.11	0.12	0.14	48 (33 – 64)
		0,0600	1,2	0,00065	0,00095	0,0013	0,0016	0,0019	0,0026	0,0032	0,0038	0,0044	0,0048	0,0055	155 (110 – 200)
S2	E/M/A	0.0600	1.2	0.016	0.024	0.032	0.040	0.048	0.065	0.080	0.095	0.11	0.12	0.14	39 (26 – 51)
		0,0600	1,2	0,00065	0,00095	0,0013	0,0016	0,0019	0,0026	0,0032	0,0038	0,0044	0,0048	0,0055	130 (86 – 160)
S3	E/M/A	0.0400	1.2	0.012	0.018	0.024	0.030	0.036	0.048	0.060	0.070	0.080	0.090	0.10	33 (26 – 50)
		0,0400	1,2	0,00048	0,00070	0,00095	0,0012	0,0014	0,0019	0,0024	0,0028	0,0032	0,0036	0,0040	110 (86 – 160)
S11	E/M/A	0.0800	1.2	0.016	0.024	0.032	0.040	0.048	0.065	0.080	0.095	0.11	0.12	0.14	145 (130 – 180)
		0,0800	1,2	0,00065	0,00095	0,0013	0,0016	0,0019	0,0026	0,0032	0,0038	0,0044	0,0048	0,0055	475 (430 – 590)
S12	E/M/A	0.0800	1.2	0.016	0.024	0.032	0.040	0.048	0.065	0.080	0.095	0.11	0.12	0.14	110 (95 – 140)
		0,0800	1,2	0,00065	0,00095	0,0013	0,0016	0,0019	0,0026	0,0032	0,0038	0,0044	0,0048	0,0055	360 (320 – 450)
S13	E/M/A	0.0800	1.2	0.014	0.020	0.028	0.034	0.042	0.055	0.070	0.085	0.095	0.10	0.12	90 (76 – 110)
		0,0800	1,2	0,00055	0,00080	0,0011	0,0013	0,0017	0,0022	0,0028	0,0034	0,0038	0,0040	0,0048	295 (250 – 360)

Cutting data – JHP751 Slot milling

SMG		a _p /DC	f _z											v _c
			2	3	4	5	6	8	10	12	14	16	20	
S1	E/M/A	0.44	0.0075	0.011	0.015	0.019	0.022	0.030	0.038	0.044	0.050	0.055	0.065	30 (20 – 39)
		0,44	0,00030	0,00044	0,00060	0,00075	0,00085	0,0012	0,0015	0,0017	0,0020	0,0022	0,0026	100 (66 – 120)
S2	E/M/A	0.44	0.0075	0.011	0.015	0.019	0.022	0.030	0.038	0.044	0.050	0.055	0.065	24 (17 – 32)
		0,44	0,00030	0,00044	0,00060	0,00075	0,00085	0,0012	0,0015	0,0017	0,0020	0,0022	0,0026	80 (56 – 100)
S3	E/M/A	0.34	0.0046	0.0070	0.0095	0.012	0.014	0.019	0.024	0.028	0.032	0.034	0.040	20 (15 – 29)
		0,34	0,00018	0,00028	0,00038	0,00048	0,00055	0,00075	0,00095	0,0011	0,0013	0,0013	0,0016	65 (50 – 95)
S11	E/M/A	0.70	0.0085	0.013	0.017	0.022	0.026	0.034	0.044	0.050	0.055	0.065	0.075	90 (78 – 110)
		0,70	0,00034	0,00050	0,00065	0,00085	0,0010	0,0013	0,0017	0,0020	0,0022	0,0026	0,0030	295 (260 – 360)
S12	E/M/A	0.70	0.0085	0.013	0.017	0.022	0.026	0.034	0.044	0.050	0.055	0.065	0.075	70 (60 – 89)
		0,70	0,00034	0,00050	0,00065	0,00085	0,0010	0,0013	0,0017	0,0020	0,0022	0,0026	0,0030	230 (200 – 290)
S13	E/M/A	0.70	0.0075	0.011	0.015	0.019	0.022	0.030	0.038	0.044	0.050	0.055	0.065	55 (48 – 71)
		0,70	0,00030	0,00044	0,00060	0,00075	0,00085	0,0012	0,0015	0,0017	0,0020	0,0022	0,0026	180 (160 – 230)

For cutting data recalculations, see pages 556 - 563

SMG = Seco material group
Coolant = A=air D=dry E=emulsion M=mist spray
v_c = m/min (sf/min)
f_z = mm (in/tooth)
a_p = mm/DC (in/DC) = factor
a_e = mm/DC (in/DC) = factor
All cutting data are target values

JHP760

High performance – ISO-S – Square – 2-4 Flutes – Cylindrical – Corner radius – ICC

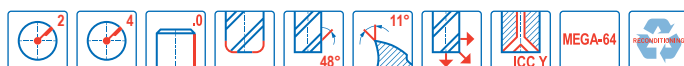
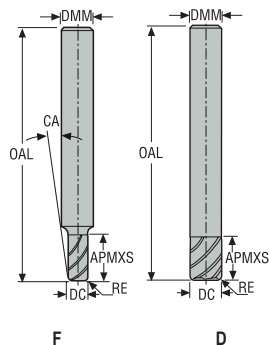

- Tolerances:
- DMM=h5
- DC=-0,02/-0,04 mm
- RE= ±0,03 mm
- Re grind possible if DC is ≥Ø6

Designation	Item number	Length index	Tool shape	ICC	DC	DMM	APMXS	OAL	RE	CA°	PCEDC	Cylindrical
					mm	mm	mm	mm	mm			
760040R020Z2.0A-MEGA-64	02734051	2	F	■	4,0	6,0	8,0	50,0	0,2	4,0 °	2	■
760040R040Z2.0A-MEGA-64	02623413	2	F	■	4,0	6,0	8,0	50,0	0,4	4,0 °	2	■
760050R020Z2.0A-MEGA-64	02734052	2	F	■	5,0	6,0	10,0	50,0	0,2	2,0 °	2	■
760050R040Z2.0A-MEGA-64	02623435	2	F	■	5,0	6,0	10,0	50,0	0,4	2,0 °	2	■
760060R020Z4.0A-MEGA-64	02734053	2	D	■	6,0	6,0	12,0	50,0	0,2	-	4	■
760060R040Z4.0A-MEGA-64	02623433	2	D	■	6,0	6,0	12,0	50,0	0,4	-	4	■
760080R040Z4.0A-MEGA-64	02623436	2	D	■	8,0	8,0	16,0	55,0	0,4	-	4	■
760080R100Z4.0A-MEGA-64	02623437	2	D	■	8,0	8,0	16,0	55,0	1,0	-	4	■
760100R040Z4.0A-MEGA-64	02623460	2	D	■	10,0	10,0	20,0	65,0	0,4	-	4	■
760100R100Z4.0A-MEGA-64	02623463	2	D	■	10,0	10,0	20,0	65,0	1,0	-	4	■
760100R150Z4.0A-MEGA-64	02623466	2	D	■	10,0	10,0	20,0	65,0	1,5	-	4	■
760120R040Z4.0A-MEGA-64	02623819	2	D	■	12,0	12,0	24,0	75,0	0,4	-	4	■
760120R100Z4.0A-MEGA-64	02623825	2	D	■	12,0	12,0	24,0	75,0	1,0	-	4	■
760120R150Z4.0A-MEGA-64	02623828	2	D	■	12,0	12,0	24,0	75,0	1,5	-	4	■
760120R310Z4.0A-MEGA-64	02623833	2	D	■	12,0	12,0	24,0	75,0	3,1	-	4	■
760200R040Z4.0A-MEGA-64	02734055	2	D	■	20,0	20,0	45,0	100,0	0,4	-	4	■
760200R080Z4.0A-MEGA-64	02623852	2	D	■	20,0	20,0	45,0	100,0	0,8	-	4	■
760L080R040Z4.0A-MEGA-64	02623438	3	D	■	8,0	8,0	28,0	65,0	0,4	-	4	■
760L100R040Z4.0A-MEGA-64	02623461	3	D	■	10,0	10,0	36,0	75,0	0,4	-	4	■
760L100R100Z4.0A-MEGA-64	02623464	3	D	■	10,0	10,0	36,0	75,0	1,0	-	4	■
760L100R150Z4.0A-MEGA-64	02623467	3	D	■	10,0	10,0	36,0	75,0	1,5	-	4	■
760L100R200Z4.0A-MEGA-64	02623472	3	D	■	10,0	10,0	36,0	75,0	2,0	-	4	■
760L100R310Z4.0A-MEGA-64	02623807	3	D	■	10,0	10,0	36,0	75,0	3,1	-	4	■
760L120R040Z4.0A-MEGA-64	02623821	3	D	■	12,0	12,0	42,0	90,0	0,4	-	4	■
760L120R100Z4.0A-MEGA-64	02623826	3	D	■	12,0	12,0	42,0	90,0	1,0	-	4	■
760L120R150Z4.0A-MEGA-64	02623829	3	D	■	12,0	12,0	42,0	90,0	1,5	-	4	■
760L120R400Z4.0A-MEGA-64	02623838	3	D	■	12,0	12,0	42,0	90,0	4,0	-	4	■
760L160R040Z4.0A-MEGA-64	02623840	3	D	■	16,0	16,0	50,0	100,0	0,4	-	4	■
760L160R100Z4.0A-MEGA-64	02623842	3	D	■	16,0	16,0	50,0	100,0	1,0	-	4	■
760L160R150Z4.0A-MEGA-64	02623844	3	D	■	16,0	16,0	50,0	100,0	1,5	-	4	■

■ Stocked standard.
ICC = Internal Coolant Channel

Universal

Steel and cast iron

Stainless steel and S-materials

Non ferrous

Hard

Plastic and CFRP

Graphite

X-Heads

Minimaster Plus

Minimaster

JHP760

High performance – ISO-S – Square – 2-4 Flutes – Weldon – Corner radius – ICC

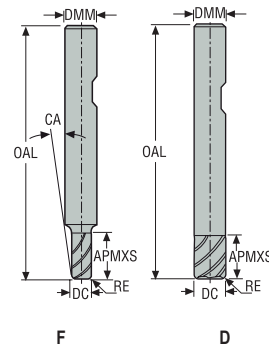

- Tolerances:
- DMM=h5
- DC=-0,02/-0,04 mm
- RE= ±0,03 mm
- Regrind possible if DC is ≥Ø6

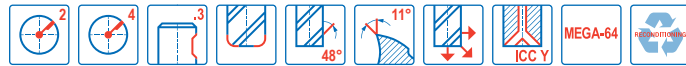

Designation	Item number	Length index	Tool shape	ICC	DC	DMM	APMXS	OAL	RE	CA°	PCEDC	Weldon
					mm	mm	mm	mm	mm			
760040R020Z2.0A-MEGA-64W	02734065	2	F	■	4,0	6,0	8,0	50,0	0,2	4,0°	2	□
760040R040Z2.0A-MEGA-64W	02669339	2	F	■	4,0	6,0	8,0	50,0	0,4	4,0°	2	□
760050R020Z2.0A-MEGA-64W	02734068	2	F	■	5,0	6,0	10,0	50,0	0,2	2,0°	2	□
760060R020Z4.0A-MEGA-64W	02669340	2	F	■	5,0	6,0	10,0	50,0	0,4	2,0°	2	□
760060R040Z4.0A-MEGA-64W	02734069	2	D	■	6,0	6,0	12,0	50,0	0,2	-	4	□
760060R040Z4.0A-MEGA-64W	02669341	2	D	■	6,0	6,0	12,0	50,0	0,4	-	4	□
760080R040Z4.0A-MEGA-64W	02669343	2	D	■	8,0	8,0	16,0	55,0	0,4	-	4	□
760080R100Z4.0A-MEGA-64W	02669344	2	D	■	8,0	8,0	16,0	55,0	1,0	-	4	□
760100R040Z4A-MEGA-64	02623442	2	D	■	10,0	10,0	20,0	65,0	0,4	-	4	■
760100R100Z4A-MEGA-64	02623462	2	D	■	10,0	10,0	20,0	65,0	1,0	-	4	■
760100R150Z4A-MEGA-64	02623465	2	D	■	10,0	10,0	20,0	65,0	1,5	-	4	■
760120R040Z4A-MEGA-64	02623817	2	D	■	12,0	12,0	24,0	75,0	0,4	-	4	■
760120R100Z4A-MEGA-64	02623824	2	D	■	12,0	12,0	24,0	75,0	1,0	-	4	■
760120R150Z4A-MEGA-64	02623827	2	D	■	12,0	12,0	24,0	75,0	1,5	-	4	■
760120R400Z4A-MEGA-64	02623835	2	D	■	12,0	12,0	24,0	75,0	4,0	-	4	■
760160R040Z4A-MEGA-64	02623839	2	D	■	16,0	16,0	40,0	90,0	0,4	-	4	■
760160R100Z4A-MEGA-64	02623841	2	D	■	16,0	16,0	40,0	90,0	1,0	-	4	■
760160R150Z4A-MEGA-64	02623843	2	D	■	16,0	16,0	40,0	90,0	1,5	-	4	■
760160R200Z4A-MEGA-64	02623845	2	D	■	16,0	16,0	40,0	90,0	2,0	-	4	■
760200R040Z4A-MEGA-64	02734054	2	D	■	20,0	20,0	45,0	100,0	0,4	-	4	■
760200R080Z4A-MEGA-64	02623851	2	D	■	20,0	20,0	45,0	100,0	0,8	-	4	■

■ Stocked standard. □ Weldon available. Delivery time is 3 days.
ICC = Internal Coolant Channel

Universal
Steel and cast iron
Stainless steel and S-materials
Non ferrous
Hard
Plastic and cfrp
Graphite
X-Heads
Minimaster Plus
Minimaster

JHP760

High performance – ISO-S – Square – 2-4 Flutes – Weldon – Corner radius – ICC

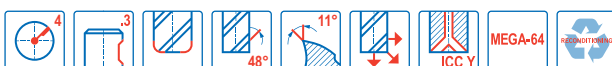
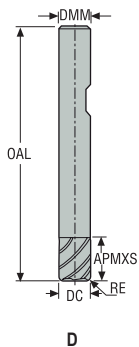

- Tolerances:
- DMM=h5
- DC=-0,02/-0,04 mm
- RE= ±0,03 mm
- Regrind possible

Designation	Item number	Length index	Tool shape	ICC	DC	DMM	APMXS	OAL	RE	PCEDC	Weldon
					mm	mm	mm	mm	mm		
760L080R040Z4.0A-MEGA-64W	02720459	3	D	■	8,0	8,0	28,0	65,0	0,4	4	<input type="checkbox"/>
760L100R040Z4.0A-MEGA-64W	02669345	3	D	■	10,0	10,0	36,0	75,0	0,4	4	<input type="checkbox"/>
760L100R100Z4.0A-MEGA-64W	02669346	3	D	■	10,0	10,0	36,0	75,0	1,0	4	<input type="checkbox"/>
760L100R150Z4.0A-MEGA-64W	02669347	3	D	■	10,0	10,0	36,0	75,0	1,5	4	<input type="checkbox"/>
760L100R200Z4.0A-MEGA-64W	02669348	3	D	■	10,0	10,0	36,0	75,0	2,0	4	<input type="checkbox"/>
760L120R040Z4.0A-MEGA-64W	02669350	3	D	■	12,0	12,0	42,0	90,0	0,4	4	<input type="checkbox"/>
760L120R100Z4.0A-MEGA-64W	02669351	3	D	■	12,0	12,0	42,0	90,0	1,0	4	<input type="checkbox"/>
760L120R150Z4.0A-MEGA-64W	02669352	3	D	■	12,0	12,0	42,0	90,0	1,5	4	<input type="checkbox"/>
760L160R040Z4.0A-MEGA-64W	02669356	3	D	■	16,0	16,0	50,0	100,0	0,4	4	<input type="checkbox"/>
760L160R100Z4.0A-MEGA-64W	02669357	3	D	■	16,0	16,0	50,0	100,0	1,0	4	<input type="checkbox"/>
760L160R150Z4.0A-MEGA-64W	02669358	3	D	■	16,0	16,0	50,0	100,0	1,5	4	<input type="checkbox"/>

Weldon available. Delivery time is 3 days.
ICC = Internal Coolant Channel

Universal

Steel and cast iron

Stainless steel and S-materials

Non ferrous

Hard

Plastic and CFRP

Graphite

X-Heads

Minimaster Plus

Minimaster

Cutting data – JHP760 Side milling

SMG		a _e /DC	a _p /DC	f _z									v _c
				4	5	6	8	10	12	16	20	25	
M1	E	0.300	1.5	0.036	0.044	0.055	0.070	0.090	0.10	0.13	0.15	0.17	120 (97 – 130)
		0,300	1,5	0,0014	0,0017	0,0022	0,0028	0,0036	0,0040	0,0050	0,0060	0,0065	395 (320 – 420)
M2	E	0.300	1.5	0.032	0.040	0.048	0.065	0.080	0.095	0.12	0.13	0.15	100 (81 – 110)
		0,300	1,5	0,0013	0,0016	0,0019	0,0026	0,0032	0,0038	0,0048	0,0050	0,0060	330 (270 – 360)
M3	E	0.300	1.4	0.026	0.032	0.038	0.050	0.065	0.075	0.095	0.11	0.12	75 (58 – 91)
		0,300	1,4	0,0010	0,0013	0,0015	0,0020	0,0026	0,0030	0,0038	0,0044	0,0048	245 (200 – 290)
M4	E	0.300	1.4	0.022	0.028	0.034	0.046	0.055	0.065	0.085	0.095	0.11	60 (45 – 70)
		0,300	1,4	0,00085	0,0011	0,0013	0,0018	0,0022	0,0026	0,0034	0,0038	0,0044	195 (150 – 220)
M5	E	0.300	1.4	0.022	0.028	0.034	0.046	0.055	0.065	0.085	0.095	0.11	48 (37 – 59)
		0,300	1,4	0,00085	0,0011	0,0013	0,0018	0,0022	0,0026	0,0034	0,0038	0,0044	155 (130 – 190)

Cutting data – JHP760 Slot milling

SMG		a _p /DC	f _z									v _c
			4	5	6	8	10	12	16	20	25	
M1	E	1.0	0.016	0.020	0.024	0.032	0.040	0.048	0.065	0.080	0.10	110 (92 – 130)
		1,0	0,00065	0,00080	0,00095	0,0013	0,0016	0,0019	0,0026	0,0032	0,0040	360 (310 – 420)
M2	E	1.0	0.016	0.020	0.024	0.032	0.040	0.048	0.065	0.080	0.10	90 (74 – 100)
		1,0	0,00065	0,00080	0,00095	0,0013	0,0016	0,0019	0,0026	0,0032	0,0040	295 (250 – 320)
M3	E	0.80	0.012	0.015	0.018	0.024	0.030	0.036	0.048	0.060	0.075	70 (54 – 85)
		0,80	0,00048	0,00060	0,00070	0,00095	0,0012	0,0014	0,0019	0,0024	0,0030	230 (180 – 270)
M4	E	0.80	0.012	0.015	0.018	0.024	0.030	0.036	0.048	0.060	0.075	50 (40 – 63)
		0,80	0,00048	0,00060	0,00070	0,00095	0,0012	0,0014	0,0019	0,0024	0,0030	165 (140 – 200)
M5	E	0.80	0.012	0.015	0.018	0.024	0.030	0.036	0.048	0.060	0.075	43 (34 – 53)
		0,80	0,00048	0,00060	0,00070	0,00095	0,0012	0,0014	0,0019	0,0024	0,0030	140 (120 – 170)

For cutting data recalculations, see pages 556 - 563

SMG = Seco material group
Coolant = A=air D=dry E=emulsion M=mist spray
v_c = m/min (sf/min)
f_z = mm (in/tooth)
a_p = mm/DC (in/DC) = factor
a_e = mm/DC (in/DC) = factor
All cutting data are target values

JHP770

High performance – Titanium – Square – 4-5 Flutes – Cylindrical – Corner radius – ICC

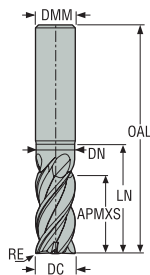

E

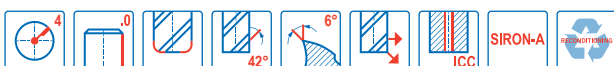

- Tolerances:
- DMM= h5
- DC= e7
- RE= ±0,02 mm
- Re grind possible

Designation	Item number	Length index	Tool shape	ICC	DC	DMM	APMXS	OAL	LN	DN	RE	PCEDC	Cylindrical
					mm	mm	mm	mm	mm	mm	mm		
JHP770060E2R030.0Z4A-SIRA	02760645	2	E	■	6,0	6,0	12,0	60,0	18,0	5,6	0,3	4	■
JHP770080E2R040.0Z4A-SIRA	02760653	2	E	■	8,0	8,0	16,0	65,0	24,0	7,4	0,4	4	■
JHP770080E2R050.0Z4A-SIRA	02823416	2	E	■	8,0	8,0	16,0	65,0	24,0	7,4	0,5	4	■
JHP770100E2R040.0Z4A-SIRA	02760654	2	E	■	10,0	10,0	20,0	75,0	30,0	9,4	0,4	4	■
JHP770100E2R050.0Z4A-SIRA	02823417	2	E	■	10,0	10,0	20,0	75,0	30,0	9,4	0,5	4	■
JHP770120E2R040.0Z4A-SIRA	02760656	2	E	■	12,0	12,0	24,0	90,0	36,0	11,4	0,4	4	■
JHP770120E2R050.0Z4A-SIRA	02823419	2	E	■	12,0	12,0	24,0	90,0	36,0	11,4	0,5	4	■
JHP770120E2R100.0Z4A-SIRA	02823420	2	E	■	12,0	12,0	24,0	90,0	36,0	11,4	1,0	4	■
JHP770120E2R250.0Z4A-SIRA	02760659	2	E	■	12,0	12,0	24,0	90,0	36,0	11,4	2,5	4	■
JHP770140E2R050.0Z4A-SIRA	02823421	2	E	■	14,0	14,0	28,0	95,0	42,0	13,4	0,5	4	■
JHP770160E2R040.0Z4A-SIRA	02760661	2	E	■	16,0	16,0	32,0	100,0	45,0	15,4	0,4	4	■
JHP770160E2R050.0Z4A-SIRA	02823422	2	E	■	16,0	16,0	32,0	100,0	45,0	15,4	0,5	4	■
JHP770160E2R080.0Z4A-SIRA	02760662	2	E	■	16,0	16,0	32,0	100,0	45,0	15,4	0,8	4	■
JHP770160E2R100.0Z4A-SIRA	02823423	2	E	■	16,0	16,0	32,0	100,0	45,0	15,4	1,0	4	■
JHP770160E2R250.0Z4A-SIRA	02760663	2	E	■	16,0	16,0	32,0	100,0	45,0	15,4	2,5	4	■
JHP770160E2R310.0Z4A-SIRA	02760664	2	E	■	16,0	16,0	32,0	100,0	45,0	15,4	3,1	4	■
JHP770160E2R400.0Z4A-SIRA	02760665	2	E	■	16,0	16,0	32,0	100,0	45,0	15,4	4,0	4	■
JHP770200E2R050.0Z4A-SIRA	02823424	2	E	■	20,0	20,0	40,0	115,0	55,0	19,4	0,5	4	■
JHP770200E2R100.0Z4A-SIRA	02823425	2	E	■	20,0	20,0	40,0	115,0	55,0	19,4	1,0	4	■
JHP770200E2R250.0Z4A-SIRA	02760668	2	E	■	20,0	20,0	40,0	115,0	55,0	19,4	2,5	4	■
JHP770200E2R310.0Z4A-SIRA	02760669	2	E	■	20,0	20,0	40,0	115,0	55,0	19,4	3,1	4	■
JHP770200E2R400.0Z4A-SIRA	02760670	2	E	■	20,0	20,0	40,0	115,0	55,0	19,4	4,0	4	■

■ Stocked standard.

Remark: if cornerradius is >15% of DC → a_p=-30%, f_z=-20%

ICC = Internal Coolant Channel

Universal

Steel and cast iron

Stainless steel and S-materials

Non ferrous

Hard

Plastic and CFRP

Graphite

X-Heads

Minimaster Plus

Minimaster

JHP770

High performance – Titanium – Square – 4-5 Flutes – Cylindrical – Corner radius – ICC

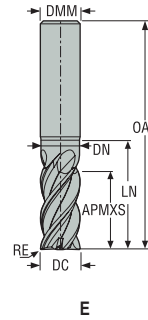

- Tolerances:
- DMM= h5
- DC= e7
- RE= ±0,02 mm
- Regrind possible

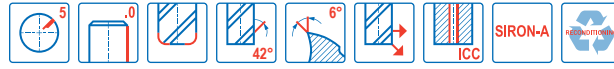

Designation	Item number	Length index	Tool shape	ICC	DC	DMM	APMXS	OAL	LN	DN	RE	PCEDC	Cylindrical
					mm	mm	mm	mm	mm	mm	mm		
JHP770160E2R050.0Z5A-SIRA	02810129	2	E	■	16,0	16,0	32,0	100,0	45,0	15,4	0,5	5	■
JHP770160E2R100.0Z5A-SIRA	02810130	2	E	■	16,0	16,0	32,0	100,0	45,0	15,4	1,0	5	■
JHP770160E2R250.0Z5A-SIRA	02810131	2	E	■	16,0	16,0	32,0	100,0	45,0	15,4	2,5	5	■
JHP770160E2R310.0Z5A-SIRA	02810132	2	E	■	16,0	16,0	32,0	100,0	45,0	15,4	3,1	5	■
JHP770160E2R400.0Z5A-SIRA	02810133	2	E	■	16,0	16,0	32,0	100,0	45,0	15,4	4,0	5	■
JHP770200E2R050.0Z5A-SIRA	02810134	2	E	■	20,0	20,0	40,0	115,0	55,0	19,4	0,5	5	■
JHP770200E2R100.0Z5A-SIRA	02810135	2	E	■	20,0	20,0	40,0	115,0	55,0	19,4	1,0	5	■
JHP770200E2R250.0Z5A-SIRA	02810136	2	E	■	20,0	20,0	40,0	115,0	55,0	19,4	2,5	5	■
JHP770200E2R310.0Z5A-SIRA	02810137	2	E	■	20,0	20,0	40,0	115,0	55,0	19,4	3,1	5	■
JHP770200E2R400.0Z5A-SIRA	02810138	2	E	■	20,0	20,0	40,0	115,0	55,0	19,4	4,0	5	■
JHP770250E2R050.0Z5A-SIRA	02810139	2	E	■	25,0	25,0	50,0	130,0	65,0	24,4	0,5	5	■

■ Stocked standard.
Remark: if cornerradius is >15% of DC → a_p=-30%, f_z=-20%
ICC = Internal Coolant Channel

Universal

Steel and cast iron

Stainless steel and S-materials

Non ferrous

Hard

Plastic and cfrp

Graphite

X-Heads

Minimaster Plus

Minimaster

JHP770

High performance – Titanium – Square – 4-5 Flutes – Weldon – Corner radius – ICC

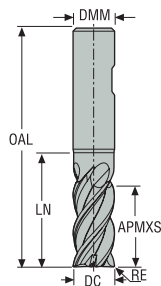

E

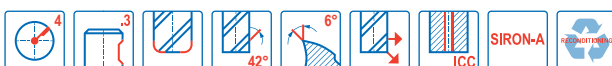

- Tolerances:
- DMM= h5
- DC= e7
- RE= ±0,02 mm
- Regrind possible

Designation	Item number	Length index	Tool shape	ICC	DC	DMM	APMXS	OAL	LN	DN	RE	PCEDC	Weldon
JHP770060E2R030.3Z4A-SIRA	02760796	2	E	■	6,0	6,0	12,0	60,0	18,0	5,6	0,3	4	■
JHP770080E2R040.3Z4A-SIRA	02760799	2	E	■	8,0	8,0	16,0	65,0	24,0	7,4	0,4	4	□
JHP770080E2R050.3Z4A-SIRA	02823428	2	E	■	8,0	8,0	16,0	65,0	24,0	7,4	0,5	4	■
JHP770100E2R040.3Z4A-SIRA	02760801	2	E	■	10,0	10,0	20,0	75,0	30,0	9,4	0,4	4	□
JHP770100E2R050.3Z4A-SIRA	02823429	2	E	■	10,0	10,0	20,0	75,0	30,0	9,4	0,5	4	■
JHP770120E2R040.3Z4A-SIRA	02760803	2	E	■	12,0	12,0	24,0	90,0	36,0	11,4	0,4	4	□
JHP770120E2R050.3Z4A-SIRA	02823431	2	E	■	12,0	12,0	24,0	90,0	36,0	11,4	0,5	4	■
JHP770120E2R100.3Z4A-SIRA	02823432	2	E	■	12,0	12,0	24,0	90,0	36,0	11,4	1,0	4	■
JHP770120E2R250.3Z4A-SIRA	02760805	2	E	■	12,0	12,0	24,0	90,0	36,0	11,4	2,5	4	□
JHP770140E2R050.3Z4A-SIRA	02823433	2	E	■	14,0	14,0	28,0	95,0	42,0	13,4	0,5	4	■
JHP770160E2R040.3Z4A-SIRA	02760807	2	E	■	16,0	16,0	32,0	100,0	45,0	15,4	0,4	4	□
JHP770160E2R050.3Z4A-SIRA	02823434	2	E	■	16,0	16,0	32,0	100,0	45,0	15,4	0,5	4	■
JHP770160E2R080.3Z4A-SIRA	02760809	2	E	■	16,0	16,0	32,0	100,0	45,0	15,4	0,8	4	□
JHP770160E2R100.3Z4A-SIRA	02823435	2	E	■	16,0	16,0	32,0	100,0	45,0	15,4	1,0	4	■
JHP770160E2R250.3Z4A-SIRA	02760810	2	E	■	16,0	16,0	32,0	100,0	45,0	15,4	2,5	4	■
JHP770160E2R310.3Z4A-SIRA	02760811	2	E	■	16,0	16,0	32,0	100,0	45,0	15,4	3,1	4	□
JHP770160E2R400.3Z4A-SIRA	02760817	2	E	■	16,0	16,0	32,0	100,0	45,0	15,4	4,0	4	□
JHP770200E2R050.3Z4A-SIRA	02823436	2	E	■	20,0	20,0	40,0	115,0	55,0	19,4	0,5	4	■
JHP770200E2R100.3Z4A-SIRA	02823437	2	E	■	20,0	20,0	40,0	115,0	55,0	19,4	1,0	4	■
JHP770200E2R250.3Z4A-SIRA	02760823	2	E	■	20,0	20,0	40,0	115,0	55,0	19,4	2,5	4	□
JHP770200E2R310.3Z4A-SIRA	02760824	2	E	■	20,0	20,0	40,0	115,0	55,0	19,4	3,1	4	□
JHP770200E2R400.3Z4A-SIRA	02760825	2	E	■	20,0	20,0	40,0	115,0	55,0	19,4	4,0	4	□

■ Stocked standard. □ Weldon available. Delivery time is 3 days.
Remark: if cornerradius is >15% of DC → a_p=-30%, f_z=-20%

Universal

Steel and cast iron

Stainless steel and S-materials

Non ferrous

Hard

Plastic and CFRP

Graphite

X-Heads

Minimaster Plus

Minimaster

JHP770

High performance – Titanium – Square – 4-5 Flutes – Weldon – Corner radius – ICC

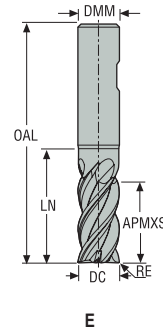

- Tolerances:
- DMM= h5
- DC= e7
- RE= ±0,02 mm
- Regrind possible

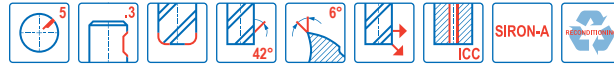

Designation	Item number	Length index	Tool shape	ICC	DC	DMM	APMXS	OAL	LN	DN	RE	PCEDC	Weldon
					mm	mm	mm	mm	mm	mm	mm		
JHP770160E2R050.3Z5A-SIRA	02810143	2	E	■	16,0	16,0	32,0	100,0	45,0	15,4	0,5	5	■
JHP770160E2R100.3Z5A-SIRA	02810144	2	E	■	16,0	16,0	32,0	100,0	45,0	15,4	1,0	5	■
JHP770160E2R250.3Z5A-SIRA	02810145	2	E	■	16,0	16,0	32,0	100,0	45,0	15,4	2,5	5	□
JHP770160E2R310.3Z5A-SIRA	02810146	2	E	■	16,0	16,0	32,0	100,0	45,0	15,4	3,1	5	■
JHP770160E2R400.3Z5A-SIRA	02810147	2	E	■	16,0	16,0	32,0	100,0	45,0	15,4	4,0	5	□
JHP770200E2R050.3Z5A-SIRA	02810148	2	E	■	20,0	20,0	40,0	115,0	55,0	19,4	0,5	5	■
JHP770200E2R100.3Z5A-SIRA	02810149	2	E	■	20,0	20,0	40,0	115,0	55,0	19,4	1,0	5	■
JHP770200E2R250.3Z5A-SIRA	02810150	2	E	■	20,0	20,0	40,0	115,0	55,0	19,4	2,5	5	□
JHP770200E2R310.3Z5A-SIRA	02810151	2	E	■	20,0	20,0	40,0	115,0	55,0	19,4	3,1	5	■
JHP770200E2R400.3Z5A-SIRA	02810152	2	E	■	20,0	20,0	40,0	115,0	55,0	19,4	4,0	5	■
JHP770250E2R050.3Z5A-SIRA	02810153	2	E	■	25,0	25,0	50,0	130,0	65,0	24,4	0,5	5	■
JHP770250E2R100.3Z5A-SIRA	02810154	2	E	■	25,0	25,0	50,0	130,0	65,0	24,4	1,0	5	■

■ Stocked standard. □ Weldon available. Delivery time is 3 days.
Remark: if cornerradius is >15% of DC → a_p=-30%, f_z=-20%

Universal

Steel and cast iron

Stainless steel and S-materials

Non ferrous

Hard

Plastic and CFRP

Graphite

X-Heads

Minimaster Plus

Minimaster

JHP770

High performance – Titanium – Square – 4-5 Flutes – Safelock – Corner radius – ICC

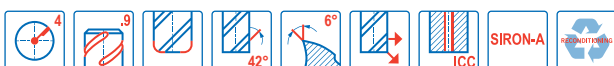
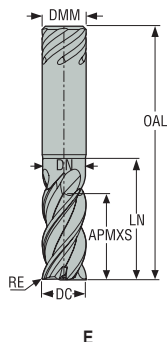

- Tolerances:
- DMM= h5
- DC= e7
- RE= ±0,02 mm
- Re grind possible

Designation	Item number	Length index	Tool shape	ICC	DC	DMM	APMXS	OAL	LN	DN	RE	PCEDC	Safelock
					mm	mm	mm	mm	mm	mm	mm		
JHP770060E2R030.9Z4A-SIRA	02927936	2	E	■	6,0	6,0	12,0	60,0	18,0	6,0	0,3	4	<input type="checkbox"/>
JHP770080E2R040.9Z4A-SIRA	02927937	2	E	■	8,0	8,0	16,0	65,0	24,0	7,0	0,4	4	<input type="checkbox"/>
JHP770080E2R050.9Z4A-SIRA	02927938	2	E	■	8,0	8,0	16,0	65,0	24,0	7,0	0,5	4	<input type="checkbox"/>
JHP770100E2R040.9Z4A-SIRA	02927939	2	E	■	10,0	10,0	20,0	75,0	30,0	9,0	0,4	4	<input type="checkbox"/>
JHP770100E2R050.9Z4A-SIRA	02927940	2	E	■	10,0	10,0	20,0	75,0	30,0	9,0	0,5	4	<input type="checkbox"/>
JHP770120E2R040.9Z4A-SIRA	02927943	2	E	■	12,0	12,0	24,0	90,0	36,0	11,0	0,4	4	<input type="checkbox"/>
JHP770120E2R050.9Z4A-SIRA	02927944	2	E	■	12,0	12,0	24,0	90,0	36,0	11,0	0,5	4	<input type="checkbox"/>
JHP770120E2R100.9Z4A-SIRA	02927946	2	E	■	12,0	12,0	24,0	90,0	36,0	11,0	1,0	4	<input type="checkbox"/>
JHP770120E2R250.9Z4A-SIRA	02927947	2	E	■	12,0	12,0	24,0	90,0	36,0	11,0	2,5	4	<input type="checkbox"/>
JHP770140E2R050.9Z4A-SIRA	02927950	2	E	■	14,0	14,0	28,0	95,0	42,0	13,0	0,5	4	<input type="checkbox"/>
JHP770160E2R040.9Z4A-SIRA	02927948	2	E	■	16,0	16,0	32,0	100,0	45,0	15,0	0,4	4	<input type="checkbox"/>
JHP770160E2R050.9Z4A-SIRA	02927978	2	E	■	16,0	16,0	32,0	100,0	45,0	15,0	0,5	4	<input type="checkbox"/>
JHP770160E2R080.9Z4A-SIRA	02927951	2	E	■	16,0	16,0	32,0	100,0	45,0	15,0	0,8	4	<input type="checkbox"/>
JHP770160E2R100.9Z4A-SIRA	02927952	2	E	■	16,0	16,0	32,0	100,0	45,0	15,0	1,0	4	<input type="checkbox"/>
JHP770160E2R250.9Z4A-SIRA	02927954	2	E	■	16,0	16,0	32,0	100,0	45,0	15,0	2,5	4	<input type="checkbox"/>
JHP770160E2R310.9Z4A-SIRA	02927956	2	E	■	16,0	16,0	32,0	100,0	45,0	15,0	3,1	4	<input type="checkbox"/>
JHP770160E2R400.9Z4A-SIRA	02927958	2	E	■	16,0	16,0	32,0	100,0	45,0	15,0	4,0	4	<input type="checkbox"/>
JHP770200E2R050.9Z4A-SIRA	02927960	2	E	■	20,0	20,0	40,0	115,0	55,0	19,0	0,5	4	<input type="checkbox"/>
JHP770200E2R100.9Z4A-SIRA	02927962	2	E	■	20,0	20,0	40,0	115,0	55,0	19,0	1,0	4	<input type="checkbox"/>
JHP770200E2R250.9Z4A-SIRA	02927964	2	E	■	20,0	20,0	40,0	115,0	55,0	19,0	2,5	4	<input type="checkbox"/>
JHP770200E2R310.9Z4A-SIRA	02927966	2	E	■	20,0	20,0	40,0	115,0	55,0	19,0	3,1	4	<input type="checkbox"/>
JHP770200E2R400.9Z4A-SIRA	02927968	2	E	■	20,0	20,0	40,0	115,0	55,0	19,0	4,0	4	<input type="checkbox"/>

Safelock available. Delivery time is 6 days.
Remark: if cornerradius is >15% of DC → a_p=-30%, f_z=-20%

Universal

Steel and cast iron

Stainless steel and S-materials

Non ferrous

Hard

Plastic and CFRP

Graphite

X-Heads

Minimaster Plus

Minimaster

JHP770

High performance – Titanium – Square – 4-5 Flutes – Safelock – Corner radius – ICC

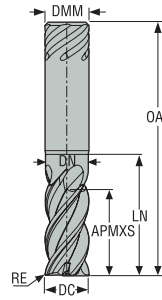

E

- Tolerances:
- DMM= h5
- DC= e7
- RE= ±0,02 mm
- Regrind possible

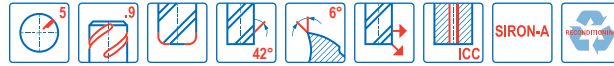

Designation	Item number	Length index	Tool shape	ICC	DC	DMM	APMXS	OAL	LN	DN	RE	PCEDC	Safelock
					mm	mm	mm	mm	mm	mm	mm		
JHP770160E2R050.9Z5A-SIRA	02927949	2	E	■	16,0	16,0	32,0	100,0	45,0	15,0	0,5	5	<input type="checkbox"/>
JHP770160E2R100.9Z5A-SIRA	02927953	2	E	■	16,0	16,0	32,0	100,0	45,0	15,0	1,0	5	<input type="checkbox"/>
JHP770160E2R250.9Z5A-SIRA	02927955	2	E	■	16,0	16,0	32,0	100,0	45,0	15,0	2,5	5	<input type="checkbox"/>
JHP770160E2R310.9Z5A-SIRA	02927957	2	E	■	16,0	16,0	32,0	100,0	45,0	15,0	3,1	5	<input type="checkbox"/>
JHP770160E2R400.9Z5A-SIRA	02927959	2	E	■	16,0	16,0	32,0	100,0	45,0	15,0	4,0	5	<input type="checkbox"/>
JHP770200E2R050.9Z5A-SIRA	02927961	2	E	■	20,0	20,0	40,0	115,0	55,0	19,0	0,5	5	<input type="checkbox"/>
JHP770200E2R100.9Z5A-SIRA	02927963	2	E	■	20,0	20,0	40,0	115,0	55,0	19,0	1,0	5	<input type="checkbox"/>
JHP770200E2R250.9Z5A-SIRA	02927965	2	E	■	20,0	20,0	40,0	115,0	55,0	19,0	2,5	5	<input type="checkbox"/>
JHP770200E2R310.9Z5A-SIRA	02927967	2	E	■	20,0	20,0	40,0	115,0	55,0	19,0	3,1	5	<input type="checkbox"/>
JHP770200E2R400.9Z5A-SIRA	02927969	2	E	■	20,0	20,0	40,0	115,0	55,0	19,0	4,0	5	<input type="checkbox"/>
JHP770250E2R050.9Z5A-SIRA	02927971	2	E	■	25,0	25,0	50,0	130,0	65,0	24,0	0,5	5	<input type="checkbox"/>

Safelock available. Delivery time is 6 days.
Remark: if cornerradius is >15% of DC → a_p=-30%, f_z=-20%

Universal

Steel and cast iron

Stainless steel and S-materials

Non ferrous

Hard

Plastic and CFRP

Graphite

X-Heads

Minimaster Plus

Minimaster

Cutting data – JHP770 Side milling

SMG		a _p /DC	a _p /DC	f _z								v _c
				6	8	10	12	14	16	20	25	
S11	E	0.400	1.8	0.050	0.065	0.080	0.095	0.11	0.12	0.14	0.16	120 (110 – 130)
		0.400	1,6	0,0020	0,0026	0,0032	0,0038	0,0044	0,0048	0,0055	0,0065	395 (370 – 420)
S12	E	0.400	1.8	0.050	0.065	0.080	0.095	0.11	0.12	0.14	0.16	90 (80 – 100)
		0.400	1,6	0,0020	0,0026	0,0032	0,0038	0,0044	0,0048	0,0055	0,0065	295 (270 – 320)
S13	E	0.400	1.8	0.042	0.055	0.070	0.085	0.095	0.11	0.12	0.14	75 (64 – 81)
		0.400	1,6	0,0017	0,0022	0,0028	0,0034	0,0038	0,0044	0,0048	0,0055	245 (210 – 260)

Cutting data – JHP770 Slot milling

SMG		a _p /DC	a _p /DC	f _z								v _c
				6	8	10	12	14	16	20	25	
S11	E	1.6	0.030	0.040	0.050	0.060	0.070	0.080	0.10	0.13	105 (94 – 120)	
		1,6	0,0012	0,0016	0,0020	0,0024	0,0028	0,0032	0,0040	0,0050	345 (310 – 390)	
S12	E	1.6	0.030	0.040	0.050	0.060	0.070	0.080	0.10	0.13	80 (72 – 92)	
		1,6	0,0012	0,0016	0,0020	0,0024	0,0028	0,0032	0,0040	0,0050	260 (240 – 300)	
S13	E	1.6	0.030	0.040	0.050	0.060	0.070	0.080	0.10	0.13	65 (56 – 71)	
		1,6	0,0012	0,0016	0,0020	0,0024	0,0028	0,0032	0,0040	0,0050	215 (190 – 230)	

For cutting data recalculations, see pages 556 - 563

SMG = Seco material group
Coolant = A=air D=dry E=emulsion M=mist spray
v_c = m/min (sf/min)
f_z = mm (in/tooth)
a_p = mm/DC (in/DC) = factor
a_e = mm/DC (in/DC) = factor
All cutting data are target values

Universal
Steel and cast iron
Stainless steel and S-materials
Non ferrous
Hard
Plastic and CFRP
Graphite
X-Heads
Minimaster Plus
Minimaster

JHP780

High performance – Superalloy – Square – 4-Flutes – Cylindrical – Corner radius – ICC

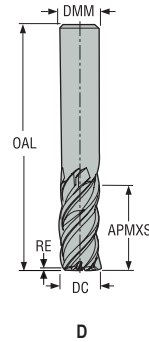

- Tolerances:
- DMM=h5
- DC=e7
- RE= ±0,02 mm
- Regrind possible

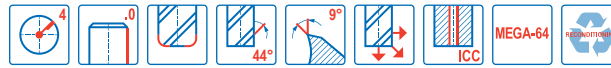

Designation	Item number	Length index	Tool shape	ICC	DC	DMM	APMXS	OAL	RE	PCEDC	Cylindrical
					mm	mm	mm	mm	mm		
JHP780060D1R030.0Z4A-M64	03134984	1	D	■	6,0	6,0	7,5	47,0	0,3	4	■
JHP780060D1R080.0Z4A-M64	03134985	1	D	■	6,0	6,0	7,5	47,0	0,8	4	■
JHP780080D1R040.0Z4A-M64	03134986	1	D	■	8,0	8,0	10,0	50,0	0,4	4	■
JHP780080D1R080.0Z4A-M64	03134987	1	D	■	8,0	8,0	10,0	50,0	0,8	4	■
JHP780100D1R040.0Z4A-M64	03134988	1	D	■	10,0	10,0	12,5	57,0	0,4	4	■
JHP780100D1R080.0Z4A-M64	03134989	1	D	■	10,0	10,0	12,5	57,0	0,8	4	■

■ Stocked standard.

Universal

Steel and cast iron

Stainless steel and S-materials

Non ferrous

Hard

Plastic and CFRP

Graphite

X-Heads

Minimaster Plus

Minimaster

JHP780

High performance – Superalloy – Square – 4-Flutes – Cylindrical – Corner radius – ICC

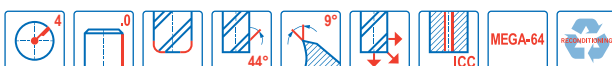
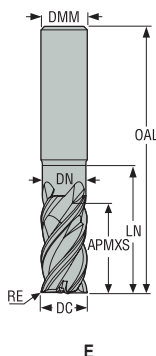

- Tolerances:
- DMM=h5
- DC=e7
- RE= ±0,02 mm
- Re grind possible

Designation	Item number	Length index	Tool shape	ICC	DC	DMM	APMXS	OAL	LN	DN	RE	PCEDC	Cylindrical
					mm	mm	mm	mm	mm	mm	mm		
JHP780060E2R030.0Z4A-M64	03134992	2	E	■	6,0	6,0	12,0	60,0	18,0	5,6	0,3	4	■
JHP780060E2R030.0Z4-M64	02760834	2	E	-	6,0	6,0	12,0	60,0	18,0	5,6	0,3	4	■
JHP780080E2R040.0Z4A-M64	03134993	2	E	■	8,0	8,0	16,0	65,0	24,0	7,4	0,4	4	■
JHP780080E2R040.0Z4-M64	02760842	2	E	-	8,0	8,0	16,0	65,0	24,0	7,4	0,4	4	■
JHP780100E2R040.0Z4A-M64	03134994	2	E	■	10,0	10,0	20,0	75,0	30,0	9,4	0,4	4	■
JHP780100E2R040.0Z4-M64	02760846	2	E	-	10,0	10,0	20,0	75,0	30,0	9,4	0,4	4	■
JHP780100E2R080.0Z4A-M64	03134995	2	E	■	10,0	10,0	20,0	75,0	30,0	9,4	0,8	4	■
JHP780100E2R080.0Z4-M64	02760847	2	E	-	10,0	10,0	20,0	75,0	30,0	9,4	0,8	4	■
JHP780120E2R040.0Z4A-M64	03134996	2	E	■	12,0	12,0	24,0	90,0	36,0	11,4	0,4	4	■
JHP780120E2R040.0Z4-M64	02760848	2	E	-	12,0	12,0	24,0	90,0	36,0	11,4	0,4	4	■
JHP780120E2R080.0Z4A-M64	03134997	2	E	■	12,0	12,0	24,0	90,0	36,0	11,4	0,8	4	■
JHP780120E2R080.0Z4-M64	02760849	2	E	-	12,0	12,0	24,0	90,0	36,0	11,4	0,8	4	■
JHP780120E2R150.0Z4-M64	02760850	2	E	-	12,0	12,0	24,0	90,0	36,0	11,4	1,5	4	■
JHP780120E2R250.0Z4-M64	02760851	2	E	-	12,0	12,0	24,0	90,0	36,0	11,4	2,5	4	■
JHP780140E2R040.0Z4-M64	02760852	2	E	-	14,0	14,0	28,0	95,0	42,0	13,4	0,4	4	■
JHP780160E2R040.0Z4A-M64	03135000	2	E	■	16,0	16,0	32,0	100,0	45,0	15,4	0,4	4	■
JHP780160E2R040.0Z4-M64	02760853	2	E	-	16,0	16,0	32,0	100,0	45,0	15,4	0,4	4	■
JHP780160E2R080.0Z4A-M64	03135001	2	E	■	16,0	16,0	32,0	100,0	45,0	15,4	0,8	4	■
JHP780160E2R080.0Z4-M64	02760861	2	E	-	16,0	16,0	32,0	100,0	45,0	15,4	0,8	4	■
JHP780160E2R310.0Z4-M64	02760862	2	E	-	16,0	16,0	32,0	100,0	45,0	15,4	3,1	4	■
JHP780160E2R400.0Z4-M64	02760863	2	E	-	16,0	16,0	32,0	100,0	45,0	15,4	4,0	4	■
JHP780200E2R040.0Z4-M64	02760865	2	E	-	20,0	20,0	40,0	115,0	55,0	19,4	0,4	4	■
JHP780200E2R080.0Z4-M64	02760866	2	E	-	20,0	20,0	40,0	115,0	55,0	19,4	0,8	4	■
JHP780200E2R310.0Z4-M64	02760867	2	E	-	20,0	20,0	40,0	115,0	55,0	19,4	3,1	4	■
JHP780200E2R400.0Z4-M64	02760868	2	E	-	20,0	20,0	40,0	115,0	55,0	19,4	4,0	4	■
JHP780250E2R080.0Z4-M64	02760870	2	E	-	25,0	25,0	50,0	130,0	65,0	24,4	0,8	4	■

■ Stocked standard.

Universal

Steel and cast iron

Stainless steel and S-materials

Non ferrous

Hard

Plastic and CFRP

Graphite

X-Heads

Minimaster Plus

Minimaster

JHP780

High performance – Superalloy – Square – 4-Flutes – Weldon – Corner radius – ICC

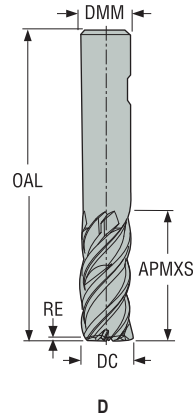

- Tolerances:
- DMM=h5
- DC=e7
- RE= ±0,02 mm
- Regrind possible

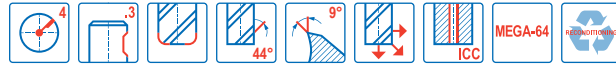

Designation	Item number	Length index	Tool shape	ICC	DC	DMM	APMXS	OAL	RE	PCEDC	Weldon
					mm	mm	mm	mm	mm		
JHP780060D1R030.3Z4A-M64	03135445	1	D	■	6,0	6,0	7,5	47,0	0,3	4	■
JHP780060D1R080.3Z4A-M64	03135446	1	D	■	6,0	6,0	7,5	47,0	0,8	4	■
JHP780080D1R040.3Z4A-M64	03135447	1	D	■	8,0	8,0	10,0	50,0	0,4	4	■
JHP780080D1R080.3Z4A-M64	03135449	1	D	■	8,0	8,0	10,0	50,0	0,8	4	■
JHP780100D1R040.3Z4A-M64	03135450	1	D	■	10,0	10,0	12,5	57,0	0,4	4	■
JHP780100D1R080.3Z4A-M64	03135451	1	D	■	10,0	10,0	12,5	57,0	0,8	4	■

■ Stocked standard.

Universal

Steel and cast iron

Stainless steel and S-materials

Non ferrous

Hard

Plastic and CFRP

Graphite

X-Heads

Minimaster Plus

Minimaster

JHP780

High performance – Superalloy – Square – 4-Flutes – Weldon – Corner radius – ICC

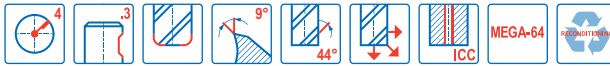
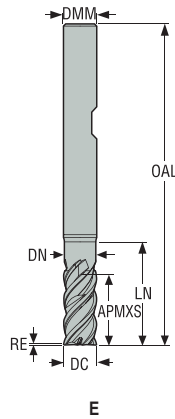

- Tolerances:
- DMM=h5
- DC=e7
- RE= ±0,02 mm
- Re grind possible

Designation	Item number	Length index	Tool shape	ICC	DC	DMM	APMXS	OAL	LN	DN	RE	PCEDC	Weldon
					mm	mm	mm	mm	mm	mm	mm		
JHP780060E2R030.3Z4-M64	02760878	2	E	–	6,0	6,0	12,0	60,0	18,0	5,6	0,3	4	■
JHP780060E2R030.3Z4A-M64	03135454	2	E	■	6,0	6,0	12,0	60,0	18,0	5,6	0,3	4	■
JHP780080E2R040.3Z4-M64	02760879	2	E	–	8,0	8,0	16,0	65,0	24,0	7,4	0,4	4	■
JHP780080E2R040.3Z4A-M64	03135455	2	E	■	8,0	8,0	16,0	65,0	24,0	7,4	0,4	4	■
JHP780100E2R040.3Z4-M64	02760880	2	E	–	10,0	10,0	20,0	75,0	30,0	9,4	0,4	4	■
JHP780100E2R040.3Z4A-M64	03135456	2	E	■	10,0	10,0	20,0	75,0	30,0	9,4	0,4	4	■
JHP780100E2R080.3Z4-M64	02760881	2	E	–	10,0	10,0	20,0	75,0	30,0	9,4	0,8	4	■
JHP780100E2R080.3Z4A-M64	03135457	2	E	■	10,0	10,0	20,0	75,0	30,0	9,4	0,8	4	■
JHP780120E2R040.3Z4-M64	02760883	2	E	–	12,0	12,0	24,0	90,0	36,0	11,4	0,4	4	■
JHP780120E2R040.3Z4A-M64	03134998	2	E	■	12,0	12,0	24,0	90,0	36,0	11,4	0,4	4	■
JHP780120E2R080.3Z4-M64	02760885	2	E	–	12,0	12,0	24,0	90,0	36,0	11,4	0,8	4	■
JHP780120E2R080.3Z4A-M64	03134999	2	E	■	12,0	12,0	24,0	90,0	36,0	11,4	0,8	4	■
JHP780120E2R150.3Z4-M64	02760887	2	E	–	12,0	12,0	24,0	90,0	36,0	11,4	1,5	4	■
JHP780120E2R250.3Z4-M64	02766989	2	E	–	12,0	12,0	24,0	90,0	36,0	11,4	2,5	4	■
JHP780140E2R040.3Z4-M64	02760888	2	E	–	14,0	14,0	28,0	95,0	42,0	13,4	0,4	4	■
JHP780160E2R040.3Z4-M64	02760889	2	E	–	16,0	16,0	32,0	100,0	45,0	15,4	0,4	4	■
JHP780160E2R040.3Z4A-M64	03135002	2	E	■	16,0	16,0	32,0	100,0	45,0	15,4	0,4	4	■
JHP780160E2R080.3Z4-M64	02760890	2	E	–	16,0	16,0	32,0	100,0	45,0	15,4	0,8	4	■
JHP780160E2R080.3Z4A-M64	03135003	2	E	■	16,0	16,0	32,0	100,0	45,0	15,4	0,8	4	■
JHP780160E2R400.3Z4-M64	02760893	2	E	–	16,0	16,0	32,0	100,0	45,0	15,4	4,0	4	■
JHP780200E2R040.3Z4-M64	02760894	2	E	–	20,0	20,0	40,0	115,0	55,0	19,4	0,4	4	■
JHP780200E2R080.3Z4-M64	02760896	2	E	–	20,0	20,0	40,0	115,0	55,0	19,4	0,8	4	■
JHP780200E2R310.3Z4-M64	02760897	2	E	–	20,0	20,0	40,0	115,0	55,0	19,4	3,1	4	■
JHP780200E2R400.3Z4-M64	02760898	2	E	–	20,0	20,0	40,0	115,0	55,0	19,4	4,0	4	■
JHP780250E2R080.3Z4-M64	02760901	2	E	–	25,0	25,0	50,0	130,0	65,0	24,4	0,8	4	■

■ Stocked standard.

Universal

Steel and cast iron

Stainless steel and S-materials

Non ferrous

Hard

Plastic and CFRP

Graphite

X-Heads

Minimaster Plus

Minimaster

Cutting data – JHP780 Side milling

SMG		a _e /DC	a _p /DC	f _z								v _c
				6	8	10	12	14	16	20	25	
S1	E	0.300	1.0	0.036	0.048	0.060	0.070	0.080	0.090	0.10	0.12	50 (45 — 59)
		0,300	1,0	0,0014	0,0019	0,0024	0,0028	0,0032	0,0036	0,0040	0,0048	165 (150 — 190)
S2	E	0.300	1.0	0.036	0.048	0.060	0.070	0.080	0.090	0.10	0.12	42 (36 — 47)
		0,300	1,0	0,0014	0,0019	0,0024	0,0028	0,0032	0,0036	0,0040	0,0048	140 (120 — 150)
S3	E	0.300	0.80	0.036	0.048	0.060	0.070	0.080	0.090	0.10	0.11	28 (23 — 33)
		0,300	0,80	0,0014	0,0019	0,0024	0,0028	0,0032	0,0036	0,0040	0,0044	90 (76 — 100)

Cutting data – JHP780 Slot milling

SMG		a _p /DC	f _z								v _c
			6	8	10	12	14	16	20	25	
S1	E	0.80	0.020	0.028	0.034	0.042	0.048	0.055	0.070	0.085	43 (38 — 49)
		0,80	0,00080	0,0011	0,0013	0,0017	0,0019	0,0022	0,0028	0,0034	140 (130 — 160)
S2	E	0.80	0.020	0.028	0.034	0.042	0.048	0.055	0.070	0.085	35 (30 — 40)
		0,80	0,00080	0,0011	0,0013	0,0017	0,0019	0,0022	0,0028	0,0034	115 (99 — 130)
S3	E	0.60	0.012	0.016	0.020	0.025	0.028	0.032	0.040	0.050	26 (21 — 30)
		0,60	0,00048	0,00065	0,00080	0,0010	0,0011	0,0013	0,0016	0,0020	85 (69 — 98)

For cutting data recalculations, see pages 556 - 563

SMG = Seco material group

Coolant = A=air D=dry E=emulsion M=mist spray

v_c = m/min (sf/min)

f_z = mm (in/tooth)

a_p = mm/DC (in/DC) = factor

a_e = mm/DC (in/DC) = factor

All cutting data are target values

Universal

Steel and cast iron

Stainless steel and S-materials

Non ferrous

Hard

Plastic and CFRP

Graphite

X-Heads

Minimaster Plus

Minimaster

JHP794

High performance – ISO-S – Square – 4 Flutes – Weldon – Corner radius

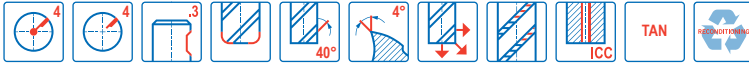
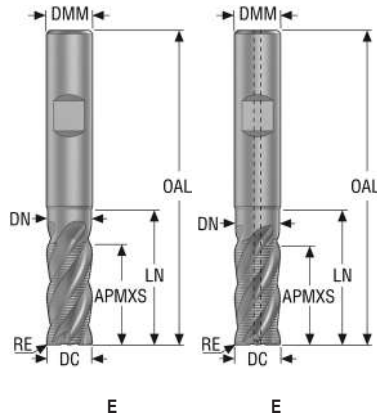

- Tolerances:
- DMM= h6
- DC= h12
- RE= ±0,05 mm
- Re grind possible if DC is ≥Ø8

Designation	Grade	Item number	Length index	Tool shape	ICC	DC	DMM	APMXS	OAL	LN	DN	RE	PCEDC	Weldon
						mm	mm	mm	mm	mm	mm	mm		
JHP794060E2R020.3Z4	TAN	10072338	2	E	–	6,0	6,0	13,0	57,0	18,5	2,0	0,2	4	■
JHP794060E2R020.3Z4A	TAN	10072339	2	E	■	6,0	6,0	13,0	57,0	18,5	5,5	0,2	4	■
JHP794080E2R020.3Z4	TAN	10072340	2	E	–	8,0	8,0	19,0	63,0	24,5	7,5	0,2	4	■
JHP794080E2R020.3Z4A	TAN	10072341	2	E	■	8,0	8,0	19,0	63,0	24,5	7,5	0,2	4	■
JHP794100E2R035.3Z4	TAN	10072342	2	E	–	10,0	10,0	22,0	72,0	29,5	9,5	0,35	4	■
JHP794100E2R035.3Z4A	TAN	10072343	2	E	■	10,0	10,0	22,0	72,0	29,5	9,5	0,35	4	■
JHP794120E2R035.3Z4	TAN	10072344	2	E	–	12,0	12,0	26,0	83,0	35,5	11,4	0,35	4	■
JHP794120E2R035.3Z4A	TAN	10072345	2	E	■	12,0	12,0	26,0	92,0	35,5	11,4	0,35	4	■
JHP794160E2R040.3Z4	TAN	10072346	2	E	–	16,0	16,0	32,0	92,0	41,5	15,2	0,4	4	■
JHP794160E2R040.3Z4A	TAN	10072347	2	E	■	16,0	16,0	32,0	92,0	41,5	15,2	0,4	4	■
JHP794200E2R040.3Z4	TAN	10072348	2	E	–	20,0	20,0	38,0	104,0	51,5	19,0	0,4	4	■
JHP794200E2R040.3Z4A	TAN	10072349	2	E	■	20,0	20,0	38,0	104,0	51,5	19,0	0,4	4	■
JHP794250E2R040.3Z4	TAN	10072350	2	E	–	25,0	25,0	45,0	121,0	62,5	23,8	0,4	4	■
JHP794250E2R040.3Z4A	TAN	10072351	2	E	■	25,0	25,0	45,0	121,0	62,5	23,8	0,4	4	■

■ Stocked standard.

Universal

Steel and cast iron

Stainless steel and S-materials

Non ferrous

Hard

Plastic and CFRP

Graphite

X-Heads

Minimaster Plus

Minimaster

Cutting data – JHP794 Side milling

SMG		a _p /DC	f _z							v _c
			6	8	10	12	16	20	25	
M1	E	1.3	0.032	0.044	0.055	0.065	0.080	0.090	0.10	90 (61 – 120)
		1,3	0,0013	0,0017	0,0022	0,0026	0,0032	0,0036	0,0040	295 (210 – 390)
M2	E	1.3	0.030	0.040	0.048	0.060	0.070	0.085	0.095	75 (50 – 99)
		1,3	0,0012	0,0016	0,0019	0,0024	0,0028	0,0034	0,0038	245 (170 – 320)
M3	E	1.3	0.024	0.032	0.040	0.046	0.055	0.065	0.075	60 (40 – 78)
		1,3	0,00095	0,0013	0,0016	0,0018	0,0022	0,0026	0,0030	195 (140 – 250)
M4	E	1.3	0.020	0.028	0.034	0.040	0.050	0.060	0.065	45 (31 – 60)
		1,3	0,00080	0,0011	0,0013	0,0016	0,0020	0,0024	0,0026	150 (110 – 190)
M5	E	1.3	0.020	0.028	0.034	0.040	0.050	0.060	0.065	38 (26 – 50)
		1,3	0,00080	0,0011	0,0013	0,0016	0,0020	0,0024	0,0026	125 (86 – 160)

Cutting data – JHP794 Slot milling

SMG		a _p /DC	f _z							v _c
			6	8	10	12	16	20	25	
M1	E	0.60	0.024	0.032	0.040	0.048	0.065	0.080	0.095	75 (50 – 99)
		0,60	0,00095	0,0013	0,0016	0,0019	0,0026	0,0032	0,0038	245 (170 – 320)
M2	E	0.60	0.024	0.032	0.040	0.048	0.065	0.080	0.090	60 (40 – 79)
		0,60	0,00095	0,0013	0,0016	0,0019	0,0026	0,0032	0,0036	195 (140 – 250)
M3	E	0.60	0.022	0.030	0.036	0.044	0.055	0.060	0.070	47 (32 – 62)
		0,60	0,00085	0,0012	0,0014	0,0017	0,0022	0,0024	0,0028	155 (110 – 200)
M4	E	0.60	0.019	0.026	0.032	0.038	0.048	0.055	0.060	36 (24 – 47)
		0,60	0,00075	0,0010	0,0013	0,0015	0,0019	0,0022	0,0024	120 (79 – 150)
M5	E	0.60	0.019	0.026	0.032	0.038	0.048	0.055	0.060	30 (20 – 39)
		0,60	0,00075	0,0010	0,0013	0,0015	0,0019	0,0022	0,0024	100 (66 – 120)

For cutting data recalculations, see pages 556 - 563

SMG = Seco material group
Coolant = A=air D=dry E=emulsion M=mist spray
v_c = m/min (sf/min)
f_z = mm (in/tooth)
a_p = mm/DC (in/DC) = factor
a_e = mm/DC (in/DC) = factor
All cutting data are target values

JCG790

High performance – Square – Superalloy – 5-6 Flutes – Cylindrical – Corner radius

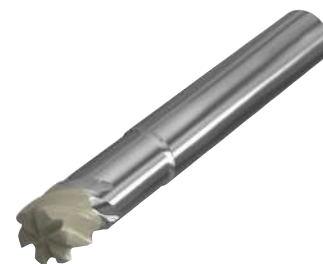
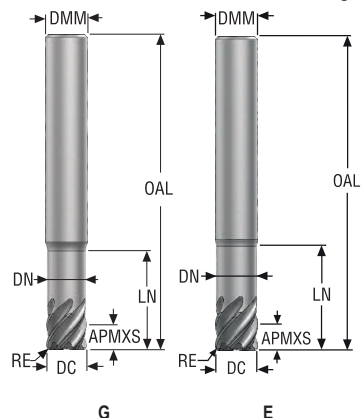

- Tolerances:
- DMM= h5
- DC= -0,02/-0,1 mm
- RE= ±0,05 mm

Designation	Item number	Length index	Tool shape	DC	DMM	APMXS	OAL	DN	LN	RE	PCEDC	Cylindrical
				mm	mm	mm	mm	mm	mm	mm		
JCG790060E2R050.0Z5	10010512	2	E	6,0	6,0	6,0	59,0	5,7	15,0	0,5	5	■
JCG790080E2R050.0Z5	10010513	2	E	8,0	8,0	6,0	67,0	7,6	20,0	0,5	5	■
JCG790094G2R100.0Z6	10010514	2	G	9,4	10,0	6,0	75,0	9,0	23,5	1,0	6	■
JCG790100E2R100.0Z6	10010515	2	E	10,0	10,0	6,0	75,0	9,5	25,0	1,0	6	■
JCG790114G2R150.0Z6	10010516	2	G	11,4	12,0	6,0	82,0	10,9	28,5	1,5	6	■
JCG790120E2R150.0Z6	10010517	2	E	12,0	12,0	6,0	82,0	11,4	30,0	1,5	6	■
JCG790160E2R200.0Z6	10010518	2	E	16,0	16,0	8,0	93,0	15,2	40,0	2,0	6	■
JCG790200E2R300.0Z6	10010519	2	E	20,0	20,0	8,0	103,0	19,0	50,0	3,0	6	■
JCG790250E2R400.0Z6	10010520	2	E	25,0	25,0	8,0	108,0	23,8	50,0	4,0	6	■

■ Stocked standard.

Universal

Steel and cast iron

Stainless steel and S-materials

Non ferrous

Hard

Plastic and cfrp

Graphite

X-Heads

Minimaster Plus

Minimaster

Universal
Steel and cast iron
Cutting data – JCG790 Side milling roughing

SMG		a _e /DC	apmxs	f _z						v _c	
				6	8	10	12	16	20		25
S1	A/D	0.0500	1	0.018	0.024	0.030	0.036	0.048	0.060	0.075	830 (420 — 1300)
		0,0500	1	0,00070	0,00095	0,0012	0,0014	0,0019	0,0024	0,0030	2725 (1400 — 4200)
S2	A/D	0.0500	1	0.018	0.024	0.030	0.036	0.048	0.060	0.075	670 (340 — 1100)
		0,0500	1	0,00070	0,00095	0,0012	0,0014	0,0019	0,0024	0,0030	2200 (1200 — 3600)
S3	A/D	0.0500	1	0.018	0.024	0.030	0.036	0.048	0.060	0.075	570 (290 — 950)
		0,0500	1	0,00070	0,00095	0,0012	0,0014	0,0019	0,0024	0,0030	1875 (960 — 3100)

Stainless steel and S-materials
Cutting data – JCG790 Slot milling

SMG		a _p /DC	f _z						v _c	
			6	8	10	12	16	20		25
S1	A/D	0.05	0.018	0.024	0.030	0.036	0.048	0.060	0.075	830 (420 — 1300)
		0,05	0,00070	0,00095	0,0012	0,0014	0,0019	0,0024	0,0030	2725 (1400 — 4200)
S2	A/D	0.05	0.018	0.024	0.030	0.036	0.048	0.060	0.075	670 (340 — 1100)
		0,05	0,00070	0,00095	0,0012	0,0014	0,0019	0,0024	0,0030	2200 (1200 — 3600)
S3	A/D	0.05	0.018	0.024	0.030	0.036	0.048	0.060	0.075	570 (290 — 950)
		0,05	0,00070	0,00095	0,0012	0,0014	0,0019	0,0024	0,0030	1875 (960 — 3100)

For cutting data recalculations, see pages 556 - 563

SMG = Seco material group
Coolant = A=air D=dry E=emulsion M=mist spray
v_c = m/min (sf/min)
f_z = mm (in/tooth)
a_p = mm/DC (in/DC) = factor
a_e = mm/DC (in/DC) = factor
All cutting data are target values

JH724

High speed – ISO– M and ISO– S - Taper Shape – 4 Flutes – Cylindrical

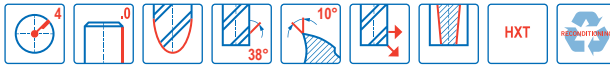
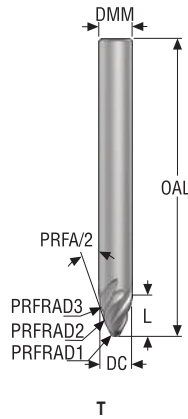

- Tolerances:
- DMM=h5
- PRFRAD1= ±0.03 mm
- Form tolerance PRFRAD2= 0.02 mm
- Regrind possible if PRFRAD is ≥1,5

Designation	Grade	Item number	Length index	Tool shape	DC	DMM	L	OAL	PRFRAD1	PRFRAD2	PRFRAD3	PRFA/2°	PCEDC	Cylindrical
					mm	mm	mm	mm	mm	mm	mm			
JH724100T2R2R030.0Z4	HXT	10106106	2	T	10,0	10,0	12,3	89,0	2,0	30,0	5,0	20,0	4	■
JH724100T2R2R050.0Z4	HXT	10106107	2	T	10,0	10,0	12,5	89,0	2,0	50,0	5,0	20,0	4	■
JH724100T2R3R100.0Z4	HXT	10106108	2	T	10,0	10,0	10,7	89,0	3,0	100,0	5,0	20,0	4	■
JH724100T2R3R250.0Z4	HXT	10106109	2	T	10,0	10,0	10,8	89,0	3,0	250,0	5,0	20,0	4	■

■ Stocked standard.

Universal

Steel and cast iron

Stainless steel and S-materials

Non ferrous

Hard

Plastic and CFRP

Graphite

X-Heads

Minimaster Plus

Minimaster

Cutting data – JH724 Copy milling finishing

SMG		a_e/DC	f_z	v_c
			10	
P12	E	0,010 0.010	0,05 0.0022	120 (95 - 135) 400 (310 - 445)
M1	E	0,010 0.010	0,05 0.0022	150 (125 - 155) 490 (410 - 510)
M2	E	0,010 0.010	0,05 0.0022	145 (120 - 150) 475 (400 - 490)
M3	E	0,010 0.010	0,05 0.0022	130 (95 - 140) 425 (310 - 460)
S2	E	0,010 0.010	0,05 0.0022	65 (55 - 75) 215 (180 - 245)
S11	E	0,010 0.010	0,05 0.0022	130 (95 - 140) 425 (310 - 475)
S12	E	0,010 0.010	0,05 0.0022	120 (95 - 135) 400 (310 - 445)
S13	E	0,010 0.010	0,05 0.0022	95 (80 - 100) 310 (260 - 320)

SMG = Seco material group
Coolant = A=air D=dry E=emulsion M=mist spray
 v_c = m/min (sf/min)
 f_z = mm (in/tooth)
 a_p = mm/DC (in/DC) = factor
 a_e = mm/DC (in/DC) = factor
All cutting data are target values

Universal

Steel and cast iron

Stainless steel and S-materials

Non ferrous

Hard

Plastic and cfrp

Graphite

X-Heads

Minimaster Plus

Minimaster

JH726

High speed – ISO– M and ISO– S - Taper Shape – 6 Flutes – Cylindrical

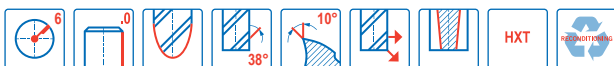
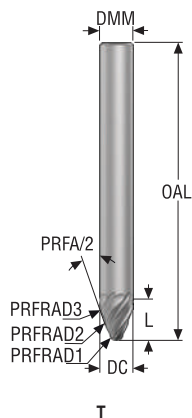

- Tolerances:
- DMM=h5
- PRFRAD1= ±0.03 mm
- Form tolerance PRFRAD2= 0.02 mm
- Regrind possible if PRFRAD is ≥1,5

Designation	Grade	Item number	Length index	Tool shape	DC	DMM	L	OAL	PRFRAD1	PRFRAD2	PRFRAD3	PRFA/2°	PCEDC	Cylindrical
					mm	mm	mm	mm	mm	mm	mm			
JH726100T2R2R030.0Z6	HXT	10106110	2	T	10,0	10,0	10,8	89,0	2,0	30,0	5,0	20,0	6	■
JH726100T2R2R050.0Z6	HXT	10106111	2	T	10,0	10,0	10,7	89,0	2,0	50,0	5,0	20,0	6	■
JH726100T2R3R100.0Z6	HXT	10106112	2	T	10,0	10,0	12,3	89,0	3,0	100,0	5,0	20,0	6	■
JH726100T2R3R250.0Z6	HXT	10106113	2	T	10,0	10,0	12,5	89,0	3,0	250,0	5,0	20,0	6	■

■ Stocked standard.

Universal

Steel and cast iron

Stainless steel and S-materials

Non ferrous

Hard

Plastic and CFRP

Graphite

X-Heads

Minimaster Plus

Minimaster

Cutting data – JH726 Copy milling finishing

SMG		a_e/DC	f_z	v_c
			10	
P12	E	0,010 0.010	0,05 0.0022	120 (95 - 135) 400 (310 - 445)
M1	E	0,010 0.010	0,05 0.0022	150 (125 - 155) 490 (410 - 510)
M2	E	0,010 0.010	0,05 0.0022	145 (120 - 150) 475 (400 - 490)
M3	E	0,010 0.010	0,05 0.0022	130 (95 - 140) 425 (310 - 460)
S2	E	0,010 0.010	0,05 0.0022	65 (55 - 75) 215 (180 - 245)
S11	E	0,010 0.010	0,05 0.0022	130 (95 - 140) 425 (310 - 475)
S12	E	0,010 0.010	0,05 0.0022	120 (95 - 135) 400 (310 - 445)
S13	E	0,010 0.010	0,05 0.0022	95 (80 - 100) 310 (260 - 320)

SMG = Seco material group
Coolant = A=air D=dry E=emulsion M=mist spray
 v_c = m/min (sf/min)
 f_z = mm (in/tooth)
 a_p = mm/DC (in/DC) = factor
 a_e = mm/DC (in/DC) = factor
All cutting data are target values

Universal

Steel and cast iron

Stainless steel and S-materials

Non ferrous

Hard

Plastic and cfrp

Graphite

X-Heads

Minimaster Plus

Minimaster

JH734

High speed – ISO– M and ISO– S - Drop Shape – 4 Flutes – Cylindrical

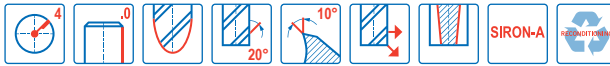
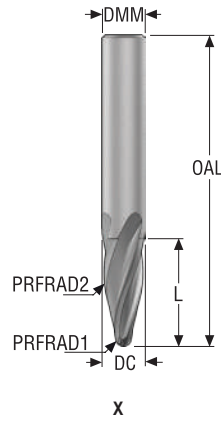

- Tolerances:
- DMM= h5
- PRFRAD1= ±0.03mm
- Form tolerance PRFRAD2= 0.02mm
- Re grind possible if PRFRAD is ≥1,5

Designation	Grade	Item number	Length index	Tool shape	DC	DMM	L	OAL	PRFRAD1	PRFRAD2	PCEDC	Cylindrical
					mm	mm	mm	mm	mm	mm		
JH734060X2R1R95.0Z4	SIRA	10044783	2	X	6,0	6,0	20,8	62,0	1,0	95,0	4	■
JH734080X2R1R90.0Z4	SIRA	10044784	2	X	8,0	8,0	24,5	68,0	1,0	90,0	4	■
JH734100X2R2R85.0Z4	SIRA	10044785	2	X	10,0	10,0	24,7	72,0	2,0	85,0	4	■
JH734120X2R2R80.0Z4	SIRA	10044786	2	X	12,0	12,0	27,3	83,0	2,0	80,0	4	■
JH734160X2R3R75.0Z4	SIRA	10044787	2	X	16,0	16,0	30,1	92,0	3,0	75,0	4	■

■ Stocked standard.

Universal

Steel and cast iron

Stainless steel and S-materials

Non ferrous

Hard

Plastic and CFRP

Graphite

X-Heads

Minimaster Plus

Minimaster

Cutting data – JH734 Copy milling finishing

SMG		a _p /DC	f _z					v _c
			6	8	10	12	16	
P8	E	0,010	0,03	0,04	0,05	0,06	0,08	170 (150 - 195)
		0,010	0,0012	0,0016	0,0022	0,0024	0,0032	560 (490 - 640)
P12	E	0,010	0,03	0,04	0,05	0,06	0,08	120 (95 - 135)
		0,010	0,0012	0,0016	0,0022	0,0024	0,0032	400 (310 - 445)
M1	E	0,010	0,03	0,04	0,05	0,06	0,08	150 (125 - 155)
		0,010	0,0012	0,0016	0,0022	0,0024	0,0032	490 (410 - 510)
M2	E	0,010	0,03	0,04	0,05	0,06	0,08	145 (120 - 150)
		0,010	0,0012	0,0016	0,0022	0,0024	0,0032	475 (400 - 490)
M3	E	0,010	0,03	0,04	0,05	0,06	0,08	130 (90 - 140)
		0,010	0,0012	0,0016	0,0022	0,0024	0,0032	425 (295 - 460)
S2	E	0,010	0,03	0,04	0,05	0,06	0,08	60 (50 - 70)
		0,010	0,0012	0,0016	0,0022	0,0024	0,0032	195 (165 - 230)
S11	E	0,010	0,03	0,04	0,05	0,06	0,08	100 (85 - 105)
		0,010	0,0012	0,0016	0,0022	0,0024	0,0032	320 (280 - 345)
S12	E	0,010	0,03	0,04	0,05	0,06	0,08	95 (80 - 100)
		0,010	0,0012	0,0016	0,0022	0,0024	0,0032	310 (260 - 320)
S13	E	0,010	0,03	0,04	0,05	0,06	0,08	90 (75 - 95)
		0,010	0,0012	0,0016	0,0022	0,0024	0,0032	295 (245 - 310)

SMG = Seco material group
 Coolant = A=air D=dry E=emulsion M=mist spray
 v_c = m/min (sf/min)
 f_z = mm (in/tooth)
 a_p = mm/DC (in/DC) = factor
 a_e = mm/DC (in/DC) = factor
 All cutting data are target values

Universal
 Steel and cast iron
 Stainless steel and S-materials
 Non ferrous
 Hard
 Plastic and cfrp
 Graphite
 X-Heads
 Minimaster Plus
 Minimaster

JH736

High speed – ISO– M and ISO– S - Drop Shape – 6 Flutes – Cylindrical

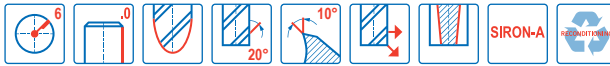
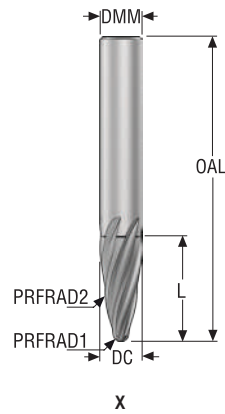

- Tolerances:
- DMM= h5
- PRFRAD1= ±0.03mm
- Form tolerance PRFRAD2= 0.02mm
- Re grind possible

Designation	Grade	Item number	Length index	Tool shape	DC	DMM	L	OAL	PRFRAD1	PRFRAD2	PCEDC	Cylindrical
					mm	mm	mm	mm	mm	mm		
JH736100X2R2R85.0Z6	SIRA	10044834	2	X	10,0	10,0	24,7	72,0	2,0	85,0	6	■
JH736120X2R2R80.0Z6	SIRA	10044835	2	X	12,0	12,0	27,3	83,0	2,0	80,0	6	■
JH736160X2R3R75.0Z6	SIRA	10044836	2	X	16,0	16,0	30,1	92,0	3,0	75,0	6	■

■ Stocked standard.

Universal

Steel and cast iron

Stainless steel and S-materials

Non ferrous

Hard

Plastic and CFRP

Graphite

X-Heads

Minimaster Plus

Minimaster

Cutting data – JH736 Copy milling finishing

SMG		a _p /DC	f _z			v _c
			10	12	16	
P8	E	0,010	0,05	0,06	0,08	170 (150 - 195)
		0.010	0.0022	0.0024	0.0032	560 (490 - 640)
P12	E	0,010	0,05	0,06	0,08	120 (95 - 135)
		0.010	0.0022	0.0024	0.0032	400 (310 - 445)
M1	E	0,010	0,05	0,06	0,08	150 (125 - 155)
		0.010	0.0022	0.0024	0.0032	490 (410 - 510)
M2	E	0,010	0,05	0,06	0,08	145 (120 - 150)
		0.010	0.0022	0.0024	0.0032	475 (400 - 490)
M3	E	0,010	0,05	0,06	0,08	130 (90 - 140)
		0.010	0.0022	0.0024	0.0032	425 (295 - 460)
S2	E	0,010	0,05	0,06	0,08	60 (50 - 70)
		0.010	0.0022	0.0024	0.0032	195 (165 - 230)
S11	E	0,010	0,05	0,06	0,08	100 (85 - 105)
		0.010	0.0022	0.0024	0.0032	320 (280 - 345)
S12	E	0,010	0,05	0,06	0,08	95 (80 - 100)
		0.010	0.0022	0.0024	0.0032	310 (260 - 320)
S13	E	0,010	0,05	0,06	0,08	90 (75 - 95)
		0.010	0.0022	0.0024	0.0032	295 (245 - 310)

SMG = Seco material group
Coolant = A=air D=dry E=emulsion M=mist spray
v_c = m/min (sf/min)
f_z = mm (in/tooth)
a_p = mm/DC (in/DC) = factor
a_e = mm/DC (in/DC) = factor
All cutting data are target values

Universal
Steel and cast iron
Stainless steel and S-materials
Non ferrous
Hard
Plastic and cfrp
Graphite
X-Heads
Minimaster Plus
Minimaster

JH744

High speed – ISO– M and ISO– S - Taper Shape – 4 Flutes – Cylindrical

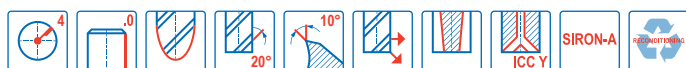
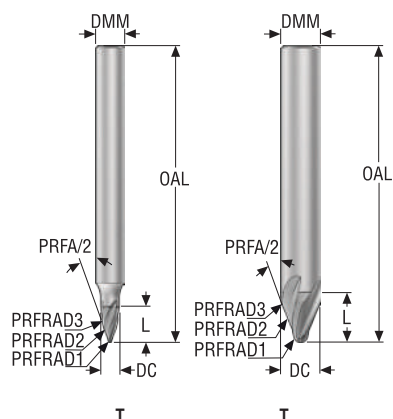

- Tolerances:
- DMM= h5
- PRFRAD1= ±0.03mm
- Form tolerance PRFRAD2= 0.02mm
- Regrind possible if PRFRAD1 is ≥1,5

Designation	Grade	Item number	Length index	Tool shape	ICC	DC	DMM	L	OAL	PRFRAD1	PRFRAD2	PRFRAD3	PRFA/2°	PCEDC	Cylindrical
						mm	mm	mm	mm	mm	mm	mm			
JH744100T1R1.5R250.0Z4	SIRA	10044920	1	T	-	10,0	10,0	5,4	72,0	1,5	250,0	2,0	65,0	4	■
JH744120T1R3R250.0Z4	SIRA	10044921	1	T	-	12,0	12,0	10,5	89,0	3,0	250,0	6,0	32,5	4	■
JH744160T1R4R500.0Z4	SIRA	10044922	1	T	-	16,0	16,0	14,6	108,0	4,0	500,0	8,0	27,5	4	■
JH744040T2R0.5R250.0Z4	SIRA	10044923	2	T	-	4,0	6,0	7,6	62,0	0,5	250,0	3,0	17,5	4	■
JH744060T2R1R250.0Z4	SIRA	10044924	2	T	-	6,0	6,0	9,6	62,0	1,0	250,0	3,0	17,5	4	■
JH744080T2R1.5R250.0Z4	SIRA	10044925	2	T	-	8,0	8,0	10,7	68,0	1,5	250,0	4,0	20,0	4	■
JH744100T2R2R250.0Z4	SIRA	10044926	2	T	-	10,0	10,0	12,7	75,0	2,0	250,0	5,0	20,0	4	■
JH744120T2R3R250.0Z4	SIRA	10044927	2	T	-	12,0	12,0	13,7	89,0	3,0	250,0	6,0	20,0	4	■
JH744160T2R4R500.0Z4	SIRA	10044928	2	T	-	16,0	16,0	17,6	108,0	4,0	500,0	8,0	20,0	4	■
JH744160T2R2R1000.0Z4	SIRA	10044929	2	T	-	16,0	16,0	31,3	108,0	2,0	1000,0	5,0	12,5	4	■
JH744160T2R4R1000.0Z4	SIRA	10044930	2	T	-	16,0	16,0	24,1	108,0	4,0	1000,0	5,0	12,5	4	■
JH744160T4R4R1000.0Z4A	SIRA	10044931	4	T	■	16,0	16,0	24,1	150,0	4,0	1000,0	5,0	12,5	4	■

■ Stocked standard.

Universal

Steel and cast iron

Stainless steel and S-materials

Non ferrous

Hard

Plastic and CFRP

Graphite

X-Heads

Minimaster Plus

Minimaster

Cutting data – JH744 Copy milling finishing

SMG		a _p /DC	f _z						v _c
			4	6	8	10	12	16	
P8	E	0,010	0,02	0,03	0,04	0,05	0,06	0,08	170 (150 - 195)
		0,010	0,0008	0,0012	0,0016	0,0022	0,0024	0,0032	560 (490 - 640)
P12	E	0,010	0,02	0,03	0,04	0,05	0,06	0,08	120 (95 - 135)
		0,010	0,0008	0,0012	0,0016	0,0022	0,0024	0,0032	400 (310 - 445)
M1	E	0,010	0,02	0,03	0,04	0,05	0,06	0,08	150 (125 - 155)
		0,010	0,0008	0,0012	0,0016	0,0022	0,0024	0,0032	490 (410 - 510)
M2	E	0,010	0,02	0,03	0,04	0,05	0,06	0,08	145 (120 - 150)
		0,010	0,0008	0,0012	0,0016	0,0022	0,0024	0,0032	475 (400 - 490)
M3	E	0,010	0,02	0,03	0,04	0,05	0,06	0,08	130 (90 - 140)
		0,010	0,0008	0,0012	0,0016	0,0022	0,0024	0,0032	425 (295 - 460)
S2	E	0,010	0,02	0,03	0,04	0,05	0,06	0,08	60 (50 - 70)
		0,010	0,0008	0,0012	0,0016	0,0022	0,0024	0,0032	195 (165 - 230)
S11	E	0,010	0,02	0,03	0,04	0,05	0,06	0,08	100 (85 - 105)
		0,010	0,0008	0,0012	0,0016	0,0022	0,0024	0,0032	320 (280 - 345)
S12	E	0,010	0,02	0,03	0,04	0,05	0,06	0,08	95 (80 - 100)
		0,010	0,0008	0,0012	0,0016	0,0022	0,0024	0,0032	310 (260 - 320)
S13	E	0,010	0,02	0,03	0,04	0,05	0,06	0,08	90 (75 - 95)
		0,010	0,0008	0,0012	0,0016	0,0022	0,0024	0,0032	295 (245 - 310)

SMG = Seco material group
Coolant = A=air D=dry E=emulsion M=mist spray
v_c = m/min (sf/min)
f_z = mm (in/tooth)
a_p = mm/DC (in/DC) = factor
a_e = mm/DC (in/DC) = factor
All cutting data are target values

Universal

Steel and cast iron

Stainless steel and S-materials

Non ferrous

Hard

Plastic and cfrp

Graphite

X-Heads

Minimaster Plus

Minimaster

JH746

High speed – ISO– M and ISO– S - Taper Shape – 6 Flutes – Cylindrical

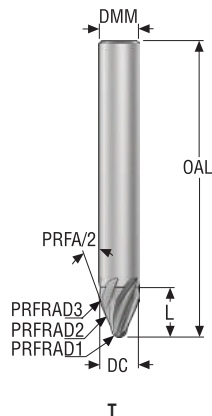

- Tolerances:
- DMM= h5
- PRFRAD1= ±0.03mm
- Form tolerance PRFRAD2= 0.02mm
- Regrind possible

Designation	Grade	Item number	Length index	Tool shape	ICC	DC	DMM	L	OAL	PRFRAD1	PRFRAD2	PRFRAD3	PRFA/2°	PCEDC	Cylindrical
						mm	mm	mm	mm	mm	mm	mm			
JH746100T2R2R250.0Z6	SIRA	10044958	2	T	–	10,0	10,0	12,7	75,0	2,0	250,0	5,0	20,0	6	■
JH746120T2R3R250.0Z6	SIRA	10044959	2	T	–	12,0	12,0	13,7	89,0	3,0	250,0	6,0	20,0	6	■
JH746160T2R4R500.0Z6	SIRA	10044960	2	T	–	16,0	16,0	17,6	108,0	4,0	500,0	8,0	20,0	6	■
JH746160T4R4R500.0Z6A	SIRA	10044961	4	T	■	16,0	16,0	17,6	150,0	4,0	500,0	8,0	20,0	6	■

■ Stocked standard.

Universal
Steel and cast iron
Stainless steel and S-materials
Non ferrous
Hard
Plastic and CFRP
Graphite
X-Heads
Minimaster Plus
Minimaster

Cutting data – JH744 Copy milling finishing

SMG		a _e /DC	f _z			v _c
			10	12	16	
P8	E	0,010	0,05	0,06	0,08	170 (150 - 195)
		0,010	0,0022	0,0024	0,0032	560 (490 - 640)
P12	E	0,010	0,05	0,06	0,08	120 (95 - 135)
		0,010	0,0022	0,0024	0,0032	400 (310 - 445)
M1	E	0,010	0,05	0,06	0,08	150 (125 - 155)
		0,010	0,0022	0,0024	0,0032	490 (410 - 510)
M2	E	0,010	0,05	0,06	0,08	145 (120 - 150)
		0,010	0,0022	0,0024	0,0032	475 (400 - 490)
M3	E	0,010	0,05	0,06	0,08	130 (90 - 140)
		0,010	0,0022	0,0024	0,0032	425 (295 - 460)
S2	E	0,010	0,05	0,06	0,08	60 (50 - 70)
		0,010	0,0022	0,0024	0,0032	195 (165 - 230)
S11	E	0,010	0,05	0,06	0,08	100 (85 - 105)
		0,010	0,0022	0,0024	0,0032	320 (280 - 345)
S12	E	0,010	0,05	0,06	0,08	95 (80 - 100)
		0,010	0,0022	0,0024	0,0032	310 (260 - 320)
S13	E	0,010	0,05	0,06	0,08	90 (75 - 95)
		0,010	0,0022	0,0024	0,0032	295 (245 - 310)

SMG = Seco material group
Coolant = A=air D=dry E=emulsion M=mist spray
v_c = m/min (sf/min)
f_z = mm (in/tooth)
a_p = mm/DC (in/DC) = factor
a_e = mm/DC (in/DC) = factor
All cutting data are target values

Cutting data – JH744 Copy milling roughing

SMG		a _e /DC	f _z			v _c
			10	12	16	
P12	E	0,025	0,03	0,036	0,048	120 (95 - 135)
		0,025	0,0012	0,0014	0,0019	400 (310 - 445)
M1	E	0,025	0,03	0,036	0,048	145 (120 - 150)
		0,025	0,0012	0,0014	0,0019	475 (400 - 490)
M2	E	0,025	0,03	0,036	0,048	145 (120 - 150)
		0,025	0,0012	0,0014	0,0019	475 (400 - 490)
S12	E	0,025	0,03	0,036	0,048	95 (80 - 100)
		0,025	0,0012	0,0014	0,0019	310 (270 - 320)

SMG = Seco material group
Coolant = A=air D=dry E=emulsion M=mist spray
v_c = m/min (sf/min)
f_z = mm (in/tooth)
a_p = mm/DC (in/DC) = factor
a_e = mm/DC (in/DC) = factor
All cutting data are target values

JH770

High speed – CoCr/Titanium – Square – 3-4-5-6 Flutes – Cylindrical – Corner radius

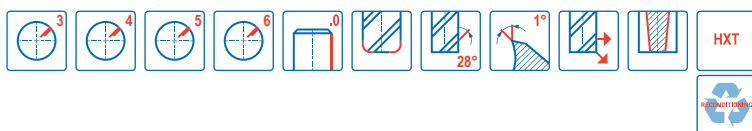
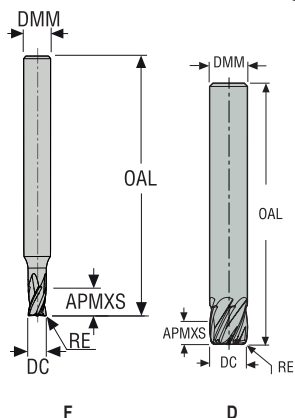

- Tolerances:
- DMM= h5
- DC= e7
- RE= ±0,02 mm
- Re grind possible if DC is ≥Ø6

Designation	Item number	Length index	Tool shape	DC	DMM	APMXS	OAL	RE	PCEDC	Cylindrical
				mm	mm	mm	mm	mm		
JH770030F2R020.0Z3-HXT	03320783	2	F	3,0	6,0	5,0	58,0	0,2	3	■
JH770040F2R020.0Z4-HXT	03320784	2	F	4,0	6,0	6,0	58,0	0,2	4	■
JH770050F2R020.0Z4-HXT	10000170	2	F	5,0	6,0	7,0	58,0	0,2	4	■
JH770060D2R050.0Z4-HXT	03127351	2	D	6,0	6,0	8,0	50,0	0,5	4	■
JH770080D2R050.0Z4-HXT	03127352	2	D	8,0	8,0	10,0	58,0	0,5	4	■
JH770080D2R050.0Z5-HXT	03127354	2	D	8,0	8,0	10,0	58,0	0,5	5	■
JH770080D2R100.0Z4-HXT	03127353	2	D	8,0	8,0	10,0	58,0	1,0	4	■
JH770080D2R100.0Z5-HXT	03127355	2	D	8,0	8,0	10,0	58,0	1,0	5	■
JH770080D2R100.0Z6-HXT	03127356	2	D	8,0	8,0	10,0	58,0	1,0	6	■
JH770100D2R100.0Z5-HXT	03127357	2	D	10,0	10,0	12,0	66,0	1,0	5	■
JH770100D2R100.0Z6-HXT	03127358	2	D	10,0	10,0	12,0	66,0	1,0	6	■

■ Stocked standard.

Universal

Steel and cast iron

Stainless steel and S-materials

Non ferrous

Hard

Plastic and CFRP

Graphite

X-Heads

Minimaster Plus

Minimaster

Cutting data – JH770 Side milling roughing PCEDC 3 and 4

SMG		a _e /DC	a _p /DC	f _z				v _c
				3	4	6	8	
S2	E	0.750	0.12	0.015	0.020	0.030	0.040	50 (42 – 62)
		0,750	0,12	0,00060	0,00080	0,0012	0,0016	165 (140 – 200)
S11	E	0.250	0.32	0.0075	0.010	0.015	0.020	65 (53 – 91)
		0,250	0,32	0,00030	0,00040	0,00060	0,00080	215 (180 – 290)
S12	E	0.250	0.32	0.0075	0.010	0.015	0.020	50 (41 – 70)
		0,250	0,32	0,00030	0,00040	0,00060	0,00080	165 (140 – 220)

Cutting data – JH770 Side milling roughing PCEDC 6

SMG		a _e /DC	a _p /DC	f _z		v _c
				8	10	
S2	E	0.750	0.12	0.050	0.060	55 (43 – 64)
		0,750	0,12	0,0020	0,0024	180 (150 – 200)
S11	E	0.250	0.32	0.022	0.026	65 (54 – 93)
		0,250	0,32	0,00085	0,0010	215 (180 – 300)
S12	E	0.250	0.32	0.022	0.026	50 (42 – 71)
		0,250	0,32	0,00085	0,0010	165 (140 – 230)

For cutting data recalculations, see pages 556 - 563

SMG = Seco material group

Coolant = A=air D=dry E=emulsion M=mist spray

v_c = m/min (sf/min)

f_z = mm (in/tooth)

a_p = mm/DC (in/DC) = factor

a_e = mm/DC (in/DC) = factor

All cutting data are target values

Universal
Steel and cast iron
Stainless steel and S-materials
Non ferrous
Hard
Plastic and cfrp
Graphite
X-Heads
Minimaster Plus
Minimaster

JH740

High speed – CoCr/Titanium – Bottom finisher – 4-5 Flutes – Cylindrical – Corner radius

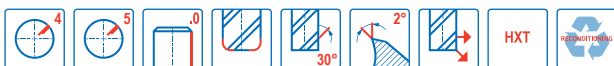
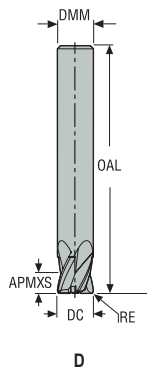

- Tolerances:
- DMM=h5
- DC=e7
- RE= ±0,02 mm
- Re grind possible

Designation	Item number	Length index	Tool shape	DC	DMM	APMXS	OAL	RE	PCEDC	Cylindrical
				mm	mm	mm	mm	mm		
JH740060D2R025.0Z4-HXT	03127359	2	D	6,0	6,0	6,0	50,0	0,25	4	■
JH740060D2R050.0Z4-HXT	03127360	2	D	6,0	6,0	6,0	50,0	0,5	4	■
JH740080D2R025.0Z4-HXT	03127361	2	D	8,0	8,0	8,0	58,0	0,25	4	■
JH740080D2R050.0Z4-HXT	03127362	2	D	8,0	8,0	8,0	58,0	0,5	4	■
JH740100D2R025.0Z5-HXT	03127363	2	D	10,0	10,0	10,0	66,0	0,25	5	■
JH740100D2R050.0Z5-HXT	03127364	2	D	10,0	10,0	10,0	66,0	0,5	5	■

■ Stocked standard.

Universal

Steel and cast iron

Stainless steel and S-materials

Non ferrous

Hard

Plastic and CFRP

Graphite

X-Heads

Minimaster Plus

Minimaster

Cutting data – JH740 Face finishing PCEDC 4

SMG		a _e /DC	a _p /DC	f _z		v _c
				6	8	
S2	E	0.500	0.0060	0.044	0.060	50 (40 – 59)
		0,500	0,0060	0,0017	0,0024	165 (140 – 190)
S11	E	0.500	0.0060	0.044	0.060	65 (52 – 77)
		0,500	0,0060	0,0017	0,0024	215 (180 – 250)
S12	E	0.500	0.0060	0.044	0.060	50 (40 – 59)
		0,500	0,0060	0,0017	0,0024	165 (140 – 190)

Cutting data – JH740 Face finishing PCEDC 5

SMG		a _e /DC	a _p /DC	f _z	v _c
				10	
S2	E	0.500	0.0065	0.046	48 (39 – 58)
		0,500	0,0065	0,0018	155 (130 – 190)
S11	E	0.500	0.0065	0.046	65 (51 – 75)
		0,500	0,0065	0,0018	215 (170 – 240)
S12	E	0.500	0.0065	0.046	48 (39 – 58)
		0,500	0,0065	0,0018	155 (130 – 190)

SMG = Seco material group
 Coolant = A=air D=dry E=emulsion M=mist spray
 v_c = m/min (sf/min)
 f_z = mm (in/tooth)
 a_p = mm/DC (in/DC) = factor
 a_e = mm/DC (in/DC) = factor
 All cutting data are target values

Universal
 Steel and cast iron
 Stainless steel and S-materials
 Non ferrous
 Hard
 Plastic and cfrp
 Graphite
 X-Heads
 Minimaster Plus
 Minimaster

JH710

High speed – CoCr/Titanium – Square – 5 Flutes – Cylindrical – Corner radius

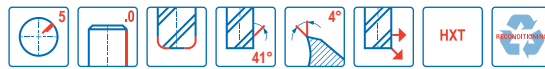
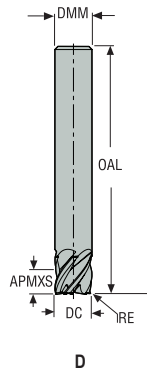

- Tolerances:
- DMM=h5
- DC=e7
- RE= ±0,02 mm
- Re grind possible

Designation	Item number	Length index	Tool shape	DC	DMM	APMXS	OAL	RE	PCEDC	Cylindrical
				mm	mm	mm	mm	mm		
JH710060D2R025.0Z5-HXT	03127365	2	D	6,0	6,0	6,0	57,0	0,25	5	■
JH710060D2R050.0Z5-HXT	03127366	2	D	6,0	6,0	6,0	57,0	0,5	5	■
JH710080D2R025.0Z5-HXT	03127367	2	D	8,0	8,0	8,0	63,0	0,25	5	■
JH710080D2R050.0Z5-HXT	03127368	2	D	8,0	8,0	8,0	63,0	0,5	5	■
JH710080D2R100.0Z5-HXT	03127369	2	D	8,0	8,0	8,0	63,0	1,0	5	■

■ Stocked standard.

Universal

Steel and cast iron

Stainless steel and S-materials

Non ferrous

Hard

Plastic and CFRP

Graphite

X-Heads

Minimaster Plus

Minimaster

Cutting data – JH710 Side milling finishing

SMG		a _e /DC	a _p /DC	f _z		v _c
				6	8	
S1	E	0,00800	0,65	0,034	0,044	100 (79 – 110)
		0,00800	0,65	0,0013	0,0017	330 (260 – 360)
S2	E	0,00800	0,65	0,034	0,044	100 (79 – 110)
		0,00800	0,65	0,0013	0,0017	330 (260 – 360)
S3	E	0,00800	0,65	0,034	0,044	100 (79 – 110)
		0,00800	0,65	0,0013	0,0017	330 (260 – 360)
S11	E	0,00800	0,65	0,036	0,046	180 (160 – 200)
		0,00800	0,65	0,0014	0,0018	590 (530 – 650)
S12	E	0,00800	0,65	0,036	0,046	135 (120 – 150)
		0,00800	0,65	0,0014	0,0018	445 (400 – 490)
S13	E	0,00800	0,65	0,032	0,040	105 (92 – 120)
		0,00800	0,65	0,0013	0,0016	345 (310 – 390)

SMG = Seco material group
 Coolant = A=air D=dry E=emulsion M=mist spray
 v_c = m/min (sf/min)
 f_z = mm (in/tooth)
 a_p = mm/DC (in/DC) = factor
 a_e = mm/DC (in/DC) = factor
 All cutting data are target values

Universal

Steel and cast iron

Stainless steel and S-materials

Non ferrous

Hard

Plastic and cfrp

Graphite

X-Heads

Minimaster Plus

Minimaster

JH790

High speed – CoCr/Titanium – T Cutter – 6 Flutes – Cylindrical

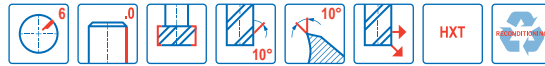
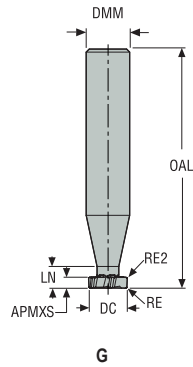

- Tolerances:
- DMM=h5
- DC= ±0,02 mm
- RE= ±0,02 mm
- Re grind possible

Designation	Item number	Length index	Tool shape	DC	DMM	APMXS	OAL	LN	RE	RE2	PCEDC	Cylindrical
				mm	mm	mm	mm	mm	mm	mm	mm	
JH790095G2R025.0Z6-HXT	03127370	2	G	9,5	10,0	2,0	66,0	5,0	0,25	0,25	6	■
JH790095G2R050.0Z6-HXT	03127371	2	G	9,5	10,0	2,0	66,0	5,0	0,5	0,5	6	■
JH790095G3R025.0Z6-HXT	03127372	3	G	9,5	10,0	2,54	66,0	5,0	0,25	0,25	6	■
JH790095G3R050.0Z6-HXT	03127373	3	G	9,5	10,0	2,54	66,0	5,0	0,5	0,5	6	■

■ Stocked standard.

Universal

Steel and cast iron

Stainless steel and S-materials

Non ferrous

Hard

Plastic and cfrp

Graphite

X-Heads

Minimaster Plus

Minimaster

Cutting data – JH790 (T) Side milling roughing

SMG		a_p/DC		f_z	v_c
				9.5	
S2	E	0.189	0.19	0.030	39 (31 – 50)
		0,189	0,19	0,0012	130 (110 – 160)
S11	E	0.189	0.19	0.022	85 (66 – 100)
		0,189	0,19	0,00085	280 (220 – 320)
S12	E	0.189	0.19	0.022	65 (51 – 80)
		0,189	0,19	0,00085	215 (170 – 260)

SMG = Seco material group
 Coolant = A=air D=dry E=emulsion M=mist spray
 v_c = m/min (sf/min)
 f_z = mm (in/tooth)
 a_p = mm/DC (in/DC) = factor
 a_e = mm/DC (in/DC) = factor
 All cutting data are target values

- Universal
- Steel and cast iron
- Stainless steel and S-materials
- Non ferrous
- Hard
- Plastic and CFRP
- Graphite
- X-Heads
- Minimaster Plus
- Minimaster

JH730

High speed – CoCr/Titanium – Square – 6-7 Flutes – Cylindrical – Corner radius

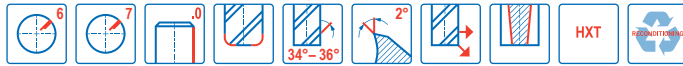
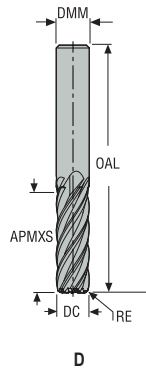

- Tolerances:
- DMM=h5
- DC=e7
- RE= ±0,02 mm
- Re grind possible

Designation	Item number	Length index	Tool shape	DC	DMM	APMXS	OAL	RE	PCEDC	Cylindrical
				mm	mm	mm	mm	mm		
JH730080D2R050.0Z6-HXT	03127375	2	D	8,0	8,0	25,0	63,0	0,5	6	■
JH730080D2R100.0Z6-HXT	03127377	2	D	8,0	8,0	25,0	63,0	1,0	6	■
JH730080D2R150.0Z6-HXT	03127378	2	D	8,0	8,0	25,0	63,0	1,5	6	■
JH730080D2R200.0Z6-HXT	03127379	2	D	8,0	8,0	25,0	63,0	2,0	6	■
JH730100D2R100.0Z7-HXT	03127380	2	D	10,0	10,0	31,0	72,0	1,0	7	■
JH730100D2R250.0Z7-HXT	03127381	2	D	10,0	10,0	31,0	72,0	2,5	7	■

■ Stocked standard.

Universal

Steel and cast iron

Stainless steel and S-materials

Non ferrous

Hard

Plastic and CFRP

Graphite

X-Heads

Minimaster Plus

Minimaster

Cutting data – JH730 Side milling finishing

SMG		a _e /DC	a _p /DC	f _z		v _c
				8	10	
S2	E	0.0625	1.8	0.020	0.025	80 (63 – 93)
		0,0625	1,8	0,00080	0,0010	260 (210 – 300)
S11	E	0.0625	1.8	0.016	0.020	135 (110 – 160)
		0,0625	1,8	0,00065	0,00080	445 (370 – 520)
S12	E	0.0625	1.8	0.016	0.020	105 (83 – 120)
		0,0625	1,8	0,00065	0,00080	345 (280 – 390)

For cutting data recalculations, see pages 556 - 563

SMG = Seco material group

Coolant = A=air D=dry E=emulsion M=mist spray

v_c = m/min (sf/min)

f_z = mm (in/tooth)

a_p = mm/DC (in/DC) = factor

a_e = mm/DC (in/DC) = factor

All cutting data are target values

Universal
 Steel and cast iron
 Stainless steel and S-materials
 Non ferrous
 Hard
 Plastic and cfrp
 Graphite
 X-Heads
 Minimaster Plus
 Minimaster

JHP994

High performance – CoCr/Titanium – Square – 4 Flutes – Cylindrical – Chamfer

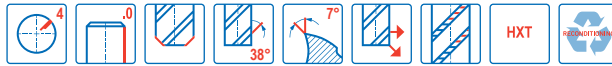
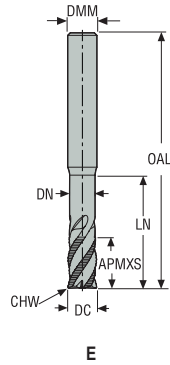

- Tolerances:
- DMM=h5
- DC=-0,02/-0,1 mm
- CHW=0/-0,1 mm
- Re grind possible

Designation	Item number	Length index	Tool shape	DC	DMM	APMXS	OAL	LN	DN	CHW	PCEDC	Cylindrical
				mm	mm	mm	mm	mm	mm	mm		
JHP994060E3C.0Z4-HXT	03127382	3	E	6,0	6,0	14,0	63,0	24,0	5,6	0,2	4	■
JHP994080E3C.0Z4-HXT	03127383	3	E	8,0	8,0	18,0	69,0	32,0	7,4	0,2	4	■
JHP994100E3C.0Z4-HXT	03127384	3	E	10,0	10,0	22,0	88,0	40,0	9,4	0,2	4	■

■ Stocked standard.

Universal

Steel and cast iron

Stainless steel and S-materials

Non ferrous

Hard

Plastic and cfrp

Graphite

X-Heads

Minimaster Plus

Minimaster

Cutting data – JHP994 Side milling roughing

SMG		a _e /DC	a _p /DC	f _z			v _c
				6	8	10	
S2	E	0.0480	2.0	0.025	0.032	0.042	55 (40 – 69)
		0,0480	2,0	0,0010	0,0013	0,0017	180 (140 – 220)
S11	E	0.450	0.60	0.025	0.034	0.042	50 (39 – 77)
		0,450	0,60	0,0010	0,0013	0,0017	165 (130 – 250)
S12	E	0.450	0.60	0.025	0.034	0.042	40 (30 – 59)
		0,450	0,60	0,0010	0,0013	0,0017	130 (99 – 190)

Cutting data – JHP994 Slot milling

SMG		a _p /DC	f _z			v _c
			6	8	10	
S2	E	2.0	0.011	0.014	0.018	33 (24 – 41)
		2,0	0,00044	0,00055	0,00070	110 (79 – 130)
S11	E	0.60	0.025	0.034	0.042	42 (32 – 63)
		0,60	0,0010	0,0013	0,0017	140 (110 – 200)
S12	E	0.60	0.025	0.034	0.042	33 (25 – 48)
		0,60	0,0010	0,0013	0,0017	110 (83 – 150)

SMG = Seco material group
Coolant = A=air D=dry E=emulsion M=mist spray
v_c = m/min (sf/min)
f_z = mm (in/tooth)
a_p = mm/DC (in/DC) = factor
a_e = mm/DC (in/DC) = factor
All cutting data are target values

Universal

Steel and cast iron

Stainless steel and S-materials

Non ferrous

Hard

Plastic and CFRP

Graphite

X-Heads

Minimaster Plus

Minimaster

JH780

High speed – CoCr/Titanium – Tapered ball nose – 4 Flutes – Cylindrical

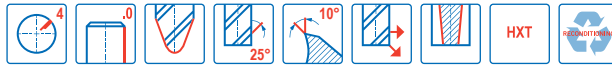
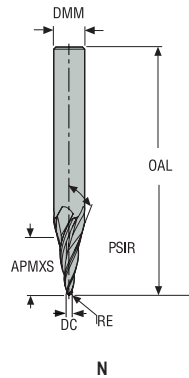

- Tolerances:
- DMM=h5
- DC= ±0,04 mm
- RE= ±0,01 mm
- Regrind possible

Designation	Item number	Length index	Tool shape	DC	DMM	APMXS	OAL	RE	PSIR	PCEDC	Cylindrical
				mm	mm	mm	mm	mm	mm		
JH780018N2R100.0Z4-HXT	03127386	2	N	1,827	8,0	23,5	63,0	1,0	5,1838	4	■
JH780028N2R150.0Z4-HXT	03127387	2	N	2,803	8,0	23,5	63,0	1,5	3,8915	4	■
JH780038N2R200.0Z4-HXT	03127388	2	N	3,823	8,0	23,5	63,0	2,0	2,5972	4	■
JH780049N2R250.0Z4-HXT	03127389	2	N	4,888	8,0	23,5	63,0	2,5	1,3003	4	■

■ Stocked standard.

Universal

Steel and cast iron

Stainless steel and S-materials

Non ferrous

Hard

Plastic and CFRP

Graphite

X-Heads

Minimaster Plus

Minimaster

Cutting data – JH780 Copy milling roughing

SMG		a _e /DC	a _p /DC	f _z				v _c
				1.8	2.8	3.8	4.9	
S2	E	0.0510	4.2	0.0080	0.012	0.017	0.022	70 (54 – 86)
		0,0510	4,2	0,00032	0,00048	0,00065	0,00085	230 (180 – 280)
S12	E	0.0510	4.2	0.0060	0.0090	0.013	0.016	95 (76 – 110)
		0,0510	4,2	0,00024	0,00036	0,00050	0,00065	310 (250 – 360)

For cutting data recalculations, see pages 556 - 563

SMG = Seco material group

Coolant = A=air D=dry E=emulsion M=mist spray

v_c = m/min (sf/min)

f_z = mm (in/tooth)

a_p = mm/DC (in/DC) = factor

a_e = mm/DC (in/DC) = factor

All cutting data are target values

Universal
 Steel and cast iron
 Stainless steel and S-materials
 Non ferrous
 Hard
 Plastic and cfrp
 Graphite
 X-Heads
 Minimaster Plus
 Minimaster

JHB720

High speed – Titanium – Ball nose – 3 Flutes – Cylindrical

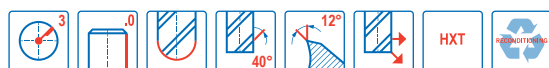
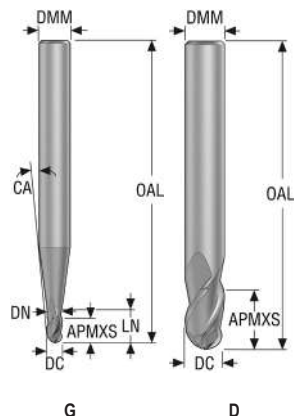

- Tolerances:
- DMM=h5
- DC=-0,02/-0,04 mm
- RE= ±0,01 mm
- Regrind possible if DC is ≥Ø6

Designation	Grade	Item number	Length index	Tool shape	DC	DMM	APMXS	OAL	LN	DN	CA°	PCEDC	Cylindrical
					mm	mm	mm	mm	mm	mm			
JHB720020G2B.0Z3	HXT	10072323	2	G	2,0	6,0	3,0	60,0	6,0	1,9	7,0	3	■
JHB720030G2B.0Z3	HXT	10072324	2	G	3,0	6,0	4,5	60,0	6,5	2,8	5,0	3	■
JHB720035G2B.0Z3	HXT	10072325	2	G	3,5	6,0	5,0	65,0	7,0	3,2	3,5	3	■
JHB720040G2B.0Z3	HXT	10072326	2	G	4,0	6,0	6,0	65,0	8,0	3,7	3,0	3	■
JHB720060D2B.0Z3	HXT	10072327	2	D	6,0	6,0	9,0	75,0	-	-	-	3	■
JHB720080D2B.0Z3	HXT	10072328	2	D	8,0	8,0	12,0	75,0	-	-	-	3	■
JHB720100D2B.0Z3	HXT	10072329	2	D	10,0	10,0	15,0	80,0	-	-	-	3	■
JHB720120D2B.0Z3	HXT	10072330	2	D	12,0	12,0	18,0	90,0	-	-	-	3	■
JHB720160D2B.0Z3	HXT	10072331	2	D	16,0	16,0	24,0	100,0	-	-	-	3	■

■ Stocked standard.

Universal

Steel and cast iron

Stainless steel and S-materials

Non ferrous

Hard

Plastic and CFRP

Graphite

X-Heads

Minimaster Plus

Minimaster

Cutting data – JHB720 Side milling

SMG	Coolant	a _p /DC	a _e /DC	f _z									v _c
				2	3	3.5	4	6	8	10	12	16	
M1	E	0.200	1.2	0.0080	0.012	0.014	0.016	0.024	0.032	0.040	0.048	0.060	85 (62 – 110)
		0,200	1,2	0,00032	0,00048	0,00055	0,00065	0,00095	0,0013	0,0016	0,0019	0,0024	280 (210 – 360)
M2	E	0.200	1.2	0.0080	0.012	0.014	0.016	0.024	0.032	0.040	0.048	0.060	70 (51 – 90)
		0,200	1,2	0,00032	0,00048	0,00055	0,00065	0,00095	0,0013	0,0016	0,0019	0,0024	230 (170 – 290)
M3	E	0.200	1.2	0.0080	0.012	0.014	0.016	0.024	0.032	0.040	0.048	0.060	65 (46 – 84)
		0,200	1,2	0,00032	0,00048	0,00055	0,00065	0,00095	0,0013	0,0016	0,0019	0,0024	215 (160 – 270)
M4	E	0.200	1.2	0.0070	0.011	0.012	0.014	0.022	0.028	0.034	0.042	0.050	50 (35 – 65)
		0,200	1,2	0,00028	0,00044	0,00048	0,00055	0,00085	0,0011	0,0013	0,0017	0,0020	165 (120 – 210)
M5	E	0.200	1.2	0.0070	0.011	0.012	0.014	0.022	0.028	0.034	0.042	0.050	42 (29 – 54)
		0,200	1,2	0,00028	0,00044	0,00048	0,00055	0,00085	0,0011	0,0013	0,0017	0,0020	140 (96 – 170)
N1	E/M/A	0.400	1.2	0.020	0.030	0.036	0.040	0.060	0.080	0.10	0.12	0.15	600 (500 – 690)
		0,400	1,2	0,00080	0,0012	0,0014	0,0016	0,0024	0,0032	0,0040	0,0048	0,0060	1975 (1700 – 2200)
N2	E/M/A	0.400	1.2	0.016	0.024	0.028	0.032	0.048	0.065	0.080	0.095	0.12	500 (400 – 600)
		0,400	1,2	0,00065	0,00095	0,0011	0,0013	0,0019	0,0026	0,0032	0,0038	0,0048	1650 (1400 – 1900)
N3	E/M/A	0.400	1.2	0.016	0.024	0.028	0.032	0.048	0.065	0.080	0.095	0.12	335 (270 – 400)
		0,400	1,2	0,00065	0,00095	0,0011	0,0013	0,0019	0,0026	0,0032	0,0038	0,0048	1100 (890 – 1300)
N11	E/M/A	0.300	1.2	0.012	0.018	0.022	0.024	0.036	0.048	0.060	0.070	0.090	300 (260 – 340)
		0,300	1,2	0,00048	0,00070	0,00085	0,00095	0,0014	0,0019	0,0024	0,0028	0,0036	980 (860 – 1100)
S1	E	0.100	1.2	0.0065	0.0095	0.011	0.013	0.019	0.026	0.032	0.038	0.048	43 (29 – 57)
		0,100	1,2	0,00026	0,00038	0,00044	0,00050	0,00075	0,0010	0,0013	0,0015	0,0019	140 (96 – 180)
S2	E	0.100	1.2	0.0065	0.0095	0.011	0.013	0.019	0.026	0.032	0.038	0.048	35 (24 – 46)
		0,100	1,2	0,00026	0,00038	0,00044	0,00050	0,00075	0,0010	0,0013	0,0015	0,0019	115 (79 – 150)
S3	E	0.100	1.2	0.0060	0.0090	0.011	0.012	0.018	0.024	0.030	0.036	0.044	30 (21 – 39)
		0,100	1,2	0,00024	0,00036	0,00044	0,00048	0,00070	0,00095	0,0012	0,0014	0,0017	100 (69 – 120)
S11	E	0.300	1.2	0.010	0.015	0.018	0.020	0.030	0.040	0.050	0.060	0.075	90 (79 – 100)
		0,300	1,2	0,00040	0,00060	0,00070	0,00080	0,0012	0,0016	0,0020	0,0024	0,0030	295 (260 – 320)
S12	E	0.300	1.2	0.010	0.015	0.018	0.020	0.030	0.040	0.050	0.060	0.075	70 (61 – 80)
		0,300	1,2	0,00040	0,00060	0,00070	0,00080	0,0012	0,0016	0,0020	0,0024	0,0030	230 (210 – 260)
S13	E	0.300	1.2	0.0085	0.013	0.015	0.017	0.026	0.034	0.044	0.050	0.065	55 (48 – 63)
		0,300	1,2	0,00034	0,00050	0,00060	0,00065	0,0010	0,0013	0,0017	0,0020	0,0026	180 (160 – 200)
TS1	A	0.400	1.2	0.020	0.030	0.036	0.040	0.060	0.080	0.10	0.12	0.15	500 (400 – 600)
		0,400	1,2	0,00080	0,0012	0,0014	0,0016	0,0024	0,0032	0,0040	0,0048	0,0060	1650 (1400 – 1900)
TP1	M	0.400	1.2	0.020	0.030	0.036	0.040	0.060	0.080	0.10	0.12	0.15	500 (400 – 600)
		0,400	1,2	0,00080	0,0012	0,0014	0,0016	0,0024	0,0032	0,0040	0,0048	0,0060	1650 (1400 – 1900)

For cutting data recalculations, see pages 556 - 563

SMG = Seco material group
Coolant = A=air D=dry E=emulsion M=mist spray
v_c = m/min (sf/min)
f_z = mm (in/tooth)
a_p = mm/DC (in/DC) = factor
a_e = mm/DC (in/DC) = factor
All cutting data are target values

JH721

High speed – CoCr/Titanium – Ball nose – 6 Flutes – Cylindrical

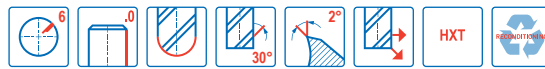
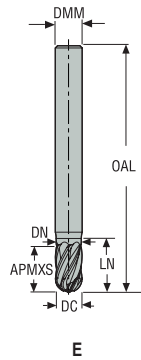

- Tolerances:
- DMM=h5
- DC=e7
- RE= ±0,02 mm
- Re grind possible

Designation	Item number	Length index	Tool shape	DC	DMM	APMXS	OAL	LN	DN	PCEDC	Cylindrical
				mm	mm	mm	mm	mm	mm		
JH721060E2B.0Z6-HXT	03127390	2	E	6,0	6,0	10,0	57,0	12,0	5,6	6	■
JH721080E2B.0Z6-HXT	03127391	2	E	8,0	8,0	13,0	58,0	16,0	7,4	6	■

■ Stocked standard.

Universal

Steel and cast iron

Stainless steel and S-materials

Non ferrous

Hard

Plastic and CFRP

Graphite

X-Heads

Minimaster Plus

Minimaster

Cutting data – JH721 Copy milling finishing

SMG		a _e /DC	a _p /DC	f _z		v _c
				6	8	
S2	E	0.0424	0.040	0.032	0.042	120 (110 – 140)
		0,0424	0,040	0,0013	0,0017	395 (370 – 450)
S11	E	0.0424	0.040	0.032	0.042	210 (140 – 230)
		0,0424	0,040	0,0013	0,0017	690 (460 – 750)
S12	E	0.0424	0.040	0.032	0.042	160 (110 – 180)
		0,0424	0,040	0,0013	0,0017	520 (370 – 590)

SMG = Seco material group

Coolant = A=air D=dry E=emulsion M=mist spray

v_c = m/min (sf/min)

f_z = mm (in/tooth)

a_p = mm/DC (in/DC) = factor

a_e = mm/DC (in/DC) = factor

All cutting data are target values

- Universal
- Steel and cast iron
- Stainless steel and S-materials
- Non ferrous
- Hard
- Plastic and cfrp
- Graphite
- X-Heads
- Minimaster Plus
- Minimaster

JH722

High speed – CoCr/Titanium – Ball nose – 6 Flutes – Cylindrical

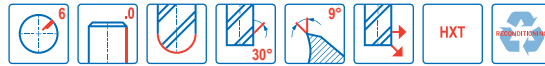
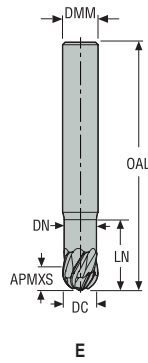

- Tolerances:
- DMM=h5
- DC=e7
- RE= ±0,01 mm
- Regrind possible

Designation	Item number	Length index	Tool shape	DC	DMM	APMXS	OAL	LN	DN	PCEDC	Cylindrical
				mm	mm	mm	mm	mm	mm		
JH722100E2B.0Z6-HXT	03127392	2	E	10,0	10,0	10,0	72,0	20,0	9,4	6	■

■ Stocked standard.

Universal

Steel and cast iron

Stainless steel and S-materials

Non ferrous

Hard

Plastic and cfrp

Graphite

X-Heads

Minimaster Plus

Minimaster

Cutting data – JH722 Copy milling finishing

SMG		a_p/DC		f_z	v_c
				10	
S2	E	0.0500	0.15	0.065	125 (110 – 150)
		0,0500	0,15	0,0026	410 (370 – 490)
S11	E	0.0500	0.15	0.048	210 (190 – 230)
		0,0500	0,15	0,0019	690 (630 – 750)
S12	E	0.0500	0.15	0.048	160 (150 – 180)
		0,0500	0,15	0,0019	520 (500 – 590)

SMG = Seco material group
 Coolant = A=air D=dry E=emulsion M=mist spray
 v_c = m/min (sf/min)
 f_z = mm (in/tooth)
 a_p = mm/DC (in/DC) = factor
 a_e = mm/DC (in/DC) = factor
 All cutting data are target values

- Universal
- Steel and cast iron
- Stainless steel and S-materials
- Non ferrous
- Hard
- Plastic and cfrp
- Graphite
- X-Heads
- Minimaster Plus
- Minimaster

SHF712

High feed – ISO– S – 2 Flutes – Cylindrical – Corner radius

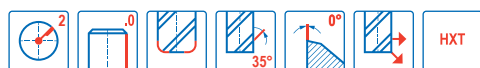
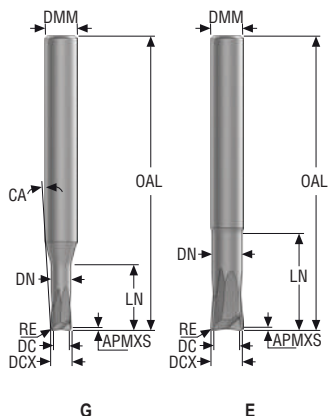

- Tolerances:
- Run-out= <0,005 mm
- DMM = h5
- DC G- Shape = 0/-0,01 mm
- DC E- Shape = 0,005/-0,015 mm
- RE = ±0,005 mm

Designation	Grade	Item number	Length index	Tool shape	DC	DCX	DMM	APMXS	OAL	LN	DN	RE	CA°	PCEDC	Cylindrical
					mm	mm	mm	mm	mm	mm	mm	mm			
SHF712040G2R050.0Z2	HXT	10106493	2	G	3,0	4,0	6,0	0,5	55,0	12,0	3,8	0,5	3,9 °	2	■
SHF712060E2R050.0Z2	HXT	10106494	2	E	5,0	6,0	6,0	0,5	55,0	18,0	5,7	0,5	0,0 °	2	■
SHF712030G3R050.0Z2	HXT	10106495	3	G	2,0	3,0	6,0	0,5	55,0	12,0	2,85	0,5	5,65 °	2	■
SHF712040G3R050.0Z2	HXT	10106496	3	G	3,0	4,0	6,0	0,5	55,0	16,0	3,8	0,5	3,07 °	2	■
SHF712060E3R050.0Z2	HXT	10106497	3	E	5,0	6,0	6,0	0,5	55,0	25,0	5,7	0,5	0,0 °	2	■
SHF712030G4R050.0Z2	HXT	10106498	4	G	2,0	3,0	6,0	0,5	55,0	16,0	2,85	0,5	4,47 °	2	■

■ Stocked standard.

Universal

Steel and cast iron

Stainless steel and S-materials

Non ferrous

Hard

Plastic and CFRP

Graphite

X-Heads

Minimaster Plus

Minimaster

Cutting data – SFH712 Side milling

SMG		a_e/DCX	a_p/DCX	f_z			v_c
				3	4	6	
S2	E	0,30	0,050	0,055	0,075	0,11	65 (51 – 76)
		0,30	0,050	0,0022	0,0030	0,0044	215 (170 – 240)
S12	E	0,30	0,050	0,085	0,12	0,17	170 (150 – 190)
		0,30	0,050	0,0034	0,0048	0,0065	560 (500 – 620)

Cutting data – SFH712 Slot milling

SMG		a_p/DCX	f_z			v_c
			3	4	6	
S2	E	0,050	0,046	0,060	0,090	50 (41 – 60)
		0,050	0,0018	0,0024	0,0036	165 (140 – 190)
S12	E	0,050	0,046	0,060	0,090	145 (130 – 160)
		0,050	0,0018	0,0024	0,0036	475 (430 – 520)

For cutting data recalculations, see pages 556 - 563

SMG = Seco material group
Coolant = A=air D=dry E=emulsion M=mist spray
 v_c = m/min (sf/min)
 f_z = mm (in/tooth)
 a_p = mm/DC (in/DC) = factor
 a_e = mm/DC (in/DC) = factor
All cutting data are target values

Universal

Steel and cast iron

Stainless steel and S-materials

Non ferrous

Hard

Plastic and cfrp

Graphite

X-Heads

Minimaster Plus

Minimaster

SME714/716

Miniature – ISO– S - Square – 2-3 Flutes – Cylindrical – Sharp or corner radius

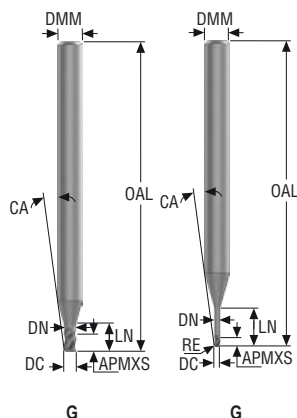

- Tolerances:
- Run-out= <0,005 mm
- DMM = h5
- DC = 0/-0,01 mm
- RE = ±0,005 mm

Designation	Grade	Item number	Length index	Tool shape	DC	DMM	APMXS	OAL	DN	LN	RE	CA°	PCEDC	Cylindrical
					mm	mm	mm	mm	mm	mm	mm			
SME714020G1S.0Z3	HXT	10107349	1	G	2,0	4	2,0	50	1,9	4,0	–	6,86 °	3	■
SME716020G1S.0Z3	HXT	10107360	1	G	2,0	6	2,0	50	1,9	4,0	–	9,42 °	3	■
SME714020G3R010.0Z3	HXT	10107350	3	G	2,0	4	2,5	50	1,9	8,0	0,1	4,68 °	3	■
SME716020G3R010.0Z3	HXT	10107361	3	G	2,0	6	2,5	50	1,9	8,0	0,1	7,14 °	3	■
SME716010G4R010.0Z3	HXT	10107362	4	G	1,0	6	1,2	50	0,95	6,0	0,1	9,03 °	3	■
SME716015G4R010.0Z3	HXT	10107363	4	G	1,5	6	1,8	50	1,4	10,0	0,1	6,79 °	3	■
SME714010G4R010.0Z3	HXT	10107351	4	G	2,0	4	1,2	50	0,95	6,0	0,1	7,13 °	3	■
SME714015G4R010.0Z3	HXT	10107352	4	G	2,0	4	1,8	50	1,4	10,0	0,1	4,72 °	3	■
SME714020G4R010.0Z3	HXT	10107353	4	G	2,0	4	2,5	50	1,9	12,0	0,1	3,53 °	3	■
SME716020G4R010.0Z3	HXT	10107364	4	G	2,0	6	2,5	50	1,9	12,0	0,1	5,72 °	3	■
SME714015G5R010.0Z3	HXT	10107354	5	G	1,5	4	1,8	50	1,4	12,0	0,1	3,38 °	3	■
SME716015G5R010.0Z3	HXT	10107365	5	G	1,5	6	1,8	50	1,4	12,0	0,1	6,15 °	3	■
SME714020G5R010.0Z3	HXT	10107355	5	G	2,0	4	2,5	50	1,9	16,0	0,1	2,83 °	3	■
SME716020G5R010.0Z3	HXT	10107366	5	G	2,0	6	2,5	50	1,9	16,0	0,1	4,77 °	3	■
SME714005G6R005.0Z2	HXT	10107356	6	G	0,5	4	0,6	50	0,45	5,0	0,05	8,31 °	2	■
SME716005G6R005.0Z2	HXT	10107367	6	G	0,5	6	0,6	50	0,45	5,0	0,05	9,93 °	2	■
SME714010G6R010.0Z3	HXT	10107357	6	G	1,0	4	1,2	50	0,95	12,0	0,1	4,77 °	3	■
SME716010G6R010.0Z3	HXT	10107368	6	G	1,0	6	1,6	50	0,95	12,0	0,1	6,56 °	3	■
SME714015G6R010.0Z3	HXT	10107358	6	G	1,5	4	1,8	50	1,4	16,0	0,1	3,38 °	3	■
SME716015G6R010.0Z3	HXT	10107369	6	G	1,5	6	1,8	50	1,4	16,0	0,1	5,16 °	3	■
SME714010G7R010.0Z3	HXT	10107359	7	G	1,0	4	1,2	50	0,95	16,0	0,1	3,9 °	3	■
SME716010G7R010.0Z3	HXT	10107370	7	G	1,0	6	1,2	50	0,95	16,0	0,1	5,55 °	3	■

■ Stocked standard.

Universal

Steel and cast iron

Stainless steel and S-materials

Non ferrous

Hard

Plastic and CFRP

Graphite

X-Heads

Minimaster Plus

Minimaster

Universal
Steel and cast iron
Stainless steel and S-materials
Cutting data – SME714 Side milling roughing

SMG		a _e /DC	a _p /DC	f _z				v _c
				0.5	1	1.5	2	
S2	E	0,0800	0,070	0,0036	0,0070	0,010	0,014	60 (31 – 120)
		0,0800	0,070	0,00014	0,00028	0,00040	0,00055	195 (110 – 390)
S12	E	0,0800	0,070	0,0036	0,0070	0,010	0,014	65 (33 – 130)
		0,0800	0,070	0,00014	0,00028	0,00040	0,00055	215 (110 – 420)

Cutting data – SME714 Slot milling

SMG		a _p /DC	f _z				v _c
			0.5	1	1.5	2	
S2	E	0,070	0,0036	0,0070	0,010	0,014	41 (21 – 82)
		0,070	0,00014	0,00028	0,00040	0,00055	135 (69 – 260)
S12	E	0,070	0,0036	0,0070	0,010	0,014	45 (23 – 89)
		0,070	0,00014	0,00028	0,00040	0,00055	150 (76 – 290)

For cutting data recalculations, see pages 556 - 563

SMG = Seco material group
Coolant = A=air D=dry E=emulsion M=mist spray
v_c = m/min (sf/min)
f_z = mm (in/tooth)
a_p = mm/DC (in/DC) = factor
a_e = mm/DC (in/DC) = factor
All cutting data are target values

Hard
Plastic and CFRP
Cutting data – SME716 Side milling roughing

SMG		a _e /DC	a _p /DC	f _z				v _c
				0.5	1	1.5	2	
S2	E	0,0800	0,070	0,0036	0,0070	0,010	0,014	60 (31 – 120)
		0,0800	0,070	0,00014	0,00028	0,00040	0,00055	195 (110 – 390)
S12	E	0,0800	0,070	0,0036	0,0070	0,010	0,014	65 (33 – 130)
		0,0800	0,070	0,00014	0,00028	0,00040	0,00055	215 (110 – 420)

Graphite
X-Heads
Minimaster Plus
Minimaster
Cutting data – SME716 Slot milling

SMG		a _p /DC	f _z				v _c
			0.5	1	1.5	2	
S2	E	0,070	0,0036	0,0070	0,010	0,014	41 (21 – 82)
		0,070	0,00014	0,00028	0,00040	0,00055	135 (69 – 260)
S12	E	0,070	0,0036	0,0070	0,010	0,014	45 (23 – 89)
		0,070	0,00014	0,00028	0,00040	0,00055	150 (76 – 290)

For cutting data recalculations, see pages 556 - 563

SMG = Seco material group
Coolant = A=air D=dry E=emulsion M=mist spray
v_c = m/min (sf/min)
f_z = mm (in/tooth)
a_p = mm/DC (in/DC) = factor
a_e = mm/DC (in/DC) = factor
All cutting data are target values

SMB713/714/716

Miniature – ISO– S – Ball nose – 2 Flutes – Cylindrical

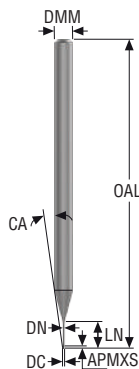

G

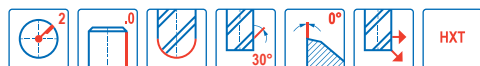

- Tolerances:
- Run-out= <0,005 mm
- DMM = h5
- DC = 0/-0,01 mm
- RE = ±0,005 mm

Designation	Grade	Item number	Length index	Tool shape	DC	DMM	APMXS	OAL	DN	LN	CA°	PCEDC	Cylindrical
					mm	mm	mm	mm	mm	mm			
SMB714020G2B.0Z2	HXT	10109582	2	G	2,0	4	2,0	50	1,9	6,0	6,13 °	2	■
SMB716020G2B.0Z2	HXT	10109596	2	G	2,0	6	2,0	50	1,9	6,0	8,72 °	2	■
SMB714030G2B.0Z2	HXT	10109583	2	G	3,0	4	3,0	50	2,85	9,0	2,85 °	2	■
SMB716030G2B.0Z2	HXT	10109597	2	G	3,0	6	3,0	50	2,85	9,0	6,22 °	2	■
SMB714030G3B.0Z2	HXT	10109584	3	G	3,0	4	3,0	50	2,85	12,0	2,2 °	2	■
SMB716030G3B.0Z2	HXT	10109598	3	G	3,0	6	3,0	50	2,85	12,0	5,11 °	2	■
SMB714015G4B.0Z2	HXT	10109585	4	G	1,5	4	1,5	50	1,4	9,0	5,29 °	2	■
SMB716015G4B.0Z2	HXT	10109599	4	G	1,5	6	1,5	50	1,4	9,0	7,44 °	2	■
SMB714020G4B.0Z2	HXT	10109586	4	G	2,0	4	2,0	50	1,9	10,0	4,3 °	2	■
SMB716020G4B.0Z2	HXT	10109600	4	G	2,0	6	2,0	50	1,9	10,0	6,69 °	2	■
SMB714005G5B.0Z2	HXT	10109587	5	G	0,5	4	0,5	50	0,45	4,0	9,23 °	2	■
SMB716005G5B.0Z2	HXT	10109601	5	G	0,5	6	0,5	50	0,45	4,0	10,73 °	2	■
SMB714010G5B.0Z2	HXT	10109588	5	G	1,0	4	1,0	50	0,95	10,0	5,5 °	2	■
SMB716010G5B.0Z2	HXT	10109602	5	G	1,0	6	1,0	50	0,95	10,0	7,37 °	2	■
SMB714015G5B.0Z2	HXT	10109589	5	G	1,5	4	1,5	50	1,4	12,0	4,41 °	2	■
SMB716015G5B.0Z2	HXT	10109603	5	G	1,5	6	1,5	50	1,4	12,0	6,35 °	2	■
SMB714020G5B.0Z2	HXT	10109590	5	G	2,0	4	2,0	50	1,9	16,0	2,96 °	2	■
SMB716020G5B.0Z2	HXT	10109604	5	G	2,0	6	2,0	50	1,9	16,0	4,96 °	2	■
SMB713003G6B.0Z2	HXT	10109581	6	G	0,3	3	0,3	50	0,28	4,0	8,24 °	2	■
SMB714005G6B.0Z2	HXT	10109591	6	G	0,5	4	0,5	50	0,45	6,0	7,8 °	2	■
SMB716005G6B.0Z2	HXT	10109605	6	G	0,5	6	0,5	50	0,45	6,0	9,46 °	2	■
SMB714010G6B.0Z2	HXT	10109592	6	G	1,0	4	1,0	50	0,95	12,0	4,97 °	2	■
SMB716010G6B.0Z2	HXT	10109606	6	G	1,0	6	1,0	50	0,95	12,0	6,69 °	2	■
SMB714015G6B.0Z2	HXT	10109593	6	G	1,5	4	1,5	50	1,4	16,0	3,49 °	2	■
SMB716015G6B.0Z2	HXT	10109607	6	G	1,5	6	1,5	55	1,4	16,0	5,31 °	2	■
SMB714005G7B.0Z2	HXT	10109594	7	G	0,5	4	0,5	50	0,45	9,0	6,33 °	2	■
SMB716005G7B.0Z2	HXT	10109608	7	G	0,5	6	0,5	50	0,45	9,0	8,03 °	2	■
SMB714010G7B.0Z2	HXT	10109595	7	G	1,0	4	1,0	50	0,95	16,0	3,98 °	2	■
SMB716010G7B.0Z2	HXT	10109609	7	G	1,0	6	1,0	55	0,95	16,0	5,64 °	2	■

■ Stocked standard.

Universal

Steel and cast iron

Stainless steel and S-materials

Non ferrous

Hard

Plastic and CFRP

Graphite

X-Heads

Minimaster Plus

Minimaster

Cutting data – SMB713 Copy milling roughing

SMG		a_e/DC	a_p/DC	f_z		v_c
				0.3		
S2	E	0,0600	0,050	0,0020		47 (26 – 64)
		<i>0.0600</i>	<i>0.050</i>	<i>0.000080</i>		155 (86 – 200)
S12	E	0,0600	0,050	0,0020		47 (26 – 64)
		<i>0.0600</i>	<i>0.050</i>	<i>0.000080</i>		155 (86 – 200)

Cutting data – SMB714 Copy milling roughing

SMG		a_e/DC	a_p/DC	f_z					v_c
				0.5	1	1.5	2	3	
S2	E	0,0600	0,050	0,0036	0,0070	0,010	0,014	0,020	60 (33 – 81)
		<i>0.0600</i>	<i>0.050</i>	<i>0.00014</i>	<i>0.00028</i>	<i>0.00040</i>	<i>0.00055</i>	<i>0.00080</i>	195 (110 – 260)
S12	E	0,0600	0,050	0,0036	0,0070	0,010	0,014	0,020	60 (33 – 81)
		<i>0.0600</i>	<i>0.050</i>	<i>0.00014</i>	<i>0.00028</i>	<i>0.00040</i>	<i>0.00055</i>	<i>0.00080</i>	195 (110 – 260)

Cutting data – SMB716 Copy milling roughing

SMG		a_e/DC	a_p/DC	f_z					v_c
				0.5	1	1.5	2	3	
S2	E	0,0600	0,050	0,0036	0,0070	0,010	0,014	0,020	60 (33 – 81)
		<i>0.0600</i>	<i>0.050</i>	<i>0.00014</i>	<i>0.00028</i>	<i>0.00040</i>	<i>0.00055</i>	<i>0.00080</i>	195 (110 – 260)
S12	E	0,0600	0,050	0,0036	0,0070	0,010	0,014	0,020	60 (33 – 81)
		<i>0.0600</i>	<i>0.050</i>	<i>0.00014</i>	<i>0.00028</i>	<i>0.00040</i>	<i>0.00055</i>	<i>0.00080</i>	195 (110 – 260)

For cutting data recalculations, see pages 556 - 563

SMG = Seco material group

Coolant = A=air D=dry E=emulsion M=mist spray

v_c = m/min (sf/min)

f_z = mm (in/tooth)

a_p = mm/DC (in/DC) = factor

a_e = mm/DC (in/DC) = factor

All cutting data are target values

JCO710

High performance – Titanium – Square – 4-6 Flutes – Weldon – Corner radius

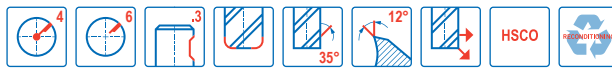
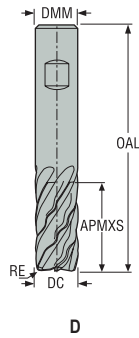

- Tolerances:
- DMM= h6
- DC= k10
- RE= ±0,05 mm
- Re grind possible

Designation	Item number	Length index	Tool shape	DC	DMM	APMXS	OAL	RE	PCEDC	Weldon
				mm	mm	mm	mm	mm		
JCO710160D2R100.3Z4	02810493	2	D	16,0	16,0	32,0	92,0	1,0	4	■
JCO710160D2R250.3Z4	02810494	2	D	16,0	16,0	32,0	92,0	2,5	4	■
JCO710160D2R400.3Z4	02810496	2	D	16,0	16,0	32,0	92,0	4,0	4	■
JCO710200D2R100.3Z4	02810497	2	D	20,0	20,0	38,0	114,0	1,0	4	■
JCO710200D2R400.3Z4	02810500	2	D	20,0	20,0	38,0	114,0	4,0	4	■
JCO710250D2R100.3Z6	02810501	2	D	25,0	25,0	45,0	121,0	1,0	6	■
JCO710320D2R100.3Z6	02810504	2	D	32,0	32,0	53,0	132,0	1,0	6	■
JCO710320D2R400.3Z6	02810505	2	D	32,0	32,0	53,0	132,0	4,0	6	■

■ Stocked standard.

Universal

Steel and cast iron

Stainless steel and S-materials

Non ferrous

Hard

Plastic and cfrp

Graphite

X-Heads

Minimaster Plus

Minimaster

Universal
Cutting data – JCO710 Side milling roughing PCEDC4 LV2

SMG		a _p /DC	a _p /DC	f _z				v _c
				16	20	25	32	
M1	E	0.500	1.2	0.065	0.080	0.095	0.11	21 (15 – 28)
		0,500	1,2	0,0026	0,0032	0,0038	0,0044	70 (50 – 91)
M2	E	0.500	1.2	0.060	0.075	0.085	0.10	17 (12 – 23)
		0,500	1,2	0,0024	0,0030	0,0034	0,0040	55 (40 – 75)
S11	E	0.500	1.1	0.0060	0.0075	0.0085	0.010	13 (9.4 – 18)
		0,500	1,1	0,00024	0,00030	0,00034	0,00040	43 (31 – 59)
S12	E	0.500	1.1	0.0060	0.0075	0.0085	0.010	10 (7.3 – 14)
		0,500	1,1	0,00024	0,00030	0,00034	0,00040	33 (24 – 45)
S13	E	0.500	1.1	0.0050	0.0065	0.0075	0.0090	7 (5.7 – 11)
		0,500	1,1	0,00020	0,00026	0,00030	0,00036	23 (19 – 36)

Steel and cast iron
Stainless steel and S-materials
Cutting data – JCO710 Side milling roughing PCEDC6 LV2

SMG		a _p /DC	a _p /DC	f _z				v _c
				20	25	32	40	
M1	E	0.480	1.2	0.090	0.11	0.14	0.16	18 (13 – 24)
		0,480	1,2	0,0036	0,0044	0,0055	0,0065	60 (43 – 78)
M2	E	0.480	1.2	0.080	0.10	0.12	0.15	15 (11 – 20)
		0,480	1,2	0,0032	0,0040	0,0048	0,0060	49 (37 – 65)
S11	E	0.480	1.2	0.075	0.095	0.12	0.14	11 (7.9 – 15)
		0,480	1,2	0,0030	0,0038	0,0048	0,0055	36 (26 – 49)
S12	E	0.480	1.2	0.075	0.095	0.12	0.14	8 (6.1 – 12)
		0,480	1,2	0,0030	0,0038	0,0048	0,0055	26 (21 – 39)
S13	E	0.480	1.2	0.065	0.085	0.10	0.12	6 (4.9 – 9.6)
		0,480	1,2	0,0026	0,0034	0,0040	0,0048	20 (17 – 31)

Hard
Cutting data – JCO710 Slot milling PCEDC4 LV2

SMG		a _p /DC	f _z				v _c
			16	20	25	32	
M1	E	1.0	0.050	0.060	0.080	0.10	19 (13 – 24)
		1,0	0,0020	0,0024	0,0032	0,0040	60 (43 – 78)
M2	E	1.0	0.050	0.060	0.080	0.10	15 (10 – 20)
		1,0	0,0020	0,0024	0,0032	0,0040	49 (33 – 65)
M3	E	0.50	0.046	0.055	0.065	0.080	10 (7.1 – 15)
		0,50	0,0018	0,0022	0,0026	0,0032	33 (24 – 49)
M4	E	0.50	0.040	0.050	0.060	0.070	8 (5.4 – 11)
		0,50	0,0016	0,0020	0,0024	0,0028	26 (18 – 36)
M5	E	0.50	0.040	0.050	0.060	0.070	6 (4.5 – 9.6)
		0,50	0,0016	0,0020	0,0024	0,0028	20 (15 – 31)
S11	E	0.75	0.0060	0.0075	0.0085	0.010	10 (7.8 – 15)
		0,75	0,00024	0,00030	0,00034	0,00040	33 (26 – 49)
S12	E	0.75	0.0060	0.0075	0.0085	0.010	8 (6.0 – 11)
		0,75	0,00024	0,00030	0,00034	0,00040	26 (20 – 36)
S13	E	0.75	0.0050	0.0065	0.0075	0.0090	6 (4.7 – 9.3)
		0,75	0,00020	0,00026	0,00030	0,00036	20 (16 – 30)

When JCO + SIRA is applied: v_c table * 1.2

For cutting data recalculations, see pages 556 - 563

SMG = Seco material group
Coolant = A=air D=dry E=emulsion M=mist spray
v_c = m/min (sf/min)
f_z = mm (in/tooth)
a_p = mm/DC (in/DC) = factor
a_s = mm/DC (in/DC) = factor
All cutting data are target values



NON FERROUS

Seco offers a complete range of high performance solid carbide square shoulder end mills, ballnose cutters and finish end mills for high productivity for non ferrous materials.

- JS412 and JS413 for sharp corner type.
- JS452, JS453, JHP490, JH40, JH421, JM403, JM404, JM406, JH410 and JH440 for radius type.
- JH450, JH460, SMB413, SMB414, SMB416, JM413 and JM416 for ball-nose type.

Universal

Steel and cast iron

Stainless steel
and S-materials

Non ferrous

Hard

Plastic and CFRP

Graphite



















X-Heads

Minimaster Plus

Minimaster

		Tool selection Non ferrous					
Universal							
Steel and cast iron	Name	JS412	JS413	JS452	JS453	JHP490	
	Page(s)	325	328	331	336	341	
Stainless steel and S-materials	Family name	SOLID ²	SOLID ²	SOLID ²	SOLID ²	HPM	
	Type of mill						
Non ferrous	Shank	Cylindrical	<input checked="" type="checkbox"/>	<input checked="" type="checkbox"/>	<input checked="" type="checkbox"/>	<input checked="" type="checkbox"/>	
		Weldon	<input checked="" type="checkbox"/>	<input checked="" type="checkbox"/>	<input type="checkbox"/>	<input type="checkbox"/>	
		SafeLock				<input type="checkbox"/>	
	Number of Flutes	2	3	2	3	2-3	
	ICC					<input checked="" type="checkbox"/>	
Hard	Diameter range	Metric	2-20	2-20	2-20	2-20	10-25
		Inch					
	Length availability	2	2,3	2,3	2,3	2,3,4	
Plastic and cfrp	Operation						
Graphite	SMG						
	N1	<input checked="" type="checkbox"/>	<input checked="" type="checkbox"/>	<input checked="" type="checkbox"/>	<input checked="" type="checkbox"/>	<input checked="" type="checkbox"/>	
	N2	<input checked="" type="checkbox"/>	<input checked="" type="checkbox"/>	<input checked="" type="checkbox"/>	<input checked="" type="checkbox"/>	<input checked="" type="checkbox"/>	
	N3		<input checked="" type="checkbox"/>	<input checked="" type="checkbox"/>	<input checked="" type="checkbox"/>	<input checked="" type="checkbox"/>	
	N11						
X-Heads	TS1	<input checked="" type="checkbox"/>	<input checked="" type="checkbox"/>	<input checked="" type="checkbox"/>	<input checked="" type="checkbox"/>		
	TP1	<input checked="" type="checkbox"/>	<input checked="" type="checkbox"/>	<input checked="" type="checkbox"/>	<input checked="" type="checkbox"/>		
■ Stock standard □ Weldon available, delivery time is 3 days. □ Safe-Lock available, delivery time is 6 days ● Preferred choice ○ Alternative choice							
Minimaster Plus							
Minimaster							

Tool selection Non ferrous

					
Name		JH40	JH421	JH410	JH440
Page(s)		345	348	352	354
Family name		HSM/TORNADO	HSM/TORNADO	HSM/TORNADO	HSM/TORNADO
Type of mill					
Shank	Cylindrical	■	■	■	■
	Weldon				
	Safelock				
Number of Flutes		2	2	1	2
ICC			■		
Diameter range	Metric	2-20	2-25	2-17	6-8
	Inch				
Length					
Operation					
					
SMG					
N1		●	●	●	●
N2					●
N3					●
N11		●	●	●	●
TS1		●	●	●	●
TP1			●		●

■ Stock standard □ Weldon available, delivery time is 3 days.
● Preferred choice ○ Alternative choice

Universal
Steel and cast iron
Stainless steel and S-materials
Non ferrous
Hard
Plastic and cfrp
Graphite
X-Heads
Minimaster Plus
Minimaster

- Universal
- Steel and cast iron
- Stainless steel and S-materials
- Non ferrous
- Hard
- Plastic and cfrp
- Graphite
- X-Heads
- Minimaster Plus
- Minimaster

Tool selection Non ferrous

Name		JH450	JH460	SMB413/414/416	JM403/404/406	JM413/416
Page(s)		356	358	364	362	364
Family name		HSM/TORNADO	HSM/TORNADO	MINI	MINI	MINI
Type of mill						
Shank	Cylindrical	■	■	■	■	■
	Weldon					
	Safelock					
Number of Flutes		2	2	2	1	2
ICC						
Diameter range	Metric	2-20	3-12	1-3	0,5-2	0,5-2
	Inch					
Length availability		2,3	2	4,5,6,7	1,2,5	2,3,5
Operation						
SMG						
N1		●	●	●	●	●
N2		●		●	●	●
N3		●		●	●	●
N11		●	●			●
TS1		●	●	●		●
TP1		●	●	●		●

■ Stock standard □ Weldon available, delivery time is 3 days.
 ● Preferred choice ○ Alternative choice

JS412

General purpose – Aluminium – Square – 2 Flutes – Cylindrical – Sharp

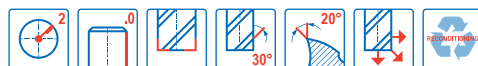
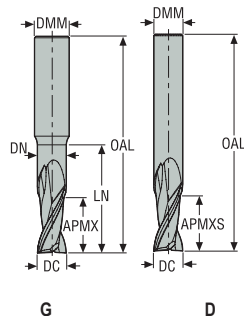

- Tolerances:
- DMM= h5
- DC= e8
- Regrind possible if DC is $\geq \varnothing 6$

Designation	Item number	Length index	Tool shape	DC	DMM	APMXS	OAL	DN	LN	PCEDC	Cylindrical
				mm	mm	mm	mm	mm	mm		
JS412020G2SZ2.0	02881760	2	G	2,0	6,0	4,0	57,0	1,9	7,0	2	■
JS412030G2SZ2.0	02881761	2	G	3,0	6,0	6,0	57,0	2,8	10,0	2	■
JS412040G2SZ2.0	02881762	2	G	4,0	6,0	8,0	57,0	3,8	14,0	2	■
JS412050G2SZ2.0	02881763	2	G	5,0	6,0	10,0	57,0	4,7	17,0	2	■
JS412060D2SZ2.0	02881764	2	D	6,0	6,0	12,0	57,0	-	-	2	■
JS412080D2SZ2.0	02881765	2	D	8,0	8,0	16,0	63,0	-	-	2	■
JS412100D2SZ2.0	02881766	2	D	10,0	10,0	20,0	75,0	-	-	2	■
JS412120D2SZ2.0	02881767	2	D	12,0	12,0	24,0	88,0	-	-	2	■
JS412160D2SZ2.0	02881769	2	D	16,0	16,0	32,0	100,0	-	-	2	■
JS412200D2SZ2.0	02881770	2	D	20,0	20,0	40,0	124,0	-	-	2	■

■ Stocked standard.

Universal

Steel and cast iron

Stainless steel and S-materials

Non ferrous

Hard

Plastic and CFRP

Graphite

X-Heads

Minimaster Plus

Minimaster

JS412

General purpose – Aluminium – Square – 2 Flutes – Weldon – Sharp

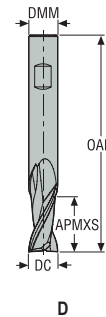

- Tolerances:
- DMM= h5
- DC= e8
- Regrind possible

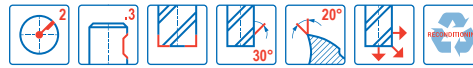

Designation	Item number	Length index	Tool shape	DC	DMM	APMXS	OAL	PCEDC	Weldon
				mm	mm	mm	mm		
JS412060D2SZ2.3	02881771	2	D	6,0	6,0	12,0	57,0	2	■
JS412080D2SZ2.3	02881772	2	D	8,0	8,0	16,0	63,0	2	■
JS412100D2SZ2.3	02881773	2	D	10,0	10,0	20,0	75,0	2	■
JS412120D2SZ2.3	02881774	2	D	12,0	12,0	24,0	88,0	2	■
JS412160D2SZ2.3	02881776	2	D	16,0	16,0	32,0	100,0	2	■
JS412200D2SZ2.3	02881777	2	D	20,0	20,0	40,0	124,0	2	■

■ Stocked standard.

Universal
Steel and cast iron
Stainless steel and S-materials
Non ferrous
Hard
Plastic and CFRP
Graphite
X-Heads
Minimaster Plus
Minimaster

Cutting data – JS412 Side milling

SMG		a _e /DC	a _p /DC	f _z										v _c
				2	3	4	5	6	8	10	12	16	20	
N1	E/M/A	0.400	1.5	0.026	0.038	0.050	0.065	0.080	0.10	0.13	0.15	0.19	0.22	590 (470 – 700)
		0,400	1,5	0,0010	0,0015	0,0020	0,0026	0,0032	0,0040	0,0050	0,0060	0,0075	0,0085	1925 (1600 – 2200)
N2	E/M/A	0.300	1.4	0.026	0.040	0.050	0.065	0.080	0.10	0.13	0.16	0.19	0.22	475 (360 – 590)
		0,300	1,4	0,0010	0,0016	0,0020	0,0026	0,0032	0,0040	0,0050	0,0065	0,0075	0,0085	1550 (1200 – 1900)
TS1	A/D	0.400	1.5	0.024	0.036	0.048	0.060	0.070	0.095	0.12	0.14	0.18	0.20	600 (480 – 710)
		0,400	1,5	0,00095	0,0014	0,0019	0,0024	0,0028	0,0038	0,0048	0,0055	0,0070	0,0080	1975 (1600 – 2300)
TP1	A/D	0.400	1.5	0.024	0.036	0.048	0.060	0.070	0.095	0.12	0.14	0.18	0.20	500 (380 – 630)
		0,400	1,5	0,00095	0,0014	0,0019	0,0024	0,0028	0,0038	0,0048	0,0055	0,0070	0,0080	1650 (1300 – 2000)

Cutting data – JS412 Slot milling

SMG		a _p /DC	f _z										v _c
			2	3	4	5	6	8	10	12	16	20	
N1	E	1.2	0.020	0.030	0.040	0.050	0.060	0.080	0.10	0.12	0.16	0.20	500 (410 – 590)
		1,2	0,00080	0,0012	0,0016	0,0020	0,0024	0,0032	0,0040	0,0048	0,0065	0,0080	1650 (1400 – 1900)
N2	E	1.0	0.016	0.024	0.032	0.040	0.048	0.065	0.080	0.095	0.13	0.16	400 (310 – 500)
		1,0	0,00065	0,00095	0,0013	0,0016	0,0019	0,0026	0,0032	0,0038	0,0050	0,0065	1300 (1100 – 1600)
TS1	A	1.2	0.020	0.030	0.040	0.050	0.060	0.080	0.10	0.12	0.16	0.20	500 (410 – 590)
		1,2	0,00080	0,0012	0,0016	0,0020	0,0024	0,0032	0,0040	0,0048	0,0065	0,0080	1650 (1400 – 1900)
TP1	A	1.2	0.020	0.030	0.040	0.050	0.060	0.080	0.10	0.12	0.16	0.20	420 (320 – 520)
		1,2	0,00080	0,0012	0,0016	0,0020	0,0024	0,0032	0,0040	0,0048	0,0065	0,0080	1375 (1100 – 1700)

For cutting data recalculations, see pages 556 - 563

SMG = Seco material group

Coolant = A=air D=dry E=emulsion M=mist spray

v_c = m/min (sf/min)

f_z = mm (in/tooth)

a_p = mm/DC (in/DC) = factor

a_e = mm/DC (in/DC) = factor

All cutting data are target values

Universal
Steel and cast iron
Stainless steel and S-materials
Non ferrous
Hard
Plastic and CFRP
Graphite
X-Heads
Minimaster Plus
Minimaster

JS413

General purpose – Aluminium – Square – 3 Flutes – Cylindrical – Sharp

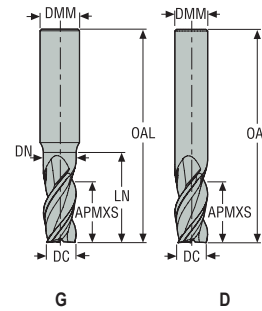

- Tolerances:
- DMM= h5
- DC= e8
- Regrind possible if DC is $\geq \varnothing 6$

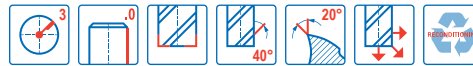

Designation	Item number	Length index	Tool shape	DC	DMM	APMXS	OAL	DN	LN	PCEDC	Cylindrical
				mm	mm	mm	mm	mm	mm		
JS413020G2SZ3.0	02881797	2	G	2,0	6,0	4,0	57,0	1,9	7,0	3	■
JS413030G2SZ3.0	02881798	2	G	3,0	6,0	6,0	57,0	2,8	10,0	3	■
JS413040G2SZ3.0	02881799	2	G	4,0	6,0	8,0	57,0	3,8	14,0	3	■
JS413050G2SZ3.0	02881800	2	G	5,0	6,0	10,0	57,0	4,7	17,0	3	■
JS413060D2SZ3.0	02881801	2	D	6,0	6,0	12,0	57,0	–	–	3	■
JS413080D2SZ3.0	02881802	2	D	8,0	8,0	16,0	63,0	–	–	3	■
JS413100D2SZ3.0	02881803	2	D	10,0	10,0	20,0	72,0	–	–	3	■
JS413120D2SZ3.0	02881804	2	D	12,0	12,0	24,0	88,0	–	–	3	■
JS413160D2SZ3.0	02881806	2	D	16,0	16,0	32,0	100,0	–	–	3	■
JS413200D2SZ3.0	02881807	2	D	20,0	20,0	40,0	124,0	–	–	3	■
JS413060D3SZ3.0	02881815	3	D	6,0	6,0	24,0	70,0	–	–	3	■
JS413080D3SZ3.0	02881816	3	D	8,0	8,0	32,0	85,0	–	–	3	■
JS413100D3SZ3.0	02881817	3	D	10,0	10,0	40,0	100,0	–	–	3	■
JS413120D3SZ3.0	02881818	3	D	12,0	12,0	50,0	115,0	–	–	3	■
JS413160D3SZ3.0	02881820	3	D	16,0	16,0	55,0	125,0	–	–	3	■
JS413200D3SZ3.0	02881821	3	D	20,0	20,0	75,0	150,0	–	–	3	■

■ Stocked standard.

Universal

Steel and cast iron

Stainless steel and S-materials

Non ferrous

Hard

Plastic and CFRP

Graphite

X-Heads

Minimaster Plus

Minimaster

JS413

General purpose – Aluminium – Square – 3 Flutes – Weldon – Sharp

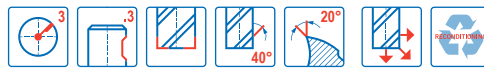
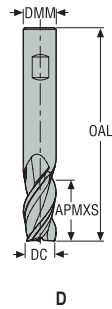

- Tolerances:
- DMM= h5
- DC= e8
- Regrind possible

Designation	Item number	Length index	Tool shape	DC	DMM	APMXS	OAL	PCEDC	Weldon
				mm	mm	mm	mm		
JS413060D2SZ3.3	02881808	2	D	6,0	6,0	12,0	57,0	3	■
JS413080D2SZ3.3	02881809	2	D	8,0	8,0	16,0	63,0	3	■
JS413100D2SZ3.3	02881810	2	D	10,0	10,0	20,0	72,0	3	■
JS413120D2SZ3.3	02881811	2	D	12,0	12,0	24,0	88,0	3	■
JS413160D2SZ3.3	02881813	2	D	16,0	16,0	32,0	100,0	3	■
JS413200D2SZ3.3	02881814	2	D	20,0	20,0	40,0	124,0	3	■
JS413060D3SZ3.3	02881955	3	D	6,0	6,0	24,0	70,0	3	□
JS413080D3SZ3.3	02881956	3	D	8,0	8,0	32,0	85,0	3	□
JS413100D3SZ3.3	02881957	3	D	10,0	10,0	40,0	100,0	3	□
JS413120D3SZ3.3	02881958	3	D	12,0	12,0	50,0	115,0	3	□
JS413160D3SZ3.3	02881960	3	D	16,0	16,0	55,0	125,0	3	□
JS413200D3SZ3.3	02881961	3	D	20,0	20,0	75,0	150,0	3	□

■ Stocked standard. □ Weldon available. Delivery time is 3 days.

Universal

Steel and cast iron

Stainless steel and S-materials

Non ferrous

Hard

Plastic and CFRP

Graphite

X-Heads

Minimaster Plus

Minimaster

Cutting data – JS413 Side milling

SMG		a _e /DC	a _p /DC	f _z										v _c
				2	3	4	5	6	8	10	12	16	20	
N1	E/M/A	0.400	1.5	0.024	0.036	0.048	0.060	0.070	0.095	0.12	0.14	0.18	0.20	600 (480 – 710)
		0,400	1,5	0,00095	0,0014	0,0019	0,0024	0,0028	0,0038	0,0048	0,0055	0,0070	0,0080	1975 (1600 – 2300)
N2	E/M/A	0.300	1.5	0.024	0.036	0.048	0.060	0.070	0.095	0.12	0.14	0.18	0.20	470 (360 – 580)
		0,300	1,5	0,00095	0,0014	0,0019	0,0024	0,0028	0,0038	0,0048	0,0055	0,0070	0,0080	1550 (1200 – 1900)
N3	E/M/A	0.300	1.5	0.024	0.036	0.048	0.060	0.070	0.095	0.12	0.14	0.18	0.20	315 (240 – 390)
		0,300	1,5	0,00095	0,0014	0,0019	0,0024	0,0028	0,0038	0,0048	0,0055	0,0070	0,0080	1025 (790 – 1200)
TS1	A/D	0.400	1.5	0.022	0.034	0.044	0.055	0.065	0.090	0.11	0.13	0.17	0.19	610 (500 – 730)
		0,400	1,5	0,00085	0,0013	0,0017	0,0022	0,0026	0,0036	0,0044	0,0050	0,0065	0,0075	2000 (1700 – 2300)
TP1	A/D	0.400	1.5	0.022	0.034	0.044	0.055	0.065	0.090	0.11	0.13	0.17	0.19	330 (250 – 410)
		0,400	1,5	0,00085	0,0013	0,0017	0,0022	0,0026	0,0036	0,0044	0,0050	0,0065	0,0075	1075 (830 – 1300)

Cutting data – JS413 Slot milling

SMG		a _p /DC	f _z										v _c
			2	3	4	5	6	8	10	12	16	20	
N1	E	1.0	0.020	0.030	0.040	0.050	0.060	0.080	0.10	0.12	0.16	0.20	500 (400 – 600)
		1,0	0,00080	0,0012	0,0016	0,0020	0,0024	0,0032	0,0040	0,0048	0,0065	0,0080	1650 (1400 – 1900)
N2	E	1.0	0.014	0.022	0.028	0.036	0.042	0.055	0.070	0.085	0.11	0.14	400 (300 – 490)
		1,0	0,00055	0,00085	0,0011	0,0014	0,0017	0,0022	0,0028	0,0034	0,0044	0,0055	1300 (990 – 1600)
N3	E	1.0	0.014	0.022	0.028	0.036	0.042	0.055	0.070	0.085	0.11	0.14	265 (200 – 330)
		1,0	0,00055	0,00085	0,0011	0,0014	0,0017	0,0022	0,0028	0,0034	0,0044	0,0055	870 (660 – 1000)
TS1	A	1.0	0.020	0.030	0.040	0.050	0.060	0.080	0.10	0.12	0.16	0.19	500 (400 – 600)
		1,0	0,00080	0,0012	0,0016	0,0020	0,0024	0,0032	0,0040	0,0048	0,0065	0,0075	1650 (1400 – 1900)
TP1	A	1.0	0.020	0.030	0.040	0.050	0.060	0.080	0.10	0.12	0.16	0.19	270 (210 – 330)
		1,0	0,00080	0,0012	0,0016	0,0020	0,0024	0,0032	0,0040	0,0048	0,0065	0,0075	890 (690 – 1000)

For cutting data recalculations, see pages 556 - 563

SMG = Seco material group
Coolant = A=air D=dry E=emulsion M=mist spray
v_c = m/min (sf/min)
f_z = mm (in/tooth)
a_p = mm/DC (in/DC) = factor
a_e = mm/DC (in/DC) = factor
All cutting data are target values

JS452

High performance – Aluminium – Square – 2 Flutes – Cylindrical – Corner radius or chamfer

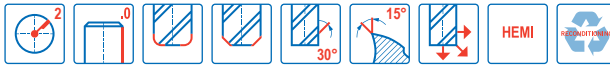
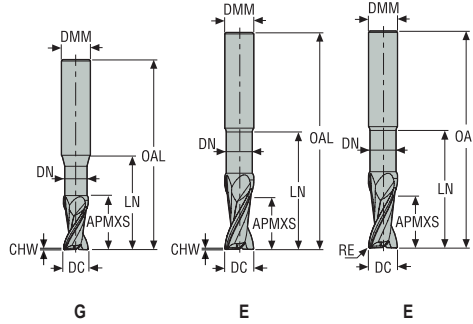

- Tolerances:
- DMM= h5
- DC= e7
- RE= ±0,02
- CHW= +0,04 mm
- Regrind possible if DC is ≥Ø6

Designation	Item number	Length index	Tool shape	DC	DMM	APMXS	OAL	LN	DN	CHW	RE	PCEDC	Cylindrical
				mm	mm	mm	mm	mm	mm	mm	mm		
JS452020G2CZ2.0-HEMI	02881848	2	G	2,0	6,0	4,0	57,0	8,0	1,9	0,1	-	2	■
JS452030G2CZ2.0-HEMI	02881849	2	G	3,0	6,0	6,0	57,0	10,0	2,8	0,1	-	2	■
JS452040G2CZ2.0-HEMI	02881850	2	G	4,0	6,0	8,0	57,0	14,0	3,8	0,1	-	2	■
JS452050G2CZ2.0-HEMI	02881851	2	G	5,0	6,0	8,0	57,0	17,0	4,7	0,1	-	2	■
JS452060E2CZ2.0-HEMI	02881852	2	E	6,0	6,0	12,0	57,0	19,0	5,7	0,1	-	2	■
JS452060E2R050Z2.0-HEMI	02881853	2	E	6,0	6,0	12,0	57,0	19,0	5,7	-	0,5	2	■
JS452060E2R100Z2.0-HEMI	02881854	2	E	6,0	6,0	12,0	57,0	19,0	5,7	-	1,0	2	■
JS452080E2CZ2.0-HEMI	02881778	2	E	8,0	8,0	16,0	63,0	24,0	7,6	0,1	-	2	■
JS452080E2R050Z2.0-HEMI	02881855	2	E	8,0	8,0	16,0	63,0	24,0	7,6	-	0,5	2	■
JS452080E2R100Z2.0-HEMI	02881779	2	E	8,0	8,0	16,0	63,0	24,0	7,6	-	1,0	2	■
JS452100E2CZ2.0-HEMI	02881856	2	E	10,0	10,0	20,0	72,0	29,0	9,5	0,1	-	2	■
JS452100E2R050Z2.0-HEMI	02881857	2	E	10,0	10,0	20,0	72,0	29,0	9,5	-	0,5	2	■
JS452100E2R100Z2.0-HEMI	02881858	2	E	10,0	10,0	20,0	72,0	29,0	9,5	-	1,0	2	■
JS452120E2CZ2.0-HEMI	02881859	2	E	12,0	12,0	24,0	88,0	37,0	11,4	0,1	-	2	■
JS452120E2R050Z2.0-HEMI	02881860	2	E	12,0	12,0	24,0	88,0	37,0	11,4	-	0,5	2	■
JS452120E2R100Z2.0-HEMI	02881861	2	E	12,0	12,0	24,0	88,0	37,0	11,4	-	1,0	2	■
JS452120E2R200Z2.0-HEMI	02881780	2	E	12,0	12,0	24,0	88,0	37,0	11,4	-	2,0	2	■
JS452140E2CZ2.0-HEMI	02881862	2	E	14,0	14,0	28,0	88,0	41,0	13,3	0,1	-	2	■
JS452160E2CZ2.0-HEMI	02881863	2	E	16,0	16,0	32,0	100,0	48,0	15,2	0,1	-	2	■
JS452160E2R050Z2.0-HEMI	02881864	2	E	16,0	16,0	32,0	100,0	48,0	15,2	-	0,5	2	■
JS452160E2R100Z2.0-HEMI	02881782	2	E	16,0	16,0	32,0	100,0	48,0	15,2	-	1,0	2	■
JS452160E2R200Z2.0-HEMI	02881783	2	E	16,0	16,0	32,0	100,0	48,0	15,2	-	2,0	2	■
JS452200E2CZ2.0-HEMI	02881865	2	E	20,0	20,0	36,0	110,0	57,0	19,0	0,1	-	2	■
JS452200E2R050Z2.0-HEMI	02881866	2	E	20,0	20,0	36,0	110,0	57,0	19,0	-	0,5	2	■
JS452200E2R100Z2.0-HEMI	02881768	2	E	20,0	20,0	36,0	110,0	57,0	19,0	-	1,0	2	■

■ Stocked standard.

Universal

Steel and cast iron

Stainless steel and S-materials

Non ferrous

Hard

Plastic and CFRP

Graphite

X-Heads

Minimaster Plus

Minimaster

JS452

High performance – Aluminium – Square – 2 Flutes – Cylindrical – Corner radius

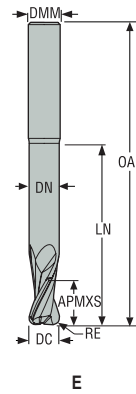

- Tolerances:
- DMM= h5
- DC= e7
- RE= ±0,02 mm
- Regrind possible

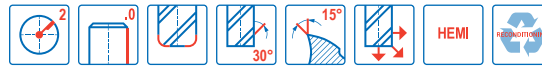

Designation	Item number	Length index	Tool shape	DC	DMM	APMXS	OAL	LN	DN	RE	PCEDC	Cylindrical
				mm	mm	mm	mm	mm	mm	mm		
JS452080E3R020.0Z2-HEMI	03003413	3	E	8,0	8,0	12,0	79,0	41,0	7,6	0,2	2	■
JS452100E3R050.0Z2-HEMI	03003415	3	E	10,0	10,0	15,0	99,0	57,0	9,5	0,5	2	■
JS452120E3R050.0Z2-HEMI	03003419	3	E	12,0	12,0	18,0	119,0	72,0	11,4	0,5	2	■
JS452160E3R050.0Z2-HEMI	03003426	3	E	16,0	16,0	24,0	129,0	79,0	15,2	0,5	2	■
JS452200E3R050.0Z2-HEMI	03003433	3	E	20,0	20,0	30,0	164,0	111,0	19,0	0,5	2	■

■ Stocked standard.

Universal

Steel and cast iron

Stainless steel and S-materials

Non ferrous

Hard

Plastic and cfrp

Graphite

X-Heads

Minimaster Plus

Minimaster

JS452

High performance – Aluminium – Square – 2 Flutes – Weldon – Corner radius or chamfer

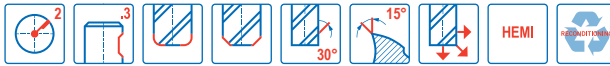
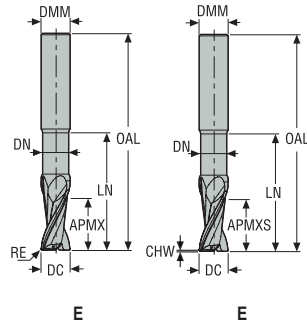

- Tolerances:
- DMM= h5
- DC= e7
- RE= ±0,02
- CHW= +0,04 mm
- Regrind possible

Designation	Item number	Length index	Tool shape	DC	DMM	APMXS	OAL	LN	DN	CHW	RE	PCEDC	Weldon
				mm	mm	mm	mm	mm	mm	mm	mm		
JS452060E2CZ2.3-HEMI	02881867	2	E	6,0	6,0	12,0	57,0	19,0	5,7	0,1	-	2	<input type="checkbox"/>
JS452060E2R050Z2.3-HEMI	02881868	2	E	6,0	6,0	12,0	57,0	19,0	5,7	-	0,5	2	<input type="checkbox"/>
JS452060E2R100Z2.3-HEMI	02881869	2	E	6,0	6,0	12,0	57,0	19,0	5,7	-	1,0	2	<input type="checkbox"/>
JS452080E2CZ2.3-HEMI	02881947	2	E	8,0	8,0	16,0	63,0	24,0	7,6	0,1	-	2	<input type="checkbox"/>
JS452080E2R050Z2.3-HEMI	02881870	2	E	8,0	8,0	16,0	63,0	24,0	7,6	-	0,5	2	<input type="checkbox"/>
JS452080E2R100Z2.3-HEMI	02922247	2	E	8,0	8,0	16,0	63,0	24,0	7,6	-	1,0	2	<input type="checkbox"/>
JS452100E2CZ2.3-HEMI	02881871	2	E	10,0	10,0	20,0	72,0	29,0	9,5	0,1	-	2	<input type="checkbox"/>
JS452100E2R050Z2.3-HEMI	02881872	2	E	10,0	10,0	20,0	72,0	29,0	9,5	-	0,5	2	<input type="checkbox"/>
JS452100E2R100Z2.3-HEMI	02881873	2	E	10,0	10,0	20,0	72,0	29,0	9,5	-	1,0	2	<input type="checkbox"/>
JS452120E2CZ2.3-HEMI	02881874	2	E	12,0	12,0	24,0	88,0	37,0	11,4	0,1	-	2	<input type="checkbox"/>
JS452120E2R050Z2.3-HEMI	02881875	2	E	12,0	12,0	24,0	88,0	37,0	11,4	-	0,5	2	<input type="checkbox"/>
JS452120E2R100Z2.3-HEMI	02881876	2	E	12,0	12,0	24,0	88,0	37,0	11,4	-	1,0	2	<input type="checkbox"/>
JS452120E2R200Z2.3-HEMI	02881948	2	E	12,0	12,0	24,0	88,0	37,0	11,4	-	2,0	2	<input type="checkbox"/>
JS452140E2CZ2.3-HEMI	02881877	2	E	14,0	14,0	28,0	88,0	41,0	13,3	0,1	-	2	<input type="checkbox"/>
JS452160E2CZ2.3-HEMI	02881878	2	E	16,0	16,0	32,0	100,0	48,0	15,2	0,1	-	2	<input type="checkbox"/>
JS452160E2R050Z2.3-HEMI	02881879	2	E	16,0	16,0	32,0	100,0	48,0	15,2	-	0,5	2	<input type="checkbox"/>
JS452160E2R100Z2.3-HEMI	02881949	2	E	16,0	16,0	32,0	100,0	48,0	15,2	-	1,0	2	<input type="checkbox"/>
JS452160E2R200Z2.3-HEMI	02881950	2	E	16,0	16,0	32,0	100,0	48,0	15,2	-	2,0	2	<input type="checkbox"/>
JS452200E2CZ2.3-HEMI	02881880	2	E	20,0	20,0	36,0	110,0	57,0	19,0	0,1	-	2	<input type="checkbox"/>
JS452200E2R050Z2.3-HEMI	02881881	2	E	20,0	20,0	36,0	110,0	57,0	19,0	-	0,5	2	<input type="checkbox"/>
JS452200E2R100Z2.3-HEMI	02881953	2	E	20,0	20,0	36,0	110,0	57,0	19,0	-	1,0	2	<input type="checkbox"/>

Weldon available. Delivery time is 3 days.

Universal

Steel and cast iron

Stainless steel and S-materials

Non ferrous

Hard

Plastic and CFRP

Graphite

X-Heads

Minimaster Plus

Minimaster

JS452

High performance – Aluminium – Square – 2 Flutes – Weldon – Corner radius

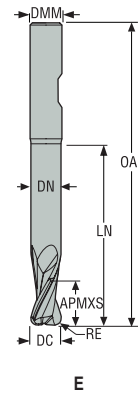

- Tolerances:
- DMM= h5
- DC= e7
- RE= ±0,02
- Regrind possible

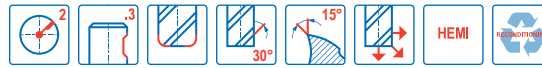

Designation	Item number	Length index	Tool shape	DC	DMM	APMXS	OAL	LN	DN	RE	PCEDC	Weldon
				mm	mm	mm	mm	mm	mm	mm		
JS452080E3R020.3Z2-HEMI	03003447	3	E	8,0	8,0	12,0	79,0	41,0	7,6	0,2	2	<input type="checkbox"/>
JS452100E3R050.3Z2-HEMI	03003449	3	E	10,0	10,0	15,0	99,0	57,0	9,5	0,5	2	<input type="checkbox"/>
JS452120E3R050.3Z2-HEMI	03003453	3	E	12,0	12,0	18,0	119,0	72,0	11,4	0,5	2	<input type="checkbox"/>
JS452160E3R050.3Z2-HEMI	03003460	3	E	16,0	16,0	24,0	129,0	79,0	15,2	0,5	2	<input type="checkbox"/>
JS452200E3R050.3Z2-HEMI	03003467	3	E	20,0	20,0	30,0	164,0	111,0	19,0	0,5	2	<input type="checkbox"/>

Weldon available. Delivery time is 3 days.

Universal
Steel and cast iron
Stainless steel and S-materials
Non ferrous
Hard
Plastic and CFRP
Graphite
X-Heads
Minimaster Plus
Minimaster

Cutting data – JS452 Side milling roughing

SMG		a _e /DC	a _p /DC	f _z											v _c
				2	3	4	5	6	8	10	12	14	16	20	
N1	E/M/A	0.400	1.5	0.030	0.046	0.060	0.075	0.090	0.12	0.15	0.18	0.20	0.22	0.25	560 (450 – 670)
		0.400	1.5	0.0012	0.0018	0.0024	0.0030	0.0036	0.0048	0.0060	0.0070	0.0080	0.0085	0.010	1825 (1500 – 2100)
N2	E/M/A	0.300	1.5	0.024	0.036	0.048	0.060	0.070	0.095	0.12	0.14	0.16	0.18	0.20	485 (370 – 600)
		0.300	1.5	0.00095	0.0014	0.0019	0.0024	0.0028	0.0038	0.0048	0.0055	0.0065	0.0070	0.0080	1600 (1300 – 1900)
N3	E/M/A	0.300	1.5	0.024	0.036	0.048	0.060	0.070	0.095	0.12	0.14	0.16	0.18	0.20	325 (250 – 400)
		0.300	1.5	0.00095	0.0014	0.0019	0.0024	0.0028	0.0038	0.0048	0.0055	0.0065	0.0070	0.0080	1075 (830 – 1300)
TS1	A/D	0.400	1.5	0.030	0.046	0.060	0.075	0.090	0.12	0.15	0.18	0.20	0.22	0.25	560 (450 – 670)
		0.400	1.5	0.0012	0.0018	0.0024	0.0030	0.0036	0.0048	0.0060	0.0070	0.0080	0.0085	0.010	1825 (1500 – 2100)
TP1	A/D	0.400	1.5	0.030	0.046	0.060	0.075	0.090	0.12	0.15	0.18	0.20	0.22	0.25	450 (340 – 560)
		0.400	1.5	0.0012	0.0018	0.0024	0.0030	0.0036	0.0048	0.0060	0.0070	0.0080	0.0085	0.010	1475 (1200 – 1800)

Cutting data – JS452 Slot milling

SMG		a _p /DC	f _z											v _c
			2	3	4	5	6	8	10	12	14	16	20	
N1	E	1.5	0.020	0.030	0.040	0.050	0.060	0.080	0.10	0.12	0.14	0.16	0.20	500 (410 – 590)
		1.5	0.00080	0.0012	0.0016	0.0020	0.0024	0.0032	0.0040	0.0048	0.0055	0.0065	0.0080	1650 (1400 – 1900)
N2	E	1.2	0.016	0.024	0.032	0.040	0.048	0.065	0.080	0.095	0.11	0.13	0.16	400 (310 – 500)
		1.2	0.00065	0.00095	0.0013	0.0016	0.0019	0.0026	0.0032	0.0038	0.0044	0.0050	0.0065	1300 (1100 – 1600)
N3	E	1.2	0.016	0.024	0.032	0.040	0.048	0.065	0.080	0.095	0.11	0.13	0.16	265 (210 – 330)
		1.2	0.00065	0.00095	0.0013	0.0016	0.0019	0.0026	0.0032	0.0038	0.0044	0.0050	0.0065	870 (690 – 1000)
TS1	A	1.5	0.020	0.030	0.040	0.050	0.060	0.080	0.10	0.12	0.14	0.16	0.20	500 (410 – 590)
		1.5	0.00080	0.0012	0.0016	0.0020	0.0024	0.0032	0.0040	0.0048	0.0055	0.0065	0.0080	1650 (1400 – 1900)
TP1	A	1.5	0.020	0.030	0.040	0.050	0.060	0.080	0.10	0.12	0.14	0.16	0.20	400 (310 – 500)
		1.5	0.00080	0.0012	0.0016	0.0020	0.0024	0.0032	0.0040	0.0048	0.0055	0.0065	0.0080	1300 (1100 – 1600)

Remark: if cornerradius is >15% of DC then a_p= -30%, f_z= -20%
For cutting data recalculations, see pages 556 - 563

SMG = Seco material group
Coolant = A=air D=dry E=emulsion M=mist spray
v_c= m/min (sf/min)
f_z = mm (in/tooth)
a_p = mm/DC (in/DC) = factor
a_e = mm/DC (in/DC) = factor
All cutting data are target values

Universal
Steel and cast iron
Stainless steel and S-materials
Non ferrous
Hard
Plastic and CFRP
Graphite
X-Heads
Minimaster Plus
Minimaster

JS453

High performance – Aluminium – Square – 3 Flutes – Cylindrical – Corner radius or chamfer

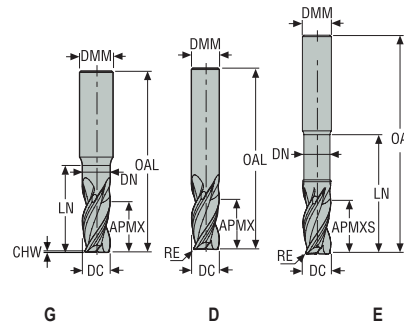

- Tolerances:
- DMM=h5
- DC=e7
- RE= ±0,02 mm
- CHW= +0,04 mm
- Regrind possible if DC is ≥Ø6

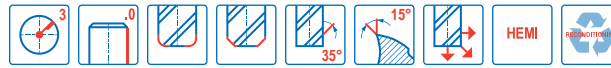

Designation	Item number	Length index	Tool shape	DC	DMM	APMXS	OAL	LN	DN	CHW	RE	PCEDC	Cylindrical
				mm	mm	mm	mm	mm	mm	mm	mm		
JS453020G2CZ3.0-HEMI	02881896	2	G	2,0	6,0	4,0	57,0	7,0	1,9	0,1	–	3	■
JS453030G2CZ3.0-HEMI	02881897	2	G	3,0	6,0	6,0	57,0	10,0	2,85	0,1	–	3	■
JS453040G2CZ3.0-HEMI	02881898	2	G	4,0	6,0	8,0	57,0	13,0	3,8	0,1	–	3	■
JS453050G2CZ3.0-HEMI	02881899	2	G	5,0	6,0	10,0	57,0	14,0	4,75	0,1	–	3	■
JS453060D2CZ3.0-HEMI	02881900	2	D	6,0	6,0	12,0	57,0	–	–	0,1	–	3	■
JS453060D2R050Z3.0-HEMI	02881901	2	D	6,0	6,0	12,0	57,0	–	–	–	0,5	3	■
JS453080D2CZ3.0-HEMI	02881812	2	D	8,0	8,0	16,0	63,0	–	–	0,1	–	3	■
JS453080D2R050Z3.0-HEMI	02881902	2	D	8,0	8,0	16,0	63,0	–	–	–	0,5	3	■
JS453100D2CZ3.0-HEMI	02881903	2	D	10,0	10,0	20,0	72,0	–	–	0,1	–	3	■
JS453100D2R050Z3.0-HEMI	02881904	2	D	10,0	10,0	20,0	72,0	–	–	–	0,5	3	■
JS453120D2CZ3.0-HEMI	02881905	2	D	12,0	12,0	24,0	88,0	–	–	0,1	–	3	■
JS453120D2R050Z3.0-HEMI	02881906	2	D	12,0	12,0	24,0	88,0	–	–	–	0,5	3	■
JS453120E2R300.0Z3-HEMI	02905280	2	E	12,0	12,0	24,0	88,0	37,0	11,4	–	3,0	3	■
JS453140D2CZ3.0-HEMI	02881907	2	D	14,0	14,0	28,0	88,0	–	–	0,1	–	3	■
JS453160D2CZ3.0-HEMI	02881908	2	D	16,0	16,0	32,0	100,0	–	–	0,1	–	3	■
JS453160D2R050Z3.0-HEMI	02881909	2	D	16,0	16,0	32,0	100,0	–	–	–	0,5	3	■
JS453160E2R100.0Z3-HEMI	02905281	2	E	16,0	16,0	32,0	100,0	48,0	15,2	–	1,0	3	■
JS453160E2R200.0Z3-HEMI	02905282	2	E	16,0	16,0	32,0	100,0	48,0	15,2	–	2,0	3	■
JS453160E2R250.0Z3-HEMI	02905283	2	E	16,0	16,0	32,0	100,0	48,0	15,2	–	2,5	3	■
JS453160E2R300.0Z3-HEMI	02905284	2	E	16,0	16,0	32,0	100,0	48,0	15,2	–	3,0	3	■
JS453160E2R400.0Z3-HEMI	02905285	2	E	16,0	16,0	32,0	100,0	48,0	15,2	–	4,0	3	■
JS453200E2C.0Z3-HEMI	02905286	2	E	20,0	20,0	36,0	110,0	57,0	19,0	0,1	–	3	■
JS453200E2R050.0Z3-HEMI	02905287	2	E	20,0	20,0	36,0	110,0	57,0	19,0	–	0,5	3	■
JS453200E2R100.0Z3-HEMI	02905288	2	E	20,0	20,0	36,0	110,0	57,0	19,0	–	1,0	3	■
JS453200E2R200.0Z3-HEMI	02905289	2	E	20,0	20,0	36,0	110,0	57,0	19,0	–	2,0	3	■
JS453200E2R300.0Z3-HEMI	02905291	2	E	20,0	20,0	36,0	110,0	57,0	19,0	–	3,0	3	■

■ Stocked standard.

Universal

Steel and cast iron

Stainless steel and S-materials

Non ferrous

Hard

Plastic and CFRP

Graphite

X-Heads

Minimaster Plus

Minimaster

JS453

High performance – Aluminium – Square – 3 Flutes – Cylindrical – Corner radius or chamfer

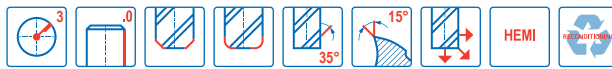
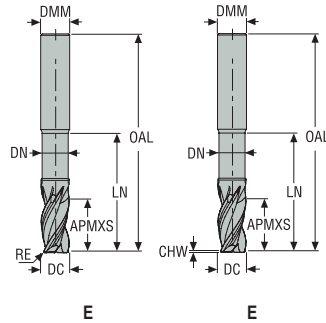

- Tolerances:
- DMM= h5
- DC = e7
- RE= ±0,02 mm
- CHW= +0,04 mm
- Regrind possible

Designation	Item number	Length index	Tool shape	DC	DMM	APMXS	OAL	LN	DN	CHW	RE	PCEDC	Cylindrical
				mm	mm	mm	mm	mm	mm	mm	mm		
JS453120E3R300.0Z3-HEMI	02905294	3	E	12,0	12,0	24,0	110,0	54,0	11,4	–	3,0	3	■
JS453160E3R100.0Z3-HEMI	02905295	3	E	16,0	16,0	32,0	125,0	77,0	15,2	–	1,0	3	■
JS453160E3R200.0Z3-HEMI	02905296	3	E	16,0	16,0	32,0	125,0	77,0	15,2	–	2,0	3	■
JS453160E3R300.0Z3-HEMI	02905298	3	E	16,0	16,0	32,0	125,0	77,0	15,2	–	3,0	3	■
JS453160E3R400.0Z3-HEMI	02905299	3	E	16,0	16,0	32,0	125,0	77,0	15,2	–	4,0	3	■
JS453200E3C.0Z3-HEMI	02905300	3	E	20,0	20,0	36,0	150,0	90,0	19,0	0,1	–	3	■
JS453200E3R050.0Z3-HEMI	02905301	3	E	20,0	20,0	36,0	150,0	90,0	19,0	–	0,5	3	■
JS453200E3R100.0Z3-HEMI	02905302	3	E	20,0	20,0	36,0	150,0	90,0	19,0	–	1,0	3	■
JS453200E3R200.0Z3-HEMI	02905303	3	E	20,0	20,0	36,0	150,0	90,0	19,0	–	2,0	3	■
JS453200E3R300.0Z3-HEMI	02905305	3	E	20,0	20,0	36,0	150,0	90,0	19,0	–	3,0	3	■

■ Stocked standard.

Universal

Steel and cast iron

Stainless steel and S-materials

Non ferrous

Hard

Plastic and cfrp

Graphite

X-Heads

Minimaster Plus

Minimaster

JS453

High performance – Aluminium – Square – 3 Flutes – Weldon – Corner radius or chamfer

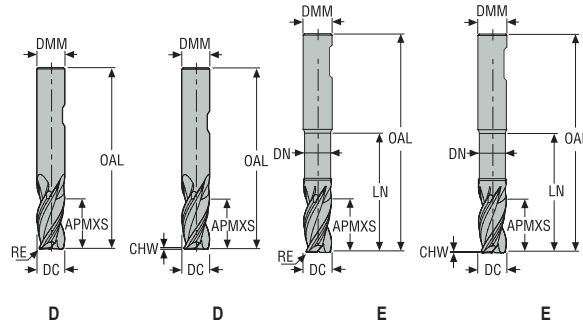

- Tolerances:
- DMM=h5
- DC=e7
- RE=±0,02 mm
- CHW= ±0,02 mm
- Regrind possible

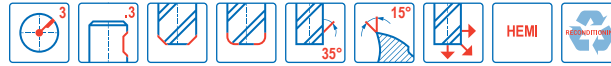

Designation	Item number	Length index	Tool shape	DC	DMM	APMXS	OAL	LN	DN	CHW	RE	PCEDC	Weldon
				mm	mm	mm	mm	mm	mm	mm	mm		
JS453060D2CZ3.3-HEMI	02881910	2	D	6,0	6,0	12,0	57,0	-	-	0,1	-	3	<input type="checkbox"/>
JS453060D2R050Z3.3-HEMI	02881911	2	D	6,0	6,0	12,0	57,0	-	-	-	0,5	3	<input type="checkbox"/>
JS453080D2CZ3.3-HEMI	02881964	2	D	8,0	8,0	16,0	63,0	-	-	0,1	-	3	<input type="checkbox"/>
JS453080D2R050Z3.3-HEMI	02881954	2	D	8,0	8,0	16,0	63,0	-	-	-	0,5	3	<input type="checkbox"/>
JS453100D2CZ3.3-HEMI	02881913	2	D	10,0	10,0	20,0	72,0	-	-	0,1	-	3	<input type="checkbox"/>
JS453100D2R050Z3.3-HEMI	02881914	2	D	10,0	10,0	20,0	72,0	-	-	-	0,5	3	<input type="checkbox"/>
JS453120D2CZ3.3-HEMI	02881915	2	D	12,0	12,0	24,0	88,0	-	-	0,1	-	3	<input type="checkbox"/>
JS453120D2R050Z3.3-HEMI	02881916	2	D	12,0	12,0	24,0	88,0	-	-	-	0,5	3	<input type="checkbox"/>
JS453120E2R300.3Z3-HEMI	02905308	2	E	12,0	12,0	24,0	88,0	37,0	11,4	-	3,0	3	<input type="checkbox"/>
JS453140D2CZ3.3-HEMI	02881917	2	D	14,0	14,0	28,0	88,0	-	-	0,1	-	3	<input type="checkbox"/>
JS453160D2CZ3.3-HEMI	02881918	2	D	16,0	16,0	32,0	100,0	-	-	0,1	-	3	<input type="checkbox"/>
JS453160D2R050Z3.3-HEMI	02881919	2	D	16,0	16,0	32,0	100,0	-	-	-	0,5	3	<input type="checkbox"/>
JS453160E2R100.3Z3-HEMI	02905309	2	E	16,0	16,0	32,0	100,0	48,0	15,2	-	1,0	3	<input type="checkbox"/>
JS453160E2R200.3Z3-HEMI	02905310	2	E	16,0	16,0	32,0	100,0	48,0	15,2	-	2,0	3	<input type="checkbox"/>
JS453160E2R250.3Z3-HEMI	02905311	2	E	16,0	16,0	32,0	100,0	48,0	15,2	-	2,5	3	<input type="checkbox"/>
JS453160E2R300.3Z3-HEMI	02905312	2	E	16,0	16,0	32,0	100,0	48,0	15,2	-	3,0	3	<input type="checkbox"/>
JS453160E2R400.3Z3-HEMI	02905313	2	E	16,0	16,0	32,0	100,0	48,0	15,2	-	4,0	3	<input type="checkbox"/>
JS453200E2C.3Z3-HEMI	02905314	2	E	20,0	20,0	36,0	110,0	57,0	19,0	0,1	-	3	<input type="checkbox"/>
JS453200E2R050.3Z3-HEMI	02905315	2	E	20,0	20,0	36,0	110,0	57,0	19,0	-	0,5	3	<input type="checkbox"/>
JS453200E2R100.3Z3-HEMI	02905316	2	E	20,0	20,0	36,0	110,0	57,0	19,0	-	1,0	3	<input type="checkbox"/>
JS453200E2R200.3Z3-HEMI	02905317	2	E	20,0	20,0	36,0	110,0	57,0	19,0	-	2,0	3	<input type="checkbox"/>
JS453200E2R300.3Z3-HEMI	02905319	2	E	20,0	20,0	36,0	110,0	57,0	19,0	-	3,0	3	<input type="checkbox"/>

Weldon available. Delivery time is 3 days.

Universal

Steel and cast iron

Stainless steel and S-materials

Non ferrous

Hard

Plastic and CFRP

Graphite

X-Heads

Minimaster Plus

Minimaster

JS453

High performance – Aluminium – Square – 3 Flutes – Weldon – Corner radius or chamfer

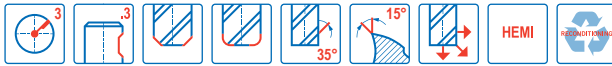
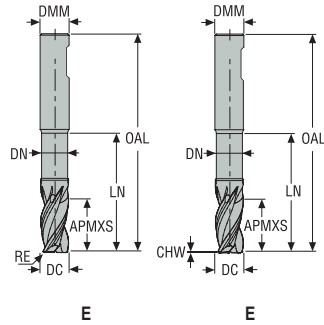

- Tolerances:
- DMM= h5
- DC = e7
- RE= ±0,02 mm
- CHW= +0,04 mm
- Regrind possible

Designation	Item number	Length index	Tool shape	DC	DMM	APMXS	OAL	LN	DN	CHW	RE	PCEDC	Weldon
				mm	mm	mm	mm	mm	mm	mm	mm		
JS453120E3R300.3Z3-HEMI	02905322	3	E	12,0	12,0	24,0	110,0	54,0	11,4	–	3,0	3	<input type="checkbox"/>
JS453160E3R100.3Z3-HEMI	02905323	3	E	16,0	16,0	32,0	125,0	77,0	15,2	–	1,0	3	<input type="checkbox"/>
JS453160E3R200.3Z3-HEMI	02905324	3	E	16,0	16,0	32,0	125,0	77,0	15,2	–	2,0	3	<input type="checkbox"/>
JS453160E3R300.3Z3-HEMI	02905326	3	E	16,0	16,0	32,0	125,0	77,0	15,2	–	3,0	3	<input type="checkbox"/>
JS453160E3R400.3Z3-HEMI	02905327	3	E	16,0	16,0	32,0	125,0	77,0	15,2	–	4,0	3	<input type="checkbox"/>
JS453200E3C.3Z3-HEMI	02905328	3	E	20,0	20,0	36,0	150,0	90,0	19,0	0,1	–	3	<input type="checkbox"/>
JS453200E3R050.3Z3-HEMI	02905329	3	E	20,0	20,0	36,0	150,0	90,0	19,0	–	0,5	3	<input type="checkbox"/>
JS453200E3R100.3Z3-HEMI	02905330	3	E	20,0	20,0	36,0	150,0	90,0	19,0	–	1,0	3	<input type="checkbox"/>
JS453200E3R200.3Z3-HEMI	02905331	3	E	20,0	20,0	36,0	150,0	90,0	19,0	–	2,0	3	<input type="checkbox"/>
JS453200E3R300.3Z3-HEMI	02905333	3	E	20,0	20,0	36,0	150,0	90,0	19,0	–	3,0	3	<input type="checkbox"/>

Weldon available. Delivery time is 3 days.

Universal

Steel and cast iron

Stainless steel and S-materials

Non ferrous

Hard

Plastic and cfrp

Graphite

X-Heads

Minimaster Plus

Minimaster

Cutting data – JS453 Side milling

SMG		a _e /DC	a _p /DC	f _z											v _c
				2	3	4	5	6	8	10	12	14	16	20	
N1	E/M/A	0.400	1.5	0.030	0.046	0.060	0.075	0.090	0.12	0.15	0.18	0.20	0.22	0.25	560 (450 – 660)
		0,400	1,5	0,0012	0,0018	0,0024	0,0030	0,0036	0,0048	0,0060	0,0070	0,0080	0,0085	0,010	1825 (1500 – 2100)
N2	E/M/A	0.300	1.5	0.024	0.036	0.048	0.060	0.070	0.095	0.12	0.14	0.16	0.18	0.20	480 (370 – 600)
		0,300	1,5	0,00095	0,0014	0,0019	0,0024	0,0028	0,0038	0,0048	0,0055	0,0065	0,0070	0,0080	1575 (1300 – 1900)
N3	E/M/A	0.300	1.5	0.024	0.036	0.048	0.060	0.070	0.095	0.12	0.14	0.16	0.18	0.20	320 (250 – 400)
		0,300	1,5	0,00095	0,0014	0,0019	0,0024	0,0028	0,0038	0,0048	0,0055	0,0065	0,0070	0,0080	1050 (830 – 1300)
TS1	A/D	0.400	1.5	0.030	0.046	0.060	0.075	0.090	0.12	0.15	0.18	0.20	0.22	0.25	560 (450 – 660)
		0,400	1,5	0,0012	0,0018	0,0024	0,0030	0,0036	0,0048	0,0060	0,0070	0,0080	0,0085	0,010	1825 (1500 – 2100)
TP1	A/D	0.400	1.5	0.030	0.046	0.060	0.075	0.090	0.12	0.15	0.18	0.20	0.22	0.25	445 (340 – 550)
		0,400	1,5	0,0012	0,0018	0,0024	0,0030	0,0036	0,0048	0,0060	0,0070	0,0080	0,0085	0,010	1450 (1200 – 1800)

Cutting data – JS453 Slot milling

SMG		a _p /DC	f _z											v _c
			2	3	4	5	6	8	10	12	14	16	20	
N1	E	1.5	0.020	0.030	0.040	0.050	0.060	0.080	0.10	0.12	0.14	0.16	0.20	500 (410 – 590)
		1,5	0,00080	0,0012	0,0016	0,0020	0,0024	0,0032	0,0040	0,0048	0,0055	0,0065	0,0080	1650 (1400 – 1900)
N2	E	1.2	0.016	0.024	0.032	0.040	0.048	0.065	0.080	0.095	0.11	0.13	0.16	400 (300 – 490)
		1,2	0,00065	0,00095	0,0013	0,0016	0,0019	0,0026	0,0032	0,0038	0,0044	0,0050	0,0065	1300 (990 – 1600)
N3	E	1.2	0.016	0.024	0.032	0.040	0.048	0.065	0.080	0.095	0.11	0.13	0.16	265 (200 – 330)
		1,2	0,00065	0,00095	0,0013	0,0016	0,0019	0,0026	0,0032	0,0038	0,0044	0,0050	0,0065	870 (660 – 1000)
TS1	A	1.5	0.020	0.030	0.040	0.050	0.060	0.080	0.10	0.12	0.14	0.16	0.20	500 (410 – 590)
		1,5	0,00080	0,0012	0,0016	0,0020	0,0024	0,0032	0,0040	0,0048	0,0055	0,0065	0,0080	1650 (1400 – 1900)
TP1	A	1.5	0.020	0.030	0.040	0.050	0.060	0.080	0.10	0.12	0.14	0.16	0.20	400 (300 – 500)
		1,5	0,00080	0,0012	0,0016	0,0020	0,0024	0,0032	0,0040	0,0048	0,0055	0,0065	0,0080	1300 (990 – 1600)

For cutting data recalculations, see pages 556 - 563

SMG = Seco material group
Coolant = A=air D=dry E=emulsion M=mist spray
v_c = m/min (sf/min)
f_z = mm (in/tooth)
a_p = mm/DC (in/DC) = factor
a_e = mm/DC (in/DC) = factor
All cutting data are target values

JHP490

High performance – Aluminium – Square – 2-3 Flutes – Cylindrical – Corner radius – ICC

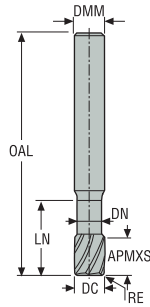

E

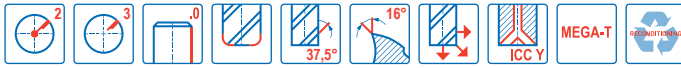

- Tolerances:
- DMM=h5
- DC=-0,02/-0,1 mm
- RE= ±0,05 mm
- Re grind possible

Designation	Item number	Length index	Tool shape	ICC	DC	DMM	APMXS	OAL	LN	DN	RE	PCEDC	Cylindrical
					mm	mm	mm	mm	mm	mm	mm		
490V100R050Z2.0A-MEGA-T	02623870	2	E	■	10,0	10,0	12,0	65,0	20,0	9,0	0,5	2	■
490V120R200Z2.0A-MEGA-T	02623883	2	E	■	12,0	12,0	14,0	75,0	24,0	11,0	2,0	2	■
490V160R050Z3.0A-MEGA-T	02623889	2	E	■	16,0	16,0	18,0	85,0	32,0	14,5	0,5	3	■
490V200R050Z3.0A-MEGA-T	02623908	2	E	■	20,0	20,0	22,0	100,0	40,0	18,0	0,5	3	■
490V250R050Z3.0A-MEGA-T	02623926	2	E	■	25,0	25,0	27,0	125,0	50,0	23,0	0,5	3	■
490VL100R100Z2.0A-MEGA-T	02623876	3	E	■	10,0	10,0	22,0	85,0	42,0	9,0	1,0	2	■
490VL120R050Z3.0A-MEGA-T	02623880	3	E	■	12,0	12,0	14,0	95,0	40,0	11,0	0,5	3	■
490VL120R100Z2.0A-MEGA-T	02623886	3	E	■	12,0	12,0	26,0	95,0	50,0	11,0	1,0	2	■
490VL160R050Z3.0A-MEGA-T	02623891	3	E	■	16,0	16,0	18,0	95,0	45,0	14,5	0,5	3	■
490VL200R200Z3.0A-MEGA-T	02623916	3	E	■	20,0	20,0	42,0	125,0	65,0	18,0	2,0	3	■
490VXL250R050Z3.0A-MEGA-T	02623927	4	E	■	25,0	25,0	50,0	125,0	75,0	23,0	0,5	3	■

■ Stocked standard.

Universal

Steel and cast iron

Stainless steel and S-materials

Non ferrous

Hard

Plastic and CFRP

Graphite

X-Heads

Minimaster Plus

Minimaster

JHP490

High performance – Aluminium – Square – 2-3 Flutes – Weldon – Corner radius – ICC

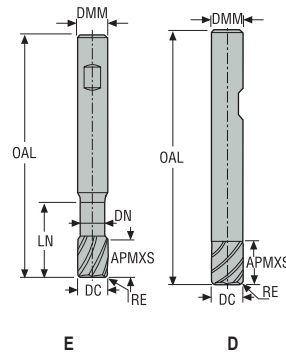

- Tolerances:
- DMM=h5
- DC=-0,02/-0,1 mm
- RE= ±0,05 mm
- Regrind possible

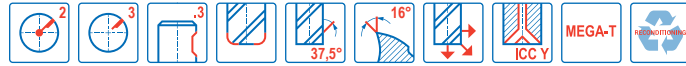

Designation	Item number	Length index	Tool shape	ICC	DC	DMM	APMXS	OAL	LN	DN	RE	PCEDC	Weldon
					mm	mm	mm	mm	mm	mm	mm		
490V120R200Z2.0A-MEGA-TW	02669371	2	E	■	12,0	12,0	14,0	75,0	24,0	11,0	2,0	2	□
490V160R050Z3A-MEGA-T	02623888	2	E	■	16,0	16,0	18,0	85,0	32,0	14,5	0,5	3	■
490160R200Z3A-MEGA-T	02623898	2	D	■	16,0	16,0	34,0	95,0	-	-	2,0	3	■
490V200R050Z3A-MEGA-T	02623907	2	E	■	20,0	20,0	22,0	100,0	40,0	18,0	0,5	3	■
490V250R050Z3A-MEGA-T	02623925	2	E	■	25,0	25,0	27,0	125,0	50,0	23,0	0,5	3	■
490VL100R100Z2.0A-MEGA-TW	02669368	3	E	■	10,0	10,0	22,0	85,0	42,0	9,0	1,0	2	□
490VL120R050Z3.0A-MEGA-TW	02669374	3	E	■	12,0	12,0	14,0	95,0	40,0	11,0	0,5	3	□
490VL120R100Z2.0A-MEGA-TW	02669375	3	E	■	12,0	12,0	26,0	95,0	50,0	11,0	1,0	2	□
490VL160R050Z3.0A-MEGA-TW	02669382	3	E	■	16,0	16,0	18,0	95,0	45,0	14,5	0,5	3	□
490VL200R200Z3.0A-MEGA-TW	02669388	3	E	■	20,0	20,0	42,0	125,0	65,0	18,0	2,0	3	□
490VXL250R050Z3.0A-MEGA-TW	02669397	4	E	■	25,0	25,0	50,0	125,0	75,0	23,0	0,5	3	□

■ Stocked standard. □ Weldon available. Delivery time is 3 days.

Universal
Steel and cast iron
Stainless steel and S-materials
Non ferrous
Hard
Plastic and CFRP
Graphite
X-Heads
Minimaster Plus
Minimaster

JHP490

High performance – Aluminium – Square – 2-3 Flutes – Safelock – Corner radius – ICC

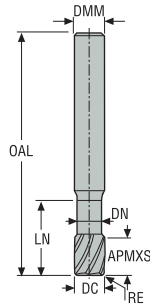

E

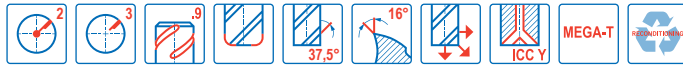

- Tolerances:
- DMM=h5
- DC=-0,02/-0,1 mm
- RE= ±0,05 mm
- Re grind possible

Designation	Item number	Length index	Tool shape	ICC	DC	DMM	APMXS	OAL	LN	DN	RE	PCEDC	Safelock
					mm	mm	mm	mm	mm	mm	mm		
490V100R050Z2.9A-MEGA-T	02927984	2	E	■	10,0	10,0	12,0	65,0	20,0	9,0	0,5	2	<input type="checkbox"/>
490V120R200Z2.9A-MEGA-T	02927988	2	E	■	12,0	12,0	14,0	75,0	24,0	11,0	2,0	2	<input type="checkbox"/>
490V160R050Z3.9A-MEGA-T	02927990	2	E	■	16,0	16,0	18,0	85,0	32,0	14,0	0,5	3	<input type="checkbox"/>
490V200R050Z3.9A-MEGA-T	02927992	2	E	■	20,0	20,0	22,0	100,0	40,0	18,0	0,5	3	<input type="checkbox"/>
490V250R050Z3.9A-MEGA-T	02927993	2	E	■	25,0	25,0	27,0	125,0	50,0	23,0	0,5	3	<input type="checkbox"/>
490VL100R100Z2.9A-MEGA-T	02927994	3	E	■	10,0	10,0	22,0	85,0	42,0	9,0	1,0	2	<input type="checkbox"/>
490VL120R050Z3.9A-MEGA-T	02927995	3	E	■	12,0	12,0	14,0	95,0	40,0	11,0	0,5	3	<input type="checkbox"/>
490VL120R100Z2.9A-MEGA-T	02927996	3	E	■	12,0	12,0	26,0	95,0	50,0	11,0	1,0	2	<input type="checkbox"/>
490VL160R050Z3.9A-MEGA-T	02927997	3	E	■	16,0	16,0	18,0	95,0	32,0	14,0	0,5	3	<input type="checkbox"/>
490VL200R200Z3.9A-MEGA-T	02927998	3	E	■	20,0	20,0	42,0	125,0	65,0	18,0	2,0	3	<input type="checkbox"/>
490VXL250R050Z3.9A-MEGA-T	02927999	4	E	■	25,0	25,0	50,0	125,0	75,0	23,0	0,5	3	<input type="checkbox"/>

Safelock available. Subject to change, refer to current Price and Stock List.

Universal

Steel and cast iron

Stainless steel and S-materials

Non ferrous

Hard

Plastic and CFRP

Graphite

X-Heads

Minimaster Plus

Minimaster

Cutting data – JHP490 Side milling roughing

SMG		a _p /DC	a _p /DC	f _z					v _c
				10	12	16	20	25	
N1	E/M/A	0.500	1.1	0.20	0.24	0.30	0.34	0.38	700 (550 – 860)
		0,500	1,0	0,0080	0,0095	0,012	0,013	0,015	2325 (1900 – 2800)
N2	E/M/A	0.500	1.1	0.20	0.24	0.30	0.34	0.38	455 (350 – 550)
		0,500	1,0	0,0080	0,0095	0,012	0,013	0,015	1500 (1200 – 1800)
N3	E/M/A	0.500	1.1	0.20	0.24	0.30	0.34	0.38	540 (440 – 650)
		0,500	1,0	0,0080	0,0095	0,012	0,013	0,015	1775 (1500 – 2100)

Cutting data – JHP490 Slot milling

SMG		a _p /DC	a _p /DC	f _z					v _c
				10	12	16	20	25	
N1	E/M/A	1.0	0.15	0.18	0.24	0.30	0.38	650 (500 – 790)	
		1,0	0,0060	0,0070	0,0095	0,012	0,015	2125 (1700 – 2500)	
N2	E/M/A	1.0	0.15	0.18	0.24	0.30	0.38	420 (330 – 510)	
		1,0	0,0060	0,0070	0,0095	0,012	0,015	1375 (1100 – 1600)	
N3	E/M/A	1.0	0.15	0.18	0.24	0.30	0.38	500 (400 – 590)	
		1,0	0,0060	0,0070	0,0095	0,012	0,015	1650 (1400 – 1900)	

Universal

Steel and cast iron

Stainless steel and S-materials

Non ferrous

Hard

Plastic and cfrp

Graphite

X-Heads

Minimaster Plus

Minimaster

JH40

High performance – Aluminium – Square – 2 Flutes – Cylindrical – Corner radius

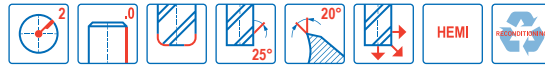
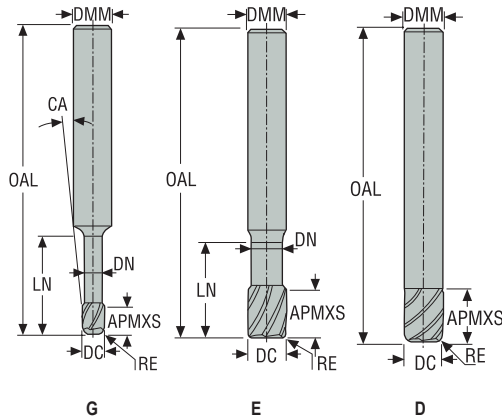

- Tolerances:
- DMM=h5
- DC=-0,02/-0,04 mm
- RE= ±0,1 mm
- Regrind possible if DC is ≥Ø6

Designation	Item number	Length index	Tool shape	DC	DMM	APMXS	OAL	LN	DN	RE	CA°	PCEDC	Cylindrical
				mm	mm	mm	mm	mm	mm	mm			
40K060-HEMI	00022089	1	D	6,0	6,0	13,0	50,0	-	-	0,1	-	2	■
40K080-HEMI	00022090	1	D	8,0	8,0	13,0	50,0	-	-	0,1	-	2	■
40K100-HEMI	00022091	1	D	10,0	10,0	16,0	50,0	-	-	0,1	-	2	■
40K120-HEMI	00022092	1	D	12,0	12,0	16,0	65,0	-	-	0,1	-	2	■
40020-HEMI	00022093	2	G	2,0	3,0	3,0	40,0	6,0	1,9	0,1	3,5	2	■
40030-HEMI	00022094	2	E	3,0	3,0	4,0	40,0	8,0	2,9	0,1	-	2	■
40040-HEMI	00022095	2	E	4,0	4,0	5,0	50,0	12,0	3,8	0,1	-	2	■
40050-HEMI	00022120	2	E	5,0	5,0	8,0	50,0	14,0	4,8	0,1	-	2	■
40060-HEMI	00022250	2	E	6,0	6,0	8,0	65,0	18,0	5,7	0,1	-	2	■
40080-HEMI	00022580	2	E	8,0	8,0	10,0	70,0	22,0	7,7	0,1	-	2	■
40100-HEMI	00022663	2	E	10,0	10,0	14,0	80,0	28,0	9,7	0,1	-	2	■
40120-HEMI	00022667	2	E	12,0	12,0	16,0	90,0	35,0	11,5	0,1	-	2	■
40160-HEMI	00022668	2	E	16,0	16,0	20,0	90,0	40,0	15,5	0,1	-	2	■
40200-HEMI	00022701	2	E	20,0	20,0	25,0	100,0	50,0	19,5	0,1	-	2	■

■ Stocked standard.

Universal

Steel and cast iron

Stainless steel and S-materials

Non ferrous

Hard

Plastic and CFRP

Graphite

X-Heads

Minimaster Plus

Minimaster

JH40

High performance – Aluminium – Square – 2 Flutes – Cylindrical – Corner radius

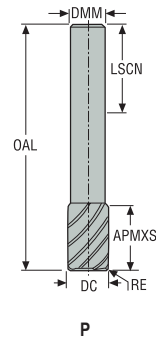

- Tolerances:
- DMM= h5
- DC= -0,02/-0,04 mm
- RE= ±0,1 mm
- Regrind possible if DC is ≥Ø6

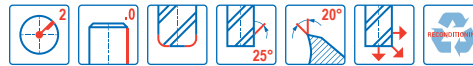

Designation	Item number	Length index	Tool shape	DC	DMM	APMXS	OAL	LSCN	RE	PCEDC	Cylindrical
				mm	mm	mm	mm	mm	mm		
40020-RS	02479642	2	P	2,0	1,9	3,0	40,0	28,0	0,1	2	■
40030-RS	02479643	2	P	3,0	2,9	4,0	60,0	28,0	0,1	2	■
40040-RS	02479644	2	P	4,0	3,8	5,0	60,0	28,0	0,1	2	■
40050-RS	02479645	2	P	5,0	4,8	8,0	70,0	28,0	0,1	2	■
40060-RS	02479646	2	P	6,0	5,8	8,0	65,0	36,0	0,1	2	■
40080-RS	02479647	2	P	8,0	7,8	10,0	70,0	36,0	0,1	2	■
40100-RS	02479648	2	P	10,0	9,7	14,0	100,0	40,0	0,1	2	■
40120-RS	02479649	2	P	12,0	11,7	16,0	90,0	45,0	0,1	2	■
40L060-RS	02479650	3	P	6,0	5,8	8,0	100,0	36,0	0,1	2	■
40L080-RS	02479651	3	P	8,0	7,8	10,0	100,0	36,0	0,1	2	■
40L120-RS	02479652	3	P	12,0	11,7	16,0	125,0	45,0	0,1	2	■
40L160-RS	02479653	3	P	16,0	15,7	20,0	125,0	48,0	0,1	2	■
40L200-RS	02479654	3	P	20,0	19,7	25,0	125,0	50,0	0,1	2	■

■ Stocked standard.

Universal

Steel and cast iron

Stainless steel and S-materials

Non ferrous

Hard

Plastic and CFRP

Graphite

X-Heads

Minimaster Plus

Minimaster

Cutting data – JH40 Side milling

SMG		a _e /DC	a _p /DC	f _z										v _c
				2	3	4	5	6	8	10	12	16	20	
N1	E/M/A	0.400	1.2	0.030	0.046	0.060	0.075	0.090	0.12	0.15	0.18	0.22	0.25	730 (610 – 840)
		0,400	1,2	0,0012	0,0018	0,0024	0,0030	0,0036	0,0048	0,0060	0,0070	0,0085	0,010	2400 (2100 – 2700)
N11	E/M/A	0.400	1.0	0.030	0.046	0.060	0.075	0.090	0.12	0.15	0.18	0.22	0.26	425 (320 – 520)
		0,400	1,0	0,0012	0,0018	0,0024	0,0030	0,0036	0,0048	0,0060	0,0070	0,0085	0,010	1400 (1100 – 1700)
TS1	A	0.400	1.2	0.030	0.046	0.060	0.075	0.090	0.12	0.15	0.18	0.22	0.25	730 (610 – 840)
		0,400	1,2	0,0012	0,0018	0,0024	0,0030	0,0036	0,0048	0,0060	0,0070	0,0085	0,010	2400 (2100 – 2700)

Cutting data – JH40 Slot milling

SMG		a _p /DC	f _z										v _c
			2	3	4	5	6	8	10	12	16	20	
N1	E/M/A	0.60	0.026	0.040	0.050	0.065	0.080	0.10	0.13	0.16	0.20	0.25	600 (510 – 700)
		0,60	0,0010	0,0016	0,0020	0,0026	0,0032	0,0040	0,0050	0,0065	0,0080	0,010	1975 (1700 – 2200)
N11	E/M/A	0.40	0.016	0.024	0.032	0.040	0.048	0.065	0.080	0.095	0.13	0.16	400 (310 – 500)
		0,40	0,00065	0,00095	0,0013	0,0016	0,0019	0,0026	0,0032	0,0038	0,0050	0,0065	1300 (1100 – 1600)
TS1	A	1.0	0.026	0.040	0.050	0.065	0.080	0.10	0.13	0.16	0.20	0.25	600 (510 – 700)
		1,0	0,0010	0,0016	0,0020	0,0026	0,0032	0,0040	0,0050	0,0065	0,0080	0,010	1975 (1700 – 2200)

For cutting data recalculations, see pages 556 - 563

SMG = Seco material group

Coolant = A=air D=dry E=emulsion M=mist spray

v_c = m/min (sf/min)

f_z = mm (in/tooth)

a_p = mm/DC (in/DC) = factor

a_e = mm/DC (in/DC) = factor

All cutting data are target values

Universal
Steel and cast iron
Stainless steel and S-materials
Non ferrous
Hard
Plastic and cfrp
Graphite
X-Heads
Minimaster Plus
Minimaster

JH421

High performance – Aluminium – Square – 2 Flutes – Cylindrical – Corner radius – ICC

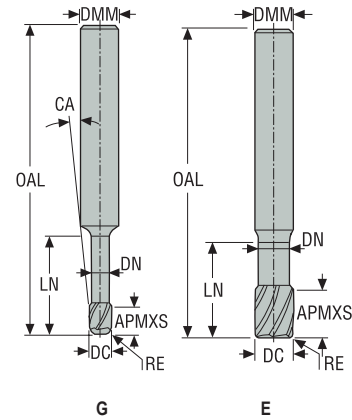

- Tolerances:
- DMM=h5
- DC=-0,02/-0,04 mm
- RE= ±0,05 mm
- Regrind possible if DC is ≥Ø6

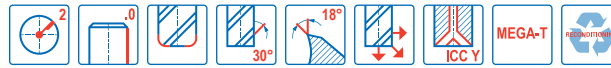

Designation	Item number	Length index	Tool shape	ICC	DC	DMM	APMXS	OAL	LN	DN	RE	CA°	PCEDC	Cylindrical
					mm	mm	mm	mm	mm	mm	mm			
421020R020Z2-MEGA-T	02434927	2	G	-	2,0	3,0	3,0	40,0	8,0	1,8	0,2	3,0	2	■
421030R020Z2-MEGA-T	02434939	2	E	-	3,0	3,0	4,0	40,0	12,0	2,7	0,2	-	2	■
421040R020Z2-MEGA-T	02434940	2	G	-	4,0	6,0	5,0	50,0	16,0	3,6	0,2	3,0	2	■
421040R030Z2-MEGA-T	02434941	2	G	-	4,0	6,0	5,0	50,0	16,0	3,6	0,3	3,0	2	■
421050R100Z2-MEGA-T	02434942	2	G	-	5,0	6,0	6,0	50,0	18,0	4,5	1,0	1,5	2	■
421060R025Z2-MEGA-T	02434946	2	E	-	6,0	6,0	8,0	50,0	20,0	5,4	0,25	-	2	■
421060R050Z2-MEGA-T	02434947	2	E	-	6,0	6,0	8,0	50,0	20,0	5,4	0,5	-	2	■
421060R100Z2-MEGA-T	02434958	2	E	-	6,0	6,0	8,0	50,0	20,0	5,4	1,0	-	2	■
421080R030Z2-MEGA-T	02434960	2	E	-	8,0	8,0	10,0	65,0	30,0	7,2	0,3	-	2	■
421080R060Z2-MEGA-T	02434964	2	E	-	8,0	8,0	10,0	65,0	30,0	7,2	0,6	-	2	■
421080R100Z2-MEGA-T	02434967	2	E	-	8,0	8,0	10,0	65,0	30,0	7,2	1,0	-	2	■
421100R030Z2-MEGA-T	02434968	2	E	-	10,0	10,0	12,0	80,0	36,0	9,0	0,3	-	2	■
421100R080Z2-MEGA-T	02434970	2	E	-	10,0	10,0	12,0	80,0	36,0	9,0	0,8	-	2	■
421100R150Z2-MEGA-T	02434971	2	E	-	10,0	10,0	12,0	80,0	36,0	9,0	1,5	-	2	■
421100R250Z2-MEGA-T	02438614	2	E	-	10,0	10,0	12,0	80,0	36,0	9,0	2,5	-	2	■
421100R310Z2-MEGA-T	02438683	2	E	-	10,0	10,0	12,0	80,0	36,0	9,0	3,1	-	2	■
421120R030Z2-MEGA-T	02434983	2	E	-	12,0	12,0	14,0	90,0	40,0	11,0	0,3	-	2	■
421120R050Z2-MEGA-T	02434986	2	E	-	12,0	12,0	14,0	90,0	40,0	11,0	0,5	-	2	■
421120R100Z2-MEGA-T	02434988	2	E	-	12,0	12,0	14,0	90,0	40,0	11,0	1,0	-	2	■
421120R150Z2-MEGA-T	02434989	2	E	-	12,0	12,0	14,0	90,0	40,0	11,0	1,5	-	2	■
421120R200Z2-MEGA-T	02434990	2	E	-	12,0	12,0	14,0	90,0	40,0	11,0	2,0	-	2	■
421120R250Z2AMEGA-T	02435008	2	E	■	12,0	12,0	14,0	90,0	40,0	11,0	2,5	-	2	■
421120R250Z2-MEGA-T	02435007	2	E	-	12,0	12,0	14,0	90,0	40,0	11,0	2,5	-	2	■
421120R310Z2-MEGA-T	02435009	2	E	-	12,0	12,0	14,0	90,0	40,0	11,0	3,1	-	2	■

■ Stocked standard.

Universal

Steel and cast iron

Stainless steel and S-materials

Non ferrous

Hard

Plastic and CFRP

Graphite

X-Heads

Minimaster Plus

Minimaster

JH421

High performance – Aluminium – Square – 2 Flutes – Cylindrical – Corner radius – ICC

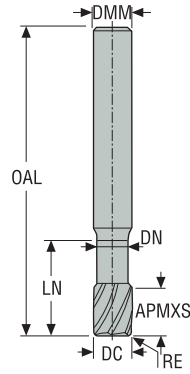

E

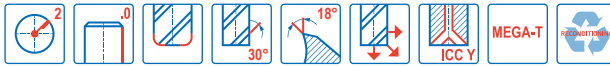

- Tolerances:
- DMM=h5
- DC=-0,02/-0,04 mm
- RE= ±0,05 mm
- Re grind possible

Designation	Item number	Length index	Tool shape	ICC	DC	DMM	APMXS	OAL	LN	DN	RE	PCEDC	Cylindrical
					mm	mm	mm	mm	mm	mm	mm		
421160R050Z2-MEGA-T	02435010	2	E	–	16,0	16,0	18,0	100,0	45,0	14,5	0,5	2	■
421160R200Z2-MEGA-T	02435014	2	E	–	16,0	16,0	18,0	100,0	45,0	14,5	2,0	2	■
421160R250Z2AMEGA-T	02435020	2	E	■	16,0	16,0	18,0	100,0	45,0	14,5	2,5	2	■
421160R250Z2-MEGA-T	02435012	2	E	–	16,0	16,0	18,0	100,0	45,0	14,5	2,5	2	■
421160R310Z2-MEGA-T	02435036	2	E	–	16,0	16,0	18,0	100,0	45,0	14,5	3,1	2	■
421160R400Z2AMEGA-T	02438684	2	E	■	16,0	16,0	18,0	100,0	45,0	14,5	4,0	2	■
421160R400Z2-MEGA-T	02435039	2	E	–	16,0	16,0	18,0	100,0	45,0	14,5	4,0	2	■
421200R160Z2-MEGA-T	02435042	2	E	–	20,0	20,0	24,0	100,0	45,0	18,0	1,6	2	■
421200R200Z2-MEGA-T	02435044	2	E	–	20,0	20,0	24,0	100,0	45,0	18,0	2,0	2	■
421200R250Z2AMEGA-T	02438685	2	E	■	20,0	20,0	24,0	100,0	45,0	18,0	2,5	2	■
421200R250Z2-MEGA-T	02435046	2	E	–	20,0	20,0	24,0	100,0	45,0	18,0	2,5	2	■
421200R310Z2-MEGA-T	02435049	2	E	–	20,0	20,0	24,0	100,0	45,0	18,0	3,1	2	■
421200R400Z2-MEGA-T	02435051	2	E	–	20,0	20,0	24,0	100,0	45,0	18,0	4,0	2	■
421200R500Z2-MEGA-T	02435055	2	E	–	20,0	20,0	24,0	100,0	45,0	18,0	5,0	2	■

■ Stocked standard.

Universal

Steel and cast iron

Stainless steel and S-materials

Non ferrous

Hard

Plastic and CFRP

Graphite

X-Heads

Minimaster Plus

Minimaster

JH421

High performance – Aluminium – Square – 2 Flutes – Cylindrical – Corner radius – ICC

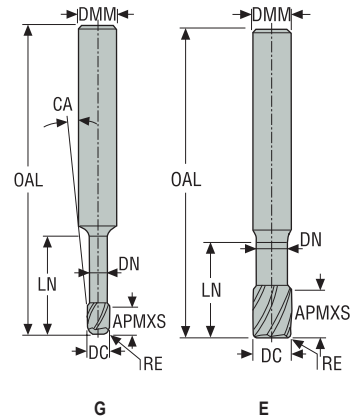

- Tolerances:
- DMM=h5
- DC=-0,02/-0,04 mm
- RE= ±0,05 mm
- Regrind possible

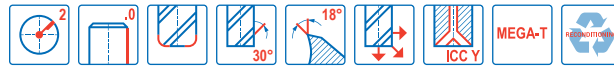

Designation	Item number	Length index	Tool shape	ICC	DC	DMM	APMXS	OAL	LN	DN	RE	CA°	PCEDC	Cylindrical
					mm	mm	mm	mm	mm	mm	mm			
421L080R020Z2-MEGA-T	02435068	3	E	-	8,0	8,0	6,0	75,0	40,0	7,2	0,2	-	2	■
421L100R050Z2-MEGA-T	02435070	3	E	-	10,0	10,0	8,0	90,0	50,0	9,0	0,5	-	2	■
421L100R250Z2-MEGA-T	02435074	3	E	-	10,0	10,0	8,0	90,0	50,0	9,0	2,5	-	2	■
421L100R310Z2-MEGA-T	02438690	3	E	-	10,0	10,0	8,0	90,0	50,0	9,0	3,1	-	2	■
421L120R050Z2-MEGA-T	02435340	3	E	-	12,0	12,0	10,0	110,0	70,0	11,0	0,5	-	2	■
421L120R100Z2-MEGA-T	02435343	3	E	-	12,0	12,0	10,0	110,0	70,0	11,0	1,0	-	2	■
421L120R200Z2-MEGA-T	02435373	3	E	-	12,0	12,0	10,0	110,0	70,0	11,0	2,0	-	2	■
421L120R250Z2-MEGA-T	02435374	3	E	-	12,0	12,0	10,0	110,0	70,0	11,0	2,5	-	2	■
421L120R310Z2-MEGA-T	02438692	3	E	-	12,0	12,0	10,0	110,0	70,0	11,0	3,1	-	2	■
421L140R050Z2-MEGA-T	02462710	3	G	-	14,0	16,0	12,0	110,0	70,0	13,0	0,5	1,0	2	■
421L140R310Z2-MEGA-T	02462712	3	G	-	14,0	16,0	12,0	110,0	70,0	13,0	3,1	1,0	2	■
421L160R050Z2-MEGA-T	02435375	3	E	-	16,0	16,0	13,0	125,0	80,0	14,5	0,5	-	2	■
421L160R100Z2-MEGA-T	02435380	3	E	-	16,0	16,0	13,0	125,0	80,0	14,5	1,0	-	2	■
421L160R200Z2-MEGA-T	02435381	3	E	-	16,0	16,0	13,0	125,0	80,0	14,5	2,0	-	2	■
421L160R250Z2AMEGA-T	02435383	3	E	■	16,0	16,0	13,0	125,0	80,0	14,5	2,5	-	2	■
421L160R250Z2-MEGA-T	02435382	3	E	-	16,0	16,0	13,0	125,0	80,0	14,5	2,5	-	2	■
421L160R310Z2-MEGA-T	02435384	3	E	-	16,0	16,0	13,0	125,0	80,0	14,5	3,1	-	2	■
421L160R400Z2AMEGA-T	02435386	3	E	■	16,0	16,0	13,0	125,0	80,0	14,5	4,0	-	2	■
421L200R050Z2-MEGA-T	02435387	3	E	-	20,0	20,0	16,0	150,0	100,0	18,0	0,5	-	2	■
421L200R200Z2-MEGA-T	02435391	3	E	-	20,0	20,0	16,0	150,0	100,0	18,0	2,0	-	2	■
421L200R310Z2-MEGA-T	02435398	3	E	-	20,0	20,0	16,0	150,0	100,0	18,0	3,1	-	2	■
421L200R500Z2-MEGA-T	02435401	3	E	-	20,0	20,0	16,0	150,0	100,0	18,0	5,0	-	2	■

■ Stocked standard.

Universal

Steel and cast iron

Stainless steel and S-materials

Non ferrous

Hard

Plastic and CFRP

Graphite

X-Heads

Minimaster Plus

Minimaster

Cutting data – JH421 Side milling

SMG		a _e /DC	a _p /DC	f _z												v _c
				2	3	4	5	6	8	10	12	14	16	20	25	
N1	E/M/A	0.400	1.0	0.030	0.044	0.060	0.075	0.090	0.12	0.15	0.18	0.20	0.22	0.25	0.28	620 (520 – 720)
		0,400	1,0	0,0012	0,0017	0,0024	0,0030	0,0036	0,0048	0,0060	0,0070	0,0080	0,0085	0,010	0,011	2025 (1800 – 2300)
N11	E/M/A	0.400	1.0	0.020	0.030	0.040	0.050	0.060	0.080	0.10	0.12	0.13	0.15	0.17	0.19	410 (310 – 510)
		0,400	1,0	0,00080	0,0012	0,0016	0,0020	0,0024	0,0032	0,0040	0,0048	0,0050	0,0060	0,0065	0,0075	1350 (1100 – 1600)
TS1	A	0.400	1.0	0.030	0.044	0.060	0.075	0.090	0.12	0.15	0.18	0.20	0.22	0.25	0.28	620 (520 – 720)
		0,400	1,0	0,0012	0,0017	0,0024	0,0030	0,0036	0,0048	0,0060	0,0070	0,0080	0,0085	0,010	0,011	2025 (1800 – 2300)
TP1	M	0.400	1.0	0.024	0.036	0.048	0.060	0.070	0.095	0.12	0.14	0.16	0.18	0.20	0.24	410 (310 – 500)
		0,400	1,0	0,00095	0,0014	0,0019	0,0024	0,0028	0,0038	0,0048	0,0055	0,0065	0,0070	0,0080	0,0095	1350 (1100 – 1600)

Cutting data – JH421 Slot milling

SMG		a _p /DC	f _z												v _c
			2	3	4	5	6	8	10	12	14	16	20	25	
N1	E/M/A	0.50	0.014	0.022	0.028	0.036	0.042	0.055	0.070	0.085	0.10	0.11	0.14	0.18	610 (510 – 700)
		0,50	0,00055	0,00085	0,0011	0,0014	0,0017	0,0022	0,0028	0,0034	0,0040	0,0044	0,0055	0,0070	2000 (1700 – 2200)
N11	E/M/A	0.50	0.0080	0.012	0.016	0.020	0.025	0.032	0.040	0.050	0.055	0.065	0.080	0.10	405 (310 – 500)
		0,50	0,00032	0,00048	0,00065	0,00080	0,0010	0,0013	0,0016	0,0020	0,0022	0,0026	0,0032	0,0040	1325 (1100 – 1600)
TS1	A	0.50	0.014	0.022	0.028	0.036	0.042	0.055	0.070	0.085	0.10	0.11	0.14	0.18	610 (510 – 700)
		0,50	0,00055	0,00085	0,0011	0,0014	0,0017	0,0022	0,0028	0,0034	0,0040	0,0044	0,0055	0,0070	2000 (1700 – 2200)
TP1	M	0.50	0.010	0.015	0.020	0.025	0.030	0.040	0.050	0.060	0.070	0.080	0.10	0.13	405 (310 – 500)
		0,50	0,00040	0,00060	0,00080	0,0010	0,0012	0,0016	0,0020	0,0024	0,0028	0,0032	0,0040	0,0050	1325 (1100 – 1600)

For cutting data recalculations, see pages 556 - 563

SMG = Seco material group
Coolant = A=air D=dry E=emulsion M=mist spray
v_c = m/min (sf/min)
f_z = mm (in/tooth)
a_p = mm/DC (in/DC) = factor
a_e = mm/DC (in/DC) = factor
All cutting data are target values

Universal
Steel and cast iron
Stainless steel and S-materials
Non ferrous
Hard
Plastic and cfrp
Graphite
X-Heads
Minimaster Plus
Minimaster

JH410

High performance – Aluminium – Square – 1 Flute – Cylindrical – Corner radius

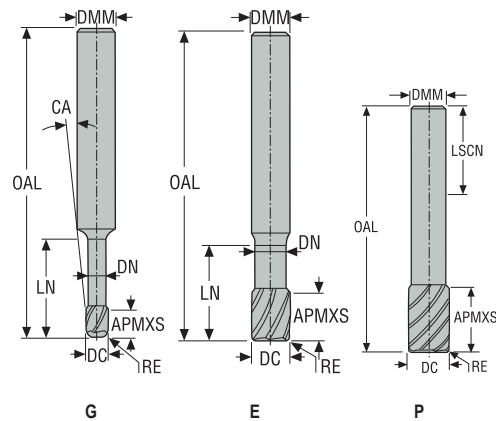

- Tolerances:
- DMM= h5
- DC= -0,02/-0,04 mm
- RE= ±0,02 mm
- Regrind possible if DC is ≥Ø6

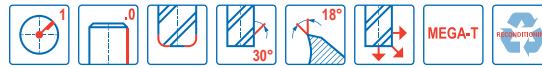

Designation	Item number	Length index	Tool shape	DC	DMM	APMXS	OAL	LN	LSCN	DN	RE	CA°	PCEDC	Cylindrical
				mm	mm	mm	mm	mm	mm	mm	mm	mm		
410020R050-MEGA-T	02451548	2	G	2,0	6,0	3,0	50,0	6,0	36,0	1,7	0,5	12,0	1	■
410030R050-MEGA-T	02451578	2	G	3,0	6,0	4,0	50,0	8,0	36,0	2,7	0,5	7,5	1	■
410ML030R050-MEGA-T	02451580	2	G	3,0	6,0	4,0	60,0	15,0	36,0	2,7	0,5	5,0	1	■
410040R050-MEGA-T	02451581	2	G	4,0	6,0	5,0	60,0	8,0	36,0	3,6	0,5	5,5	1	■
410ML040R050-MEGA-T	02451585	2	G	4,0	6,0	5,0	60,0	15,0	36,0	3,6	0,5	3,5	1	■
410050R050-MEGA-T	02451586	2	G	5,0	6,0	7,0	65,0	11,0	36,0	4,5	0,5	2,5	1	■
410ML050R050-MEGA-T	02451589	2	G	5,0	6,0	7,0	65,0	18,0	36,0	4,5	0,5	1,5	1	■
410TL050R050-MEGA-T	02451587	2	G	5,0	6,0	7,0	65,0	26,0	36,0	4,5	0,5	1,5	1	■
410060R050-MEGA-T	02451591	2	E	6,0	6,0	8,0	70,0	11,0	36,0	5,3	0,5	-	1	■
410ML060R050-MEGA-T	02451593	2	E	6,0	6,0	8,0	70,0	18,0	36,0	5,3	0,5	-	1	■
410TL060R050-MEGA-T	02451592	2	E	6,0	6,0	8,0	70,0	31,0	36,0	5,3	0,5	-	1	■
410070RSR050-MEGA-T	02451594	2	P	7,0	6,0	9,0	65,0	-	36,0	-	0,5	-	1	■
410090RSR050-MEGA-T	02451596	2	P	9,0	8,0	11,0	65,0	-	36,0	-	0,5	-	1	■
410110RSR050-MEGA-T	02451598	2	P	11,0	10,0	13,0	70,0	-	40,0	-	0,5	-	1	■
410130RSR100-MEGA-T	02451600	2	P	13,0	12,0	15,0	70,0	-	45,0	-	1,0	-	1	■
410150RSR100-MEGA-T	02451603	2	P	15,0	14,0	17,0	80,0	-	45,0	-	1,0	-	1	■
410170RSR100-MEGA-T	02451605	2	P	17,0	16,0	19,0	80,0	-	48,0	-	1,0	-	1	■
410L070RSR200-MEGA-T	02451595	3	P	7,0	6,0	9,0	85,0	-	36,0	-	2,0	-	1	■
410L090RSR200-MEGA-T	02451597	3	P	9,0	8,0	11,0	85,0	-	36,0	-	2,0	-	1	■
410L110RSR200-MEGA-T	02451599	3	P	11,0	10,0	13,0	90,0	-	40,0	-	2,0	-	1	■
410L130RSR200-MEGA-T	02451601	3	P	13,0	12,0	15,0	90,0	-	45,0	-	2,0	-	1	■
410L150RSR200-MEGA-T	02451604	3	P	15,0	14,0	17,0	110,0	-	45,0	-	2,0	-	1	■
410L170RSR200-MEGA-T	02451606	3	P	17,0	16,0	19,0	110,0	-	48,0	-	2,0	-	1	■

■ Stocked standard.

Universal

Steel and cast iron

Stainless steel and S-materials

Non ferrous

Hard

Plastic and CFRP

Graphite

X-Heads

Minimaster Plus

Minimaster

Cutting data – JH410 Side milling roughing

SMG		a _e /DC	a _p /DC	f _z											v _c
				2	3	4	5	6	7	9	11	13	15	17	
N1	E/M/A	0.410	1.0	0.070	0.11	0.14	0.18	0.22	0.25	0.32	0.40	0.46	0.50	0.55	710 (600 — 820)
		0.410	1,0	0,0028	0,0044	0,0055	0,0070	0,0085	0,010	0,013	0,016	0,018	0,020	0,022	2325 (2000 — 2600)
N11	E/M/A	0.318	0.65	0.026	0.040	0.055	0.065	0.080	0.095	0.12	0.15	0.17	0.19	0.22	495 (380 — 610)
		0.318	0,65	0,0010	0,0016	0,0022	0,0026	0,0032	0,0038	0,0048	0,0060	0,0065	0,0075	0,0085	1625 (1300 — 2000)
TS1	A	0.410	1.0	0.070	0.11	0.14	0.18	0.22	0.25	0.32	0.40	0.46	0.50	0.55	710 (600 — 820)
		0.410	1,0	0,0028	0,0044	0,0055	0,0070	0,0085	0,010	0,013	0,016	0,018	0,020	0,022	2325 (2000 — 2600)

Cutting data – JH410 Slot milling

SMG		a _p /DC	f _z											v _c
			2	3	4	5	6	7	9	11	13	15	17	
N1	E/M/A	0.75	0.055	0.080	0.11	0.14	0.16	0.19	0.25	0.30	0.36	0.40	0.46	630 (530 — 730)
		0.75	0,0022	0,0032	0,0044	0,0055	0,0065	0,0075	0,010	0,012	0,014	0,016	0,018	2075 (1800 — 2300)
N11	E/M/A	0.36	0.018	0.028	0.036	0.046	0.055	0.065	0.080	0.10	0.12	0.14	0.15	420 (320 — 520)
		0.36	0,00070	0,0011	0,0014	0,0018	0,0022	0,0026	0,0032	0,0040	0,0048	0,0055	0,0060	1375 (1100 — 1700)
TS1	A	1.0	0.055	0.080	0.11	0.14	0.16	0.19	0.25	0.30	0.36	0.40	0.46	630 (530 — 730)
		1,0	0,0022	0,0032	0,0044	0,0055	0,0065	0,0075	0,010	0,012	0,014	0,016	0,018	2075 (1800 — 2300)

For cutting data recalculations, see pages 556 - 563

SMG = Seco material group

Coolant = A=air D=dry E=emulsion M=mist spray

v_c = m/min (sf/min)

f_z = mm (in/tooth)

a_p = mm/DC (in/DC) = factor

a_e = mm/DC (in/DC) = factor

All cutting data are target values

Universal
Steel and cast iron
Stainless steel and S-materials
Non ferrous
Hard
Plastic and cfrp
Graphite
X-Heads
Minimaster Plus
Minimaster

JH440

High speed – Aluminium – Square – 2 Flutes – Cylindrical – Corner radius

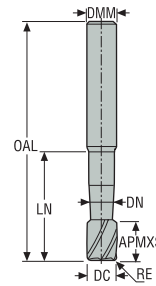

E

- Tolerances:
- DMM=h5
- DC=-0,02/-0,04 mm
- RE= ±0,05 mm
- Regrind possible

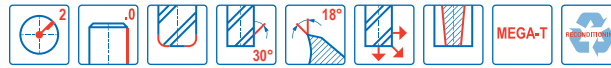

Designation	Item number	Length index	Tool shape	DC	DMM	APMXS	OAL	LN	DN	RE	PCEDC	Cylindrical
				mm	mm	mm	mm	mm	mm	mm		
440060-MEGA-T	00022702	2	E	6,0	6,0	8,0	60,0	30,0	5,4	1,5	2	■
440080-MEGA-T	00022865	2	E	8,0	8,0	10,0	60,0	30,0	7,2	2,0	2	■

■ Stocked standard.

Universal

Steel and cast iron

Stainless steel and S-materials

Non ferrous

Hard

Plastic and CFRP

Graphite

X-Heads

Minimaster Plus

Minimaster

Cutting data – JH440 Copy milling roughing

SMG		a _e /DC		a _p /DC		f _z		v _c
						6	8	
N1	E/M/A	0.300	0.50	0.080	0.10	780 (650 — 900)		
		0,300	0,50	0,0032	0,0040	2550 (2200 — 2900)		
N2	E/M/A	0.300	0.50	0.060	0.080	510 (390 — 640)		
		0,300	0,50	0,0024	0,0032	1675 (1300 — 2000)		
N3	E/M/A	0.300	0.50	0.060	0.080	340 (260 — 420)		
		0,300	0,50	0,0024	0,0032	1125 (860 — 1300)		
N11	E/M/A	0.300	0.50	0.060	0.080	255 (130 — 370)		
		0,300	0,50	0,0024	0,0032	840 (430 — 1200)		
TS1	A	0.300	0.50	0.080	0.10	780 (650 — 900)		
		0,300	0,50	0,0032	0,0040	2550 (2200 — 2900)		
TP1	A	0.300	0.60	0.060	0.080	510 (380 — 630)		
		0,300	0,60	0,0024	0,0032	1675 (1300 — 2000)		

For cutting data recalculations, see pages 556 - 563

SMG = Seco material group
 Coolant = A=air D=dry E=emulsion M=mist spray
 v_c = m/min (sf/min)
 f_z = mm (in/tooth)
 a_p = mm/DC (in/DC) = factor
 a_e = mm/DC (in/DC) = factor
 All cutting data are target values

Universal
Steel and cast iron
Stainless steel and S-materials
Non ferrous
Hard
Plastic and cfrp
Graphite
X-Heads
Minimaster Plus
Minimaster

JH450

High speed – Aluminium – Ball nose – 2 Flutes – Cylindrical

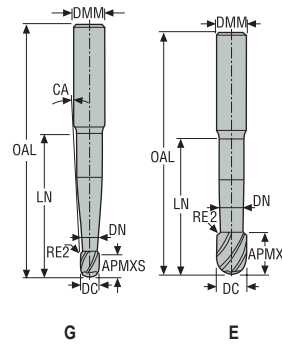

- Tolerances:
- DMM= h5
- DC= -0,02/-0,04 mm
- RE= ±0,02 mm
- Regrind possible if DC is ≥Ø6

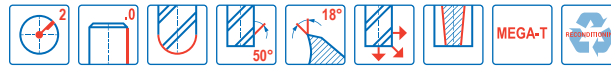

Designation	Item number	Length index	Tool shape	DC	DMM	APMXS	OAL	LN	DN	RE2	CA°	PCEDC	Cylindrical
				mm	mm	mm	mm	mm	mm	mm			
450020-MEGA-T	00022977	2	G	2,0	3,0	1,75	40,0	10,0	1,8	1,0	3,0	2	■
450030-MEGA-T	00022978	2	E	3,0	3,0	2,5	40,0	12,0	2,7	2,0	-	2	■
450040-MEGA-T	00022979	2	G	4,0	6,0	3,5	50,0	21,0	3,6	2,0	3,0	2	■
450050-MEGA-T	00022980	2	G	5,0	6,0	4,5	50,0	22,5	4,5	2,0	2,0	2	■
450060-MEGA-T	00023020	2	E	6,0	6,0	5,5	55,0	25,0	5,4	2,0	-	2	■
450080-MEGA-T	00023032	2	E	8,0	8,0	7,0	65,0	30,0	7,2	2,0	-	2	■
450100-MEGA-T	00023040	2	E	10,0	10,0	8,5	75,0	35,0	9,0	3,0	-	2	■
450120-MEGA-T	00029842	2	E	12,0	12,0	10,5	75,0	40,0	11,0	3,0	-	2	■
450160-MEGA-T	00023050	2	E	16,0	16,0	14,0	90,0	50,0	14,5	4,0	-	2	■
450200-MEGA-T	00023053	2	E	20,0	20,0	17,0	100,0	50,0	18,0	4,0	-	2	■
450L100-MEGA-T	00023056	3	G	10,0	12,0	8,5	125,0	50,0	9,0	3,0	1,5	2	■
450L120-MEGA-T	00023091	3	E	12,0	12,0	10,5	150,0	60,0	11,0	3,0	-	2	■
450L160-MEGA-T	00023095	3	E	16,0	16,0	14,0	150,0	70,0	14,5	4,0	-	2	■

■ Stocked standard.

Universal

Steel and cast iron

Stainless steel and S-materials

Non ferrous

Hard

Plastic and cfrp

Graphite

X-Heads

Minimaster Plus

Minimaster

Cutting data – JH450 Copy milling roughing

SMG		a _e /DC	a _p /DC	f _z										v _c
				2	3	4	5	6	8	10	12	16	20	
N1	E/M/A	0.400	0.24	0.040	0.060	0.080	0.10	0.12	0.16	0.20	0.24	0.32	0.40	690 (670 – 930)
		0,400	0,24	0,0016	0,0024	0,0032	0,0040	0,0048	0,0065	0,0080	0,0095	0,013	0,016	2275 (2200 – 3000)
N2	E/M/A	0.300	0.24	0.040	0.060	0.080	0.10	0.12	0.16	0.20	0.24	0.32	0.40	470 (410 – 680)
		0,300	0,24	0,0016	0,0024	0,0032	0,0040	0,0048	0,0065	0,0080	0,0095	0,013	0,016	1550 (1400 – 2200)
N3	E/M/A	0.300	0.24	0.040	0.060	0.080	0.10	0.12	0.16	0.20	0.24	0.32	0.40	315 (280 – 450)
		0,300	0,24	0,0016	0,0024	0,0032	0,0040	0,0048	0,0065	0,0080	0,0095	0,013	0,016	1025 (920 – 1400)
N11	E/M/A	0.300	0.24	0.040	0.060	0.080	0.10	0.12	0.16	0.20	0.24	0.32	0.38	470 (420 – 680)
		0,300	0,24	0,0016	0,0024	0,0032	0,0040	0,0048	0,0065	0,0080	0,0095	0,013	0,015	1550 (1400 – 2200)
TS1	A	0.500	0.50	0.040	0.060	0.080	0.10	0.12	0.16	0.20	0.24	0.30	0.34	700 (630 – 860)
		0,500	0,50	0,0016	0,0024	0,0032	0,0040	0,0048	0,0065	0,0080	0,0095	0,012	0,013	2300 (2100 – 2800)
TP1	M	0.300	0.24	0.040	0.060	0.080	0.10	0.12	0.16	0.20	0.24	0.32	0.38	470 (410 – 680)
		0,300	0,24	0,0016	0,0024	0,0032	0,0040	0,0048	0,0065	0,0080	0,0095	0,013	0,015	1550 (1400 – 2200)

For cutting data recalculations, see pages 556 - 563

SMG = Seco material group
 Coolant = A=air D=dry E=emulsion M=mist spray
 v_c = m/min (sf/min)
 f_z = mm (in/tooth)
 a_p = mm/DC (in/DC) = factor
 a_e = mm/DC (in/DC) = factor
 All cutting data are target values

Universal
 Steel and cast iron
 Stainless steel and S-materials
 Non ferrous
 Hard
 Plastic and cfrp
 Graphite
 X-Heads
 Minimaster Plus
 Minimaster

JH460

High speed – Aluminium – Ball nose – 2 Flutes – Cylindrical

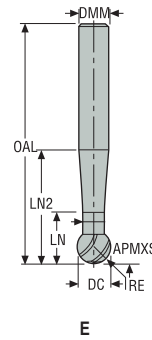

- Tolerances:
- DMM=h5
- DC=-0,02/-0,06 mm
- RE= ±0.02 mm
- SA=250°

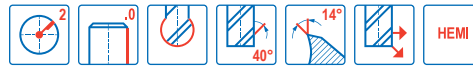

Designation	Item number	Length index	Tool shape	DC	DMM	APMXS	OAL	LN	LN2	DN	RE	PCEDC	Cylindrical
				mm	mm	mm	mm	mm	mm	mm	mm		
460030-HEMI	00040372	2	E	3,0	3,0	2,3	60,0	4,8	9,9	1,5	1,5	2	■
460040-HEMI	00040373	2	E	4,0	4,0	3,1	60,0	5,6	12,1	2,0	2,0	2	■
460050-HEMI	00040376	2	E	5,0	5,0	3,9	70,0	6,4	14,4	2,5	2,5	2	■
460060-HEMI	00040377	2	E	6,0	6,0	4,7	80,0	9,7	19,1	3,0	3,0	2	■
460080-HEMI	00040378	2	E	8,0	8,0	6,2	85,0	11,2	23,6	4,0	4,0	2	■
460100-HEMI	00040379	2	E	10,0	10,0	7,8	100,0	15,6	30,8	5,0	5,0	2	■
460120-HEMI	00040380	2	E	12,0	12,0	9,4	125,0	17,2	35,3	6,0	6,0	2	■

■ Stocked standard.

Universal

Steel and cast iron

Stainless steel and S-materials

Non ferrous

Hard

Plastic and CFRP

Graphite

X-Heads

Minimaster Plus

Minimaster

Cutting data – JH460 Copy milling roughing

SMG		a _e /DC	a _p /DC	f _z							v _c
				3	4	5	6	8	10	12	
N1	E/M/A	0.500	0.20	0.055	0.075	0.095	0.11	0.15	0.19	0.22	590 (500 – 680)
		0,500	0,20	0,0022	0,0030	0,0038	0,0044	0,0060	0,0075	0,0085	1925 (1700 – 2200)
N11	E/M/A	0.300	0.20	0.046	0.065	0.080	0.095	0.13	0.16	0.18	610 (510 – 700)
		0,300	0,20	0,0018	0,0026	0,0032	0,0038	0,0050	0,0065	0,0070	2000 (1700 – 2200)
S11	E/M/A	0.300	0.20	0.034	0.044	0.055	0.065	0.090	0.11	0.13	120 (110 – 130)
		0,300	0,20	0,0013	0,0017	0,0022	0,0026	0,0036	0,0044	0,0050	395 (370 – 420)
S12	E/M/A	0.300	0.20	0.034	0.044	0.055	0.065	0.090	0.11	0.13	90 (82 – 100)
		0,300	0,20	0,0013	0,0017	0,0022	0,0026	0,0036	0,0044	0,0050	295 (270 – 320)
S13	E/M/A	0.300	0.20	0.030	0.038	0.048	0.060	0.075	0.095	0.11	75 (65 – 81)
		0,300	0,20	0,0012	0,0015	0,0019	0,0024	0,0030	0,0038	0,0044	245 (220 – 260)
TS1	A	0.500	0.50	0.055	0.070	0.13	0.15	0.20	0.25	0.30	620 (520 – 720)
		0,500	0,50	0,0022	0,0028	0,0050	0,0060	0,0080	0,010	0,012	2025 (1800 – 2300)
TP1	M	0.300	0.20	0.046	0.065	0.080	0.095	0.13	0.16	0.18	405 (360 – 450)
		0,300	0,20	0,0018	0,0026	0,0032	0,0038	0,0050	0,0065	0,0070	1325 (1200 – 1400)

For cutting data recalculations, see pages 556 - 563

SMG = Seco material group
Coolant = A=air D=dry E=emulsion M=mist spray
v_c = m/min (sf/min)
f_z = mm (in/tooth)
a_p = mm/DC (in/DC) = factor
a_e = mm/DC (in/DC) = factor
All cutting data are target values

Universal
Steel and cast iron
Stainless steel and S-materials
Non ferrous
Hard
Plastic and cfrp
Graphite
X-Heads
Minimaster Plus
Minimaster

SMB413/414/416

Miniature – Aluminium – Ball nose – 2 Flutes – Cylindrical

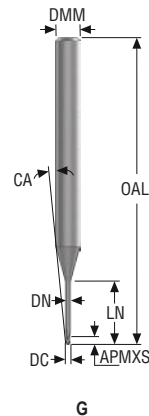

G

- Tolerances:
- Run-out= <0,005 mm
- DMM = h5
- DC = 0/-0,01 mm
- RE = ±0,005 mm

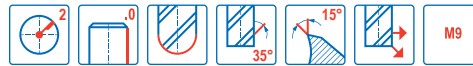

Designation	Grade	Item number	Length index	Tool shape	DC	DMM	APMXS	OAL	DN	LN	CA°	PCEDC	Cylindrical
					mm	mm	mm	mm	mm	mm			
SMB414020G4B.0Z2	-	10109385	4	G	2,0	4	2,0	50	1,9	12,0	3,75°	2	■
SMB414020G4B.0Z2	M9	10109139	4	G	2,0	4	2,0	50	1,9	12,0	3,75°	2	■
SMB414030G4B.0Z2	-	10109386	4	G	3,0	4	3,0	50	2,85	16,0	1,68°	2	■
SMB414030G4B.0Z2	M9	10109140	4	G	3,0	4	3,0	50	2,85	16,0	1,68°	2	■
SMB413025G5B.0Z2	-	10109133	5	G	2,5	3	2,5	50	2,4	20,0	0,71°	2	■
SMB413025G5B.0Z2	M9	10109136	5	G	2,5	3	2,5	50	2,4	20,0	0,71°	2	■
SMB414025G5B.0Z2	-	10109387	5	G	2,5	4	2,5	50	2,4	20,0	1,94°	2	■
SMB414025G5B.0Z2	M9	10109141	5	G	2,5	4	2,5	50	2,4	20,0	1,94°	2	■
SMB416025G5B.0Z2	-	10109390	5	G	2,5	6	2,5	55	2,4	20,0	3,87°	2	■
SMB416025G5B.0Z2	M9	10109145	5	G	2,5	6	1,0	55	0,95	20,0	3,87°	2	■
SMB414010G6B.0Z2	-	10109381	6	G	1,0	4	1,0	50	0,95	10,0	5,5°	2	■
SMB414010G6B.0Z2	M9	10109142	6	G	1,0	4	1,0	50	0,95	10,0	5,5°	2	■
SMB413015G6B.0Z2	-	10109134	6	G	1,5	3	1,5	50	1,4	20,0	1,9°	2	■
SMB413015G6B.0Z2	M9	10109137	6	G	1,5	3	1,5	50	1,4	20,0	1,9°	2	■
SMB414015G6B.0Z2	-	10109388	6	G	1,5	4	2,5	55	2,4	20,0	2,92°	2	■
SMB414015G6B.0Z2	M9	10109143	6	G	1,5	4	1,5	55	1,4	20,0	2,92°	2	■
SMB416015G6B.0Z2	-	10109391	6	G	1,5	6	1,5	55	1,4	20,0	4,56°	2	■
SMB416015G6B.0Z2	M9	10109146	6	G	1,5	6	1,5	55	1,4	20,0	4,56°	2	■
SMB413010G7B.0Z2	-	10109135	7	G	1,0	3	1,0	50	0,95	18,0	2,63°	2	■
SMB413010G7B.0Z2	M9	10109138	7	G	1,0	3	1,0	50	0,95	18,0	2,63°	2	■
SMB414010G7B.0Z2	-	10109389	7	G	1,0	4	1,0	50	0,95	18,0	3,64°	2	■
SMB414010G7B.0Z2	M9	10109144	7	G	1,0	4	1,0	50	0,95	18,0	3,64°	2	■
SMB416010G7B.0Z2	-	10109392	7	G	1,0	6	1,0	55	0,95	18,0	5,23°	2	■
SMB416010G7B.0Z2	M9	10109147	7	G	1,0	6	1,0	55	0,95	18,0	5,23°	2	■

■ Stocked standard.

Universal

Steel and cast iron

Stainless steel and S-materials

Non ferrous

Hard

Plastic and CFRP

Graphite

X-Heads

Minimaster Plus

Minimaster

Cutting data – SMB413 Copy milling roughing

SMG		a _e /DC	a _p /DC	f _z			v _c
				1	1.5	2.5	
N1	E	0,0500	0,080	0,013	0,020	0,032	135 (86 – 170)
		0,0500	0,080	0,00050	0,00080	0,0013	445 (290 – 550)
N2	E	0,0500	0,080	0,013	0,020	0,032	85 (55 – 100)
		0,0500	0,080	0,00050	0,00080	0,0013	280 (190 – 320)
N3	E	0,0500	0,080	0,013	0,020	0,032	55 (37 – 73)
		0,0500	0,080	0,00050	0,00080	0,0013	180 (130 – 230)
TS1	A	0,0500	0,080	0,013	0,020	0,032	135 (86 – 170)
		0,0500	0,080	0,00050	0,00080	0,0013	445 (290 – 550)
TP1	A	0,0500	0,080	0,013	0,020	0,032	135 (86 – 170)
		0,0500	0,080	0,00050	0,00080	0,0013	445 (290 – 550)

Cutting data – SMB414 Copy milling roughing

SMG		a _e /DC	a _p /DC	f _z					v _c
				1	1.5	2	2.5	3	
N1	E	0,0500	0,080	0,013	0,020	0,026	0,032	0,040	135 (86 – 170)
		0,0500	0,080	0,00050	0,00080	0,0010	0,0013	0,0016	445 (290 – 550)
N2	E	0,0500	0,080	0,013	0,020	0,026	0,032	0,040	85 (55 – 100)
		0,0500	0,080	0,00050	0,00080	0,0010	0,0013	0,0016	280 (190 – 320)
N3	E	0,0500	0,080	0,013	0,020	0,026	0,032	0,040	55 (37 – 73)
		0,0500	0,080	0,00050	0,00080	0,0010	0,0013	0,0016	180 (130 – 230)
TS1	A	0,0500	0,080	0,013	0,020	0,026	0,032	0,040	135 (86 – 170)
		0,0500	0,080	0,00050	0,00080	0,0010	0,0013	0,0016	445 (290 – 550)
TP1	A	0,0500	0,080	0,013	0,020	0,026	0,032	0,040	135 (86 – 170)
		0,0500	0,080	0,00050	0,00080	0,0010	0,0013	0,0016	445 (290 – 550)

Cutting data – SMB416 Copy milling roughing

SMG		a _e /DC	a _p /DC	f _z			v _c
				1	1.5	2.5	
N1	E	0,0500	0,080	0,013	0,020	0,032	135 (86 – 170)
		0,0500	0,080	0,00050	0,00080	0,0013	445 (290 – 550)
N2	E	0,0500	0,080	0,013	0,020	0,032	85 (55 – 100)
		0,0500	0,080	0,00050	0,00080	0,0013	280 (190 – 320)
N3	E	0,0500	0,080	0,013	0,020	0,032	55 (37 – 73)
		0,0500	0,080	0,00050	0,00080	0,0013	180 (130 – 230)
TS1	A	0,0500	0,080	0,013	0,020	0,032	135 (86 – 170)
		0,0500	0,080	0,00050	0,00080	0,0013	445 (290 – 550)
TP1	A	0,0500	0,080	0,013	0,020	0,032	135 (86 – 170)
		0,0500	0,080	0,00050	0,00080	0,0013	445 (290 – 550)

For cutting data recalculations, see pages 556 - 563

SMG = Seco material group
 Coolant = A=air D=dry E=emulsion M=mist spray
 v_c = m/min (sf/min)
 f_z = mm (in/tooth)
 a_p = mm/DC (in/DC) = factor
 a_e = mm/DC (in/DC) = factor
 All cutting data are target values

Universal
 Steel and cast iron
 Stainless steel and S-materials
 Non ferrous
 Hard
 Plastic and CFRP
 Graphite
 X-Heads
 Minmaster Plus
 Minmaster

JM403/JM404/JM406

Miniature – Aluminium – Square – 1 Flute – Cylindrical – Corner radius

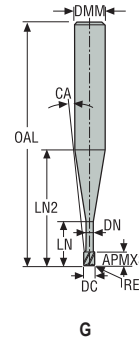

- Tolerances:
- Run-out=<0,005 mm
- DMM= h5
- DC= $\varnothing 0,6$= -0,005/-0,013 mm
- DC= $\geq \varnothing 0,6$ = -0,005/-0,015 mm
- RE= $\pm 0,01$ mm

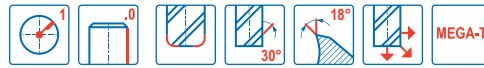

Designation	Item number	Length index	Tool shape	DC	DMM	APMXS	OAL	LN	LN2	DN	RE	CA°	PCEDC	Cylindrical
				mm	mm	mm	mm	mm	mm	mm	mm			
403ML005R005-MEGA-T	02568434	2	G	0,5	3,0	0,5	40,0	1,5	6,7	0,45	0,05	11,0	1	■
403ML008R005-MEGA-T	02568450	2	G	0,8	3,0	0,8	40,0	2,5	7,1	0,75	0,05	9,0	1	■
403ML010R010-MEGA-T	02568456	2	G	1,0	3,0	1,0	40,0	4,0	8,3	0,95	0,1	7,5	1	■
406ML015R010-MEGA-T	02568478	5	G	1,5	6,0	1,5	50,0	5,0	14,0	1,4	0,1	9,5	1	■
404ML020R010-MEGA-T	02577246	5	G	2,0	4,0	2,0	40,0	6,0	10,4	1,9	0,1	6,0	1	■

■ Stocked standard.

Universal

Steel and cast iron

Stainless steel and S-materials

Non ferrous

Hard

Plastic and CFRP

Graphite

X-Heads

Minimaster Plus

Minimaster

Cutting data – JM403/JM404/406 Side milling

SMG		a _p /DC	a _p /DC	f _z					v _c
				0.5	0.8	1	1.5	2	
N1	E	0.500	0.70	0.015	0.024	0.030	0.042	0.050	365 (310 – 420)
		0,500	0,70	0,00060	0,00095	0,0012	0,0017	0,0020	1200 (1100 – 1300)
N2	E	0.500	0.70	0.015	0.024	0.030	0.042	0.050	235 (200 – 270)
		0,500	0,70	0,00060	0,00095	0,0012	0,0017	0,0020	770 (660 – 880)
N3	E	0.500	0.70	0.015	0.024	0.030	0.042	0.050	155 (140 – 180)
		0,500	0,70	0,00060	0,00095	0,0012	0,0017	0,0020	510 (460 – 590)

Cutting data – JM403/JM404/406 Slot milling

SMG		a _p /DC	f _z					v _c
			0.5	0.8	1	1.5	2	
N1	E	0.40	0.015	0.025	0.030	0.044	0.050	315 (270 – 360)
		0,40	0,00060	0,0010	0,0012	0,0017	0,0020	1025 (890 – 1100)
N2	E	0.40	0.015	0.025	0.030	0.044	0.050	200 (170 – 230)
		0,40	0,00060	0,0010	0,0012	0,0017	0,0020	660 (560 – 750)
N3	E	0.40	0.015	0.025	0.030	0.044	0.050	135 (120 – 150)
		0,40	0,00060	0,0010	0,0012	0,0017	0,0020	445 (400 – 490)

For cutting data recalculations, see pages 556 - 563

SMG = Seco material group
Coolant = A=air D=dry E=emulsion M=mist spray
v_c = m/min (sf/min)
f_z = mm (in/tooth)
a_p = mm/DC (in/DC) = factor
a_e = mm/DC (in/DC) = factor
All cutting data are target values

Universal
Steel and cast iron
Stainless steel and S-materials
Non ferrous
Hard
Plastic and cfrp
Graphite
X-Heads
Minimaster Plus
Minimaster

JM413/JM416

Miniature – Aluminium – Ball nose – 2 Flute – Cylindrical

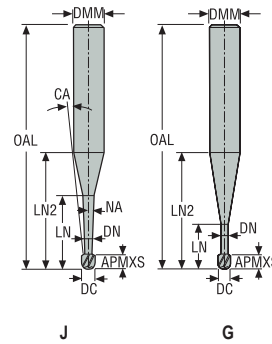

- Tolerances:
- Run-out=<0,005 mm
- DMM=h5
- DC = $\varnothing 0,6 = -0,005/-0,013 \text{ mm}$
- DC = $\geq \varnothing 0,6 = -0,005/-0,015 \text{ mm}</math>$
- RE = $\pm 0,005 \text{ mm}</math>$

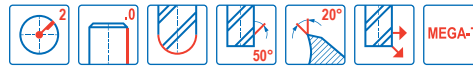

Designation	Item number	Length index	Tool shape	DC	DMM	APMXS	OAL	LN	LN2	DN	RE	NA°	CA°	PCEDC	Cylindrical
				mm	mm	mm	mm	mm	mm	mm	mm	mm	mm		
413ML005TN-MEGA-T	02568709	2	J	0,5	3,0	0,375	40,0	1,5	6,6	0,45	0,25	0,9	11,5	2	■
413L005-MEGA-T	02568711	3	G	0,5	3,0	0,375	40,0	2,5	7,7	0,45	0,25	0,0	10,0	2	■
413L008-MEGA-T	02568727	3	G	0,8	3,0	0,6	40,0	4,0	8,6	0,75	0,4	0,0	8,0	2	■
413L010-MEGA-T	02568736	3	G	1,0	3,0	0,75	40,0	5,0	9,3	0,95	0,5	0,0	7,0	2	■
416L015-MEGA-T	02568772	3	G	1,5	6,0	1,125	50,0	7,5	16,5	1,4	0,75	0,0	8,5	2	■
416L020-MEGA-T	02568779	3	G	2,0	6,0	1,5	50,0	10,0	18,1	1,9	1,0	0,0	7,0	2	■

■ Stocked standard.

Universal

Steel and cast iron

Stainless steel and S-materials

Non ferrous

Hard

Plastic and CFRP

Graphite

X-Heads

Minimaster Plus

Minimaster

Cutting data – JM413/416 Copy milling roughing

SMG		a_p/DC		f_z					v_c
				0,5	0,8	1	1,5	2	
N1	E	0.300	0.30	0.030	0.048	0.060	0.085	0.10	385 (370 — 510)
		0,300	0,30	0,0012	0,0019	0,0024	0,0034	0,0040	1275 (1300 — 1600)
N2	E	0.300	0.30	0.030	0.048	0.060	0.085	0.10	245 (240 — 320)
		0,300	0,30	0,0012	0,0019	0,0024	0,0034	0,0040	800 (790 — 1000)
N3	E	0.300	0.30	0.030	0.048	0.060	0.085	0.10	165 (160 — 210)
		0,300	0,30	0,0012	0,0019	0,0024	0,0034	0,0040	540 (530 — 680)
N11	E	0.300	0.30	0.030	0.048	0.060	0.085	0.10	320 (300 — 430)
		0,300	0,30	0,0012	0,0019	0,0024	0,0034	0,0040	1050 (990 — 1400)
TS1	A	0.300	0.30	0.030	0.048	0.060	0.085	0.10	385 (370 — 510)
		0,300	0,30	0,0012	0,0019	0,0024	0,0034	0,0040	1275 (1300 — 1600)
TP1	A	0.300	0.30	0.030	0.048	0.060	0.085	0.10	385 (370 — 510)
		0,300	0,30	0,0012	0,0019	0,0024	0,0034	0,0040	1275 (1300 — 1600)

For cutting data recalculations, see pages 556 - 563

SMG = Seco material group
 Coolant = A=air D=dry E=emulsion M=mist spray
 $v_c = m/min (sf/min)$
 $f_z = mm (in/tooth)$
 $a_p = mm/DC (in/DC) = factor$
 $a_e = mm/DC (in/DC) = factor$
 All cutting data are target values

Universal
 Steel and cast iron
 Stainless steel and S-materials
 Non ferrous
 Hard
 Plastic and cfrp
 Graphite
 X-Heads
 Minimaster Plus
 Minimaster

Universal
Steel and cast iron
Stainless steel and S-materials
Non ferrous
Hard
Plastic and CFRP
Graphite
X-Heads
Minimaster Plus
Minimaster





























HARD

Seco offers a complete range of high performance solid carbide square shoulder end mills, ballnose cutters and finish end mills for high productivity for hardened steel.

- JHP170, JHF181, JH120, JH130, JH930, JH142, JME142 and JME144 for radius type.
- JH112, JH150, JH160 and JMB112 for ball-nose type.

Tool Selection Hard

							
							
Name		JHP170	JHF181	JH120	JH130	JH930	JH142
Page(s)		369	372	375	377	135, 379	195, 382
Family name		HPM	HFM	HSM/TORNADO	HSM/TORNADO	HSM/TORNADO	HSM/TORNADO
Type of mill							
Shank	Cylindrical	■	■	■	■	■	■
	Weldon	■					
Number of Flutes		3-4	3-4-5	4	5-6, 8	5,6,8	2-4-5-6
ICC			■				
Diameter range	Metric	2-20	1-10	2-16	6-20	6-20	2-12
	Inch						
Length availability		2	1,2,3,4	2	2	2	2,3,6
Operation							
							
							
SMG							
H3		●	●	●	●	●	●
H5		●	●	●	●	●	●
H7		●	●	●	●	●	●
H8		●	●	●	●	●	●
H11		●	●	●	●	●	
H12		●	●	●	●	●	
H21		●	●	●	●	●	●
H31		●	●	●	●	●	●

■ Stock standard □ Weldon available, delivery time is 3 days.
 ● Preferred choice ○ Alternative choice

Universal
 Steel and cast iron
 Stainless steel and S-materials
 Non ferrous
 Hard
 Plastic and CFRP
 Graphite
 X-Heads
 Minimax Plus
 Minimax

- Universal
- Steel and cast iron
- Stainless steel and S-materials
- Non ferrous
- Hard
- Plastic and CFRP
- Graphite
- X-Heads
- Minimaster Plus
- Minimaster

Tool Selection Hard

Name		JH112	JH150	JH160	JME142	JME144	JMB112
Page(s)		200, 385	388	390	392	397	399
Family name		HSM/TORNADO	HSM/TORNADO	HSM/TORNADO	MINI	MINI	MINI
Type of mill							
Shank	Cylindrical	■	■	■	■	■	■
	Weldon						
Number of Flutes		2	4	4	2	4	2
ICC							
Diameter range	Metric	2-12	6-12	3-12	0,2-3,0	1,0-3,0	0,2-3,0
	Inch						
Length availability		1,2,3,4,5,6	2	2	1,2,3,4,5,6	2,3,4	1,2,3,4,5,6
Operation							
SMG							
H3		●	●	●	●	●	●
H5		●	●	●	●	●	●
H7		●	●	●	●	●	●
H8		●	●	●	●	●	●
H11			●	●	●	●	●
H12			●	●	●	●	●
H21		●	●	●	●	●	●
H31		●	●	●	●	●	●

■ Stock standard □ Weldon available, delivery time is 3 days.
 ● Preferred choice ○ Alternative choice

JHP170

High performance – Hardened steel – Square – 3-4 Flutes – Cylindrical – Corner radius or chamfer

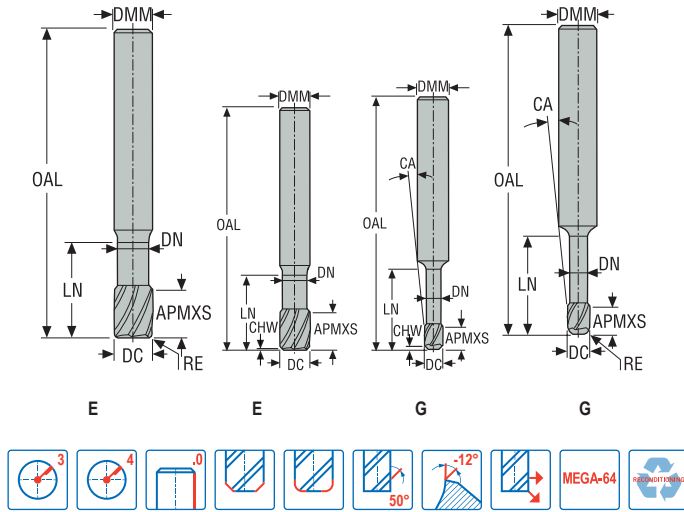

- Tolerances:
- DMM= h5
- DC= -0,02/-0,04 mm
- CHW= $\varnothing 2 - \varnothing 4 = +0,05$ mm
- CHW= $\varnothing 5 - \varnothing 16 = +0,1$ mm
- RE= $\pm 0,05$ mm
- Regrind possible if DC is $\geq \varnothing 6$



Designation	Item number	Length index	Tool shape	DC	DMM	APMXS	OAL	LN	DN	CHW	RE	CA°	PCEDC	Cylindrical
				mm	mm	mm	mm	mm	mm	mm	mm			
170020.0-MEGA-64	02462685	2	G	2,0	6,0	2,0	50,0	4,0	1,9	0,08	-	14,5	3	■
170020R020.0-MEGA-64	02587615	2	G	2,0	6,0	2,0	50,0	4,0	1,9	-	0,2	14,5	3	■
170020R050.0-MEGA-64	02587617	2	G	2,0	6,0	2,0	50,0	4,0	1,9	-	0,5	15,0	3	■
170030.0-MEGA-64	02462686	2	G	3,0	6,0	3,0	50,0	6,0	2,8	0,08	-	9,0	3	■
170030R020.0-MEGA-64	02587618	2	G	3,0	6,0	3,0	50,0	6,0	2,8	-	0,2	9,5	3	■
170030R050.0-MEGA-64	02587619	2	G	3,0	6,0	3,0	50,0	6,0	2,8	-	0,5	9,5	3	■
170040.0-MEGA-64	02462687	2	G	4,0	6,0	4,0	50,0	8,0	3,7	0,1	-	5,5	4	■
170040R020.0-MEGA-64	02587620	2	G	4,0	6,0	4,0	50,0	8,0	3,7	-	0,2	5,5	4	■
170040R050.0-MEGA-64	02587621	2	G	4,0	6,0	4,0	50,0	8,0	3,7	-	0,5	5,5	4	■
170050.0-MEGA-64	02462688	2	G	5,0	6,0	5,0	50,0	10,0	4,6	0,12	-	2,5	4	■
170050R020.0-MEGA-64	02587622	2	G	5,0	6,0	5,0	50,0	10,0	4,6	-	0,2	2,5	4	■
170050R050.0-MEGA-64	02587623	2	G	5,0	6,0	5,0	50,0	10,0	4,6	-	0,5	2,5	4	■
170060.0-MEGA-64	02462689	2	E	6,0	6,0	6,0	50,0	11,5	5,6	0,14	-	-	4	■
170060R020.0-MEGA-64	02587624	2	E	6,0	6,0	6,0	50,0	11,5	5,6	-	0,2	-	4	■
170060R050.0-MEGA-64	02587625	2	E	6,0	6,0	6,0	50,0	11,5	5,6	-	0,5	-	4	■
170080.0-MEGA-64	02462690	2	E	8,0	8,0	8,0	55,0	16,0	7,4	0,16	-	-	4	■
170080R020.0-MEGA-64	02587626	2	E	8,0	8,0	8,0	55,0	16,0	7,4	-	0,2	-	4	■
170080R050.0-MEGA-64	02587627	2	E	8,0	8,0	8,0	55,0	16,0	7,4	-	0,5	-	4	■
170080R100.0-MEGA-64	02587628	2	E	8,0	8,0	8,0	55,0	16,0	7,4	-	1,0	-	4	■
170100.0-MEGA-64	02462691	2	E	10,0	10,0	10,0	65,0	22,0	9,4	0,18	-	-	4	■
170100R050.0-MEGA-64	02587629	2	E	10,0	10,0	10,0	65,0	22,0	9,4	-	0,5	-	4	■
170100R100.0-MEGA-64	02587630	2	E	10,0	10,0	10,0	65,0	22,0	9,4	-	1,0	-	4	■
170120.0-MEGA-64	02462692	2	E	12,0	12,0	12,0	75,0	27,0	11,4	0,2	-	-	4	■
170120R050.0-MEGA-64	02587631	2	E	12,0	12,0	12,0	75,0	27,0	11,4	-	0,5	-	4	■
170120R100.0-MEGA-64	02587632	2	E	12,0	12,0	12,0	75,0	27,0	11,4	-	1,0	-	4	■
170160.0-MEGA-64	02462693	2	E	16,0	16,0	16,0	80,0	29,0	15,4	0,3	-	-	4	■
170160R050.0-MEGA-64	02587633	2	E	16,0	16,0	16,0	80,0	29,0	15,4	-	0,5	-	4	■

■ Stocked standard.

Universal

Steel and cast iron

Stainless steel and S-materials

Non ferrous

Hard

Plastic and CFRP

Graphite

X-Heads

Minimaster Plus

Minimaster

JHP170

High performance – Hardened steel – Square – 3-4 Flutes – Weldon – Corner radius or chamfer

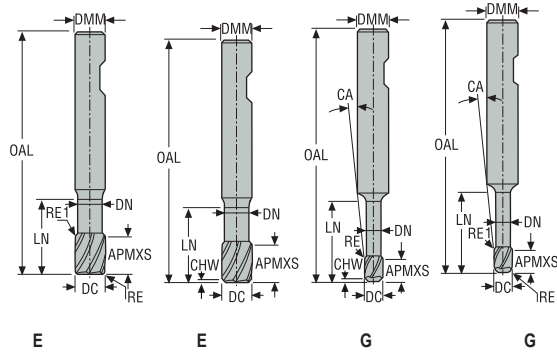

- Tolerances:
- DMM= h5
- DC= -0,02/-0,04 mm
- CHW= Ø2-Ø4=+0,05 mm
- CHW= Ø5-Ø16= +0,1 mm
- RE= ±0,05 mm
- Regrind possible if DC is ≥Ø6

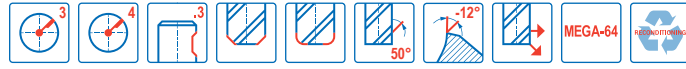

Designation	Item number	Length index	Tool shape	DC	DMM	APMXS	OAL	LN	DN	CHW	RE	CA°	PCEDC	Weldon
				mm	mm	mm	mm	mm	mm	mm	mm			
170020-MEGA-64	02452924	2	G	2,0	6,0	2,0	50,0	4,0	1,9	0,08	-	14,5	3	■
170020R020.0-MEGA-64W	02669319	2	G	2,0	6,0	2,0	50,0	4,0	1,9	-	0,2	-	3	□
170020R050.0-MEGA-64W	02669320	2	G	2,0	6,0	2,0	50,0	4,0	1,9	-	0,5	-	3	□
170030-MEGA-64	02452925	2	G	3,0	6,0	3,0	50,0	6,0	2,8	0,08	-	9,0	3	■
170030R020.0-MEGA-64W	02669321	2	G	3,0	6,0	3,0	50,0	6,0	2,8	-	0,2	-	3	□
170030R050.0-MEGA-64W	02669322	2	G	3,0	6,0	3,0	50,0	6,0	2,8	-	0,5	-	3	□
170040-MEGA-64	02452927	2	G	4,0	6,0	4,0	50,0	8,0	3,7	0,1	-	5,5	4	■
170040R020.0-MEGA-64W	02669323	2	G	4,0	6,0	4,0	50,0	8,0	3,7	-	0,2	-	4	□
170040R050.0-MEGA-64W	02669324	2	G	4,0	6,0	4,0	50,0	8,0	3,7	-	0,5	-	4	□
170050-MEGA-64	02452928	2	G	5,0	6,0	5,0	50,0	10,0	4,6	0,12	-	2,5	4	■
170050R020.0-MEGA-64W	02669325	2	G	5,0	6,0	5,0	50,0	10,0	4,6	-	0,2	-	4	□
170050R050.0-MEGA-64W	02669326	2	G	5,0	6,0	5,0	50,0	10,0	4,6	-	0,5	-	4	□
170060-MEGA-64	02452929	2	E	6,0	6,0	6,0	50,0	11,5	5,6	0,14	-	-	4	■
170060R020.0-MEGA-64W	02669327	2	E	6,0	6,0	6,0	50,0	11,5	5,6	-	0,2	-	4	□
170060R050.0-MEGA-64W	02669328	2	E	6,0	6,0	6,0	50,0	11,5	5,6	-	0,5	-	4	□
170080-MEGA-64	02452930	2	E	8,0	8,0	8,0	55,0	16,0	7,4	0,16	-	-	4	■
170080R020.0-MEGA-64W	02669329	2	E	8,0	8,0	8,0	55,0	16,0	7,4	-	0,2	-	4	□
170080R050.0-MEGA-64W	02669331	2	E	8,0	8,0	8,0	55,0	16,0	7,4	-	0,5	-	4	□
170080R100.0-MEGA-64W	02669332	2	E	8,0	8,0	8,0	55,0	16,0	7,4	-	1,0	-	4	□
170100-MEGA-64	02452931	2	E	10,0	10,0	10,0	65,0	22,0	9,4	0,18	-	-	4	■
170100R050.0-MEGA-64W	02669333	2	E	10,0	10,0	10,0	65,0	22,0	9,4	-	0,5	-	4	□
170100R100.0-MEGA-64W	02669334	2	E	10,0	10,0	10,0	65,0	22,0	9,4	-	1,0	-	4	□
170120-MEGA-64	02452932	2	E	12,0	12,0	12,0	75,0	27,0	11,4	0,2	-	-	4	■
170120R050.0-MEGA-64W	02669335	2	E	12,0	12,0	12,0	75,0	27,0	11,4	-	0,5	-	4	□
170120R100.0-MEGA-64W	02669336	2	E	12,0	12,0	12,0	75,0	27,0	11,4	-	1,0	-	4	□
170160-MEGA-64	02452933	2	E	16,0	16,0	16,0	80,0	29,0	15,4	0,3	-	-	4	■
170160R050.0-MEGA-64W	02669337	2	E	16,0	16,0	16,0	80,0	29,0	15,4	-	0,5	-	4	□
170200R050-MEGA-64	02611637	2	E	20,0	20,0	20,0	100,0	40,0	19,2	-	0,5	-	4	■

■ Stocked standard. □ Weldon available. Delivery time is 3 days.

Cutting data – JHP170 Side milling

SMG		a _e /DC	a _p /DC	f _z										v _c
				2	3	4	5	6	8	10	12	16	20	
H3	M	0.150	0.60	0.0055	0.0085	0.011	0.014	0.017	0.022	0.028	0.034	0.042	0.048	29 (22 – 35)
		0,150	0,60	0,00022	0,00034	0,00044	0,00055	0,00065	0,00085	0,0011	0,0013	0,0017	0,0019	95 (73 – 110)
H5	M	0.300	0.80	0.012	0.018	0.024	0.030	0.036	0.048	0.060	0.070	0.090	0.10	60 (56 – 68)
		0,300	0,80	0,00048	0,00070	0,00095	0,0012	0,0014	0,0019	0,0024	0,0028	0,0036	0,0040	195 (190 – 220)
H7	M	0.150	0.60	0.0055	0.0085	0.011	0.014	0.017	0.022	0.028	0.034	0.042	0.048	29 (22 – 35)
		0,150	0,60	0,00022	0,00034	0,00044	0,00055	0,00065	0,00085	0,0011	0,0013	0,0017	0,0019	95 (73 – 110)
H8	M	0.300	0.80	0.0090	0.014	0.018	0.022	0.028	0.036	0.046	0.055	0.065	0.080	65 (59 – 71)
		0,300	0,80	0,00036	0,00055	0,00070	0,00085	0,0011	0,0014	0,0018	0,0022	0,0026	0,0032	215 (200 – 230)
H11	M	0.300	0.80	0.012	0.018	0.024	0.030	0.036	0.048	0.060	0.070	0.090	0.10	80 (71 – 86)
		0,300	0,80	0,00048	0,00070	0,00095	0,0012	0,0014	0,0019	0,0024	0,0028	0,0036	0,0040	260 (240 – 280)
H12	M	0.300	0.80	0.0090	0.014	0.018	0.022	0.028	0.036	0.046	0.055	0.065	0.080	75 (69 – 83)
		0,300	0,80	0,00036	0,00055	0,00070	0,00085	0,0011	0,0014	0,0018	0,0022	0,0026	0,0032	245 (230 – 270)
H21	M	0.300	0.80	0.0090	0.014	0.018	0.022	0.028	0.036	0.046	0.055	0.065	0.080	65 (59 – 71)
		0,300	0,80	0,00036	0,00055	0,00070	0,00085	0,0011	0,0014	0,0018	0,0022	0,0026	0,0032	215 (200 – 230)
H31	M	0.300	0.80	0.012	0.018	0.024	0.030	0.036	0.048	0.060	0.070	0.090	0.10	60 (56 – 68)
		0,300	0,80	0,00048	0,00070	0,00095	0,0012	0,0014	0,0019	0,0024	0,0028	0,0036	0,0040	195 (190 – 220)

Cutting data – JHP170 Slot milling

SMG		a _p /DC	f _z										v _c
			2	3	4	5	6	8	10	12	16	20	
H3	M	0.40	0.0040	0.0060	0.0080	0.010	0.012	0.016	0.020	0.024	0.030	0.034	20 (16 – 25)
		0,40	0,00016	0,00024	0,00032	0,00040	0,00048	0,00065	0,00080	0,00095	0,0012	0,0013	65 (53 – 82)
H5	M	0.60	0.0080	0.012	0.016	0.020	0.025	0.032	0.040	0.050	0.065	0.080	50 (46 – 55)
		0,60	0,00032	0,00048	0,00065	0,00080	0,0010	0,0013	0,0016	0,0020	0,0026	0,0032	165 (160 – 180)
H7	M	0.40	0.0040	0.0060	0.0080	0.010	0.012	0.016	0.020	0.024	0.030	0.034	20 (16 – 25)
		0,40	0,00016	0,00024	0,00032	0,00040	0,00048	0,00065	0,00080	0,00095	0,0012	0,0013	65 (53 – 82)
H8	M	0.60	0.0080	0.012	0.016	0.020	0.025	0.032	0.040	0.050	0.060	0.070	50 (46 – 55)
		0,60	0,00032	0,00048	0,00065	0,00080	0,0010	0,0013	0,0016	0,0020	0,0024	0,0028	165 (160 – 180)
H11	M	0.60	0.0080	0.012	0.016	0.020	0.025	0.032	0.040	0.050	0.065	0.080	65 (58 – 70)
		0,60	0,00032	0,00048	0,00065	0,00080	0,0010	0,0013	0,0016	0,0020	0,0026	0,0032	215 (200 – 220)
H12	M	0.60	0.0080	0.012	0.016	0.020	0.025	0.032	0.040	0.050	0.060	0.070	60 (53 – 64)
		0,60	0,00032	0,00048	0,00065	0,00080	0,0010	0,0013	0,0016	0,0020	0,0024	0,0028	195 (180 – 200)
H21	M	0.60	0.0080	0.012	0.016	0.020	0.025	0.032	0.040	0.050	0.060	0.070	50 (46 – 55)
		0,60	0,00032	0,00048	0,00065	0,00080	0,0010	0,0013	0,0016	0,0020	0,0024	0,0028	165 (160 – 180)
H31	M	0.60	0.0080	0.012	0.016	0.020	0.025	0.032	0.040	0.050	0.065	0.080	50 (46 – 55)
		0,60	0,00032	0,00048	0,00065	0,00080	0,0010	0,0013	0,0016	0,0020	0,0026	0,0032	165 (160 – 180)

For cutting data recalculations, see pages 556 - 563

SMG = Seco material group

Coolant = A=air D=dry E=emulsion M=mist spray

v_c = m/min (sf/min)

f_z = mm (in/tooth)

a_p = mm/DC (in/DC) = factor

a_e = mm/DC (in/DC) = factor

All cutting data are target values

Universal
Steel and cast iron
Stainless steel and S-materials
Non ferrous
Hard
Plastic and CFRP
Graphite
X-Heads
Minimaster Plus
Minimaster

JHF181

High feed – Hardened steel – Square – 3-5 Flutes – Cylindrical – Corner radius – ICC

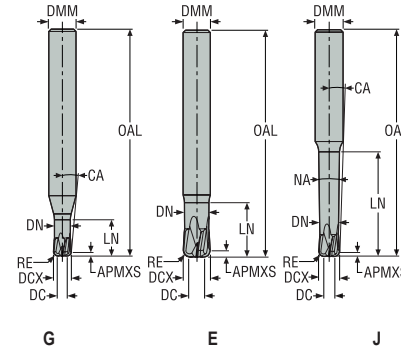

- Tolerances:
- DMM=h5
- DC=-0,02/-0,04 mm
- RE= ±0,01 mm
- Regrind possible if DC is ≥Ø6

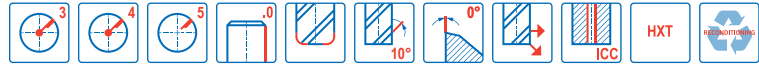

Designation	Item number	Length index	Tool shape	ICC	DCX	DC	DMM	APMXS	OAL	LN	DN	NA	RE	CA°	PCEDC	Cylindrical
JHF181020G1R050.0Z4-HXT	03067297	1	G	-	2,0	1,0	6,0	0,5	50,0	4,0	1,8	0,0	0,5	10,0	4	■
JHF181030G1R075.0Z4-HXT	03067298	1	G	-	3,0	1,5	6,0	0,75	50,0	6,0	2,7	0,0	0,75	7,5	4	■
JHF181040G1R100.0Z4-HXT	03067299	1	G	-	4,0	2,0	6,0	1,0	50,0	8,0	3,6	0,0	1,0	5,0	4	■
JHF181060E1R150.0Z4-HXT	03067300	1	E	-	6,0	3,0	6,0	1,5	50,0	12,0	5,4	0,0	1,5	-	4	■
JHF181080E1R200.0Z4-HXT	03067301	1	E	-	8,0	4,0	8,0	2,0	55,0	16,0	7,3	0,0	2,0	-	4	■
JHF181100E1R200.0Z4-HXT	03067302	1	E	-	10,0	6,0	10,0	2,0	65,0	20,0	9,2	0,0	2,0	-	4	■
JHF181100E1R200.0Z5-HXT	03067303	1	E	-	10,0	6,0	10,0	2,0	65,0	20,0	9,2	0,0	2,0	-	5	■
JHF181120E1R300.0Z4-HXT	03067304	1	E	-	12,0	6,0	12,0	3,0	75,0	24,0	11,0	0,0	3,0	-	4	■
JHF181120E1R300.0Z5-HXT	03067305	1	E	-	12,0	6,0	12,0	3,0	75,0	24,0	11,0	0,0	3,0	-	5	■
JHF181160E1R300.0Z4-HXT	03067306	1	E	-	16,0	10,0	16,0	3,0	80,0	32,0	14,8	0,0	3,0	-	4	■
JHF181020G2R050.0Z4-HXT	03067307	2	G	-	2,0	1,0	6,0	0,5	50,0	8,0	1,8	0,0	0,5	7,5	4	■
JHF181030G2R075.0Z4-HXT	03067308	2	G	-	3,0	1,5	6,0	0,75	50,0	12,0	2,7	0,0	0,75	5,0	4	■
JHF181040G2R100.0Z4-HXT	03067309	2	G	-	4,0	2,0	6,0	1,0	50,0	16,0	3,6	0,0	1,0	3,0	4	■
JHF181060E2R150.0Z4A-HXT	03067311	2	E	■	6,0	3,0	6,0	1,5	65,0	24,0	5,4	0,0	1,5	-	4	■
JHF181060E2R150.0Z4-HXT	03067310	2	E	-	6,0	3,0	6,0	1,5	65,0	24,0	5,4	0,0	1,5	-	4	■
JHF181080E2R200.0Z4A-HXT	03067313	2	E	■	8,0	4,0	8,0	2,0	70,0	32,0	7,3	0,0	2,0	-	4	■
JHF181080E2R200.0Z4-HXT	03067312	2	E	-	8,0	4,0	8,0	2,0	70,0	32,0	7,3	0,0	2,0	-	4	■
JHF181100E2R200.0Z4A-HXT	03067315	2	E	■	10,0	6,0	10,0	2,0	85,0	40,0	9,2	0,0	2,0	-	4	■
JHF181100E2R200.0Z4-HXT	03067314	2	E	-	10,0	6,0	10,0	2,0	85,0	40,0	9,2	0,0	2,0	-	4	■
JHF181120E2R300.0Z4A-HXT	03067317	2	E	■	12,0	6,0	12,0	3,0	100,0	48,0	11,0	0,0	3,0	-	4	■
JHF181120E2R300.0Z4-HXT	03067316	2	E	-	12,0	6,0	12,0	3,0	100,0	48,0	11,0	0,0	3,0	-	4	■
JHF181020J3R050.0Z4-HXT	03067318	3	J	-	2,0	1,0	6,0	0,5	50,0	10,0	1,8	0,9	0,5	6,8	4	■
JHF181030J3R075.0Z4-HXT	03067319	3	J	-	3,0	1,5	6,0	0,75	50,0	15,0	2,7	0,9	0,75	4,4	4	■
JHF181040J3R100.0Z4-HXT	03067320	3	J	-	4,0	2,0	6,0	1,0	60,0	20,0	3,6	0,9	1,0	2,6	4	■
JHF181060J3R150.0Z4-HXT	03067321	3	J	-	6,0	3,0	8,0	1,5	65,0	30,0	5,4	0,9	1,5	1,9	4	■
JHF181080J3R200.0Z4-HXT	03067325	3	J	-	8,0	4,0	10,0	2,0	85,0	40,0	7,3	0,9	2,0	1,5	4	■
JHF181100J3R200.0Z4-HXT	03067327	3	J	-	10,0	6,0	12,0	2,0	100,0	50,0	9,2	0,9	2,0	1,2	4	■
JHF181020J4R050.0Z3-HXT	03067329	4	J	-	2,0	1,0	6,0	0,5	50,0	14,0	1,8	0,9	0,5	5,6	3	■
JHF181030J4R075.0Z3-HXT	03067330	4	J	-	3,0	1,5	6,0	0,75	60,0	21,0	2,7	0,9	0,75	3,4	3	■
JHF181040J4R100.0Z3-HXT	03067331	4	J	-	4,0	2,0	6,0	1,0	65,0	28,0	3,6	0,9	1,0	2,0	3	■
JHF181060J4R150.0Z3-HXT	03067332	4	J	-	6,0	3,0	8,0	1,5	80,0	42,0	5,4	0,9	1,5	1,4	3	■
JHF181080J4R200.0Z3-HXT	03067333	4	J	-	8,0	4,0	10,0	2,0	100,0	56,0	7,3	0,9	2,0	1,1	3	■
JHF181100J4R200.0Z3-HXT	03067334	4	J	-	10,0	6,0	12,0	2,0	125,0	70,0	9,2	0,9	2,0	0,9	3	■

■ Stocked standard.

Cutting data – JHF181 Side milling roughing

SMG		a _e /DCX	a _p /DCX	f _z								v _c
				2	3	4	6	8	10	12	16	
P6	E/M/A	0.30	0.040	0.070	0.10	0.14	0.20	0.28	0.34	0.40	0.55	305 (290 – 320)
		0,30	0,040	0,0028	0,0040	0,0055	0,0080	0,011	0,013	0,016	0,022	1000 (960 – 1000)
P7	E/M/A	0.30	0.040	0.070	0.10	0.14	0.20	0.28	0.34	0.40	0.55	290 (270 – 300)
		0,30	0,040	0,0028	0,0040	0,0055	0,0080	0,011	0,013	0,016	0,022	950 (890 – 980)
P8	E/M/A	0.30	0.040	0.070	0.10	0.14	0.20	0.28	0.34	0.40	0.55	270 (260 – 290)
		0,30	0,040	0,0028	0,0040	0,0055	0,0080	0,011	0,013	0,016	0,022	890 (860 – 950)
P11	E/M/A	0.30	0.040	0.070	0.10	0.14	0.20	0.28	0.34	0.40	0.55	280 (270 – 290)
		0,30	0,040	0,0028	0,0040	0,0055	0,0080	0,011	0,013	0,016	0,022	920 (890 – 950)
K1	E/M/A	0.30	0.040	0.070	0.10	0.14	0.20	0.28	0.34	0.40	0.55	210 (190 – 240)
		0,30	0,040	0,0028	0,0040	0,0055	0,0080	0,011	0,013	0,016	0,022	690 (630 – 780)
K2	E/M/A	0.30	0.040	0.070	0.10	0.14	0.20	0.28	0.34	0.40	0.55	185 (160 – 200)
		0,30	0,040	0,0028	0,0040	0,0055	0,0080	0,011	0,013	0,016	0,022	610 (530 – 650)
K3	E/M/A	0.30	0.040	0.070	0.10	0.14	0.20	0.28	0.34	0.40	0.55	155 (140 – 170)
		0,30	0,040	0,0028	0,0040	0,0055	0,0080	0,011	0,013	0,016	0,022	510 (460 – 550)
K4	E/M/A	0.30	0.040	0.070	0.10	0.14	0.20	0.28	0.34	0.40	0.55	150 (130 – 160)
		0,30	0,040	0,0028	0,0040	0,0055	0,0080	0,011	0,013	0,016	0,022	490 (430 – 520)
K5	E/M/A	0.30	0.040	0.050	0.080	0.10	0.16	0.20	0.26	0.32	0.42	150 (120 – 170)
		0,30	0,040	0,0020	0,0032	0,0040	0,0065	0,0080	0,010	0,013	0,017	490 (460 – 550)
K6	E/M/A	0.30	0.040	0.050	0.080	0.10	0.16	0.20	0.26	0.32	0.42	220 (180 – 260)
		0,30	0,040	0,0020	0,0032	0,0040	0,0065	0,0080	0,010	0,013	0,017	720 (600 – 850)
K7	E/M/A	0.30	0.040	0.050	0.080	0.10	0.16	0.20	0.26	0.32	0.42	190 (160 – 220)
		0,30	0,040	0,0020	0,0032	0,0040	0,0065	0,0080	0,010	0,013	0,017	620 (530 – 720)
S1	E	0.18	0.014	0.025	0.038	0.050	0.075	0.10	0.13	0.15	0.19	60 (40 – 79)
		0,18	0,014	0,0010	0,0015	0,0020	0,0030	0,0040	0,0050	0,0060	0,0075	195 (140 – 250)
S2	E	0.18	0.014	0.025	0.038	0.050	0.075	0.10	0.13	0.15	0.19	48 (33 – 64)
		0,18	0,014	0,0010	0,0015	0,0020	0,0030	0,0040	0,0050	0,0060	0,0075	155 (110 – 200)
S3	E	0.18	0.014	0.024	0.036	0.048	0.070	0.095	0.12	0.14	0.17	42 (28 – 55)
		0,18	0,014	0,00095	0,0014	0,0019	0,0028	0,0038	0,0048	0,0055	0,0065	140 (92 – 180)
S11	E	0.18	0.034	0.036	0.055	0.070	0.11	0.14	0.18	0.22	0.26	200 (180 – 220)
		0,18	0,034	0,0014	0,0022	0,0028	0,0044	0,0055	0,0070	0,0085	0,010	660 (600 – 720)
S12	E	0.18	0.034	0.036	0.055	0.070	0.11	0.14	0.18	0.22	0.26	155 (140 – 170)
		0,18	0,034	0,0014	0,0022	0,0028	0,0044	0,0055	0,0070	0,0085	0,010	510 (460 – 550)
S13	E	0.18	0.034	0.032	0.046	0.065	0.095	0.13	0.16	0.18	0.24	125 (110 – 130)
		0,18	0,034	0,0013	0,0018	0,0026	0,0038	0,0050	0,0065	0,0070	0,0095	410 (370 – 420)
H3	M/A/D	0.30	0.020	0.050	0.080	0.10	0.16	0.20	0.26	0.32	0.42	85 (73 – 96)
		0,30	0,020	0,0020	0,0032	0,0040	0,0065	0,0080	0,010	0,013	0,017	280 (240 – 310)
H5	M/A/D	0.30	0.040	0.070	0.10	0.14	0.20	0.28	0.34	0.40	0.55	165 (150 – 180)
		0,30	0,040	0,0028	0,0040	0,0055	0,0080	0,011	0,013	0,016	0,022	540 (500 – 590)
H7	M/A/D	0.30	0.020	0.050	0.080	0.10	0.16	0.20	0.26	0.32	0.42	85 (73 – 96)
		0,30	0,020	0,0020	0,0032	0,0040	0,0065	0,0080	0,010	0,013	0,017	280 (240 – 310)
H8	M/A/D	0.30	0.040	0.070	0.10	0.14	0.20	0.28	0.34	0.40	0.55	165 (150 – 180)
		0,30	0,040	0,0028	0,0040	0,0055	0,0080	0,011	0,013	0,016	0,022	540 (500 – 590)
H11	M/A/D	0.30	0.040	0.070	0.10	0.14	0.20	0.28	0.34	0.40	0.55	210 (190 – 230)
		0,30	0,040	0,0028	0,0040	0,0055	0,0080	0,011	0,013	0,016	0,022	690 (630 – 750)
H12	M/A/D	0.30	0.040	0.070	0.10	0.14	0.20	0.28	0.34	0.40	0.55	190 (180 – 210)
		0,30	0,040	0,0028	0,0040	0,0055	0,0080	0,011	0,013	0,016	0,022	620 (600 – 680)
H21	M/A/D	0.30	0.040	0.070	0.10	0.14	0.20	0.28	0.34	0.40	0.55	165 (150 – 180)
		0,30	0,040	0,0028	0,0040	0,0055	0,0080	0,011	0,013	0,016	0,022	540 (500 – 590)
H31	M/A/D	0.30	0.040	0.070	0.10	0.14	0.20	0.28	0.34	0.40	0.55	125 (120 – 130)
		0,30	0,040	0,0028	0,0040	0,0055	0,0080	0,011	0,013	0,016	0,022	410 (400 – 420)

For cutting data recalculations, see pages 556 - 563

SMG = Seco material group
 Coolant = A=air D=dry E=emulsion M=mist spray
 v_c = m/min (sf/min)
 f_z = mm (in/tooth)
 a_p = mm/DC (in/DC) = factor
 a_e = mm/DC (in/DC) = factor
 All cutting data are target values

Universal
 Steel and cast iron
 Stainless steel and S-materials
 Non ferrous
 Hard
 Plastic and CFRP
 Graphite
 X-Heads
 Minmaster Plus
 Minmaster

Cutting data – JHF181 Slot milling

SMG		a _p /DCX	f _z								v _c
			2	3	4	6	8	10	12	16	
P6	E/M/A	0.040	0.042	0.065	0.085	0.13	0.17	0.20	0.25	0.34	270 (260 – 280)
		0,040	0,0017	0,0026	0,0034	0,0050	0,0065	0,0080	0,010	0,013	890 (860 – 910)
P7	E/M/A	0.040	0.042	0.065	0.085	0.13	0.17	0.20	0.25	0.34	255 (240 – 270)
		0,040	0,0017	0,0026	0,0034	0,0050	0,0065	0,0080	0,010	0,013	840 (790 – 880)
P8	E/M/A	0.040	0.042	0.065	0.085	0.13	0.17	0.20	0.25	0.34	240 (230 – 250)
		0,040	0,0017	0,0026	0,0034	0,0050	0,0065	0,0080	0,010	0,013	790 (760 – 820)
P11	E/M/A	0.040	0.042	0.065	0.085	0.13	0.17	0.20	0.25	0.34	250 (240 – 260)
		0,040	0,0017	0,0026	0,0034	0,0050	0,0065	0,0080	0,010	0,013	820 (790 – 850)
K1	E/M/A	0.040	0.042	0.065	0.085	0.13	0.17	0.20	0.25	0.34	185 (170 – 210)
		0,040	0,0017	0,0026	0,0034	0,0050	0,0065	0,0080	0,010	0,013	610 (560 – 680)
K2	E/M/A	0.040	0.042	0.065	0.085	0.13	0.17	0.20	0.25	0.34	160 (140 – 180)
		0,040	0,0017	0,0026	0,0034	0,0050	0,0065	0,0080	0,010	0,013	520 (460 – 590)
K3	E/M/A	0.040	0.042	0.065	0.085	0.13	0.17	0.20	0.25	0.34	135 (120 – 150)
		0,040	0,0017	0,0026	0,0034	0,0050	0,0065	0,0080	0,010	0,013	445 (400 – 490)
K4	E/M/A	0.040	0.042	0.065	0.085	0.13	0.17	0.20	0.25	0.34	130 (120 – 140)
		0,040	0,0017	0,0026	0,0034	0,0050	0,0065	0,0080	0,010	0,013	425 (400 – 450)
K5	E/M/A	0.040	0.030	0.046	0.060	0.090	0.12	0.15	0.18	0.24	130 (110 – 150)
		0,040	0,0012	0,0018	0,0024	0,0036	0,0048	0,0060	0,0070	0,0095	640 (530 – 750)
K6	E/M/A	0.040	0.030	0.046	0.060	0.090	0.12	0.15	0.18	0.24	195 (160 – 230)
		0,040	0,0012	0,0018	0,0024	0,0036	0,0048	0,0060	0,0070	0,0095	640 (530 – 750)
K7	E/M/A	0.040	0.030	0.046	0.060	0.090	0.12	0.15	0.18	0.24	170 (140 – 200)
		0,040	0,0012	0,0018	0,0024	0,0036	0,0048	0,0060	0,0070	0,0095	560 (460 – 650)
S1	E	0.014	0.0090	0.014	0.018	0.028	0.036	0.046	0.055	0.070	48 (33 – 64)
		0,014	0,00036	0,00055	0,00070	0,0011	0,0014	0,0018	0,0022	0,0028	155 (110 – 200)
S2	E	0.014	0.0090	0.014	0.018	0.028	0.036	0.046	0.055	0.070	39 (26 – 51)
		0,014	0,00036	0,00055	0,00070	0,0011	0,0014	0,0018	0,0022	0,0028	130 (86 – 160)
S3	E	0.014	0.0090	0.014	0.018	0.028	0.036	0.046	0.055	0.070	33 (23 – 44)
		0,014	0,00036	0,00055	0,00070	0,0011	0,0014	0,0018	0,0022	0,0028	110 (76 – 140)
S11	E	0.034	0.011	0.017	0.022	0.034	0.046	0.055	0.070	0.090	170 (150 – 190)
		0,034	0,00044	0,00065	0,00085	0,0013	0,0018	0,0022	0,0028	0,0036	560 (500 – 620)
S12	E	0.034	0.011	0.017	0.022	0.034	0.046	0.055	0.070	0.090	130 (120 – 140)
		0,034	0,00044	0,00065	0,00085	0,0013	0,0018	0,0022	0,0028	0,0036	425 (400 – 450)
S13	E	0.034	0.011	0.017	0.022	0.034	0.046	0.055	0.070	0.090	100 (89 – 110)
		0,034	0,00044	0,00065	0,00085	0,0013	0,0018	0,0022	0,0028	0,0036	330 (300 – 360)
H3	M/A/D	0.020	0.034	0.050	0.070	0.10	0.14	0.17	0.20	0.28	75 (63 – 83)
		0,020	0,0013	0,0020	0,0028	0,0040	0,0055	0,0065	0,0080	0,011	245 (210 – 270)
H5	M/A/D	0.040	0.042	0.065	0.085	0.13	0.17	0.20	0.25	0.34	145 (130 – 160)
		0,040	0,0017	0,0026	0,0034	0,0050	0,0065	0,0080	0,010	0,013	475 (430 – 520)
H7	M/A/D	0.020	0.034	0.050	0.070	0.10	0.14	0.17	0.20	0.28	75 (63 – 83)
		0,020	0,0013	0,0020	0,0028	0,0040	0,0055	0,0065	0,0080	0,011	245 (210 – 270)
H8	M/A/D	0.040	0.042	0.065	0.085	0.13	0.17	0.20	0.25	0.34	145 (130 – 160)
		0,040	0,0017	0,0026	0,0034	0,0050	0,0065	0,0080	0,010	0,013	475 (430 – 520)
H11	M/A/D	0.040	0.042	0.065	0.085	0.13	0.17	0.20	0.25	0.34	185 (170 – 200)
		0,040	0,0017	0,0026	0,0034	0,0050	0,0065	0,0080	0,010	0,013	610 (560 – 650)
H12	M/A/D	0.040	0.042	0.065	0.085	0.13	0.17	0.20	0.25	0.34	170 (160 – 180)
		0,040	0,0017	0,0026	0,0034	0,0050	0,0065	0,0080	0,010	0,013	560 (530 – 590)
H21	M/A/D	0.040	0.042	0.065	0.085	0.13	0.17	0.20	0.25	0.34	145 (130 – 160)
		0,040	0,0017	0,0026	0,0034	0,0050	0,0065	0,0080	0,010	0,013	475 (430 – 520)
H31	M/A/D	0.040	0.042	0.065	0.085	0.13	0.17	0.20	0.25	0.34	110 (98 – 120)
		0,040	0,0017	0,0026	0,0034	0,0050	0,0065	0,0080	0,010	0,013	360 (330 – 390)

For cutting data recalculations, see pages 556 - 563

SMG = Seco material group
Coolant = A=air D=dry E=emulsion M=mist spray
v_c = m/min (sf/min)
f_z = mm (in/tooth)
a_p = mm/DC (in/DC) = factor
a_e = mm/DC (in/DC) = factor
All cutting data are target values

JH120

High speed – Hardened steel – Square – 4 Flutes – Cylindrical – Corner radius

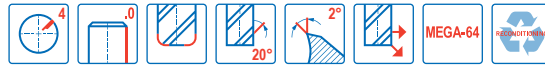
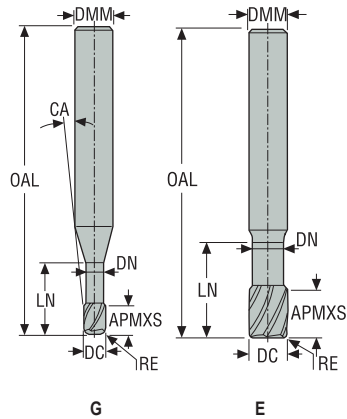

- Tolerances:
- DMM=h5
- DC=-0,02/-0,03 mm
- RE= ±0,01 mm
- Regrind possible if DC is ≥Ø6

Designation	Item number	Length index	Tool shape	DC	DMM	APMXS	OAL	LN	DN	RE	CA°	PCEDC	Cylindrical
				mm	mm	mm	mm	mm	mm	mm	mm	mm	mm
120020-MEGA-64	00019437	2	G	2,0	6,0	2,5	50,0	5,0	1,9	0,2	10,5	4	■
120025-MEGA-64	00019448	2	G	2,5	6,0	3,0	50,0	6,0	2,4	0,25	8,5	4	■
120030-MEGA-64	00019450	2	G	3,0	6,0	4,0	50,0	7,0	2,8	0,3	7,0	4	■
120035-MEGA-64	00019460	2	G	3,5	6,0	4,5	50,0	8,0	3,2	0,35	5,5	4	■
120040-MEGA-64	00019462	2	G	4,0	6,0	5,0	50,0	9,0	3,7	0,4	4,5	4	■
120050-MEGA-64	00019476	2	G	5,0	6,0	6,0	50,0	12,0	4,6	0,5	2,5	4	■
120060-MEGA-64	00019479	2	E	6,0	6,0	7,0	55,0	14,0	5,6	0,6	-	4	■
120080-MEGA-64	00019481	2	E	8,0	8,0	10,0	60,0	18,0	7,4	0,8	-	4	■
120100-MEGA-64	00019494	2	E	10,0	10,0	12,0	70,0	25,0	9,4	1,0	-	4	■
120120-MEGA-64	00019501	2	E	12,0	12,0	15,0	80,0	30,0	11,4	1,2	-	4	■
120160-MEGA-64	00019503	2	E	16,0	16,0	18,0	90,0	35,0	15,4	1,6	-	4	■

■ Stocked standard.

Universal

Steel and cast iron

Stainless steel and S-materials

Non ferrous

Hard

Plastic and CFRP

Graphite

X-Heads

Minimaster Plus

Minimaster

Universal
Steel and cast iron
Stainless steel and S-materials

Cutting data – JH120 Side milling

SMG		a _e /DC	a _p /DC	f _z											v _c
				2	2.5	3	3.5	4	5	6	8	10	12	16	
H3	M	0.0150	0.50	0.0095	0.012	0.014	0.016	0.019	0.024	0.028	0.038	0.048	0.055	0.070	90 (57 – 130)
		0,0150	0,50	0,00038	0,00048	0,00055	0,00065	0,00075	0,00095	0,0011	0,0015	0,0019	0,0022	0,0028	295 (190 – 420)
H5	M	0.0300	1.0	0.012	0.015	0.018	0.020	0.024	0.030	0.036	0.048	0.060	0.070	0.095	215 (180 – 250)
		0,0300	1,0	0,00048	0,00060	0,00070	0,00080	0,00095	0,0012	0,0014	0,0019	0,0024	0,0028	0,0038	710 (600 – 820)
H7	M	0.0150	0.50	0.0095	0.012	0.014	0.016	0.019	0.024	0.028	0.038	0.048	0.055	0.070	90 (57 – 130)
		0,0150	0,50	0,00038	0,00048	0,00055	0,00065	0,00075	0,00095	0,0011	0,0015	0,0019	0,0022	0,0028	295 (190 – 420)
H8	M	0.0300	1.0	0.012	0.015	0.018	0.020	0.024	0.030	0.036	0.048	0.060	0.070	0.095	215 (180 – 250)
		0,0300	1,0	0,00048	0,00060	0,00070	0,00080	0,00095	0,0012	0,0014	0,0019	0,0024	0,0028	0,0038	710 (600 – 820)
H11	M	0.0300	1.0	0.012	0.015	0.018	0.020	0.024	0.030	0.036	0.048	0.060	0.070	0.095	275 (230 – 320)
		0,0300	1,0	0,00048	0,00060	0,00070	0,00080	0,00095	0,0012	0,0014	0,0019	0,0024	0,0028	0,0038	900 (760 – 1000)
H12	M	0.0300	1.0	0.012	0.015	0.018	0.020	0.024	0.030	0.036	0.048	0.060	0.070	0.095	250 (210 – 290)
		0,0300	1,0	0,00048	0,00060	0,00070	0,00080	0,00095	0,0012	0,0014	0,0019	0,0024	0,0028	0,0038	820 (690 – 950)
H21	M	0.0300	1.0	0.012	0.015	0.018	0.020	0.024	0.030	0.036	0.048	0.060	0.070	0.095	215 (180 – 250)
		0,0300	1,0	0,00048	0,00060	0,00070	0,00080	0,00095	0,0012	0,0014	0,0019	0,0024	0,0028	0,0038	710 (600 – 820)
H31	M	0.0300	1.0	0.012	0.015	0.018	0.020	0.024	0.030	0.036	0.048	0.060	0.070	0.095	135 (120 – 150)
		0,0300	1,0	0,00048	0,00060	0,00070	0,00080	0,00095	0,0012	0,0014	0,0019	0,0024	0,0028	0,0038	445 (400 – 490)

Non ferrous
Hard
Plastic and CFRP

Cutting data – JH120 Slot milling

SMG		a _p /DC	f _z											v _c
			2	2.5	3	3.5	4	5	6	8	10	12	16	
H3	M	0.050	0.0050	0.0065	0.0075	0.0090	0.010	0.013	0.015	0.020	0.025	0.030	0.038	55 (34 – 78)
		0,050	0,00020	0,00026	0,00030	0,00036	0,00040	0,00050	0,00060	0,00080	0,0010	0,0012	0,0015	180 (120 – 250)
H5	M	0.18	0.0080	0.010	0.012	0.014	0.016	0.020	0.024	0.032	0.040	0.048	0.060	120 (98 – 140)
		0,18	0,00032	0,00040	0,00048	0,00055	0,00065	0,00080	0,00095	0,0013	0,0016	0,0019	0,0024	395 (330 – 450)
H7	M	0.050	0.0050	0.0065	0.0075	0.0090	0.010	0.013	0.015	0.020	0.025	0.030	0.038	55 (34 – 78)
		0,050	0,00020	0,00026	0,00030	0,00036	0,00040	0,00050	0,00060	0,00080	0,0010	0,0012	0,0015	180 (120 – 250)
H8	M	0.18	0.0060	0.0075	0.0090	0.011	0.012	0.015	0.018	0.025	0.030	0.036	0.044	125 (110 – 140)
		0,18	0,00024	0,00030	0,00036	0,00044	0,00048	0,00060	0,00070	0,0010	0,0012	0,0014	0,0017	410 (370 – 450)
H11	M	0.18	0.0080	0.010	0.012	0.014	0.016	0.020	0.024	0.032	0.040	0.048	0.060	150 (130 – 170)
		0,18	0,00032	0,00040	0,00048	0,00055	0,00065	0,00080	0,00095	0,0013	0,0016	0,0019	0,0024	490 (430 – 550)
H12	M	0.18	0.0060	0.0075	0.0090	0.011	0.012	0.015	0.018	0.025	0.030	0.036	0.044	145 (120 – 170)
		0,18	0,00024	0,00030	0,00036	0,00044	0,00048	0,00060	0,00070	0,0010	0,0012	0,0014	0,0017	475 (400 – 550)
H21	M	0.18	0.0060	0.0075	0.0090	0.011	0.012	0.015	0.018	0.025	0.030	0.036	0.044	125 (110 – 140)
		0,18	0,00024	0,00030	0,00036	0,00044	0,00048	0,00060	0,00070	0,0010	0,0012	0,0014	0,0017	410 (370 – 450)
H31	M	0.18	0.0055	0.0065	0.0080	0.0090	0.011	0.013	0.016	0.022	0.026	0.032	0.038	80 (70 – 92)
		0,18	0,00022	0,00026	0,00032	0,00036	0,00044	0,00050	0,00065	0,00085	0,0010	0,0013	0,0015	260 (230 – 300)

For cutting data recalculations, see pages 556 - 563

SMG = Seco material group
Coolant = A=air D=dry E=emulsion M=mist spray
v_c = m/min (sf/min)
f_z = mm (in/tooth)
a_p = mm/DC (in/DC) = factor
a_e = mm/DC (in/DC) = factor
All cutting data are target values

JH130

High speed – Hardened steel – Square – 5-8 Flutes – Cylindrical – Corner radius

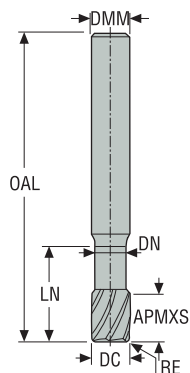

E



- Tolerances:
- DMM=h5
- DC=-0,02/-0,04 mm
- RE= ±0,05 mm
- Re grind possible

Designation	Item number	Length index	Tool shape	DC	DMM	APMXS	OAL	LN	DN	RE	PCEDC	Cylindrical
				mm	mm	mm	mm	mm	mm	mm		
130060-MEGA-64	00019504	2	E	6,0	6,0	6,0	55,0	12,0	5,6	0,2	5	■
130080-MEGA-64	00019507	2	E	8,0	8,0	8,0	60,0	16,0	7,4	0,2	5	■
130100-MEGA-64	00019511	2	E	10,0	10,0	10,0	70,0	20,0	9,4	0,3	6	■
130120-MEGA-64	00019512	2	E	12,0	12,0	12,0	80,0	24,0	11,4	0,5	6	■
130160-MEGA-64	00019514	2	E	16,0	16,0	16,0	90,0	30,0	15,4	0,5	8	■
130200-MEGA-64	00019542	2	E	20,0	20,0	20,0	100,0	35,0	19,2	0,5	8	■

■ Stocked standard.

- Universal
- Steel and cast iron
- Stainless steel and S-materials
- Non ferrous
- Hard
- Plastic and CFRP
- Graphite
- X-Heads
- Minimaster Plus
- Minimaster

Cutting data – JH130 Side milling finishing

SMG		a _p /DC	a _r /DC	f _z						v _c
				6	8	10	12	16	20	
H3	M	0.0300	0.50	0.013	0.018	0.022	0.026	0.032	0.038	85 (73 – 93)
		0,0300	0,50	0,00050	0,00070	0,00085	0,0010	0,0013	0,0015	280 (240 – 300)
H5	M	0.0300	1.0	0.032	0.042	0.050	0.060	0.075	0.090	255 (240 – 270)
		0,0300	1,0	0,0013	0,0017	0,0020	0,0024	0,0030	0,0036	840 (790 – 880)
H7	M	0.0300	0.50	0.013	0.018	0.022	0.026	0.032	0.038	85 (73 – 93)
		0,0300	0,50	0,00050	0,00070	0,00085	0,0010	0,0013	0,0015	280 (240 – 300)
H8	M	0.0300	1.0	0.024	0.032	0.040	0.046	0.060	0.065	260 (240 – 270)
		0,0300	1,0	0,00095	0,0013	0,0016	0,0018	0,0024	0,0026	850 (790 – 880)
H11	M	0.0300	1.0	0.032	0.042	0.050	0.060	0.075	0.090	320 (300 – 340)
		0,0300	1,0	0,0013	0,0017	0,0020	0,0024	0,0030	0,0036	1050 (990 – 1100)
H12	M	0.0300	1.0	0.024	0.032	0.040	0.046	0.060	0.065	300 (280 – 320)
		0,0300	1,0	0,00095	0,0013	0,0016	0,0018	0,0024	0,0026	980 (920 – 1000)
H21	M	0.0300	1.0	0.024	0.032	0.040	0.046	0.060	0.065	260 (240 – 270)
		0,0300	1,0	0,00095	0,0013	0,0016	0,0018	0,0024	0,0026	850 (790 – 880)
H31	M	0.0300	1.0	0.030	0.040	0.050	0.060	0.075	0.085	155 (140 – 170)
		0,0300	1,0	0,0012	0,0016	0,0020	0,0024	0,0030	0,0034	510 (460 – 550)

Cutting data – JH130 Side milling roughing

SMG		a _p /DC	a _r /DC	f _z						v _c
				6	8	10	12	16	20	
H3	M	0.0300	0.50	0.013	0.018	0.022	0.026	0.032	0.038	85 (73 – 93)
		0,0300	0,50	0,00050	0,00070	0,00085	0,0010	0,0013	0,0015	280 (240 – 300)
H5	M	0.0300	1.0	0.032	0.042	0.050	0.060	0.075	0.090	255 (240 – 270)
		0,0300	1,0	0,0013	0,0017	0,0020	0,0024	0,0030	0,0036	840 (790 – 880)
H7	M	0.0300	0.50	0.013	0.018	0.022	0.026	0.032	0.038	85 (73 – 93)
		0,0300	0,50	0,00050	0,00070	0,00085	0,0010	0,0013	0,0015	280 (240 – 300)
H8	M	0.0300	1.0	0.024	0.032	0.040	0.046	0.060	0.065	260 (240 – 270)
		0,0300	1,0	0,00095	0,0013	0,0016	0,0018	0,0024	0,0026	850 (790 – 880)
H11	M	0.0300	1.0	0.032	0.042	0.050	0.060	0.075	0.090	320 (300 – 340)
		0,0300	1,0	0,0013	0,0017	0,0020	0,0024	0,0030	0,0036	1050 (990 – 1100)
H12	M	0.0300	1.0	0.024	0.032	0.040	0.046	0.060	0.065	300 (280 – 320)
		0,0300	1,0	0,00095	0,0013	0,0016	0,0018	0,0024	0,0026	980 (920 – 1000)
H21	M	0.0300	1.0	0.024	0.032	0.040	0.046	0.060	0.065	260 (240 – 270)
		0,0300	1,0	0,00095	0,0013	0,0016	0,0018	0,0024	0,0026	850 (790 – 880)
H31	M	0.0300	1.0	0.030	0.040	0.050	0.060	0.075	0.085	155 (140 – 170)
		0,0300	1,0	0,0012	0,0016	0,0020	0,0024	0,0030	0,0034	510 (460 – 550)

For cutting data recalculations, see pages 556 - 563

SMG = Seco material group
Coolant = A=air D=dry E=emulsion M=mist spray
v_c = m/min (sf/min)
f_z = mm (in/tooth)
a_p = mm/DC (in/DC) = factor
a_r = mm/DC (in/DC) = factor
All cutting data are target values

JH930

High speed – Universal – Square – 5-8 Flutes – Cylindrical – Corner radius

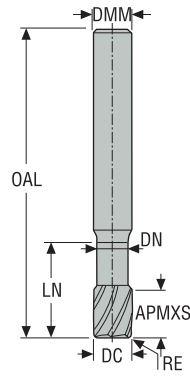

E

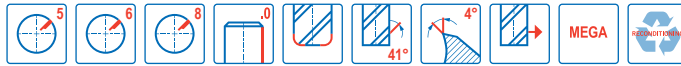

- Tolerances:
- DMM=h5
- DC=-0,02/-0,04 mm
- RE= ±0,05 mm
- Regrind possible



Designation	Item number	Length index	Tool shape	DC	DMM	APMXS	OAL	LN	DN	RE	PCEDC	Cylindrical
				mm	mm	mm	mm	mm	mm	mm		
930060R020-MEGA	00022026	2	E	6,0	6,0	9,0	55,0	15,0	5,6	0,2	5	■
930060R050-MEGA	00022027	2	E	6,0	6,0	9,0	55,0	15,0	5,6	0,5	5	■
930080R020-MEGA	00022028	2	E	8,0	8,0	12,0	60,0	18,0	7,4	0,2	5	■
930080R050-MEGA	00022029	2	E	8,0	8,0	12,0	60,0	18,0	7,4	0,5	5	■
930100R030-MEGA	00022030	2	E	10,0	10,0	15,0	70,0	25,0	9,4	0,3	6	■
930100R100-MEGA	00022031	2	E	10,0	10,0	15,0	70,0	25,0	9,4	1,0	6	■
930120R050-MEGA	00022033	2	E	12,0	12,0	18,0	80,0	30,0	11,4	0,5	6	■
930120R100-MEGA	00022034	2	E	12,0	12,0	18,0	80,0	30,0	11,4	1,0	6	■
930160R050-MEGA	00022035	2	E	16,0	16,0	24,0	90,0	35,0	15,4	0,5	8	■
930160R100-MEGA	00022040	2	E	16,0	16,0	24,0	90,0	35,0	15,4	1,0	8	■
930200R050-MEGA	00022044	2	E	20,0	20,0	30,0	100,0	38,0	19,2	0,5	8	■

■ Stocked standard.

Universal

Steel and cast iron

Stainless steel and S-materials

Non ferrous

Hard

Plastic and CFRP

Graphite

X-Heads

Minimaster Plus

Minimaster

Cutting data – JH930 Side milling

SMG		a _p /DC	a _e /DC	f _z						v _c
				6	8	10	12	16	20	
P1	M/E/A	0.0400 0,0400	0.70 0,70	0.065 0,0026	0.085 0,0034	0.11 0,0044	0.13 0,0050	0.16 0,0065	0.18 0,0070	440 (370 – 490) 1450 (1300 – 1600)
P2	M/E/A	0.0400 0,0400	0.70 0,70	0.065 0,0026	0.090 0,0036	0.11 0,0044	0.13 0,0050	0.16 0,0065	0.19 0,0075	430 (360 – 480) 1400 (1200 – 1500)
P3	M/E/A	0.0400 0,0400	0.70 0,70	0.060 0,0024	0.085 0,0034	0.10 0,0040	0.12 0,0048	0.15 0,0060	0.18 0,0070	375 (320 – 420) 1225 (1100 – 1300)
P4	M/E/A	0.0400 0,0400	0.70 0,70	0.060 0,0024	0.080 0,0032	0.10 0,0040	0.12 0,0048	0.15 0,0060	0.17 0,0065	330 (280 – 370) 1075 (920 – 1200)
P5	M/E/A	0.0400 0,0400	0.70 0,70	0.060 0,0024	0.080 0,0032	0.10 0,0040	0.12 0,0048	0.15 0,0060	0.17 0,0065	315 (270 – 350) 1025 (890 – 1100)
P6	M/E/A	0.0400 0,0400	0.70 0,70	0.060 0,0024	0.080 0,0032	0.10 0,0040	0.12 0,0048	0.15 0,0060	0.17 0,0065	355 (300 – 390) 1175 (990 – 1200)
P7	M/E/A	0.0400 0,0400	0.70 0,70	0.060 0,0024	0.080 0,0032	0.10 0,0040	0.12 0,0048	0.15 0,0060	0.17 0,0065	335 (280 – 370) 1100 (920 – 1200)
P8	M/E/A	0.0400 0,0400	0.70 0,70	0.060 0,0024	0.085 0,0034	0.10 0,0040	0.12 0,0048	0.15 0,0060	0.18 0,0070	315 (270 – 350) 1025 (890 – 1100)
P11	M/E/A	0.0400 0,0400	0.70 0,70	0.060 0,0024	0.080 0,0032	0.10 0,0040	0.12 0,0048	0.15 0,0060	0.17 0,0065	325 (280 – 360) 1075 (920 – 1100)
P12	M/E/A	0.0400 0,0400	0.70 0,70	0.040 0,0016	0.055 0,0022	0.070 0,0028	0.080 0,0032	0.10 0,0040	0.11 0,0044	200 (170 – 220) 660 (560 – 720)
K1	E/M/A	0.0400 0,0400	0.70 0,70	0.060 0,0024	0.080 0,0032	0.10 0,0040	0.12 0,0048	0.15 0,0060	0.17 0,0065	255 (210 – 300) 840 (690 – 980)
K2	E/M/A	0.0400 0,0400	0.70 0,70	0.055 0,0022	0.075 0,0030	0.090 0,0036	0.11 0,0044	0.13 0,0050	0.15 0,0060	225 (180 – 260) 740 (600 – 850)
K3	E/M/A	0.0400 0,0400	0.70 0,70	0.055 0,0022	0.075 0,0030	0.090 0,0036	0.11 0,0044	0.13 0,0050	0.15 0,0060	190 (160 – 220) 620 (530 – 720)
K4	E/M/A	0.0400 0,0400	0.70 0,70	0.055 0,0022	0.075 0,0030	0.090 0,0036	0.11 0,0044	0.13 0,0050	0.15 0,0060	180 (150 – 210) 590 (500 – 680)
K5	E/M/A	0.0300 0,0300	0.50 0,50	0.060 0,0024	0.080 0,0032	0.10 0,0040	0.12 0,0048	0.15 0,0060	0.17 0,0065	205 (160 – 250) 670 (530 – 820)
K6	E/M/A	0.0300 0,0300	0.50 0,50	0.065 0,0026	0.090 0,0036	0.11 0,0044	0.13 0,0050	0.16 0,0065	0.19 0,0075	300 (230 – 370) 980 (760 – 1200)
K7	E/M/A	0.0300 0,0300	0.50 0,50	0.060 0,0024	0.080 0,0032	0.10 0,0040	0.12 0,0048	0.15 0,0060	0.17 0,0065	260 (200 – 320) 850 (660 – 1000)
S1	E/M/A	0.0300 0,0300	0.44 0,44	0.055 0,0022	0.070 0,0028	0.090 0,0036	0.11 0,0044	0.13 0,0050	0.15 0,0060	80 (62 – 100) 260 (210 – 320)
S2	E/M/A	0.0300 0,0300	0.44 0,44	0.055 0,0022	0.070 0,0028	0.090 0,0036	0.11 0,0044	0.13 0,0050	0.15 0,0060	65 (50 – 82) 215 (170 – 260)
S3	E/M/A	0.0200 0,0200	0.70 0,70	0.055 0,0022	0.070 0,0028	0.090 0,0036	0.11 0,0044	0.13 0,0050	0.15 0,0060	41 (31 – 50) 135 (110 – 160)
S11	E/M/A	0.0400 0,0400	0.70 0,70	0.060 0,0024	0.080 0,0032	0.10 0,0040	0.12 0,0048	0.15 0,0060	0.17 0,0065	160 (140 – 180) 520 (460 – 590)
S12	E/M/A	0.0400 0,0400	0.70 0,70	0.060 0,0024	0.080 0,0032	0.10 0,0040	0.12 0,0048	0.15 0,0060	0.17 0,0065	120 (110 – 140) 395 (370 – 450)
S13	E/M/A	0.0400 0,0400	0.70 0,70	0.050 0,0020	0.070 0,0028	0.085 0,0034	0.10 0,0040	0.13 0,0050	0.15 0,0060	95 (81 – 110) 310 (270 – 360)
H3	M/A	0.0200 0,0200	0.50 0,50	0.018 0,00070	0.024 0,00095	0.030 0,0012	0.036 0,0014	0.044 0,0017	0.050 0,0020	55 (41 – 71) 180 (140 – 230)
H5	M/A	0.0300 0,0300	0.50 0,50	0.024 0,00095	0.032 0,0013	0.040 0,0016	0.048 0,0019	0.060 0,0024	0.070 0,0028	250 (210 – 300) 820 (690 – 980)
H7	M/A	0.0200 0,0200	0.50 0,50	0.018 0,00070	0.024 0,00095	0.030 0,0012	0.036 0,0014	0.044 0,0017	0.050 0,0020	55 (41 – 71) 180 (140 – 230)
H8	M/A	0.0300 0,0300	0.50 0,50	0.018 0,00070	0.024 0,00095	0.030 0,0012	0.036 0,0014	0.044 0,0017	0.050 0,0020	255 (210 – 300) 840 (690 – 980)
H11	M/A	0.0300 0,0300	0.50 0,50	0.024 0,00095	0.032 0,0013	0.040 0,0016	0.048 0,0019	0.060 0,0024	0.070 0,0028	320 (260 – 380) 1050 (860 – 1200)
H12	M/A	0.0400 0,0400	0.70 0,70	0.030 0,0012	0.042 0,0017	0.050 0,0020	0.060 0,0024	0.075 0,0030	0.085 0,0034	270 (220 – 320) 890 (730 – 1000)
H21	M/A	0.0300 0,0300	0.50 0,50	0.018 0,00070	0.024 0,00095	0.030 0,0012	0.036 0,0014	0.044 0,0017	0.050 0,0020	255 (210 – 300) 840 (690 – 980)
H31	M/A	0.0300 0,0300	0.50 0,50	0.024 0,00095	0.032 0,0013	0.040 0,0016	0.048 0,0019	0.060 0,0024	0.070 0,0028	155 (130 – 180) 510 (430 – 590)

For cutting data recalculations, see pages 556 - 563

SMG = Seco material group
Coolant = A=air D=dry E=emulsion M=mist spray
v_c = m/min (sf/min)
f_z = mm (in/tooth)
a_p = mm/DC (in/DC) = factor
a_e = mm/DC (in/DC) = factor
All cutting data are target values

JH142

High speed – High precision – Torical – Hardened steel – 2-6 Flutes – Cylindrical – Corner radius

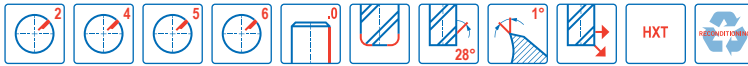
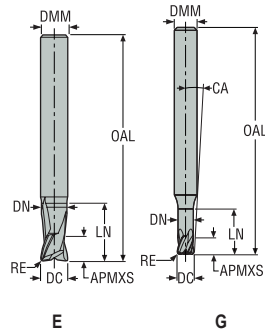

- Tolerances:
- Run-out= <0,005 mm
- DMM= h5
- DC= 0-0,01 mm
- RE= ±0,005 mm
- Regrind possible if DC is ≥Ø6

Designation	Item number	Length index	Tool shape	DC	DMM	APMXS	OAL	LN	DN	RE	CA°	PCEDC	Cylindrical
				mm	mm	mm	mm	mm	mm	mm	mm	mm	
JH142020G2R030.0Z2-HXT	02968223	2	G	2,0	4,0	2,0	40,0	6,0	1,9	0,3	6,64	2	■
JH142020G2R030.0Z4-HXT	02968224	2	G	2,0	4,0	2,0	40,0	6,0	1,9	0,3	6,64	4	■
JH142020G2R050.0Z2-HXT	02968225	2	G	2,0	4,0	2,0	40,0	6,0	1,9	0,5	6,79	2	■
JH142020G2R050.0Z4-HXT	02968226	2	G	2,0	4,0	2,0	40,0	6,0	1,9	0,5	6,79	4	■
JH142030G2R050.0Z2-HXT	02968227	2	G	3,0	4,0	3,0	40,0	8,0	2,8	0,5	2,95	2	■
JH142030G2R050.0Z4-HXT	02968228	2	G	3,0	4,0	3,0	40,0	8,0	2,8	0,5	2,95	4	■
JH142030G2R100.0Z2-HXT	02968229	2	G	3,0	4,0	3,0	40,0	8,0	2,8	1,0	3,1	2	■
JH142030G2R100.0Z4-HXT	02968230	2	G	3,0	4,0	3,0	40,0	8,0	2,8	1,0	3,1	4	■
JH142040G2R030.0Z2-HXT	02968231	2	G	4,0	6,0	4,0	50,0	8,0	3,7	0,3	5,34	2	■
JH142040G2R030.0Z4-HXT	02970110	2	G	4,0	6,0	4,0	50,0	8,0	3,7	0,3	5,34	4	■
JH142040G2R050.0Z4-HXT	02968232	2	G	4,0	6,0	4,0	50,0	8,0	3,7	0,5	5,44	4	■
JH142040G2R100.0Z4-HXT	02968233	2	G	4,0	6,0	4,0	50,0	8,0	3,7	1,0	5,69	4	■
JH142060E2R050.0Z4-HXT	02968235	2	E	6,0	6,0	6,0	50,0	12,0	5,6	0,5	-	4	■
JH142060E2R100.0Z4-HXT	02968237	2	E	6,0	6,0	6,0	50,0	12,0	5,6	1,0	-	4	■
JH142060E2R100.0Z5-HXT	02968238	2	E	6,0	6,0	6,0	50,0	12,0	5,6	1,0	-	5	■
JH142060E2R150.0Z5-HXT	02968240	2	E	6,0	6,0	6,0	50,0	12,0	5,6	1,5	-	5	■
JH142060E2R200.0Z5-HXT	02968241	2	E	6,0	6,0	6,0	50,0	12,0	5,6	2,0	-	5	■
JH142080E2R050.0Z5-HXT	02968242	2	E	8,0	8,0	8,0	60,0	16,0	7,4	0,5	-	5	■
JH142080E2R100.0Z5-HXT	02968243	2	E	8,0	8,0	8,0	60,0	16,0	7,4	1,0	-	5	■
JH142080E2R150.0Z5-HXT	02968244	2	E	8,0	8,0	8,0	60,0	16,0	7,4	1,5	-	5	■
JH142080E2R200.0Z5-HXT	02968245	2	E	8,0	8,0	8,0	60,0	16,0	7,4	2,0	-	5	■
JH142080E2R300.0Z5-HXT	02968246	2	E	8,0	8,0	8,0	60,0	16,0	7,4	3,0	-	5	■
JH142100E2R050.0Z5-HXT	02968247	2	E	10,0	10,0	10,0	70,0	20,0	9,4	0,5	-	5	■
JH142100E2R100.0Z5-HXT	02968248	2	E	10,0	10,0	10,0	70,0	20,0	9,4	1,0	-	5	■
JH142100E2R200.0Z5-HXT	02968249	2	E	10,0	10,0	10,0	70,0	20,0	9,4	2,0	-	5	■
JH142100E2R250.0Z5-HXT	02968250	2	E	10,0	10,0	10,0	70,0	20,0	9,4	2,5	-	5	■
JH142120E2R100.0Z6-HXT	02968251	2	E	12,0	12,0	12,0	75,0	24,0	11,4	1,0	-	6	■
JH142120E2R200.0Z6-HXT	02968252	2	E	12,0	12,0	12,0	75,0	24,0	11,4	2,0	-	6	■
JH142120E2R300.0Z6-HXT	02968253	2	E	12,0	12,0	12,0	75,0	24,0	11,4	3,0	-	6	■

■ Stocked standard.

Universal
Steel and cast iron
Stainless steel and S-materials
Non ferrous
Hard
Plastic and CFRP
Graphite
X-Heads
Minimaster Plus
Minimaster

JH142

High speed – High precision – Torical – Hardened steel – 2-5 Flutes – Cylindrical – Corner radius

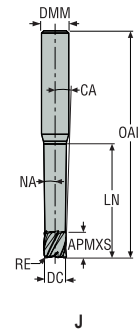

- Tolerances:
- Run-out= <0,005 mm
- DMM= h5
- DC= 0-0,01 mm
- RE= ±0,005 mm
- Regrind possible if DC is ≥Ø6

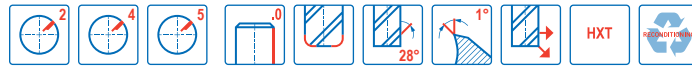

Designation	Item number	Length index	Tool shape	DC	DMM	APMXS	OAL	LN	DN	RE	CA°	PCEDC	Cylindrical
				mm	mm	mm	mm	mm	mm	mm			
JH142020J3R030.0Z2-HXT	02968255	3	J	2,0	6,0	2,0	60,0	10,0	1,9	0,3	6,72	2	■
JH142020J3R030.0Z4-HXT	02968256	3	J	2,0	6,0	2,0	60,0	10,0	1,9	0,3	6,72	4	■
JH142020J3R050.0Z2-HXT	02968257	3	J	2,0	6,0	2,0	60,0	10,0	1,9	0,5	6,79	2	■
JH142020J3R050.0Z4-HXT	02968258	3	J	2,0	6,0	2,0	60,0	10,0	1,9	0,5	6,79	4	■
JH142030J3R050.0Z2-HXT	02968259	3	J	3,0	6,0	3,0	60,0	15,0	2,8	0,5	4,3	2	■
JH142030J3R050.0Z4-HXT	02968260	3	J	3,0	6,0	3,0	60,0	15,0	2,8	0,5	4,3	4	■
JH142030J3R100.0Z2-HXT	02968261	3	J	3,0	6,0	3,0	60,0	15,0	2,8	1,0	4,4	2	■
JH142030J3R100.0Z4-HXT	02968262	3	J	3,0	6,0	3,0	60,0	15,0	2,8	1,0	4,4	4	■
JH142040J3R030.0Z2-HXT	02968263	3	J	4,0	6,0	4,0	60,0	20,0	3,7	0,3	2,45	2	■
JH142040J3R030.0Z4-HXT	02970111	3	J	4,0	6,0	4,0	60,0	20,0	3,7	0,3	2,45	4	■
JH142040J3R050.0Z2-HXT	02968265	3	J	4,0	6,0	4,0	60,0	20,0	3,7	0,5	2,48	2	■
JH142040J3R050.0Z4-HXT	02968264	3	J	4,0	6,0	4,0	60,0	20,0	3,7	0,5	2,48	4	■
JH142040J3R100.0Z2-HXT	02968266	3	J	4,0	6,0	4,0	60,0	20,0	3,7	1,0	2,53	2	■
JH142040J3R100.0Z4-HXT	02968267	3	J	4,0	6,0	4,0	60,0	20,0	3,7	1,0	2,53	4	■
JH142060J3R050.0Z4-HXT	02968268	3	J	6,0	8,0	6,0	75,0	30,0	5,6	0,5	1,75	4	■
JH142060J3R050.0Z5-HXT	02968269	3	J	6,0	8,0	6,0	75,0	30,0	5,6	0,5	1,75	5	■
JH142060J3R100.0Z4-HXT	02968270	3	J	6,0	8,0	6,0	75,0	30,0	5,6	1,0	1,77	4	■
JH142060J3R100.0Z5-HXT	02968271	3	J	6,0	8,0	6,0	75,0	30,0	5,6	1,0	1,77	5	■
JH142060J3R150.0Z5-HXT	02968272	3	J	6,0	8,0	6,0	75,0	30,0	5,6	1,5	1,8	5	■
JH142060J3R200.0Z5-HXT	02968273	3	J	6,0	8,0	6,0	75,0	30,0	5,6	2,0	1,83	5	■
JH142080J3R050.0Z5-HXT	02968274	3	J	8,0	10,0	8,0	85,0	40,0	7,4	0,5	1,34	5	■
JH142080J3R100.0Z5-HXT	02968275	3	J	8,0	10,0	8,0	85,0	40,0	7,4	1,0	1,36	5	■
JH142080J3R150.0Z5-HXT	02968276	3	J	8,0	10,0	8,0	85,0	40,0	7,4	1,5	1,37	5	■
JH142080J3R200.0Z5-HXT	02968277	3	J	8,0	10,0	8,0	85,0	40,0	7,4	2,0	1,39	5	■
JH142100J3R050.0Z5-HXT	02968278	3	J	10,0	12,0	10,0	100,0	50,0	9,4	0,5	1,1	5	■
JH142100J3R100.0Z5-HXT	02968279	3	J	10,0	12,0	10,0	100,0	50,0	9,4	1,0	1,11	5	■
JH142100J3R200.0Z5-HXT	02968280	3	J	10,0	12,0	10,0	100,0	50,0	9,4	2,0	1,13	5	■
JH142020J6R030.0Z4-HXT	02968282	6	J	2,0	6,0	2,0	75,0	20,0	1,9	0,3	4,33	4	■
JH142020J6R050.0Z4-HXT	02968283	6	J	2,0	6,0	2,0	75,0	20,0	1,9	0,5	4,36	4	■
JH142030J6R050.0Z4-HXT	02968284	6	J	3,0	6,0	3,0	75,0	30,0	2,8	0,5	2,52	4	■
JH142030J6R100.0Z4-HXT	02968285	6	J	3,0	6,0	3,0	75,0	30,0	2,8	1,0	2,56	4	■
JH142040J6R030.0Z4-HXT	02968286	6	J	4,0	6,0	4,0	80,0	40,0	3,7	0,3	1,36	4	■
JH142040J6R050.0Z4-HXT	02968287	6	J	4,0	6,0	4,0	80,0	40,0	3,7	0,5	1,37	4	■
JH142040J6R100.0Z4-HXT	02968288	6	J	4,0	6,0	4,0	80,0	40,0	3,7	1,0	1,38	4	■

■ Stocked standard.

Cutting data – JH142 Copy milling roughing

SMG		a _p /DC	a _e /DC	f _z								v _c
				2	3	4	6	8	10	12	16	
P1	M/E	0.0500	0.050	0.020	0.030	0.040	0.060	0.080	0.10	0.12	0.14	485 (460 – 530)
		0,0500	0,050	0,00080	0,0012	0,0016	0,0024	0,0032	0,0040	0,0048	0,0055	1600 (1600 – 1700)
P2	M/E	0.0500	0.050	0.020	0.030	0.040	0.060	0.080	0.10	0.12	0.15	470 (450 – 520)
		0,0500	0,050	0,00080	0,0012	0,0016	0,0024	0,0032	0,0040	0,0048	0,0060	1550 (1500 – 1700)
P3	M/E	0.0500	0.050	0.019	0.028	0.038	0.055	0.075	0.095	0.11	0.14	405 (390 – 450)
		0,0500	0,050	0,00075	0,0011	0,0015	0,0022	0,0030	0,0038	0,0044	0,0055	1325 (1300 – 1400)
P4	M/E	0.0500	0.050	0.019	0.028	0.038	0.055	0.075	0.095	0.11	0.14	360 (340 – 390)
		0,0500	0,050	0,00075	0,0011	0,0015	0,0022	0,0030	0,0038	0,0044	0,0055	1175 (1200 – 1200)
P5	M/E	0.0500	0.050	0.018	0.028	0.036	0.055	0.075	0.090	0.11	0.13	345 (330 – 380)
		0,0500	0,050	0,00070	0,0011	0,0014	0,0022	0,0030	0,0036	0,0044	0,0050	1125 (1100 – 1200)
P6	M/E	0.0500	0.050	0.018	0.028	0.036	0.055	0.070	0.090	0.11	0.13	385 (370 – 420)
		0,0500	0,050	0,00070	0,0011	0,0014	0,0022	0,0028	0,0036	0,0044	0,0050	1275 (1300 – 1300)
P7	M/E	0.0500	0.050	0.018	0.028	0.036	0.055	0.070	0.090	0.11	0.13	365 (350 – 400)
		0,0500	0,050	0,00070	0,0011	0,0014	0,0022	0,0028	0,0036	0,0044	0,0050	1200 (1200 – 1300)
P8	M/E	0.0500	0.050	0.019	0.028	0.038	0.055	0.075	0.095	0.11	0.14	340 (330 – 380)
		0,0500	0,050	0,00075	0,0011	0,0015	0,0022	0,0030	0,0038	0,0044	0,0055	1125 (1100 – 1200)
P11	M/E	0.0500	0.050	0.018	0.028	0.036	0.055	0.070	0.090	0.11	0.13	355 (340 – 390)
		0,0500	0,050	0,00070	0,0011	0,0014	0,0022	0,0028	0,0036	0,0044	0,0050	1175 (1200 – 1200)
K1	A/E	0.0500	0.050	0.018	0.028	0.036	0.055	0.075	0.090	0.11	0.13	345 (330 – 380)
		0,0500	0,050	0,00070	0,0011	0,0014	0,0022	0,0030	0,0036	0,0044	0,0050	1125 (1100 – 1200)
K2	A/E	0.0500	0.050	0.017	0.025	0.034	0.050	0.065	0.085	0.10	0.12	300 (290 – 330)
		0,0500	0,050	0,00065	0,0010	0,0013	0,0020	0,0026	0,0034	0,0040	0,0048	980 (960 – 1000)
K3	A/E	0.0500	0.050	0.017	0.025	0.034	0.050	0.065	0.085	0.10	0.12	255 (240 – 280)
		0,0500	0,050	0,00065	0,0010	0,0013	0,0020	0,0026	0,0034	0,0040	0,0048	840 (790 – 910)
K4	A/E	0.0500	0.050	0.017	0.025	0.034	0.050	0.065	0.085	0.10	0.12	245 (230 – 260)
		0,0500	0,050	0,00065	0,0010	0,0013	0,0020	0,0026	0,0034	0,0040	0,0048	800 (760 – 850)
K5	A/E	0.0500	0.050	0.018	0.028	0.036	0.055	0.075	0.090	0.11	0.13	345 (330 – 380)
		0,0500	0,050	0,00070	0,0011	0,0014	0,0022	0,0030	0,0036	0,0044	0,0050	1125 (1100 – 1200)
K6	A/E	0.0500	0.050	0.020	0.030	0.040	0.060	0.080	0.10	0.12	0.15	500 (480 – 550)
		0,0500	0,050	0,00080	0,0012	0,0016	0,0024	0,0032	0,0040	0,0048	0,0060	1650 (1600 – 1800)
K7	A/E	0.0500	0.050	0.018	0.028	0.036	0.055	0.075	0.090	0.11	0.13	440 (420 – 490)
		0,0500	0,050	0,00070	0,0011	0,0014	0,0022	0,0030	0,0036	0,0044	0,0050	1450 (1400 – 1600)
H3	M/A	0.0200	0.020	0.014	0.020	0.028	0.042	0.055	0.070	0.080	0.10	95 (72 – 110)
		0,0200	0,020	0,00055	0,00080	0,0011	0,0017	0,0022	0,0028	0,0032	0,0040	310 (240 – 360)
H5	M/A	0.0400	0.040	0.014	0.022	0.028	0.042	0.055	0.070	0.085	0.10	305 (290 – 330)
		0,0400	0,040	0,00055	0,00085	0,0011	0,0017	0,0022	0,0028	0,0034	0,0040	1000 (960 – 1000)
H7	M/A	0.0200	0.020	0.014	0.020	0.028	0.042	0.055	0.070	0.080	0.10	95 (72 – 110)
		0,0200	0,020	0,00055	0,00080	0,0011	0,0017	0,0022	0,0028	0,0032	0,0040	310 (240 – 360)
H8	M/A	0.0400	0.040	0.011	0.016	0.022	0.032	0.042	0.055	0.065	0.080	310 (290 – 330)
		0,0400	0,040	0,00044	0,00065	0,00085	0,0013	0,0017	0,0022	0,0026	0,0032	1025 (960 – 1000)
H11	M/A	0.0400	0.040	0.014	0.022	0.028	0.042	0.055	0.070	0.085	0.10	390 (360 – 420)
		0,0400	0,040	0,00055	0,00085	0,0011	0,0017	0,0022	0,0028	0,0034	0,0040	1275 (1200 – 1300)
H12	M/A	0.0500	0.050	0.0095	0.014	0.019	0.028	0.038	0.046	0.055	0.070	345 (320 – 370)
		0,0500	0,050	0,00038	0,00055	0,00075	0,0011	0,0015	0,0018	0,0022	0,0028	1125 (1100 – 1200)
H21	M/A	0.0400	0.040	0.011	0.016	0.022	0.032	0.042	0.055	0.065	0.080	310 (290 – 330)
		0,0400	0,040	0,00044	0,00065	0,00085	0,0013	0,0017	0,0022	0,0026	0,0032	1025 (960 – 1000)
H31	M/A	0.0300	0.030	0.013	0.019	0.025	0.038	0.050	0.065	0.075	0.090	140 (120 – 160)
		0,0300	0,030	0,00050	0,00075	0,0010	0,0015	0,0020	0,0026	0,0030	0,0036	460 (400 – 520)

For cutting data recalculations, see pages 556 - 563

SMG = Seco material group
 Coolant = A=air D=dry E=emulsion M=mist spray
 v_c = m/min (sf/min)
 f_z = mm (in/tooth)
 a_p = mm/DC (in/DC) = factor
 a_e = mm/DC (in/DC) = factor
 All cutting data are target values

Universal
 Steel and cast iron
 Stainless steel and S-materials
 Non ferrous
 Hard
 Plastic and CFRP
 Graphite
 X-Heads
 Minimax Plus
 Minimax

JH112

High speed – High precision – Hardened steel – Ball nose – 2 Flutes – Cylindrical

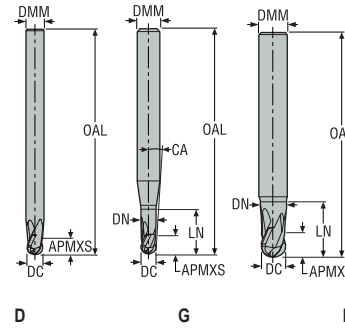

- Tolerances:
- Run-out= <0,005 mm
- DMM= h5
- DC= 0-0,01 mm
- RE= ±0,005 mm
- Regrind possible if DC is ≥Ø6

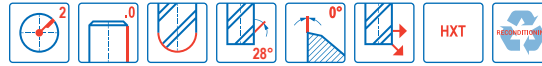

Designation	Item number	Length index	Tool shape	DC	DMM	APMXS	OAL	LN	DN	CA°	PCEDC	Cylindrical
				mm	mm	mm	mm	mm	mm			
JH112020G1B.0Z2-HXT	02970112	1	G	2,0	4,0	2,0	40,0	4,0	1,9	6,45	2	■
JH112030G1B.0Z2-HXT	02970113	1	G	3,0	4,0	3,0	40,0	6,0	2,8	3,3	2	■
JH112040D1B.0Z2-HXT	02970114	1	D	4,0	4,0	4,0	40,0	-	-	-	2	■
JH112050G1B.0Z2-HXT	02970115	1	G	5,0	6,0	5,0	50,0	10,0	4,6	2,0	2	■
JH112060D1B.0Z2-HXT	02970116	1	D	6,0	6,0	6,0	50,0	-	-	-	2	■
JH112080D1B.0Z2-HXT	02970117	1	D	8,0	8,0	8,0	65,0	-	-	-	2	■
JH112100D1B.0Z2-HXT	02970118	1	D	10,0	10,0	10,0	65,0	-	-	-	2	■
JH112020G2B.0Z2-HXT	02970119	2	G	2,0	3,0	2,0	50,0	10,0	1,9	2,5	2	■
JH112030D2B.0Z2-HXT	02970120	2	D	3,0	3,0	3,0	50,0	-	-	-	2	■
JH112040D2B.0Z2-HXT	02970121	2	D	4,0	4,0	4,0	60,0	-	-	-	2	■
JH112050D2B.0Z2-HXT	02970122	2	D	5,0	5,0	5,0	60,0	-	-	-	2	■
JH112060D2B.0Z2-HXT	02970123	2	D	6,0	6,0	6,0	75,0	-	-	-	2	■
JH112020G3B.0Z2-HXT	02970124	3	G	2,0	6,0	2,0	60,0	4,0	1,9	8,12	2	■
JH112025G3B.0Z2-HXT	02970125	3	G	2,5	6,0	2,5	60,0	5,0	2,4	7,39	2	■
JH112030G3B.0Z2-HXT	02970126	3	G	3,0	6,0	3,0	60,0	6,0	2,8	5,5	2	■
JH112035G3B.0Z2-HXT	02968289	3	G	3,5	6,0	3,5	65,0	7,0	3,2	3,81	2	■
JH112040G3B.0Z2-HXT	02970127	3	G	4,0	6,0	4,0	65,0	8,0	3,7	3,34	2	■
JH112050G3B.0Z2-HXT	02970128	3	G	5,0	6,0	5,0	65,0	10,0	4,6	2,0	2	■
JH112060G3B.0Z2-HXT	02970129	3	G	6,0	8,0	6,0	75,0	12,0	5,6	2,78	2	■
JH112080E3B.0Z2-HXT	02968290	3	E	8,0	8,0	8,0	75,0	16,0	7,4	-	2	■
JH112100E3B.0Z2-HXT	02968291	3	E	10,0	10,0	10,0	80,0	20,0	9,4	-	2	■
JH112120E3B.0Z2-HXT	02968292	3	E	12,0	12,0	12,0	90,0	24,0	11,4	-	2	■
JH112020G4B.0Z2-HXT	02970130	4	G	2,0	6,0	2,0	80,0	20,0	1,9	3,82	2	■
JH112030G4B.0Z2-HXT	02970131	4	G	3,0	6,0	3,0	80,0	20,0	2,8	2,91	2	■
JH112040G4B.0Z2-HXT	02970132	4	G	4,0	6,0	4,0	80,0	20,0	3,7	1,97	2	■
JH112050G4B.0Z2-HXT	02970133	4	G	5,0	6,0	5,0	100,0	50,0	4,6	0,53	2	■
JH112060D4B.0Z2-HXT	02968293	4	D	6,0	6,0	6,0	100,0	-	-	-	2	■
JH112080D4B.0Z2-HXT	02968294	4	D	8,0	8,0	8,0	110,0	-	-	-	2	■
JH112100D4B.0Z2-HXT	02968295	4	D	10,0	10,0	10,0	125,0	-	-	-	2	■
JH112120D4B.0Z2-HXT	02968296	4	D	12,0	12,0	12,0	125,0	-	-	-	2	■

■ Stocked standard.

Universal

Steel and cast iron

Stainless steel and S-materials

Non ferrous

Hard

Plastic and CFRP

Graphite

X-Heads

Minimaster Plus

Minimaster

JH112

High speed – High precision – Hardened steel – Ball nose – 2 Flutes – Cylindrical

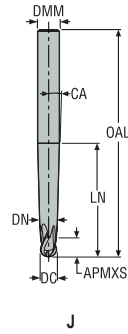

J

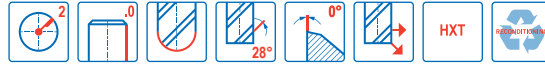

- Tolerances:
- Run-out= <0,005 mm
- DMM= h5
- DC= $\varnothing 0,6 = 0/-0,008 \text{ mm}$
- DC= $\ge \varnothing 0,6 = 0/-0,01 \text{ mm}$
- RE= $\varnothing 0,5 = \pm 0,004 \text{ mm}$
- RE= $\ge \varnothing 1,5 = \pm 0,005 \text{ mm}$

Designation	Item number	Length index	Tool shape	DC	DMM	APMXS	OAL	DN	NA°	CA°	PCEDC	Cylindrical
				mm	mm	mm	mm	mm				
JH112020J5B.0Z2-HXT	02970134	5	J	2,0	6,0	2,0	80,0	1,9	3,55	3,3	2	■
JH112030J5B.0Z2-HXT	02970135	5	J	3,0	6,0	3,0	80,0	2,8	2,5	2,2	2	■
JH112040J5B.0Z2-HXT	02970136	5	J	4,0	6,0	4,0	80,0	3,7	1,4	1,2	2	■
JH112050J5B.0Z2-HXT	02970137	5	J	5,0	8,0	5,0	100,0	4,6	1,95	1,6	2	■
JH112060J5B.0Z2-HXT	02970138	5	J	6,0	8,0	6,0	100,0	5,6	1,4	1,1	2	■
JH112080J5B.0Z2-HXT	02970139	5	J	8,0	10,0	8,0	125,0	7,4	1,43	1,0	2	■
JH112100J5B.0Z2-HXT	02970140	5	J	10,0	12,0	10,0	125,0	9,4	1,5	1,0	2	■
JH112060J6B.0Z2-HXT	02970141	6	J	6,0	10,0	6,0	125,0	5,6	2,3	2,0	2	■
JH112080J6B.0Z2-HXT	02970142	6	J	8,0	12,0	8,0	150,0	7,4	2,3	1,8	2	■
JH112100J6B.0Z2-HXT	02970143	6	J	10,0	12,0	10,0	150,0	9,4	1,1	0,8	2	■

■ Stocked standard.

Universal

Steel and cast iron

Stainless steel and S-materials

Non ferrous

Hard

Plastic and cfrp

Graphite

X-Heads

Minimaster Plus

Minimaster

Cutting data – JH112 Copy milling finishing

SMG		a _p /DC	f _z										v _c
			2	2.5	3	3.5	4	5	6	8	10	12	
K1	E	0.30	0.030	0.038	0.044	0.050	0.060	0.075	0.090	0.12	0.15	0.18	520 (500 – 730)
		0.30	0.0012	0.0015	0.0017	0.0020	0.0024	0.0030	0.0036	0.0048	0.0060	0.0070	1700 (1700 – 2300)
K2	E	0.30	0.030	0.038	0.044	0.050	0.060	0.075	0.090	0.12	0.15	0.18	445 (430 – 630)
		0.30	0.0012	0.0015	0.0017	0.0020	0.0024	0.0030	0.0036	0.0048	0.0060	0.0070	1450 (1500 – 2000)
K3	E	0.30	0.030	0.038	0.044	0.050	0.060	0.075	0.090	0.12	0.15	0.18	380 (360 – 530)
		0.30	0.0012	0.0015	0.0017	0.0020	0.0024	0.0030	0.0036	0.0048	0.0060	0.0070	1250 (1200 – 1700)
K4	E	0.30	0.030	0.038	0.044	0.050	0.060	0.075	0.090	0.12	0.15	0.18	360 (350 – 510)
		0.30	0.0012	0.0015	0.0017	0.0020	0.0024	0.0030	0.0036	0.0048	0.0060	0.0070	1175 (1200 – 1600)
K5	E	0.30	0.030	0.038	0.044	0.050	0.060	0.075	0.090	0.12	0.15	0.18	415 (370 – 610)
		0.30	0.0012	0.0015	0.0017	0.0020	0.0024	0.0030	0.0036	0.0048	0.0060	0.0070	1350 (1300 – 2000)
K6	E	0.30	0.030	0.038	0.044	0.050	0.060	0.075	0.090	0.12	0.15	0.18	610 (550 – 900)
		0.30	0.0012	0.0015	0.0017	0.0020	0.0024	0.0030	0.0036	0.0048	0.0060	0.0070	2000 (1900 – 2900)
K7	E	0.30	0.030	0.038	0.044	0.050	0.060	0.075	0.090	0.12	0.15	0.18	680 (560 – 790)
		0.30	0.0012	0.0015	0.0017	0.0020	0.0024	0.0030	0.0036	0.0048	0.0060	0.0070	2225 (1900 – 2500)
H3	M	0.16	0.028	0.036	0.042	0.048	0.055	0.070	0.085	0.11	0.14	0.17	155 (150 – 230)
		0.16	0.0011	0.0014	0.0017	0.0019	0.0022	0.0028	0.0034	0.0044	0.0055	0.0065	510 (500 – 750)
H5	M	0.30	0.030	0.038	0.044	0.050	0.060	0.075	0.090	0.12	0.15	0.18	285 (240 – 330)
		0.30	0.0012	0.0015	0.0017	0.0020	0.0024	0.0030	0.0036	0.0048	0.0060	0.0070	940 (790 – 1000)
H7	M	0.16	0.028	0.036	0.042	0.048	0.055	0.070	0.085	0.11	0.14	0.17	155 (150 – 230)
		0.16	0.0011	0.0014	0.0017	0.0019	0.0022	0.0028	0.0034	0.0044	0.0055	0.0065	510 (500 – 750)
H8	M	0.30	0.030	0.038	0.044	0.050	0.060	0.075	0.090	0.12	0.15	0.18	285 (240 – 330)
		0.30	0.0012	0.0015	0.0017	0.0020	0.0024	0.0030	0.0036	0.0048	0.0060	0.0070	940 (790 – 1000)
H11	M	0.30	0.030	0.038	0.044	0.050	0.060	0.075	0.090	0.12	0.15	0.18	360 (300 – 420)
		0.30	0.0012	0.0015	0.0017	0.0020	0.0024	0.0030	0.0036	0.0048	0.0060	0.0070	1175 (990 – 1300)
H12	M	0.30	0.030	0.038	0.044	0.050	0.060	0.075	0.090	0.12	0.15	0.18	330 (280 – 380)
		0.30	0.0012	0.0015	0.0017	0.0020	0.0024	0.0030	0.0036	0.0048	0.0060	0.0070	1075 (920 – 1200)
H21	M	0.30	0.030	0.038	0.044	0.050	0.060	0.075	0.090	0.12	0.15	0.18	285 (240 – 330)
		0.30	0.0012	0.0015	0.0017	0.0020	0.0024	0.0030	0.0036	0.0048	0.0060	0.0070	940 (790 – 1000)
H31	M	0.30	0.026	0.032	0.040	0.046	0.050	0.065	0.080	0.10	0.13	0.16	300 (290 – 430)
		0.30	0.0010	0.0013	0.0016	0.0018	0.0020	0.0026	0.0032	0.0040	0.0050	0.0065	980 (960 – 1400)

For cutting data recalculations, see pages 556 - 563

SMG = Seco material group

Coolant = A=air D=dry E=emulsion M=mist spray

v_c = m/min (sf/min)

f_z = mm (in/tooth)

a_p = mm/DC (in/DC) = factor

a_e = mm/DC (in/DC) = factor

All cutting data are target values

Cutting data – JH112 Copy milling roughing

SMG		a _e /DC	a _p /DC	f _z										v _c
				2	2.5	3	3.5	4	5	6	8	10	12	
K1	E	0.250	0.15	0.030	0.038	0.044	0.050	0.060	0.075	0.090	0.12	0.15	0.18	315 (310 – 450)
		0,250	0,15	0,0012	0,0015	0,0017	0,0020	0,0024	0,0030	0,0036	0,0048	0,0060	0,0070	1025 (1100 – 1400)
K2	E	0.250	0.15	0.028	0.036	0.044	0.050	0.060	0.070	0.085	0.12	0.14	0.17	280 (270 – 390)
		0,250	0,15	0,0011	0,0014	0,0017	0,0020	0,0024	0,0028	0,0034	0,0048	0,0055	0,0065	920 (890 – 1200)
K3	E	0.250	0.15	0.028	0.036	0.044	0.050	0.060	0.070	0.085	0.12	0.14	0.17	235 (230 – 330)
		0,250	0,15	0,0011	0,0014	0,0017	0,0020	0,0024	0,0028	0,0034	0,0048	0,0055	0,0065	770 (760 – 1000)
K4	E	0.250	0.15	0.028	0.036	0.044	0.050	0.060	0.070	0.085	0.12	0.14	0.17	225 (220 – 320)
		0,250	0,15	0,0011	0,0014	0,0017	0,0020	0,0024	0,0028	0,0034	0,0048	0,0055	0,0065	740 (730 – 1000)
K5	E	0.160	0.15	0.030	0.038	0.044	0.050	0.060	0.075	0.090	0.12	0.15	0.18	280 (250 – 410)
		0,160	0,15	0,0012	0,0015	0,0017	0,0020	0,0024	0,0030	0,0036	0,0048	0,0060	0,0070	920 (830 – 1300)
K6	E	0.160	0.15	0.030	0.038	0.044	0.050	0.060	0.075	0.090	0.12	0.15	0.18	415 (370 – 610)
		0,160	0,15	0,0012	0,0015	0,0017	0,0020	0,0024	0,0030	0,0036	0,0048	0,0060	0,0070	1350 (1300 – 2000)
K7	E	0.250	0.10	0.030	0.038	0.044	0.050	0.060	0.075	0.090	0.12	0.15	0.18	420 (350 – 490)
		0,250	0,10	0,0012	0,0015	0,0017	0,0020	0,0024	0,0030	0,0036	0,0048	0,0060	0,0070	1375 (1200 – 1600)
H3	M	0.120	0.040	0.028	0.036	0.042	0.048	0.055	0.070	0.085	0.11	0.14	0.17	110 (100 – 160)
		0,120	0,040	0,0011	0,0014	0,0017	0,0019	0,0022	0,0028	0,0034	0,0044	0,0055	0,0065	360 (330 – 520)
H5	M	0.250	0.10	0.030	0.038	0.044	0.050	0.060	0.075	0.090	0.12	0.15	0.18	175 (150 – 200)
		0,250	0,10	0,0012	0,0015	0,0017	0,0020	0,0024	0,0030	0,0036	0,0048	0,0060	0,0070	570 (500 – 650)
H7	M	0.120	0.040	0.028	0.036	0.042	0.048	0.055	0.070	0.085	0.11	0.14	0.17	110 (100 – 160)
		0,120	0,040	0,0011	0,0014	0,0017	0,0019	0,0022	0,0028	0,0034	0,0044	0,0055	0,0065	360 (330 – 520)
H8	M	0.250	0.10	0.030	0.038	0.044	0.050	0.060	0.075	0.090	0.12	0.15	0.18	175 (150 – 200)
		0,250	0,10	0,0012	0,0015	0,0017	0,0020	0,0024	0,0030	0,0036	0,0048	0,0060	0,0070	570 (500 – 650)
H11	M	0.250	0.10	0.030	0.038	0.044	0.050	0.060	0.075	0.090	0.12	0.15	0.18	225 (190 – 260)
		0,250	0,10	0,0012	0,0015	0,0017	0,0020	0,0024	0,0030	0,0036	0,0048	0,0060	0,0070	740 (630 – 850)
H12	M	0.250	0.10	0.030	0.038	0.044	0.050	0.060	0.075	0.090	0.12	0.15	0.18	205 (170 – 240)
		0,250	0,10	0,0012	0,0015	0,0017	0,0020	0,0024	0,0030	0,0036	0,0048	0,0060	0,0070	670 (560 – 780)
H21	M	0.250	0.10	0.030	0.038	0.044	0.050	0.060	0.075	0.090	0.12	0.15	0.18	175 (150 – 200)
		0,250	0,10	0,0012	0,0015	0,0017	0,0020	0,0024	0,0030	0,0036	0,0048	0,0060	0,0070	570 (500 – 650)
H31	M	0.200	0.10	0.026	0.032	0.040	0.046	0.050	0.065	0.080	0.10	0.13	0.16	200 (200 – 280)
		0,200	0,10	0,0010	0,0013	0,0016	0,0018	0,0020	0,0026	0,0032	0,0040	0,0050	0,0065	660 (660 – 910)

For cutting data recalculations, see pages 556 - 563

SMG = Seco material group
 Coolant = A=air D=dry E=emulsion M=mist spray
 v_c = m/min (sf/min)
 f_z = mm (in/tooth)
 a_p = mm/DC (in/DC) = factor
 a_e = mm/DC (in/DC) = factor
 All cutting data are target values

Universal
 Steel and cast iron
 Stainless steel and S-materials
 Non ferrous
 Hard
 Plastic and CFRP
 Graphite
 X-Heads
 Minmaster Plus
 Minmaster

JH150

High speed – Hardened steel – Ball nose – 4 Flutes – Cylindrical

Universal

Steel and cast iron

Stainless steel and S-materials

Non ferrous

Hard

Plastic and CFRP

Graphite

X-Heads

Minimaster Plus

Minimaster

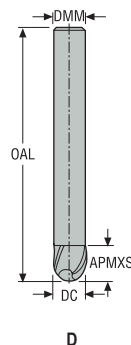

- Tolerances:
- DMM= h5
- DC= -0,02/-0,04 mm
- RE= ±0,01 mm
- Regrind possible

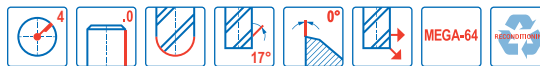

Designation	Item number	Length index	Tool shape	DC	DMM	APMXS	OAL	PCEDC	Cylindrical
				mm	mm	mm	mm		
150060-MEGA-64	00019198	2	D	6,0	6,0	6,0	80,0	4	■
150080-MEGA-64	00019208	2	D	8,0	8,0	8,0	85,0	4	■
150100-MEGA-64	00019219	2	D	10,0	10,0	10,0	100,0	4	■
150120-MEGA-64	00019254	2	D	12,0	12,0	12,0	100,0	4	■

■ Stocked standard.

Cutting data – JH150 Copy milling roughing

SMG		a _e /DC	a _p /DC	f _z				v _c
				6	8	10	12	
K1	A	0.300	0.15	0.10	0.14	0.17	0.20	290 (310 – 370)
		0,300	0,15	0,0040	0,0055	0,0065	0,0080	950 (1100 – 1200)
K2	A	0.300	0.15	0.10	0.14	0.17	0.20	250 (270 – 320)
		0,300	0,15	0,0040	0,0055	0,0065	0,0080	820 (890 – 1000)
K3	A	0.300	0.15	0.10	0.14	0.17	0.20	210 (230 – 270)
		0,300	0,15	0,0040	0,0055	0,0065	0,0080	690 (760 – 880)
K5	A	0.200	0.15	0.10	0.14	0.17	0.20	255 (270 – 330)
		0,200	0,15	0,0040	0,0055	0,0065	0,0080	840 (890 – 1000)
K6	A	0.200	0.15	0.10	0.14	0.17	0.20	375 (390 – 500)
		0,200	0,15	0,0040	0,0055	0,0065	0,0080	1225 (1300 – 1600)
K7	A	0.200	0.15	0.10	0.14	0.17	0.20	325 (340 – 430)
		0,200	0,15	0,0040	0,0055	0,0065	0,0080	1075 (1200 – 1400)
H3	M	0.0500	0.020	0.085	0.11	0.14	0.17	85 (88 – 120)
		0,0500	0,020	0,0034	0,0044	0,0055	0,0065	280 (290 – 390)
H5	M	0.200	0.060	0.10	0.14	0.17	0.20	180 (160 – 200)
		0,200	0,060	0,0040	0,0055	0,0065	0,0080	590 (530 – 650)
H7	M	0.0500	0.020	0.085	0.11	0.14	0.17	85 (88 – 120)
		0,0500	0,020	0,0034	0,0044	0,0055	0,0065	280 (290 – 390)
H8	M	0.200	0.060	0.10	0.14	0.17	0.20	180 (160 – 200)
		0,200	0,060	0,0040	0,0055	0,0065	0,0080	590 (530 – 650)
H11	M	0.200	0.060	0.10	0.14	0.17	0.20	230 (210 – 250)
		0,200	0,060	0,0040	0,0055	0,0065	0,0080	750 (690 – 820)
H12	M	0.200	0.060	0.10	0.14	0.17	0.20	210 (190 – 230)
		0,200	0,060	0,0040	0,0055	0,0065	0,0080	690 (630 – 750)
H21	M	0.200	0.060	0.10	0.14	0.17	0.20	180 (160 – 200)
		0,200	0,060	0,0040	0,0055	0,0065	0,0080	590 (530 – 650)
H31	M	0.150	0.060	0.090	0.12	0.15	0.18	125 (130 – 180)
		0,150	0,060	0,0036	0,0048	0,0060	0,0070	410 (430 – 590)

For cutting data recalculations, see pages 556 - 563

SMG = Seco material group
 Coolant = A=air D=dry E=emulsion M=mist spray
 v_c = m/min (sf/min)
 f_z = mm (in/tooth)
 a_p = mm/DC (in/DC) = factor
 a_e = mm/DC (in/DC) = factor
 All cutting data are target values

Universal
 Steel and cast iron
 Stainless steel and S-materials
 Non ferrous
 Hard
 Plastic and CFRP
 Graphite
 X-Heads
 Minimaster Plus
 Minimaster

JH160

High speed – Hardened steel – Ball nose – 4 Flutes – Cylindrical

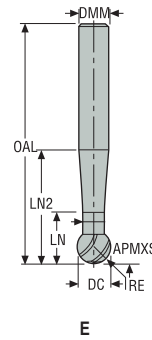

- Tolerances:
- DMM= h5
- DC= 0,02/-0,06 mm
- SA=250°

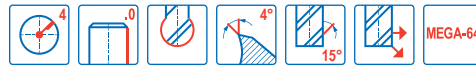

Designation	Item number	Length index	Tool shape	DC	DMM	APMXS	OAL	LN	LN2	DN	RE	PCEDC	Cylindrical
				mm	mm	mm	mm	mm	mm	mm	mm		
160030-MEGA-64	00040365	2	E	3,0	3,0	2,3	60,0	4,5	9,0	1,8	1,5	4	■
160040-MEGA-64	00040366	2	E	4,0	4,0	3,1	60,0	5,6	11,0	2,4	2,0	4	■
160050-MEGA-64	00040367	2	E	5,0	5,0	3,9	70,0	6,4	13,0	3,0	2,5	4	■
160060-MEGA-64	00040368	2	E	6,0	6,0	4,7	80,0	9,7	17,3	3,6	3,0	4	■
160080-MEGA-64	00040369	2	E	8,0	8,0	6,2	85,0	11,2	21,3	4,8	4,0	4	■
160100-MEGA-64	00040370	2	E	10,0	10,0	7,8	100,0	15,6	27,9	6,0	5,0	4	■
160120-MEGA-64	00040371	2	E	12,0	12,0	9,4	125,0	17,2	31,8	7,2	6,0	4	■

■ Stocked standard.

Universal

Steel and cast iron

Stainless steel and S-materials

Non ferrous

Hard

Plastic and CFRP

Graphite

X-Heads

Minimaster Plus

Minimaster

Cutting data – JH160 Copy milling finishing

SMG		a _p /DC	a _p /DC	f _z							v _c
				3	4	5	6	8	10	12	
P1	M/E/A	0.0200	0.024	0.050	0.070	0.085	0.10	0.14	0.17	0.20	550 (450 – 700)
		0,0200	0,024	0,0020	0,0028	0,0034	0,0040	0,0055	0,0065	0,0080	1800 (1500 – 2200)
P2	M/E/A	0.0200	0.024	0.050	0.070	0.085	0.10	0.14	0.17	0.20	530 (440 – 680)
		0,0200	0,024	0,0020	0,0028	0,0034	0,0040	0,0055	0,0065	0,0080	1750 (1500 – 2200)
P3	M/E/A	0.0200	0.024	0.050	0.070	0.085	0.10	0.14	0.17	0.20	460 (380 – 590)
		0,0200	0,024	0,0020	0,0028	0,0034	0,0040	0,0055	0,0065	0,0080	1500 (1300 – 1900)
P4	M/E/A	0.0200	0.024	0.050	0.070	0.085	0.10	0.14	0.17	0.20	405 (340 – 520)
		0,0200	0,024	0,0020	0,0028	0,0034	0,0040	0,0055	0,0065	0,0080	1325 (1200 – 1700)
P5	M/E/A	0.0200	0.024	0.050	0.070	0.085	0.10	0.14	0.17	0.20	385 (320 – 490)
		0,0200	0,024	0,0020	0,0028	0,0034	0,0040	0,0055	0,0065	0,0080	1275 (1100 – 1600)
P6	M/E/A	0.0200	0.024	0.050	0.070	0.085	0.10	0.14	0.17	0.20	430 (360 – 560)
		0,0200	0,024	0,0020	0,0028	0,0034	0,0040	0,0055	0,0065	0,0080	1400 (1200 – 1800)
P7	M/E/A	0.0200	0.024	0.050	0.070	0.085	0.10	0.14	0.17	0.20	410 (340 – 520)
		0,0200	0,024	0,0020	0,0028	0,0034	0,0040	0,0055	0,0065	0,0080	1350 (1200 – 1700)
P8	M/E/A	0.0200	0.024	0.050	0.070	0.085	0.10	0.14	0.17	0.20	385 (320 – 490)
		0,0200	0,024	0,0020	0,0028	0,0034	0,0040	0,0055	0,0065	0,0080	1275 (1100 – 1600)
P11	M/E/A	0.0200	0.024	0.050	0.070	0.085	0.10	0.14	0.17	0.20	395 (330 – 510)
		0,0200	0,024	0,0020	0,0028	0,0034	0,0040	0,0055	0,0065	0,0080	1300 (1100 – 1600)
P12	M/E/A	0.0200	0.024	0.050	0.070	0.085	0.10	0.14	0.17	0.20	235 (200 – 300)
		0,0200	0,024	0,0020	0,0028	0,0034	0,0040	0,0055	0,0065	0,0080	770 (660 – 980)
H3	M/E/A	0.0100	0.0075	0.040	0.050	0.065	0.080	0.10	0.13	0.16	85 (91 – 110)
		0,0100	0,0075	0,0016	0,0020	0,0026	0,0032	0,0040	0,0050	0,0065	280 (300 – 360)
H5	M/E/A	0.0100	0.016	0.040	0.050	0.065	0.080	0.10	0.13	0.16	340 (320 – 360)
		0,0100	0,016	0,0016	0,0020	0,0026	0,0032	0,0040	0,0050	0,0065	1125 (1100 – 1100)
H7	M/E/A	0.0100	0.0075	0.040	0.050	0.065	0.080	0.10	0.13	0.16	85 (91 – 110)
		0,0100	0,0075	0,0016	0,0020	0,0026	0,0032	0,0040	0,0050	0,0065	280 (300 – 360)
H8	M/E/A	0.0100	0.016	0.040	0.050	0.065	0.080	0.10	0.13	0.16	340 (320 – 360)
		0,0100	0,016	0,0016	0,0020	0,0026	0,0032	0,0040	0,0050	0,0065	1125 (1100 – 1100)
H11	M/E/A	0.0100	0.016	0.040	0.050	0.065	0.080	0.10	0.13	0.16	430 (400 – 460)
		0,0100	0,016	0,0016	0,0020	0,0026	0,0032	0,0040	0,0050	0,0065	1400 (1400 – 1500)
H12	M/E/A	0.0200	0.024	0.050	0.070	0.085	0.10	0.14	0.17	0.20	355 (340 – 380)
		0,0200	0,024	0,0020	0,0028	0,0034	0,0040	0,0055	0,0065	0,0080	1175 (1200 – 1200)
H21	M/E/A	0.0100	0.016	0.040	0.050	0.065	0.080	0.10	0.13	0.16	340 (320 – 360)
		0,0100	0,016	0,0016	0,0020	0,0026	0,0032	0,0040	0,0050	0,0065	1125 (1100 – 1100)
H31	M/E/A	0.0100	0.016	0.040	0.050	0.065	0.080	0.10	0.13	0.16	165 (180 – 210)
		0,0100	0,016	0,0016	0,0020	0,0026	0,0032	0,0040	0,0050	0,0065	540 (600 – 680)

For cutting data recalculations, see pages 556 - 563

SMG = Seco material group
 Coolant = A=air D=dry E=emulsion M=mist spray
 v_c = m/min (sf/min)
 f_z = mm (in/tooth)
 a_p = mm/DC (in/DC) = factor
 a_e = mm/DC (in/DC) = factor
 All cutting data are target values

Universal
 Steel and cast iron
 Stainless steel and S-materials
 Non ferrous
 Hard
 Plastic and CFRP
 Graphite
 X-Heads
 Minmaster Plus
 Minmaster

JME142

Miniature – Hardened steel – Square – 2 Flutes – Cylindrical – Corner radius

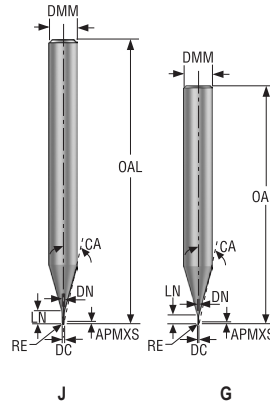

- Tolerances:
- Run-out= <0,005 mm
- DMM = h5
- DC= $\varnothing 0,6= 0/-0,008\text{ mm}$
- DC= $\geq \varnothing 0,6= 0/-0,01\text{ mm}</math>$
- RE = $\pm 0,005\text{ mm}</math>$

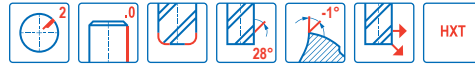

Designation	Item number	Length index	Tool shape	DC	DMM	APMXS	OAL	LN	DN	RE	CA°	PCEDC	Cylindrical
				mm	mm	mm	mm	mm	mm	mm	mm		
JME142002G1R005Z2.0-HXT	03205080	1	G	0,2	4,0	0,15	40,0	0,4	0,18	0,05	15,12	2	■
JME142003G1R005Z2.0-HXT	03205082	1	G	0,3	4,0	0,225	40,0	0,6	0,28	0,05	14,77	2	■
JME142004G1R005Z2.0-HXT	03205084	1	G	0,4	4,0	0,3	40,0	0,8	0,37	0,05	14,39	2	■
JME142005G1R005Z2.0-HXT	03205086	1	G	0,5	4,0	0,375	40,0	0,75	0,46	0,05	14,01	2	■
JME142006G1R005Z2.0-HXT	03205099	1	G	0,6	4,0	0,45	40,0	0,9	0,56	0,05	13,67	2	■
JME142008G1R005Z2.0-HXT	03205121	1	G	0,8	6,0	0,6	50,0	1,2	0,76	0,05	13,98	2	■
JME142010G1R005Z2.0-HXT	03205139	1	G	1,0	6,0	0,75	50,0	1,5	0,95	0,05	13,49	2	■
JME142012G1R005Z2.0-HXT	03205151	1	G	1,2	6,0	0,9	50,0	1,8	1,15	0,05	13,02	2	■
JME142015G1R005Z2.0-HXT	03205161	1	G	1,5	6,0	1,125	50,0	2,25	1,45	0,05	12,3	2	■
JME142002J2R005Z2.0-HXT	03205081	2	J	0,2	4,0	0,15	40,0	0,6	0,18	0,05	14,23	2	■
JME142003J2R005Z2.0-HXT	03205083	2	J	0,3	4,0	0,225	40,0	0,9	0,28	0,05	13,67	2	■
JME142004J2R005Z2.0-HXT	03205085	2	J	0,4	4,0	0,3	40,0	1,2	0,37	0,05	13,1	2	■
JME142005J2R005Z2.0-HXT	03205087	2	J	0,5	4,0	0,375	40,0	1,5	0,46	0,05	12,54	2	■
JME142005J2R010Z2.0-HXT	03205093	2	J	0,5	4,0	0,375	40,0	1,5	0,46	0,1	12,61	2	■
JME142005G2R005Z2.0-HXT	03205088	2	G	0,5	6,0	0,375	50,0	1,5	0,46	0,05	13,5	2	■
JME142005G2R010Z2.0-HXT	03205094	2	G	0,5	6,0	0,375	50,0	1,5	0,46	0,1	13,55	2	■
JME142006J2R005Z2.0-HXT	03205100	2	J	0,6	4,0	0,45	40,0	2,0	0,56	0,05	11,76	2	■
JME142006J2R010Z2.0-HXT	03205107	2	J	0,6	4,0	0,45	40,0	2,0	0,56	0,1	11,83	2	■
JME142006G2R005Z2.0-HXT	03205101	2	G	0,6	6,0	0,45	50,0	2,0	0,56	0,05	9,48	2	■
JME142006G2R010Z2.0-HXT	03205108	2	G	0,6	6,0	0,45	50,0	2,0	0,56	0,1	9,51	2	■
JME142008J2R005Z2.0-HXT	03205122	2	J	0,8	4,0	0,6	40,0	2,5	0,76	0,05	10,92	2	■
JME142008J2R010Z2.0-HXT	03205129	2	J	0,8	4,0	0,6	40,0	2,5	0,76	0,1	10,98	2	■
JME142008J2R020Z2.0-HXT	03205135	2	J	0,8	4,0	0,6	40,0	2,5	0,76	0,2	11,1	2	■
JME142008G2R005Z2.0-HXT	03205123	2	G	0,8	6,0	0,6	50,0	2,5	0,76	0,05	9,15	2	■
JME142008G2R010Z2.0-HXT	03205130	2	G	0,8	6,0	0,6	50,0	2,5	0,76	0,1	9,17	2	■
JME142008G2R020Z2.0-HXT	03205136	2	G	0,8	6,0	0,6	50,0	2,5	0,76	0,2	9,22	2	■
JME142010G2R005Z2.0-HXT	03205140	2	G	1,0	6,0	0,75	50,0	4,0	0,95	0,05	8,29	2	■
JME142010G2R010Z2.0-HXT	03205145	2	G	1,0	6,0	0,75	50,0	4,0	0,95	0,1	8,31	2	■
JME142010G2R020Z2.0-HXT	03205148	2	G	1,0	6,0	0,75	50,0	4,0	0,95	0,2	8,36	2	■
JME142012G2R005Z2.0-HXT	03205152	2	G	1,2	6,0	0,9	50,0	4,5	1,15	0,05	7,97	2	■
JME142012G2R010Z2.0-HXT	03205155	2	G	1,2	6,0	0,9	50,0	4,5	1,15	0,1	7,99	2	■
JME142012G2R020Z2.0-HXT	03205158	2	G	1,2	6,0	0,9	50,0	4,5	1,15	0,2	8,04	2	■
JME142015G2R005Z2.0-HXT	03205162	2	G	1,5	6,0	1,125	50,0	5,0	1,45	0,05	7,6	2	■
JME142015G2R010Z2.0-HXT	03205167	2	G	1,5	6,0	1,125	50,0	5,0	1,45	0,1	9,7	2	■
JME142015G2R020Z2.0-HXT	03205171	2	G	1,5	6,0	1,125	50,0	5,0	1,45	0,2	9,76	2	■

■ Stocked standard.

JME142

Miniature – Hardened steel – Square – 2 Flutes – Cylindrical – Corner radius

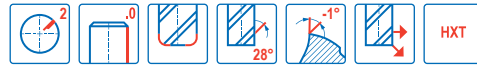
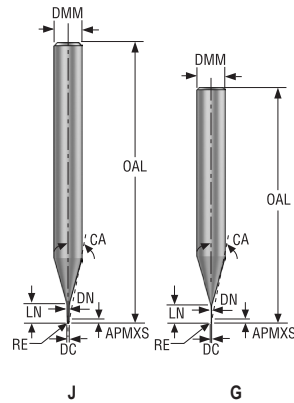

- Tolerances:
- Run-out= <0,005 mm
- DMM = h5
- DC= $\varnothing 0,6= 0/-0,008\text{ mm}$
- DC= $\ge \varnothing 0,6= 0/-0,01\text{ mm}</math>$
- RE = $\pm 0,005\text{ mm}</math>$

Designation	Item number	Length index	Tool shape	DC	DMM	APMXS	OAL	LN	DN	RE	CA°	PCEDC	Cylindrical
				mm	mm	mm	mm	mm	mm	mm	mm	mm	
JME142018G2R005Z2.0-HXT	03205174	2	G	1,8	6,0	1,35	50,0	5,0	1,75	0,05	9,4	2	■
JME142018G2R010Z2.0-HXT	03205177	2	G	1,8	6,0	1,35	50,0	5,0	1,75	0,1	9,43	2	■
JME142020G2R005Z2.0-HXT	03205180	2	G	2,0	6,0	1,5	50,0	6,0	1,94	0,05	8,52	2	■
JME142020G2R010Z2.0-HXT	03205185	2	G	2,0	6,0	1,5	50,0	6,0	1,94	0,1	8,55	2	■
JME142020G2R020Z2.0-HXT	03205188	2	G	2,0	6,0	1,5	50,0	6,0	1,94	0,2	8,6	2	■
JME142020G2R030Z2.0-HXT	03205191	2	G	2,0	6,0	1,5	50,0	6,0	1,94	0,3	8,66	2	■
JME142025G2R005Z2.0-HXT	03205192	2	G	2,5	6,0	1,875	50,0	7,5	2,4	0,05	7,1	2	■
JME142025G2R010Z2.0-HXT	03205195	2	G	2,5	6,0	1,875	50,0	7,5	2,4	0,1	7,13	2	■
JME142025G2R020Z2.0-HXT	03205198	2	G	2,5	6,0	1,875	50,0	7,5	2,4	0,2	7,17	2	■
JME142030G2R005Z2.0-HXT	03205201	2	G	3,0	6,0	2,25	50,0	9,0	2,85	0,05	5,81	2	■
JME142030G2R010Z2.0-HXT	03205205	2	G	3,0	6,0	2,25	50,0	9,0	2,85	0,1	5,82	2	■
JME142030G2R020Z2.0-HXT	03205208	2	G	3,0	6,0	2,25	50,0	9,0	2,85	0,2	5,86	2	■
JME142030G2R030Z2.0-HXT	03205211	2	G	3,0	6,0	2,25	50,0	9,0	2,85	0,3	5,9	2	■
JME142005J3R005Z2.0-HXT	03205089	3	J	0,5	4,0	0,375	40,0	2,5	0,46	0,05	11,24	2	■
JME142005J3R010Z2.0-HXT	03205095	3	J	0,5	4,0	0,375	40,0	2,5	0,46	0,1	11,29	2	■
JME142005G3R005Z2.0-HXT	03205090	3	G	0,5	6,0	0,375	50,0	3,5	0,46	0,05	11,55	2	■
JME142005G3R010Z2.0-HXT	03205096	3	G	0,5	6,0	0,375	50,0	3,5	0,46	0,1	11,59	2	■
JME142006J3R005Z2.0-HXT	03205103	3	J	0,6	4,0	0,45	40,0	3,0	0,56	0,05	10,58	2	■
JME142006J3R010Z2.0-HXT	03205109	3	J	0,6	4,0	0,45	40,0	3,0	0,56	0,1	10,63	2	■
JME142006G3R005Z2.0-HXT	03205104	3	G	0,6	6,0	0,45	50,0	4,0	0,56	0,05	8,46	2	■
JME142006G3R010Z2.0-HXT	03205110	3	G	0,6	6,0	0,45	50,0	4,0	0,56	0,1	8,48	2	■
JME142008J3R005Z2.0-HXT	03205124	3	J	0,8	4,0	0,6	40,0	4,0	0,76	0,05	9,36	2	■
JME142008J3R010Z2.0-HXT	03205131	3	J	0,8	4,0	0,6	40,0	4,0	0,76	0,1	9,4	2	■
JME142008G3R005Z2.0-HXT	03205126	3	G	0,8	6,0	0,6	50,0	5,5	0,76	0,05	9,89	2	■
JME142008G3R010Z2.0-HXT	03205132	3	G	0,8	6,0	0,6	50,0	5,5	0,76	0,1	9,92	2	■
JME142008G3R020Z2.0-HXT	03205137	3	G	0,8	6,0	0,6	50,0	5,5	0,76	0,2	9,98	2	■
JME142010G3R005Z2.0-HXT	03205141	3	G	1,0	6,0	0,75	50,0	7,0	0,95	0,05	8,84	2	■
JME142010G3R010Z2.0-HXT	03205146	3	G	1,0	6,0	0,75	50,0	7,0	0,95	0,1	8,86	2	■
JME142010G3R020Z2.0-HXT	03205149	3	G	1,0	6,0	0,75	50,0	7,0	0,95	0,2	8,91	2	■
JME142012G3R005Z2.0-HXT	03205153	3	G	1,2	6,0	0,9	50,0	8,0	1,15	0,05	8,16	2	■
JME142012G3R010Z2.0-HXT	03205156	3	G	1,2	6,0	0,9	50,0	8,0	1,15	0,1	8,19	2	■
JME142012G3R020Z2.0-HXT	03205159	3	G	1,2	6,0	0,9	50,0	8,0	1,15	0,2	8,23	2	■
JME142015G3R005Z2.0-HXT	03205163	3	G	1,5	6,0	1,125	50,0	10,0	1,45	0,05	7,05	2	■
JME142015G3R010Z2.0-HXT	03205169	3	G	1,5	6,0	1,125	50,0	10,0	1,45	0,1	7,06	2	■
JME142015G3R020Z2.0-HXT	03205172	3	G	1,5	6,0	1,125	50,0	10,0	1,45	0,2	7,1	2	■

■ Stocked standard.

Universal

Steel and cast iron

Stainless steel and S-materials

Non ferrous

Hard

Plastic and CFRP

Graphite

X-Heads

Minimaster Plus

Minimaster

JME142

Miniature – Hardened steel – Square – 2 Flutes – Cylindrical – Corner radius

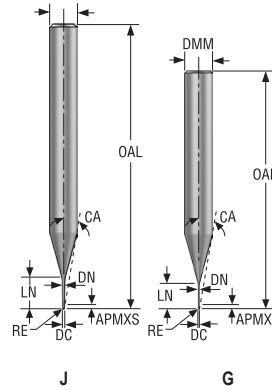

- Tolerances:
- Run-out= <0,005 mm
- DMM = h5
- DC= $\varnothing 0,6= 0/-0,008\text{ mm}$
- DC= $\geq \varnothing 0,6= 0/-0,01\text{ mm}</math>$
- RE = $\pm 0,005\text{ mm}</math>$

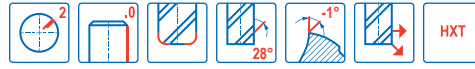

Designation	Item number	Length index	Tool shape	DC	DMM	APMXS	OAL	LN	DN	RE	CA°	PCEDC	Cylindrical
				mm	mm	mm	mm	mm	mm	mm	mm		
JME142018G3R005Z2.0-HXT	03205175	3	G	1,8	6,0	1,35	50,0	10,0	1,75	0,05	6,77	2	■
JME142018G3R010Z2.0-HXT	03205178	3	G	1,8	6,0	1,35	50,0	10,0	1,75	0,1	6,79	2	■
JME142020G3R005Z2.0-HXT	03205181	3	G	2,0	6,0	1,5	50,0	12,0	1,94	0,05	5,9	2	■
JME142020G3R010Z2.0-HXT	03205186	3	G	2,0	6,0	1,5	50,0	12,0	1,94	0,1	5,92	2	■
JME142020G3R020Z2.0-HXT	03205189	3	G	2,0	6,0	1,5	50,0	12,0	1,94	0,2	5,95	2	■
JME142025G3R005Z2.0-HXT	03205193	3	G	2,5	6,0	1,875	50,0	12,5	2,4	0,05	5,25	2	■
JME142025G3R010Z2.0-HXT	03205196	3	G	2,5	6,0	1,875	50,0	12,5	2,4	0,1	5,27	2	■
JME142025G3R020Z2.0-HXT	03205199	3	G	2,5	6,0	1,875	50,0	12,5	2,4	0,2	5,29	2	■
JME142030G3R005Z2.0-HXT	03205202	3	G	3,0	6,0	2,25	60,0	15,0	2,85	0,05	4,14	2	■
JME142030G3R010Z2.0-HXT	03205206	3	G	3,0	6,0	2,25	60,0	15,0	2,85	0,1	4,15	2	■
JME142030G3R020Z2.0-HXT	03205209	3	G	3,0	6,0	2,25	60,0	15,0	2,85	0,2	4,17	2	■
JME142030G3R030Z2.0-HXT	03205212	3	G	3,0	6,0	2,25	60,0	15,0	2,85	0,3	4,19	2	■
JME142005J4R005Z2.0-HXT	03205091	4	J	0,5	4,0	0,375	40,0	4,0	0,46	0,05	9,71	2	■
JME142005J4R010Z2.0-HXT	03205097	4	J	0,5	4,0	0,375	40,0	4,0	0,46	0,1	9,76	2	■
JME142005G4R005Z2.0-HXT	03205092	4	G	0,5	6,0	0,375	50,0	5,0	0,46	0,05	10,42	2	■
JME142005G4R010Z2.0-HXT	03205098	4	G	0,5	6,0	0,375	50,0	5,0	0,46	0,1	10,45	2	■
JME142006J4R005Z2.0-HXT	03205105	4	J	0,6	4,0	0,45	40,0	5,0	0,56	0,05	8,79	2	■
JME142006J4R010Z2.0-HXT	03205118	4	J	0,6	4,0	0,45	40,0	5,0	0,56	0,1	8,83	2	■
JME142006G4R005Z2.0-HXT	03205106	4	G	0,6	6,0	0,45	50,0	6,0	0,56	0,05	9,72	2	■
JME142006G4R010Z2.0-HXT	03205120	4	G	0,6	6,0	0,45	50,0	6,0	0,56	0,1	9,75	2	■
JME142008J4R005Z2.0-HXT	03205127	4	J	0,8	4,0	0,6	40,0	7,0	0,76	0,05	7,28	2	■
JME142008J4R010Z2.0-HXT	03205133	4	J	0,8	4,0	0,6	40,0	7,0	0,76	0,1	7,3	2	■
JME142008G4R005Z2.0-HXT	03205128	4	G	0,8	6,0	0,6	50,0	8,0	0,76	0,05	8,49	2	■
JME142008G4R010Z2.0-HXT	03205134	4	G	0,8	6,0	0,6	50,0	8,0	0,76	0,1	8,51	2	■
JME142008G4R020Z2.0-HXT	03205138	4	G	0,8	6,0	0,6	50,0	8,0	0,76	0,2	8,56	2	■
JME142010G4R005Z2.0-HXT	03205142	4	G	1,0	6,0	0,75	50,0	10,0	0,95	0,05	7,47	2	■
JME142010G4R010Z2.0-HXT	03205147	4	G	1,0	6,0	0,75	50,0	10,0	0,95	0,1	7,48	2	■
JME142010G4R020Z2.0-HXT	03205150	4	G	1,0	6,0	0,75	50,0	10,0	0,95	0,2	7,52	2	■
JME142012G4R005Z2.0-HXT	03205154	4	G	1,2	6,0	0,9	50,0	12,0	1,15	0,05	6,61	2	■
JME142012G4R010Z2.0-HXT	03205157	4	G	1,2	6,0	0,9	50,0	12,0	1,15	0,1	6,62	2	■
JME142012G4R020Z2.0-HXT	03205160	4	G	1,2	6,0	0,9	50,0	12,0	1,15	0,2	6,65	2	■
JME142015G4R005Z2.0-HXT	03205164	4	G	1,5	6,0	1,125	60,0	15,0	1,45	0,05	5,54	2	■
JME142015G4R010Z2.0-HXT	03205170	4	G	1,5	6,0	1,125	60,0	15,0	1,45	0,1	5,55	2	■
JME142015G4R020Z2.0-HXT	03205173	4	G	1,5	6,0	1,125	60,0	15,0	1,45	0,2	5,58	2	■

■ Stocked standard.

Universal

Steel and cast iron

Stainless steel and S-materials

Non ferrous

Hard

Plastic and CFRP

Graphite

X-Heads

Minimaster Plus

Minimaster

JME142

Miniature – Hardened steel – Square – 2 Flutes – Cylindrical – Corner radius

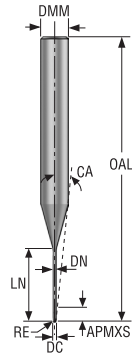

G

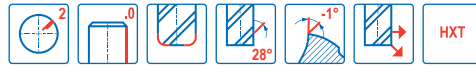

- Tolerances:
- Run-out= <0,005 mm
- DMM = h5
- DC= $\varnothing 0,6 = 0/-0,008 \text{ mm}$
- DC= $\geq \varnothing 0,6 = 0/-0,01 \text{ mm}</math>$
- RE = $\pm 0,005 \text{ mm}</math>$

Designation	Item number	Length index	Tool shape	DC	DMM	APMXS	OAL	LN	DN	RE	CA°	PCEDC	Cylindrical
				mm	mm	mm	mm	mm	mm	mm	mm	mm	
JME142018G4R005Z2.0-HXT	03205176	4	G	1,8	6,0	1,35	60,0	18,0	1,75	0,05	4,68	2	■
JME142018G4R010Z2.0-HXT	03205179	4	G	1,8	6,0	1,35	60,0	18,0	1,75	0,1	4,69	2	■
JME142020G4R005Z2.0-HXT	03205182	4	G	2,0	6,0	1,5	60,0	20,0	1,94	0,05	4,19	2	■
JME142020G4R010Z2.0-HXT	03205187	4	G	2,0	6,0	1,5	60,0	20,0	1,94	0,1	4,19	2	■
JME142020G4R020Z2.0-HXT	03205190	4	G	2,0	6,0	1,5	60,0	20,0	1,94	0,2	4,21	2	■
JME142025G4R005Z2.0-HXT	03205194	4	G	2,5	6,0	1,875	65,0	25,0	2,4	0,05	3,18	2	■
JME142025G4R010Z2.0-HXT	03205197	4	G	2,5	6,0	1,875	65,0	25,0	2,4	0,1	3,19	2	■
JME142025G4R020Z2.0-HXT	03205200	4	G	2,5	6,0	1,875	65,0	25,0	2,4	0,2	3,2	2	■
JME142030G4R010Z2.0-HXT	03205207	4	G	3,0	6,0	2,25	80,0	30,0	2,85	0,1	2,41	2	■
JME142030G4R020Z2.0-HXT	03205210	4	G	3,0	6,0	2,25	80,0	30,0	2,85	0,2	2,42	2	■
JME142030G4R030Z2.0-HXT	03205213	4	G	3,0	6,0	2,25	80,0	30,0	2,85	0,3	2,42	2	■
JME142010G5R005Z2.0-HXT	03205143	5	G	1,0	6,0	0,75	60,0	15,0	0,95	0,05	5,93	2	■
JME142015G5R005Z2.0-HXT	03205165	5	G	1,5	6,0	1,125	80,0	22,5	1,45	0,05	4,2	2	■
JME142020G5R005Z2.0-HXT	03205183	5	G	2,0	6,0	1,5	80,0	30,0	1,94	0,05	3,07	2	■
JME142030G5R005Z2.0-HXT	03205203	5	G	3,0	6,0	2,25	90,0	45,0	2,85	0,05	1,7	2	■
JME142010G6R005Z2.0-HXT	03205144	6	G	1,0	6,0	0,75	60,0	20,0	0,95	0,05	4,92	2	■
JME142015G6R005Z2.0-HXT	03205166	6	G	1,5	6,0	1,125	80,0	30,0	1,45	0,05	3,37	2	■
JME142020G6R005Z2.0-HXT	03205184	6	G	2,0	6,0	1,5	80,0	40,0	1,94	0,05	2,42	2	■
JME142030G6R005Z2.0-HXT	03205204	6	G	3,0	6,0	2,25	90,0	60,0	2,85	0,05	1,31	2	■

■ Stocked standard.

Universal

Steel and cast iron

Stainless steel and S-materials

Non ferrous

Hard

Plastic and CFRP

Graphite

X-Heads

Minimaster Plus

Minimaster

Cutting data – JME142 Side milling roughing

SMG		a _e /DC	a _p /DC	f _z													v _c
				0.2	0.3	0.4	0.5	0.6	0.8	1	1.2	1.5	1.8	2	2.5	3	
H3	M/A	0.0500	0.30	0.0036	0.0055	0.0070	0.0090	0.011	0.014	0.018	0.022	0.026	0.032	0.036	0.044	0.055	90 (59 — 110)
		0,0500	0,30	0,00014	0,00022	0,00028	0,00036	0,00044	0,00055	0,00070	0,00085	0,0010	0,0013	0,0014	0,0017	0,0022	295 (200 — 360)
H5	M/A	0.0500	0.46	0.0040	0.0060	0.0080	0.010	0.012	0.016	0.020	0.024	0.030	0.036	0.040	0.050	0.060	160 (140 — 190)
		0,0500	0,46	0,00016	0,00024	0,00032	0,00040	0,00048	0,00065	0,00080	0,00095	0,0012	0,0014	0,0016	0,0020	0,0024	520 (460 — 620)
H7	M/A	0.0500	0.30	0.0036	0.0055	0.0070	0.0090	0.011	0.014	0.018	0.022	0.026	0.032	0.036	0.044	0.055	90 (59 — 110)
		0,0500	0,30	0,00014	0,00022	0,00028	0,00036	0,00044	0,00055	0,00070	0,00085	0,0010	0,0013	0,0014	0,0017	0,0022	295 (200 — 360)
H8	M/A	0.0500	0.46	0.0040	0.0060	0.0080	0.010	0.012	0.016	0.020	0.024	0.030	0.036	0.040	0.050	0.060	160 (140 — 190)
		0,0500	0,46	0,00016	0,00024	0,00032	0,00040	0,00048	0,00065	0,00080	0,00095	0,0012	0,0014	0,0016	0,0020	0,0024	520 (460 — 620)
H11	M/A	0.0500	0.46	0.0040	0.0060	0.0080	0.010	0.012	0.016	0.020	0.024	0.030	0.036	0.040	0.050	0.060	205 (170 — 240)
		0,0500	0,46	0,00016	0,00024	0,00032	0,00040	0,00048	0,00065	0,00080	0,00095	0,0012	0,0014	0,0016	0,0020	0,0024	670 (560 — 780)
H12	M/A	0.0500	0.46	0.0040	0.0060	0.0080	0.010	0.012	0.016	0.020	0.024	0.030	0.036	0.040	0.050	0.060	190 (160 — 220)
		0,0500	0,46	0,00016	0,00024	0,00032	0,00040	0,00048	0,00065	0,00080	0,00095	0,0012	0,0014	0,0016	0,0020	0,0024	620 (530 — 720)
H21	M/A	0.0500	0.46	0.0040	0.0060	0.0080	0.010	0.012	0.016	0.020	0.024	0.030	0.036	0.040	0.050	0.060	160 (140 — 190)
		0,0500	0,46	0,00016	0,00024	0,00032	0,00040	0,00048	0,00065	0,00080	0,00095	0,0012	0,0014	0,0016	0,0020	0,0024	520 (460 — 620)
H31	M/A	0.0500	0.46	0.0040	0.0060	0.0080	0.010	0.012	0.016	0.020	0.024	0.030	0.036	0.040	0.050	0.060	120 (110 — 140)
		0,0500	0,46	0,00016	0,00024	0,00032	0,00040	0,00048	0,00065	0,00080	0,00095	0,0012	0,0014	0,0016	0,0020	0,0024	395 (370 — 450)

Cutting data – JME142 Slot milling

SMG		a _p /DC	f _z													v _c
			0.2	0.3	0.4	0.5	0.6	0.8	1	1.2	1.5	1.8	2	2.5	3	
H3	M/A	0.012	0.0024	0.0036	0.0048	0.0060	0.0070	0.0095	0.012	0.014	0.018	0.022	0.024	0.030	0.036	65 (43 — 85)
		0,012	0,000095	0,00014	0,00019	0,00024	0,00028	0,00038	0,00048	0,00055	0,00070	0,00085	0,00095	0,0012	0,0014	215 (150 — 270)
H5	M/A	0.020	0.0040	0.0060	0.0080	0.010	0.012	0.016	0.020	0.024	0.030	0.036	0.040	0.050	0.060	120 (97 — 130)
		0,020	0,00016	0,00024	0,00032	0,00040	0,00048	0,00065	0,00080	0,00095	0,0012	0,0014	0,0016	0,0020	0,0024	395 (320 — 420)
H7	M/A	0.012	0.0024	0.0036	0.0048	0.0060	0.0070	0.0095	0.012	0.014	0.018	0.022	0.024	0.030	0.036	65 (43 — 85)
		0,012	0,000095	0,00014	0,00019	0,00024	0,00028	0,00038	0,00048	0,00055	0,00070	0,00085	0,00095	0,0012	0,0014	215 (150 — 270)
H8	M/A	0.020	0.0040	0.0060	0.0080	0.010	0.012	0.016	0.020	0.024	0.030	0.036	0.040	0.050	0.060	120 (97 — 130)
		0,020	0,00016	0,00024	0,00032	0,00040	0,00048	0,00065	0,00080	0,00095	0,0012	0,0014	0,0016	0,0020	0,0024	395 (320 — 420)
H11	M/A	0.020	0.0040	0.0060	0.0080	0.010	0.012	0.016	0.020	0.024	0.030	0.036	0.040	0.050	0.060	150 (130 — 170)
		0,020	0,00016	0,00024	0,00032	0,00040	0,00048	0,00065	0,00080	0,00095	0,0012	0,0014	0,0016	0,0020	0,0024	490 (430 — 550)
H12	M/A	0.020	0.0040	0.0060	0.0080	0.010	0.012	0.016	0.020	0.024	0.030	0.036	0.040	0.050	0.060	135 (120 — 160)
		0,020	0,00016	0,00024	0,00032	0,00040	0,00048	0,00065	0,00080	0,00095	0,0012	0,0014	0,0016	0,0020	0,0024	445 (400 — 520)
H21	M/A	0.012	0.0024	0.0036	0.0048	0.0060	0.0070	0.0095	0.012	0.014	0.018	0.022	0.024	0.030	0.036	120 (98 — 140)
		0,012	0,000095	0,00014	0,00019	0,00024	0,00028	0,00038	0,00048	0,00055	0,00070	0,00085	0,00095	0,0012	0,0014	395 (330 — 450)
H31	M/A	0.020	0.0040	0.0060	0.0080	0.010	0.012	0.016	0.020	0.024	0.030	0.036	0.040	0.050	0.060	90 (73 — 100)
		0,020	0,00016	0,00024	0,00032	0,00040	0,00048	0,00065	0,00080	0,00095	0,0012	0,0014	0,0016	0,0020	0,0024	295 (240 — 320)

For cutting data recalculations, see pages 556 - 563

SMG = Seco material group
 Coolant = A=air D=dry E=emulsion M=mist spray
 v_c = m/min (sf/min)
 f_z = mm (in/tooth)
 a_p = mm/DC (in/DC) = factor
 a_e = mm/DC (in/DC) = factor
 All cutting data are target values

JME144

Miniature – Hardened steel – Square – 4 Flutes – Cylindrical – Corner radius

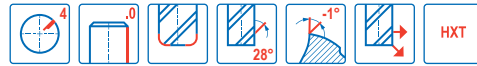
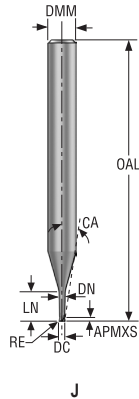

- Tolerances:
- Run-out= <0,005 mm
- DMM=h5
- DC = 0-0,01 mm
- RE= ±0,005 mm

Designation	Item number	Length index	Tool shape	DC	DMM	APMXS	OAL	LN	DN	RE	CA°	PCEDC	Cylindrical
				mm	mm	mm	mm	mm	mm	mm	mm		
JME144010J2R005Z4.0-HXT	03205214	2	J	1,0	4,0	0,75	40,0	4,0	0,95	0,05	9,08	4	■
JME144010J2R010Z4.0-HXT	03205217	2	J	1,0	4,0	0,75	40,0	4,0	0,95	0,1	9,13	4	■
JME144010J2R020Z4.0-HXT	03205220	2	J	1,0	4,0	0,75	40,0	4,0	0,95	0,2	9,22	4	■
JME144012J2R005Z4.0-HXT	03205221	2	J	1,2	4,0	0,9	50,0	4,5	1,15	0,05	8,37	4	■
JME144012J2R010Z4.0-HXT	03205224	2	J	1,2	4,0	0,9	50,0	4,5	1,15	0,1	8,41	4	■
JME144015J2R005Z4.0-HXT	03205227	2	J	1,5	4,0	1,125	50,0	5,0	1,45	0,05	7,52	4	■
JME144015J2R010Z4.0-HXT	03205229	2	J	1,5	4,0	1,125	50,0	5,0	1,45	0,1	7,56	4	■
JME144015J2R020Z4.0-HXT	03205232	2	J	1,5	4,0	1,125	50,0	5,0	1,45	0,2	7,63	4	■
JME144020J2R005Z4.0-HXT	03205234	2	J	2,0	4,0	1,5	50,0	6,0	1,94	0,05	5,97	4	■
JME144020J2R010Z4.0-HXT	03205236	2	J	2,0	4,0	1,5	50,0	6,0	1,94	0,1	6,0	4	■
JME144020J2R020Z4.0-HXT	03205239	2	J	2,0	4,0	1,5	50,0	6,0	1,94	0,2	6,06	4	■
JME144020J2R030Z4.0-HXT	03205241	2	J	2,0	4,0	1,5	50,0	6,0	1,94	0,3	6,12	4	■
JME144030J2R010Z4.0-HXT	03205243	2	J	3,0	4,0	2,25	50,0	9,0	2,85	0,1	2,66	4	■
JME144030J2R020Z4.0-HXT	03205246	2	J	3,0	4,0	2,25	50,0	9,0	2,85	0,2	2,69	4	■
JME144010J3R005Z4.0-HXT	03205215	3	J	1,0	4,0	0,75	40,0	5,0	0,95	0,05	8,27	4	■
JME144010J3R010Z4.0-HXT	03205218	3	J	1,0	4,0	0,75	40,0	5,0	0,95	0,1	8,3	4	■
JME144012J3R005Z4.0-HXT	03205222	3	J	1,2	4,0	0,9	50,0	6,0	1,15	0,05	7,3	4	■
JME144012J3R010Z4.0-HXT	03205225	3	J	1,2	4,0	0,9	50,0	6,0	1,15	0,1	7,33	4	■
JME144015J3R005Z4.0-HXT	03205228	3	J	1,5	4,0	1,125	50,0	7,5	1,45	0,05	6,04	4	■
JME144015J3R010Z4.0-HXT	03205230	3	J	1,5	4,0	1,125	50,0	7,5	1,45	0,1	6,06	4	■
JME144020J3R005Z4.0-HXT	03205235	3	J	2,0	4,0	1,5	50,0	10,0	1,94	0,05	4,29	4	■
JME144020J3R010Z4.0-HXT	03205237	3	J	2,0	4,0	1,5	50,0	10,0	1,94	0,1	4,31	4	■
JME144030J3R005Z4.0-HXT	03205242	3	J	3,0	4,0	2,25	50,0	15,0	2,85	0,05	1,74	4	■
JME144030J3R010Z4.0-HXT	03205244	3	J	3,0	4,0	2,25	50,0	15,0	2,85	0,1	1,75	4	■
JME144010J4R005Z4.0-HXT	03205216	4	J	1,0	4,0	0,75	40,0	8,5	0,95	0,05	6,28	4	■
JME144010J4R010Z4.0-HXT	03205219	4	J	1,0	4,0	0,75	40,0	8,5	0,95	0,1	6,31	4	■
JME144012J4R005Z4.0-HXT	03205223	4	J	1,2	4,0	0,9	50,0	10,0	1,15	0,05	5,44	4	■
JME144012J4R010Z4.0-HXT	03205226	4	J	1,2	4,0	0,9	50,0	10,0	1,15	0,1	5,46	4	■
JME144015J4R010Z4.0-HXT	03205231	4	J	1,5	4,0	1,125	60,0	12,0	1,45	0,1	4,46	4	■
JME144015J4R020Z4.0-HXT	03205233	4	J	1,5	4,0	1,125	60,0	12,0	1,45	0,2	4,49	4	■
JME144020J4R010Z4.0-HXT	03205238	4	J	2,0	4,0	1,5	60,0	16,0	1,94	0,1	3,02	4	■
JME144020J4R020Z4.0-HXT	03205240	4	J	2,0	4,0	1,5	60,0	16,0	1,94	0,2	3,04	4	■
JME144030J4R010Z4.0-HXT	03205245	4	J	3,0	4,0	2,25	60,0	24,0	2,85	0,1	1,16	4	■
JME144030J4R020Z4.0-HXT	03205248	4	J	3,0	4,0	2,25	60,0	24,0	2,85	0,2	1,16	4	■

■ Stocked standard.

Universal

Steel and cast iron

Stainless steel and S-materials

Non ferrous

Hard

Plastic and CFRP

Graphite

X-Heads

Minimaster Plus

Minimaster

Cutting data – JME144 Side milling roughing

SMG		a _e /DC	a _p /DC	f _z					v _c
				1.0	1.2	1.5	2.0	3	
H3	M/A	0.0500	0.095	0.013	0.016	0.020	0.026	0.040	95 (65 – 120)
		0,0500	0,095	0,00050	0,00065	0,00080	0,0010	0,0016	310 (220 – 390)
H5	M/A	0.0500	0.22	0.014	0.017	0.020	0.028	0.042	165 (140 – 190)
		0,0500	0,22	0,00055	0,00065	0,00080	0,0011	0,0017	540 (460 – 620)
H7	M/A	0.0500	0.095	0.013	0.016	0.020	0.026	0.040	95 (65 – 120)
		0,0500	0,095	0,00050	0,00065	0,00080	0,0010	0,0016	310 (220 – 390)
H8	M/A	0.0500	0.22	0.014	0.017	0.020	0.028	0.042	165 (140 – 190)
		0,0500	0,22	0,00055	0,00065	0,00080	0,0011	0,0017	540 (460 – 620)
H11	M/A	0.0500	0.22	0.014	0.017	0.020	0.028	0.042	210 (180 – 240)
		0,0500	0,22	0,00055	0,00065	0,00080	0,0011	0,0017	690 (600 – 780)
H12	M/A	0.0500	0.22	0.014	0.017	0.020	0.028	0.042	190 (160 – 220)
		0,0500	0,22	0,00055	0,00065	0,00080	0,0011	0,0017	620 (530 – 720)
H21	M/A	0.0500	0.22	0.014	0.017	0.020	0.028	0.042	165 (140 – 190)
		0,0500	0,22	0,00055	0,00065	0,00080	0,0011	0,0017	540 (460 – 620)
H31	M/A	0.0500	0.22	0.014	0.017	0.020	0.028	0.042	125 (110 – 140)
		0,0500	0,22	0,00055	0,00065	0,00080	0,0011	0,0017	410 (370 – 450)

Cutting data – JME144 Slot milling

SMG		a _p /DC	f _z					v _c
			1.0	1.2	1.5	2.0	3.0	
H3	M/A	0.0090	0.0065	0.0075	0.0095	0.013	0.019	65 (43 – 84)
		0,0090	0,00026	0,00030	0,00038	0,00050	0,00075	215 (150 – 270)
H5	M/A	0.019	0.012	0.014	0.018	0.024	0.036	115 (96 – 130)
		0,019	0,00048	0,00055	0,00070	0,00095	0,0014	375 (320 – 420)
H7	M/A	0.0090	0.0065	0.0075	0.0095	0.013	0.019	65 (43 – 84)
		0,0090	0,00026	0,00030	0,00038	0,00050	0,00075	215 (150 – 270)
H8	M/A	0.019	0.012	0.014	0.018	0.024	0.036	115 (96 – 130)
		0,019	0,00048	0,00055	0,00070	0,00095	0,0014	375 (320 – 420)
H11	M/A	0.019	0.012	0.014	0.018	0.024	0.036	150 (130 – 170)
		0,019	0,00048	0,00055	0,00070	0,00095	0,0014	490 (430 – 550)
H12	M/A	0.019	0.012	0.014	0.018	0.024	0.036	135 (120 – 160)
		0,019	0,00048	0,00055	0,00070	0,00095	0,0014	445 (400 – 520)
H21	M/A	0.019	0.012	0.014	0.018	0.024	0.036	115 (96 – 130)
		0,019	0,00048	0,00055	0,00070	0,00095	0,0014	375 (320 – 420)
H31	M/A	0.019	0.012	0.014	0.018	0.024	0.036	90 (73 – 100)
		0,019	0,00048	0,00055	0,00070	0,00095	0,0014	295 (240 – 320)

For cutting data recalculations, see pages 556 - 563

SMG = Seco material group
Coolant = A=air D=dry E=emulsion M=mist spray
v_c = m/min (sf/min)
f_z = mm (in/tooth)
a_p = mm/DC (in/DC) = factor
a_e = mm/DC (in/DC) = factor
All cutting data are target values

JMB112

Miniature – Hardened steel – Ball nose – 2 Flutes – Cylindrical

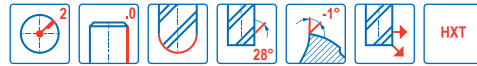
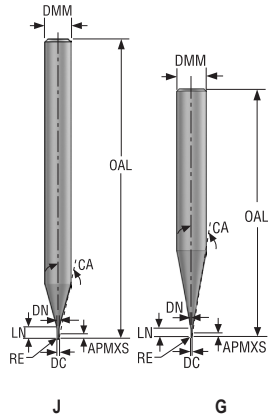

- Tolerances:
- Run-out= <0,005 mm
- DMM= h5
- DC= $\lt;0,6= 0/-0,008\text{ mm}$
- DC= $\geq 0,6= 0/-0,01\text{ mm}$
- RE= $\lt;0,5= \pm 0,004\text{ mm}$
- RE= $\geq 0,5= \pm 0,005\text{ mm}$

Designation	Item number	Length index	Tool shape	DC	DMM	APMXS	OAL	LN	DN	RE	CA°	PCEDC	Cylindrical
				mm	mm	mm	mm	mm	mm	mm	mm	mm	
JMB112002G1BZ2.0-HXT	03204964	1	G	0,2	4,0	0,15	40,0	0,4	0,18	0,1	15,11	2	■
JMB112003G1BZ2.0-HXT	03204966	1	G	0,3	4,0	0,225	40,0	0,6	0,28	0,15	14,77	2	■
JMB112004G1BZ2.0-HXT	03204968	1	G	0,4	4,0	0,3	40,0	0,8	0,37	0,2	14,32	2	■
JMB112005G1BZ2.0-HXT	03204970	1	G	0,5	4,0	0,5	40,0	1,0	0,46	0,25	13,97	2	■
JMB112006G1BZ2.0-HXT	03204977	1	G	0,6	4,0	0,6	40,0	1,2	0,56	0,3	13,64	2	■
JMB112008G1BZ2.0-HXT	03204984	1	G	0,8	6,0	0,8	50,0	1,6	0,76	0,4	13,96	2	■
JMB112010G1BZ2.0-HXT	03204991	1	G	1,0	6,0	1,0	50,0	2,0	0,95	0,5	13,49	2	■
JMB112012G1BZ2.0-HXT	03205000	1	G	1,2	6,0	1,2	50,0	2,4	1,15	0,6	13,02	2	■
JMB112015G1BZ2.0-HXT	03205009	1	G	1,5	6,0	1,5	50,0	3,0	1,45	0,75	12,2	2	■
JMB112002J2BZ2.0-HXT	03204965	2	J	0,2	4,0	0,15	40,0	0,6	0,18	0,1	14,33	2	■
JMB112003J2BZ2.0-HXT	03204967	2	J	0,3	4,0	0,225	40,0	0,9	0,28	0,15	13,85	2	■
JMB112004J2BZ2.0-HXT	03204969	2	J	0,4	4,0	0,3	40,0	1,2	0,37	0,2	13,3	2	■
JMB112005J2BZ2.0-HXT	03204971	2	J	0,5	4,0	0,5	40,0	1,5	0,46	0,25	12,85	2	■
JMB112005G2BZ2.0-HXT	03204972	2	G	0,5	6,0	0,5	50,0	1,5	0,46	0,25	9,91	2	■
JMB112006J2BZ2.0-HXT	03204978	2	J	0,6	4,0	0,6	50,0	2,0	0,56	0,3	12,09	2	■
JMB112006G2BZ2.0-HXT	03204979	2	G	0,6	6,0	0,6	50,0	2,0	0,56	0,3	9,62	2	■
JMB112008J2BZ2.0-HXT	03204985	2	J	0,8	4,0	0,8	50,0	2,5	0,76	0,4	11,34	2	■
JMB112008G2BZ2.0-HXT	03204986	2	G	0,8	6,0	0,8	50,0	2,5	0,76	0,4	9,33	2	■
JMB112010J2BZ2.0-HXT	03204992	2	J	1,0	4,0	1,0	40,0	4,0	0,95	0,5	9,49	2	■
JMB112010G2BZ2.0-HXT	03204993	2	G	1,0	6,0	1,0	50,0	4,0	0,95	0,5	8,49	2	■
JMB112012J2BZ2.0-HXT	03205001	2	J	1,2	4,0	1,2	50,0	4,5	1,15	0,6	8,83	2	■
JMB112012G2BZ2.0-HXT	03205002	2	G	1,2	6,0	1,2	50,0	4,5	1,15	0,6	8,21	2	■
JMB112015J2BZ2.0-HXT	03205010	2	J	1,5	4,0	1,5	50,0	5,0	1,45	0,75	8,1	2	■
JMB112015G2BZ2.0-HXT	03205011	2	G	1,5	6,0	1,5	50,0	5,0	1,45	0,75	10,14	2	■
JMB112018J2BZ2.0-HXT	03205019	2	J	1,8	4,0	1,8	50,0	5,0	1,75	0,9	7,71	2	■
JMB112018G2BZ2.0-HXT	03205018	2	G	1,8	6,0	1,8	50,0	5,0	1,75	0,9	9,99	2	■
JMB112020J2BZ2.0-HXT	03205024	2	J	2,0	4,0	2,0	50,0	6,0	1,94	1,0	6,6	2	■
JMB112020G2BZ2.0-HXT	03205025	2	G	2,0	6,0	2,0	50,0	6,0	1,94	1,0	9,1	2	■
JMB112025J2BZ2.0-HXT	03205032	2	J	2,5	4,0	2,5	50,0	7,5	2,4	1,25	4,75	2	■
JMB112025G2BZ2.0-HXT	03205033	2	G	2,5	6,0	2,5	50,0	7,5	2,4	1,25	7,71	2	■
JMB112030J2BZ2.0-HXT	03205037	2	J	3,0	4,0	3,0	50,0	9,0	2,85	1,5	3,04	2	■
JMB112030G2BZ2.0-HXT	03205038	2	G	3,0	6,0	3,0	50,0	9,0	2,85	1,5	6,35	2	■

■ Stocked standard.

Universal

Steel and cast iron

Stainless steel and S-materials

Non ferrous

Hard

Plastic and CFRP

Graphite

X-Heads

Minimaster Plus

Minimaster

JMB112

Miniature – Hardened steel – Ball nose – 2 Flutes – Cylindrical

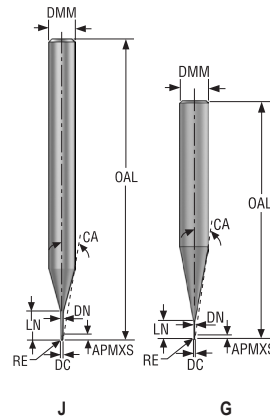

- Tolerances:
- Run-out= <0,005 mm
- DMM= h5
- DC= $\lt;0,6$= 0/-0,008 mm
- DC= $\geq 0,6$= 0/-0,01 mm
- RE= $\lt;0,5$= $\pm 0,004$ mm
- RE= $\geq 0,5$= $\pm 0,005$ mm

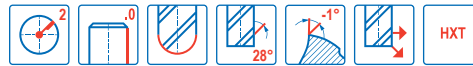

Designation	Item number	Length index	Tool shape	DC	DMM	APMXS	OAL	LN	DN	RE	CA°	PCEDC	Cylindrical
				mm	mm	mm	mm	mm	mm	mm	mm		
JMB112005J3BZ2.0-HXT	03204973	3	J	0,5	4,0	0,5	40,0	2,5	0,46	0,25	11,49	2	■
JMB112005G3BZ2.0-HXT	03204974	3	G	0,5	6,0	0,5	50,0	3,5	0,46	0,25	8,81	2	■
JMB112006J3BZ2.0-HXT	03204980	3	J	0,6	4,0	0,6	40,0	3,0	0,56	0,3	10,83	2	■
JMB112006G3BZ2.0-HXT	03204981	3	G	0,6	6,0	0,6	50,0	4,0	0,56	0,3	8,56	2	■
JMB112008J3BZ2.0-HXT	03204987	3	J	0,8	4,0	0,8	40,0	4,0	0,76	0,4	9,67	2	■
JMB112008G3BZ2.0-HXT	03204988	3	G	0,8	6,0	0,8	50,0	5,5	0,76	0,4	10,1	2	■
JMB112010J3BZ2.0-HXT	03204994	3	J	1,0	4,0	1,0	40,0	5,0	0,95	0,5	8,6	2	■
JMB112010G3BZ2.0-HXT	03204995	3	G	1,0	6,0	1,0	50,0	7,0	0,95	0,5	9,06	2	■
JMB112012J3BZ2.0-HXT	03205003	3	J	1,2	4,0	1,2	50,0	6,0	1,15	0,6	7,65	2	■
JMB112012G3BZ2.0-HXT	03205004	3	G	1,2	6,0	1,2	50,0	8,0	1,15	0,6	8,42	2	■
JMB112015J3BZ2.0-HXT	03205012	3	J	1,5	4,0	1,5	40,0	7,5	1,45	0,75	6,4	2	■
JMB112015G3BZ2.0-HXT	03205013	3	G	1,5	6,0	1,5	50,0	10,0	1,45	0,75	7,31	2	■
JMB112018J3BZ2.0-HXT	03205020	3	J	1,8	4,0	1,8	50,0	9,0	1,75	0,9	5,28	2	■
JMB112018G3BZ2.0-HXT	03205021	3	G	1,8	6,0	1,8	50,0	12,0	1,75	0,9	6,35	2	■
JMB112020J3BZ2.0-HXT	03205026	3	J	2,0	4,0	2,0	50,0	10,0	1,94	1,0	4,61	2	■
JMB112020G3BZ2.0-HXT	03205027	3	G	2,0	6,0	2,0	50,0	12,0	1,94	1,0	6,19	2	■
JMB112025J3BZ2.0-HXT	03205034	3	J	2,5	4,0	2,5	50,0	12,5	2,4	1,25	3,13	2	■
JMB112025G3BZ2.0-HXT	03205035	3	G	2,5	6,0	2,5	50,0	15,0	2,4	1,25	4,91	2	■
JMB112030J3BZ2.0-HXT	03205039	3	J	3,0	4,0	3,0	50,0	15,0	2,85	1,5	1,91	2	■
JMB112030G3BZ2.0-HXT	03205040	3	G	3,0	6,0	3,0	60,0	15,0	2,85	1,5	4,41	2	■

■ Stocked standard.

Universal

Steel and cast iron

Stainless steel and S-materials

Non ferrous

Hard

Plastic and CFRP

Graphite

X-Heads

Minimaster Plus

Minimaster

JMB112

Miniature – Hardened steel – Ball nose – 2 Flutes – Cylindrical

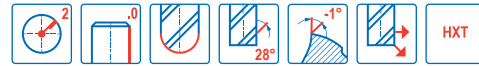
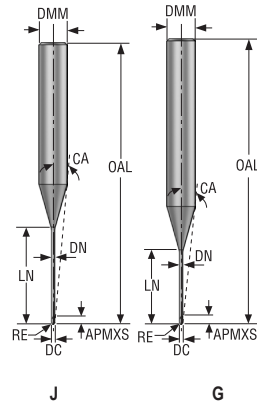

- Tolerances:
- Run-out= <0,005 mm
- DMM= h5
- DC= $\lt;0,6= 0/-0,008\text{ mm}$
- DC= $\ge 0,6= 0/-0,01\text{ mm}$
- RE= $\lt;0,5= \pm 0,004\text{ mm}$
- RE= $\ge 0,5= \pm 0,005\text{ mm}$

Designation	Item number	Length index	Tool shape	DC	DMM	APMXS	OAL	LN	DN	RE	CA°	PCEDC	Cylindrical
				mm	mm	mm	mm	mm	mm	mm	mm	mm	
JMB112005J4BZ2.0-HXT	03204975	4	J	0,5	4,0	0,5	40,0	4,0	0,46	0,25	9,9	2	■
JMB112005G4BZ2.0-HXT	03204976	4	G	0,5	6,0	0,5	50,0	5,0	0,46	0,25	10,55	2	■
JMB112006J4BZ2.0-HXT	03204982	4	J	0,6	4,0	0,6	40,0	5,0	0,56	0,3	8,97	2	■
JMB112006G4BZ2.0-HXT	03204983	4	G	0,6	6,0	0,6	50,0	6,0	0,56	0,3	9,86	2	■
JMB112008J4BZ2.0-HXT	03204989	4	J	0,8	4,0	0,8	40,0	7,0	0,76	0,4	7,46	2	■
JMB112008G4BZ2.0-HXT	03204990	4	G	0,8	6,0	0,8	50,0	8,0	0,76	0,4	8,65	2	■
JMB112010J4BZ2.0-HXT	03204996	4	J	1,0	4,0	1,0	40,0	8,5	0,95	0,5	6,48	2	■
JMB112010G4BZ2.0-HXT	03204998	4	G	1,0	6,0	1,0	50,0	10,0	0,95	0,5	7,63	2	■
JMB112012J4BZ2.0-HXT	03205005	4	J	1,2	4,0	1,2	50,0	10,0	1,15	0,6	5,63	2	■
JMB112012G4BZ2.0-HXT	03205006	4	G	1,2	6,0	1,2	50,0	12,0	1,15	0,6	8,77	2	■
JMB112015J4BZ2.0-HXT	03205014	4	J	1,5	4,0	1,5	60,0	12,0	1,45	0,75	4,65	2	■
JMB112015G4BZ2.0-HXT	03205015	4	G	1,5	6,0	1,5	70,0	15,0	1,45	0,75	5,7	2	■
JMB112018J4BZ2.0-HXT	03205022	4	J	1,8	4,0	1,8	60,0	15,0	1,75	0,9	3,57	2	■
JMB112018G4BZ2.0-HXT	03205023	4	G	1,8	6,0	1,8	60,0	18,0	1,75	0,9	4,83	2	■
JMB112020J4BZ2.0-HXT	03205028	4	J	2,0	4,0	2,0	60,0	16,0	1,94	1,0	3,17	2	■
JMB112020G4BZ2.0-HXT	03205029	4	G	2,0	6,0	2,0	60,0	18,0	1,94	1,0	4,68	2	■
JMB112025G4BZ2.0-HXT	03205036	4	G	2,5	6,0	2,5	65,0	25,0	2,4	1,25	3,3	2	■
JMB112030J4BZ2.0-HXT	03205041	4	J	3,0	4,0	3,0	60,0	24,0	2,85	1,5	1,22	2	■
JMB112030G4BZ2.0-HXT	03205042	4	G	3,0	6,0	3,0	80,0	30,0	2,85	1,5	2,51	2	■
JMB112010G5BZ2.0-HXT	03204999	5	G	1,0	6,0	1,0	60,0	15,0	0,95	0,5	6,04	2	■
JMB112012G5BZ2.0-HXT	03205007	5	G	1,2	6,0	1,2	60,0	18,0	1,15	0,6	5,24	2	■
JMB112015G5BZ2.0-HXT	03205016	5	G	1,5	6,0	1,5	70,0	22,5	1,45	0,75	4,29	2	■
JMB112020G5BZ2.0-HXT	03205030	5	G	2,0	6,0	2,0	80,0	30,0	1,94	1,0	3,15	2	■
JMB112030G5BZ2.0-HXT	03205043	5	G	3,0	6,0	3,0	90,0	45,0	2,85	1,5	1,75	2	■
JMB112010G6BZ2.0-HXT	03205054	6	G	1,0	6,0	1,0	60,0	20,0	0,95	0,5	4,99	2	■
JMB112012G6BZ2.0-HXT	03205008	6	G	1,2	6,0	1,2	70,0	24,0	1,15	0,6	4,27	2	■
JMB112015G6BZ2.0-HXT	03205017	6	G	1,5	6,0	1,5	80,0	30,0	1,45	0,75	3,44	2	■
JMB112020G6BZ2.0-HXT	03205031	6	G	2,0	6,0	2,0	80,0	40,0	1,94	1,0	2,47	2	■
JMB112030G6BZ2.0-HXT	03205045	6	G	3,0	6,0	3,0	90,0	60,0	2,85	1,5	1,34	2	■

■ Stocked standard.

Universal

Steel and cast iron

Stainless steel and S-materials

Non ferrous

Hard

Plastic and CFRP

Graphite

X-Heads

Minimaster Plus

Minimaster

Cutting data – JMB112 Copy milling roughing

SMG		a _e /DC	a _p /DC	f _z													v _c
				0.2	0.3	0.4	0.5	0.6	0.8	1	1.2	1.5	1.8	2	2.5	3	
H3	M	0.0500	0.30	0.0036	0.0055	0.0070	0.0090	0.011	0.014	0.018	0.022	0.026	0.032	0.036	0.044	0.048	150 (130 – 170)
		0,0500	0,30	0,00014	0,00022	0,00028	0,00036	0,00044	0,00055	0,00070	0,00085	0,0010	0,0013	0,0014	0,0017	0,0019	490 (430 – 550)
H5	M	0.0500	0.44	0.0040	0.0060	0.0080	0.010	0.012	0.016	0.020	0.024	0.030	0.036	0.040	0.050	0.060	220 (200 – 240)
		0,0500	0,44	0,00016	0,00024	0,00032	0,00040	0,00048	0,00065	0,00080	0,00095	0,0012	0,0014	0,0016	0,0020	0,0024	720 (660 – 780)
H7	M	0.0500	0.30	0.0036	0.0055	0.0070	0.0090	0.011	0.014	0.018	0.022	0.026	0.032	0.036	0.044	0.048	150 (130 – 170)
		0,0500	0,30	0,00014	0,00022	0,00028	0,00036	0,00044	0,00055	0,00070	0,00085	0,0010	0,0013	0,0014	0,0017	0,0019	490 (430 – 550)
H8	M	0.0500	0.44	0.0040	0.0060	0.0080	0.010	0.012	0.016	0.020	0.024	0.030	0.036	0.040	0.048	0.050	220 (200 – 240)
		0,0500	0,44	0,00016	0,00024	0,00032	0,00040	0,00048	0,00065	0,00080	0,00095	0,0012	0,0014	0,0016	0,0019	0,0020	720 (660 – 780)
H11	M	0.0500	0.44	0.0040	0.0060	0.0080	0.010	0.012	0.016	0.020	0.024	0.030	0.036	0.040	0.050	0.060	280 (250 – 310)
		0,0500	0,44	0,00016	0,00024	0,00032	0,00040	0,00048	0,00065	0,00080	0,00095	0,0012	0,0014	0,0016	0,0020	0,0024	920 (830 – 1000)
H12	M	0.0500	0.44	0.0040	0.0060	0.0080	0.010	0.012	0.016	0.020	0.024	0.030	0.036	0.040	0.048	0.050	255 (230 – 280)
		0,0500	0,44	0,00016	0,00024	0,00032	0,00040	0,00048	0,00065	0,00080	0,00095	0,0012	0,0014	0,0016	0,0019	0,0020	840 (760 – 910)
H21	M	0.0500	0.44	0.0040	0.0060	0.0080	0.010	0.012	0.016	0.020	0.024	0.030	0.036	0.040	0.048	0.050	220 (200 – 240)
		0,0500	0,44	0,00016	0,00024	0,00032	0,00040	0,00048	0,00065	0,00080	0,00095	0,0012	0,0014	0,0016	0,0019	0,0020	720 (660 – 780)
H31	M	0.0500	0.44	0.0040	0.0060	0.0080	0.010	0.012	0.016	0.020	0.024	0.030	0.034	0.036	0.042	0.044	165 (150 – 180)
		0,0500	0,44	0,00016	0,00024	0,00032	0,00040	0,00048	0,00065	0,00080	0,00095	0,0012	0,0013	0,0014	0,0017	0,0017	540 (500 – 590)

For cutting data recalculations, see pages 556 - 563

SMG = Seco material group
Coolant = A=air D=dry E=emulsion M=mist spray
v_c = m/min (sf/min)
f_z = mm (in/tooth)
a_p = mm/DC (in/DC) = factor
a_e = mm/DC (in/DC) = factor
All cutting data are target values

Universal
Steel and cast iron
Stainless steel and S-materials
Non ferrous
Hard
Plastic and CFRP
Graphite
X-Heads
Minimaster Plus
Minimaster



PLASTIC AND CFRP

Seco presents a complete solid carbide end mill product range for the machining of glass and carbon fiber reinforced plastics. It consists of diamond-coated and uncoated solid carbide and PCD end mills incorporating different geometries as well as with PCD-brazed cutting edges. This is a product range offering optimized tools for difficult cutting conditions on challenging workpiece materials.

- JC860, JC870, JC871, JC899, JPD890, J93F and J28 for sharp corner type.
- JC845, JC880, JC885 and JC898 for radius type.
- JC875, JC876, JC877 and JPD880 with 45° chamfer type.
- JC850 and JPD850 for ball-nose type.

Universal

Steel and cast iron

Stainless steel
and S-materials

Non ferrous

Hard

Plastic and cfrp

Graphite

X-Heads

Minimaster Plus

Minimaster



























Universal
 Steel and cast iron
 Stainless steel and S-materials
 Non ferrous
 Hard
 Plastic and cfrp
 Graphite
 X-Heads
 Minimaster Plus
 Minimaster

Tool Selection Plastic and CFRP

Name		JC845	JC850	JC860	JC870	JC871
Page(s)		407	409	411	413	419
Family name		COMPOSITE	COMPOSITE	COMPOSITE	COMPOSITE	COMPOSITE
Type of mill						
Shank	Cylindrical	■	■	■	■	■
	Weldon					
Number of Flutes		3	4	5,6,8,9		
ICC						
Diameter range	Metric	6-8	3-12	6-12	3-12	3-12
	Inch				1/4 -1/2	1/4 -1/2
Length availability		2	2	2	2	2
Operation						
SMG						
TS1						
TS2		●	●	●	●	●
TS3		●	●	●	●	●
TP1						
TP2		●	●	●	●	●
TP3		●	●	●	●	●
Honeycomb*				●	●	●

■ Stock standard □ Weldon available, delivery time is 3 days.
 ● Preferred choice ○ Alternative choice

Tool Selection Plastic and CFRP

							
Name	JC875	JC876	JC877	JC880	JC885	JC898	JC899
Page(s)	425	429	433	437	439	441	443
Family name	COMPOSITE	COMPOSITE	COMPOSITE	COMPOSITE	COMPOSITE	COMPOSITE	COMPOSITE
Type of mill							
Shank	Cylindrical	<input checked="" type="checkbox"/>	<input checked="" type="checkbox"/>	<input checked="" type="checkbox"/>	<input checked="" type="checkbox"/>	<input checked="" type="checkbox"/>	<input checked="" type="checkbox"/>
	Weldon	<input type="checkbox"/>	<input type="checkbox"/>	<input type="checkbox"/>	<input type="checkbox"/>	<input type="checkbox"/>	<input type="checkbox"/>
Number of Flutes	5,6,10	6,8,10,12,14	6,8,10,12,14	4	4	4	4
ICC						<input checked="" type="checkbox"/>	
Diameter range	Metric	3-10	3-12	3-12	4-20	4-10	8,5-14,8
	Inch	1/4	1/4-3/8	1/4			3/8
Length availability	2	2	2	2	2	2	2
Operation							
							
SMG							
TS1							
TS2	<input checked="" type="checkbox"/>	<input checked="" type="checkbox"/>	<input checked="" type="checkbox"/>	<input checked="" type="checkbox"/>	<input checked="" type="checkbox"/>	<input checked="" type="checkbox"/>	
TS3	<input checked="" type="checkbox"/>	<input checked="" type="checkbox"/>	<input checked="" type="checkbox"/>	<input checked="" type="checkbox"/>	<input checked="" type="checkbox"/>	<input checked="" type="checkbox"/>	
TP1							
TP2	<input checked="" type="checkbox"/>	<input checked="" type="checkbox"/>	<input checked="" type="checkbox"/>	<input checked="" type="checkbox"/>	<input checked="" type="checkbox"/>	<input checked="" type="checkbox"/>	
TP3	<input checked="" type="checkbox"/>	<input checked="" type="checkbox"/>	<input checked="" type="checkbox"/>	<input checked="" type="checkbox"/>	<input checked="" type="checkbox"/>	<input checked="" type="checkbox"/>	
Honeycomb*							

Stock standard Weldon available, delivery time is 3 days.
 Preferred choice Alternative choice

Universal

Steel and cast iron

Stainless steel and S-materials

Non ferrous

Hard

Plastic and cfrp

























Graphite

X-Heads

Minimaster Plus

Minimaster

Universal
 Steel and cast iron
 Stainless steel and S-materials
 Non ferrous
 Hard
 Plastic and cfrp
 Graphite
 X-Heads
 Minimaster Plus
 Minimaster

Tool Selection Plastic and CFRP						
						
						
Name		JPD850	JPD880	JPD890	J93F	J28
Page(s)		446	448	450	452	454
Family name		PCD	PCD	PCD	VHM	VHM
Type of mill						
Shank	Cylindrical	■	■	■	■	■
	Weldon					
Number of Flutes		2	3	2	2	1
ICC		■	■	■		
Diameter range	Metric	4-10	6-16	6-12	1,5-20	3-12
	Inch					
Length availability		2	2,3	2,3	1,2,3,4	2
Operation						
						
						
SMG						
TS1					●	●
TS2		●	●	●		
TS3		●	●	●		
TP1					●	
TP2		●	●	●		
TP3		●	●	●		
Honeycomb*						

■ Stock standard □ Weldon available, delivery time is 3 days.
 ● Preferred choice ○ Alternative choice

JC845

Composite – Compression – 3 Flutes – Cylindrical – Corner radius

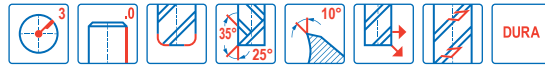
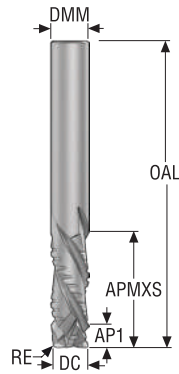

- Tolerances:
- DMM= h5
- DC= -0,02/-0,04 mm
- RE= ±0,01 mm

Designation	Item number	Length index	Tool shape	DC	DMM	APMXS	AP1	OAL	RE	PCEDC	Cylindrical
				mm	mm	mm	mm	mm	mm		
JC845060D2R050.0Z3-DURA	02843006	2	D	6,0	6,0	18,0	4,2	65,0	0,5	3	■
JC845080D2R050.0Z3-DURA	02843007	2	D	8,0	8,0	24,0	5,2	75,0	0,5	3	■
JC845100D2R050.0Z3-DURA	02843008	2	D	10,0	10,0	30,0	6,3	85,0	0,5	3	■
JC845120D2R050.0Z5-DURA	02843009	2	D	12,0	12,0	36,0	8,3	100,0	0,5	5	■

■ Stocked standard.

Universal

Steel and cast iron

Stainless steel and S-materials

Non ferrous

Hard

Plastic and cfrp

Graphite

X-Heads

Minimaster Plus

Minimaster

Cutting data – JC845 Side milling roughing

SMG		a _e /DC	a _p /DC	f _z				v _c
				6	8	10	12	
TS2	E/A/D	0.376	1.5	0.038	0.050	0.060	0.075	185 (130 – 240)
		0,376	1,5	0,0015	0,0020	0,0024	0,0030	610 (430 – 780)
TS3	E/A/D	0.376	1.4	0.038	0.050	0.060	0.075	125 (87 – 160)
		0,376	1,4	0,0015	0,0020	0,0024	0,0030	410 (290 – 520)
TP2	E/A/D	0.376	1.5	0.038	0.050	0.060	0.075	125 (87 – 180)
		0,376	1,5	0,0015	0,0020	0,0024	0,0030	410 (290 – 590)
TP3	E/A/D	0.376	1.4	0.038	0.050	0.060	0.075	85 (62 – 110)
		0,376	1,4	0,0015	0,0020	0,0024	0,0030	280 (210 – 360)

Cutting data – JC845 Slot milling

SMG		a _p /DC	f _z				v _c
			6	8	10	12	
TS2	E/A/D	1.0	0.025	0.032	0.040	0.050	160 (110 – 210)
		1,0	0,0010	0,0013	0,0016	0,0020	520 (370 – 680)
TS3	E/A/D	0.75	0.025	0.032	0.040	0.050	105 (76 – 130)
		0,75	0,0010	0,0013	0,0016	0,0020	345 (250 – 420)
TP2	E/A/D	1.0	0.025	0.032	0.040	0.050	105 (75 – 160)
		1,0	0,0010	0,0013	0,0016	0,0020	345 (250 – 520)
TP3	E/A/D	0.75	0.025	0.032	0.040	0.050	75 (54 – 96)
		0,75	0,0010	0,0013	0,0016	0,0020	245 (180 – 310)

For cutting data recalculations, see pages 556 - 563

SMG = Seco material group
Coolant = A=air D=dry E=emulsion M=mist spray
v_c = m/min (sf/min)
f_z = mm (in/tooth)
a_p = mm/DC (in/DC) = factor
a_e = mm/DC (in/DC) = factor
All cutting data are target values

JC850

Composite – Ball nose – 4 Flutes – Cylindrical

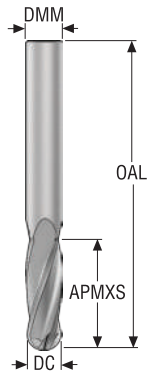

D

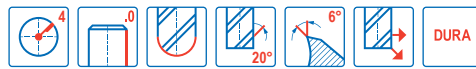

- Tolerances:
- DMM=h5
- DC=-0,02/-0,04 mm
- RE= ±0,02 mm

Designation	Item number	Length index	Tool shape	DC	DMM	APMXS	OAL	PCEDC	Cylindrical
				mm	mm	mm	mm		
850030Z4.0-DURA	02719949	2	D	3,0	3,0	9,0	50,0	4	■
850040Z4.0-DURA	02719952	2	D	4,0	4,0	12,0	50,0	4	■
850060Z4.0-DURA	02719953	2	D	6,0	6,0	18,0	65,0	4	■
850080Z4.0-DURA	02719954	2	D	8,0	8,0	24,0	70,0	4	■
850100Z4.0-DURA	02719955	2	D	10,0	10,0	30,0	85,0	4	■
850120Z4.0-DURA	02719956	2	D	12,0	12,0	36,0	100,0	4	■

■ Stocked standard.

Universal

Steel and cast iron

Stainless steel and S-materials

Non ferrous

Hard

Plastic and cfrp

Graphite

X-Heads

Minimaster Plus

Minimaster

Cutting data – JC850 Copy milling

SMG		a _e /DC	a _p /DC	f _z						v _c
				3	4	6	8	10	12	
TS2	E/A/D	0.200	2.0	0.030	0.040	0.060	0.080	0.10	0.12	265 (220 – 320)
		0,200	2,0	0,0012	0,0016	0,0024	0,0032	0,0040	0,0048	870 (730 – 1000)
TS3	E/A/D	0.200	2.0	0.024	0.032	0.048	0.065	0.080	0.095	160 (110 – 210)
		0,200	2,0	0,00095	0,0013	0,0019	0,0026	0,0032	0,0038	520 (370 – 680)
TP2	E/A/D	0.200	2.0	0.030	0.040	0.060	0.080	0.10	0.12	215 (110 – 320)
		0,200	2,0	0,0012	0,0016	0,0024	0,0032	0,0040	0,0048	710 (370 – 1000)
TP3	E/A/D	0.200	2.0	0.024	0.032	0.048	0.065	0.080	0.095	105 (54 – 150)
		0,200	2,0	0,00095	0,0013	0,0019	0,0026	0,0032	0,0038	345 (180 – 490)

For cutting data recalculations, see pages 556 - 563

SMG = Seco material group
Coolant = A=air D=dry E=emulsion M=mist spray
v_c = m/min (sf/min)
f_z = mm (in/tooth)
a_p = mm/DC (in/DC) = factor
a_e = mm/DC (in/DC) = factor
All cutting data are target values

Universal

Steel and cast iron

Stainless steel and S-materials

Non ferrous

Hard

Plastic and cfrp

Graphite

X-Heads

Minimaster Plus

Minimaster

JC860

Honeycomb – Square – 5-9 Flutes – Cylindrical – Sharp

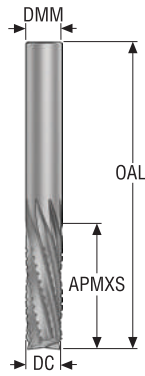

D



- Tolerances:
- DMM=h5
- DC= -0.02-0.08 mm
- FCEDC=frontal teeth



Designation	Item number	Length index	Tool shape	DC	DMM	APMXS	OAL	FCEDC	PCEDC	Cylindrical
				mm	mm	mm	mm			
860060Z5.0-DURA	02720211	2	D	6,0	6,0	18,0	70,0	2	5	■
860080Z6.0-DURA	02720212	2	D	8,0	8,0	24,0	80,0	2	6	■
860100Z8.0-DURA	02720216	2	D	10,0	10,0	30,0	90,0	2	8	■
860120Z9.0-DURA	02720217	2	D	12,0	12,0	36,0	110,0	2	9	■

■ Stocked standard.

Universal

Steel and cast iron

Stainless steel and S-materials

Non ferrous

Hard

Plastic and cfrp

Graphite

X-Heads

Minimaster Plus

Minimaster

Cutting data – JC860 Side milling roughing

SMG		a _p /DC	a _p /DC	f _z				v _c
				6	8	10	12	
TS2	E/A/D	0.100	1.0	0.024	0.032	0.040	0.048	235 (200 – 270)
		0,100	1,0	0,00095	0,0013	0,0016	0,0019	770 (660 – 880)
TS3	E/A/D	0.100	1.0	0.024	0.032	0.040	0.048	160 (130 – 180)
		0,100	1,0	0,00095	0,0013	0,0016	0,0019	520 (430 – 590)
TP2	E/A/D	0.100	1.0	0.024	0.032	0.040	0.048	165 (130 – 200)
		0,100	1,0	0,00095	0,0013	0,0016	0,0019	540 (430 – 650)
TP3	E/A/D	0.100	1.0	0.024	0.032	0.040	0.048	65 (50 – 110)
		0,100	1,0	0,00095	0,0013	0,0016	0,0019	215 (170 – 360)

Cutting data – JC860 Slot milling

SMG		a _p /DC	f _z				v _c
			6	8	10	12	
TS2	E/A/D	0.50	0.012	0.016	0.020	0.025	160 (140 – 180)
		0,50	0,00048	0,00065	0,00080	0,0010	520 (460 – 590)
TS3	E/A/D	0.50	0.012	0.016	0.020	0.025	105 (85 – 120)
		0,50	0,00048	0,00065	0,00080	0,0010	345 (280 – 390)
TP2	E/A/D	0.50	0.012	0.016	0.020	0.025	110 (84 – 130)
		0,50	0,00048	0,00065	0,00080	0,0010	360 (280 – 420)
TP3	E/A/D	0.50	0.012	0.016	0.020	0.025	44 (34 – 78)
		0,50	0,00048	0,00065	0,00080	0,0010	145 (120 – 250)

For cutting data recalculations, see pages 556 - 563

SMG = Seco material group
Coolant = A=air D=dry E=emulsion M=mist spray
v_c = m/min (sf/min)
f_z = mm (in/tooth)
a_p = mm/DC (in/DC) = factor
a_s = mm/DC (in/DC) = factor
All cutting data are target values

JC870

Composite – Router – Square – Cylindrical – Sharp

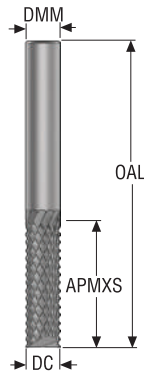

D

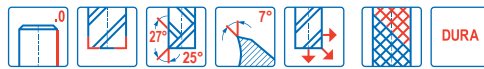

- Tolerances:
- DMM=h5
- DC=-0,02/-0,08 mm
- Router (downcut)*

Designation	Item number	Length index	Tool shape	DC	DMM	APMXS	OAL	FCEDC	PCEDC	Cylindrical
				mm	mm	mm	mm			
870030.0-DURA	02720219	2	D	3,0	3,0	9,0	50,0	2	8	■
870040.0-DURA	02720226	2	D	4,0	4,0	12,0	50,0	2	8	■
870060.0-DURA	02720228	2	D	6,0	6,0	18,0	65,0	2	10	■
870080.0-DURA	02720229	2	D	8,0	8,0	24,0	75,0	2	12	■
870100.0-DURA	02720231	2	D	10,0	10,0	30,0	85,0	2	12	■
870120.0-DURA	02720232	2	D	12,0	12,0	36,0	100,0	2	14	■

■ Stocked standard.

*Downcut indicates flute geometries that are combined to create small down forces that assist with maintaining component clamping, particularly where vacuum clamping is employed.

Universal

Steel and cast iron

Stainless steel and S-materials

Non ferrous

Hard

Plastic and cfrp

Graphite

X-Heads

Minimaster Plus

Minimaster

JC870

Composite – Router – Square – Cylindrical – Sharp – Inch

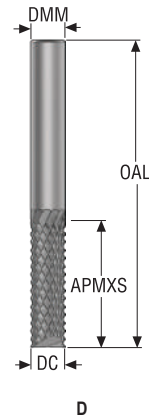

- Tolerances:
- DMM= h5
- DC= -.0008/- .0030 Inch
- Router (downcut)*

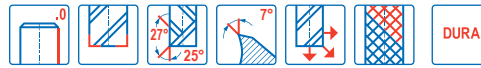

Designation	Item number	Length index	Tool shape	DC	DMM	APMXS	OAL	FCEDC	Cylindrical
				inch	inch	inch	inch		
8700250.0-DURA	02720784	2	D	0.250	0.250	0.750	2.250	2	■
8700375.0-DURA	02720785	2	D	0.375	0.375	1.250	3.500	2	■

■ Stocked standard.

*Downcut indicates flute geometries that are combined to create small down forces that assist with maintaining component clamping, particularly where vacuum clamping is employed.

Universal
 Steel and cast iron
 Stainless steel and S-materials
 Non ferrous
 Hard
 Plastic and cfrp
 Graphite
 X-Heads
 Minimaster Plus
 Minimaster

JC870

Composite – Router – Square – Cylindrical – Sharp

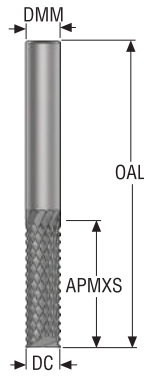

D

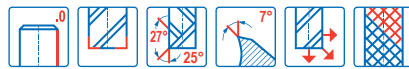

- Tolerances:
- DMM=h5
- DC=-0,02/-0,08 mm
- Router (downcut)*



Designation	Item number	Length index	Tool shape	DC	DMM	APMXS	OAL	FCEDC	PCEDC	Cylindrical
				mm	mm	mm	mm			
870030.0	02742789	2	D	3,0	3,0	9,0	50,0	2	8	■
870040.0	02742792	2	D	4,0	4,0	12,0	50,0	2	8	■
870050.0	02742793	2	D	5,0	5,0	15,0	50,0	2	10	■
870060.0	02742794	2	D	6,0	6,0	18,0	65,0	2	10	■
870080.0	02742795	2	D	8,0	8,0	24,0	75,0	2	12	■
870100.0	02742796	2	D	10,0	10,0	30,0	85,0	2	12	■
870120.0	02742797	2	D	12,0	12,0	36,0	100,0	2	14	■

■ Stocked standard.

*Downcut indicates flute geometries that are combined to create small down forces that assist with maintaining component clamping, particularly where vacuum clamping is employed.

Universal

Steel and cast iron

Stainless steel and S-materials

Non ferrous

Hard

Plastic and cfrp

Graphite

X-Heads

Minimaster Plus

Minimaster

JC870

Composite – Router – Square – Cylindrical – Sharp – Inch

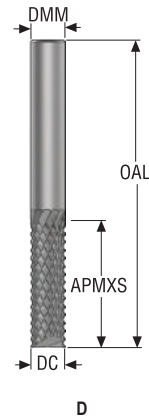

- Tolerances:
- DMM= h5
- DC= -.0008/- .0030 Inch
- Router (downcut)*

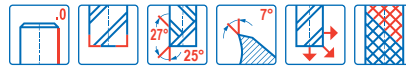

Designation	Item number	Length index	Tool shape	DC	DMM	APMXS	OAL	FCEDC	PCEDC	Cylindrical
				inch	inch	inch	inch			
8700250.0	02742798	2	D	0.250	0.250	0.750	2.250	2	10	■
8700500.0	02742800	2	D	0.500	0.500	1.500	4.250	2	14	■

■ Stocked standard.

*Downcut indicates flute geometries that are combined to create small down forces that assist with maintaining component clamping, particularly where vacuum clamping is employed.

Universal
Steel and cast iron
Stainless steel and S-materials
Non ferrous
Hard
Plastic and cfrp
Graphite
X-Heads
Minimaster Plus
Minimaster

Cutting data – JC870 Side milling roughing

SMG		a _e /DC	a _p /DC	f _z							v _c
				3	4	5	6	8	10	12	
TS2	E/A/D	0.350	2.0	0.0095	0.013	0.016	0.019	0.025	0.032	0.038	175 (150 – 200)
		0,350	2,0	0,00038	0,00050	0,00065	0,00075	0,0010	0,0013	0,0015	570 (500 – 650)
TS3	E/A/D	0.350	2.0	0.0095	0.013	0.016	0.019	0.025	0.032	0.038	115 (94 – 130)
		0,350	2,0	0,00038	0,00050	0,00065	0,00075	0,0010	0,0013	0,0015	375 (310 – 420)
TP2	E/A/D	0.350	2.0	0.0095	0.013	0.016	0.019	0.025	0.032	0.038	115 (88 – 140)
		0,350	2,0	0,00038	0,00050	0,00065	0,00075	0,0010	0,0013	0,0015	375 (290 – 450)
TP3	E/A/D	0.350	2.0	0.0095	0.013	0.016	0.019	0.025	0.032	0.038	46 (36 – 81)
		0,350	2,0	0,00038	0,00050	0,00065	0,00075	0,0010	0,0013	0,0015	150 (120 – 260)

Cutting data – JC870 Slot milling

SMG		a _p /DC	f _z							v _c
			3	4	5	6	8	10	12	
TS2	E/A/D	1.0	0.0060	0.0080	0.010	0.012	0.016	0.020	0.025	145 (130 – 170)
		1,0	0,00024	0,00032	0,00040	0,00048	0,00065	0,00080	0,0010	475 (430 – 550)
TS3	E/A/D	1.0	0.0060	0.0080	0.010	0.012	0.016	0.020	0.025	100 (79 – 110)
		1,0	0,00024	0,00032	0,00040	0,00048	0,00065	0,00080	0,0010	330 (260 – 360)
TP2	E/A/D	1.0	0.0060	0.0080	0.010	0.012	0.016	0.020	0.025	100 (74 – 120)
		1,0	0,00024	0,00032	0,00040	0,00048	0,00065	0,00080	0,0010	330 (250 – 390)
TP3	E/A/D	1.0	0.0060	0.0080	0.010	0.012	0.016	0.020	0.025	39 (30 – 68)
		1,0	0,00024	0,00032	0,00040	0,00048	0,00065	0,00080	0,0010	130 (99 – 220)

For cutting data recalculations, see pages 556 - 563

SMG = Seco material group
Coolant = A=air D=dry E=emulsion M=mist spray
v_c = m/min (sf/min)
f_z = mm (in/tooth)
a_p = mm/DC (in/DC) = factor
a_e = mm/DC (in/DC) = factor
All cutting data are target values

Universal
Steel and cast iron
Stainless steel and S-materials
Non ferrous
Hard
Plastic and cfrp
Graphite
X-Heads
Minimaster Plus
Minimaster

Cutting data – JC870 Side milling roughing – Inch

SMG		a _e /DC	a _p /DC	f _z			v _c
				1/4	3/8	1/2	
TS2	E/A/D	0.350	2.0	0.020	0.030	0.038	175 (150 – 200)
		0,350	2,0	0,00080	0,0012	0,0015	570 (500 – 650)
TS3	E/A/D	0.350	2.0	0.020	0.030	0.038	115 (94 – 130)
		0,350	2,0	0,00080	0,0012	0,0015	375 (310 – 420)
TP2	E/A/D	0.350	2.0	0.020	0.030	0.038	115 (88 – 140)
		0,350	2,0	0,00080	0,0012	0,0015	375 (290 – 450)
TP3	E/A/D	0.350	2.0	0.020	0.030	0.038	46 (36 – 81)
		0,350	2,0	0,00080	0,0012	0,0015	150 (120 – 260)

Cutting data – JC870 Slot milling – Inch

SMG		a _p /DC	f _z			v _c
			1/4	3/8	1/2	
TS2	E/A/D	1.0	0.013	0.019	0.026	145 (130 – 170)
		1,0	0,00050	0,00075	0,0010	475 (430 – 550)
TS3	E/A/D	1.0	0.013	0.019	0.026	100 (79 – 110)
		1,0	0,00050	0,00075	0,0010	330 (260 – 360)
TP2	E/A/D	1.0	0.013	0.019	0.026	100 (74 – 120)
		1,0	0,00050	0,00075	0,0010	330 (250 – 390)
TP3	E/A/D	1.0	0.013	0.019	0.026	39 (30 – 68)
		1,0	0,00050	0,00075	0,0010	130 (99 – 220)

For cutting data recalculations, see pages 556 - 563

SMG = Seco material group
Coolant = A=air D=dry E=emulsion M=mist spray
v_c = m/min (sf/min)
f_z = mm (in/tooth)
a_p = mm/DC (in/DC) = factor
a_e = mm/DC (in/DC) = factor
All cutting data are target values

JC871

Composite – Router – Square – Cylindrical – Sharp

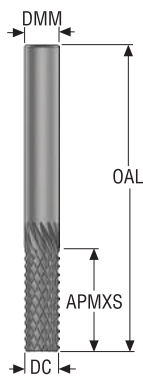

D

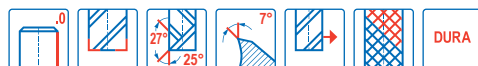

- Tolerances:
- DMM= h5
- DC= -0,02/-0,08 mm
- Router (downcut)*

Designation	Item number	Length index	Tool shape	DC	DMM	APMXS	OAL	PCEDC	Cylindrical
				mm	mm	mm	mm		
871030.0-DURA	02720249	2	D	3,0	3,0	9,0	50,0	8	■
871040.0-DURA	02720250	2	D	4,0	4,0	12,0	50,0	8	■
871060.0-DURA	02720252	2	D	6,0	6,0	18,0	65,0	10	■
871080.0-DURA	02720253	2	D	8,0	8,0	24,0	75,0	12	■
871100.0-DURA	02720254	2	D	10,0	10,0	30,0	85,0	12	■
871120.0-DURA	02720257	2	D	12,0	12,0	36,0	100,0	14	■

■ Stocked standard.

*Downcut indicates flute geometries that are combined to create small down forces that assist with maintaining component clamping, particularly where vacuum clamping is employed.

Universal

Steel and cast iron

Stainless steel and S-materials

Non ferrous

Hard

Plastic and cfrp

Graphite

X-Heads

Minimaster Plus

Minimaster

JC871

Composite – Router – Square – Cylindrical – Sharp – Inch

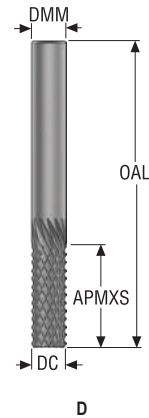

- Tolerances:
- DMM= h5
- DC= -.0008/- .0030 Inch
- Router (downcut)*

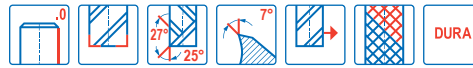

Designation	Item number	Length index	Tool shape	DC	DMM	APMXS	OAL	PCEDC	Cylindrical
				inch	inch	inch	inch		
8710250.0-DURA	02720788	2	D	0.250	0.250	0.750	2.250	10	■
8710375.0-DURA	02720789	2	D	0.375	0.375	1.250	3.500	12	■
8710500.0-DURA	02720790	2	D	0.500	0.500	1.500	4.250	14	■

■ Stocked standard.

*Downcut indicates flute geometries that are combined to create small down forces that assist with maintaining component clamping, particularly where vacuum clamping is employed.

Universal

Steel and cast iron

Stainless steel and S-materials

Non ferrous

Hard

Plastic and cfrp

Graphite

X-Heads

Minimaster Plus

Minimaster

JC871

Composite – Router – Square – Cylindrical – Sharp

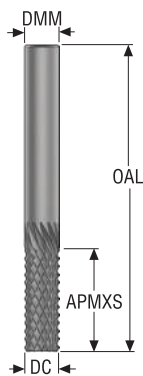

D

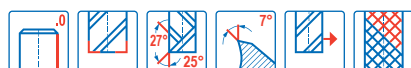

- Tolerances:
- DMM= h5
- DC= -0,02/-0,08 mm
- Router (downcut)*



Designation	Item number	Length index	Tool shape	DC	DMM	APMXS	OAL	PCEDC	Cylindrical
				mm	mm	mm	mm		
871030.0	02742801	2	D	3,0	3,0	9,0	50,0	8	■
871040.0	02742803	2	D	4,0	4,0	12,0	50,0	8	■
871060.0	02742806	2	D	6,0	6,0	18,0	65,0	10	■
871080.0	02742807	2	D	8,0	8,0	24,0	75,0	12	■
871100.0	02742808	2	D	10,0	10,0	30,0	85,0	12	■
871120.0	02742809	2	D	12,0	12,0	36,0	100,0	14	■

■ Stocked standard.

*Downcut indicates flute geometries that are combined to create small down forces that assist with maintaining component clamping, particularly where vacuum clamping is employed.

Universal

Steel and cast iron

Stainless steel and S-materials

Non ferrous

Hard

Plastic and cfrp

Graphite

X-Heads

Minimaster Plus

Minimaster

JC871

Composite – Router – Square – Cylindrical – Sharp – Inch

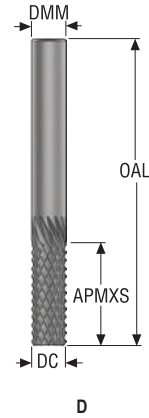

- Tolerances:
- DMM=h5
- DC= -.0008/- .0030 Inch
- Router (downcut)*

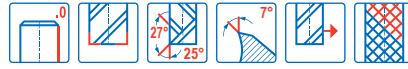

Designation	Item number	Length index	Tool shape	DC	DMM	APMXS	OAL	PCEDC	Cylindrical
8710500.0	02742814	2	D	0.500	0.500	1.500	4.250	14	■

■ Stocked standard.

*Downcut indicates flute geometries that are combined to create small down forces that assist with maintaining component clamping, particularly where vacuum clamping is employed.

Universal

Steel and cast iron

Stainless steel and S-materials

Non ferrous

Hard

Plastic and cfrp

Graphite

X-Heads

Minimaster Plus

Minimaster

Cutting data – JC871 Side milling roughing

SMG		a _e /DC	a _p /DC	f _z							v _c
				3	4	5	6	8	10	12	
TS2	E/A/D	0.350	2.0	0.0095	0.013	0.016	0.019	0.025	0.032	0.038	175 (150 – 200)
		0,350	2,0	0,00038	0,00050	0,00065	0,00075	0,0010	0,0013	0,0015	570 (500 – 650)
TS3	E/A/D	0.350	2.0	0.0095	0.013	0.016	0.019	0.025	0.032	0.038	115 (94 – 130)
		0,350	2,0	0,00038	0,00050	0,00065	0,00075	0,0010	0,0013	0,0015	375 (310 – 420)
TP2	E/A/D	0.350	2.0	0.0095	0.013	0.016	0.019	0.025	0.032	0.038	115 (88 – 140)
		0,350	2,0	0,00038	0,00050	0,00065	0,00075	0,0010	0,0013	0,0015	375 (290 – 450)
TP3	E/A/D	0.350	2.0	0.0095	0.013	0.016	0.019	0.025	0.032	0.038	46 (36 – 81)
		0,350	2,0	0,00038	0,00050	0,00065	0,00075	0,0010	0,0013	0,0015	150 (120 – 260)

Cutting data – JC871 Slot milling

SMG		a _p /DC	f _z							v _c
			3	4	5	6	8	10	12	
TS2	E/A/D	1.0	0.0060	0.0080	0.010	0.012	0.016	0.020	0.025	155 (140 – 180)
		1,0	0,00024	0,00032	0,00040	0,00048	0,00065	0,00080	0,0010	510 (460 – 590)
TS3	E/A/D	1.0	0.0060	0.0080	0.010	0.012	0.016	0.020	0.025	105 (84 – 120)
		1,0	0,00024	0,00032	0,00040	0,00048	0,00065	0,00080	0,0010	345 (280 – 390)
TP2	E/A/D	1.0	0.0060	0.0080	0.010	0.012	0.016	0.020	0.025	105 (79 – 130)
		1,0	0,00024	0,00032	0,00040	0,00048	0,00065	0,00080	0,0010	345 (260 – 420)
TP3	E/A/D	1.0	0.0060	0.0080	0.010	0.012	0.016	0.020	0.025	40 (31 – 70)
		1,0	0,00024	0,00032	0,00040	0,00048	0,00065	0,00080	0,0010	130 (110 – 220)

For cutting data recalculations, see pages 556 - 563

SMG = Seco material group
Coolant = A=air D=dry E=emulsion M=mist spray
v_c = m/min (sf/min)
f_z = mm (in/tooth)
a_p = mm/DC (in/DC) = factor
a_e = mm/DC (in/DC) = factor
All cutting data are target values

Universal
Steel and cast iron
Stainless steel and S-materials
Non ferrous
Hard
Plastic and cfrp
Graphite
X-Heads
Minimaster Plus
Minimaster

Cutting data – JC871 Side milling roughing – Inch

SMG		a _e /DC	a _p /DC	f _z			v _c
				1/4	3/8	1/2	
TS2	E/A/D	0.350	2.0	0.020	0.030	0.038	175 (150 – 200)
		0,350	2,0	0,00080	0,0012	0,0015	570 (500 – 650)
TS3	E/A/D	0.350	2.0	0.020	0.030	0.038	115 (94 – 130)
		0,350	2,0	0,00080	0,0012	0,0015	375 (310 – 420)
TP2	E/A/D	0.350	2.0	0.020	0.030	0.038	115 (88 – 140)
		0,350	2,0	0,00080	0,0012	0,0015	375 (290 – 450)
TP3	E/A/D	0.350	2.0	0.020	0.030	0.038	46 (36 – 81)
		0,350	2,0	0,00080	0,0012	0,0015	150 (120 – 260)

Cutting data – JC871 Slot milling – Inch

SMG		a _p /DC	f _z			v _c
			1/4	3/8	1/2	
TS2	E/A/D	1.0	0.013	0.019	0.026	145 (130 – 170)
		1,0	0,00050	0,00075	0,0010	475 (430 – 550)
TS3	E/A/D	1.0	0.013	0.019	0.026	100 (79 – 110)
		1,0	0,00050	0,00075	0,0010	330 (260 – 360)
TP2	E/A/D	1.0	0.013	0.019	0.026	100 (74 – 120)
		1,0	0,00050	0,00075	0,0010	330 (250 – 390)
TP3	E/A/D	1.0	0.013	0.019	0.026	39 (30 – 68)
		1,0	0,00050	0,00075	0,0010	130 (99 – 220)

For cutting data recalculations, see pages 556 - 563

SMG = Seco material group
Coolant = A=air D=dry E=emulsion M=mist spray
v_c = m/min (sf/min)
f_z = mm (in/tooth)
a_p = mm/DC (in/DC) = factor
a_e = mm/DC (in/DC) = factor
All cutting data are target values

JC875

Composite – Square – 5-10 Flutes – Cylindrical – Chamfer

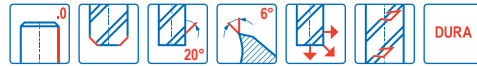
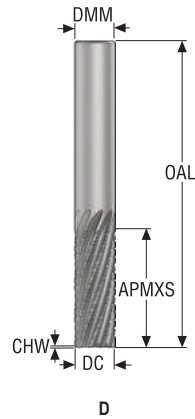

- Tolerances:
- DMM=h5
- DC=-0,02/-0,08 mm

Designation	Item number	Length index	Tool shape	DC	DMM	APMXS	OAL	CHW	PCEDC	Cylindrical
				mm	mm	mm	mm	mm		
JC875030D2.0-DURA	02968155	2	D	3,0	3,0	9,0	50,0	0,05	5	■
JC875050D2.0-DURA	02968157	2	D	5,0	5,0	15,0	50,0	0,05	6	■
JC875060D2.0-DURA	02968158	2	D	6,0	6,0	18,0	65,0	0,06	6	■
JC875080D2.0-DURA	02968159	2	D	8,0	8,0	24,0	70,0	0,08	10	■
JC875100D2.0-DURA	02968160	2	D	10,0	10,0	30,0	80,0	0,1	10	■

■ Stocked standard.

Universal

Steel and cast iron

Stainless steel and S-materials

Non ferrous

Hard

Plastic and cfrp

Graphite

X-Heads

Minimaster Plus

Minimaster

JC875

Composite – Square – 6-10 Flutes – Cylindrical – Chamfer – Inch

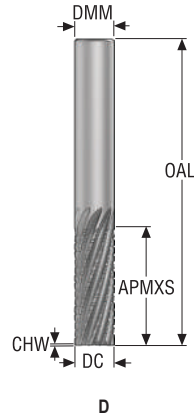

- Tolerances:
- DMM=h5
- DC= -.0008/- .0030 Inch

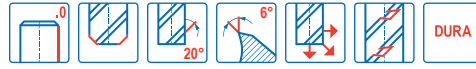

Designation	Item number	Length index	Tool shape	DC	DMM	APMXS	OAL	CHW	PCEDC	Cylindrical
JC875.250D2.0-DURA	02968162	2	D	0.250 inch	0.250 inch	0.750 inch	3.000 inch	0.002 inch	6	■

■ Stocked standard.

Universal
 Steel and cast iron
 Stainless steel and S-materials
 Non ferrous
 Hard
 Plastic and cfrp
 Graphite
 X-Heads
 Minimaster Plus
 Minimaster

Cutting data – JC875 Side milling roughing

SMG		a _p /DC	a _p /DC	f _z					v _c
				3	5	6	8	10	
TS2	E/A/D	0.350	2.0	0.0095	0.016	0.019	0.025	0.032	190 (160 – 220)
		0,350	2,0	0,00038	0,00065	0,00075	0,0010	0,0013	620 (530 – 720)
TS3	E/A/D	0.350	2.0	0.0095	0.016	0.019	0.025	0.032	130 (110 – 150)
		0,350	2,0	0,00038	0,00065	0,00075	0,0010	0,0013	425 (370 – 490)
TP2	E/A/D	0.350	2.0	0.0095	0.016	0.019	0.025	0.032	130 (96 – 150)
		0,350	2,0	0,00038	0,00065	0,00075	0,0010	0,0013	425 (320 – 490)
TP3	E/A/D	0.350	2.0	0.0095	0.016	0.019	0.025	0.032	50 (39 – 89)
		0,350	2,0	0,00038	0,00065	0,00075	0,0010	0,0013	165 (130 – 290)

Cutting data – JC875 Slot milling

SMG		a _p /DC	f _z					v _c
			3	5	6	8	10	
TS2	E/A/D	1.0	0.0060	0.010	0.012	0.016	0.020	160 (140 – 180)
		1,0	0,00024	0,00040	0,00048	0,00065	0,00080	520 (460 – 590)
TS3	E/A/D	1.0	0.0060	0.010	0.012	0.016	0.020	105 (86 – 120)
		1,0	0,00024	0,00040	0,00048	0,00065	0,00080	345 (290 – 390)
TP2	E/A/D	1.0	0.0060	0.010	0.012	0.016	0.020	105 (81 – 130)
		1,0	0,00024	0,00040	0,00048	0,00065	0,00080	345 (270 – 420)
TP3	E/A/D	1.0	0.0060	0.010	0.012	0.016	0.020	42 (33 – 74)
		1,0	0,00024	0,00040	0,00048	0,00065	0,00080	140 (110 – 240)

For cutting data recalculations, see pages 556 - 563

SMG = Seco material group
Coolant = A=air D=dry E=emulsion M=mist spray
v_c= m/min (sf/min)
f_z = mm (in/tooth)
a_p = mm/DC (in/DC) = factor
a_s = mm/DC (in/DC) = factor
All cutting data are target values

Universal
Steel and cast iron
Stainless steel and S-materials
Non ferrous
Hard
Plastic and cfrp
Graphite
X-Heads
Minimaster Plus
Minimaster

Cutting data – JC875 Side milling – Inch

SMG		a _p /DC	a _p /DC	f _z			v _c
				1/4	3/8	1/2	
TS2	E/A/D	0.350	2.0	0.020	0.030	0.038	190 (160 – 220)
		0,350	2,0	0,00080	0,0012	0,0015	620 (530 – 720)
TS3	E/A/D	0.350	2.0	0.020	0.030	0.038	130 (110 – 150)
		0,350	2,0	0,00080	0,0012	0,0015	425 (370 – 490)
TP2	E/A/D	0.350	2.0	0.020	0.030	0.038	130 (96 – 150)
		0,350	2,0	0,00080	0,0012	0,0015	425 (320 – 490)
TP3	E/A/D	0.350	2.0	0.020	0.030	0.038	50 (39 – 89)
		0,350	2,0	0,00080	0,0012	0,0015	165 (130 – 290)

Cutting data – JC875 Slot milling – Inch

SMG		a _p /DC	f _z			v _c
			1/4	3/8	1/2	
TS2	E/A/D	1.0	0.013	0.019	0.026	160 (140 – 180)
		1,0	0,00050	0,00075	0,0010	520 (460 – 590)
TS3	E/A/D	1.0	0.013	0.019	0.026	105 (86 – 120)
		1,0	0,00050	0,00075	0,0010	345 (290 – 390)
TP2	E/A/D	1.0	0.013	0.019	0.026	105 (81 – 130)
		1,0	0,00050	0,00075	0,0010	345 (270 – 420)
TP3	E/A/D	1.0	0.013	0.019	0.026	42 (33 – 74)
		1,0	0,00050	0,00075	0,0010	140 (110 – 240)

For cutting data recalculations, see pages 556 - 563

SMG = Seco material group
Coolant = A=air D=dry E=emulsion M=mist spray
v_c = m/min (sf/min)
f_z = mm/tooth (in/tooth)
a_p = mm/DC (in/DC) = factor
a_s = mm/DC (in/DC) = factor
All cutting data are target values

JC876

Composite – Square – 6-14 Flutes – Cylindrical – Chamfer

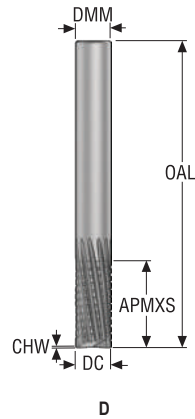

D

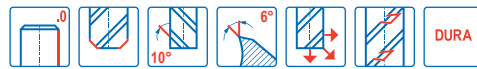

- Tolerances:
- DMM=h5
- DC=-0,02 -0,08 mm
- Left hand helix



Designation	Item number	Length index	Tool shape	DC	DMM	APMXS	OAL	CHW	PCEDC	Cylindrical
				mm	mm	mm	mm	mm		
JC876030D2C.0Z6-DURA	03135004	2	D	3,0	3,0	7,5	50,0	0,035	6	■
JC876040D2C.0Z6-DURA	03135005	2	D	4,0	4,0	10,0	54,0	0,045	6	■
JC876060D2C.0Z8-DURA	03135006	2	D	6,0	6,0	15,0	62,0	0,075	8	■
JC876060D2C.0Z10-DURA	03135007	2	D	6,0	6,0	15,0	62,0	0,075	10	■
JC876080D2C.0Z10-DURA	03135009	2	D	8,0	8,0	20,0	70,0	0,1	10	■
JC876100D2C.0Z12-DURA	03135011	2	D	10,0	10,0	25,0	82,0	0,125	12	■
JC876120D2C.0Z14-DURA	03135012	2	D	12,0	12,0	30,0	95,0	0,15	14	■

■ Stocked standard.

Universal

Steel and cast iron

Stainless steel and S-materials

Non ferrous

Hard

Plastic and cfrp

Graphite

X-Heads

Minimaster Plus

Minimaster

JC876

Composite – Square – 8-14 Flutes – Cylindrical – Chamfer – Inch

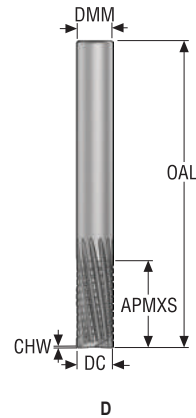

- Tolerances:
- DMM=h5
- DC= -.0008/- .0030 Inch
- Left hand helix

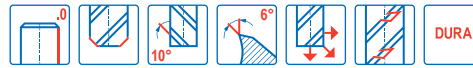

Designation	Item number	Length index	Tool shape	DC	DMM	APMXS	OAL	CHW	PCEDC	Cylindrical
				inch	inch	inch	inch	inch		
JC876.250D2C.0Z8-DURA	03135125	2	D	0.250	0.250	0.625	2.500	0.003	8	■
JC876.375D2C.0Z12-DURA	03135127	2	D	0.375	0.375	1.000	3.000	0.005	12	■

■ Stocked standard.

Universal
Steel and cast iron
Stainless steel and S-materials
Non ferrous
Hard
Plastic and cfrp
Graphite
X-Heads
Minimaster Plus
Minimaster

Cutting data – JC876 Side milling roughing

SMG		a _e /DC	a _p /DC	f _z						v _c
				3	4	6	8	10	12	
TS2	E/A/D	0.334	1.7	0.0095	0.013	0.019	0.026	0.032	0.038	220 (190 – 250)
		0,334	1,7	0,00038	0,00050	0,00075	0,0010	0,0013	0,0015	720 (630 – 820)
TS3	E/A/D	0.334	1.7	0.0095	0.013	0.019	0.026	0.032	0.038	145 (120 – 170)
		0,334	1,7	0,00038	0,00050	0,00075	0,0010	0,0013	0,0015	475 (400 – 550)
TP2	E/A/D	0.334	1.7	0.0095	0.013	0.019	0.026	0.032	0.038	145 (110 – 180)
		0,334	1,7	0,00038	0,00050	0,00075	0,0010	0,0013	0,0015	475 (370 – 590)
TP3	E/A/D	0.334	1.7	0.0095	0.013	0.019	0.026	0.032	0.038	75 (44 – 100)
		0,334	1,7	0,00038	0,00050	0,00075	0,0010	0,0013	0,0015	245 (150 – 320)

Cutting data – JC876 Slot milling

SMG		a _p /DC	f _z						v _c
			3	4	6	8	10	12	
TS2	E/A/D	1.0	0.0060	0.0080	0.012	0.016	0.020	0.025	175 (150 – 200)
		1,0	0,00024	0,00032	0,00048	0,00065	0,00080	0,0010	570 (500 – 650)
TS3	E/A/D	1.0	0.0060	0.0080	0.012	0.016	0.020	0.025	115 (94 – 140)
		1,0	0,00024	0,00032	0,00048	0,00065	0,00080	0,0010	375 (310 – 450)
TP2	E/A/D	1.0	0.0060	0.0080	0.012	0.016	0.020	0.025	115 (88 – 140)
		1,0	0,00024	0,00032	0,00048	0,00065	0,00080	0,0010	375 (290 – 450)
TP3	E/A/D	1.0	0.0060	0.0080	0.012	0.016	0.020	0.025	60 (36 – 81)
		1,0	0,00024	0,00032	0,00048	0,00065	0,00080	0,0010	195 (120 – 260)

For cutting data recalculations, see pages 556 - 563

SMG = Seco material group

Coolant = A=air D=dry E=emulsion M=mist spray

v_c = m/min (sf/min)

f_z = mm (in/tooth)

a_p = mm/DC (in/DC) = factor

a_e = mm/DC (in/DC) = factor

All cutting data are target values

Universal
Steel and cast iron
Stainless steel and S-materials
Non ferrous
Hard
Plastic and cfrp
Graphite
X-Heads
Minimaster Plus
Minimaster

Cutting data – JC876 Side milling roughing – Inch

SMG		a _p /DC	a _p /DC	f _z			v _c
				1/4	3/8	1/2	
TS2	E/A/D	0.334	1.7	0.020	0.030	0.040	220 (190 – 250)
		0,334	1,7	0,00080	0,0012	0,0016	720 (630 – 820)
TS3	E/A/D	0.334	1.7	0.020	0.030	0.040	145 (120 – 170)
		0,334	1,7	0,00080	0,0012	0,0016	475 (400 – 550)
TP2	E/A/D	0.334	1.7	0.020	0.030	0.040	145 (110 – 180)
		0,334	1,7	0,00080	0,0012	0,0016	475 (370 – 590)
TP3	E/A/D	0.334	1.7	0.020	0.030	0.040	75 (44 – 100)
		0,334	1,7	0,00080	0,0012	0,0016	245 (150 – 320)

Cutting data – JC876 Slot milling – Inch

SMG		a _p /DC	f _z			v _c
			1/4	3/8	1/2	
TS2	E/A/D	1.0	0.013	0.019	0.026	175 (150 – 200)
		1,0	0,00050	0,00075	0,0010	570 (500 – 650)
TS3	E/A/D	1.0	0.013	0.019	0.026	115 (94 – 140)
		1,0	0,00050	0,00075	0,0010	375 (310 – 450)
TP2	E/A/D	1.0	0.013	0.019	0.026	115 (88 – 140)
		1,0	0,00050	0,00075	0,0010	375 (290 – 450)
TP3	E/A/D	1.0	0.013	0.019	0.026	60 (36 – 81)
		1,0	0,00050	0,00075	0,0010	195 (120 – 260)

For cutting data recalculations, see pages 556 - 563

SMG = Seco material group
Coolant = A=air D=dry E=emulsion M=mist spray
v_c = m/min (sf/min)
f_z = mm/tooth (in/tooth)
a_p = mm/DC (in/DC) = factor
a_s = mm/DC (in/DC) = factor
All cutting data are target values

JC877

Composite – Square – 6-14 Flutes – Cylindrical – Chamfer

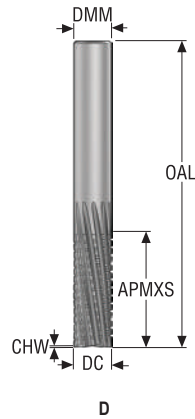

D

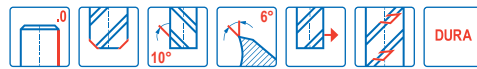

- Tolerances:
- DMM=h5
- DC=-0,02, -0,08 mm
- Left hand helix

Designation	Item number	Length index	Tool shape	DC	DMM	APMXS	OAL	CHW	PCEDC	Cylindrical
				mm	mm	mm	mm	mm		
JC877030D2C.0Z6-DURA	03135013	2	D	3,0	3,0	9,0	50,0	0,035	6	■
JC877040D2C.0Z6-DURA	03135014	2	D	4,0	4,0	12,0	54,0	0,045	6	■
JC877060D2C.0Z8-DURA	03135015	2	D	6,0	6,0	18,0	62,0	0,075	8	■
JC877060D2C.0Z10-DURA	03135016	2	D	6,0	6,0	18,0	62,0	0,075	10	■
JC877080D2C.0Z10-DURA	03135018	2	D	8,0	8,0	24,0	70,0	0,1	10	■
JC877100D2C.0Z12-DURA	03135020	2	D	10,0	10,0	30,0	82,0	0,125	12	■
JC877120D2C.0Z14-DURA	03135021	2	D	12,0	12,0	36,0	95,0	0,15	14	■

■ Stocked standard.

Universal

Steel and cast iron

Stainless steel and S-materials

Non ferrous

Hard

Plastic and cfrp

Graphite

X-Heads

Minimaster Plus

Minimaster

JC877

Composite – Square – 8-14 Flutes – Cylindrical – Chamfer – Inch

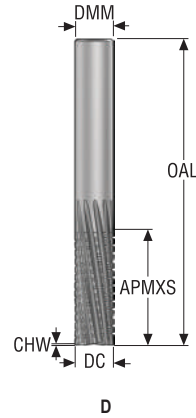

- Tolerances:
- DMM=h5
- DC= -.0008/- .0030 Inch
- Left hand helix

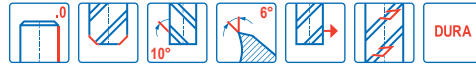

Designation	Item number	Length index	Tool shape	DC	DMM	APMXS	OAL	CHW	PCEDC	Cylindrical
JC877.250D2C.0Z8-DURA	03135129	2	D	0.250	0.250	0.750	2.500	0.003	8	■

■ Stocked standard.

- Universal
- Steel and cast iron
- Stainless steel and S-materials
- Non ferrous
- Hard
- Plastic and cfrp
- Graphite
- X-Heads
- Minimaster Plus
- Minimaster

Cutting data – JC877 Side milling roughing

SMG		a _e /DC	a _p /DC	f _z						v _c
				3	4	6	8	10	12	
TS2	E/A/D	0.334	2.0	0.0095	0.013	0.019	0.026	0.032	0.038	195 (170 – 220)
		0,334	2,0	0,00038	0,00050	0,00075	0,0010	0,0013	0,0015	640 (560 – 720)
TS3	E/A/D	0.334	2.0	0.0095	0.013	0.019	0.026	0.032	0.038	130 (110 – 150)
		0,334	2,0	0,00038	0,00050	0,00075	0,0010	0,0013	0,0015	425 (370 – 490)
TP2	E/A/D	0.334	2.0	0.0095	0.013	0.019	0.026	0.032	0.038	130 (98 – 160)
		0,334	2,0	0,00038	0,00050	0,00075	0,0010	0,0013	0,0015	425 (330 – 520)
TP3	E/A/D	0.334	2.0	0.0095	0.013	0.019	0.026	0.032	0.038	65 (40 – 91)
		0,334	2,0	0,00038	0,00050	0,00075	0,0010	0,0013	0,0015	215 (140 – 290)

Cutting data – JC877 Slot milling

SMG		a _p /DC	f _z						v _c
			3	4	6	8	10	12	
TS2	E/A/D	1,0	0,0060	0,0080	0,012	0,016	0,020	0,025	170 (150 – 200)
		1,0	0,0060	0,0080	0,012	0,016	0,020	0,025	115 (92 – 130)
TP2	E/A/D	1,0	0,0060	0,0080	0,012	0,016	0,020	0,025	115 (86 – 140)
		1,0	0,0060	0,0080	0,012	0,016	0,020	0,025	55 (35 – 80)

For cutting data recalculations, see pages 556 - 563

SMG = Seco material group
Coolant = A=air D=dry E=emulsion M=mist spray
v_c = m/min (sf/min)
f_z = mm (in/tooth)
a_p = mm/DC (in/DC) = factor
a_e = mm/DC (in/DC) = factor
All cutting data are target values

Universal
Steel and cast iron
Stainless steel and S-materials
Non ferrous
Hard
Plastic and cfrp
Graphite
X-Heads
Minimaster Plus
Minimaster

Cutting data – JC877 Side milling roughing – Inch

SMG		a _e /DC	a _p /DC	f _z			v _c
				1/4	3/8	1/2	
TS2	E/A/D	0.334	2.0	0.020	0.030	0.040	195 (170 – 220)
		0,334	2,0	0,00080	0,0012	0,0016	640 (560 – 720)
TS3	E/A/D	0.334	2.0	0.020	0.030	0.040	130 (110 – 150)
		0,334	2,0	0,00080	0,0012	0,0016	425 (370 – 490)
TP2	E/A/D	0.334	2.0	0.020	0.030	0.040	130 (98 – 160)
		0,334	2,0	0,00080	0,0012	0,0016	425 (330 – 520)
TP3	E/A/D	0.334	2.0	0.020	0.030	0.040	65 (40 – 91)
		0,334	2,0	0,00080	0,0012	0,0016	215 (140 – 290)

Cutting data – JC877 Slot milling – Inch

SMG		a _p /DC	f _z			v _c
			1/4	3/8	1/2	
TS2	E/A/D	1.0	0.013	0.019	0.026	160 (140 – 180)
		1,0	0,00050	0,00075	0,0010	520 (460 – 590)
TS3	E/A/D	1.0	0.013	0.019	0.026	105 (85 – 120)
		1,0	0,00050	0,00075	0,0010	345 (280 – 390)
TP2	E/A/D	1.0	0.013	0.019	0.026	105 (80 – 130)
		1,0	0,00050	0,00075	0,0010	345 (270 – 420)
TP3	E/A/D	1.0	0.013	0.019	0.026	55 (32 – 74)
		1,0	0,00050	0,00075	0,0010	180 (110 – 240)

For cutting data recalculations, see pages 556 - 563

SMG = Seco material group
Coolant = A=air D=dry E=emulsion M=mist spray
v_c = m/min (sf/min)
f_z = mm/tooth (in/tooth)
a_p = mm/DC (in/DC) = factor
a_e = mm/DC (in/DC) = factor
All cutting data are target values

JC880

Composite – Square – 4 Flutes – Cylindrical – Corner radius

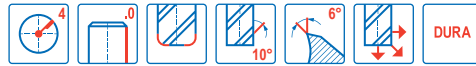
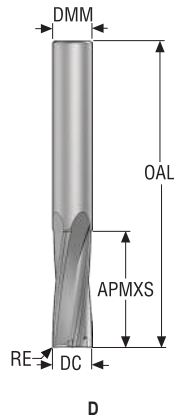

- Tolerances:
- DMM=h5
- DC=-0,02/-0,04 mm
- RE=±0,01 mm

Designation	Item number	Length index	Tool shape	DC	DMM	APMXS	OAL	RE	PCEDC	Cylindrical
				mm	mm	mm	mm	mm		
880040R020Z4.0-DURA	02843012	2	D	4,0	4,0	12,0	50,0	0,2	4	■
880050R020Z4.0-DURA	02843013	2	D	5,0	5,0	15,0	50,0	0,2	4	■
880060R020Z4.0-DURA	02720258	2	D	6,0	6,0	18,0	65,0	0,2	4	■
880080R020Z4.0-DURA	02720259	2	D	8,0	8,0	24,0	70,0	0,2	4	■
880100R020Z4.0-DURA	02720260	2	D	10,0	10,0	30,0	80,0	0,2	4	■
880120R020Z4.0-DURA	02720261	2	D	12,0	12,0	36,0	100,0	0,2	4	■
880160R020Z4.0-DURA	02720262	2	D	16,0	16,0	48,0	110,0	0,2	4	■
880200R020Z4.0-DURA	02720263	2	D	20,0	20,0	60,0	130,0	0,2	4	■

■ Stocked standard.

Universal

Steel and cast iron

Stainless steel and S-materials

Non ferrous

Hard

Plastic and cfrp

Graphite

X-Heads

Minimaster Plus

Minimaster

Cutting data – JC880 Side milling roughing

SMG		a _e /DC	a _p /DC	f _z							v _c
				4	6	8	10	12	16	20	
TS2	E/A/D	0.400	1.9	0.024	0.036	0.048	0.060	0.070	0.090	0.10	190 (160 – 210)
		0,400	1,9	0,00095	0,0014	0,0019	0,0024	0,0028	0,0036	0,0040	620 (530 – 680)
TS3	E/A/D	0.300	2.0	0.017	0.025	0.034	0.042	0.050	0.060	0.070	130 (93 – 170)
		0,300	2,0	0,00065	0,0010	0,0013	0,0017	0,0020	0,0024	0,0028	425 (310 – 550)
TP2	E/A/D	0.400	1.9	0.024	0.036	0.048	0.060	0.070	0.090	0.10	125 (95 – 150)
		0,400	1,9	0,00095	0,0014	0,0019	0,0024	0,0028	0,0036	0,0040	410 (320 – 490)
TP3	E/A/D	0.300	2.0	0.017	0.025	0.034	0.042	0.050	0.060	0.070	50 (40 – 92)
		0,300	2,0	0,00065	0,0010	0,0013	0,0017	0,0020	0,0024	0,0028	165 (140 – 300)

Cutting data – JC880 Slot milling

SMG		a _p /DC	f _z							v _c	
			4	5	6	8	10	12	16		20
TS2	E/A/D	1.0	0.024	0.030	0.036	0.048	0.060	0.070	0.090	0.10	150 (130 – 170)
		1,0	0,00095	0,0012	0,0014	0,0019	0,0024	0,0028	0,0036	0,0040	490 (430 – 550)
TS3	E/A/D	1.0	0.015	0.019	0.022	0.030	0.038	0.044	0.055	0.065	100 (71 – 130)
		1,0	0,00060	0,00075	0,00085	0,0012	0,0015	0,0017	0,0022	0,0026	330 (240 – 420)
TP2	E/A/D	1.0	0.024	0.030	0.036	0.048	0.060	0.070	0.090	0.10	100 (76 – 120)
		1,0	0,00095	0,0012	0,0014	0,0019	0,0024	0,0028	0,0036	0,0040	330 (250 – 390)
TP3	E/A/D	1.0	0.015	0.019	0.022	0.030	0.038	0.044	0.055	0.065	40 (31 – 70)
		1,0	0,00060	0,00075	0,00085	0,0012	0,0015	0,0017	0,0022	0,0026	130 (110 – 220)

For cutting data recalculations, see pages 556 - 563

SMG = Seco material group
Coolant = A=air D=dry E=emulsion M=mist spray
v_c = m/min (sf/min)
f_z = mm (in/tooth)
a_p = mm/DC (in/DC) = factor
a_e = mm/DC (in/DC) = factor
All cutting data are target values

JC885

Composite – Square – 4 Flutes – Cylindrical – Corner radius

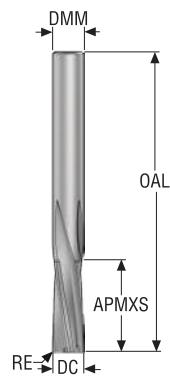

D

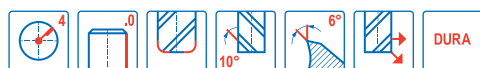

- Tolerances:
- DMM=h5
- DC=-0,02/-0,04 mm
- RE=±0,01 mm
- Left hand helix

Designation	Item number	Length index	Tool shape	DC	DMM	APMXS	OAL	RE	PCEDC	Cylindrical
				mm	mm	mm	mm	mm		
JC885040D2R020.0Z4-DURA	02843014	2	D	4,0	4,0	12,0	50,0	0,2	4	■
JC885060D2R020.0Z4-DURA	02843016	2	D	6,0	6,0	18,0	70,0	0,2	4	■
JC885080D2R020.0Z4-DURA	02843017	2	D	8,0	8,0	24,0	80,0	0,2	4	■

■ Stocked standard.

Universal

Steel and cast iron

Stainless steel and S-materials

Non ferrous

Hard

Plastic and cfrp

Graphite

X-Heads

Minimaster Plus

Minimaster

Cutting data – JC885 Side milling roughing

SMG		a _p /DC	a _p /DC	f _z				v _c
				4	6	8	10	
TS2	E/A/D	0.400	2.0	0.024	0.036	0.048	0.060	190 (160 – 210)
		0,400	2,0	0,00095	0,0014	0,0019	0,0024	620 (530 – 680)
TS3	E/A/D	0.300	2.0	0.017	0.025	0.034	0.042	130 (99 – 170)
		0,300	2,0	0,00065	0,0010	0,0013	0,0017	425 (330 – 550)
TP2	E/A/D	0.400	2.0	0.024	0.036	0.048	0.060	125 (94 – 150)
		0,400	2,0	0,00095	0,0014	0,0019	0,0024	410 (310 – 490)
TP3	E/A/D	0.300	2.0	0.017	0.025	0.034	0.042	50 (33 – 92)
		0,300	2,0	0,00065	0,0010	0,0013	0,0017	165 (110 – 300)

Cutting data – JC885 Slot milling

SMG		a _p /DC	f _z				v _c
			4	6	8	10	
TS2	E/A/D	1.0	0.024	0.036	0.048	0.060	150 (130 – 170)
		1,0	0,00095	0,0014	0,0019	0,0024	490 (430 – 550)
TS3	E/A/D	0.70	0.015	0.022	0.030	0.038	100 (76 – 130)
		0,70	0,00060	0,00085	0,0012	0,0015	330 (250 – 420)
TP2	E/A/D	1.0	0.024	0.036	0.048	0.060	100 (75 – 120)
		1,0	0,00095	0,0014	0,0019	0,0024	330 (250 – 390)
TP3	E/A/D	0.70	0.015	0.022	0.030	0.038	40 (26 – 70)
		0,70	0,00060	0,00085	0,0012	0,0015	130 (86 – 220)

For cutting data recalculations, see pages 556 - 563

SMG = Seco material group
Coolant = A=air D=dry E=emulsion M=mist spray
v_c = m/min (sf/min)
f_z = mm (in/tooth)
a_p = mm/DC (in/DC) = factor
a_e = mm/DC (in/DC) = factor
All cutting data are target values

JC898

High feed – Stacked materials – Corner radius – 4 Flutes – Cylindrical – Corner radius

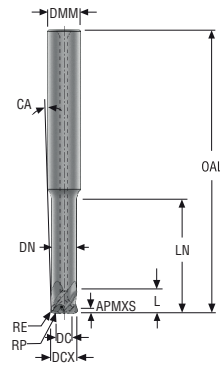

G

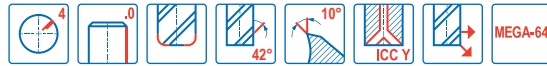

- Tolerances:
- DMM=h5
- DC= e7
- RE= ±0,1 mm



Designation	Item number	Length index	Tool shape	ICC	DC	DCX	DMM	APMXS	L	OAL	LN	DN	RE	RP	CA°	PCEDC	Cylindrical
					mm	mm	mm	mm	mm	mm	mm	mm	mm	mm	mm	mm	mm
JC898080G3HZ4A.0-M64	03245308	3	G	■	4,0	8,0	10,0	0,43	6,0	88,0	35,0	7,6	0,5	0,87	1,5 °	4	■
JC898150G3HZ4A.0-M64	03245309	3	G	■	7,5	15,0	16,0	0,796	12,0	125,0	70,0	14,3	0,94	1,63	0,4 °	4	■

■ Stocked standard.

Universal

Steel and cast iron

Stainless steel and S-materials

Non ferrous

Hard

Plastic and cfrp

Graphite

X-Heads

Minimaster Plus

Minimaster

Cutting data – JC898 Side milling

SMG		a_e/DCX	a_p/DCX	f_z		v_c
				8	15	
S12+TS2/TP2	D	0,30	0,020	0,1	0,15	90 (80-120)
		0,30	0,020	0,0040	0,0060	300 (270-400)
TP2+TS2/TP2	D	0,30	0,034	0,12	0,25	120 (90-150)
		0,30	0,034	0,0048	0,0100	400 (300-490)

Cutting data – JC898 Slot milling

SMG		a_p/DCX	f_z		v_c
			8	15	
S12+TP2/TS2	D	0,020	0,08	0,10	90 (80-120)
		0,020	0,0032	0,0040	300 (270-400)
N1+TP2/TS2	D	0,034	0,1	0,10	120 (90-150)
		0,034	0,0040	0,0040	400 (300-490)

For cutting data recalculations, see pages 556 - 563

SMG = Seco material group
Coolant = A=air D=dry E=emulsion M=mist spray
 v_c = m/min (sf/min)
 f_z = mm (in/tooth)
 a_p = mm/DC (in/DC) = factor
 a_e = mm/DC (in/DC) = factor
All cutting data are target values

Universal

Steel and cast iron

Stainless steel and S-materials

Non ferrous

Hard

Plastic and cfrp

Graphite

X-Heads

Minimaster Plus

Minimaster

JC899

High performance – Stacked materials – Square – 4 Flutes – Cylindrical – Sharp

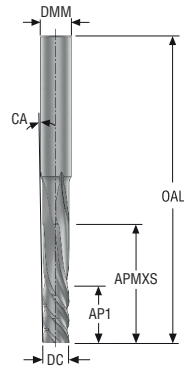

F

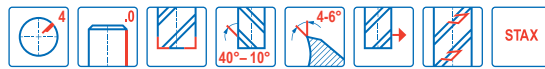

- Tolerances:
- DMM=h5
- DC= ±0,02 mm



Designation	Item number	Length index	Tool shape	Chip splitters	DC	DMM	APMXS	AP1	OAL	CA°	PCEDC	Cylindrical
					mm	mm	mm	mm	mm			
JC899085F3S.0Z4-STAX	03245482	3	F	■	8,5	10,0	38,0	19,0	100,0	0,8 °	4	■
JC899148F3S.0Z4-STAX	03245480	3	F	■	14,8	16,0	55,0	30,0	150,0	0,53 °	4	■
JC899148F4S.0Z4-STAX	03245481	4	F	■	14,8	16,0	62,0	37,0	150,0	0,48 °	4	■

■ Stocked standard.

Universal

Steel and cast iron

Stainless steel and S-materials

Non ferrous

Hard

Plastic and cfrp

Graphite

X-Heads

Minimaster Plus

Minimaster

JC899

High performance – Stacked materials – Square – 4 Flutes – Cylindrical – Sharp – Inch

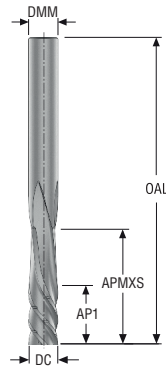

D

- Tolerances:
- DMM=h5
- DC= ±0,0008 Inch

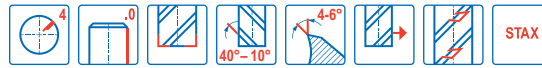

Designation	Item number	Length index	Tool shape	Chip splitters	DC	DMM	APMXS	AP1	OAL	PCEDC	Cylindrical
					inch	inch	inch	inch	inch		
JC8990375D4S.0Z4-STAX	03245483	4	D	■	0.373	0.375	1.500	0.625	4.000	4	■

■ Stocked standard.

Universal
 Steel and cast iron
 Stainless steel and S-materials
 Non ferrous
 Hard
 Plastic and cfrp
 Graphite
 X-Heads
 Minimaster Plus
 Minimaster

Cutting data – JC899 Finishing

SMG		a _e /DC		f _z		v _c
				8.5	14.8	
S12+TP2/TS2	D	0,025	4,0	0,04	0,075	40 (30 — 50)
		0,025	4,0	0,0016	0,0030	140 (100 — 170)
N1+TP2/TS2	D	0,025	4,0	0,06	0,09	60 (50 — 75)
		0,025	4,0	0,0032	0,0036	200 (170 — 250)

Cutting data – JC899 Finishing – Inch

SMG		a _e /DC		f _z		v _c
				3/8		
S12+TP2/TS2	D	0,025	4,0	0,05		40 (30 — 50)
		0,025	4,0	0,0022		140 (100 — 170)
N1+TP2/TS2	D	0,025	4,0	0,07		60 (50 — 75)
		0,025	4,0	0,0028		200 (170 — 250)

For cutting data recalculations, see pages 556 - 563

SMG = Seco material group
Coolant = A=air D=dry E=emulsion M=mist spray
v_c = m/min (sf/min)
f_z = mm (in/tooth)
a_p = mm/DC (in/DC) = factor
a_e = mm/DC (in/DC) = factor
All cutting data are target values

Universal
Steel and cast iron
Stainless steel and S-materials
Non ferrous
Hard
Plastic and cfrp
Graphite
X-Heads
Minimaster Plus
Minimaster

JPD850

Composite – Ball nose – 2 Flutes – Cylindrical – ICC

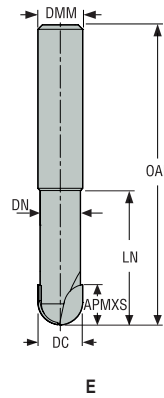

- Tolerances:
- DMM=h5
- DC= h10
- ICC= 2 straight channels

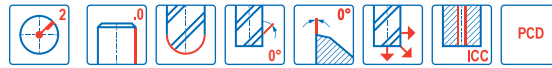

Designation	Item number	Length index	Tool shape	ICC	DC	DMM	APMXS	OAL	LN	DN	PCEDC	Cylindrical
					mm	mm	mm	mm	mm	mm		
JPD850060E2B.0Z2A	02968184	2	E	■	6,0	6,0	7,0	58,0	18,0	5,4	2	■
JPD850080E2B.0Z2A	02968185	2	E	■	8,0	8,0	8,0	64,0	24,0	7,2	2	■
JPD850100E2B.0Z2A	02968186	2	E	■	10,0	10,0	10,0	73,0	30,0	9,0	2	■

■ Stocked standard.

Universal

Steel and cast iron

Stainless steel and S-materials

Non ferrous

Hard

Plastic and cfrp

Graphite

X-Heads

Minimaster Plus

Minimaster

Cutting data – JPD850 Copy milling

SMG		a _p /DC	a _e /DC	f _z					v _c
				4	5	6	8	10	
TS2	E/A/D	0.200	0.50	0.040	0.048	0.060	0.080	0.10	550 (470 — 820)
		0,200	0,50	0,0016	0,0019	0,0024	0,0032	0,0040	1800 (1600 — 2600)
TS3	E/A/D	0.200	0.50	0.040	0.048	0.060	0.080	0.10	310 (270 — 460)
		0,200	0,50	0,0016	0,0019	0,0024	0,0032	0,0040	1025 (890 — 1500)
TP2	E/A/D	0.200	0.50	0.040	0.048	0.060	0.080	0.10	890 (750 — 1300)
		0,200	0,50	0,0016	0,0019	0,0024	0,0032	0,0040	2925 (2500 — 4200)
TP3	E/A/D	0.200	0.50	0.040	0.048	0.060	0.080	0.10	580 (500 — 870)
		0,200	0,50	0,0016	0,0019	0,0024	0,0032	0,0040	1900 (1700 — 2800)

For cutting data recalculations, see pages 556 - 563

SMG = Seco material group
 Coolant = A=air D=dry E=emulsion M=mist spray
 v_c = m/min (sf/min)
 f_z = mm (in/tooth)
 a_p = mm/DC (in/DC) = factor
 a_e = mm/DC (in/DC) = factor
 All cutting data are target values

Universal
 Steel and cast iron
 Stainless steel and S-materials
 Non ferrous
 Hard
 Plastic and cfrp
 Graphite
 X-Heads
 Minimaster Plus
 Minimaster

JPD880

Composite – Square – 3 Flutes – Cylindrical – Chamfer – ICC

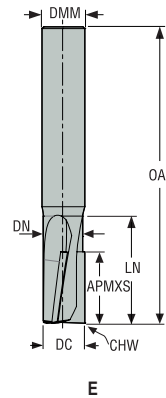

- Tolerances:
- DMM=h5
- DC=h10
- ICC=Y



Designation	Item number	Length index	Tool shape	ICC	DC	DMM	APMXS	OAL	LN	DN	CHW	PCEDC	Cylindrical
					mm	mm	mm	mm	mm	mm	mm		
JPD880060G2C.0Z3A	02968190	2	G	■	6,0	8,0	13,0	64,0	20,0	5,3	0,1	3	■
JPD880080E2C.0Z3A	02968191	2	E	■	8,0	8,0	15,0	64,0	20,0	7,3	0,1	3	■
JPD880100E2C.0Z3A	02968192	2	E	■	10,0	10,0	13,0	73,0	30,0	9,2	0,1	3	■
JPD880120E2C.0Z3A	02968194	2	E	■	12,0	12,0	13,0	83,0	30,0	11,0	0,1	3	■
JPD880160E2C.0Z3A	02968196	2	E	■	16,0	16,0	13,0	90,0	35,0	14,8	0,1	3	■
JPD880100E3C.0Z3A	02968193	3	E	■	10,0	10,0	20,0	73,0	30,0	9,2	0,1	3	■
JPD880160E3C.0Z3A	02968197	3	E	■	16,0	16,0	20,0	90,0	35,0	14,8	0,1	3	■

■ Stocked standard.

Universal

Steel and cast iron

Stainless steel and S-materials

Non ferrous

Hard

Plastic and cfrp

Graphite

X-Heads

Minimaster Plus

Minimaster

Cutting data – JPD880 Side milling

SMG		a _p /DC	a _p /DC	f _z					v _c
				6	8	10	12	16	
TS2	E/A/D	0.300	1.2	0.060	0.080	0.10	0.12	0.15	510 (430 – 750)
		0,300	1,2	0,0024	0,0032	0,0040	0,0048	0,0060	1675 (1500 – 2400)
TS3	E/A/D	0.300	1.2	0.060	0.080	0.10	0.12	0.15	275 (230 – 410)
		0,300	1,2	0,0024	0,0032	0,0040	0,0048	0,0060	900 (760 – 1300)
TP2	E/A/D	0.300	1.2	0.060	0.080	0.10	0.12	0.15	810 (680 – 940)
		0,300	1,2	0,0024	0,0032	0,0040	0,0048	0,0060	2650 (2300 – 3000)
TP3	E/A/D	0.300	1.2	0.060	0.080	0.10	0.12	0.15	520 (440 – 780)
		0,300	1,2	0,0024	0,0032	0,0040	0,0048	0,0060	1700 (1500 – 2500)

Cutting data – JPD880 Slot milling

SMG		a _p /DC	a _p /DC	f _z					v _c
				6	8	10	12	16	
TS2	E/A/D	1.0	0.055	0.075	0.090	0.11	0.14	385 (330 – 570)	
		1,0	0,0022	0,0030	0,0036	0,0044	0,0055	1275 (1100 – 1800)	
TS3	E/A/D	1.0	0.055	0.075	0.090	0.11	0.14	210 (180 – 310)	
		1,0	0,0022	0,0030	0,0036	0,0044	0,0055	690 (600 – 1000)	
TP2	E/A/D	1.0	0.055	0.075	0.090	0.11	0.14	620 (520 – 710)	
		1,0	0,0022	0,0030	0,0036	0,0044	0,0055	2025 (1800 – 2300)	
TP3	E/A/D	1.0	0.055	0.075	0.090	0.11	0.14	395 (340 – 590)	
		1,0	0,0022	0,0030	0,0036	0,0044	0,0055	1300 (1200 – 1900)	

For cutting data recalculations, see pages 556 - 563

SMG = Seco material group
Coolant = A=air D=dry E=emulsion M=mist spray
v_c = m/min (sf/min)
f_z = mm (in/tooth)
a_p = mm/DC (in/DC) = factor
a_s = mm/DC (in/DC) = factor
All cutting data are target values

Universal
Steel and cast iron
Stainless steel and S-materials
Non ferrous
Hard
Plastic and cfrp
Graphite
X-Heads
Minimaster Plus
Minimaster

JPD890

Composite – Square – 2 Flutes – Cylindrical – Chamfer – ICC

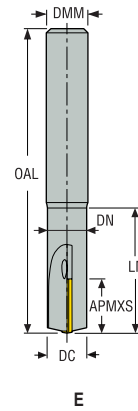

- Tolerances:
- DMM=h5
- DC=h10
- ICC=2 straight channels

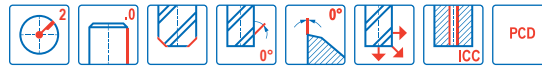

Designation	Item number	Length index	Tool shape	ICC	DC	DMM	APMXS	OAL	LN	DN	CHW	PCEDC	Cylindrical
					mm	mm	mm	mm	mm	mm	mm		
JPD890060G2S.0Z2A	02791382	2	G	■	6,0	8,0	13,0	64,0	20,0	5,4	0,1	2	■
JPD890080E2S.0Z2A	02791383	2	E	■	8,0	8,0	15,0	64,0	20,0	7,4	0,1	2	■
JPD890100E2S.0Z2A	02791384	2	E	■	10,0	10,0	13,0	73,0	30,0	9,4	0,1	2	■
JPD890120E2S.0Z2A	02791386	2	E	■	12,0	12,0	13,0	83,0	30,0	11,4	0,1	2	■
JPD890100E3S.0Z2A	02791385	3	E	■	10,0	10,0	20,0	73,0	30,0	9,4	0,1	2	■
JPD890120E3S.0Z2A	02791387	3	E	■	12,0	12,0	20,0	83,0	30,0	11,4	0,1	2	■

■ Stocked standard.

Universal

Steel and cast iron

Stainless steel and S-materials

Non ferrous

Hard

Plastic and cfrp

Graphite

X-Heads

Minimaster Plus

Minimaster

Cutting data – JPD890 Side milling

SMG		a _e /DC	a _p /DC	f _z				v _c
				6	8	10	12	
TS2	E/A/D	0.300	1.2	0.12	0.16	0.20	0.24	415 (360 – 620)
		0,300	1,2	0,0048	0,0065	0,0080	0,0095	1350 (1200 – 2000)
TS3	E/A/D	0.200	1.2	0.060	0.080	0.10	0.12	305 (260 – 450)
		0,200	1,2	0,0024	0,0032	0,0040	0,0048	1000 (860 – 1400)
TP2	E/A/D	0.300	1.2	0.12	0.16	0.20	0.24	670 (560 – 770)
		0,300	1,2	0,0048	0,0065	0,0080	0,0095	2200 (1900 – 2500)
TP3	E/A/D	0.200	1.2	0.060	0.080	0.10	0.12	580 (490 – 860)
		0,200	1,2	0,0024	0,0032	0,0040	0,0048	1900 (1700 – 2800)

Cutting data – JPD890 Slot milling

SMG		a _p /DC	f _z				v _c
			6	8	10	12	
TS2	E/A/D	1.0	0.060	0.080	0.10	0.12	375 (320 – 550)
		1,0	0,0024	0,0032	0,0040	0,0048	1225 (1100 – 1800)
TS3	E/A/D	1.0	0.042	0.055	0.070	0.085	225 (190 – 330)
		1,0	0,0017	0,0022	0,0028	0,0034	740 (630 – 1000)
TP2	E/A/D	1.0	0.060	0.080	0.10	0.12	600 (500 – 690)
		1,0	0,0024	0,0032	0,0040	0,0048	1975 (1700 – 2200)
TP3	E/A/D	1.0	0.042	0.055	0.070	0.085	420 (360 – 630)
		1,0	0,0017	0,0022	0,0028	0,0034	1375 (1200 – 2000)

For cutting data recalculations, see pages 556 - 563

SMG = Seco material group
Coolant = A=air D=dry E=emulsion M=mist spray
v_c = m/min (sf/min)
f_z = mm (in/tooth)
a_p = mm/DC (in/DC) = factor
a_e = mm/DC (in/DC) = factor
All cutting data are target values

Universal
Steel and cast iron
Stainless steel and S-materials
Non ferrous
Hard
Plastic and cfrp
Graphite
X-Heads
Minimaster Plus
Minimaster

J93F

General purpose – Plastic – Square – 2 Flutes – Cylindrical – Sharp

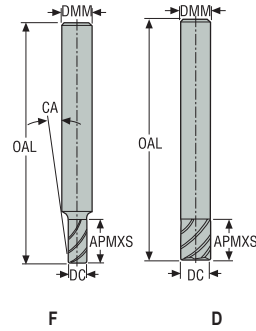

- Tolerances:
- DMM= h5
- DC= Ø1-Ø6= -0,02/-0,034 mm
- DC= Ø8-Ø20= -0,02/-0,044 mm
- Regrind possible if DC is ≥Ø6

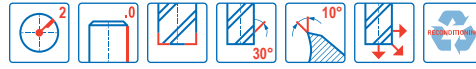

Designation	Item number	Length index	Tool shape	DC	DMM	APMXS	OAL	CA°	PCEDC	Cylindrical
				mm	mm	mm	mm	mm		
93015-F	02605874	2	F	1,5	3,0	6,0	40,0	4,0	2	■
93020-F	02605888	2	F	2,0	3,0	9,0	40,0	2,5	2	■
93030-F	02606060	2	D	3,0	3,0	12,0	40,0	-	2	■
93040-F	02606061	2	D	4,0	4,0	14,0	50,0	-	2	■
93060-F	02606063	2	D	6,0	6,0	20,0	65,0	-	2	■
93080-F	02606064	2	D	8,0	8,0	20,0	70,0	-	2	■
93100-F	02606065	2	D	10,0	10,0	25,0	80,0	-	2	■
93120-F	02606066	2	D	12,0	12,0	25,0	90,0	-	2	■
93160-F	02606068	2	D	16,0	16,0	30,0	90,0	-	2	■
93L060-F	02606071	3	D	6,0	6,0	40,0	100,0	-	2	■
93L080-F	02606072	3	D	8,0	8,0	40,0	100,0	-	2	■
93L100-F	02606073	3	D	10,0	10,0	40,0	100,0	-	2	■
93L120-F	02606074	3	D	12,0	12,0	45,0	100,0	-	2	■
93L160-F	02606077	3	D	16,0	16,0	45,0	100,0	-	2	■
93L200-F	02606078	3	D	20,0	20,0	55,0	125,0	-	2	■
93XL120-F	02606079	4	D	12,0	12,0	30,0	150,0	-	2	■
93XL160-F	02606080	4	D	16,0	16,0	65,0	150,0	-	2	■
93XL200-F	02606081	4	D	20,0	20,0	65,0	150,0	-	2	■

■ Stocked standard.

Universal

Steel and cast iron

Stainless steel and S-materials

Non ferrous

Hard

Plastic and cfrp

Graphite

X-Heads

Minimaster Plus

Minimaster

Cutting data – J93F Side milling

SMG		a _e /DC	a _p /DC	f _z										v _c
				1.5	2	3	4	6	8	10	12	16	20	
TS1	A	0.400	1.4	0.015	0.020	0.030	0.040	0.060	0.080	0.10	0.12	0.15	0.17	590 (480 – 710)
		0,400	1,4	0,00060	0,00080	0,0012	0,0016	0,0024	0,0032	0,0040	0,0048	0,0060	0,0065	1925 (1600 – 2300)
TP1	A	0.400	1.4	0.015	0.020	0.030	0.040	0.060	0.080	0.10	0.12	0.15	0.17	570 (460 – 680)
		0,400	1,4	0,00060	0,00080	0,0012	0,0016	0,0024	0,0032	0,0040	0,0048	0,0060	0,0065	1875 (1600 – 2200)

Cutting data – J93F Slot milling

SMG		a _p /DC	f _z										v _c
			1.5	2	3	4	6	8	10	12	16	20	
TS1	A	0.50	0.012	0.016	0.024	0.032	0.048	0.065	0.080	0.095	0.13	0.16	500 (400 – 590)
		0,50	0,00048	0,00065	0,00095	0,0013	0,0019	0,0026	0,0032	0,0038	0,0050	0,0065	1650 (1400 – 1900)
TP1	A	0.50	0.012	0.016	0.024	0.032	0.048	0.065	0.080	0.095	0.13	0.16	485 (390 – 580)
		0,50	0,00048	0,00065	0,00095	0,0013	0,0019	0,0026	0,0032	0,0038	0,0050	0,0065	1600 (1300 – 1900)

For cutting data recalculations, see pages 556 - 563

SMG = Seco material group
 Coolant = A=air D=dry E=emulsion M=mist spray
 v_c = m/min (sf/min)
 f_z = mm (in/tooth)
 a_p = mm/DC (in/DC) = factor
 a_e = mm/DC (in/DC) = factor
 All cutting data are target values

Universal
 Steel and cast iron
 Stainless steel and S-materials
 Non ferrous
 Hard
 Plastic and cfrp
 Graphite
 X-Heads
 Minmaster Plus
 Minmaster

J28

General purpose – Plastic – Square – 1 Flute – Cylindrical – Sharp

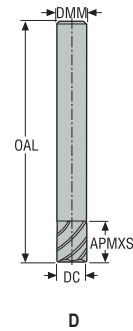

- Tolerances:
- DMM= h5
- DC= Ø2-Ø6= -0,02/-0,034 mm
- DC= Ø8-Ø12= -0,02/-0,044 mm
- Regrind possible if DC is ≥Ø6

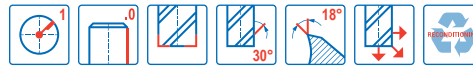

Designation	Item number	Length index	Tool shape	DC	DMM	APMXS	OAL	PCEDC	Cylindrical
				mm	mm	mm	mm		
28030	00029353	2	D	3,0	3,0	10,0	40,0	1	■
28040	00029361	2	D	4,0	4,0	14,0	50,0	1	■
28050	00029363	2	D	5,0	5,0	16,0	60,0	1	■
28060	00029366	2	D	6,0	6,0	20,0	65,0	1	■
28080	00029369	2	D	8,0	8,0	25,0	75,0	1	■
28100	00029370	2	D	10,0	10,0	25,0	75,0	1	■
28120	00029372	2	D	12,0	12,0	25,0	75,0	1	■

■ Stocked standard.

Universal

Steel and cast iron

Stainless steel and S-materials

Non ferrous

Hard

Plastic and cfrp

Graphite

X-Heads

Minimaster Plus

Minimaster

Cutting data – J28 Side milling $a_e/DC=0,4$

SMG		a_e/DC	a_p/DC	f_z								v_c
				3	4	5	6	8	10	12		
TS1	A/D	0.300	1.5	0.040	0.050	0.065	0.080	0.10	0.13	0.16	490 (370 – 610)	
		0,300	1,5	0,0016	0,0020	0,0026	0,0032	0,0040	0,0050	0,0065	1600 (1300 – 2000)	

Cutting data – J28 Slot milling

SMG		a_p/DC	f_z								v_c
			3	4	5	6	8	10	12		
TS1	A/D	1.0	0.026	0.036	0.044	0.055	0.070	0.090	0.11	400 (310 – 490)	
		1,0	0,0010	0,0014	0,0017	0,0022	0,0028	0,0036	0,0044	1300 (1100 – 1600)	

For cutting data recalculations, see pages 556 - 563

SMG = Seco material group
 Coolant = A=air D=dry E=emulsion M=mist spray
 v_c = m/min (sf/min)
 f_z = mm (in/tooth)
 a_p = mm/DC (in/DC) = factor
 a_e = mm/DC (in/DC) = factor
 All cutting data are target values

Universal
 Steel and cast iron
 Stainless steel and S-materials
 Non ferrous
 Hard
 Plastic and cfrp
 Graphite
 X-Heads
 Minimaster Plus
 Minimaster



GRAPHITE

Seco diamond-coated solid carbide end mills are designed specifically for machining graphite. They offer up to 10 times more tool life than milling cutters with conventional coatings. Available in a variety of geometries and an extensive diameter range, these tools feature the best possible substrate to ensure the perfect adhesion of the diamond coating across a range of cutting parameters.

- JD620, JD630, JD640 and JME642 for radius type.
- JD660, SMB614, SMB616 and JMB642 for ball-nose type.

Universal

Steel and cast iron

Stainless steel
and S-materials

Non ferrous

Hard

Plastic and CFRP















Graphite

X-Heads

Minimaster Plus

Minimaster

Tool Selection Graphite

					
Name		JD620	JD630	JD640	JD660
Page(s)		459	461	463	465
Family name		DIAMOND	DIAMOND	DIAMOND	DIAMOND
Type of mill					
Shank	Cylindrical	■	■	■	■
	Weldon				
Number of Flutes		2	3	4	2
ICC					
Diameter range	Metric	3-12	3-8	6-12	3-6
	Inch				
Length availability		2,3,4	2,3,4	2,3,4	1,2,3,4,5
Operation					
					
					
SMG					
GR		●	●	●	●

■ Stock standard □ Weldon available, delivery time is 3 days.
 ● Preferred choice ○ Alternative choice

Universal
 Steel and cast iron
 Stainless steel and S-materials
 Non ferrous
 Hard
 Plastic and CFRP
 Graphite
 X-Heads
 Minimaster Plus
 Minimaster

Universal
 Steel and cast iron
 Stainless steel and S-materials
 Non ferrous
 Hard
 Plastic and cfrp
 Graphite
 X-Heads
 Minimaster Plus
 Minimaster

Tool Selection Graphite

Name		SMB614/616	JME642	JMB642/JMB662
Page(s)		467	469	471
Family name		MINI DIAMOND	MINI DIAMOND	MINI DIAMOND
Type of mill				
Shank	Cylindrical	■	■	■
	Weldon			
Number of Flutes		2	2	2
ICC				
Diameter range	Metric	0,6-3	0,2-2,0	0,2-3,0
	Inch			
Length availability		4,5,6,7	1,3,5,6,7	1,3,5,6,7
Operation				
SMG				
GR		●	●	●

■ Stock standard □ Weldon available, delivery time is 3 days.
 ● Preferred choice ○ Alternative choice

JD620

Diamond – Graphite – Square – 2 Flutes – Cylindrical – Corner radius

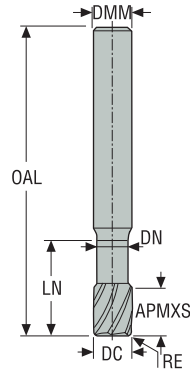

E

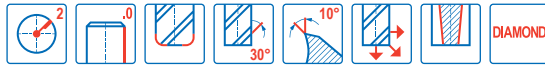

- Tolerances:
- Run-out= <0,01 mm
- DMM= h5
- DC= -0,02/-0,04 mm
- RE= ±0,05 mm



Designation	Item number	Length index	Tool shape	DC	DMM	APMXS	OAL	LN	DN	RE	PCEDC	Cylindrical
				mm	mm	mm	mm	mm	mm	mm		
620V030R050-DIAMOND	00023425	2	E	3,0	3,0	5,0	60,0	30,0	2,85	0,5	2	■
620V040R050-DIAMOND	00023427	2	E	4,0	4,0	5,0	60,0	30,0	3,85	0,5	2	■
620V060R050-DIAMOND	00023429	2	E	6,0	6,0	10,0	80,0	40,0	5,8	0,5	2	■
620V080R050-DIAMOND	00023431	2	E	8,0	8,0	10,0	80,0	40,0	7,7	0,5	2	■
620V100R050-DIAMOND	00023435	2	E	10,0	10,0	10,0	80,0	40,0	9,7	0,5	2	■
620V120R050-DIAMOND	00023437	2	E	12,0	12,0	10,0	80,0	40,0	11,7	0,5	2	■
620VL060R050-DIAMOND	00023444	3	E	6,0	6,0	10,0	100,0	70,0	5,8	0,5	2	■
620VL080R050-DIAMOND	00023446	3	E	8,0	8,0	10,0	100,0	70,0	7,8	0,5	2	■
620VL080R100-DIAMOND	00023447	3	E	8,0	8,0	10,0	100,0	70,0	7,8	1,0	2	■
620VL100R050-DIAMOND	00023448	3	E	10,0	10,0	10,0	100,0	70,0	9,8	0,5	2	■
620VL100R100-DIAMOND	00023449	3	E	10,0	10,0	10,0	100,0	70,0	9,8	1,0	2	■
620VL120R050-DIAMOND	00023450	3	E	12,0	12,0	10,0	100,0	70,0	11,8	0,5	2	■
620VL120R100-DIAMOND	00023451	3	E	12,0	12,0	10,0	100,0	70,0	11,7	1,0	2	■
620VSL100R100-DIAMOND	00023452	4	E	10,0	10,0	10,0	150,0	100,0	9,8	1,0	2	■
620VSL120R100-DIAMOND	00023453	4	E	12,0	12,0	10,0	150,0	100,0	11,8	1,0	2	■

■ Stocked standard.

Universal

Steel and cast iron

Stainless steel and S-materials

Non ferrous

Hard

Plastic and CFRP

Graphite

X-Heads

Minimaster Plus

Minimaster

Cutting data – JD620 Side milling

SMG		a_e/DC	a_p/DC	f_z						v_c
				3	4	6	8	10	12	
GR1	D	0.500 0,500	0.50 0,50	0.030 0,0012	0.040 0,0016	0.060 0,0024	0.080 0,0032	0.10 0,0040	0.12 0,0048	690 (580 – 800) 2275 (2000 – 2600)

Cutting data – JD620 Slot milling

SMG		a_p/DC	f_z						v_c
			3	4	6	8	10	12	
GR1	D	0.50 0,50	0.024 0,00095	0.032 0,0013	0.048 0,0019	0.065 0,0026	0.080 0,0032	0.095 0,0038	610 (520 – 710) 2000 (1800 – 2300)

For cutting data recalculations, see pages 556 - 563

SMG = Seco material group
Coolant = A=air D=dry E=emulsion M=mist spray
 v_c = m/min (sf/min)
 f_z = mm (in/tooth)
 a_p = mm/DC (in/DC) = factor
 a_e = mm/DC (in/DC) = factor
All cutting data are target values

Universal

Steel and cast iron

Stainless steel and S-materials

Non ferrous

Hard

Plastic and CFRP

Graphite

X-Heads

Minimaster Plus

Minimaster

JD630

Diamond – Graphite – Square – 3 Flutes – Cylindrical – Corner radius

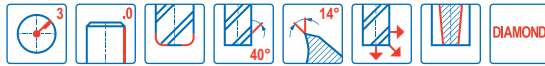
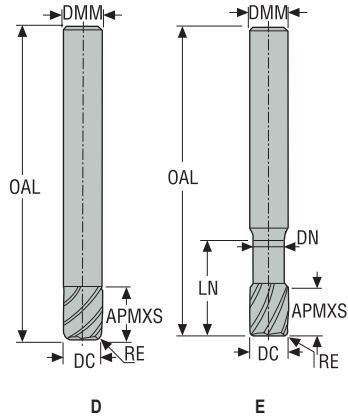

- Tolerances:
- Run-out= <0,01 mm
- DMM= h5
- DC= -0,02/-0,04 mm
- RE= ±0,05 mm

Designation	Item number	Length index	Tool shape	DC	DMM	APMXS	OAL	LN	DN	RE	PCEDC	Cylindrical
				mm	mm	mm	mm	mm	mm	mm		
630030R015-DIAMOND	00023454	2	D	3,0	3,0	12,0	40,0	–	–	0,15	3	■
630040R020-DIAMOND	00023456	2	D	4,0	4,0	14,0	50,0	–	–	0,2	3	■
630050R030-DIAMOND	00023457	2	D	5,0	5,0	16,0	50,0	–	–	0,3	3	■
630060R030-DIAMOND	00023458	2	D	6,0	6,0	20,0	65,0	–	–	0,3	3	■
630080R050-DIAMOND	00023459	2	D	8,0	8,0	20,0	65,0	–	–	0,5	3	■
630V030R030-DIAMOND	00023464	3	E	3,0	3,0	5,0	40,0	15,0	2,9	0,3	3	■
630V040R030-DIAMOND	00023465	3	E	4,0	4,0	5,0	50,0	20,0	3,9	0,3	3	■
630VL030R020-DIAMOND	00023467	4	E	3,0	3,0	5,0	60,0	25,0	2,9	0,2	3	■
630VL040R020-DIAMOND	00023470	4	E	4,0	4,0	5,0	60,0	30,0	3,9	0,2	3	■
630VL050R020-DIAMOND	00023471	4	E	5,0	5,0	6,0	70,0	40,0	4,9	0,2	3	■
630VL060R050-DIAMOND	00023472	4	E	6,0	6,0	10,0	100,0	60,0	5,9	0,5	3	■

■ Stocked standard.

Universal

Steel and cast iron

Stainless steel and S-materials

Non ferrous

Hard

Plastic and CFRP

Graphite

X-Heads

Minimaster Plus

Minimaster

Cutting data – JD630 Side milling

SMG		a _e /DC	a _p /DC	f _z					v _c
				3	4	5	6	8	
GR1	D	0.500 0,500	1.0 1,0	0.030 0,0012	0.040 0,0016	0.050 0,0020	0.060 0,0024	0.080 0,0032	680 (580 – 790) 2225 (2000 – 2500)

Cutting data – JD630 Slot milling

SMG		a _p /DC	f _z					v _c
			3	4	5	6	8	
GR1	D	0.50 0,50	0.024 0,00095	0.032 0,0013	0.040 0,0016	0.048 0,0019	0.065 0,0026	620 (520 – 720) 2025 (1800 – 2300)

For cutting data recalculations, see pages 556 - 563

SMG = Seco material group

Coolant = A=air D=dry E=emulsion M=mist spray

v_c = m/min (sf/min)

f_z = mm (in/tooth)

a_p = mm/DC (in/DC) = factor

a_e = mm/DC (in/DC) = factor

All cutting data are target values

Universal

Steel and cast iron

Stainless steel and S-materials

Non ferrous

Hard

Plastic and cfrp

Graphite

X-Heads

Minimaster Plus

Minimaster

JD640

Diamond – Graphite – Square – 4 Flutes – Cylindrical – Corner radius

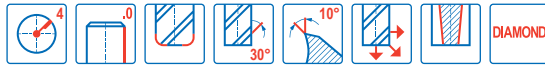
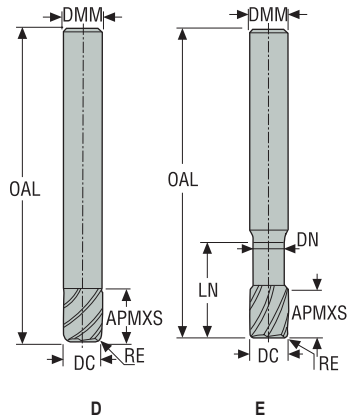

- Tolerances:
- Run-out= <0,01 mm
- DMM= h5
- DC= -0,02/-0,04 mm
- RE= ±0,05 mm

Designation	Item number	Length index	Tool shape	DC	DMM	APMXS	OAL	LN	DN	RE	PCEDC	Cylindrical
				mm	mm	mm	mm	mm	mm	mm		
640100R050-DIAMOND	00023474	2	D	10,0	10,0	25,0	75,0	-	-	0,5	4	■
640120R050-DIAMOND	00023475	2	D	12,0	12,0	25,0	80,0	-	-	0,5	4	■
640V060R050-DIAMOND	00023479	3	E	6,0	6,0	10,0	80,0	40,0	5,9	0,5	4	■
640V080R050-DIAMOND	00023480	3	E	8,0	8,0	10,0	80,0	40,0	7,8	0,5	4	■
640V100R050-DIAMOND	00023481	3	E	10,0	10,0	12,0	80,0	40,0	9,8	0,5	4	■
640V100R100-DIAMOND	00039781	3	E	10,0	10,0	12,0	80,0	40,0	9,8	1,0	4	■
640V120R050-DIAMOND	00023483	3	E	12,0	12,0	15,0	80,0	40,0	11,8	0,5	4	■
640V120R100-DIAMOND	00023484	3	E	12,0	12,0	15,0	80,0	40,0	11,8	1,0	4	■
640VL080R100-DIAMOND	00023485	4	E	8,0	8,0	10,0	100,0	60,0	7,8	1,0	4	■
640VL100R050-DIAMOND	00023486	4	E	10,0	10,0	12,0	125,0	80,0	9,8	0,5	4	■
640VL100R100-DIAMOND	02462696	4	E	10,0	10,0	12,0	125,0	80,0	9,7	1,0	4	■
640VL120R050-DIAMOND	02462698	4	E	12,0	12,0	15,0	125,0	80,0	11,7	0,5	4	■
640VL120R100-DIAMOND	00023487	4	E	12,0	12,0	15,0	125,0	80,0	11,8	1,0	4	■

■ Stocked standard.

Universal

Steel and cast iron

Stainless steel and S-materials

Non ferrous

Hard

Plastic and CFRP

Graphite

X-Heads

Minimaster Plus

Minimaster

Cutting data – JD640 Side milling

SMG		a_e/DC	a_p/DC	f_z				v_c
				6	8	10	12	
GR1	D	0.500 0,500	1.0 1,0	0.060 0,0024	0.080 0,0032	0.10 0,0040	0.12 0,0048	680 (570 – 780) 2225 (1900 – 2500)

Cutting data – JD640 Slot milling

SMG		a_p/DC	f_z				v_c
			6	8	10	12	
GR1	D	0.50 0,50	0.048 0,0019	0.065 0,0026	0.080 0,0032	0.095 0,0038	610 (520 – 710) 2000 (1800 – 2300)

For cutting data recalculations, see pages 556 - 563

SMG = Seco material group

Coolant = A=air D=dry E=emulsion M=mist spray

v_c = m/min (sf/min)

f_z = mm (in/tooth)

a_p = mm/DC (in/DC) = factor

a_e = mm/DC (in/DC) = factor

All cutting data are target values

Universal

Steel and cast iron

Stainless steel and S-materials

Non ferrous

Hard

Plastic and CFRP

Graphite

X-Heads

Minimaster Plus

Minimaster

JD660

Diamond – Graphite – Ball nose – 2 Flutes – Cylindrical

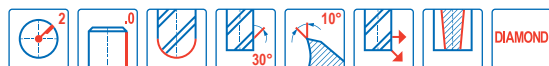
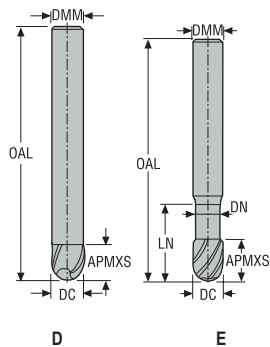

- Tolerances:
- Run-out=<0,01 mm
- DMM=h5
- DC= -0,02/-0,04 mm
- RE= ±0,01 mm
- B=0,9°

Designation	Item number	Length index	Tool shape	DC	DMM	APMXS	OAL	LN	DN	RE	PCEDC	Cylindrical
				mm	mm	mm	mm	mm	mm	mm		
660030-DIAMOND	00023488	1	D	3,0	3,0	8,0	40,0	–	–	1,5	2	■
660040-DIAMOND	00023489	1	D	4,0	4,0	14,0	50,0	–	–	2,0	2	■
660060-DIAMOND	00023491	1	D	6,0	6,0	20,0	65,0	–	–	3,0	2	■
660V030-DIAMOND	00023501	2	E	3,0	3,0	6,0	40,0	15,0	2,9	1,5	2	■
660V040-DIAMOND	00023502	2	E	4,0	4,0	6,0	40,0	15,0	3,9	2,0	2	■
660V060-DIAMOND	00023505	2	E	6,0	6,0	10,0	65,0	35,0	5,9	3,0	2	■
660L030-DIAMOND	00023494	3	D	3,0	3,0	20,0	60,0	–	–	1,5	2	■
660L040-DIAMOND	00023496	3	D	4,0	4,0	30,0	60,0	–	–	2,0	2	■
660L060-DIAMOND	00023498	3	D	6,0	6,0	40,0	100,0	–	–	3,0	2	■
660VL030-DIAMOND	00023511	4	E	3,0	3,0	6,0	60,0	30,0	2,9	1,5	2	■
660VL040-DIAMOND	00023512	4	E	4,0	4,0	6,0	60,0	30,0	3,9	2,0	2	■
660VL060-DIAMOND	00023516	4	E	6,0	6,0	10,0	100,0	70,0	5,8	3,0	2	■

■ Stocked standard.

Universal

Steel and cast iron

Stainless steel and S-materials

Non ferrous

Hard

Plastic and cfrp

Graphite

X-Heads

Minimaster Plus

Minimaster

Cutting data – JD660 Copy milling roughing

SMG		a _e /DC	a _p /DC	f _z			v _c
				3	4	6	
GR1	D	0.400 0,400	2.4 2,4	0.024 0,00095	0.032 0,0013	0.046 0,0018	920 (780 — 1000) 3025 (2600 — 3200)

For cutting data recalculations, see pages 556 - 563

SMG = Seco material group
Coolant = A=air D=dry E=emulsion M=mist spray
v_c = m/min (sf/min)
f_z = mm (in/tooth)
a_p = mm/DC (in/DC) = factor
a_e = mm/DC (in/DC) = factor
All cutting data are target values

- Universal
- Steel and cast iron
- Stainless steel and S-materials
- Non ferrous
- Hard
- Plastic and CFRP
- Graphite
- X-Heads
- Minimaster Plus
- Minimaster

SMB614/616

Miniature – Graphite – Ball nose – 2 Flutes – Cylindrical

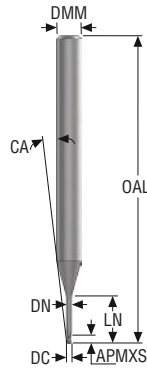

G

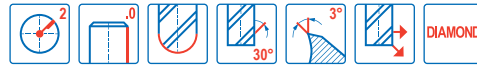

- Tolerances:
- Run-out= <0,005 mm
- DMM = h5
- DC Coated = -0,01/-0,025 mm
- DC Coated = 0/-0,015 mm
- RE = ±0,01 mm

Designation	Grade	Item number	Length index	Tool shape	DC	DMM	APMXS	OAL	DN	LN	CA°	PCEDC	Cylindrical
					mm	mm	mm	mm	mm	mm			
SMB614010G4B.0Z2	-	10108702	4	G	1,0	4	1,0	50	0,95	7,5	6,54 °	2	■
SMB614010G4B.0Z2	DIA	10108776	4	G	1,0	4	1,0	50	0,95	7,5	6,54 °	2	■
SMB614020G4B.0Z2	-	10108703	4	G	2,0	4	2,0	50	1,9	12,0	3,74 °	2	■
SMB614020G4B.0Z2	DIA	10108777	4	G	2,0	4	2,0	50	1,9	12,0	3,74 °	2	■
SMB616020G4B.0Z2	-	10108768	4	G	2,0	6	2,0	50	1,9	12,0	5,99 °	2	■
SMB614030G4B.0Z2	-	10108704	4	G	3,0	4	3,0	50	2,85	20,0	1,36 °	2	■
SMB614030G4B.0Z2	DIA	10108778	4	G	3,0	4	3,0	50	2,85	20,0	1,36 °	2	■
SMB616030G4B.0Z2	-	10108769	4	G	3,0	6	3,0	55	2,85	20,0	3,47 °	2	■
SMB614020G5B.0Z2	-	10108705	5	G	2,0	4	2,0	50	1,9	16,0	2,96 °	2	■
SMB614020G5B.0Z2	DIA	10108779	5	G	2,0	4	2,0	50	1,9	16,0	3,13 °	2	■
SMB616020G5B.0Z2	-	10108770	5	G	2,0	6	2,0	50	1,9	16,0	4,96 °	2	■
SMB614006G6B.0Z2	-	10108706	6	G	0,6	4	0,6	50	0,55	6,0	7,72 °	2	■
SMB614006G6B.0Z2	DIA	10108780	6	G	0,6	4	0,6	50	0,55	6,0	7,72 °	2	■
SMB616006G6B.0Z2	-	10108771	6	G	0,6	6	0,6	50	0,55	6,0	9,43 °	2	■
SMB614008G6B.0Z2	-	10108707	6	G	0,8	4	0,8	50	0,75	10,0	5,69 °	2	■
SMB614008G6B.0Z2	DIA	10108781	6	G	0,8	4	0,8	50	0,75	10,0	5,69 °	2	■
SMB614010G6B.0Z2	-	10108708	6	G	1,0	4	0,5	50	0,95	12,0	4,88 °	2	■
SMB614010G6B.0Z2	DIA	10108782	6	G	1,0	4	0,5	50	0,95	12,0	4,88 °	2	■
SMB616010G6B.0Z2	-	10108772	6	G	1,0	6	1,0	50	0,95	12,0	6,69 °	2	■
SMB614020G6B.0Z2	-	10108709	6	G	2,0	4	2,0	50	1,9	20,0	2,46 °	2	■
SMB614020G6B.0Z2	DIA	10108783	6	G	2,0	4	2,0	50	1,9	20,0	2,46 °	2	■
SMB616020G6B.0Z2	-	10108773	6	G	2,0	6	2,0	55	1,9	20,0	4,23 °	2	■
SMB614006G7B.0Z2	-	10108710	7	G	0,6	4	0,6	50	0,55	10,0	5,87 °	2	■
SMB614006G7B.0Z2	DIA	10108784	7	G	0,6	4	0,6	50	0,55	10,0	5,87 °	2	■
SMB616006G7B.0Z2	-	10108774	7	G	0,6	6	0,6	50	0,55	10,0	7,59 °	2	■
SMB614010G7B.0Z2	-	10108711	7	G	1,0	4	1,0	50	0,95	18,0	3,64 °	2	■
SMB614010G7B.0Z2	DIA	10108785	7	G	1,0	4	1,0	50	0,95	18,0	3,64 °	2	■
SMB616010G7B.0Z2	-	10108775	7	G	1,0	6	1,0	55	0,95	18,0	5,23 °	2	■

■ Stocked standard.

Universal

Steel and cast iron

Stainless steel and S-materials

Non ferrous

Hard

Plastic and CFRP

Graphite

X-Heads

Minimaster Plus

Minimaster

Cutting data – SMB614 Copy milling roughing

SMG		a _e /DC	a _p /DC	f _z					v _c
				0.6	0.8	1	2	3	
GR1	D	0,0700 0.0700	0,10 0.10	0,018 0.00070	0,024 0.00095	0,030 0.0012	0,060 0.0024	0,090 0.0036	95 (54 — 120) 310 (180 — 390)

For cutting data recalculations, see pages 556 - 563

SMG = Seco material group
Coolant = A=air D=dry E=emulsion M=mist spray
v_c = m/min (sf/min)
f_z = mm (in/tooth)
a_p = mm/DC (in/DC) = factor
a_e = mm/DC (in/DC) = factor
All cutting data are target values

Cutting data – SMB616 Copy milling roughing

SMG		a _e /DC	a _p /DC	f _z			v _c
				0.6	1	2	
GR1	D	0,0700 0.0700	0,10 0.10	0,018 0.00070	0,030 0.0012	0,060 0.0024	95 (54 — 120) 310 (180 — 390)

For cutting data recalculations, see pages 556 - 563

SMG = Seco material group
Coolant = A=air D=dry E=emulsion M=mist spray
v_c = m/min (sf/min)
f_z = mm (in/tooth)
a_p = mm/DC (in/DC) = factor
a_e = mm/DC (in/DC) = factor
All cutting data are target values

Universal

Steel and cast iron

Stainless steel and S-materials

Non ferrous

Hard

Plastic and CFRP

Graphite

X-Heads

Minimaster Plus

Minimaster

JME642

Miniature – Graphite – Square – Diamond – 2 Flutes – DMM 4 – Cylindrical – Corner radius

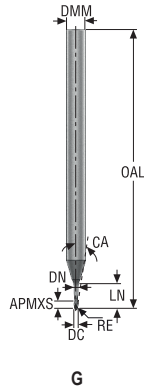

G

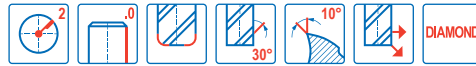

- Tolerances:
- Run-out= <0,005 mm
- DMM= h5
- DC= 0/-0,015 mm
- RE= ±0,007 mm

Designation	Item number	Length index	Tool shape	DC	DMM	APMXS	OAL	LN	DN	RE	CA°	PCEDC	Cylindrical
				mm	mm	mm	mm	mm	mm	mm	mm		
JME642002G1R002.0Z2-DIA	03215524	1	G	0,2	4,0	0,3	40,0	0,4	0,18	0,02	14,32	2	■
JME642003G1R002.0Z2-DIA	03215525	1	G	0,3	4,0	0,5	40,0	0,5	0,28	0,02	14,1	2	■
JME642004G1R004.0Z2-DIA	03215526	1	G	0,4	4,0	0,6	40,0	2,0	0,37	0,04	11,67	2	■
JME642005G3R005.0Z2-DIA	03215527	3	G	0,5	4,0	0,7	40,0	2,5	0,45	0,05	10,97	2	■
JME642006G3R006.0Z2-DIA	03215528	3	G	0,6	4,0	1,0	60,0	3,0	0,55	0,06	10,31	2	■
JME642008G3R008.0Z2-DIA	03215529	3	G	0,8	4,0	1,2	60,0	4,0	0,75	0,08	9,31	2	■
JME642010G3R010.0Z2-DIA	03215530	3	G	1,0	4,0	1,6	60,0	5,0	0,95	0,1	8,04	2	■
JME642012G3R012.0Z2-DIA	03215531	3	G	1,2	4,0	1,6	60,0	6,0	1,15	0,12	7,09	2	■
JME642015G3R015.0Z2-DIA	03215532	3	G	1,5	4,0	2,4	60,0	7,5	1,4	0,15	5,8	2	■
JME642020G3R015.0Z2-DIA	03236441	3	G	2,0	4,0	2,2	60,0	10,0	1,9	0,15	4,11	2	■
JME642020G3R020.0Z2-DIA	03215533	3	G	2,0	4,0	3,0	60,0	10,0	1,9	0,2	4,11	2	■
JME642005G5R005.0Z2-DIA	03215534	5	G	0,5	4,0	0,7	40,0	4,0	0,45	0,05	9,43	2	■
JME642006G5R006.0Z2-DIA	03215535	5	G	0,6	4,0	1,0	60,0	5,0	0,55	0,06	8,5	2	■
JME642008G5R008.0Z2-DIA	03215536	5	G	0,8	4,0	1,2	60,0	7,0	0,75	0,08	7,02	2	■
JME642010G5R010.0Z2-DIA	03215537	5	G	1,0	4,0	1,6	60,0	8,5	0,95	0,1	6,06	2	■
JME642012G5R012.0Z2-DIA	03215538	5	G	1,2	4,0	1,6	60,0	10,0	1,15	0,12	5,23	2	■
JME642015G5R015.0Z2-DIA	03215539	5	G	1,5	4,0	2,4	60,0	12,0	1,4	0,15	4,25	2	■
JME642020G5R015.0Z2-DIA	03236442	5	G	2,0	4,0	2,2	60,0	16,0	1,9	0,15	2,87	2	■
JME642020G5R020.0Z2-DIA	03215540	5	G	2,0	4,0	3,0	60,0	16,0	1,9	0,2	2,87	2	■
JME642010G6R010.0Z2-DIA	03215541	6	G	1,0	4,0	1,6	60,0	12,0	0,95	0,1	4,86	2	■
JME642015G6R015.0Z2-DIA	03215542	6	G	1,5	4,0	2,4	50,0	18,0	1,4	0,15	3,13	2	■
JME642020G6R020.0Z2-DIA	03215543	6	G	2,0	4,0	3,0	60,0	25,0	1,9	0,2	1,97	2	■
JME642020G7R020.0Z2-DIA	03215544	7	G	2,0	4,0	3,0	60,0	30,0	1,9	0,2	1,68	2	■

■ Stocked standard.

Universal

Steel and cast iron

Stainless steel and S-materials

Non ferrous

Hard

Plastic and CFRP

Graphite

X-Heads

Minimaster Plus

Minimaster

Cutting data – JME642 Side milling roughing

SMG		a _e /DC	a _p /DC	f _z										v _c
				0.2	0.3	0.4	0.5	0.6	0.8	1	1.2	1.5	2	
GR1	D	0.300	0.80	0.024	0.036	0.044	0.048	0.055	0.060	0.065	0.070	0.075	0.085	175 (130 – 370) 570 (430 – 1200)
		0,300	0,80	0,00095	0,0014	0,0017	0,0019	0,0022	0,0024	0,0026	0,0028	0,0030	0,0034	

Cutting data – JME642 Slot milling

SMG		a _p /DC	f _z										v _c
			0.2	0.3	0.4	0.5	0.6	0.8	1	1.2	1.5	2	
GR1	D	0.30	0.022	0.032	0.040	0.046	0.050	0.055	0.065	0.065	0.075	0.080	140 (110 – 300) 460 (370 – 980)
		0,30	0,00085	0,0013	0,0016	0,0018	0,0020	0,0022	0,0026	0,0026	0,0030	0,0032	

Table based on LV3, please recalc based on length version chosen. See page(s). 556 - 563

SMG = Seco material group

Coolant = A=air D=dry E=emulsion M=mist spray

v_c = m/min (sf/min)

f_z = mm (in/tooth)

a_p = mm/DC (in/DC) = factor

a_e = mm/DC (in/DC) = factor

All cutting data are target values

Universal
Steel and cast iron
Stainless steel and S-materials
Non ferrous
Hard
Plastic and cfrp
Graphite
X-Heads
Minimaster Plus
Minimaster

JMB642/JMB662

Miniature – Graphite – Ball nose – Diamond – 2 Flutes – DMM 4-6 – Cylindrical

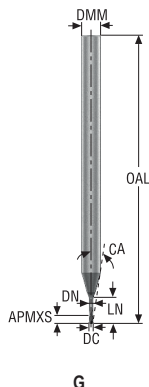

G

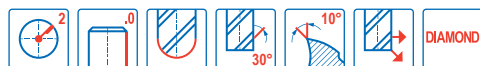

- Tolerances:
- Run-out= <0,005 mm
- DMM= h5
- DC= 0/-0,015 mm
- RE= ±0,007 mm

Designation	Item number	Length index	Tool shape	DC	DMM	APMXS	OAL	LN	DN	RE	CA°	PCEDC	Cylindrical
				mm	mm	mm	mm	mm	mm	mm	mm	mm	
JMB642002G1B.0Z2-DIA	03215373	1	G	0,2	4,0	0,3	40,0	0,4	0,18	0,1	14,5	2	■
JMB642003G1B.0Z2-DIA	03215374	1	G	0,3	4,0	0,5	40,0	0,6	0,28	0,15	14,17	2	■
JMB642004G1B.0Z2-DIA	03215375	1	G	0,4	4,0	2,0	40,0	0,8	0,37	0,2	13,8	2	■
JMB642005G3B.0Z2-DIA	03215376	3	G	0,5	4,0	0,7	40,0	2,5	0,45	0,25	11,19	2	■
JMB642006G3B.0Z2-DIA	03215377	3	G	0,6	4,0	1,0	60,0	3,0	0,55	0,3	10,55	2	■
JMB642008G3B.0Z2-DIA	03215378	3	G	0,8	4,0	1,2	60,0	4,0	0,75	0,4	9,38	2	■
JMB642010G3B.0Z2-DIA	03215379	3	G	1,0	4,0	1,6	60,0	5,0	0,95	0,5	8,33	2	■
JMB642012G3B.0Z2-DIA	03215380	3	G	1,2	4,0	1,6	60,0	6,0	1,15	0,6	7,38	2	■
JMB642015G3B.0Z2-DIA	03215381	3	G	1,5	4,0	2,4	60,0	7,5	1,4	0,75	6,08	2	■
JMB642020G3B.0Z2-DIA	03215382	3	G	2,0	4,0	3,0	60,0	10,0	1,9	1,0	4,35	2	■
JMB662030G3B.0Z2-DIA	03215384	3	G	3,0	6,0	3,0	60,0	15,0	2,8	1,5	4,38	2	■
JMB642005G5B.0Z2-DIA	03215387	5	G	0,5	4,0	0,7	40,0	4,0	0,45	0,25	9,6	2	■
JMB642006G5B.0Z2-DIA	03215388	5	G	0,6	4,0	1,0	60,0	5,0	0,55	0,3	8,68	2	■
JMB642008G5B.0Z2-DIA	03215389	5	G	0,8	4,0	1,2	60,0	7,0	0,75	0,4	7,18	2	■
JMB642010G5B.0Z2-DIA	03215390	5	G	1,0	4,0	1,6	60,0	8,5	0,95	0,5	6,22	2	■
JMB642012G5B.0Z2-DIA	03215391	5	G	1,2	4,0	1,6	60,0	10,0	1,15	0,6	5,4	2	■
JMB642015G5B.0Z2-DIA	03215392	5	G	1,5	4,0	2,4	60,0	12,0	1,4	0,75	4,4	2	■
JMB642020G5B.0Z2-DIA	03215393	5	G	2,0	4,0	3,0	60,0	16,0	1,9	1,0	2,99	2	■
JMB662030G5B.0Z2-DIA	03215395	5	G	3,0	6,0	3,0	60,0	24,0	2,8	1,5	3,0	2	■
JMB642010G6B.0Z2-DIA	03215396	6	G	1,0	4,0	1,6	60,0	12,0	0,95	0,5	4,96	2	■
JMB642015G6B.0Z2-DIA	03215397	6	G	1,5	4,0	2,4	60,0	18,0	1,4	0,75	3,21	2	■
JMB642020G6B.0Z2-DIA	03215398	6	G	2,0	4,0	3,0	60,0	25,0	1,9	1,0	2,03	2	■
JMB642020G7B.0Z2-DIA	03215399	7	G	2,0	4,0	3,0	60,0	30,0	1,9	1,0	1,72	2	■

■ Stocked standard.

Universal

Steel and cast iron

Stainless steel and S-materials

Non ferrous

Hard

Plastic and CFRP

Graphite

X-Heads

Minimaster Plus

Minimaster

Cutting data – JMB642/662 Side milling roughing

SMG		a _e /DC	a _p /DC	f _z										v _c
				0.2	0.3	0.4	0.5	0.6	0.8	1	1.2	1.5	2	
GR1	D	0.300 0,300	0.50 0,50	0.0024 0,000095	0.0036 0,00014	0.0048 0,00019	0.0060 0,00024	0.0070 0,00028	0.0095 0,00038	0.012 0,00048	0.014 0,00055	0.017 0,00065	0.020 0,00080	250 (200 – 300) 820 (660 – 980)

Cutting data – JMB642/662 Copy milling roughing

SMG		a _e /DC	a _p /DC	f _z										v _c
				0.2	0.3	0.4	0.5	0.6	0.8	1	1.2	1.5	2	
GR1	D	0.300 0,300	0.50 0,50	0.0024 0,000095	0.0036 0,00014	0.0048 0,00019	0.0060 0,00024	0.0070 0,00028	0.0095 0,00038	0.012 0,00048	0.014 0,00055	0.017 0,00065	0.020 0,00080	250 (200 – 300) 820 (660 – 980)

Table based on LV3, please recalc based on length version chosen. See page(s) N/A-N/A

SMG = Seco material group

Coolant = A=air D=dry E=emulsion M=mist spray

v_c = m/min (sf/min)

f_z = mm (in/tooth)

a_p = mm/DC (in/DC) = factor

a_e = mm/DC (in/DC) = factor

All cutting data are target values

Universal

Steel and cast iron

Stainless steel and S-materials

Non ferrous

Hard

Plastic and CFRP

Graphite

X-Heads

Minimaster Plus

Minimaster



SECO X-HEADS

The new Seco Tools Exchangeable Head range is a comprehensive offering to meet most customer demands. Utilizing our proven solid carbide geometries, we offer various types to machine most materials and complete various machining operations. The connection is a proven exchangeable head design to give high process security and reliability. The shanks offer many types for short reach up to long reach applications. Straight necking and tapered necks to give the best combination of stability depending on the needs for your machining operation.

- XSE550, XSE720, XSE450, XHF580, XHF780 XVE540 and XVE510 for chamfer or radius type.
- XSB540, XSB720 and XVB510 for ball-nose type.
- XVC506, XVC509 and XVC512 for conical type.
- XHT740 for barrel type.

Universal

Steel and cast iron

Stainless steel
and S-materials

Non ferrous

Hard

Plastic and cfrp

Graphite

X-Heads

Minimaster Plus

Minimaster

























Universal
 Steel and cast iron
 Stainless steel and S-materials
 Non ferrous
 Hard
 Plastic and cfrp
 Graphite
 X-Heads
 Minimaster Plus
 Minimaster

Tool selection X-Heads

Name		XSE550	XSB540	XSE720	XSB720	XSE450	XHT740
Page(s)		483-490	499	501-502	507	513-514	289
Family name		X-HEADS SOLID ²	X-HEADS SOLID ²	X-HEADS SOLID ²	X-HEADS SOLID ²	X-HEADS SOLID ²	X-HEADS HSM/TORNADO
Type of mill							
Number of Flutes		3,4,5	4	6	6	3	4,6
ICC			■				
Diameter range	Metric	10-20	10-16	10-25	10-20	10-20	10-16
	Inch	3/8-1		3/8-1	3/8-1	3/8-1	
Length availability		1,2	1	3	3	2	2,3
Operation							
SMG							
P1-8		●	●	○	○		○
P11-12		●	○	●	●		●
M1-3		●	●	●	●		●
M4-5		●	●	●	●		
K1-7		●	●	●	●		●
S1-3		●	○	●	●		○
S11-13		●	●	●	●		●
H3 H5 H7 H8 H11 H12 H21 H31		●	○				
N1		●	●			●	
N2-3		●	●			●	
N11		●	●			●	
TS1		●	●			●	
TP1		●	●			●	
GR		○	○				

■ Stocked standard.
 ● Preferred choice, ○ Alternative choice

Tool selection X-Heads

								
Name		XHF580	XHF780	XVE540	XVE510	XVB510	XVC506/509/512	XVK310
Page(s)		520	525	538	543	546-547	550	554
Family name		X-HEADS HFM	X-HEADS HFM	X-HEADS VHM	X-HEADS VHM	X-HEADS VHM	X-HEADS VHM	X-HEADS VHM
Type of mill								
Number of Flutes		4	3	3,4	2	2	2	4
ICC		■		■				
Diameter range	Metric	10-16	10-16	10-20	10-12	10-16	10-16	12-20
	Inch	3/8-5/8	3/8-5/8	3/8-3/4		3/8-5/8		
Length availability		1	1	1	1	1	1	1
Operation								
								
								
								
SMG								
P1-8		●	○	●	●	●	●	●
P11-12		●	○	●	●	●	●	●
M1-3		●	●	●	●	●	●	●
M4-5		●	●	●	●	●	●	●
K1-7		●	●	●	●	●	●	●
S1-3		○	●	○	○	○	○	○
S11-13		○	●	○	○	○	○	○
H3 H5 H7 H8 H11 H12 H21 H31		○	○	○				○
N1				●	○	○	○	●
N2-3				●	○	○	○	●
N11				●	○	○	○	●
TS1				●	●	●	●	●
TP1				●	●	●	●	●
GR				○	○	○	○	○

■ Stocked standard.

● Preferred choice, ○ Alternative choice

Universal
Steel and cast iron
Stainless steel and S-materials
Non ferrous
Hard
Plastic and cfrp
Graphite
X-Heads
Minimaster Plus
Minimaster

Steel - Metric

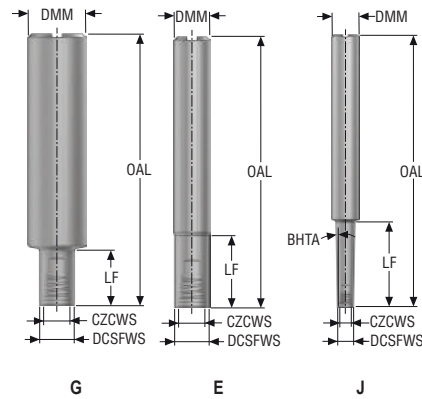





- Tolerances:
- DMM= h6
- DCSFWS= ±0,05 mm
- BHTA= ±20°

Designation	Item number	Length index	Tool shape	CZCWS	DCSFWS	DMM	LF	OAL	BHTA°	Cylindrical
XE10160G1-065-00.0S	10138083	1	G	E10	9,6	16,0	5,0	65,0	0,0	■
XE10100E2-055-00.0S	10138092	2	E	E10	9,6	10,0	10,0	55,0	0,0	■
XE10100E2-075-00.0S	10138093	2	E	E10	9,6	10,0	20,0	75,0	0,0	■
XE10160G2-075-00.0S	10138088	2	G	E10	9,6	16,0	15,0	75,0	0,0	■
XE10160J3-120-01.0S	10138099	3	J	E10	9,6	16,0	35,0	120,0	1,0	■
XE10160J5-160-01.0S	10138100	5	J	E10	9,6	16,0	50,0	160,0	1,0	■
XE10160J3-140-05.0S	10138106	3	J	E10	9,6	16,0	36,6	140,0	5,0	■
XE10200J5-140-05.0S	10138108	5	J	E10	9,6	20,0	59,4	140,0	5,0	■
XE10320J6-250-10.0S	10138113	6	J	E10	9,6	32,0	63,5	250,0	10,0	■
XE12160G1-065-00.0S	10138084	1	G	E12	11,6	16,0	5,0	65,0	0,0	■
XE12120E2-065-00.0S	10138094	2	E	E12	11,6	12,0	12,0	65,0	0,0	■
XE12120E2-100-00.0S	10138095	2	E	E12	11,6	12,0	22,0	100,0	0,0	■
XE12160G2-080-00.0S	10138089	2	G	E12	11,6	16,0	18,0	80,0	0,0	■
XE12160J3-155-01.0S	10138101	3	J	E12	11,6	16,0	42,0	155,0	1,0	■
XE12160J5-170-01.0S	10138102	5	J	E12	11,6	16,0	60,0	170,0	1,0	■
XE12160J2-140-05.0S	10138107	2	J	E12	11,6	16,0	25,1	140,0	5,0	■
XE12200J4-155-05.0S	10138109	4	J	E12	11,6	20,0	48,0	155,0	5,0	■
XE12320J4-250-10.0S	10138114	4	J	E12	11,6	32,0	57,8	250,0	10,0	■
XE16200G1-070-00.0S	10138085	1	G	E16	15,4	20,0	5,0	70,0	0,0	■
XE16160E2-070-00.0S	10138096	2	E	E16	15,4	16,0	16,0	70,0	0,0	■
XE16200G2-090-00.0S	10138090	2	G	E16	15,4	20,0	24,0	90,0	0,0	■
XE16200G2-110-00.0S	10138091	2	G	E16	15,4	20,0	25,0	110,0	0,0	■
XE16200J3-190-01.0S	10138103	3	J	E16	15,4	20,0	56,0	190,0	1,0	■
XE16200J4-190-01.0S	10138104	4	J	E16	15,4	20,0	75,0	190,0	1,0	■
XE16250J3-170-05.0S	10138110	3	J	E16	15,4	25,0	54,9	170,0	5,0	■
XE20250G1-080-00.0S	10138086	1	G	E20	19,2	25,0	5,0	80,0	0,0	■
XE20200E2-120-00.0S	10138097	2	E	E20	19,2	20,0	30,0	120,0	0,0	■
XE20250J4-200-01.0S	10138105	4	J	E20	19,2	25,0	80,0	200,0	1,0	■
XE20320J3-180-05.0S	10138111	3	J	E20	19,2	32,0	73,2	180,0	5,0	■
XE25320G1-080-00.0S	10138087	1	G	E25	24,1	32,0	5,0	80,0	0,0	■
XE25250E2-140-00.0S	10138098	2	E	E25	24,1	25,0	40,0	140,0	0,0	■
XE25320J2-200-05.0S	10138112	2	J	E25	24,1	32,0	45,1	200,0	5,0	■

Spare Parts, included in delivery

Accessories

CZCWS	Spanner	Replacement blade	Replacement blade 1	Torque key
				
E10	XW-E10	XTWH-E10.08	XTWH-E10.06	XTW-E10.E12
E12	XW-E12	XTWH-E12.10	XTWH-E12.08	XTW-E10.E12
E16	XW-E16	XTWH-E16.12	XTWH-E16.10	XTW-E16.E25
E20	XW-E20	XTWH-E20.16	-	XTW-E16.E25
E25	XW-E25	XTWH-E25.20	-	XTW-E16.E25

■ Stocked standard.

- Universal
- Steel and cast iron
- Stainless steel and S-materials
- Non ferrous
- Hard
- Plastic and cfrp
- Graphite
- X-Heads
- Minimaster Plus
- Minimaster

Steel - Inch

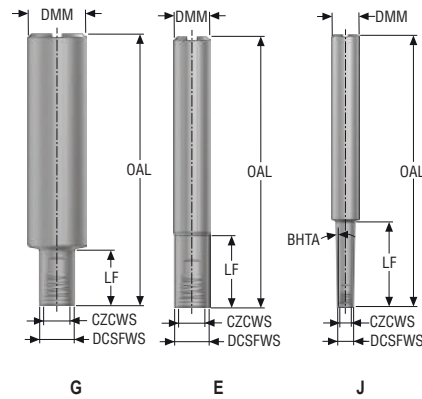





- Tolerances:
- DMM= h6
- DCSFWS= ±.002 inch
- BHTA= ±20'

Designation	Item number	Length index	Tool shape	CZCWS	DCSFWS	DMM	LF	OAL	BHTA°	Cylindrical
XE10.500G1-2.50-00.0S	10138050	1	G	E10	0.360	0.500	0.250	2.500	0,0	■
XE10.375E2-2.50-00.0S	10138053	2	E	E10	0.360	0.375	0.402	2.500	0,0	■
XE10.500G2-3.00-00.0S	10138051	2	G	E10	0.360	0.500	1.000	3.000	0,0	■
XE10.625J3-4.50-01.0S	10138063	3	J	E10	0.360	0.625	1.402	4.500	1,0	■
XE10.625J5-6.50-01.0S	10138064	5	J	E10	0.360	0.625	2.000	6.500	1,0	■
XE10.625J4-4.00-03.0S	10138071	4	J	E10	0.360	0.625	1.799	4.000	3,0	■
XE10.750J9-6.00-03.0S	10138072	9	J	E10	0.360	0.750	3.720	6.000	3,0	■
XE12.500E1-3.00-00.0S	10138054	1	E	E12	0.480	0.500	0.250	3.000	0,0	■
XE12.500E2-2.50-00.0S	10138055	2	E	E12	0.480	0.500	0.500	2.500	0,0	■
XE12.500E2-4.50-00.0S	10138056	2	E	E12	0.480	0.500	1.000	4.500	0,0	■
XE12.625J3-6.00-01.0S	10138065	3	J	E12	0.480	0.625	1.650	6.000	1,0	■
XE12.625J4-7.50-01.0S	10138066	4	J	E12	0.480	0.625	2.400	7.500	1,0	■
XE12.750J5-6.50-01.0S	10138067	5	J	E12	0.480	0.750	2.850	6.500	1,0	■
XE12.750J4-4.50-03.0S	10138073	4	J	E12	0.480	0.750	2.201	4.500	3,0	■
XE12.750J5-6.00-03.0S	10138074	5	J	E12	0.480	0.750	2.575	6.000	3,0	■
XE12.625J2-6.50-05.0S	10138075	2	J	E12	0.480	0.625	0.827	6.500	5,0	■
XE16.625E1-3.00-00.0S	10138057	1	E	E16	0.606	0.625	0.250	3.000	0,0	■
XE16.625E2-3.00-00.0S	10138058	2	E	E16	0.606	0.625	0.650	3.000	0,0	■
XE16.625E2-4.50-00.0S	10138059	2	E	E16	0.606	0.625	1.000	4.500	0,0	■
XE16.750J3-7.50-01.0S	10138068	3	J	E16	0.606	0.750	2.252	7.500	1,0	■
XE16.750J4-7.50-01.0S	10138070	4	J	E16	0.606	0.750	3.000	7.500	1,0	■
XE16.750J6-7.50-01.0S	10138069	6	J	E16	0.606	0.750	3.748	7.500	1,0	■
XE16.750J2-6.50-05.0S	10138076	2	J	E16	0.606	0.750	0.821	6.500	5,0	■
XE161.00J3-7.00-05.0S	10138077	3	J	E16	0.606	1.000	2.250	7.000	5,0	■
XE20.750E1-3.00-00.0S	10138060	1	E	E20	0.724	0.750	0.250	3.000	0,0	■
XE20.750E2-4.50-00.0S	10138061	2	E	E20	0.724	0.750	1.000	4.500	0,0	■
XE251.00E1-3.50-00.0S	10138062	1	E	E25	0.961	1.000	0.250	3.500	0,0	■
XE251.25G2-6.50-00.0S	10138052	2	G	E25	0.961	1.250	2.500	6.500	0,0	■

Spare Parts, included in delivery

Accessories

CZCWS	Spanner	Replacement blade	Replacement blade 1	Torque key
				
E10	XW-E10	XTWH-E10.08	XTWH-E10.06	XTW-E10.E12
E12	XW-E12	XTWH-E12.10	XTWH-E12.08	XTW-E10.E12
E16	XW-E16	XTWH-E16.12	XTWH-E16.10	XTW-E16.E25
E20	XW-E20	XTWH-E20.16	-	XTW-E16.E25
E25	XW-E25	XTWH-E25.20	-	XTW-E16.E25

■ Stocked standard.

- Universal
- Steel and cast iron
- Stainless steel and S-materials
- Non ferrous
- Hard
- Plastic and cfrp
- Graphite
- X-Heads
- Minimaster Plus
- Minimaster

Solid carbide - Metric

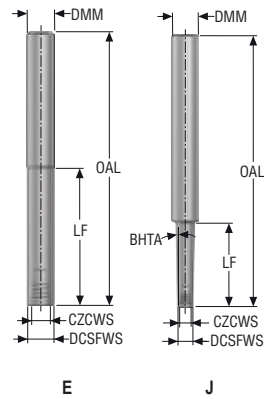

- Tolerances:
- DMM= h6
- DCSFWS= ±0,05 mm
- BHTA= ±20°

Designation	Item number	Length index	Tool shape	CZCWS	DCSFWS	DMM	LF	OAL	BHTA°	Cylindrical
					mm	mm	mm	mm		
XE10100E5-100-00.0E	10138120	5	E	E10	9,6	10,0	50,0	100,0	0,0	■
XE10160J9-155-01.0E	10138126	9	J	E10	9,6	16,0	100,0	155,0	1,0	■
XE12120E4-100-00.0E	10138121	4	E	E12	11,6	12,0	48,0	100,0	0,0	■
XE12160J7-150-01.0E	10138127	7	J	E12	11,6	16,0	90,0	150,0	1,0	■
XE16160E5-135-00.0E	10138122	5	E	E16	15,4	16,0	80,0	135,0	0,0	■
XE16200J7-175-01.0E	10138128	7	J	E16	15,4	20,0	118,0	175,0	1,0	■
XE20200E2-095-00.0E	10138123	2	E	E20	19,2	20,0	38,0	95,0	0,0	■
XE20200E5-180-00.0E	10138124	5	E	E20	19,2	20,0	110,0	180,0	0,0	■
XE20250J4-200-02.0E	10138129	4	J	E20	19,2	25,0	83,0	200,0	2,0	■
XE25250E4-200-00.0E	10138125	4	E	E25	24,1	25,0	120,0	200,0	0,0	■

Spare Parts, included in delivery

Accessories

CZCWS	Spanner	Replacement blade	Replacement blade 1	Torque key
E10	XW-E10	XTWH-E10.08	XTWH-E10.06	XTW-E10.E12
E12	XW-E12	XTWH-E12.10	XTWH-E12.08	XTW-E10.E12
E16	XW-E16	XTWH-E16.12	XTWH-E16.10	XTW-E16.E25
E20	XW-E20	XTWH-E20.16	–	XTW-E16.E25
E25	XW-E25	XTWH-E25.20	–	XTW-E16.E25

■ Stocked standard.

Universal

Steel and cast iron

Stainless steel and S-materials

Non ferrous

Hard

Plastic and CFRP

Graphite

X-Heads

Minimaster Plus

Minimaster

Solid carbide - inch

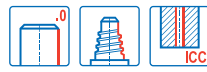
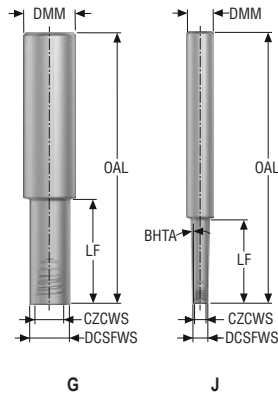

- Tolerances:
- DMM= h6
- DCSFWS= ±.002 inch
- BHTA= ±20'

Designation	Item number	Length index	Tool shape	CZCWS	DCSFWS	DMM	LF	OAL	BHTA°	Cylindrical
XE10.625J5-6.50-01.0E	10138079	5	J	E10	0.360	0.625	2.000	6.500	1,0	■
XE12.625J4-7.50-01.0E	10138080	4	J	E12	0.480	0.625	2.400	7.500	1,0	■
XE16.750J4-7.50-01.0E	10138081	4	J	E16	0.606	0.750	3.000	7.500	1,0	■
XE201.00J4-8.00-01.0E	10138082	4	J	E20	0.724	1.000	3.150	8.000	1,0	■
XE251.25G2-6.50-00.0E	10138078	2	G	E25	0.961	1.250	2.500	6.500	0,0	■

Spare Parts, included in delivery

Accessories

CZCWS	Spanner	Replacement blade	Replacement blade 1	Torque key
E10	XW-E10	XTWH-E10.08	XTWH-E10.06	XTW-E10.E12
E12	XW-E12	XTWH-E12.10	XTWH-E12.08	XTW-E10.E12
E16	XW-E16	XTWH-E16.12	XTWH-E16.10	XTW-E16.E25
E20	XW-E20	XTWH-E20.16	-	XTW-E16.E25
E25	XW-E25	XTWH-E25.20	-	XTW-E16.E25

■ Stocked standard.

Universal
Steel and cast iron
Stainless steel and S-materials
Non ferrous
Hard
Plastic and CFRP
Graphite
X-Heads
Minimaster Plus
Minimaster

Densimet - Metric

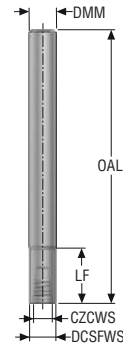

E



- Tolerances:
- DMM= h6
- DCSFWS= ±0,05 mm
- BHTA= ±20°

Designation	Item number	Length index	Tool shape	CZCWS	DCSFWS	DMM	LF	OAL	BHTA°	Cylindrical
XE10100E2-100-00.0DM	10138115	2	E	E10	9,6	10,0	20,0	100,0	0,0	■
XE12120E2-110-00.0DM	10138116	2	E	E12	11,6	12,0	25,0	110,0	0,0	■
XE16160E2-130-00.0DM	10138117	2	E	E16	15,4	16,0	35,0	130,0	0,0	■
XE20200E2-160-00.0DM	10138118	2	E	E20	19,2	20,0	45,0	160,0	0,0	■
XE25250E2-185-00.0DM	10138119	2	E	E25	24,1	25,0	65,0	185,0	0,0	■

Spare Parts, included in delivery

Accessories

	CZCWS	Spanner	Replacement blade	Replacement blade 1	Torque key
E10					
E12		XW-E10	XTWH-E10.08	XTWH-E10.06	XTW-E10.E12
E16		XW-E12	XTWH-E12.10	XTWH-E12.08	XTW-E10.E12
E20		XW-E16	XTWH-E16.12	XTWH-E16.10	XTW-E16.E25
E25		XW-E20	XTWH-E20.16	–	XTW-E16.E25
		XW-E25	XTWH-E25.20	–	XTW-E16.E25

■ Stocked standard.

XSE550

High performance – Universal – Square – 3 Flutes – Corner radius

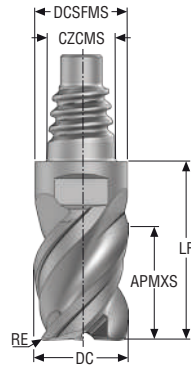

D

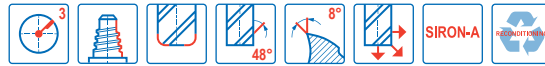

- Tolerances:
- DC= e7
- RE= ±0,02 mm
- Regrind possible if DC is ≥Ø12 mm

Designation	Item number	Length index	Tool shape	CZCMS	DC	DCSFMS	APMXS	LF	RE	PCEDC	SW	Grade
					mm	mm	mm	mm	mm			SIRA
XSE550E10100D1R050Z3	10138138	1	D	E10	10,0	9,7	5,5	12,3	0,5	3	8	■
XSE550E12120D1R050Z3	10138139	1	D	E12	12,0	11,7	6,6	14,4	0,5	3	10	■
XSE550E16160D1R050Z3	10138140	1	D	E16	16,0	15,5	8,8	18,6	0,5	3	12	■
XSE550E20200D1R050Z3	10138141	1	D	E20	20,0	19,3	11,0	21,2	0,5	3	16	■
XSE550E10100D2R050Z3	10138142	2	D	E10	10,0	9,7	12,0	18,7	0,5	3	8	■
XSE550E12120D2R050Z3	10138143	2	D	E12	12,0	11,7	14,4	22,1	0,5	3	10	■
XSE550E16160D2R050Z3	10138144	2	D	E16	16,0	15,5	19,2	29,2	0,5	3	12	■
XSE550E20200D2R050Z3	10138145	2	D	E20	20,0	19,3	24,0	34,3	0,5	3	16	■

■ Stocked standard.

Universal

Steel and cast iron

Stainless steel and S-materials

Non ferrous

Hard

Plastic and CFRP

Graphite

X-Heads

Minimaster Plus

Minimaster

XSE550 – Inch

High performance – Universal – Square – 3 Flutes – Corner radius – Inch

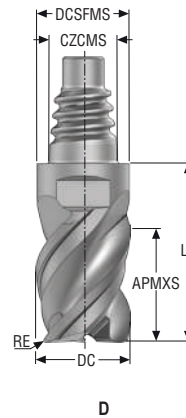

- Tolerances:
- DC= e7
- RE= ±0.008 Inch
- Regrind possible if DC is ≥Ø.500 Inch

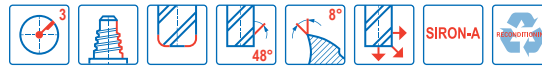

Designation	Item number	Length index	Tool shape	CZCMS	DC	DCSFMS	APMXS	LF	RE	PCEDC	SW	Grade
					Inch	Inch	Inch	Inch	Inch			
XSE550E10.375D1R030Z3	10138146	1	D	E10	0.375	0.364	0.206	0.484	0.030	3	8	■
XSE550E12.500D1R030Z3	10138147	1	D	E12	0.500	0.484	0.275	0.567	0.030	3	10	■
XSE550E20.750D1R030Z3	10138148	1	D	E20	0.750	0.728	0.413	0.835	0.030	3	16	■
XSE550E10.375D2R030Z3	10138149	2	D	E10	0.375	0.364	0.450	0.720	0.030	3	8	■
XSE550E12.500D2R030Z3	10138150	2	D	E12	0.500	0.484	0.600	0.906	0.030	3	10	■
XSE550E20.750D2R030Z3	10138151	2	D	E20	0.750	0.728	0.900	1.295	0.030	3	16	■

■ Stocked standard.

Universal
Steel and cast iron
Stainless steel and S-materials
Non ferrous
Hard
Plastic and CFRP
Graphite
X-Heads
Minimaster Plus
Minimaster

Cutting data – XSE550 – Side milling PCEDC 3

SMG		a _e /DC	a _p /DC	f _z				v _c
				10	12	16	20	
P1	E/M/A/D	0,40	1,1	0,095	0,12	0,14	0,16	185 (140 – 220)
		0,40	1,1	0,0038	0,0048	0,0055	0,0065	610 (460 – 720)
P2	E/M/A/D	0,40	1,1	0,10	0,12	0,15	0,17	175 (140 – 210)
		0,40	1,1	0,0040	0,0048	0,0060	0,0065	570 (460 – 680)
P3	E/M/A/D	0,40	1,1	0,095	0,11	0,14	0,16	155 (120 – 190)
		0,40	1,1	0,0038	0,0044	0,0055	0,0065	510 (400 – 620)
P4	E/M/A/D	0,40	1,1	0,090	0,11	0,14	0,16	135 (110 – 170)
		0,40	1,1	0,0036	0,0044	0,0055	0,0065	445 (370 – 550)
P5	E/M/A/D	0,40	1,1	0,090	0,11	0,13	0,15	130 (98 – 160)
		0,40	1,1	0,0036	0,0044	0,0050	0,0060	425 (330 – 520)
P6	E/M/A/D	0,40	1,1	0,090	0,11	0,13	0,15	145 (110 – 180)
		0,40	1,1	0,0036	0,0044	0,0050	0,0060	475 (370 – 590)
P7	E/M/A/D	0,40	1,1	0,090	0,11	0,13	0,15	140 (110 – 170)
		0,40	1,1	0,0036	0,0044	0,0050	0,0060	460 (370 – 550)
P8	E/M/A/D	0,40	1,1	0,095	0,11	0,14	0,16	130 (97 – 160)
		0,40	1,1	0,0038	0,0044	0,0055	0,0065	425 (320 – 520)
P11	E/M/A/D	0,30	1,1	0,065	0,075	0,095	0,11	95 (80 – 100)
		0,30	1,1	0,0026	0,0030	0,0038	0,0044	310 (270 – 320)
P12	E/M/A/D	0,30	1,1	0,044	0,055	0,065	0,075	60 (51 – 67)
		0,30	1,1	0,0017	0,0022	0,0026	0,0030	195 (170 – 210)
M1	E/M/A	0,30	1,1	0,070	0,085	0,11	0,12	105 (92 – 120)
		0,30	1,1	0,0028	0,0034	0,0044	0,0048	345 (310 – 390)
M2	E/M/A	0,30	1,1	0,065	0,075	0,095	0,11	90 (76 – 100)
		0,30	1,1	0,0026	0,0030	0,0038	0,0044	295 (250 – 320)
M3	E/M/A	0,30	0,95	0,055	0,065	0,080	0,090	55 (44 – 68)
		0,30	0,95	0,0022	0,0026	0,0032	0,0036	180 (150 – 220)
M4	E/M/A	0,30	0,95	0,048	0,055	0,070	0,080	43 (34 – 52)
		0,30	0,95	0,0019	0,0022	0,0028	0,0032	140 (120 – 170)
M5	E/M/A	0,30	0,95	0,048	0,055	0,070	0,080	36 (28 – 43)
		0,30	0,95	0,0019	0,0022	0,0028	0,0032	120 (92 – 140)
K1	E/M/A/D	0,40	1,1	0,090	0,11	0,14	0,16	160 (140 – 180)
		0,40	1,1	0,0036	0,0044	0,0055	0,0065	520 (460 – 590)
K2	E/M/A/D	0,40	1,1	0,085	0,10	0,12	0,14	140 (130 – 160)
		0,40	1,1	0,0034	0,0040	0,0048	0,0055	460 (430 – 520)
K3	E/M/A/D	0,40	1,1	0,085	0,10	0,12	0,14	120 (110 – 130)
		0,40	1,1	0,0034	0,0040	0,0048	0,0055	395 (370 – 420)
K4	E/M/A/D	0,40	1,1	0,085	0,10	0,12	0,14	115 (97 – 120)
		0,40	1,1	0,0034	0,0040	0,0048	0,0055	375 (320 – 390)
K5	E/M/A/D	0,40	0,95	0,080	0,095	0,12	0,14	140 (120 – 150)
		0,40	0,95	0,0032	0,0038	0,0048	0,0055	460 (400 – 490)
K6	E/M/A/D	0,40	0,95	0,090	0,11	0,13	0,15	200 (170 – 220)
		0,40	0,95	0,0036	0,0044	0,0050	0,0060	660 (560 – 720)
K7	E/M/A/D	0,40	0,95	0,080	0,095	0,12	0,14	180 (150 – 200)
		0,40	0,95	0,0032	0,0038	0,0048	0,0055	590 (500 – 650)
N1	E/M/A	0,40	0,95	0,080	0,095	0,12	0,14	600 (560 – 780)
		0,40	0,95	0,0032	0,0038	0,0048	0,0055	1975 (1900 – 2500)
N2	E/M/A	0,40	0,95	0,080	0,095	0,12	0,14	390 (360 – 500)
		0,40	0,95	0,0032	0,0038	0,0048	0,0055	1275 (1200 – 1600)
N3	E/M/A	0,40	0,95	0,080	0,095	0,12	0,14	260 (240 – 330)
		0,40	0,95	0,0032	0,0038	0,0048	0,0055	850 (790 – 1000)
N11	E/M/A	0,40	0,95	0,080	0,095	0,12	0,14	335 (280 – 380)
		0,40	0,95	0,0032	0,0038	0,0048	0,0055	1100 (920 – 1200)
S1	E	0,15	0,95	0,090	0,11	0,13	0,15	32 (26 – 40)
		0,15	0,95	0,0036	0,0044	0,0050	0,0060	105 (86 – 130)
S2	E	0,15	0,95	0,090	0,11	0,13	0,15	28 (21 – 34)
		0,15	0,95	0,0036	0,0044	0,0050	0,0060	90 (69 – 110)
S3	E	0,15	0,95	0,085	0,10	0,12	0,14	24 (19 – 30)
		0,15	0,95	0,0034	0,0040	0,0048	0,0055	80 (63 – 98)
S11	E	0,40	0,95	0,060	0,070	0,090	0,10	105 (77 – 130)
		0,40	0,95	0,0024	0,0028	0,0036	0,0040	345 (260 – 420)
S12	E	0,40	0,95	0,060	0,070	0,090	0,10	80 (59 – 100)
		0,40	0,95	0,0024	0,0028	0,0036	0,0040	260 (200 – 320)
S13	E	0,40	0,95	0,055	0,065	0,080	0,090	65 (47 – 83)
		0,40	0,95	0,0022	0,0026	0,0032	0,0036	215 (160 – 270)
H5	M/A	0,050	0,95	0,090	0,11	0,14	0,16	75 (62 – 92)
		0,050	0,95	0,0036	0,0044	0,0055	0,0065	245 (210 – 300)
H8	M/A	0,050	0,95	0,070	0,085	0,10	0,12	80 (64 – 95)
		0,050	0,95	0,0028	0,0034	0,0040	0,0048	260 (210 – 310)
H21	M/A	0,050	0,95	0,070	0,085	0,10	0,12	80 (64 – 95)
		0,050	0,95	0,0028	0,0034	0,0040	0,0048	260 (210 – 310)
H31	M/A	0,050	0,95	0,060	0,070	0,090	0,10	60 (50 – 74)
		0,050	0,95	0,0024	0,0028	0,0036	0,0040	195 (170 – 240)
TS1	A/D	0,40	0,95	0,080	0,095	0,12	0,14	280 (170 – 390)
		0,40	0,95	0,0032	0,0038	0,0048	0,0055	920 (560 – 1200)
TP1	A/D	0,40	0,95	0,080	0,095	0,12	0,14	280 (170 – 390)
		0,40	0,95	0,0032	0,0038	0,0048	0,0055	920 (560 – 1200)
GR1	A/D	0,40	0,95	0,080	0,095	0,12	0,14	550 (450 – 660)
		0,40	0,95	0,0032	0,0038	0,0048	0,0055	1800 (1500 – 2100)

Universal
Steel and cast iron
Stainless steel and S-materials
Non ferrous
Hard
Plastic and CFRP
Graphite
X-Heads
Minimaster Plus
Minimaster

Cutting data – XSE550 – Slot milling PCEDC 3

SMG		a _p /DC	f _z				v _c
			10	12	16	20	
P1	E/M/A/D	1,0	0,060	0,070	0,095	0,12	165 (130 – 200)
		1,0	0,0024	0,0028	0,0038	0,0048	540 (430 – 650)
P2	E/M/A/D	1,0	0,060	0,070	0,095	0,12	160 (120 – 190)
		1,0	0,0024	0,0028	0,0038	0,0048	520 (400 – 620)
P3	E/M/A/D	1,0	0,060	0,070	0,095	0,12	135 (110 – 170)
		1,0	0,0024	0,0028	0,0038	0,0048	445 (370 – 550)
P4	E/M/A/D	1,0	0,060	0,070	0,095	0,12	120 (90 – 140)
		1,0	0,0024	0,0028	0,0038	0,0048	395 (300 – 450)
P5	E/M/A/D	1,0	0,060	0,070	0,095	0,12	115 (86 – 140)
		1,0	0,0024	0,0028	0,0038	0,0048	375 (290 – 450)
P6	E/M/A/D	1,0	0,060	0,070	0,095	0,12	130 (97 – 160)
		1,0	0,0024	0,0028	0,0038	0,0048	425 (320 – 520)
P7	E/M/A/D	1,0	0,060	0,070	0,095	0,12	120 (92 – 150)
		1,0	0,0024	0,0028	0,0038	0,0048	395 (310 – 490)
P8	E/M/A/D	1,0	0,060	0,070	0,095	0,12	115 (86 – 140)
		1,0	0,0024	0,0028	0,0038	0,0048	375 (290 – 450)
P11	E/M/A/D	0,80	0,050	0,060	0,080	0,10	75 (64 – 84)
		0,80	0,0020	0,0024	0,0032	0,0040	245 (210 – 270)
P12	E/M/A/D	0,65	0,040	0,048	0,060	0,070	46 (40 – 52)
		0,65	0,0016	0,0019	0,0024	0,0028	150 (140 – 170)
M1	E/M/A	0,80	0,050	0,060	0,080	0,10	85 (75 – 99)
		0,80	0,0020	0,0024	0,0032	0,0040	280 (250 – 320)
M2	E/M/A	0,80	0,050	0,060	0,080	0,10	70 (60 – 79)
		0,80	0,0020	0,0024	0,0032	0,0040	230 (200 – 250)
M3	E/M/A	0,70	0,040	0,048	0,065	0,080	45 (35 – 54)
		0,70	0,0016	0,0019	0,0026	0,0032	150 (120 – 170)
M4	E/M/A	0,50	0,040	0,048	0,065	0,075	34 (27 – 41)
		0,50	0,0016	0,0019	0,0026	0,0030	110 (89 – 130)
M5	E/M/A	0,50	0,040	0,048	0,065	0,075	29 (23 – 34)
		0,50	0,0016	0,0019	0,0026	0,0030	95 (76 – 110)
K1	E/M/A/D	1,0	0,060	0,070	0,095	0,12	140 (120 – 160)
		1,0	0,0024	0,0028	0,0038	0,0048	460 (400 – 520)
K2	E/M/A/D	1,0	0,060	0,070	0,095	0,12	120 (110 – 130)
		1,0	0,0024	0,0028	0,0038	0,0048	395 (370 – 420)
K3	E/M/A/D	1,0	0,060	0,070	0,095	0,12	105 (88 – 110)
		1,0	0,0024	0,0028	0,0038	0,0048	345 (290 – 360)
K4	E/M/A/D	1,0	0,060	0,070	0,095	0,12	100 (84 – 110)
		1,0	0,0024	0,0028	0,0038	0,0048	330 (280 – 360)
K5	E/M/A/D	0,80	0,050	0,060	0,080	0,10	125 (100 – 130)
		0,80	0,0020	0,0024	0,0032	0,0040	410 (330 – 420)
K6	E/M/A/D	0,80	0,050	0,060	0,080	0,10	185 (150 – 200)
		0,80	0,0020	0,0024	0,0032	0,0040	610 (500 – 650)
K7	E/M/A/D	0,80	0,050	0,060	0,080	0,10	160 (130 – 170)
		0,80	0,0020	0,0024	0,0032	0,0040	520 (430 – 550)
N1	E/M/A	0,70	0,050	0,060	0,080	0,10	540 (500 – 690)
		0,70	0,0020	0,0024	0,0032	0,0040	1775 (1700 – 2200)
N2	E/M/A	0,70	0,050	0,060	0,080	0,10	345 (330 – 440)
		0,70	0,0020	0,0024	0,0032	0,0040	1125 (1100 – 1400)
N3	E/M/A	0,70	0,050	0,060	0,080	0,10	230 (220 – 290)
		0,70	0,0020	0,0024	0,0032	0,0040	750 (730 – 950)
N11	E/M/A	0,60	0,050	0,060	0,080	0,10	300 (250 – 340)
		0,60	0,0020	0,0024	0,0032	0,0040	980 (830 – 1100)
S1	E	0,30	0,030	0,036	0,048	0,060	27 (21 – 33)
		0,30	0,0012	0,0014	0,0019	0,0024	90 (69 – 100)
S2	E	0,30	0,030	0,036	0,048	0,060	23 (17 – 28)
		0,30	0,0012	0,0014	0,0019	0,0024	75 (56 – 91)
S3	E	0,30	0,030	0,036	0,048	0,060	20 (15 – 25)
		0,30	0,0012	0,0014	0,0019	0,0024	65 (50 – 82)
S11	E	0,50	0,050	0,060	0,080	0,10	90 (66 – 110)
		0,50	0,0020	0,0024	0,0032	0,0040	295 (220 – 360)
S12	E	0,50	0,050	0,060	0,080	0,10	70 (50 – 89)
		0,50	0,0020	0,0024	0,0032	0,0040	230 (170 – 290)
S13	E	0,42	0,050	0,060	0,075	0,090	55 (39 – 70)
		0,42	0,0020	0,0024	0,0030	0,0036	180 (130 – 220)
H5	M/A	0,30	0,030	0,036	0,048	0,060	50 (41 – 60)
		0,30	0,0012	0,0014	0,0019	0,0024	165 (140 – 190)
H8	M/A	0,26	0,030	0,036	0,046	0,050	50 (41 – 61)
		0,26	0,0012	0,0014	0,0018	0,0020	165 (140 – 200)
H21	M/A	0,26	0,030	0,036	0,046	0,050	50 (41 – 61)
		0,26	0,0012	0,0014	0,0018	0,0020	165 (140 – 200)
H31	M/A	0,26	0,026	0,032	0,040	0,046	40 (32 – 47)
		0,26	0,0010	0,0013	0,0016	0,0018	130 (110 – 150)
TS1	A/D	0,70	0,050	0,060	0,080	0,10	250 (150 – 340)
		0,70	0,0020	0,0024	0,0032	0,0040	820 (500 – 1100)
TP1	A/D	0,70	0,050	0,060	0,080	0,10	250 (150 – 340)
		0,70	0,0020	0,0024	0,0032	0,0040	820 (500 – 1100)
GR1	A/D	0,70	0,050	0,060	0,080	0,10	490 (410 – 600)
		0,70	0,0020	0,0024	0,0032	0,0040	1600 (1400 – 1900)

Cutting data – XSE550 – Side milling PCEDC 3 – inch

SMG		a _e /DC	a _p /DC	f _z				v _c
				3/8	1/2	5/8	3/4	
P1	E/M/A/D	0,40	1,1	0,095	0,12	0,14	0,16	215 (190 – 240)
		0,40	1,1	0,0038	0,0048	0,0055	0,0065	710 (630 – 780)
P2	E/M/A/D	0,40	1,1	0,10	0,12	0,15	0,17	205 (180 – 230)
		0,40	1,1	0,0040	0,0048	0,0060	0,0065	670 (600 – 750)
P3	E/M/A/D	0,40	1,1	0,095	0,11	0,14	0,16	180 (160 – 200)
		0,40	1,1	0,0038	0,0044	0,0055	0,0065	590 (530 – 650)
P4	E/M/A/D	0,40	1,1	0,090	0,11	0,14	0,16	160 (140 – 180)
		0,40	1,1	0,0036	0,0044	0,0055	0,0065	520 (460 – 590)
P5	E/M/A/D	0,40	1,1	0,090	0,11	0,13	0,15	150 (140 – 170)
		0,40	1,1	0,0036	0,0044	0,0050	0,0060	490 (460 – 550)
P6	E/M/A/D	0,40	1,1	0,090	0,11	0,13	0,15	170 (150 – 190)
		0,40	1,1	0,0036	0,0044	0,0050	0,0060	560 (500 – 620)
P7	E/M/A/D	0,40	1,1	0,090	0,11	0,13	0,15	160 (140 – 180)
		0,40	1,1	0,0036	0,0044	0,0050	0,0060	520 (460 – 590)
P8	E/M/A/D	0,40	1,1	0,095	0,11	0,14	0,16	150 (130 – 170)
		0,40	1,1	0,0038	0,0044	0,0055	0,0065	490 (430 – 550)
P11	E/M/A/D	0,30	1,1	0,065	0,075	0,095	0,11	105 (93 – 110)
		0,30	1,1	0,0026	0,0030	0,0038	0,0044	345 (310 – 360)
P12	E/M/A/D	0,30	1,1	0,044	0,055	0,065	0,075	65 (60 – 75)
		0,30	1,1	0,0017	0,0022	0,0026	0,0030	215 (200 – 240)
M1	E/M/A	0,30	1,1	0,070	0,085	0,11	0,12	120 (110 – 130)
		0,30	1,1	0,0028	0,0034	0,0044	0,0048	395 (370 – 420)
M2	E/M/A	0,30	1,1	0,065	0,075	0,095	0,11	100 (88 – 110)
		0,30	1,1	0,0026	0,0030	0,0038	0,0044	330 (290 – 360)
M3	E/M/A	0,30	0,95	0,055	0,065	0,080	0,090	60 (50 – 74)
		0,30	0,95	0,0022	0,0026	0,0032	0,0036	195 (170 – 240)
M4	E/M/A	0,30	0,95	0,048	0,055	0,070	0,080	48 (39 – 57)
		0,30	0,95	0,0019	0,0022	0,0028	0,0032	155 (130 – 180)
M5	E/M/A	0,30	0,95	0,048	0,055	0,070	0,080	40 (32 – 47)
		0,30	0,95	0,0019	0,0022	0,0028	0,0032	130 (110 – 150)
K1	E/M/A/D	0,40	1,1	0,090	0,11	0,14	0,16	170 (160 – 200)
		0,40	1,1	0,0036	0,0044	0,0055	0,0065	560 (530 – 650)
K2	E/M/A/D	0,40	1,1	0,085	0,10	0,12	0,14	150 (150 – 180)
		0,40	1,1	0,0034	0,0040	0,0048	0,0055	490 (500 – 590)
K3	E/M/A/D	0,40	1,1	0,085	0,10	0,12	0,14	125 (120 – 150)
		0,40	1,1	0,0034	0,0040	0,0048	0,0055	410 (400 – 490)
K4	E/M/A/D	0,40	1,1	0,085	0,10	0,12	0,14	120 (120 – 140)
		0,40	1,1	0,0034	0,0040	0,0048	0,0055	395 (400 – 450)
K5	E/M/A/D	0,40	0,95	0,080	0,095	0,12	0,14	155 (140 – 170)
		0,40	0,95	0,0032	0,0038	0,0048	0,0055	510 (460 – 550)
K6	E/M/A/D	0,40	0,95	0,090	0,11	0,13	0,15	225 (200 – 250)
		0,40	0,95	0,0036	0,0044	0,0050	0,0060	740 (660 – 820)
K7	E/M/A/D	0,40	0,95	0,080	0,095	0,12	0,14	200 (180 – 220)
		0,40	0,95	0,0032	0,0038	0,0048	0,0055	660 (600 – 720)
N1	E/M/A	0,40	0,95	0,080	0,095	0,12	0,14	670 (560 – 780)
		0,40	0,95	0,0032	0,0038	0,0048	0,0055	2200 (1900 – 2500)
N2	E/M/A	0,40	0,95	0,080	0,095	0,12	0,14	430 (360 – 500)
		0,40	0,95	0,0032	0,0038	0,0048	0,0055	1400 (1200 – 1600)
N3	E/M/A	0,40	0,95	0,080	0,095	0,12	0,14	285 (240 – 330)
		0,40	0,95	0,0032	0,0038	0,0048	0,0055	940 (790 – 1000)
N11	E/M/A	0,40	0,95	0,080	0,095	0,12	0,14	335 (280 – 380)
		0,40	0,95	0,0032	0,0038	0,0048	0,0055	1100 (920 – 1200)
S1	E	0,15	0,95	0,090	0,11	0,13	0,15	43 (26 – 60)
		0,15	0,95	0,0036	0,0044	0,0050	0,0060	140 (86 – 190)
S2	E	0,15	0,95	0,090	0,11	0,13	0,15	35 (21 – 48)
		0,15	0,95	0,0036	0,0044	0,0050	0,0060	115 (69 – 150)
S3	E	0,15	0,95	0,085	0,10	0,12	0,14	30 (19 – 42)
		0,15	0,95	0,0034	0,0040	0,0048	0,0055	100 (63 – 130)
S11	E	0,40	0,95	0,060	0,070	0,090	0,10	105 (77 – 130)
		0,40	0,95	0,0024	0,0028	0,0036	0,0040	345 (260 – 420)
S12	E	0,40	0,95	0,060	0,070	0,090	0,10	80 (59 – 100)
		0,40	0,95	0,0024	0,0028	0,0036	0,0040	260 (200 – 320)
S13	E	0,40	0,95	0,055	0,065	0,080	0,090	65 (47 – 83)
		0,40	0,95	0,0022	0,0026	0,0032	0,0036	215 (160 – 270)
H5	M/A	0,050	0,95	0,090	0,11	0,14	0,16	75 (62 – 92)
		0,050	0,95	0,0036	0,0044	0,0055	0,0065	245 (210 – 300)
H8	M/A	0,050	0,95	0,070	0,085	0,10	0,12	80 (64 – 95)
		0,050	0,95	0,0028	0,0034	0,0040	0,0048	260 (210 – 310)
H21	M/A	0,050	0,95	0,070	0,085	0,10	0,12	80 (64 – 95)
		0,050	0,95	0,0028	0,0034	0,0040	0,0048	260 (210 – 310)
H31	M/A	0,050	0,95	0,060	0,070	0,090	0,10	60 (50 – 74)
		0,050	0,95	0,0024	0,0028	0,0036	0,0040	195 (170 – 240)
TS1	A/D	0,40	0,95	0,080	0,095	0,12	0,14	280 (170 – 390)
		0,40	0,95	0,0032	0,0038	0,0048	0,0055	920 (560 – 1200)
TP1	A/D	0,40	0,95	0,080	0,095	0,12	0,14	280 (170 – 390)
		0,40	0,95	0,0032	0,0038	0,0048	0,0055	920 (560 – 1200)
GR1	A/D	0,40	0,95	0,080	0,095	0,12	0,14	670 (560 – 780)
		0,40	0,95	0,0032	0,0038	0,0048	0,0055	2200 (1900 – 2500)

Universal
Steel and cast iron
Stainless steel and S-materials
Non ferrous
Hard
Plastic and CFRP
Graphite
X-Heads
Minimaster Plus
Minimaster

Cutting data – XSE550 – Slot milling PCEDC 3 inch

SMG		a _p /DC	f _z				v _c
			3/8	1/2	5/8	3/4	
P1	E/M/A/D	1,0	0,060	0,070	0,095	0,12	190 (170 – 210)
		1,0	0,0024	0,0028	0,0038	0,0048	620 (560 – 680)
P2	E/M/A/D	1,0	0,060	0,070	0,095	0,12	185 (160 – 210)
		1,0	0,0024	0,0028	0,0038	0,0048	610 (530 – 680)
P3	E/M/A/D	1,0	0,060	0,070	0,095	0,12	160 (140 – 180)
		1,0	0,0024	0,0028	0,0038	0,0048	520 (460 – 590)
P4	E/M/A/D	1,0	0,060	0,070	0,095	0,12	140 (120 – 150)
		1,0	0,0024	0,0028	0,0038	0,0048	460 (400 – 490)
P5	E/M/A/D	1,0	0,060	0,070	0,095	0,12	135 (120 – 150)
		1,0	0,0024	0,0028	0,0038	0,0048	445 (400 – 490)
P6	E/M/A/D	1,0	0,060	0,070	0,095	0,12	150 (130 – 170)
		1,0	0,0024	0,0028	0,0038	0,0048	490 (430 – 550)
P7	E/M/A/D	1,0	0,060	0,070	0,095	0,12	140 (130 – 160)
		1,0	0,0024	0,0028	0,0038	0,0048	460 (430 – 520)
P8	E/M/A/D	1,0	0,060	0,070	0,095	0,12	135 (120 – 150)
		1,0	0,0024	0,0028	0,0038	0,0048	445 (400 – 490)
P11	E/M/A/D	0,80	0,050	0,060	0,080	0,10	85 (74 – 94)
		0,80	0,0020	0,0024	0,0032	0,0040	280 (250 – 300)
P12	E/M/A/D	0,80	0,040	0,048	0,060	0,070	50 (46 – 58)
		0,80	0,0016	0,0019	0,0024	0,0028	165 (160 – 190)
M1	E/M/A	0,80	0,050	0,060	0,080	0,10	100 (87 – 110)
		0,80	0,0020	0,0024	0,0032	0,0040	330 (290 – 360)
M2	E/M/A	0,80	0,050	0,060	0,080	0,10	80 (70 – 89)
		0,80	0,0020	0,0024	0,0032	0,0040	260 (230 – 290)
M3	E/M/A	0,70	0,040	0,048	0,065	0,080	50 (41 – 60)
		0,70	0,0016	0,0019	0,0026	0,0032	165 (140 – 190)
M4	E/M/A	0,70	0,040	0,048	0,065	0,075	37 (30 – 45)
		0,70	0,0016	0,0019	0,0026	0,0030	120 (99 – 140)
M5	E/M/A	0,70	0,040	0,048	0,065	0,075	31 (25 – 37)
		0,70	0,0016	0,0019	0,0026	0,0030	100 (83 – 120)
K1	E/M/A/D	1,0	0,060	0,070	0,095	0,12	150 (140 – 180)
		1,0	0,0024	0,0028	0,0038	0,0048	490 (460 – 590)
K2	E/M/A/D	1,0	0,060	0,070	0,095	0,12	130 (130 – 150)
		1,0	0,0024	0,0028	0,0038	0,0048	425 (430 – 490)
K3	E/M/A/D	1,0	0,060	0,070	0,095	0,12	110 (110 – 130)
		1,0	0,0024	0,0028	0,0038	0,0048	360 (370 – 420)
K4	E/M/A/D	1,0	0,060	0,070	0,095	0,12	105 (99 – 120)
		1,0	0,0024	0,0028	0,0038	0,0048	345 (330 – 390)
K5	E/M/A/D	0,80	0,050	0,060	0,080	0,10	140 (120 – 150)
		0,80	0,0020	0,0024	0,0032	0,0040	460 (400 – 490)
K6	E/M/A/D	0,80	0,050	0,060	0,080	0,10	205 (180 – 230)
		0,80	0,0020	0,0024	0,0032	0,0040	670 (600 – 750)
K7	E/M/A/D	0,80	0,050	0,060	0,080	0,10	180 (160 – 200)
		0,80	0,0020	0,0024	0,0032	0,0040	590 (530 – 650)
N1	E/M/A	0,70	0,050	0,060	0,080	0,10	600 (510 – 690)
		0,70	0,0020	0,0024	0,0032	0,0040	1975 (1700 – 2200)
N2	E/M/A	0,70	0,050	0,060	0,080	0,10	385 (330 – 440)
		0,70	0,0020	0,0024	0,0032	0,0040	1275 (1100 – 1400)
N3	E/M/A	0,70	0,050	0,060	0,080	0,10	255 (220 – 290)
		0,70	0,0020	0,0024	0,0032	0,0040	840 (730 – 950)
N11	E/M/A	0,60	0,050	0,060	0,080	0,10	300 (250 – 340)
		0,60	0,0020	0,0024	0,0032	0,0040	980 (830 – 1100)
S1	E	0,30	0,030	0,036	0,048	0,060	36 (22 – 50)
		0,30	0,0012	0,0014	0,0019	0,0024	120 (73 – 160)
S2	E	0,30	0,030	0,036	0,048	0,060	29 (18 – 40)
		0,30	0,0012	0,0014	0,0019	0,0024	95 (60 – 130)
S3	E	0,30	0,030	0,036	0,048	0,060	25 (15 – 34)
		0,30	0,0012	0,0014	0,0019	0,0024	80 (50 – 110)
S11	E	0,50	0,050	0,060	0,080	0,10	90 (66 – 110)
		0,50	0,0020	0,0024	0,0032	0,0040	295 (220 – 360)
S12	E	0,50	0,050	0,060	0,080	0,10	70 (50 – 89)
		0,50	0,0020	0,0024	0,0032	0,0040	230 (170 – 290)
S13	E	0,50	0,050	0,060	0,075	0,090	55 (39 – 69)
		0,50	0,0020	0,0024	0,0030	0,0036	180 (130 – 220)
H5	M/A	0,30	0,030	0,036	0,048	0,060	50 (41 – 60)
		0,30	0,0012	0,0014	0,0019	0,0024	165 (140 – 190)
H8	M/A	0,30	0,030	0,036	0,044	0,050	50 (41 – 60)
		0,30	0,0012	0,0014	0,0017	0,0020	165 (140 – 190)
H21	M/A	0,30	0,030	0,036	0,044	0,050	50 (41 – 60)
		0,30	0,0012	0,0014	0,0017	0,0020	165 (140 – 190)
H31	M/A	0,30	0,026	0,032	0,038	0,044	39 (32 – 46)
		0,30	0,0010	0,0013	0,0015	0,0017	130 (110 – 150)
TS1	A/D	0,70	0,050	0,060	0,080	0,10	250 (150 – 340)
		0,70	0,0020	0,0024	0,0032	0,0040	820 (500 – 1100)
TP1	A/D	0,70	0,050	0,060	0,080	0,10	250 (150 – 340)
		0,70	0,0020	0,0024	0,0032	0,0040	820 (500 – 1100)
GR1	A/D	0,70	0,050	0,060	0,080	0,10	600 (510 – 690)
		0,70	0,0020	0,0024	0,0032	0,0040	1975 (1700 – 2200)

XSE550

High performance – Universal – Square – 4 Flutes – Corner radius or chamfer

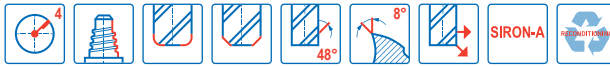
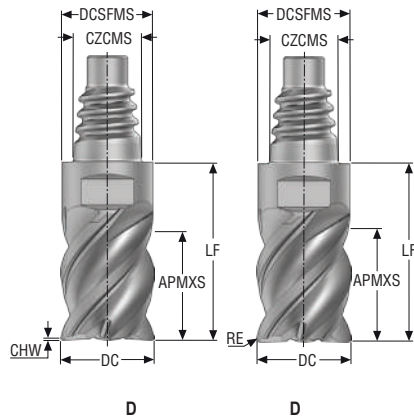

- Tolerances:
- DC= e7
- RE= ±0,02 mm
- Regrind possible if DC is ≥Ø12 mm

Designation	Item number	Length index	Tool shape	CZCMS	DC	DCSFMS	APMXS	LF	CHW	RE	PCEDC	SW	Grade
					mm	mm	mm	mm	mm	mm			SIRA
XSE550E10100D2CZ4	10138152	2	D	E10	10,0	9,7	12,0	18,7	0,125	-	4	8	■
XSE550E12120D2CZ4	10138153	2	D	E12	12,0	11,7	14,4	22,1	0,15	-	4	10	■
XSE550E16160D2CZ4	10138154	2	D	E16	16,0	15,5	19,2	29,2	0,2	-	4	12	■
XSE550E20200D2CZ4	10138155	2	D	E20	20,0	19,3	24,0	34,3	0,25	-	4	16	■
XSE550E10100D1R050Z4	10138156	1	D	E10	10,0	9,7	5,5	12,3	-	0,5	4	8	■
XSE550E12120D1R050Z4	10138157	1	D	E12	12,0	11,7	6,6	14,4	-	0,5	4	10	■
XSE550E16160D1R050Z4	10138158	1	D	E16	16,0	15,5	8,8	18,6	-	0,5	4	12	■
XSE550E20200D1R100Z4	10138159	1	D	E20	20,0	19,3	11,0	21,2	-	1,0	4	16	■
XSE550E10100D2R100Z4	10138161	2	D	E10	10,0	9,7	12,0	18,7	-	1,0	4	8	■
XSE550E12120D2R100Z4	10138165	2	D	E12	12,0	11,7	14,4	22,1	-	1,0	4	10	■
XSE550E16160D2R100Z4	10138169	2	D	E16	16,0	15,5	19,2	29,2	-	1,0	4	12	■
XSE550E20200D2R100Z4	10138172	2	D	E20	20,0	19,3	24,0	34,3	-	1,0	4	16	■
XSE550E10100D2R050Z4	10138160	2	D	E10	10,0	9,7	12,0	18,7	-	0,5	4	8	■
XSE550E10100D2R200Z4	10138162	2	D	E10	10,0	9,7	12,0	18,7	-	2,0	4	8	■
XSE550E10100D2R250Z4	10138163	2	D	E10	10,0	9,7	12,0	18,7	-	2,5	4	8	■
XSE550E12120D2R050Z4	10138164	2	D	E12	12,0	11,7	14,4	22,1	-	0,5	4	10	■
XSE550E12120D2R200Z4	10138166	2	D	E12	12,0	11,7	14,4	22,1	-	2,0	4	10	■
XSE550E12120D2R300Z4	10138167	2	D	E12	12,0	11,7	14,4	22,1	-	3,0	4	10	■
XSE550E16160D2R050Z4	10138168	2	D	E16	16,0	15,5	19,2	29,2	-	0,5	4	12	■
XSE550E16160D2R200Z4	10138170	2	D	E16	16,0	15,5	19,2	29,2	-	2,0	4	12	■
XSE550E16160D2R300Z4	10138171	2	D	E16	16,0	15,5	19,2	29,2	-	3,0	4	12	■
XSE550E20200D2R200Z4	10138173	2	D	E20	20,0	19,3	24,0	34,3	-	2,0	4	16	■
XSE550E20200D2R300Z4	10138174	2	D	E20	20,0	19,3	24,0	34,3	-	3,0	4	16	■
XSE550E20200D2R400Z4	10138175	2	D	E20	20,0	19,3	24,0	34,3	-	4,0	4	16	■

■ Stocked standard.

Universal

Steel and cast iron

Stainless steel and S-materials

Non ferrous

Hard

Plastic and CFRP

Graphite

X-Heads

Minimaster Plus

Minimaster

XSE550 – Inch

High performance – Universal – Square – 4 Flutes – Corner radius – Inch

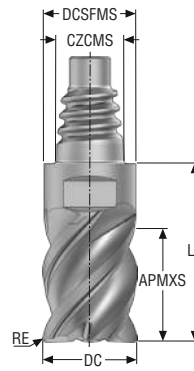

D

- Tolerances:
- DC= e7
- RE= ±0.008 Inch
- Regrind possible if DC is ≥Ø.500 Inch

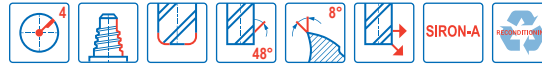

Designation	Item number	Length index	Tool shape	CZCMS	DC	DCSFMS	APMXS	LF	RE	PCEDC	SW	Grade
					<i>Inch</i>	<i>Inch</i>	<i>Inch</i>	<i>Inch</i>	<i>Inch</i>			SIRA
XSE550E10.375D1R030Z4	10138176	1	D	E10	0.375	0.364	0.206	0.484	0.030	4	8	■
XSE550E12.500D1R030Z4	10138177	1	D	E12	0.500	0.484	0.275	0.567	0.030	4	10	■
XSE550E20.750D1R030Z4	10138178	1	D	E20	0.750	0.728	0.413	0.835	0.030	4	16	■
XSE550E10.375D2R030Z4	10138179	2	D	E10	0.375	0.364	0.450	0.720	0.030	4	8	■
XSE550E12.500D2R030Z4	10138180	2	D	E12	0.500	0.484	0.600	0.906	0.030	4	10	■
XSE550E20.750D2R030Z4	10138181	2	D	E20	0.750	0.728	0.900	1.295	0.030	4	16	■

■ Stocked standard.

Universal

Steel and cast iron

Stainless steel and S-materials

Non ferrous

Hard

Plastic and CFRP

Graphite

X-Heads

Minimaster Plus

Minimaster

Cutting data – XSE550 – Side milling PCEDC 4

SMG		a _e /DC	a _p /DC	f _z				v _c
				10	12	16	20	
P1	E/M/A/D	0,40	0,95	0,085	0,10	0,13	0,15	170 (130 – 210)
		0,40	0,95	0,0034	0,0040	0,0050	0,0060	560 (430 – 680)
P2	E/M/A/D	0,40	0,95	0,090	0,10	0,13	0,15	165 (130 – 200)
		0,40	0,95	0,0036	0,0040	0,0050	0,0060	540 (430 – 650)
P3	E/M/A/D	0,40	0,95	0,085	0,10	0,12	0,14	145 (110 – 180)
		0,40	0,95	0,0034	0,0040	0,0048	0,0055	475 (370 – 590)
P4	E/M/A/D	0,40	0,95	0,080	0,095	0,12	0,14	130 (97 – 160)
		0,40	0,95	0,0032	0,0038	0,0048	0,0055	425 (320 – 520)
P5	E/M/A/D	0,40	0,95	0,080	0,095	0,12	0,14	125 (93 – 150)
		0,40	0,95	0,0032	0,0038	0,0048	0,0055	410 (310 – 490)
P6	E/M/A/D	0,40	0,95	0,080	0,095	0,12	0,13	140 (110 – 170)
		0,40	0,95	0,0032	0,0038	0,0048	0,0050	460 (370 – 550)
P7	E/M/A/D	0,40	0,95	0,080	0,095	0,12	0,13	130 (98 – 160)
		0,40	0,95	0,0032	0,0038	0,0048	0,0050	425 (330 – 520)
P8	E/M/A/D	0,40	0,95	0,085	0,10	0,12	0,14	120 (91 – 150)
		0,40	0,95	0,0034	0,0040	0,0048	0,0055	395 (300 – 490)
P11	E/M/A/D	0,30	0,95	0,065	0,075	0,095	0,11	85 (72 – 100)
		0,30	0,95	0,0026	0,0030	0,0038	0,0044	280 (240 – 320)
P12	E/M/A/D	0,30	0,95	0,044	0,055	0,065	0,075	55 (46 – 68)
		0,30	0,95	0,0017	0,0022	0,0026	0,0030	180 (160 – 220)
M1	E/M/A	0,30	0,95	0,070	0,085	0,11	0,12	95 (83 – 120)
		0,30	0,95	0,0028	0,0034	0,0044	0,0048	310 (280 – 390)
M2	E/M/A	0,30	0,95	0,065	0,075	0,095	0,11	80 (69 – 100)
		0,30	0,95	0,0026	0,0030	0,0038	0,0044	260 (230 – 320)
M3	E/M/A	0,30	0,95	0,055	0,065	0,080	0,090	47 (36 – 58)
		0,30	0,95	0,0022	0,0026	0,0032	0,0036	155 (120 – 190)
M4	E/M/A	0,30	0,95	0,048	0,055	0,070	0,080	36 (28 – 45)
		0,30	0,95	0,0019	0,0022	0,0028	0,0032	120 (92 – 140)
M5	E/M/A	0,30	0,95	0,048	0,055	0,070	0,080	30 (23 – 37)
		0,30	0,95	0,0019	0,0022	0,0028	0,0032	100 (76 – 120)
K1	E/M/A/D	0,40	0,95	0,080	0,095	0,12	0,14	150 (130 – 170)
		0,40	0,95	0,0032	0,0038	0,0048	0,0055	490 (430 – 550)
K2	E/M/A/D	0,40	0,95	0,075	0,090	0,11	0,13	130 (120 – 150)
		0,40	0,95	0,0030	0,0036	0,0044	0,0050	425 (400 – 490)
K3	E/M/A/D	0,40	0,95	0,075	0,090	0,11	0,13	110 (96 – 120)
		0,40	0,95	0,0030	0,0036	0,0044	0,0050	360 (320 – 390)
K4	E/M/A/D	0,40	0,95	0,075	0,090	0,11	0,13	105 (92 – 120)
		0,40	0,95	0,0030	0,0036	0,0044	0,0050	345 (310 – 390)
K5	E/M/A/D	0,40	0,95	0,080	0,095	0,12	0,14	150 (130 – 170)
		0,40	0,95	0,0032	0,0038	0,0048	0,0055	490 (430 – 550)
K6	E/M/A/D	0,40	0,95	0,090	0,11	0,13	0,15	215 (190 – 240)
		0,40	0,95	0,0036	0,0044	0,0050	0,0060	710 (630 – 780)
K7	E/M/A/D	0,40	0,95	0,080	0,095	0,12	0,14	190 (170 – 210)
		0,40	0,95	0,0032	0,0038	0,0048	0,0055	620 (560 – 680)
N1	E/M/A	0,40	0,95	0,080	0,095	0,12	0,14	550 (450 – 660)
		0,40	0,95	0,0032	0,0038	0,0048	0,0055	1800 (1500 – 2100)
N2	E/M/A	0,40	0,95	0,080	0,095	0,12	0,14	355 (290 – 420)
		0,40	0,95	0,0032	0,0038	0,0048	0,0055	1175 (960 – 1300)
N3	E/M/A	0,40	0,95	0,080	0,095	0,12	0,14	240 (200 – 280)
		0,40	0,95	0,0032	0,0038	0,0048	0,0055	790 (660 – 910)
N11	E/M/A	0,40	0,95	0,080	0,095	0,12	0,14	310 (280 – 380)
		0,40	0,95	0,0032	0,0038	0,0048	0,0055	1025 (920 – 1200)
S1	E	0,15	0,95	0,090	0,11	0,13	0,15	32 (26 – 40)
		0,15	0,95	0,0036	0,0044	0,0050	0,0060	105 (86 – 130)
S2	E	0,15	0,95	0,090	0,11	0,13	0,15	28 (21 – 34)
		0,15	0,95	0,0036	0,0044	0,0050	0,0060	90 (69 – 110)
S3	E	0,15	0,95	0,085	0,10	0,12	0,14	24 (19 – 30)
		0,15	0,95	0,0034	0,0040	0,0048	0,0055	80 (63 – 98)
S11	E	0,40	0,95	0,060	0,070	0,090	0,10	90 (77 – 120)
		0,40	0,95	0,0024	0,0028	0,0036	0,0040	295 (260 – 390)
S12	E	0,40	0,95	0,060	0,070	0,090	0,10	70 (59 – 93)
		0,40	0,95	0,0024	0,0028	0,0036	0,0040	230 (200 – 300)
S13	E	0,40	0,95	0,055	0,065	0,080	0,090	55 (47 – 74)
		0,40	0,95	0,0022	0,0026	0,0032	0,0036	180 (160 – 240)
H5	M/A	0,050	0,95	0,090	0,11	0,13	0,15	75 (59 – 73)
		0,050	0,95	0,0036	0,0044	0,0050	0,0060	245 (200 – 230)
H8	M/A	0,050	0,95	0,070	0,085	0,10	0,12	75 (62 – 76)
		0,050	0,95	0,0028	0,0034	0,0040	0,0048	245 (210 – 240)
H21	M/A	0,050	0,95	0,070	0,085	0,10	0,12	75 (62 – 76)
		0,050	0,95	0,0028	0,0034	0,0040	0,0048	245 (210 – 240)
H31	M/A	0,050	0,95	0,060	0,070	0,090	0,10	60 (48 – 59)
		0,050	0,95	0,0024	0,0028	0,0036	0,0040	195 (160 – 190)
TS1	A/D	0,40	0,95	0,080	0,095	0,12	0,14	275 (170 – 380)
		0,40	0,95	0,0032	0,0038	0,0048	0,0055	900 (560 – 1200)
TP1	A/D	0,40	0,95	0,080	0,095	0,12	0,14	275 (170 – 380)
		0,40	0,95	0,0032	0,0038	0,0048	0,0055	900 (560 – 1200)
GR1	A/D	0,40	0,95	0,080	0,095	0,12	0,14	550 (450 – 660)
		0,40	0,95	0,0032	0,0038	0,0048	0,0055	1800 (1500 – 2100)

Universal
Steel and cast iron
Stainless steel and S-materials
Non ferrous
Hard
Plastic and CFRP
Graphite
X-Heads
Minimaster Plus
Minimaster

Cutting data – XSE550 – Slot milling PCEDC 4

SMG		a _p /DC	f _z				v _c
			10	12	16	20	
P1	E/M/A/D	0,80	0,040	0,048	0,065	0,080	165 (130 – 200)
		0,80	0,0016	0,0019	0,0026	0,0032	540 (430 – 650)
P2	E/M/A/D	0,80	0,040	0,048	0,065	0,080	160 (120 – 190)
		0,80	0,0016	0,0019	0,0026	0,0032	520 (400 – 620)
P3	E/M/A/D	0,80	0,040	0,048	0,065	0,080	135 (110 – 170)
		0,80	0,0016	0,0019	0,0026	0,0032	445 (370 – 550)
P4	E/M/A/D	0,80	0,040	0,048	0,065	0,080	120 (90 – 140)
		0,80	0,0016	0,0019	0,0026	0,0032	395 (300 – 450)
P5	E/M/A/D	0,80	0,040	0,048	0,065	0,080	115 (86 – 140)
		0,80	0,0016	0,0019	0,0026	0,0032	375 (290 – 450)
P6	E/M/A/D	0,80	0,040	0,048	0,065	0,080	130 (97 – 160)
		0,80	0,0016	0,0019	0,0026	0,0032	425 (320 – 520)
P7	E/M/A/D	0,80	0,040	0,048	0,065	0,080	120 (92 – 150)
		0,80	0,0016	0,0019	0,0026	0,0032	395 (310 – 490)
P8	E/M/A/D	0,80	0,040	0,048	0,065	0,080	115 (86 – 140)
		0,80	0,0016	0,0019	0,0026	0,0032	375 (290 – 450)
P11	E/M/A/D	0,60	0,030	0,036	0,048	0,060	75 (64 – 94)
		0,60	0,0012	0,0014	0,0019	0,0024	245 (210 – 300)
P12	E/M/A/D	0,48	0,030	0,036	0,048	0,060	44 (38 – 56)
		0,48	0,0012	0,0014	0,0019	0,0024	145 (130 – 180)
M1	E/M/A	0,60	0,030	0,036	0,048	0,060	85 (75 – 110)
		0,60	0,0012	0,0014	0,0019	0,0024	280 (250 – 360)
M2	E/M/A	0,60	0,030	0,036	0,048	0,060	70 (60 – 90)
		0,60	0,0012	0,0014	0,0019	0,0024	230 (200 – 290)
M3	E/M/A	0,60	0,030	0,036	0,048	0,060	40 (30 – 50)
		0,60	0,0012	0,0014	0,0019	0,0024	130 (99 – 160)
M4	E/M/A	0,44	0,030	0,036	0,048	0,060	30 (23 – 38)
		0,44	0,0012	0,0014	0,0019	0,0024	100 (76 – 120)
M5	E/M/A	0,44	0,030	0,036	0,048	0,060	25 (20 – 31)
		0,44	0,0012	0,0014	0,0019	0,0024	80 (66 – 100)
K1	E/M/A/D	0,80	0,040	0,048	0,065	0,080	140 (120 – 160)
		0,80	0,0016	0,0019	0,0026	0,0032	460 (400 – 520)
K2	E/M/A/D	0,80	0,040	0,048	0,065	0,080	120 (110 – 130)
		0,80	0,0016	0,0019	0,0026	0,0032	395 (370 – 420)
K3	E/M/A/D	0,80	0,040	0,048	0,065	0,080	105 (88 – 110)
		0,80	0,0016	0,0019	0,0026	0,0032	345 (290 – 360)
K4	E/M/A/D	0,80	0,040	0,048	0,065	0,080	100 (84 – 110)
		0,80	0,0016	0,0019	0,0026	0,0032	330 (280 – 360)
K5	E/M/A/D	0,80	0,040	0,048	0,065	0,080	140 (120 – 160)
		0,80	0,0016	0,0019	0,0026	0,0032	460 (400 – 520)
K6	E/M/A/D	0,80	0,040	0,048	0,065	0,080	205 (180 – 230)
		0,80	0,0016	0,0019	0,0026	0,0032	670 (600 – 750)
K7	E/M/A/D	0,80	0,040	0,048	0,065	0,080	180 (160 – 200)
		0,80	0,0016	0,0019	0,0026	0,0032	590 (530 – 650)
N1	E/M/A	0,60	0,050	0,060	0,080	0,10	500 (410 – 590)
		0,60	0,0020	0,0024	0,0032	0,0040	1650 (1400 – 1900)
N2	E/M/A	0,60	0,050	0,060	0,080	0,10	320 (260 – 380)
		0,60	0,0020	0,0024	0,0032	0,0040	1050 (860 – 1200)
N3	E/M/A	0,60	0,050	0,060	0,080	0,10	215 (180 – 250)
		0,60	0,0020	0,0024	0,0032	0,0040	710 (600 – 820)
N11	E/M/A	0,60	0,050	0,060	0,080	0,10	280 (250 – 340)
		0,60	0,0020	0,0024	0,0032	0,0040	920 (830 – 1100)
S1	E	0,30	0,030	0,036	0,048	0,060	27 (21 – 33)
		0,30	0,0012	0,0014	0,0019	0,0024	90 (69 – 100)
S2	E	0,30	0,030	0,036	0,048	0,060	23 (17 – 28)
		0,30	0,0012	0,0014	0,0019	0,0024	75 (56 – 91)
S3	E	0,30	0,030	0,036	0,048	0,060	20 (15 – 24)
		0,30	0,0012	0,0014	0,0019	0,0024	65 (50 – 78)
S11	E	0,50	0,050	0,060	0,080	0,10	80 (65 – 100)
		0,50	0,0020	0,0024	0,0032	0,0040	260 (220 – 320)
S12	E	0,50	0,050	0,060	0,080	0,10	60 (50 – 79)
		0,50	0,0020	0,0024	0,0032	0,0040	195 (170 – 250)
S13	E	0,42	0,050	0,060	0,075	0,090	47 (39 – 62)
		0,42	0,0020	0,0024	0,0030	0,0036	155 (130 – 200)
H5	M/A	0,26	0,025	0,030	0,040	0,050	50 (41 – 50)
		0,26	0,0010	0,0012	0,0016	0,0020	165 (140 – 160)
H8	M/A	0,22	0,025	0,030	0,040	0,050	50 (42 – 51)
		0,22	0,0010	0,0012	0,0016	0,0020	165 (140 – 160)
H21	M/A	0,22	0,025	0,030	0,040	0,050	50 (42 – 51)
		0,22	0,0010	0,0012	0,0016	0,0020	165 (140 – 160)
H31	M/A	0,22	0,025	0,030	0,040	0,046	39 (32 – 38)
		0,22	0,0010	0,0012	0,0016	0,0018	130 (110 – 120)
TS1	A/D	0,60	0,050	0,060	0,080	0,10	250 (150 – 340)
		0,60	0,0020	0,0024	0,0032	0,0040	820 (500 – 1100)
TP1	A/D	0,60	0,050	0,060	0,080	0,10	250 (150 – 340)
		0,60	0,0020	0,0024	0,0032	0,0040	820 (500 – 1100)
GR1	A/D	0,60	0,050	0,060	0,080	0,10	500 (410 – 590)
		0,60	0,0020	0,0024	0,0032	0,0040	1650 (1400 – 1900)

Cutting data – XSE550 – Side milling PCEDC 4 inch

SMG		a _e /DC	a _p /DC	f _z				v _c
				3/8	1/2	5/8	3/4	
P1	E/M/A/D	0,40	0,95	0,085	0,10	0,13	0,15	200 (180 – 220)
		0,40	0,95	0,0034	0,0040	0,0050	0,0060	660 (600 – 720)
P2	E/M/A/D	0,40	0,95	0,090	0,10	0,13	0,15	195 (170 – 220)
		0,40	0,95	0,0036	0,0040	0,0050	0,0060	640 (560 – 720)
P3	E/M/A/D	0,40	0,95	0,085	0,10	0,12	0,14	170 (150 – 190)
		0,40	0,95	0,0034	0,0040	0,0048	0,0055	560 (500 – 620)
P4	E/M/A/D	0,40	0,95	0,080	0,095	0,12	0,14	150 (130 – 170)
		0,40	0,95	0,0032	0,0038	0,0048	0,0055	490 (430 – 550)
P5	E/M/A/D	0,40	0,95	0,080	0,095	0,12	0,14	145 (130 – 160)
		0,40	0,95	0,0032	0,0038	0,0048	0,0055	475 (430 – 520)
P6	E/M/A/D	0,40	0,95	0,080	0,095	0,12	0,13	160 (140 – 180)
		0,40	0,95	0,0032	0,0038	0,0048	0,0050	520 (460 – 590)
P7	E/M/A/D	0,40	0,95	0,080	0,095	0,12	0,13	150 (140 – 170)
		0,40	0,95	0,0032	0,0038	0,0048	0,0050	490 (460 – 550)
P8	E/M/A/D	0,40	0,95	0,085	0,10	0,12	0,14	140 (130 – 160)
		0,40	0,95	0,0034	0,0040	0,0048	0,0055	460 (430 – 520)
P11	E/M/A/D	0,30	0,95	0,065	0,075	0,095	0,11	95 (84 – 100)
		0,30	0,95	0,0026	0,0030	0,0038	0,0044	310 (280 – 320)
P12	E/M/A/D	0,30	0,95	0,044	0,055	0,065	0,075	60 (54 – 68)
		0,30	0,95	0,0017	0,0022	0,0026	0,0030	195 (180 – 220)
M1	E/M/A	0,30	0,95	0,070	0,085	0,11	0,12	110 (97 – 120)
		0,30	0,95	0,0028	0,0034	0,0044	0,0048	360 (320 – 390)
M2	E/M/A	0,30	0,95	0,065	0,075	0,095	0,11	90 (80 – 100)
		0,30	0,95	0,0026	0,0030	0,0038	0,0044	295 (270 – 320)
M3	E/M/A	0,30	0,95	0,055	0,065	0,080	0,090	60 (47 – 70)
		0,30	0,95	0,0022	0,0026	0,0032	0,0036	195 (160 – 220)
M4	E/M/A	0,30	0,95	0,048	0,055	0,070	0,080	45 (37 – 54)
		0,30	0,95	0,0019	0,0022	0,0028	0,0032	150 (130 – 170)
M5	E/M/A	0,30	0,95	0,048	0,055	0,070	0,080	38 (31 – 45)
		0,30	0,95	0,0019	0,0022	0,0028	0,0032	125 (110 – 140)
K1	E/M/A/D	0,40	0,95	0,080	0,095	0,12	0,14	160 (160 – 190)
		0,40	0,95	0,0032	0,0038	0,0048	0,0055	520 (530 – 620)
K2	E/M/A/D	0,40	0,95	0,075	0,090	0,11	0,13	140 (140 – 170)
		0,40	0,95	0,0030	0,0036	0,0044	0,0050	460 (460 – 550)
K3	E/M/A/D	0,40	0,95	0,075	0,090	0,11	0,13	120 (120 – 140)
		0,40	0,95	0,0030	0,0036	0,0044	0,0050	395 (400 – 450)
K4	E/M/A/D	0,40	0,95	0,075	0,090	0,11	0,13	115 (110 – 130)
		0,40	0,95	0,0030	0,0036	0,0044	0,0050	375 (370 – 420)
K5	E/M/A/D	0,40	0,95	0,080	0,095	0,12	0,14	150 (130 – 170)
		0,40	0,95	0,0032	0,0038	0,0048	0,0055	490 (430 – 550)
K6	E/M/A/D	0,40	0,95	0,090	0,11	0,13	0,15	215 (190 – 240)
		0,40	0,95	0,0036	0,0044	0,0050	0,0060	710 (630 – 780)
K7	E/M/A/D	0,40	0,95	0,080	0,095	0,12	0,14	190 (170 – 210)
		0,40	0,95	0,0032	0,0038	0,0048	0,0055	620 (560 – 680)
N1	E/M/A	0,40	0,95	0,080	0,095	0,12	0,14	670 (560 – 770)
		0,40	0,95	0,0032	0,0038	0,0048	0,0055	2200 (1900 – 2500)
N2	E/M/A	0,40	0,95	0,080	0,095	0,12	0,14	430 (360 – 490)
		0,40	0,95	0,0032	0,0038	0,0048	0,0055	1400 (1200 – 1600)
N3	E/M/A	0,40	0,95	0,080	0,095	0,12	0,14	285 (240 – 330)
		0,40	0,95	0,0032	0,0038	0,0048	0,0055	940 (790 – 1000)
N11	E/M/A	0,40	0,95	0,080	0,095	0,12	0,14	335 (280 – 380)
		0,40	0,95	0,0032	0,0038	0,0048	0,0055	1100 (920 – 1200)
S1	E	0,15	0,95	0,090	0,11	0,13	0,15	43 (26 – 60)
		0,15	0,95	0,0036	0,0044	0,0050	0,0060	140 (86 – 190)
S2	E	0,15	0,95	0,090	0,11	0,13	0,15	35 (21 – 48)
		0,15	0,95	0,0036	0,0044	0,0050	0,0060	115 (69 – 150)
S3	E	0,15	0,95	0,085	0,10	0,12	0,14	30 (19 – 42)
		0,15	0,95	0,0034	0,0040	0,0048	0,0055	100 (63 – 130)
S11	E	0,40	0,95	0,060	0,070	0,090	0,10	105 (77 – 130)
		0,40	0,95	0,0024	0,0028	0,0036	0,0040	345 (260 – 420)
S12	E	0,40	0,95	0,060	0,070	0,090	0,10	80 (59 – 100)
		0,40	0,95	0,0024	0,0028	0,0036	0,0040	260 (200 – 320)
S13	E	0,40	0,95	0,055	0,065	0,080	0,090	65 (47 – 83)
		0,40	0,95	0,0022	0,0026	0,0032	0,0036	215 (160 – 270)
H5	M/A	0,050	0,95	0,090	0,11	0,13	0,15	75 (59 – 73)
		0,050	0,95	0,0036	0,0044	0,0050	0,0060	245 (200 – 230)
H8	M/A	0,050	0,95	0,070	0,085	0,10	0,12	75 (62 – 76)
		0,050	0,95	0,0028	0,0034	0,0040	0,0048	245 (210 – 240)
H21	M/A	0,050	0,95	0,070	0,085	0,10	0,12	75 (62 – 76)
		0,050	0,95	0,0028	0,0034	0,0040	0,0048	245 (210 – 240)
H31	M/A	0,050	0,95	0,060	0,070	0,090	0,10	60 (48 – 59)
		0,050	0,95	0,0024	0,0028	0,0036	0,0040	195 (160 – 190)
TS1	A/D	0,40	0,95	0,080	0,095	0,12	0,14	275 (170 – 380)
		0,40	0,95	0,0032	0,0038	0,0048	0,0055	900 (560 – 1200)
TP1	A/D	0,40	0,95	0,080	0,095	0,12	0,14	275 (170 – 380)
		0,40	0,95	0,0032	0,0038	0,0048	0,0055	900 (560 – 1200)
GR1	A/D	0,40	0,95	0,080	0,095	0,12	0,14	670 (560 – 770)
		0,40	0,95	0,0032	0,0038	0,0048	0,0055	2200 (1900 – 2500)

Universal
Steel and cast iron
Stainless steel and S-materials
Non ferrous
Hard
Plastic and CFRP
Graphite
X-Heads
Minimaster Plus
Minimaster

Cutting data – XSE550 – Slot milling PCEDC 4 inch

SMG		a _p /DC	f _z				v _c	
			3/8	1/2	5/8	3/4		
Universal Steel and cast iron	P1	E/M/A/D	0,80	0,040	0,048	0,065	0,080	190 (170 – 210)
			0,80	0,0016	0,0019	0,0026	0,0032	620 (560 – 680)
	P2	E/M/A/D	0,80	0,040	0,048	0,065	0,080	185 (160 – 210)
			0,80	0,0016	0,0019	0,0026	0,0032	610 (530 – 680)
	P3	E/M/A/D	0,80	0,040	0,048	0,065	0,080	160 (140 – 180)
			0,80	0,0016	0,0019	0,0026	0,0032	520 (460 – 590)
	P4	E/M/A/D	0,80	0,040	0,048	0,065	0,080	140 (120 – 150)
			0,80	0,0016	0,0019	0,0026	0,0032	460 (400 – 490)
	P5	E/M/A/D	0,80	0,040	0,048	0,065	0,080	135 (120 – 150)
			0,80	0,0016	0,0019	0,0026	0,0032	445 (400 – 490)
	P6	E/M/A/D	0,80	0,040	0,048	0,065	0,080	150 (130 – 170)
			0,80	0,0016	0,0019	0,0026	0,0032	490 (430 – 550)
P7	E/M/A/D	0,80	0,040	0,048	0,065	0,080	140 (130 – 160)	
		0,80	0,0016	0,0019	0,0026	0,0032	460 (430 – 520)	
P8	E/M/A/D	0,80	0,040	0,048	0,065	0,080	135 (120 – 150)	
		0,80	0,0016	0,0019	0,0026	0,0032	445 (400 – 490)	
P11	E/M/A/D	0,60	0,030	0,036	0,048	0,060	85 (74 – 94)	
		0,60	0,0012	0,0014	0,0019	0,0024	280 (250 – 300)	
P12	E/M/A/D	0,60	0,030	0,036	0,048	0,060	50 (44 – 55)	
		0,60	0,0012	0,0014	0,0019	0,0024	165 (150 – 180)	
Non ferrous	M1	E/M/A	0,60	0,030	0,036	0,048	0,060	100 (87 – 110)
		0,60	0,0012	0,0014	0,0019	0,0024	330 (290 – 360)	
	M2	E/M/A	0,60	0,030	0,036	0,048	0,060	80 (70 – 90)
		0,60	0,0012	0,0014	0,0019	0,0024	260 (230 – 290)	
	M3	E/M/A	0,60	0,030	0,036	0,048	0,060	50 (40 – 60)
Hard	M4	E/M/A	0,60	0,030	0,036	0,048	0,060	165 (140 – 190)
		0,60	0,0012	0,0014	0,0019	0,0024	37 (30 – 45)	
	M5	E/M/A	0,60	0,030	0,036	0,048	0,060	120 (99 – 140)
		0,60	0,0012	0,0014	0,0019	0,0024	31 (25 – 37)	
	K1	E/M/A/D	0,80	0,040	0,048	0,065	0,080	150 (150 – 180)
Plastic and cfrp	K2	E/M/A/D	0,80	0,040	0,048	0,065	0,080	490 (500 – 590)
		0,80	0,0016	0,0019	0,0026	0,0032	130 (130 – 150)	
	K3	E/M/A/D	0,80	0,040	0,048	0,065	0,080	425 (430 – 490)
		0,80	0,0016	0,0019	0,0026	0,0032	110 (110 – 130)	
	K4	E/M/A/D	0,80	0,040	0,048	0,065	0,080	360 (370 – 420)
		0,80	0,0016	0,0019	0,0026	0,0032	105 (99 – 120)	
	K5	E/M/A/D	0,80	0,040	0,048	0,065	0,080	345 (330 – 390)
		0,80	0,0016	0,0019	0,0026	0,0032	140 (120 – 160)	
	K6	E/M/A/D	0,80	0,040	0,048	0,065	0,080	460 (400 – 520)
		0,80	0,0016	0,0019	0,0026	0,0032	205 (180 – 230)	
	K7	E/M/A/D	0,80	0,040	0,048	0,065	0,080	670 (600 – 750)
		0,80	0,0016	0,0019	0,0026	0,0032	180 (160 – 200)	
Graphite	N1	E/M/A	0,60	0,050	0,060	0,080	0,10	590 (530 – 650)
		0,60	0,0020	0,0024	0,0032	0,0040	600 (510 – 700)	
	N2	E/M/A	0,60	0,050	0,060	0,080	0,10	1975 (1700 – 2200)
		0,60	0,0020	0,0024	0,0032	0,0040	385 (330 – 450)	
X-Heads	N3	E/M/A	0,60	0,050	0,060	0,080	0,10	1275 (1100 – 1400)
		0,60	0,0020	0,0024	0,0032	0,0040	255 (220 – 300)	
	N11	E/M/A	0,60	0,050	0,060	0,080	0,10	840 (730 – 980)
		0,60	0,0020	0,0024	0,0032	0,0040	300 (250 – 350)	
Mimimaster Plus	S1	E	0,30	0,030	0,036	0,048	0,060	980 (830 – 1100)
		0,30	0,0012	0,0014	0,0019	0,0024	36 (22 – 50)	
	S2	E	0,30	0,030	0,036	0,048	0,060	120 (73 – 160)
		0,30	0,0012	0,0014	0,0019	0,0024	29 (18 – 40)	
	S3	E	0,30	0,030	0,036	0,048	0,060	95 (60 – 130)
		0,30	0,0012	0,0014	0,0019	0,0024	25 (15 – 34)	
	S11	E	0,50	0,050	0,060	0,080	0,10	80 (50 – 110)
		0,50	0,0020	0,0024	0,0032	0,0040	90 (65 – 110)	
	S12	E	0,50	0,050	0,060	0,080	0,10	295 (220 – 360)
	0,50	0,0020	0,0024	0,0032	0,0040	70 (50 – 90)		
Mimimaster	S13	E	0,50	0,050	0,060	0,075	0,090	230 (170 – 290)
		0,50	0,0020	0,0024	0,0030	0,0036	55 (39 – 69)	
	H5	M/A	0,26	0,025	0,030	0,040	0,050	180 (130 – 220)
		0,26	0,0010	0,0012	0,0016	0,0020	50 (41 – 50)	
	H8	M/A	0,26	0,025	0,030	0,040	0,050	165 (140 – 160)
		0,26	0,0010	0,0012	0,0016	0,0020	50 (41 – 50)	
	H21	M/A	0,26	0,025	0,030	0,040	0,050	165 (140 – 160)
		0,26	0,0010	0,0012	0,0016	0,0020	50 (41 – 50)	
	H31	M/A	0,26	0,025	0,030	0,038	0,044	125 (110 – 120)
	0,26	0,0010	0,0012	0,0015	0,0017	38 (31 – 38)		
Mimimaster	TS1	A/D	0,60	0,050	0,060	0,080	0,10	820 (500 – 1100)
		0,60	0,0020	0,0024	0,0032	0,0040	250 (150 – 340)	
	TP1	A/D	0,60	0,050	0,060	0,080	0,10	820 (500 – 1100)
		0,60	0,0020	0,0024	0,0032	0,0040	250 (150 – 340)	
GR1	A/D	0,60	0,050	0,060	0,080	0,10	600 (510 – 700)	
		0,60	0,0020	0,0024	0,0032	0,0040	1975 (1700 – 2200)	

XSE550

High performance – Universal – Square – 5 Flutes – Corner radius

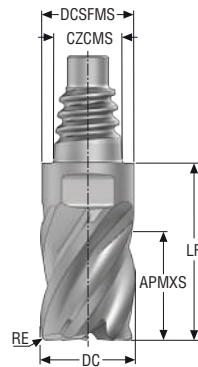

D

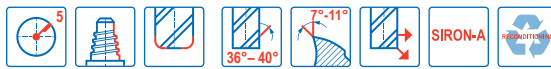

- Tolerances:
- DC= 0/-0,0508 mm
- RE= ±0,0254 mm
- Regrind possible if DC is ≥Ø12 mm

Designation	Item number	Length index	Tool shape	CZCMS	DC	DCSFMS	APMXS	LF	RE	PCEDC	SW	Grade
					mm	mm	mm	mm	mm			SIRA
XSE550E10100D2R050Z5	10138337	2	D	E10	10,0	9,7	12,0	18,7	0,5	5	8	■
XSE550E10100D2R100Z5	10138338	2	D	E10	10,0	9,7	12,0	18,7	1,0	5	8	■
XSE550E12120D2R050Z5	10138339	2	D	E12	12,0	11,7	14,4	22,1	0,5	5	10	■
XSE550E12120D2R100Z5	10138340	2	D	E12	12,0	11,7	14,4	22,1	1,0	5	10	■
XSE550E16160D2R050Z5	10138341	2	D	E16	16,0	15,5	19,2	29,2	0,5	5	12	■
XSE550E16160D2R100Z5	10138342	2	D	E16	16,0	15,5	19,2	29,2	1,0	5	12	■
XSE550E20200D2R050Z5	10138343	2	D	E20	20,0	19,3	24,0	34,3	0,5	5	16	■
XSE550E20200D2R100Z5	10138344	2	D	E20	20,0	19,3	24,0	34,3	1,0	5	16	■

■ Stocked standard.

Universal

Steel and cast iron

Stainless steel and S-materials

Non ferrous

Hard

Plastic and CFRP

Graphite

X-Heads

Minimaster Plus

Minimaster

XSE550

High performance – Universal – Square – 5 Flutes – Corner radius – Inch

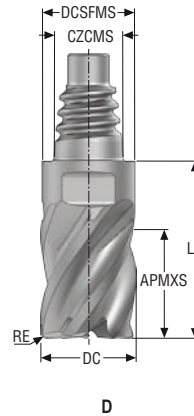

- Tolerances:
- DC= 0/-0.002 Inch
- RE= ±0.01 Inch
- Regrind possible if DC is ≥Ø.500 Inch

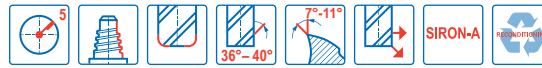

Designation	Item number	Length index	Tool shape	CZCMS	DC	DCSFMS	APMXS	LF	RE	PCEDC	SW	Grade
					Inch	Inch	Inch	Inch	Inch			SIRA
XSE550E10.375D2R015Z5	10138345	2	D	E10	0.375	0.364	0.450	0.720	0.015	5	8	■
XSE550E10.375D2R030Z5	10138346	2	D	E10	0.375	0.364	0.450	0.720	0.030	5	8	■
XSE550E10.375D2R045Z5	10138347	2	D	E10	0.375	0.364	0.450	0.720	0.044	5	8	■
XSE550E12.500D2R030Z5	10138348	2	D	E12	0.500	0.484	0.600	0.906	0.030	5	10	■
XSE550E12.500D2R060Z5	10138349	2	D	E12	0.500	0.484	0.600	0.906	0.060	5	10	■
XSE550E12.500D2R120Z5	10138350	2	D	E12	0.500	0.484	0.600	0.906	0.120	5	10	■
XSE550E16.625D2R030Z5	10138351	2	D	E16	0.625	0.610	0.750	1.150	0.030	5	12	■
XSE550E16.625D2R060Z5	10138352	2	D	E16	0.625	0.610	0.750	1.150	0.060	5	12	■
XSE550E16.625D2R120Z5	10138353	2	D	E16	0.625	0.610	0.750	1.150	0.120	5	12	■
XSE550E20.750D2R030Z5	10138354	2	D	E20	0.750	0.728	0.900	1.295	0.030	5	16	■
XSE550E20.750D2R060Z5	10138355	2	D	E20	0.750	0.728	0.900	1.295	0.060	5	16	■
XSE550E20.750D2R120Z5	10138356	2	D	E20	0.750	0.728	0.900	1.295	0.120	5	16	■
XSE550E251.00D2R030Z5	10138357	2	D	E25	1.000	0.965	1.200	1.673	0.030	5	20	■
XSE550E251.00D2R060Z5	10138358	2	D	E25	1.000	0.965	1.200	1.673	0.060	5	20	■
XSE550E251.00D2R120Z5	10138359	2	D	E25	1.000	0.965	1.200	1.673	0.120	5	20	■

■ Stocked standard.

Cutting data – XSE550 – Side milling PCEDC 5

SMG		a _d /DC	a _p /DC	f _z				v _c	
				10	12	16	20		
P1	E/M/A/D	0,30	0,95	0,080	0,095	0,12	0,14	0,15	165 (130 – 190)
		0,30	0,95	0,0032	0,0038	0,0048	0,0055	0,0060	540 (430 – 620)
P2	E/M/A/D	0,30	0,95	0,080	0,095	0,12	0,14	0,16	160 (130 – 190)
		0,30	0,95	0,0032	0,0038	0,0048	0,0055	0,0065	520 (430 – 620)
P3	E/M/A/D	0,30	0,95	0,075	0,090	0,11	0,13	0,15	140 (110 – 160)
		0,30	0,95	0,0030	0,0036	0,0044	0,0050	0,0060	460 (370 – 520)
P4	E/M/A/D	0,30	0,95	0,075	0,090	0,11	0,13	0,14	125 (97 – 140)
		0,30	0,95	0,0030	0,0036	0,0044	0,0050	0,0055	410 (320 – 450)
P5	E/M/A/D	0,30	0,95	0,075	0,090	0,11	0,13	0,14	110 (97 – 130)
		0,30	0,95	0,0030	0,0036	0,0044	0,0050	0,0055	360 (320 – 420)
P6	E/M/A/D	0,30	0,95	0,075	0,085	0,11	0,12	0,14	125 (110 – 150)
		0,30	0,95	0,0030	0,0034	0,0044	0,0048	0,0055	410 (370 – 490)
P7	E/M/A/D	0,30	0,95	0,075	0,085	0,11	0,12	0,14	120 (110 – 140)
		0,30	0,95	0,0030	0,0034	0,0044	0,0048	0,0055	395 (370 – 450)
P8	E/M/A/D	0,30	0,95	0,075	0,090	0,11	0,13	0,15	110 (97 – 130)
		0,30	0,95	0,0030	0,0036	0,0044	0,0050	0,0060	360 (320 – 420)
P11	E/M/A/D	0,20	0,95	0,060	0,070	0,090	0,10	0,12	100 (89 – 110)
		0,20	0,95	0,0024	0,0028	0,0036	0,0040	0,0048	330 (300 – 360)
P12	E/M/A/D	0,20	0,95	0,042	0,050	0,060	0,070	0,080	65 (56 – 71)
		0,20	0,95	0,0017	0,0020	0,0024	0,0028	0,0032	215 (190 – 230)
M1	E/M/A	0,20	0,95	0,070	0,080	0,10	0,12	0,13	115 (110 – 120)
		0,20	0,95	0,0028	0,0032	0,0040	0,0048	0,0050	375 (370 – 390)
M2	E/M/A	0,20	0,95	0,060	0,075	0,090	0,10	0,12	95 (84 – 100)
		0,20	0,95	0,0024	0,0030	0,0036	0,0040	0,0048	310 (280 – 320)
M3	E/M/A	0,20	0,95	0,060	0,075	0,090	0,10	0,12	60 (47 – 69)
		0,20	0,95	0,0024	0,0030	0,0036	0,0040	0,0048	195 (160 – 220)
M4	E/M/A	0,20	0,95	0,055	0,065	0,080	0,090	0,10	44 (36 – 53)
		0,20	0,95	0,0022	0,0026	0,0032	0,0036	0,0040	145 (120 – 170)
M5	E/M/A	0,20	0,95	0,055	0,065	0,080	0,090	0,10	37 (30 – 44)
		0,20	0,95	0,0022	0,0026	0,0032	0,0036	0,0040	120 (99 – 140)
K1	E/M/A/D	0,30	0,95	0,065	0,075	0,095	0,11	0,12	130 (120 – 150)
		0,30	0,95	0,0026	0,0030	0,0038	0,0044	0,0048	425 (400 – 490)
K2	E/M/A/D	0,30	0,95	0,060	0,070	0,085	0,10	0,11	115 (98 – 130)
		0,30	0,95	0,0024	0,0028	0,0034	0,0040	0,0044	375 (330 – 420)
K3	E/M/A/D	0,30	0,95	0,060	0,070	0,085	0,10	0,11	100 (83 – 110)
		0,30	0,95	0,0024	0,0028	0,0034	0,0040	0,0044	330 (280 – 360)
K4	E/M/A/D	0,30	0,95	0,060	0,070	0,085	0,10	0,11	95 (79 – 100)
		0,30	0,95	0,0024	0,0028	0,0034	0,0040	0,0044	310 (260 – 320)
K5	E/M/A/D	0,30	0,95	0,065	0,075	0,095	0,11	0,12	105 (89 – 130)
		0,30	0,95	0,0026	0,0030	0,0038	0,0044	0,0048	345 (300 – 420)
K6	E/M/A/D	0,30	0,95	0,070	0,085	0,11	0,12	0,14	155 (130 – 190)
		0,30	0,95	0,0028	0,0034	0,0044	0,0048	0,0055	510 (430 – 620)
K7	E/M/A/D	0,30	0,95	0,065	0,075	0,095	0,11	0,12	135 (120 – 160)
		0,30	0,95	0,0026	0,0030	0,0038	0,0044	0,0048	445 (400 – 520)
N1	E/M/A	0,30	0,95	0,065	0,075	0,095	0,11	0,12	690 (580 – 800)
		0,30	0,95	0,0026	0,0030	0,0038	0,0044	0,0048	2275 (2000 – 2600)
N2	E/M/A	0,30	0,95	0,065	0,075	0,095	0,11	0,12	445 (380 – 520)
		0,30	0,95	0,0026	0,0030	0,0038	0,0044	0,0048	1450 (1300 – 1700)
N3	E/M/A	0,30	0,95	0,065	0,075	0,095	0,11	0,12	300 (250 – 340)
		0,30	0,95	0,0026	0,0030	0,0038	0,0044	0,0048	980 (830 – 1100)
N11	E/M/A	0,30	0,95	0,065	0,075	0,095	0,11	0,12	345 (290 – 400)
		0,30	0,95	0,0026	0,0030	0,0038	0,0044	0,0048	1125 (960 – 1300)
S1	E	0,15	0,95	0,075	0,090	0,11	0,13	0,14	27 (24 – 41)
		0,15	0,95	0,0030	0,0036	0,0044	0,0050	0,0055	90 (79 – 130)
S2	E	0,15	0,95	0,075	0,090	0,11	0,13	0,14	26 (21 – 35)
		0,15	0,95	0,0030	0,0036	0,0044	0,0050	0,0055	85 (69 – 110)
S3	E	0,15	0,95	0,070	0,080	0,10	0,12	0,13	25 (19 – 30)
		0,15	0,95	0,0028	0,0032	0,0040	0,0048	0,0050	80 (63 – 98)
S11	E	0,30	0,95	0,055	0,065	0,080	0,090	0,10	65 (52 – 88)
		0,30	0,95	0,0022	0,0026	0,0032	0,0036	0,0040	215 (180 – 280)
S12	E	0,30	0,95	0,055	0,065	0,080	0,090	0,10	50 (40 – 68)
		0,30	0,95	0,0022	0,0026	0,0032	0,0036	0,0040	165 (140 – 220)
S13	E	0,30	0,95	0,048	0,055	0,070	0,080	0,090	41 (32 – 54)
		0,30	0,95	0,0019	0,0022	0,0028	0,0032	0,0036	135 (110 – 170)
H5	M/A	0,050	0,95	0,090	0,10	0,13	0,15	0,17	70 (56 – 83)
		0,050	0,95	0,0036	0,0040	0,0050	0,0060	0,0065	230 (190 – 270)
H8	M/A	0,050	0,95	0,070	0,080	0,10	0,11	0,13	70 (58 – 86)
		0,050	0,95	0,0028	0,0032	0,0040	0,0044	0,0050	230 (200 – 280)
H21	M/A	0,050	0,95	0,070	0,080	0,10	0,11	0,13	70 (58 – 86)
		0,050	0,95	0,0028	0,0032	0,0040	0,0044	0,0050	230 (200 – 280)
H31	M/A	0,050	0,95	0,060	0,070	0,085	0,10	0,11	55 (45 – 67)
		0,050	0,95	0,0024	0,0028	0,0034	0,0040	0,0044	180 (150 – 210)
TS1	A/D	0,30	0,95	0,065	0,075	0,095	0,11	0,12	290 (180 – 400)
		0,30	0,95	0,0026	0,0030	0,0038	0,0044	0,0048	950 (600 – 1300)
TP1	A/D	0,30	0,95	0,065	0,075	0,095	0,11	0,12	290 (180 – 400)
		0,30	0,95	0,0026	0,0030	0,0038	0,0044	0,0048	950 (600 – 1300)

Universal
Steel and cast iron
Stainless steel and S-materials
Non ferrous
Hard
Plastic and CFRP
Graphite
X-Heads
Minimaster Plus
Minimaster

Cutting data – XSE550 – Side milling PCEDC 5 inch

SMG		a _p /DC		f _z					v _c
				3/8	1/2	5/8	3/4	1	
P1	E/M/A/D	0,30	0,95	0,080	0,095	0,12	0,14	0,15	200 (180 – 220)
		0,30	0,95	0,0032	0,0038	0,0048	0,0055	0,0060	660 (600 – 720)
P2	E/M/A/D	0,30	0,95	0,080	0,095	0,12	0,14	0,16	195 (170 – 220)
		0,30	0,95	0,0032	0,0038	0,0048	0,0055	0,0065	640 (560 – 720)
P3	E/M/A/D	0,30	0,95	0,075	0,090	0,11	0,13	0,15	170 (150 – 190)
		0,30	0,95	0,0030	0,0036	0,0044	0,0050	0,0060	560 (500 – 620)
P4	E/M/A/D	0,30	0,95	0,075	0,090	0,11	0,13	0,14	150 (130 – 170)
		0,30	0,95	0,0030	0,0036	0,0044	0,0050	0,0055	490 (430 – 550)
P5	E/M/A/D	0,30	0,95	0,075	0,090	0,11	0,13	0,14	145 (130 – 160)
		0,30	0,95	0,0030	0,0036	0,0044	0,0050	0,0055	475 (430 – 520)
P6	E/M/A/D	0,30	0,95	0,075	0,085	0,11	0,12	0,14	160 (140 – 180)
		0,30	0,95	0,0030	0,0034	0,0044	0,0048	0,0055	520 (460 – 590)
P7	E/M/A/D	0,30	0,95	0,075	0,085	0,11	0,12	0,14	150 (130 – 170)
		0,30	0,95	0,0030	0,0034	0,0044	0,0048	0,0055	490 (430 – 550)
P8	E/M/A/D	0,30	0,95	0,075	0,090	0,11	0,13	0,15	145 (130 – 160)
		0,30	0,95	0,0030	0,0036	0,0044	0,0050	0,0060	475 (430 – 520)
P11	E/M/A/D	0,20	0,95	0,060	0,070	0,090	0,10	0,12	100 (89 – 110)
		0,20	0,95	0,0024	0,0028	0,0036	0,0040	0,0048	330 (300 – 360)
P12	E/M/A/D	0,20	0,95	0,042	0,050	0,060	0,070	0,080	65 (56 – 71)
		0,20	0,95	0,0017	0,0020	0,0024	0,0028	0,0032	215 (190 – 230)
M1	E/M/A	0,20	0,95	0,070	0,080	0,10	0,12	0,13	115 (110 – 120)
		0,20	0,95	0,0028	0,0032	0,0040	0,0048	0,0050	375 (370 – 390)
M2	E/M/A	0,20	0,95	0,060	0,075	0,090	0,10	0,12	95 (84 – 100)
		0,20	0,95	0,0024	0,0030	0,0036	0,0040	0,0048	310 (280 – 320)
M3	E/M/A	0,20	0,95	0,060	0,075	0,090	0,10	0,12	60 (47 – 69)
		0,20	0,95	0,0024	0,0030	0,0036	0,0040	0,0048	195 (160 – 220)
M4	E/M/A	0,20	0,95	0,055	0,065	0,080	0,090	0,10	44 (36 – 53)
		0,20	0,95	0,0022	0,0026	0,0032	0,0036	0,0040	145 (120 – 170)
M5	E/M/A	0,20	0,95	0,055	0,065	0,080	0,090	0,10	37 (30 – 44)
		0,20	0,95	0,0022	0,0026	0,0032	0,0036	0,0040	120 (99 – 140)
K1	E/M/A/D	0,30	0,95	0,065	0,075	0,095	0,11	0,12	165 (160 – 190)
		0,30	0,95	0,0026	0,0030	0,0038	0,0044	0,0048	540 (530 – 620)
K2	E/M/A/D	0,30	0,95	0,060	0,070	0,085	0,10	0,11	145 (140 – 170)
		0,30	0,95	0,0024	0,0028	0,0034	0,0040	0,0044	475 (460 – 550)
K3	E/M/A/D	0,30	0,95	0,060	0,070	0,085	0,10	0,11	125 (120 – 140)
		0,30	0,95	0,0024	0,0028	0,0034	0,0040	0,0044	410 (400 – 450)
K4	E/M/A/D	0,30	0,95	0,060	0,070	0,085	0,10	0,11	120 (110 – 140)
		0,30	0,95	0,0024	0,0028	0,0034	0,0040	0,0044	395 (370 – 450)
K5	E/M/A/D	0,30	0,95	0,065	0,075	0,095	0,11	0,12	155 (140 – 170)
		0,30	0,95	0,0026	0,0030	0,0038	0,0044	0,0048	510 (460 – 550)
K6	E/M/A/D	0,30	0,95	0,070	0,085	0,11	0,12	0,14	225 (200 – 250)
		0,30	0,95	0,0028	0,0034	0,0044	0,0048	0,0055	740 (660 – 820)
K7	E/M/A/D	0,30	0,95	0,065	0,075	0,095	0,11	0,12	200 (170 – 220)
		0,30	0,95	0,0026	0,0030	0,0038	0,0044	0,0048	660 (560 – 720)
N1	E/M/A	0,30	0,95	0,065	0,075	0,095	0,11	0,12	690 (580 – 800)
		0,30	0,95	0,0026	0,0030	0,0038	0,0044	0,0048	2275 (2000 – 2600)
N2	E/M/A	0,30	0,95	0,065	0,075	0,095	0,11	0,12	445 (380 – 520)
		0,30	0,95	0,0026	0,0030	0,0038	0,0044	0,0048	1450 (1300 – 1700)
N3	E/M/A	0,30	0,95	0,065	0,075	0,095	0,11	0,12	300 (250 – 340)
		0,30	0,95	0,0026	0,0030	0,0038	0,0044	0,0048	980 (830 – 1100)
N11	E/M/A	0,30	0,95	0,065	0,075	0,095	0,11	0,12	345 (290 – 400)
		0,30	0,95	0,0026	0,0030	0,0038	0,0044	0,0048	1125 (960 – 1300)
S1	E	0,15	0,95	0,075	0,090	0,11	0,13	0,14	44 (27 – 61)
		0,15	0,95	0,0030	0,0036	0,0044	0,0050	0,0055	145 (89 – 200)
S2	E	0,15	0,95	0,075	0,090	0,11	0,13	0,14	35 (22 – 49)
		0,15	0,95	0,0030	0,0036	0,0044	0,0050	0,0055	115 (73 – 160)
S3	E	0,15	0,95	0,070	0,080	0,10	0,12	0,13	31 (19 – 43)
		0,15	0,95	0,0028	0,0032	0,0040	0,0048	0,0050	100 (63 – 140)
S11	E	0,30	0,95	0,055	0,065	0,080	0,090	0,10	105 (75 – 130)
		0,30	0,95	0,0022	0,0026	0,0032	0,0036	0,0040	345 (250 – 420)
S12	E	0,30	0,95	0,055	0,065	0,080	0,090	0,10	80 (58 – 100)
		0,30	0,95	0,0022	0,0026	0,0032	0,0036	0,0040	260 (200 – 320)
S13	E	0,30	0,95	0,048	0,055	0,070	0,080	0,090	65 (46 – 81)
		0,30	0,95	0,0019	0,0022	0,0028	0,0032	0,0036	215 (160 – 260)
H5	M/A	0,050	0,95	0,090	0,10	0,13	0,15	0,17	70 (56 – 83)
		0,050	0,95	0,0036	0,0040	0,0050	0,0060	0,0065	230 (190 – 270)
H8	M/A	0,050	0,95	0,070	0,080	0,10	0,11	0,13	70 (58 – 86)
		0,050	0,95	0,0028	0,0032	0,0040	0,0044	0,0050	230 (200 – 280)
H21	M/A	0,050	0,95	0,070	0,080	0,10	0,11	0,13	70 (58 – 86)
		0,050	0,95	0,0028	0,0032	0,0040	0,0044	0,0050	230 (200 – 280)
H31	M/A	0,050	0,95	0,060	0,070	0,085	0,10	0,11	55 (45 – 67)
		0,050	0,95	0,0024	0,0028	0,0034	0,0040	0,0044	180 (150 – 210)
TS1	A/D	0,30	0,95	0,065	0,075	0,095	0,11	0,12	290 (180 – 400)
		0,30	0,95	0,0026	0,0030	0,0038	0,0044	0,0048	950 (600 – 1300)
TP1	A/D	0,30	0,95	0,065	0,075	0,095	0,11	0,12	290 (180 – 400)
		0,30	0,95	0,0026	0,0030	0,0038	0,0044	0,0048	950 (600 – 1300)
GR1	A/D	0,30	0,95	0,065	0,075	0,095	0,11	0,12	690 (580 – 800)
		0,30	0,95	0,0026	0,0030	0,0038	0,0044	0,0048	2275 (2000 – 2600)

XSB540

High performance – Universal – Ball nose – 4 Flutes – ICC

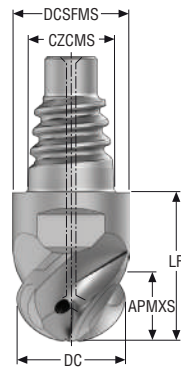

D

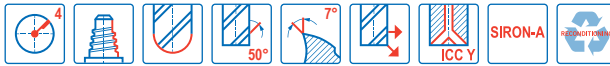

- Tolerances:
- DC= e8
- RE= ±0,02 mm
- Regrind possible if DC is ≥Ø12 mm

Designation	Item number	Length index	Tool shape	CSP	CZCMS	DC	DCSFMS	APMXS	LF	PCEDC	SW	Grade
						mm	mm	mm	mm			SIRA
XSB540E10100D1BZ4A	10138334	1	D	✓	E10	10,0	9,7	5,5	12,3	4	8	■
XSB540E12120D1BZ4A	10138335	1	D	✓	E12	12,0	11,7	6,6	14,4	4	10	■
XSB540E16160D1BZ4A	10138336	1	D	✓	E16	16,0	15,5	8,8	18,6	4	12	■

■ Stocked standard.

Universal

Steel and cast iron

Stainless steel and S-materials

Non ferrous

Hard

Plastic and cfrp

Graphite

X-Heads

Minimaster Plus

Minimaster

Cutting data – XSB540 Copy milling roughing

SMG		a _g /DC	a _p /DC	f _z			v _c
				10	12	16	
P1	E/M/A/D	0,10	0,50	0,055	0,065	0,080	210 (190 – 240)
		0,10	0,50	0,0022	0,0026	0,0032	690 (630 – 780)
P2	E/M/A/D	0,10	0,50	0,055	0,065	0,080	205 (180 – 230)
		0,10	0,50	0,0022	0,0026	0,0032	670 (600 – 750)
P3	E/M/A/D	0,10	0,50	0,050	0,060	0,075	180 (160 – 200)
		0,10	0,50	0,0020	0,0024	0,0030	590 (530 – 650)
P4	E/M/A/D	0,10	0,50	0,050	0,060	0,075	155 (140 – 170)
		0,10	0,50	0,0020	0,0024	0,0030	510 (460 – 550)
P5	E/M/A/D	0,10	0,50	0,050	0,060	0,075	150 (130 – 170)
		0,10	0,50	0,0020	0,0024	0,0030	490 (430 – 550)
P6	E/M/A/D	0,10	0,50	0,050	0,060	0,075	170 (150 – 190)
		0,10	0,50	0,0020	0,0024	0,0030	560 (500 – 620)
P7	E/M/A/D	0,10	0,50	0,050	0,060	0,075	160 (140 – 180)
		0,10	0,50	0,0020	0,0024	0,0030	520 (460 – 590)
P8	E/M/A/D	0,10	0,50	0,050	0,060	0,075	150 (130 – 170)
		0,10	0,50	0,0020	0,0024	0,0030	490 (430 – 550)
P11	E/M/A/D	0,10	0,50	0,070	0,085	0,11	190 (160 – 220)
		0,10	0,50	0,0028	0,0034	0,0044	620 (530 – 720)
P12	E/M/A/D	0,10	0,50	0,050	0,060	0,075	115 (97 – 130)
		0,10	0,50	0,0020	0,0024	0,0030	375 (320 – 420)
M1	E/M/A	0,10	0,50	0,055	0,065	0,080	145 (120 – 170)
		0,10	0,50	0,0022	0,0026	0,0032	475 (400 – 550)
M2	E/M/A	0,10	0,50	0,050	0,060	0,075	115 (97 – 130)
		0,10	0,50	0,0020	0,0024	0,0030	375 (320 – 420)
M3	E/M/A	0,10	0,50	0,040	0,048	0,060	95 (75 – 110)
		0,10	0,50	0,0016	0,0019	0,0024	310 (250 – 360)
M4	E/M/A	0,10	0,50	0,036	0,042	0,050	75 (57 – 88)
		0,10	0,50	0,0014	0,0017	0,0020	245 (190 – 280)
M5	E/M/A	0,10	0,50	0,036	0,042	0,050	60 (48 – 74)
		0,10	0,50	0,0014	0,0017	0,0020	195 (160 – 240)
K1	E/M/A/D	0,15	0,50	0,040	0,048	0,060	205 (190 – 220)
		0,15	0,50	0,0016	0,0019	0,0024	670 (630 – 720)
K2	E/M/A/D	0,15	0,50	0,036	0,044	0,055	180 (160 – 190)
		0,15	0,50	0,0014	0,0017	0,0022	590 (530 – 620)
K3	E/M/A/D	0,15	0,50	0,036	0,044	0,055	150 (140 – 160)
		0,15	0,50	0,0014	0,0017	0,0022	490 (460 – 520)
K4	E/M/A/D	0,10	0,50	0,040	0,048	0,060	170 (150 – 190)
		0,10	0,50	0,0016	0,0019	0,0024	560 (500 – 620)
K5	E/M/A/D	0,10	0,50	0,036	0,042	0,055	105 (90 – 110)
		0,10	0,50	0,0014	0,0017	0,0022	345 (300 – 360)
K6	E/M/A/D	0,10	0,50	0,040	0,048	0,060	150 (140 – 160)
		0,10	0,50	0,0016	0,0019	0,0024	490 (460 – 520)
K7	E/M/A/D	0,10	0,50	0,036	0,042	0,055	130 (120 – 140)
		0,10	0,50	0,0014	0,0017	0,0022	425 (400 – 450)
N1	E/M/A	0,20	0,50	0,070	0,085	0,10	640 (540 – 740)
		0,20	0,50	0,0028	0,0034	0,0040	2100 (1800 – 2400)
N2	E/M/A	0,20	0,50	0,070	0,085	0,10	415 (350 – 480)
		0,20	0,50	0,0028	0,0034	0,0040	1350 (1200 – 1500)
N3	E/M/A	0,20	0,50	0,070	0,085	0,10	275 (230 – 320)
		0,20	0,50	0,0028	0,0034	0,0040	900 (760 – 1000)
N11	E/M/A	0,15	0,50	0,070	0,085	0,10	430 (380 – 480)
		0,15	0,50	0,0028	0,0034	0,0040	1400 (1300 – 1500)
S1	E	0,10	0,50	0,050	0,060	0,075	65 (54 – 74)
		0,10	0,50	0,0020	0,0024	0,0030	215 (180 – 240)
S2	E	0,10	0,50	0,050	0,060	0,075	65 (59 – 75)
		0,10	0,50	0,0020	0,0024	0,0030	215 (200 – 240)
S3	E	0,10	0,50	0,020	0,024	0,030	32 (22 – 42)
		0,10	0,50	0,00080	0,00095	0,0012	105 (73 – 130)
S11	E	0,15	0,50	0,050	0,060	0,075	110 (98 – 120)
		0,15	0,50	0,0020	0,0024	0,0030	360 (330 – 390)
S12	E	0,15	0,50	0,050	0,060	0,075	85 (75 – 96)
		0,15	0,50	0,0020	0,0024	0,0030	280 (250 – 310)
S13	E	0,15	0,50	0,044	0,050	0,065	65 (59 – 75)
		0,15	0,50	0,0017	0,0020	0,0026	215 (200 – 240)
H5	M/A	0,030	0,44	0,050	0,060	0,075	135 (120 – 150)
		0,030	0,44	0,0020	0,0024	0,0030	445 (400 – 490)
H8	M/A	0,030	0,44	0,038	0,046	0,055	135 (120 – 150)
		0,030	0,44	0,0015	0,0018	0,0022	445 (400 – 490)
H21	M/A	0,030	0,44	0,038	0,046	0,055	135 (120 – 150)
		0,030	0,44	0,0015	0,0018	0,0022	445 (400 – 490)
H31	M/A	0,030	0,44	0,034	0,040	0,048	100 (86 – 110)
		0,030	0,44	0,0013	0,0016	0,0019	330 (290 – 360)
TS1	A/D	0,15	0,50	0,10	0,12	0,15	270 (170 – 370)
		0,15	0,50	0,0040	0,0048	0,0060	890 (560 – 1200)
TP1	A/D	0,15	0,50	0,10	0,12	0,15	270 (170 – 370)
		0,15	0,50	0,0040	0,0048	0,0060	890 (560 – 1200)
GR1	A/D	0,15	0,50	0,10	0,12	0,15	640 (540 – 740)
		0,15	0,50	0,0040	0,0048	0,0060	2100 (1800 – 2400)

XSE720

High performance – Superalloy – Square – 6 Flutes – Corner radius

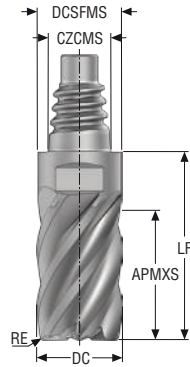

D



- Tolerances:
- DC= e7
- RE= ±0,02 mm
- Regrind possible if DC is ≥Ø12 mm

Designation	Item number	Length index	Tool shape	CZCMS	DC	DCSFMS	APMXS	LF	RE	PCEDC	SW	Grade
					mm	mm	mm	mm	mm			HXT
XSE720E10100D3R050Z6	10138187	3	D	E10	10,0	9,7	15,0	21,8	0,5	6	8	■
XSE720E10100D3R100Z6	10138188	3	D	E10	10,0	9,7	15,0	21,8	1,0	6	8	■
XSE720E12120D3R050Z6	10138189	3	D	E12	12,0	11,7	18,0	25,9	0,5	6	10	■
XSE720E12120D3R100Z6	10138190	3	D	E12	12,0	11,7	18,0	25,9	1,0	6	10	■
XSE720E12120D3R200Z6	10138191	3	D	E12	12,0	11,7	18,0	25,9	2,0	6	10	■
XSE720E12120D3R300Z6	10138192	3	D	E12	12,0	11,7	18,0	25,9	3,0	6	10	■
XSE720E16160D3R050Z6	10138193	3	D	E16	16,0	15,5	24,0	34,1	0,5	6	12	■
XSE720E16160D3R100Z6	10138194	3	D	E16	16,0	15,5	24,0	34,1	1,0	6	12	■
XSE720E16160D3R200Z6	10138195	3	D	E16	16,0	15,5	24,0	34,1	2,0	6	12	■
XSE720E16160D3R300Z6	10138196	3	D	E16	16,0	15,5	24,0	34,1	3,0	6	12	■
XSE720E20200D3R050Z6	10138197	3	D	E20	20,0	19,3	30,0	40,2	0,5	6	16	■
XSE720E20200D3R100Z6	10138198	3	D	E20	20,0	19,3	30,0	40,2	1,0	6	16	■
XSE720E20200D3R200Z6	10138199	3	D	E20	20,0	19,3	30,0	40,2	2,0	6	16	■
XSE720E20200D3R300Z6	10138200	3	D	E20	20,0	19,3	30,0	40,2	3,0	6	16	■
XSE720E25250D3R200Z6	10138201	3	D	E25	25,0	24,2	37,5	49,5	2,0	6	20	■
XSE720E25250D3R300Z6	10138202	3	D	E25	25,0	24,2	37,5	49,5	3,0	6	20	■
XSE720E25250D3R400Z6	10138203	3	D	E25	25,0	24,2	37,5	49,5	4,0	6	20	■

■ Stocked standard.

Universal

Steel and cast iron

Stainless steel and S-materials

Non ferrous

Hard

Plastic and CFRP

Graphite

X-Heads

Minimaster Plus

Minimaster

XSE720

High performance – Superalloy – Square – 6 Flutes – Corner radius or sharp – Inch

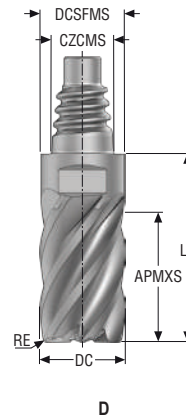

- Tolerances:
- DC= e7
- RE= ±.0008 Inch
- Regrind possible if DC is ≥Ø.500 Inch

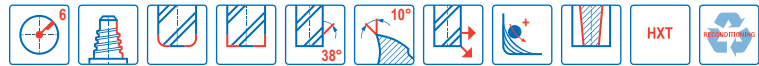

Designation	Item number	Length index	Tool shape	CZCMS	DC	DCSFMS	APMXS	LF	RE	PCEDC	SW	Grade
					<i>Inch</i>	<i>Inch</i>	<i>Inch</i>	<i>Inch</i>	<i>Inch</i>			HXT
XSE720E10.375D3SZ6	10138204	3	D	E10	0.375	0.364	0.563	0.827	–	6	8	■
XSE720E12.500D3SZ6	10138205	3	D	E12	0.500	0.484	0.750	1.055	–	6	10	■
XSE720E16.625D3SZ6	10138206	3	D	E16	0.625	0.610	0.938	1.343	–	6	12	■
XSE720E20.750D3SZ6	10138207	3	D	E20	0.750	0.728	1.125	1.524	–	6	16	■
XSE720E251.00D3SZ6	10138208	3	D	E25	1.000	0.965	1.500	1.980	–	6	20	■
XSE720E10.375D3R030Z6	10138209	3	D	E10	0.375	0.364	0.563	0.827	0.030	6	8	■
XSE720E12.500D3R030Z6	10138210	3	D	E12	0.500	0.484	0.750	1.055	0.030	6	10	■
XSE720E12.500D3R060Z6	10138211	3	D	E12	0.500	0.484	0.750	1.055	0.060	6	10	■
XSE720E12.500D3R120Z6	10138212	3	D	E12	0.500	0.484	0.750	1.055	0.120	6	10	■
XSE720E16.625D3R030Z6	10138213	3	D	E16	0.625	0.610	0.938	1.343	0.030	6	12	■
XSE720E16.625D3R060Z6	10138214	3	D	E16	0.625	0.610	0.938	1.343	0.060	6	12	■
XSE720E16.625D3R120Z6	10138215	3	D	E16	0.625	0.610	0.938	1.343	0.120	6	12	■
XSE720E20.750D3R030Z6	10138216	3	D	E20	0.750	0.728	1.125	1.524	0.030	6	16	■
XSE720E20.750D3R060Z6	10138217	3	D	E20	0.750	0.728	1.125	1.524	0.060	6	16	■
XSE720E20.750D3R120Z6	10138218	3	D	E20	0.750	0.728	1.125	1.524	0.120	6	16	■
XSE720E251.00D3R030Z6	10138219	3	D	E25	1.000	0.965	1.500	1.980	0.030	6	20	■
XSE720E251.00D3R060Z6	10138220	3	D	E25	1.000	0.965	1.500	1.980	0.060	6	20	■
XSE720E251.00D3R120Z6	10138221	3	D	E25	1.000	0.965	1.500	1.980	0.120	6	20	■

■ Stocked standard.

Universal
Steel and cast iron
Stainless steel and S-materials
Non ferrous
Hard
Plastic and CFRP
Graphite
X-Heads
Minimaster Plus
Minimaster

Cutting data – XSE720 Side milling

SMG		a _d /DC	a _p /DC	f _z					v _c
				10	12	16	20	25	
P1	E/M/A/D	0,12	1,4	0,080	0,095	0,12	0,13	0,15	230 (180 – 280)
		0,12	1,4	0,0032	0,0038	0,0048	0,0050	0,0060	750 (600 – 910)
P2	E/M/A/D	0,12	1,4	0,080	0,095	0,12	0,14	0,15	220 (170 – 270)
		0,12	1,4	0,0032	0,0038	0,0048	0,0055	0,0060	720 (560 – 880)
P3	E/M/A/D	0,12	1,4	0,075	0,090	0,11	0,13	0,15	195 (150 – 230)
		0,12	1,4	0,0030	0,0036	0,0044	0,0050	0,0060	640 (500 – 750)
P4	E/M/A/D	0,12	1,4	0,075	0,090	0,11	0,13	0,14	170 (130 – 200)
		0,12	1,4	0,0030	0,0036	0,0044	0,0050	0,0055	560 (430 – 650)
P5	E/M/A/D	0,12	1,4	0,060	0,070	0,090	0,10	0,11	130 (100 – 160)
		0,12	1,4	0,0024	0,0028	0,0036	0,0040	0,0044	425 (330 – 520)
P6	E/M/A/D	0,12	1,4	0,060	0,070	0,085	0,10	0,11	145 (120 – 190)
		0,12	1,4	0,0024	0,0028	0,0034	0,0040	0,0044	475 (400 – 620)
P7	E/M/A/D	0,12	1,4	0,060	0,070	0,085	0,10	0,11	140 (110 – 180)
		0,12	1,4	0,0024	0,0028	0,0034	0,0040	0,0044	460 (370 – 590)
P8	E/M/A/D	0,12	1,4	0,060	0,075	0,090	0,11	0,12	130 (100 – 160)
		0,12	1,4	0,0024	0,0030	0,0036	0,0044	0,0048	425 (330 – 520)
P11	E/M/A/D	0,12	1,4	0,070	0,080	0,10	0,12	0,13	130 (110 – 170)
		0,12	1,4	0,0028	0,0032	0,0040	0,0048	0,0050	425 (370 – 550)
P12	E/M/A/D	0,12	1,4	0,048	0,055	0,070	0,080	0,090	95 (80 – 100)
		0,12	1,4	0,0019	0,0022	0,0028	0,0032	0,0036	310 (270 – 320)
M1	E/M/A	0,12	1,4	0,075	0,090	0,11	0,13	0,15	170 (150 – 190)
		0,12	1,4	0,0030	0,0036	0,0044	0,0050	0,0060	560 (500 – 620)
M2	E/M/A	0,12	1,4	0,070	0,085	0,10	0,12	0,13	140 (120 – 150)
		0,12	1,4	0,0028	0,0034	0,0040	0,0048	0,0050	460 (400 – 490)
M3	E/M/A	0,10	1,4	0,060	0,075	0,090	0,10	0,12	120 (100 – 130)
		0,10	1,4	0,0024	0,0030	0,0036	0,0040	0,0048	395 (330 – 420)
M4	E/M/A	0,10	1,4	0,055	0,065	0,080	0,090	0,10	90 (77 – 100)
		0,10	1,4	0,0022	0,0026	0,0032	0,0036	0,0040	295 (260 – 320)
M5	E/M/A	0,10	1,4	0,055	0,065	0,080	0,090	0,10	75 (64 – 88)
		0,10	1,4	0,0022	0,0026	0,0032	0,0036	0,0040	245 (210 – 280)
S1	E	0,060	1,4	0,046	0,055	0,070	0,080	0,090	45 (35 – 54)
		0,060	1,4	0,0018	0,0022	0,0028	0,0032	0,0036	150 (120 – 170)
S2	E	0,060	1,4	0,042	0,050	0,065	0,075	0,080	35 (25 – 44)
		0,060	1,4	0,0017	0,0020	0,0026	0,0030	0,0032	115 (83 – 140)
S3	E	0,060	1,4	0,042	0,050	0,065	0,075	0,080	30 (20 – 39)
		0,060	1,4	0,0017	0,0020	0,0026	0,0030	0,0032	100 (66 – 120)
S11	E	0,10	1,4	0,060	0,070	0,090	0,10	0,11	105 (78 – 120)
		0,10	1,4	0,0024	0,0028	0,0036	0,0040	0,0044	345 (260 – 390)
S12	E	0,10	1,4	0,060	0,070	0,090	0,10	0,11	80 (60 – 99)
		0,10	1,4	0,0024	0,0028	0,0036	0,0040	0,0044	260 (200 – 320)
S13	E	0,10	1,4	0,050	0,060	0,075	0,090	0,10	65 (48 – 79)
		0,10	1,4	0,0020	0,0024	0,0030	0,0036	0,0040	215 (160 – 250)

SMG = Seco material group
 Coolant = A=air D=dry E=emulsion M=mist spray
 v_c = m/min (sf/min)
 f_z = mm (in/tooth)
 a_p = mm/DC (in/DC) = factor
 a_d = mm/DC (in/DC) = factor
 All cutting data are target values

Universal
 Steel and cast iron
 Stainless steel and S-materials
 Non ferrous
 Hard
 Plastic and CFRP
 Graphite
 X-Heads
 Minimax Plus
 Minimaxter

Cutting data – XSE720 advanced roughing

SMG		a _p /DC	f _z					v _c
			10	12	16	20	25	
P1	E/M/A/D	1,4	0,10	0,12	0,15	0,17	0,19	245 (190 – 300)
		1,4	0,0040	0,0048	0,0060	0,0065	0,0075	800 (630 – 980)
P2	E/M/A/D	1,4	0,10	0,12	0,15	0,18	0,20	240 (190 – 290)
		1,4	0,0040	0,0048	0,0060	0,0070	0,0080	790 (630 – 950)
P3	E/M/A/D	1,4	0,10	0,12	0,14	0,17	0,19	205 (160 – 250)
		1,4	0,0040	0,0048	0,0055	0,0065	0,0075	670 (530 – 820)
P4	E/M/A/D	1,4	0,095	0,11	0,14	0,16	0,18	185 (140 – 220)
		1,4	0,0038	0,0044	0,0055	0,0065	0,0070	610 (460 – 720)
P5	E/M/A/D	1,4	0,075	0,090	0,11	0,13	0,15	140 (110 – 180)
		1,4	0,0030	0,0036	0,0044	0,0050	0,0060	460 (370 – 590)
P6	E/M/A/D	1,4	0,075	0,090	0,11	0,13	0,15	155 (130 – 200)
		1,4	0,0030	0,0036	0,0044	0,0050	0,0060	510 (430 – 650)
P7	E/M/A/D	1,4	0,075	0,090	0,11	0,13	0,15	150 (120 – 190)
		1,4	0,0030	0,0036	0,0044	0,0050	0,0060	490 (400 – 620)
P8	E/M/A/D	1,4	0,080	0,095	0,12	0,14	0,15	140 (110 – 180)
		1,4	0,0032	0,0038	0,0048	0,0055	0,0060	460 (370 – 590)
P11	E/M/A/D	1,4	0,090	0,11	0,13	0,15	0,17	140 (110 – 180)
		1,4	0,0036	0,0044	0,0050	0,0060	0,0065	460 (370 – 590)
P12	E/M/A/D	1,4	0,060	0,070	0,090	0,10	0,12	100 (86 – 110)
		1,4	0,0024	0,0028	0,0036	0,0040	0,0048	330 (290 – 360)
M1	E/M/A	1,4	0,10	0,12	0,15	0,17	0,19	180 (160 – 200)
		1,4	0,0040	0,0048	0,0060	0,0065	0,0075	590 (530 – 650)
M2	E/M/A	1,4	0,090	0,11	0,13	0,15	0,17	150 (130 – 170)
		1,4	0,0036	0,0044	0,0050	0,0060	0,0065	490 (430 – 550)
M3	E/M/A	1,4	0,075	0,085	0,11	0,12	0,14	125 (110 – 140)
		1,4	0,0030	0,0034	0,0044	0,0048	0,0055	410 (370 – 450)
M4	E/M/A	1,4	0,065	0,075	0,095	0,11	0,12	95 (80 – 110)
		1,4	0,0026	0,0030	0,0038	0,0044	0,0048	310 (270 – 360)
M5	E/M/A	1,4	0,065	0,075	0,095	0,11	0,12	80 (67 – 92)
		1,4	0,0026	0,0030	0,0038	0,0044	0,0048	260 (220 – 300)
S1	E	1,4	0,044	0,050	0,065	0,075	0,085	44 (35 – 53)
		1,4	0,0017	0,0020	0,0026	0,0030	0,0034	145 (120 – 170)
S2	E	1,4	0,040	0,048	0,060	0,070	0,075	34 (25 – 43)
		1,4	0,0016	0,0019	0,0024	0,0028	0,0030	110 (83 – 140)
S3	E	1,4	0,040	0,048	0,060	0,070	0,075	29 (20 – 39)
		1,4	0,0016	0,0019	0,0024	0,0028	0,0030	95 (66 – 120)
S11	E	1,4	0,070	0,085	0,10	0,12	0,14	110 (82 – 130)
		1,4	0,0028	0,0034	0,0040	0,0048	0,0055	360 (270 – 420)
S12	E	1,4	0,070	0,085	0,10	0,12	0,14	85 (63 – 100)
		1,4	0,0028	0,0034	0,0040	0,0048	0,0055	280 (210 – 320)
S13	E	1,4	0,060	0,075	0,090	0,10	0,12	65 (50 – 83)
		1,4	0,0024	0,0030	0,0036	0,0040	0,0048	215 (170 – 270)

SMG = Seco material group
Coolant = A=air D=dry E=emulsion M=mist spray
v_c = m/min (sf/min)
f_z = mm (in/tooth)
a_p = mm/DC (in/DC) = factor
a_e = mm/DC (in/DC) = factor
All cutting data are target values

Cutting data – XSE720 Side milling inch

SMG		a _d /DC	a _p /DC	f _z					v _c
				3/8	1/2	5/8	3/4	1	
P1	E/M/A/D	0,12	1,4	0,080	0,095	0,12	0,13	0,15	265 (200 – 320)
		0,12	1,4	0,0032	0,0038	0,0048	0,0050	0,0060	870 (660 – 1000)
P2	E/M/A/D	0,12	1,4	0,080	0,095	0,12	0,14	0,15	255 (200 – 320)
		0,12	1,4	0,0032	0,0038	0,0048	0,0055	0,0060	840 (660 – 1000)
P3	E/M/A/D	0,12	1,4	0,075	0,090	0,11	0,13	0,15	225 (170 – 270)
		0,12	1,4	0,0030	0,0036	0,0044	0,0050	0,0060	740 (560 – 880)
P4	E/M/A/D	0,12	1,4	0,075	0,090	0,11	0,13	0,14	195 (150 – 240)
		0,12	1,4	0,0030	0,0036	0,0044	0,0050	0,0055	640 (500 – 780)
P5	E/M/A/D	0,12	1,4	0,060	0,070	0,090	0,10	0,11	160 (120 – 190)
		0,12	1,4	0,0024	0,0028	0,0036	0,0040	0,0044	520 (400 – 620)
P6	E/M/A/D	0,12	1,4	0,060	0,070	0,085	0,10	0,11	180 (140 – 220)
		0,12	1,4	0,0024	0,0028	0,0034	0,0040	0,0044	590 (460 – 720)
P7	E/M/A/D	0,12	1,4	0,060	0,070	0,085	0,10	0,11	170 (130 – 210)
		0,12	1,4	0,0024	0,0028	0,0034	0,0040	0,0044	560 (430 – 680)
P8	E/M/A/D	0,12	1,4	0,060	0,075	0,090	0,11	0,12	160 (120 – 190)
		0,12	1,4	0,0024	0,0030	0,0036	0,0044	0,0048	520 (400 – 620)
P11	E/M/A/D	0,12	1,4	0,070	0,080	0,10	0,12	0,13	160 (130 – 200)
		0,12	1,4	0,0028	0,0032	0,0040	0,0048	0,0050	520 (430 – 650)
P12	E/M/A/D	0,12	1,4	0,048	0,055	0,070	0,080	0,090	95 (80 – 100)
		0,12	1,4	0,0019	0,0022	0,0028	0,0032	0,0036	310 (270 – 320)
M1	E/M/A	0,12	1,4	0,075	0,090	0,11	0,13	0,15	170 (150 – 190)
		0,12	1,4	0,0030	0,0036	0,0044	0,0050	0,0060	560 (500 – 620)
M2	E/M/A	0,12	1,4	0,070	0,085	0,10	0,12	0,13	140 (120 – 150)
		0,12	1,4	0,0028	0,0034	0,0040	0,0048	0,0050	460 (400 – 490)
M3	E/M/A	0,10	1,4	0,060	0,075	0,090	0,10	0,12	120 (100 – 110)
		0,10	1,4	0,0024	0,0030	0,0036	0,0040	0,0048	395 (330 – 360)
M4	E/M/A	0,10	1,4	0,055	0,065	0,080	0,090	0,10	90 (77 – 91)
		0,10	1,4	0,0022	0,0026	0,0032	0,0036	0,0040	295 (260 – 290)
M5	E/M/A	0,10	1,4	0,055	0,065	0,080	0,090	0,10	75 (64 – 76)
		0,10	1,4	0,0022	0,0026	0,0032	0,0036	0,0040	245 (210 – 240)
S1	E	0,060	1,4	0,046	0,055	0,070	0,080	0,090	45 (35 – 54)
		0,060	1,4	0,0018	0,0022	0,0028	0,0032	0,0036	150 (120 – 170)
S2	E	0,060	1,4	0,042	0,050	0,065	0,075	0,080	35 (25 – 44)
		0,060	1,4	0,0017	0,0020	0,0026	0,0030	0,0032	115 (83 – 140)
S3	E	0,060	1,4	0,042	0,050	0,065	0,075	0,080	30 (20 – 39)
		0,060	1,4	0,0017	0,0020	0,0026	0,0030	0,0032	100 (66 – 120)
S11	E	0,10	1,4	0,060	0,070	0,090	0,10	0,11	105 (78 – 120)
		0,10	1,4	0,0024	0,0028	0,0036	0,0040	0,0044	345 (260 – 390)
S12	E	0,10	1,4	0,060	0,070	0,090	0,10	0,11	80 (60 – 99)
		0,10	1,4	0,0024	0,0028	0,0036	0,0040	0,0044	260 (200 – 320)
S13	E	0,10	1,4	0,050	0,060	0,075	0,090	0,10	65 (48 – 79)
		0,10	1,4	0,0020	0,0024	0,0030	0,0036	0,0040	215 (160 – 250)

SMG = Seco material group
 Coolant = A=air D=dry E=emulsion M=mist spray
 v_c = m/min (sf/min)
 f_z = mm (in/tooth)
 a_p = mm/DC (in/DC) = factor
 a_d = mm/DC (in/DC) = factor
 All cutting data are target values

Universal
 Steel and cast iron
 Stainless steel and S-materials
 Non ferrous
 Hard
 Plastic and cfrp
 Graphite
 X-Heads
 Minmaster Plus
 Minmaster

Cutting data – XSE720 advanced roughing inch

SMG		a _p /DC	f _z					v _c
			3/8	1/2	5/8	3/4	1	
P1	E/M/A/D	1,4	0,10	0,12	0,15	0,17	0,19	285 (220 — 350)
		1,4	0,0040	0,0048	0,0060	0,0065	0,0075	940 (730 — 1100)
P2	E/M/A/D	1,4	0,10	0,12	0,15	0,18	0,20	275 (210 — 340)
		1,4	0,0040	0,0048	0,0060	0,0070	0,0080	900 (690 — 1100)
P3	E/M/A/D	1,4	0,10	0,12	0,14	0,17	0,19	240 (180 — 290)
		1,4	0,0040	0,0048	0,0055	0,0065	0,0075	790 (600 — 950)
P4	E/M/A/D	1,4	0,095	0,11	0,14	0,16	0,18	210 (160 — 260)
		1,4	0,0038	0,0044	0,0055	0,0065	0,0070	690 (530 — 850)
P5	E/M/A/D	1,4	0,075	0,090	0,11	0,13	0,15	175 (130 — 210)
		1,4	0,0030	0,0036	0,0044	0,0050	0,0060	570 (430 — 680)
P6	E/M/A/D	1,4	0,075	0,090	0,11	0,13	0,15	195 (150 — 240)
		1,4	0,0030	0,0036	0,0044	0,0050	0,0060	640 (500 — 780)
P7	E/M/A/D	1,4	0,075	0,090	0,11	0,13	0,15	185 (140 — 220)
		1,4	0,0030	0,0036	0,0044	0,0050	0,0060	610 (460 — 720)
P8	E/M/A/D	1,4	0,080	0,095	0,12	0,14	0,15	170 (130 — 210)
		1,4	0,0032	0,0038	0,0048	0,0055	0,0060	560 (430 — 680)
P11	E/M/A/D	1,4	0,090	0,11	0,13	0,15	0,17	170 (130 — 210)
		1,4	0,0036	0,0044	0,0050	0,0060	0,0065	560 (430 — 680)
P12	E/M/A/D	1,4	0,060	0,070	0,090	0,10	0,12	100 (86 — 110)
		1,4	0,0024	0,0028	0,0036	0,0040	0,0048	330 (290 — 360)
M1	E/M/A	1,4	0,10	0,12	0,15	0,17	0,19	180 (160 — 200)
		1,4	0,0040	0,0048	0,0060	0,0065	0,0075	590 (530 — 650)
M2	E/M/A	1,4	0,090	0,11	0,13	0,15	0,17	150 (130 — 170)
		1,4	0,0036	0,0044	0,0050	0,0060	0,0065	490 (430 — 550)
M3	E/M/A	1,4	0,075	0,085	0,11	0,12	0,14	125 (110 — 120)
		1,4	0,0030	0,0034	0,0044	0,0048	0,0055	410 (370 — 390)
M4	E/M/A	1,4	0,065	0,075	0,095	0,11	0,12	95 (80 — 95)
		1,4	0,0026	0,0030	0,0038	0,0044	0,0048	310 (270 — 310)
M5	E/M/A	1,4	0,065	0,075	0,095	0,11	0,12	80 (67 — 79)
		1,4	0,0026	0,0030	0,0038	0,0044	0,0048	260 (220 — 250)
S1	E	1,4	0,044	0,050	0,065	0,075	0,085	44 (35 — 53)
		1,4	0,0017	0,0020	0,0026	0,0030	0,0034	145 (120 — 170)
S2	E	1,4	0,040	0,048	0,060	0,070	0,075	34 (25 — 43)
		1,4	0,0016	0,0019	0,0024	0,0028	0,0030	110 (83 — 140)
S3	E	1,4	0,040	0,048	0,060	0,070	0,075	29 (20 — 39)
		1,4	0,0016	0,0019	0,0024	0,0028	0,0030	95 (66 — 120)
S11	E	1,4	0,070	0,085	0,10	0,12	0,14	110 (82 — 130)
		1,4	0,0028	0,0034	0,0040	0,0048	0,0055	360 (270 — 420)
S12	E	1,4	0,070	0,085	0,10	0,12	0,14	85 (63 — 100)
		1,4	0,0028	0,0034	0,0040	0,0048	0,0055	280 (210 — 320)
S13	E	1,4	0,060	0,075	0,090	0,10	0,12	65 (50 — 83)
		1,4	0,0024	0,0030	0,0036	0,0040	0,0048	215 (170 — 270)

SMG = Seco material group
Coolant = A=air D=dry E=emulsion M=mist spray
v_c = m/min (sf/min)
f_z = mm (in/tooth)
a_p = mm/DC (in/DC) = factor
a_e = mm/DC (in/DC) = factor
All cutting data are target values

XSB720

High performance – Superalloy – Ball nose – 6 Flutes

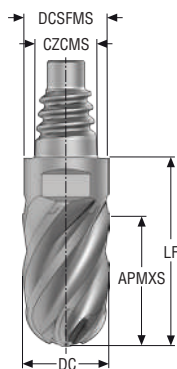

D



- Tolerances:
- DC= e7
- RE= ±0,02 mm
- Regrind possible if DC is ≥Ø12 mm

Designation	Item number	Length index	Tool shape	CZCMS	DC	DCSFMS	APMXS	LF	PCEDC	SW	Grade
					mm	mm	mm	mm			HXT
XSB720E10100D3BZ6	10138222	3	D	E10	10,0	9,7	15,0	21,8	6	8	■
XSB720E12120D3BZ6	10138223	3	D	E12	12,0	11,7	18,0	25,9	6	10	■
XSB720E16160D3BZ6	10138224	3	D	E16	16,0	15,5	24,0	34,1	6	12	■
XSB720E20200D3BZ6	10138225	3	D	E20	20,0	19,3	30,0	40,2	6	16	■

■ Stocked standard.

Universal

Steel and cast iron

Stainless steel and S-materials

Non ferrous

Hard

Plastic and CFRP

Graphite

X-Heads

Minimaster Plus

Minimaster

XSB720

High performance – Superalloy – Ball nose – 6 Flutes – Inch

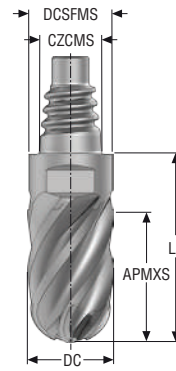

D

- Tolerances:
- DC= e7
- RE= ±.0008 Inch
- Regrind possible if DC is ≥Ø.500 Inch

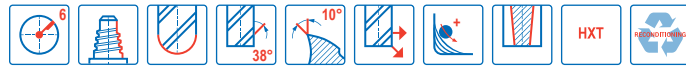

Designation	Item number	Length index	Tool shape	CZCMS	DC	DCSFMS	APMXS	LF	PCEDC	SW	Grade
					<i>Inch</i>	<i>Inch</i>	<i>Inch</i>	<i>Inch</i>			HXT
XSB720E10.375D3BZ6	10138226	3	D	E10	0.375	0.364	0.563	0.827	6	8	■
XSB720E12.500D3BZ6	10138227	3	D	E12	0.500	0.484	0.750	1.055	6	10	■
XSB720E16.625D3BZ6	10138228	3	D	E16	0.625	0.610	0.938	1.343	6	12	■
XSB720E20.750D3BZ6	10138229	3	D	E20	0.750	0.728	1.125	1.524	6	16	■
XSB720E251.00D3BZ6	10138230	3	D	E25	1.000	0.965	1.500	1.980	6	20	■

■ Stocked standard.

Universal
Steel and cast iron
Stainless steel and S-materials
Non ferrous
Hard
Plastic and CFRP
Graphite
X-Heads
Minimaster Plus
Minimaster

Cutting data – XSB720 Side milling

SMG		a _e /DC	a _p /DC	f _z				v _c
				10	12	16	20	
P1	E/M/A/D	0,12	1,2	0,095	0,11	0,14	0,16	185 (150 – 140)
		0,12	1,2	0,0038	0,0044	0,0055	0,0065	610 (500 – 450)
P2	E/M/A/D	0,12	1,2	0,10	0,12	0,15	0,17	175 (140 – 130)
		0,12	1,2	0,0040	0,0048	0,0060	0,0065	570 (460 – 420)
P3	E/M/A/D	0,12	1,2	0,095	0,11	0,14	0,16	155 (120 – 110)
		0,12	1,2	0,0038	0,0044	0,0055	0,0065	510 (400 – 360)
P4	E/M/A/D	0,12	1,2	0,090	0,11	0,13	0,16	135 (110 – 100)
		0,12	1,2	0,0036	0,0044	0,0050	0,0065	445 (370 – 320)
P5	E/M/A/D	0,12	1,2	0,090	0,11	0,13	0,15	130 (110 – 100)
		0,12	1,2	0,0036	0,0044	0,0050	0,0060	425 (370 – 320)
P6	E/M/A/D	0,12	1,2	0,090	0,11	0,13	0,15	145 (120 – 110)
		0,12	1,2	0,0036	0,0044	0,0050	0,0060	475 (400 – 360)
P7	E/M/A/D	0,12	1,2	0,090	0,11	0,13	0,15	140 (110 – 100)
		0,12	1,2	0,0036	0,0044	0,0050	0,0060	460 (370 – 320)
P8	E/M/A/D	0,12	1,2	0,095	0,11	0,14	0,16	130 (99 – 98)
		0,12	1,2	0,0038	0,0044	0,0055	0,0065	425 (330 – 320)
P11	E/M/A/D	0,12	1,2	0,070	0,080	0,10	0,12	140 (110 – 100)
		0,12	1,2	0,0028	0,0032	0,0040	0,0048	460 (370 – 320)
P12	E/M/A/D	0,12	1,2	0,048	0,055	0,070	0,080	85 (68 – 67)
		0,12	1,2	0,0019	0,0022	0,0028	0,0032	280 (230 – 210)
M1	E/M/A	0,12	1,2	0,075	0,090	0,11	0,13	170 (150 – 190)
		0,12	1,2	0,0030	0,0036	0,0044	0,0050	560 (500 – 620)
M2	E/M/A	0,12	1,2	0,070	0,085	0,10	0,12	140 (120 – 160)
		0,12	1,2	0,0028	0,0034	0,0040	0,0048	460 (400 – 520)
M3	E/M/A	0,10	1,2	0,060	0,070	0,090	0,10	120 (110 – 140)
		0,10	1,2	0,0024	0,0028	0,0036	0,0040	395 (370 – 450)
M4	E/M/A	0,10	1,2	0,050	0,060	0,075	0,090	90 (77 – 100)
		0,10	1,2	0,0020	0,0024	0,0030	0,0036	295 (260 – 320)
M5	E/M/A	0,10	1,2	0,050	0,060	0,075	0,090	75 (65 – 89)
		0,10	1,2	0,0020	0,0024	0,0030	0,0036	245 (220 – 290)
S1	E	0,070	1,2	0,048	0,055	0,070	0,080	45 (35 – 54)
		0,070	1,2	0,0019	0,0022	0,0028	0,0032	150 (120 – 170)
S2	E	0,070	1,2	0,048	0,055	0,070	0,080	35 (5 – 45)
		0,070	1,2	0,0019	0,0022	0,0028	0,0032	115 (17 – 140)
S3	E	0,070	1,2	0,048	0,055	0,070	0,080	30 (20 – 40)
		0,070	1,2	0,0019	0,0022	0,0028	0,0032	100 (66 – 130)
S11	E	0,10	1,2	0,060	0,070	0,090	0,10	105 (79 – 130)
		0,10	1,2	0,0024	0,0028	0,0036	0,0040	345 (260 – 420)
S12	E	0,10	1,2	0,060	0,070	0,090	0,10	80 (61 – 100)
		0,10	1,2	0,0024	0,0028	0,0036	0,0040	260 (210 – 320)
S13	E	0,10	1,2	0,060	0,070	0,090	0,10	60 (47 – 77)
		0,10	1,2	0,0024	0,0028	0,0036	0,0040	195 (160 – 250)

SMG = Seco material group
 Coolant = A=air D=dry E=emulsion M=mist spray
 v_c = m/min (sf/min)
 f_z = mm (in/tooth)
 a_p = mm/DC (in/DC) = factor
 a_e = mm/DC (in/DC) = factor
 All cutting data are target values

Universal
 Steel and cast iron
 Stainless steel and S-materials
 Non ferrous
 Hard
 Plastic and CFRP
 Graphite
 X-Heads
 Minimaster Plus
 Minimaster

Cutting data – XSB720 Side milling advanced roughing $a_p/DC=0,07$

SMG		a_p/DC	f_z				v_c
			10	12	16	20	
P1	E/M/A/D	1,2	0,12	0,14	0,18	0,22	195 (160 – 150)
		1,2	0,0048	0,0055	0,0070	0,0085	640 (530 – 490)
P2	E/M/A/D	1,2	0,12	0,14	0,19	0,22	190 (150 – 140)
		1,2	0,0048	0,0055	0,0075	0,0085	620 (500 – 450)
P3	E/M/A/D	1,2	0,12	0,14	0,18	0,20	165 (130 – 120)
		1,2	0,0048	0,0055	0,0070	0,0080	540 (430 – 390)
P4	E/M/A/D	1,2	0,12	0,14	0,17	0,20	145 (120 – 110)
		1,2	0,0048	0,0055	0,0065	0,0080	475 (400 – 360)
P5	E/M/A/D	1,2	0,12	0,14	0,17	0,20	140 (110 – 100)
		1,2	0,0048	0,0055	0,0065	0,0080	460 (370 – 320)
P6	E/M/A/D	1,2	0,11	0,14	0,17	0,19	160 (130 – 120)
		1,2	0,0044	0,0055	0,0065	0,0075	520 (430 – 390)
P7	E/M/A/D	1,2	0,11	0,14	0,17	0,19	150 (120 – 110)
		1,2	0,0044	0,0055	0,0065	0,0075	490 (400 – 360)
P8	E/M/A/D	1,2	0,12	0,14	0,18	0,20	140 (110 – 100)
		1,2	0,0048	0,0055	0,0070	0,0080	460 (370 – 320)
P11	E/M/A/D	1,2	0,090	0,11	0,13	0,15	150 (120 – 110)
		1,2	0,0036	0,0044	0,0050	0,0060	490 (400 – 360)
P12	E/M/A/D	1,2	0,060	0,070	0,090	0,10	95 (73 – 72)
		1,2	0,0024	0,0028	0,0036	0,0040	310 (240 – 230)
M1	E/M/A	1,2	0,10	0,12	0,15	0,17	185 (160 – 200)
		1,2	0,0040	0,0048	0,0060	0,0065	610 (530 – 650)
M2	E/M/A	1,2	0,090	0,11	0,13	0,15	150 (130 – 170)
		1,2	0,0036	0,0044	0,0050	0,0060	490 (430 – 550)
M3	E/M/A	1,2	0,070	0,085	0,10	0,12	125 (110 – 140)
		1,2	0,0028	0,0034	0,0040	0,0048	410 (370 – 450)
M4	E/M/A	1,2	0,060	0,075	0,090	0,10	95 (81 – 110)
		1,2	0,0024	0,0030	0,0036	0,0040	310 (270 – 360)
M5	E/M/A	1,2	0,060	0,075	0,090	0,10	80 (68 – 93)
		1,2	0,0024	0,0030	0,0036	0,0040	260 (230 – 300)
S1	E	1,2	0,048	0,055	0,070	0,080	45 (35 – 54)
		1,2	0,0019	0,0022	0,0028	0,0032	150 (120 – 170)
S2	E	1,2	0,048	0,055	0,070	0,080	35 (5 – 45)
		1,2	0,0019	0,0022	0,0028	0,0032	115 (17 – 140)
S3	E	1,2	0,048	0,055	0,070	0,080	30 (20 – 40)
		1,2	0,0019	0,0022	0,0028	0,0032	100 (66 – 130)
S11	E	1,2	0,070	0,085	0,10	0,12	110 (82 – 130)
		1,2	0,0028	0,0034	0,0040	0,0048	360 (270 – 420)
S12	E	1,2	0,070	0,085	0,10	0,12	85 (63 – 100)
		1,2	0,0028	0,0034	0,0040	0,0048	280 (210 – 320)
S13	E	1,2	0,070	0,085	0,10	0,12	65 (49 – 81)
		1,2	0,0028	0,0034	0,0040	0,0048	215 (170 – 260)

SMG = Seco material group
Coolant = A=air D=dry E=emulsion M=mist spray
 v_c = m/min (sf/min)
 f_z = mm (in/tooth)
 a_p = mm/DC (in/DC) = factor
 a_e = mm/DC (in/DC) = factor
All cutting data are target values

Cutting data – XSB720 Side milling inch

SMG		a _e /DC	a _p /DC	f _z				v _c
				3/8	1/2	5/8	3/4	
P1	E/M/A/D	0,12	1,2	0,095	0,11	0,14	0,16	195 (170 – 220)
		0,12	1,2	0,0038	0,0044	0,0055	0,0065	640 (560 – 720)
P2	E/M/A/D	0,12	1,2	0,10	0,12	0,15	0,17	190 (170 – 210)
		0,12	1,2	0,0040	0,0048	0,0060	0,0065	620 (560 – 680)
P3	E/M/A/D	0,12	1,2	0,095	0,11	0,14	0,16	165 (150 – 180)
		0,12	1,2	0,0038	0,0044	0,0055	0,0065	540 (500 – 590)
P4	E/M/A/D	0,12	1,2	0,090	0,11	0,13	0,16	145 (130 – 160)
		0,12	1,2	0,0036	0,0044	0,0050	0,0065	475 (430 – 520)
P5	E/M/A/D	0,12	1,2	0,090	0,11	0,13	0,15	140 (130 – 160)
		0,12	1,2	0,0036	0,0044	0,0050	0,0060	460 (430 – 520)
P6	E/M/A/D	0,12	1,2	0,090	0,11	0,13	0,15	155 (140 – 170)
		0,12	1,2	0,0036	0,0044	0,0050	0,0060	510 (460 – 550)
P7	E/M/A/D	0,12	1,2	0,090	0,11	0,13	0,15	150 (130 – 160)
		0,12	1,2	0,0036	0,0044	0,0050	0,0060	490 (430 – 520)
P8	E/M/A/D	0,12	1,2	0,095	0,11	0,14	0,16	140 (120 – 150)
		0,12	1,2	0,0038	0,0044	0,0055	0,0065	460 (400 – 490)
P11	E/M/A/D	0,12	1,2	0,070	0,080	0,10	0,12	150 (130 – 170)
		0,12	1,2	0,0028	0,0032	0,0040	0,0048	490 (430 – 550)
P12	E/M/A/D	0,12	1,2	0,048	0,055	0,070	0,080	95 (81 – 100)
		0,12	1,2	0,0019	0,0022	0,0028	0,0032	310 (270 – 320)
M1	E/M/A	0,12	1,2	0,075	0,090	0,11	0,13	220 (180 – 260)
		0,12	1,2	0,0030	0,0036	0,0044	0,0050	720 (600 – 850)
M2	E/M/A	0,12	1,2	0,070	0,085	0,10	0,12	180 (140 – 220)
		0,12	1,2	0,0028	0,0034	0,0040	0,0048	590 (460 – 720)
M3	E/M/A	0,10	1,2	0,060	0,070	0,090	0,10	160 (120 – 200)
		0,10	1,2	0,0024	0,0028	0,0036	0,0040	520 (400 – 650)
M4	E/M/A	0,10	1,2	0,050	0,060	0,075	0,090	125 (93 – 150)
		0,10	1,2	0,0020	0,0024	0,0030	0,0036	410 (310 – 490)
M5	E/M/A	0,10	1,2	0,050	0,060	0,075	0,090	105 (77 – 120)
		0,10	1,2	0,0020	0,0024	0,0030	0,0036	345 (260 – 390)
S1	E	0,070	1,2	0,048	0,055	0,070	0,080	45 (35 – 54)
		0,070	1,2	0,0019	0,0022	0,0028	0,0032	150 (120 – 170)
S2	E	0,070	1,2	0,048	0,055	0,070	0,080	37 (27 – 47)
		0,070	1,2	0,0019	0,0022	0,0028	0,0032	120 (89 – 150)
S3	E	0,070	1,2	0,048	0,055	0,070	0,080	30 (20 – 40)
		0,070	1,2	0,0019	0,0022	0,0028	0,0032	100 (66 – 130)
S11	E	0,10	1,2	0,060	0,070	0,090	0,10	80 (61 – 100)
		0,10	1,2	0,0024	0,0028	0,0036	0,0040	260 (210 – 320)
S12	E	0,10	1,2	0,060	0,070	0,090	0,10	80 (61 – 100)
		0,10	1,2	0,0024	0,0028	0,0036	0,0040	260 (210 – 320)
S13	E	0,10	1,2	0,060	0,070	0,090	0,10	80 (61 – 100)
		0,10	1,2	0,0024	0,0028	0,0036	0,0040	260 (210 – 320)

SMG = Seco material group
 Coolant = A=air D=dry E=emulsion M=mist spray
 v_c = m/min (sf/min)
 f_z = mm (in/tooth)
 a_p = mm/DC (in/DC) = factor
 a_e = mm/DC (in/DC) = factor
 All cutting data are target values

Universal
 Steel and cast iron
 Stainless steel and S-materials
 Non ferrous
 Hard
 Plastic and CFRP
 Graphite
 X-Heads
 Minimaster Plus
 Minimaster

Cutting data – XSB720 Side milling advanced roughing $a_p/DC=0,07$ inch

SMG		a_p/DC	f_z				v_c
			3/8	1/2	5/8	3/4	
P1	E/M/A/D	1,2	0,12	0,14	0,18	0,22	210 (190 – 240)
		1,2	0,0048	0,0055	0,0070	0,0085	690 (630 – 780)
P2	E/M/A/D	1,2	0,12	0,14	0,19	0,22	205 (180 – 230)
		1,2	0,0048	0,0055	0,0075	0,0085	670 (600 – 750)
P3	E/M/A/D	1,2	0,12	0,14	0,18	0,20	180 (160 – 200)
		1,2	0,0048	0,0055	0,0070	0,0080	590 (530 – 650)
P4	E/M/A/D	1,2	0,12	0,14	0,17	0,20	155 (140 – 170)
		1,2	0,0048	0,0055	0,0065	0,0080	510 (460 – 550)
P5	E/M/A/D	1,2	0,12	0,14	0,17	0,20	150 (130 – 170)
		1,2	0,0048	0,0055	0,0065	0,0080	490 (430 – 550)
P6	E/M/A/D	1,2	0,11	0,14	0,17	0,19	170 (150 – 190)
		1,2	0,0044	0,0055	0,0065	0,0075	560 (500 – 620)
P7	E/M/A/D	1,2	0,11	0,14	0,17	0,19	160 (140 – 180)
		1,2	0,0044	0,0055	0,0065	0,0075	520 (460 – 590)
P8	E/M/A/D	1,2	0,12	0,14	0,18	0,20	150 (130 – 170)
		1,2	0,0048	0,0055	0,0070	0,0080	490 (430 – 550)
P11	E/M/A/D	1,2	0,090	0,11	0,13	0,15	160 (140 – 180)
		1,2	0,0036	0,0044	0,0050	0,0060	520 (460 – 590)
P12	E/M/A/D	1,2	0,060	0,070	0,090	0,10	100 (87 – 110)
		1,2	0,0024	0,0028	0,0036	0,0040	330 (290 – 360)
M1	E/M/A	1,2	0,10	0,12	0,15	0,17	235 (190 – 280)
		1,2	0,0040	0,0048	0,0060	0,0065	770 (630 – 910)
M2	E/M/A	1,2	0,090	0,11	0,13	0,15	195 (160 – 230)
		1,2	0,0036	0,0044	0,0050	0,0060	640 (530 – 750)
M3	E/M/A	1,2	0,070	0,085	0,10	0,12	170 (130 – 200)
		1,2	0,0028	0,0034	0,0040	0,0048	560 (430 – 650)
M4	E/M/A	1,2	0,060	0,075	0,090	0,10	130 (97 – 160)
		1,2	0,0024	0,0030	0,0036	0,0040	425 (320 – 520)
M5	E/M/A	1,2	0,060	0,075	0,090	0,10	105 (81 – 130)
		1,2	0,0024	0,0030	0,0036	0,0040	345 (270 – 420)
S1	E	1,2	0,048	0,055	0,070	0,080	45 (35 – 54)
		1,2	0,0019	0,0022	0,0028	0,0032	150 (120 – 170)
S2	E	1,2	0,048	0,055	0,070	0,080	37 (27 – 47)
		1,2	0,0019	0,0022	0,0028	0,0032	120 (89 – 150)
S3	E	1,2	0,048	0,055	0,070	0,080	30 (20 – 40)
		1,2	0,0019	0,0022	0,0028	0,0032	100 (66 – 130)
S11	E	1,2	0,070	0,085	0,10	0,12	85 (63 – 100)
		1,2	0,0028	0,0034	0,0040	0,0048	280 (210 – 320)
S12	E	1,2	0,070	0,085	0,10	0,12	85 (63 – 100)
		1,2	0,0028	0,0034	0,0040	0,0048	280 (210 – 320)
S13	E	1,2	0,070	0,085	0,10	0,12	85 (63 – 100)
		1,2	0,0028	0,0034	0,0040	0,0048	280 (210 – 320)

SMG = Seco material group
Coolant = A=air D=dry E=emulsion M=mist spray
 v_c = m/min (sf/min)
 f_z = mm (in/tooth)
 a_p = mm/DC (in/DC) = factor
 a_e = mm/DC (in/DC) = factor
All cutting data are target values

XSE450

High performance – Aluminium – Square – 3 Flutes – Corner radius

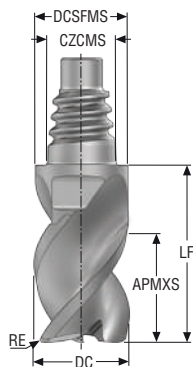

D

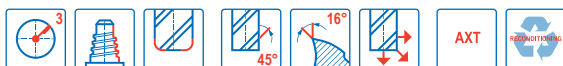

- Tolerances:
- DC= 0/-0,0508 mm
- RE= ±0,0254 mm
- Regrind possible if DC is ≥Ø12 mm

Designation	Item number	Length index	Tool shape	CZCMS	DC	DCSFMS	APMXS	LF	RE	PCEDC	SW	Grade
					mm	mm	mm	mm	mm			AXT
XSE450E10100D2R050Z3	10138362	2	D	E10	10,0	9,7	12,0	18,7	0,5	3	8	■
XSE450E12120D2R050Z3	10138363	2	D	E12	12,0	11,7	14,4	22,1	0,5	3	10	■
XSE450E12120D2R100Z3	10138364	2	D	E12	12,0	11,7	14,4	22,1	1,0	3	10	■
XSE450E16160D2R050Z3	10138365	2	D	E16	16,0	15,5	19,2	29,2	0,5	3	12	■
XSE450E16160D2R100Z3	10138366	2	D	E16	16,0	15,5	19,2	29,2	1,0	3	12	■
XSE450E20200D2R050Z3	10138367	2	D	E20	20,0	19,3	24,0	34,3	0,5	3	16	■
XSE450E20200D2R100Z3	10138369	2	D	E20	20,0	19,3	24,0	34,3	1,0	3	16	■

■ Stocked standard.

Universal

Steel and cast iron

Stainless steel and S-materials

Non ferrous

Hard

Plastic and CFRP

Graphite

X-Heads

Minimaster Plus

Minimaster

XSE450

High performance – Aluminium – Square – 3 Flutes – Corner radius – Inch

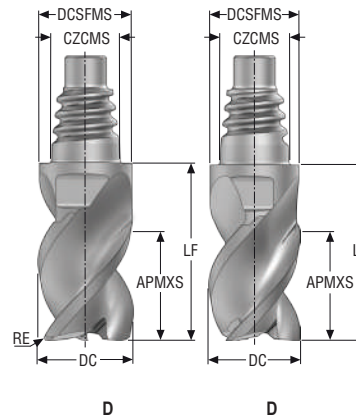

- Tolerances:
- DC= 0/- .002 Inch
- RE= ±.001 Inch
- Regrind possible if DC is ≥Ø.500 Inch

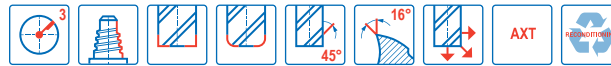

Designation	Item number	Length index	Tool shape	CZCMS	DC	DCSFMS	APMXS	LF	RE	PCEDC	SW	Grade
					Inch	Inch	Inch	Inch	Inch			AXT
XSE450E10.375D2SZ3	10138370	2	D	E10	0.375	0.364	0.450	0.720	–	3	8	■
XSE450E12.500D2SZ3	10138371	2	D	E12	0.500	0.484	0.600	0.906	–	3	10	■
XSE450E16.625D2SZ3	10138372	2	D	E16	0.625	0.610	0.750	1.150	–	3	12	■
XSE450E20.750D2SZ3	10138373	2	D	E20	0.750	0.728	0.900	1.295	–	3	16	■
XSE450E251.00D2SZ3	10138374	2	D	E25	1.000	0.965	1.200	1.673	–	3	20	■
XSE450E10.375D2R030Z3	10138375	2	D	E10	0.375	0.364	0.450	0.720	0.030	3	8	■
XSE450E12.500D2R030Z3	10138376	2	D	E12	0.500	0.484	0.600	0.906	0.030	3	10	■
XSE450E12.500D2R060Z3	10138377	2	D	E12	0.500	0.484	0.600	0.906	0.060	3	10	■
XSE450E16.625D2R030Z3	10138378	2	D	E16	0.625	0.610	0.750	1.150	0.030	3	12	■
XSE450E16.625D2R060Z3	10138379	2	D	E16	0.625	0.610	0.750	1.150	0.060	3	12	■
XSE450E16.625D2R120Z3	10138380	2	D	E16	0.625	0.610	0.750	1.150	0.120	3	12	■
XSE450E20.750D2R030Z3	10138381	2	D	E20	0.750	0.728	0.900	1.295	0.030	3	16	■
XSE450E20.750D2R060Z3	10138382	2	D	E20	0.750	0.728	0.900	1.295	0.060	3	16	■
XSE450E20.750D2R120Z3	10138383	2	D	E20	0.750	0.728	0.900	1.295	0.120	3	16	■
XSE450E251.00D2R030Z3	10138384	2	D	E25	1.000	0.965	1.200	1.673	0.030	3	20	■
XSE450E251.00D2R060Z3	10138385	2	D	E25	1.000	0.965	1.200	1.673	0.060	3	20	■
XSE450E251.00D2R120Z3	10138386	2	D	E25	1.000	0.965	1.200	1.673	0.120	3	20	■

■ Stocked standard.

Universal
Steel and cast iron
Stainless steel and S-materials
Non ferrous
Hard
Plastic and CFRP
Graphite
X-Heads
Minimaster Plus
Minimaster

Cutting data – XSE450 Side milling

SMG		a _e /DC	a _p /DC	f _z				v _c	
				10	12	16	20		
N1	E/M/A	0,40	1,1	0,15	0,18	0,22	0,26	0,30	405 (340 – 450) 1325 (1200 – 1400)
		0,40	1,1	0,0060	0,0070	0,0085	0,010	0,012	
N2	E/M/A	0,40	1,1	0,13	0,16	0,20	0,22	0,25	275 (230 – 330) 900 (760 – 1000)
		0,40	1,1	0,0050	0,0065	0,0080	0,0085	0,010	
N3	E/M/A	0,40	1,1	0,13	0,16	0,20	0,22	0,25	185 (150 – 220) 610 (500 – 720)
		0,40	1,1	0,0050	0,0065	0,0080	0,0085	0,010	
N11	E/M/A	0,40	1,1	0,13	0,16	0,20	0,22	0,25	245 (200 – 290) 800 (660 – 950)
		0,40	1,1	0,0050	0,0065	0,0080	0,0085	0,010	
TS1	A/D	0,40	1,1	0,15	0,18	0,22	0,26	0,30	280 (170 – 390) 920 (560 – 1200)
		0,40	1,1	0,0060	0,0070	0,0085	0,010	0,012	
TP1	A/D	0,40	1,1	0,15	0,18	0,22	0,26	0,30	280 (170 – 390) 920 (560 – 1200)
		0,40	1,1	0,0060	0,0070	0,0085	0,010	0,012	

Cutting data – XSE450 Slot milling

SMG		a _p /DC	f _z				v _c	
			10	12	16	20		
N1	E/M/A	0,90	0,10	0,12	0,16	0,20	0,25	360 (310 – 410) 1175 (1100 – 1300)
		0,90	0,0040	0,0048	0,0065	0,0080	0,010	
N2	E/M/A	0,90	0,080	0,095	0,13	0,16	0,20	250 (200 – 300) 820 (660 – 980)
		0,90	0,0032	0,0038	0,0050	0,0065	0,0080	
N3	E/M/A	0,90	0,080	0,095	0,13	0,16	0,20	165 (140 – 200) 540 (460 – 650)
		0,90	0,0032	0,0038	0,0050	0,0065	0,0080	
N11	E/M/A	0,90	0,080	0,095	0,13	0,16	0,20	220 (180 – 260) 720 (600 – 850)
		0,90	0,0032	0,0038	0,0050	0,0065	0,0080	
TS1	A/D	0,90	0,10	0,12	0,16	0,20	0,25	250 (150 – 340) 820 (500 – 1100)
		0,90	0,0040	0,0048	0,0065	0,0080	0,010	
TP1	A/D	0,90	0,10	0,12	0,16	0,20	0,25	250 (150 – 340) 820 (500 – 1100)
		0,90	0,0040	0,0048	0,0065	0,0080	0,010	

SMG = Seco material group
Coolant = A=air D=dry E=emulsion M=mist spray
v_c = m/min (sf/min)
f_z = mm (in/tooth)
a_p = mm/DC (in/DC) = factor
a_e = mm/DC (in/DC) = factor
All cutting data are target values

Universal
Steel and cast iron
Stainless steel and S-materials
Non ferrous
Hard
Plastic and CFRP
Graphite
X-Heads
Minimaster Plus
Minimaster

Cutting data – XSE450 Side milling inch

SMG		a _e /DC	a _p /DC	f _z					v _c
				3/8	1/2	5/8	3/4	1	
N1	E/M/A	0,40	1,1	0,15	0,18	0,22	0,26	0,30	560 (450 – 670)
		0,40	1,1	0,0060	0,0070	0,0085	0,010	0,012	1825 (1500 – 2100)
N2	E/M/A	0,40	1,1	0,13	0,16	0,20	0,22	0,25	445 (340 – 550)
		0,40	1,1	0,0050	0,0065	0,0080	0,0085	0,010	1450 (1200 – 1800)
N3	E/M/A	0,40	1,1	0,13	0,16	0,20	0,22	0,25	295 (230 – 360)
		0,40	1,1	0,0050	0,0065	0,0080	0,0085	0,010	970 (760 – 1100)
N11	E/M/A	0,40	1,1	0,13	0,16	0,20	0,22	0,25	395 (300 – 490)
		0,40	1,1	0,0050	0,0065	0,0080	0,0085	0,010	1300 (990 – 1600)
TS1	A/D	0,40	1,1	0,15	0,18	0,22	0,26	0,30	280 (170 – 390)
		0,40	1,1	0,0060	0,0070	0,0085	0,010	0,012	920 (560 – 1200)
TP1	A/D	0,40	1,1	0,15	0,18	0,22	0,26	0,30	280 (170 – 390)
		0,40	1,1	0,0060	0,0070	0,0085	0,010	0,012	920 (560 – 1200)

Cutting data – XSE450 Slot milling inch

SMG		a _p /DC	f _z					v _c
			3/8	1/2	5/8	3/4	1	
N1	E/M/A	1,1	0,10	0,12	0,16	0,20	0,25	500 (400 – 590)
		1,1	0,0040	0,0048	0,0065	0,0080	0,010	1650 (1400 – 1900)
N2	E/M/A	1,1	0,080	0,095	0,13	0,16	0,20	400 (300 – 490)
		1,1	0,0032	0,0038	0,0050	0,0065	0,0080	1300 (990 – 1600)
N3	E/M/A	1,1	0,080	0,095	0,13	0,16	0,20	265 (200 – 330)
		1,1	0,0032	0,0038	0,0050	0,0065	0,0080	870 (660 – 1000)
N11	E/M/A	1,1	0,080	0,095	0,13	0,16	0,20	355 (270 – 440)
		1,1	0,0032	0,0038	0,0050	0,0065	0,0080	1175 (890 – 1400)
TS1	A/D	1,1	0,10	0,12	0,16	0,20	0,25	250 (150 – 340)
		1,1	0,0040	0,0048	0,0065	0,0080	0,010	820 (500 – 1100)
TP1	A/D	1,1	0,10	0,12	0,16	0,20	0,25	250 (150 – 340)
		1,1	0,0040	0,0048	0,0065	0,0080	0,010	820 (500 – 1100)

SMG = Seco material group
 Coolant = A=air D=dry E=emulsion M=mist spray
 v_c = m/min (sf/min)
 f_z = mm (in/tooth)
 a_p = mm/DC (in/DC) = factor
 a_e = mm/DC (in/DC) = factor
 All cutting data are target values

XHT740

High speed – ISO– M and ISO– S - Taper Shape – 4-6 Flutes

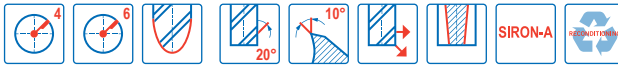
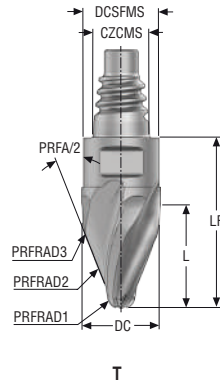

- Tolerances:
- PRFRAD1= ±0,03 mm
- Form tolerance PRFRAD2= 0,02 mm
- Regrind possible if DC is ≥Ø12 mm is ≥Ø12 mm and PRFRAD1 is ≥1,5 mm

Designation	Item number	Length index	Tool shape	CZCMS	DC	DCSFMS	L	LF	PRFRAD1	PRFRAD2	PRFRAD3	PRFA/2°	PCEDC	SW	Grade
					mm	mm	mm	mm	mm	mm	mm				SIRA
XHT740E10100T2R1.5R250Z4	10138388	2	T	E10	10,0	9,7	5,4	18,7	1,5	250,0	2,0	65,0	4	8	■
XHT740E12120T2R3R250Z4	10138389	2	T	E12	12,0	11,7	10,5	22,1	3,0	250,0	6,0	32,5	4	10	■
XHT740E16160T2R4R500Z4	10138390	2	T	E16	16,0	15,5	14,6	29,2	4,0	500,0	8,0	27,5	4	12	■
XHT740E10100T3R2R250Z4	10138391	3	T	E10	10,0	9,7	12,7	21,8	2,0	250,0	5,0	20,0	4	8	■
XHT740E12120T3R3R250Z4	10138392	3	T	E12	12,0	11,7	13,7	25,9	3,0	250,0	6,0	20,0	4	10	■
XHT740E16160T3R4R1000Z4	10138394	3	T	E16	16,0	15,5	24,0	34,1	4,0	1000,0	5,0	20,0	4	12	■
XHT740E16160T3R4R500Z4	10138393	3	T	E16	16,0	15,5	17,6	34,1	4,0	500,0	8,0	20,0	4	12	■
XHT740E10100T3R2R250Z6	10138395	3	T	E10	10,0	9,7	12,7	21,8	2,0	250,0	5,0	20,0	6	8	■
XHT740E12120T3R3R250Z6	10138396	3	T	E12	12,0	11,7	13,7	25,9	3,0	250,0	6,0	20,0	6	10	■
XHT740E16160T3R4R500Z6	10138397	3	T	E16	16,0	15,5	17,6	34,1	4,0	500,0	8,0	20,0	6	12	■

■ Stocked standard.

Universal

Steel and cast iron

Stainless steel and S-materials

Non ferrous

Hard

Plastic and CFRP

Graphite

X-Heads

Minimaster Plus

Minimaster

Cutting data – XHT740 – Copy milling PCEDC 4

SMG		a _p /DC	f _z			v _c
			10	12	16	
P8	E/M/A/D	0,010	0,05	0,06	0,08	170 (150 - 195)
		0.010	0.0022	0.0024	0.0032	560 (490 - 640)
P12	E/M/A/D	0,010	0,05	0,06	0,08	120 (95 - 135)
		0.010	0.0022	0.0024	0.0032	400 (310 - 445)
M1	E/M/A	0,010	0,05	0,06	0,08	150 (125 - 155)
		0.010	0.0022	0.0024	0.0032	490 (410 - 510)
M2	E/M/A	0,010	0,05	0,06	0,08	145 (120 - 150)
		0.010	0.0022	0.0024	0.0032	475 (400 - 490)
M3	E/M/A	0,010	0,05	0,06	0,08	130 (90 - 140)
		0.010	0.0022	0.0024	0.0032	425 (295 - 460)
S2	E	0,010	0,05	0,06	0,08	60 (50 - 70)
		0.010	0.0022	0.0024	0.0032	195 (165 - 230)
S11	E	0,010	0,05	0,06	0,08	100 (85 - 105)
		0.010	0.0022	0.0024	0.0032	320 (280 - 345)
S12	E	0,010	0,05	0,06	0,08	95 (80 - 100)
		0.010	0.0022	0.0024	0.0032	310 (260 - 320)
S13	E	0,010	0,05	0,06	0,08	90 (75 - 95)
		0.010	0.0022	0.0024	0.0032	295 (245 - 310)

Cutting data – XHT740 – Copy milling PCEDC 6

SMG		a _p /DC	f _z			v _c
			10	12	16	
P8	E/M/A/D	0,010	0,05	0,06	0,08	170 (150 - 195)
		0.010	0.0022	0.0024	0.0032	560 (490 - 640)
P12	E/M/A/D	0,010	0,05	0,06	0,08	120 (95 - 135)
		0.010	0.0022	0.0024	0.0032	400 (310 - 445)
M1	E/M/A	0,010	0,05	0,06	0,08	150 (125 - 155)
		0.010	0.0022	0.0024	0.0032	490 (410 - 510)
M2	E/M/A	0,010	0,05	0,06	0,08	145 (120 - 150)
		0.010	0.0022	0.0024	0.0032	475 (400 - 490)
M3	E/M/A	0,010	0,05	0,06	0,08	130 (90 - 140)
		0.010	0.0022	0.0024	0.0032	425 (295 - 460)
S2	E	0,010	0,05	0,06	0,08	60 (50 - 70)
		0.010	0.0022	0.0024	0.0032	195 (165 - 230)
S11	E	0,010	0,05	0,06	0,08	100 (85 - 105)
		0.010	0.0022	0.0024	0.0032	320 (280 - 345)
S12	E	0,010	0,05	0,06	0,08	95 (80 - 100)
		0.010	0.0022	0.0024	0.0032	310 (260 - 320)
S13	E	0,010	0,05	0,06	0,08	90 (75 - 95)
		0.010	0.0022	0.0024	0.0032	295 (245 - 310)

SMG = Seco material group
Coolant = A=air D=dry E=emulsion M=mist spray
v_c = m/min (sf/min)
f_z = mm (in/tooth)
a_p = mm/DC (in/DC) = factor
a_e = mm/DC (in/DC) = factor
All cutting data are target values

XHF580

High feed – Universal – 4 Flutes – Corner radius – ICC

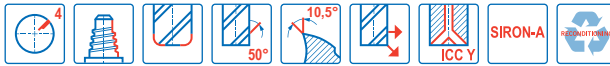
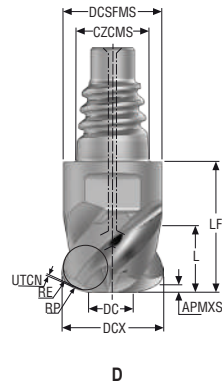

- Tolerances:
- DCX= h9
- RE= ±0,03 mm
- Regrind possible if DCX is ≥Ø12 mm

Designation	Item number	Length index	Tool shape	CSP	CZCMS	DCX	DC	DCSFMS	APMXS	L	LF	RE	RP	UTCN	PCEDC	SW	Grades
						mm	mm	mm	mm	mm	mm	mm	mm	mm			SIRA
XHF580E10100D1HZ4A	10137971	1	D	✓	E10	10,0	3,4	9,7	0,7	6,0	12,4	1,5	1,99	0,27	4	8	■
XHF580E12120D1HZ4A	10137972	1	D	✓	E12	12,0	4,5	11,7	0,8	7,5	14,5	1,5	2,1	0,323	4	10	■
XHF580E16160D1HZ4A	10137973	1	D	✓	E16	16,0	6,2	15,5	1,0	10,0	18,7	2,0	2,747	0,426	4	12	■

■ Stocked standard.

- Universal
- Steel and cast iron
- Stainless steel and S-materials
- Non ferrous
- Hard
- Plastic and CFRP
- Graphite
- X-Heads
- Minimaster Plus
- Minimaster

XHF580

High feed – Universal – 4 Flutes – Corner radius – ICC – Inch

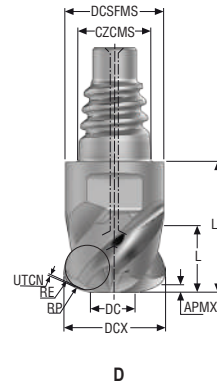

- Tolerances:
- DCX= h9
- RE= ±.0012 Inch
- Regrind possible if DCX is ≥Ø.500 Inch

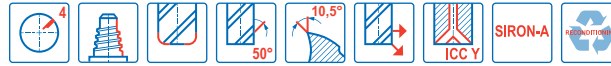

Designation	Item number	Length index	Tool shape	CSP	CZCMS	DCX	DC	DCSFMS	APMXS	L	LF	RE	RP	UTCN	PCEDC	SW	Grades
						<i>Inch</i>	<i>Inch</i>	<i>Inch</i>	<i>Inch</i>	<i>Inch</i>	<i>Inch</i>	<i>Inch</i>	<i>Inch</i>	<i>Inch</i>			SIRA
XHF580E10.375D1HZ4A	10137974	1	D	✓	E10	0.375	0.134	0.364	0.024	0.236	0.488	0.060	0.076	0.008	4	8	■
XHF580E12.500D1HZ4A	10137975	1	D	✓	E12	0.500	0.197	0.484	0.033	0.315	0.571	0.060	0.086	0.014	4	10	■
XHF580E16.625D1HZ4A	10137976	1	D	✓	E16	0.614	0.236	0.610	0.039	0.394	0.736	0.080	0.110	0.016	4	12	■

■ Stocked standard.

Universal
Steel and cast iron
Stainless steel and S-materials
Non ferrous
Hard
Plastic and CFRP
Graphite
X-Heads
Minimaster Plus
Minimaster

Cutting data – XHF580 Side milling

SMG		a _e /DCX	a _p /DCX	f _z			v _c
				10	12	16	
P1	E/M/A/D	0,30	0,060	0,50	0,60	0,80	350 (330 – 400)
		0,30	0,060	0,020	0,024	0,032	1150 (1100 – 1300)
P2	E/M/A/D	0,30	0,060	0,50	0,60	0,80	340 (320 – 390)
		0,30	0,060	0,020	0,024	0,032	1125 (1100 – 1200)
P3	E/M/A/D	0,30	0,060	0,50	0,60	0,80	295 (280 – 340)
		0,30	0,060	0,020	0,024	0,032	970 (920 – 1100)
P4	E/M/A/D	0,30	0,060	0,50	0,60	0,80	260 (250 – 300)
		0,30	0,060	0,020	0,024	0,032	850 (830 – 980)
P5	E/M/A/D	0,30	0,060	0,50	0,60	0,80	260 (250 – 300)
		0,30	0,060	0,020	0,024	0,032	850 (830 – 980)
P6	E/M/A/D	0,30	0,060	0,50	0,60	0,80	190 (180 – 230)
		0,30	0,060	0,020	0,024	0,032	620 (600 – 750)
P7	E/M/A/D	0,30	0,060	0,50	0,60	0,80	180 (170 – 220)
		0,30	0,060	0,020	0,024	0,032	590 (560 – 720)
P8	E/M/A/D	0,30	0,060	0,50	0,60	0,80	170 (160 – 200)
		0,30	0,060	0,020	0,024	0,032	560 (530 – 650)
P11	E/M/A/D	0,30	0,060	0,40	0,48	0,65	145 (150 – 170)
		0,30	0,060	0,016	0,019	0,026	475 (500 – 550)
P12	E/M/A/D	0,30	0,060	0,40	0,48	0,65	85 (83 – 100)
		0,30	0,060	0,016	0,019	0,026	280 (280 – 320)
M1	E/M/A	0,30	0,060	0,40	0,48	0,65	170 (170 – 200)
		0,30	0,060	0,016	0,019	0,026	560 (560 – 650)
M2	E/M/A	0,30	0,060	0,40	0,48	0,65	140 (140 – 160)
		0,30	0,060	0,016	0,019	0,026	460 (460 – 520)
M3	E/M/A	0,30	0,060	0,40	0,48	0,65	105 (97 – 130)
		0,30	0,060	0,016	0,019	0,026	345 (320 – 420)
M4	E/M/A	0,30	0,060	0,40	0,48	0,65	75 (73 – 99)
		0,30	0,060	0,016	0,019	0,026	245 (240 – 320)
M5	E/M/A	0,30	0,060	0,40	0,48	0,65	65 (61 – 83)
		0,30	0,060	0,016	0,019	0,026	215 (210 – 270)
K1	E/M/A/D	0,30	0,060	0,50	0,60	0,80	345 (330 – 400)
		0,30	0,060	0,020	0,024	0,032	1125 (1100 – 1300)
K2	E/M/A/D	0,30	0,060	0,50	0,60	0,80	300 (280 – 340)
		0,30	0,060	0,020	0,024	0,032	980 (920 – 1100)
K3	E/M/A/D	0,30	0,060	0,50	0,60	0,80	250 (240 – 290)
		0,30	0,060	0,020	0,024	0,032	820 (790 – 950)
K4	E/M/A/D	0,30	0,060	0,50	0,60	0,80	240 (230 – 280)
		0,30	0,060	0,020	0,024	0,032	790 (760 – 910)
K5	E/M/A/D	0,30	0,060	0,50	0,60	0,80	145 (140 – 160)
		0,30	0,060	0,020	0,024	0,032	475 (460 – 520)
K6	E/M/A/D	0,30	0,060	0,50	0,60	0,80	210 (200 – 240)
		0,30	0,060	0,020	0,024	0,032	690 (660 – 780)
K7	E/M/A/D	0,30	0,060	0,50	0,60	0,80	185 (180 – 210)
		0,30	0,060	0,020	0,024	0,032	610 (600 – 680)
S1	E	0,30	0,034	0,24	0,28	0,38	45 (36 – 71)
		0,30	0,034	0,0095	0,011	0,015	150 (120 – 230)
S2	E	0,30	0,034	0,24	0,28	0,38	36 (29 – 57)
		0,30	0,034	0,0095	0,011	0,015	120 (96 – 180)
S3	E	0,30	0,034	0,24	0,28	0,38	31 (25 – 49)
		0,30	0,034	0,0095	0,011	0,015	100 (83 – 160)
S11	E	0,30	0,060	0,36	0,42	0,55	160 (160 – 190)
		0,30	0,060	0,014	0,017	0,022	520 (530 – 620)
S12	E	0,30	0,060	0,36	0,42	0,55	125 (120 – 150)
		0,30	0,060	0,014	0,017	0,022	410 (400 – 490)
S13	E	0,30	0,060	0,36	0,42	0,55	95 (91 – 110)
		0,30	0,060	0,014	0,017	0,022	310 (300 – 360)
H5	M/A	0,30	0,060	0,40	0,48	0,65	105 (98 – 130)
		0,30	0,060	0,016	0,019	0,026	345 (330 – 420)
H8	M/A	0,30	0,060	0,40	0,48	0,65	105 (98 – 130)
		0,30	0,060	0,016	0,019	0,026	345 (330 – 420)
H21	M/A	0,30	0,060	0,40	0,48	0,65	105 (98 – 130)
		0,30	0,060	0,016	0,019	0,026	345 (330 – 420)
H31	M/A	0,30	0,060	0,40	0,48	0,65	80 (74 – 100)
		0,30	0,060	0,016	0,019	0,026	260 (250 – 320)

SMG = Seco material group
 Coolant = A=air D=dry E=emulsion M=mist spray
 v_c = m/min (sf/min)
 f_z = mm (in/tooth)
 a_p = mm/DC (in/DC) = factor
 a_e = mm/DC (in/DC) = factor
 All cutting data are target values

Universal
 Steel and cast iron
 Stainless steel and S-materials
 Non ferrous
 Hard
 Plastic and cfrp
 Graphite
 X-Heads
 Minmaster Plus
 Minmaster

Cutting data – XHF580 Slot milling

SMG		a _p /DCX	f _z			v _c
			10	12	16	
P1-P6	E/M/A/D	0,060	0,30	0,36	0,48	320 (300 – 360)
		0,060	0,012	0,014	0,019	1050 (990 – 1100)
	E/M/A/D	0,060	0,30	0,36	0,48	310 (290 – 350)
		0,060	0,012	0,014	0,019	1025 (960 – 1100)
	E/M/A/D	0,060	0,30	0,36	0,48	265 (250 – 300)
		0,060	0,012	0,014	0,019	870 (830 – 980)
	E/M/A/D	0,060	0,30	0,36	0,48	235 (220 – 270)
		0,060	0,012	0,014	0,019	770 (730 – 880)
	E/M/A/D	0,060	0,30	0,36	0,48	235 (220 – 270)
		0,060	0,012	0,014	0,019	770 (730 – 880)
	E/M/A/D	0,060	0,30	0,36	0,48	175 (160 – 210)
		0,060	0,012	0,014	0,019	570 (530 – 680)
E/M/A/D	0,060	0,30	0,36	0,48	165 (150 – 200)	
	0,060	0,012	0,014	0,019	540 (500 – 650)	
E/M/A/D	0,060	0,30	0,36	0,48	155 (150 – 180)	
	0,060	0,012	0,014	0,019	510 (500 – 590)	
E/M/A/D	0,060	0,24	0,28	0,38	130 (130 – 160)	
	0,060	0,0095	0,011	0,015	425 (430 – 520)	
E/M/A/D	0,060	0,24	0,28	0,38	80 (75 – 94)	
	0,060	0,0095	0,011	0,015	260 (250 – 300)	
M1-M5	E/M/A	0,060	0,24	0,28	0,38	155 (150 – 180)
		0,060	0,0095	0,011	0,015	510 (500 – 590)
	E/M/A	0,060	0,24	0,28	0,38	125 (120 – 150)
		0,060	0,0095	0,011	0,015	410 (400 – 490)
	E/M/A	0,060	0,24	0,28	0,38	95 (88 – 110)
0,060	0,0095	0,011	0,015	310 (290 – 360)		
K1-K7	E/M/A	0,060	0,24	0,28	0,38	70 (66 – 89)
		0,060	0,0095	0,011	0,015	230 (220 – 290)
	E/M/A	0,060	0,24	0,28	0,38	60 (55 – 74)
		0,060	0,0095	0,011	0,015	195 (190 – 240)
	E/M/A/D	0,060	0,30	0,36	0,48	310 (300 – 360)
0,060		0,012	0,014	0,019	1025 (990 – 1100)	
S1-S13	E/M/A/D	0,060	0,30	0,36	0,48	270 (260 – 310)
		0,060	0,012	0,014	0,019	890 (860 – 1000)
	E/M/A/D	0,060	0,30	0,36	0,48	230 (220 – 260)
		0,060	0,012	0,014	0,019	750 (730 – 850)
	E/M/A/D	0,060	0,30	0,36	0,48	220 (210 – 250)
		0,060	0,012	0,014	0,019	720 (690 – 820)
	E/M/A/D	0,060	0,30	0,36	0,48	130 (130 – 150)
0,060		0,012	0,014	0,019	425 (430 – 490)	
H1-H31	E/M/A/D	0,060	0,30	0,36	0,48	190 (180 – 220)
		0,060	0,012	0,014	0,019	620 (600 – 720)
	E/M/A/D	0,060	0,30	0,36	0,48	165 (160 – 190)
		0,060	0,012	0,014	0,019	540 (530 – 620)
	E	0,034	0,18	0,22	0,28	39 (32 – 62)
		0,034	0,0070	0,0085	0,011	130 (110 – 200)
	E	0,034	0,18	0,22	0,28	31 (26 – 50)
0,034		0,0070	0,0085	0,011	100 (86 – 160)	
E	0,034	0,18	0,22	0,28	27 (22 – 43)	
	0,034	0,0070	0,0085	0,011	90 (73 – 140)	
S11-S13	E	0,060	0,18	0,22	0,28	150 (150 – 180)
		0,060	0,0070	0,0085	0,011	490 (500 – 590)
	E	0,060	0,18	0,22	0,28	115 (110 – 140)
H5-H8	E	0,060	0,18	0,22	0,28	375 (370 – 450)
		0,060	0,0070	0,0085	0,011	90 (85 – 100)
	E	0,060	0,18	0,22	0,28	295 (280 – 320)
H5-H8	M/A	0,060	0,24	0,28	0,38	95 (88 – 120)
		0,060	0,0095	0,011	0,015	310 (290 – 390)
	M/A	0,060	0,24	0,28	0,38	95 (88 – 120)
H21-H31	M/A	0,060	0,24	0,28	0,38	95 (88 – 120)
		0,060	0,0095	0,011	0,015	310 (290 – 390)
	M/A	0,060	0,24	0,28	0,38	70 (67 – 91)
		0,060	0,0095	0,011	0,015	230 (220 – 290)

SMG = Seco material group
Coolant = A=air D=dry E=emulsion M=mist spray
v_c = m/min (sf/min)
f_z = mm (in/tooth)
a_p = mm/DC (in/DC) = factor
a_s = mm/DC (in/DC) = factor
All cutting data are target values

Cutting data – XHF580 Side milling inch

SMG		a _e /DCX	a _p /DCX	f _z			v _c
				3/8	1/2	5/8	
P1	E/M/A/D	0,30	0,060	0,50	0,60	0,80	485 (440 – 530)
		0,30	0,060	0,020	0,024	0,032	1600 (1500 – 1700)
P2	E/M/A/D	0,30	0,060	0,50	0,60	0,80	475 (430 – 520)
		0,30	0,060	0,020	0,024	0,032	1550 (1500 – 1700)
P3	E/M/A/D	0,30	0,060	0,50	0,60	0,80	405 (370 – 450)
		0,30	0,060	0,020	0,024	0,032	1325 (1300 – 1400)
P4	E/M/A/D	0,30	0,060	0,50	0,60	0,80	360 (320 – 390)
		0,30	0,060	0,020	0,024	0,032	1175 (1100 – 1200)
P5	E/M/A/D	0,34	0,060	0,50	0,60	0,80	260 (240 – 290)
		0,34	0,060	0,020	0,024	0,032	850 (790 – 950)
P6	E/M/A/D	0,34	0,060	0,50	0,60	0,80	295 (270 – 320)
		0,34	0,060	0,020	0,024	0,032	970 (890 – 1000)
P7	E/M/A/D	0,34	0,060	0,50	0,60	0,80	280 (250 – 300)
		0,34	0,060	0,020	0,024	0,032	920 (830 – 980)
P8	E/M/A/D	0,34	0,060	0,50	0,60	0,80	260 (240 – 290)
		0,34	0,060	0,020	0,024	0,032	850 (790 – 950)
P11	E/M/A/D	0,30	0,055	0,40	0,48	0,65	160 (140 – 170)
		0,30	0,055	0,016	0,019	0,026	520 (460 – 550)
P12	E/M/A/D	0,30	0,055	0,40	0,48	0,65	95 (83 – 100)
		0,30	0,055	0,016	0,019	0,026	310 (280 – 320)
M1	E/M/A	0,30	0,055	0,40	0,48	0,65	185 (170 – 200)
		0,30	0,055	0,016	0,019	0,026	610 (560 – 650)
M2	E/M/A	0,30	0,055	0,40	0,48	0,65	150 (140 – 160)
		0,30	0,055	0,016	0,019	0,026	490 (460 – 520)
M3	E/M/A	0,30	0,055	0,40	0,48	0,65	115 (97 – 130)
		0,30	0,055	0,016	0,019	0,026	375 (320 – 420)
M4	E/M/A	0,30	0,055	0,40	0,48	0,65	85 (73 – 99)
		0,30	0,055	0,016	0,019	0,026	280 (240 – 320)
M5	E/M/A	0,30	0,055	0,40	0,48	0,65	70 (61 – 82)
		0,30	0,055	0,016	0,019	0,026	230 (210 – 260)
K1	E/M/A/D	0,30	0,060	0,50	0,60	0,80	475 (430 – 520)
		0,30	0,060	0,020	0,024	0,032	1550 (1500 – 1700)
K2	E/M/A/D	0,30	0,060	0,50	0,60	0,80	415 (370 – 450)
		0,30	0,060	0,020	0,024	0,032	1350 (1300 – 1400)
K3	E/M/A/D	0,30	0,060	0,50	0,60	0,80	350 (320 – 380)
		0,30	0,060	0,020	0,024	0,032	1150 (1100 – 1200)
K4	E/M/A/D	0,30	0,060	0,50	0,60	0,80	335 (300 – 370)
		0,30	0,060	0,020	0,024	0,032	1100 (990 – 1200)
K5	E/M/A/D	0,30	0,060	0,50	0,60	0,80	200 (180 – 220)
		0,30	0,060	0,020	0,024	0,032	660 (600 – 720)
K6	E/M/A/D	0,30	0,060	0,50	0,60	0,80	295 (270 – 320)
		0,30	0,060	0,020	0,024	0,032	970 (890 – 1000)
K7	E/M/A/D	0,30	0,060	0,50	0,60	0,80	255 (230 – 280)
		0,30	0,060	0,020	0,024	0,032	840 (760 – 910)
S1	E	0,30	0,034	0,24	0,28	0,38	55 (36 – 71)
		0,30	0,034	0,0095	0,011	0,015	180 (120 – 230)
S2	E	0,30	0,034	0,24	0,28	0,38	43 (29 – 57)
		0,30	0,034	0,0095	0,011	0,015	140 (96 – 180)
S3	E	0,30	0,034	0,24	0,28	0,38	37 (25 – 49)
		0,30	0,034	0,0095	0,011	0,015	120 (83 – 160)
S11	E	0,30	0,034	0,36	0,42	0,55	170 (150 – 190)
		0,30	0,034	0,014	0,017	0,022	560 (500 – 620)
S12	E	0,30	0,034	0,36	0,42	0,55	130 (120 – 140)
		0,30	0,034	0,014	0,017	0,022	425 (400 – 450)
S13	E	0,30	0,034	0,36	0,42	0,55	100 (89 – 110)
		0,30	0,034	0,014	0,017	0,022	330 (300 – 360)
H5	M/A	0,30	0,060	0,40	0,48	0,65	115 (98 – 130)
		0,30	0,060	0,016	0,019	0,026	375 (330 – 420)
H8	M/A	0,30	0,060	0,40	0,48	0,65	115 (98 – 130)
		0,30	0,060	0,016	0,019	0,026	375 (330 – 420)
H21	M/A	0,30	0,060	0,40	0,48	0,65	115 (98 – 130)
		0,30	0,060	0,016	0,019	0,026	375 (330 – 420)
H31	M/A	0,30	0,060	0,40	0,48	0,65	90 (74 – 100)
		0,30	0,060	0,016	0,019	0,026	295 (250 – 320)

SMG = Seco material group
 Coolant = A=air D=dry E=emulsion M=mist spray
 v_c = m/min (sf/min)
 f_z = mm (in/tooth)
 a_p = mm/DC (in/DC) = factor
 a_e = mm/DC (in/DC) = factor
 All cutting data are target values

Universal
 Steel and cast iron
 Stainless steel and S-materials
 Non ferrous
 Hard
 Plastic and cfrp
 Graphite
 X-Heads
 Minmaster Plus
 Minmaster

Cutting data – XHF580 Slot milling inch

SMG		a _p /DCX	f _z			v _c
			3/8	1/2	5/8	
P1	E/M/A/D	0,060	0,30	0,36	0,48	440 (400 – 480)
		0.060	0.012	0.014	0.019	1450 (1400 – 1500)
P2	E/M/A/D	0,060	0,30	0,36	0,48	430 (390 – 470)
		0.060	0.012	0.014	0.019	1400 (1300 – 1500)
P3	E/M/A/D	0,060	0,30	0,36	0,48	370 (330 – 400)
		0.060	0.012	0.014	0.019	1225 (1100 – 1300)
P4	E/M/A/D	0,060	0,30	0,36	0,48	325 (290 – 360)
		0.060	0.012	0.014	0.019	1075 (960 – 1100)
P5	E/M/A/D	0,060	0,30	0,36	0,48	245 (220 – 270)
		0.060	0.012	0.014	0.019	800 (730 – 880)
P6	E/M/A/D	0,060	0,30	0,36	0,48	275 (250 – 300)
		0.060	0.012	0.014	0.019	900 (830 – 980)
P7	E/M/A/D	0,060	0,30	0,36	0,48	260 (240 – 280)
		0.060	0.012	0.014	0.019	850 (790 – 910)
P8	E/M/A/D	0,060	0,30	0,36	0,48	245 (220 – 270)
		0.060	0.012	0.014	0.019	800 (730 – 880)
P11	E/M/A/D	0,055	0,24	0,28	0,38	145 (130 – 160)
		0.055	0.0095	0.011	0.015	475 (430 – 520)
P12	E/M/A/D	0,055	0,24	0,28	0,38	85 (75 – 94)
		0.055	0.0095	0.011	0.015	280 (250 – 300)
M1	E/M/A	0,055	0,24	0,28	0,38	170 (150 – 180)
		0.055	0.0095	0.011	0.015	560 (500 – 590)
M2	E/M/A	0,055	0,24	0,28	0,38	135 (120 – 150)
		0.055	0.0095	0.011	0.015	445 (400 – 490)
M3	E/M/A	0,055	0,24	0,28	0,38	105 (88 – 110)
		0.055	0.0095	0.011	0.015	345 (290 – 360)
M4	E/M/A	0,055	0,24	0,28	0,38	80 (66 – 89)
		0.055	0.0095	0.011	0.015	260 (220 – 290)
M5	E/M/A	0,055	0,24	0,28	0,38	65 (55 – 74)
		0.055	0.0095	0.011	0.015	215 (190 – 240)
K1	E/M/A/D	0,060	0,30	0,36	0,48	430 (390 – 480)
		0.060	0.012	0.014	0.019	1400 (1300 – 1500)
K2	E/M/A/D	0,060	0,30	0,36	0,48	375 (340 – 410)
		0.060	0.012	0.014	0.019	1225 (1200 – 1300)
K3	E/M/A/D	0,060	0,30	0,36	0,48	315 (290 – 350)
		0.060	0.012	0.014	0.019	1025 (960 – 1100)
K4	E/M/A/D	0,060	0,30	0,36	0,48	305 (270 – 330)
		0.060	0.012	0.014	0.019	1000 (890 – 1000)
K5	E/M/A/D	0,060	0,30	0,36	0,48	180 (170 – 200)
		0.060	0.012	0.014	0.019	590 (560 – 650)
K6	E/M/A/D	0,060	0,30	0,36	0,48	265 (240 – 290)
		0.060	0.012	0.014	0.019	870 (790 – 950)
K7	E/M/A/D	0,060	0,30	0,36	0,48	230 (210 – 250)
		0.060	0.012	0.014	0.019	750 (690 – 820)
S1	E	0,034	0,18	0,22	0,28	47 (32 – 62)
		0.034	0.0070	0.0085	0.011	155 (110 – 200)
S2	E	0,034	0,18	0,22	0,28	38 (26 – 50)
		0.034	0.0070	0.0085	0.011	125 (86 – 160)
S3	E	0,034	0,18	0,22	0,28	32 (22 – 43)
		0.034	0.0070	0.0085	0.011	105 (73 – 140)
S11	E	0,034	0,18	0,22	0,28	160 (150 – 180)
		0.034	0.0070	0.0085	0.011	520 (500 – 590)
S12	E	0,034	0,18	0,22	0,28	125 (110 – 140)
		0.034	0.0070	0.0085	0.011	410 (370 – 450)
S13	E	0,034	0,18	0,22	0,28	95 (84 – 100)
		0.034	0.0070	0.0085	0.011	310 (280 – 320)
H5	M/A	0,060	0,24	0,28	0,38	105 (88 – 120)
		0.060	0.0095	0.011	0.015	345 (290 – 390)
H8	M/A	0,060	0,24	0,28	0,38	105 (88 – 120)
		0.060	0.0095	0.011	0.015	345 (290 – 390)
H21	M/A	0,060	0,24	0,28	0,38	105 (88 – 120)
		0.060	0.0095	0.011	0.015	345 (290 – 390)
H31	M/A	0,060	0,24	0,28	0,38	80 (67 – 91)
		0.060	0.0095	0.011	0.015	260 (220 – 290)

SMG = Seco material group
Coolant = A=air D=dry E=emulsion M=mist spray
v_c = m/min (sf/min)
f_z = mm (in/tooth)
a_p = mm/DC (in/DC) = factor
a_s = mm/DC (in/DC) = factor
All cutting data are target values

XHF780

High feed – ISO– M and ISO– S – 3 Flutes – Corner radius

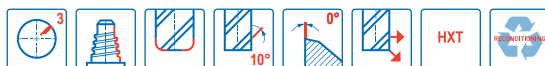
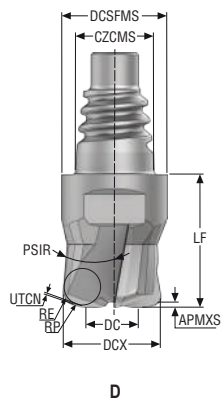

- Tolerances:
- DCX= -0,02/-0,04 mm
- RE= ±0,05 mm
- Regrind possible if DCX is ≥Ø12 mm

Designation	Item number	Length index	Tool shape	CZCMS	DCX	DC	DCSFMS	APMXS	LF	RE	RP	UTCN	PSIR°	PCEDC	SW	Grades
					mm	mm	mm	mm	mm	mm	mm	mm				HXT
XHF780E10100D1HZ3	10137957	1	D	E10	10,0	5,0	9,7	0,45	12,3	0,8	1,175	0,232	-5,0	3	8	■
XHF780E12120D1HZ3	10137958	1	D	E12	12,0	6,0	11,7	0,5	14,4	1,0	1,416	0,262	-5,0	3	10	■
XHF780E16160D1HZ3	10137959	1	D	E16	16,0	8,0	15,5	0,6	18,6	1,5	1,989	0,32	-5,0	3	12	■

■ Stocked standard.

Universal

Steel and cast iron

Stainless steel and S-materials

Non ferrous

Hard

Plastic and CFRP

Graphite

X-Heads

Minimaster Plus

Minimaster

XHF780

High feed – ISO– M and ISO– S – 3 Flutes – Corner radius – Inch

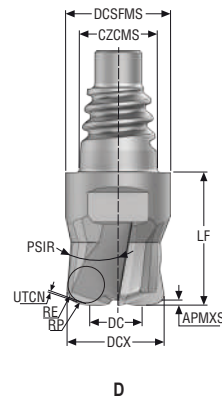

- Tolerances:
- DCX= -.0008/-0.0016 Inch
- RE= ±.002 Inch
- Regrind possible if DCX is ≥Ø.500 Inch

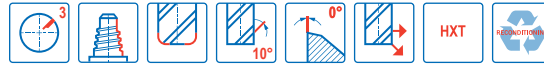

Designation	Item number	Length index	Tool shape	CZCMS	DCX	DC	DCSFMS	APMXS	LF	RE	RP	UTCN	PSIR°	PCEDC	SW	Grades
					<i>Inch</i>	<i>Inch</i>	<i>Inch</i>	<i>Inch</i>	<i>Inch</i>	<i>Inch</i>	<i>Inch</i>	<i>Inch</i>				HXT
XHF780E10.375D1HZ3	10137960	1	D	E10	0.375	0.188	0.364	0.018	0.484	0.028	0.043	0.009	-5,0	3	8	■
XHF780E12.500D1HZ3	10137961	1	D	E12	0.461	0.250	0.484	0.020	0.567	0.045	0.061	0.010	-5,0	3	10	■
XHF780E16.625D1HZ3	10137962	1	D	E16	0.625	0.313	0.610	0.024	0.732	0.061	0.080	0.012	-5,0	3	12	■

■ Stocked standard.

Universal
Steel and cast iron
Stainless steel and S-materials
Non ferrous
Hard
Plastic and CFRP
Graphite
X-Heads
Minimaster Plus
Minimaster

Cutting data – XHF780 Side milling

SMG		a _e /DCX	a _p /DCX	f _z			v _c
				10	12	16	
P1	E/M/A/D	0,30	0,040	0,50	0,60	0,80	355 (330 – 410)
		0,30	0,040	0,020	0,024	0,032	1175 (1100 – 1300)
P2	E/M/A/D	0,30	0,040	0,50	0,60	0,80	345 (320 – 390)
		0,30	0,040	0,020	0,024	0,032	1125 (1100 – 1200)
P3	E/M/A/D	0,30	0,040	0,50	0,60	0,80	295 (280 – 340)
		0,30	0,040	0,020	0,024	0,032	970 (920 – 1100)
P4	E/M/A/D	0,30	0,040	0,50	0,60	0,80	260 (250 – 300)
		0,30	0,040	0,020	0,024	0,032	850 (830 – 980)
P5	E/M/A/D	0,30	0,040	0,50	0,60	0,80	260 (250 – 300)
		0,30	0,040	0,020	0,024	0,032	850 (830 – 980)
P6	E/M/A/D	0,30	0,040	0,50	0,60	0,80	195 (180 – 230)
		0,30	0,040	0,020	0,024	0,032	640 (600 – 750)
P7	E/M/A/D	0,30	0,040	0,50	0,60	0,80	185 (170 – 220)
		0,30	0,040	0,020	0,024	0,032	610 (560 – 720)
P8	E/M/A/D	0,30	0,040	0,50	0,60	0,80	175 (160 – 210)
		0,30	0,040	0,020	0,024	0,032	570 (530 – 680)
P11	E/M/A/D	0,30	0,040	0,50	0,60	0,80	180 (170 – 210)
		0,30	0,040	0,020	0,024	0,032	590 (560 – 680)
P12	E/M/A/D	0,30	0,036	0,40	0,48	0,65	85 (83 – 100)
		0,30	0,036	0,016	0,019	0,026	280 (280 – 320)
M1	E/M/A	0,30	0,036	0,40	0,48	0,65	175 (170 – 210)
		0,30	0,036	0,016	0,019	0,026	570 (560 – 680)
M2	E/M/A	0,30	0,036	0,40	0,48	0,65	140 (140 – 160)
		0,30	0,036	0,016	0,019	0,026	460 (460 – 520)
M3	E/M/A	0,30	0,036	0,40	0,48	0,65	105 (97 – 130)
		0,30	0,036	0,016	0,019	0,026	345 (320 – 420)
M4	E/M/A	0,30	0,036	0,40	0,48	0,65	75 (73 – 100)
		0,30	0,036	0,016	0,019	0,026	245 (240 – 320)
M5	E/M/A	0,30	0,036	0,40	0,48	0,65	65 (61 – 83)
		0,30	0,036	0,016	0,019	0,026	215 (210 – 270)
S1	E	0,30	0,022	0,24	0,28	0,38	45 (36 – 71)
		0,30	0,022	0,0095	0,011	0,015	150 (120 – 230)
S2	E	0,30	0,022	0,24	0,28	0,38	36 (29 – 57)
		0,30	0,022	0,0095	0,011	0,015	120 (96 – 180)
S3	E	0,30	0,022	0,24	0,28	0,38	31 (25 – 49)
		0,30	0,022	0,0095	0,011	0,015	100 (83 – 160)
S11	E	0,30	0,022	0,36	0,42	0,55	160 (160 – 190)
		0,30	0,022	0,014	0,017	0,022	520 (530 – 620)
S12	E	0,30	0,022	0,36	0,42	0,55	120 (120 – 150)
		0,30	0,022	0,014	0,017	0,022	395 (400 – 490)
S13	E	0,30	0,022	0,36	0,42	0,55	95 (90 – 110)
		0,30	0,022	0,014	0,017	0,022	310 (300 – 360)
H5	M/A	0,30	0,040	0,40	0,48	0,65	105 (99 – 130)
		0,30	0,040	0,016	0,019	0,026	345 (330 – 420)
H8	M/A	0,30	0,040	0,40	0,48	0,65	105 (99 – 130)
		0,30	0,040	0,016	0,019	0,026	345 (330 – 420)
H11	M/A	0,30	0,040	0,40	0,48	0,65	135 (130 – 170)
		0,30	0,040	0,016	0,019	0,026	445 (430 – 550)
H21	M/A	0,30	0,040	0,40	0,48	0,65	105 (99 – 130)
		0,30	0,040	0,016	0,019	0,026	345 (330 – 420)
H31	M/A	0,30	0,040	0,40	0,48	0,65	80 (75 – 100)
		0,30	0,040	0,016	0,019	0,026	260 (250 – 320)

SMG = Seco material group
 Coolant = A=air D=dry E=emulsion M=mist spray
 v_c = m/min (sf/min)
 f_z = mm (in/tooth)
 a_p = mm/DC (in/DC) = factor
 a_e = mm/DC (in/DC) = factor
 All cutting data are target values

Universal
 Steel and cast iron
 Stainless steel and S-materials
 Non ferrous
 Hard
 Plastic and CFRP
 Graphite
 X-Heads
 Minimaster Plus
 Minimaster

Cutting data – XHF780 Slot milling

SMG		a _p /DCX	f _z			v _c
			10	12	16	
P1	E/M/A/D	0,040	0,30	0,36	0,48	310 (290 – 350)
		0.040	0.012	0.014	0.019	1025 (960 – 1100)
P2	E/M/A/D	0,040	0,30	0,36	0,48	300 (290 – 350)
		0.040	0.012	0.014	0.019	980 (960 – 1100)
P3	E/M/A/D	0,040	0,30	0,36	0,48	260 (250 – 300)
		0.040	0.012	0.014	0.019	850 (830 – 980)
P4	E/M/A/D	0,040	0,30	0,36	0,48	230 (220 – 260)
		0.040	0.012	0.014	0.019	750 (730 – 850)
P5	E/M/A/D	0,040	0,30	0,36	0,48	230 (220 – 260)
		0.040	0.012	0.014	0.019	750 (730 – 850)
P6	E/M/A/D	0,040	0,30	0,36	0,48	170 (160 – 200)
		0.040	0.012	0.014	0.019	560 (530 – 650)
P7	E/M/A/D	0,040	0,30	0,36	0,48	160 (150 – 190)
		0.040	0.012	0.014	0.019	520 (500 – 620)
P8	E/M/A/D	0,040	0,30	0,36	0,48	150 (140 – 180)
		0.040	0.012	0.014	0.019	490 (460 – 590)
P11	E/M/A/D	0,040	0,30	0,36	0,48	155 (150 – 180)
		0.040	0.012	0.014	0.019	510 (500 – 590)
P12	E/M/A/D	0,036	0,24	0,28	0,38	75 (73 – 92)
		0.036	0.0095	0.011	0.015	245 (240 – 300)
M1	E/M/A	0,036	0,24	0,28	0,38	150 (150 – 180)
		0.036	0.0095	0.011	0.015	490 (500 – 590)
M2	E/M/A	0,036	0,24	0,28	0,38	120 (120 – 140)
		0.036	0.0095	0.011	0.015	395 (400 – 450)
M3	E/M/A	0,036	0,24	0,28	0,38	90 (85 – 110)
		0.036	0.0095	0.011	0.015	295 (280 – 360)
M4	E/M/A	0,036	0,24	0,28	0,38	65 (64 – 87)
		0.036	0.0095	0.011	0.015	215 (210 – 280)
M5	E/M/A	0,036	0,24	0,28	0,38	55 (53 – 72)
		0.036	0.0095	0.011	0.015	180 (180 – 230)
S1	E	0,022	0,18	0,22	0,28	38 (31 – 60)
		0.022	0.0070	0.0085	0.011	125 (110 – 190)
S2	E	0,022	0,18	0,22	0,28	30 (25 – 48)
		0.022	0.0070	0.0085	0.011	100 (83 – 150)
S3	E	0,022	0,18	0,22	0,28	26 (21 – 41)
		0.022	0.0070	0.0085	0.011	85 (69 – 130)
S11	E	0,022	0,18	0,22	0,28	145 (140 – 170)
		0.022	0.0070	0.0085	0.011	475 (460 – 550)
S12	E	0,022	0,18	0,22	0,28	110 (110 – 130)
		0.022	0.0070	0.0085	0.011	360 (370 – 420)
S13	E	0,022	0,18	0,22	0,28	85 (82 – 100)
		0.022	0.0070	0.0085	0.011	280 (270 – 320)
H5	M/A	0,040	0,24	0,28	0,38	90 (86 – 110)
		0.040	0.0095	0.011	0.015	295 (290 – 360)
H8	M/A	0,040	0,24	0,28	0,38	90 (86 – 110)
		0.040	0.0095	0.011	0.015	295 (290 – 360)
H11	M/A	0,040	0,24	0,28	0,38	115 (110 – 140)
		0.040	0.0095	0.011	0.015	375 (370 – 450)
H21	M/A	0,040	0,24	0,28	0,38	90 (86 – 110)
		0.040	0.0095	0.011	0.015	295 (290 – 360)
H31	M/A	0,040	0,24	0,28	0,38	70 (65 – 88)
		0.040	0.0095	0.011	0.015	230 (220 – 280)

SMG = Seco material group
Coolant = A=air D=dry E=emulsion M=mist spray
v_c = m/min (sf/min)
f_z = mm (in/tooth)
a_p = mm/DC (in/DC) = factor
a_e = mm/DC (in/DC) = factor
All cutting data are target values

Cutting data – XHF780 Side milling inch

SMG		a _e /DCX	a _p /DCX	f _z			v _c
				3/8	1/2	5/8	
P1	E/M/A/D	0,30	0,040	0,50	0,60	0,80	370 (330 – 410)
		0,30	0,040	0,020	0,024	0,032	1225 (1100 – 1300)
P2	E/M/A/D	0,30	0,040	0,50	0,60	0,80	360 (320 – 390)
		0,30	0,040	0,020	0,024	0,032	1175 (1100 – 1200)
P3	E/M/A/D	0,30	0,040	0,50	0,60	0,80	310 (280 – 340)
		0,30	0,040	0,020	0,024	0,032	1025 (920 – 1100)
P4	E/M/A/D	0,30	0,040	0,50	0,60	0,80	270 (250 – 300)
		0,30	0,040	0,020	0,024	0,032	890 (830 – 980)
P5	E/M/A/D	0,30	0,040	0,50	0,60	0,80	270 (250 – 300)
		0,30	0,040	0,020	0,024	0,032	890 (830 – 980)
P6	E/M/A/D	0,30	0,040	0,50	0,60	0,80	305 (280 – 330)
		0,30	0,040	0,020	0,024	0,032	1000 (920 – 1000)
P7	E/M/A/D	0,30	0,040	0,50	0,60	0,80	290 (260 – 320)
		0,30	0,040	0,020	0,024	0,032	950 (860 – 1000)
P8	E/M/A/D	0,30	0,040	0,50	0,60	0,80	270 (250 – 300)
		0,30	0,040	0,020	0,024	0,032	890 (830 – 980)
P11	E/M/A/D	0,30	0,036	0,40	0,48	0,65	160 (150 – 170)
		0,30	0,036	0,016	0,019	0,026	520 (500 – 550)
P12	E/M/A/D	0,30	0,036	0,40	0,48	0,65	95 (83 – 100)
		0,30	0,036	0,016	0,019	0,026	310 (280 – 320)
M1	E/M/A	0,30	0,036	0,40	0,48	0,65	190 (170 – 210)
		0,30	0,036	0,016	0,019	0,026	620 (560 – 680)
M2	E/M/A	0,30	0,036	0,40	0,48	0,65	150 (140 – 160)
		0,30	0,036	0,016	0,019	0,026	490 (460 – 520)
M3	E/M/A	0,30	0,036	0,40	0,48	0,65	115 (97 – 130)
		0,30	0,036	0,016	0,019	0,026	375 (320 – 420)
M4	E/M/A	0,30	0,036	0,40	0,48	0,65	85 (73 – 100)
		0,30	0,036	0,016	0,019	0,026	280 (240 – 320)
M5	E/M/A	0,30	0,036	0,40	0,48	0,65	70 (61 – 83)
		0,30	0,036	0,016	0,019	0,026	230 (210 – 270)
S1	E	0,30	0,022	0,24	0,28	0,38	55 (36 – 71)
		0,30	0,022	0,0095	0,011	0,015	180 (120 – 230)
S2	E	0,30	0,022	0,24	0,28	0,38	43 (29 – 57)
		0,30	0,022	0,0095	0,011	0,015	140 (96 – 180)
S3	E	0,30	0,022	0,24	0,28	0,38	37 (25 – 49)
		0,30	0,022	0,0095	0,011	0,015	120 (83 – 160)
S11	E	0,30	0,022	0,36	0,42	0,55	175 (160 – 190)
		0,30	0,022	0,014	0,017	0,022	570 (530 – 620)
S12	E	0,30	0,022	0,36	0,42	0,55	135 (120 – 150)
		0,30	0,022	0,014	0,017	0,022	445 (400 – 490)
S13	E	0,30	0,022	0,36	0,42	0,55	105 (90 – 110)
		0,30	0,022	0,014	0,017	0,022	345 (300 – 360)
H5	M/A	0,30	0,040	0,40	0,48	0,65	115 (99 – 130)
		0,30	0,040	0,016	0,019	0,026	375 (330 – 420)
H8	M/A	0,30	0,040	0,40	0,48	0,65	115 (99 – 130)
		0,30	0,040	0,016	0,019	0,026	375 (330 – 420)
H11	M/A	0,30	0,040	0,40	0,48	0,65	150 (130 – 170)
		0,30	0,040	0,016	0,019	0,026	490 (430 – 550)
H21	M/A	0,30	0,040	0,40	0,48	0,65	115 (99 – 130)
		0,30	0,040	0,016	0,019	0,026	375 (330 – 420)
H31	M/A	0,30	0,040	0,40	0,48	0,65	90 (75 – 100)
		0,30	0,040	0,016	0,019	0,026	295 (250 – 320)

SMG = Seco material group
 Coolant = A=air D=dry E=emulsion M=mist spray
 v_c = m/min (sf/min)
 f_z = mm (in/tooth)
 a_p = mm/DC (in/DC) = factor
 a_e = mm/DC (in/DC) = factor
 All cutting data are target values

Universal
 Steel and cast iron
 Stainless steel and S-materials
 Non ferrous
 Hard
 Plastic and cfrp
 Graphite
 X-Heads
 Minmaster Plus
 Minmaster

Cutting data – XHF780 Slot milling inch

SMG		a _p /DCX	f _z			v _c	
			3/8	1/2	5/8		
Universal Steel and cast iron	P1	E/M/A/D	0,040	0,30	0,36	0,48	325 (290 – 350)
			0.040	0.012	0.014	0.019	1075 (960 – 1100)
	P2	E/M/A/D	0,040	0,30	0,36	0,48	315 (290 – 350)
			0.040	0.012	0.014	0.019	1025 (960 – 1100)
	P3	E/M/A/D	0,040	0,30	0,36	0,48	270 (250 – 300)
			0.040	0.012	0.014	0.019	890 (830 – 980)
	P4	E/M/A/D	0,040	0,30	0,36	0,48	240 (220 – 260)
			0.040	0.012	0.014	0.019	790 (730 – 850)
	P5	E/M/A/D	0,040	0,30	0,36	0,48	240 (220 – 260)
			0.040	0.012	0.014	0.019	790 (730 – 850)
	P6	E/M/A/D	0,040	0,30	0,36	0,48	270 (240 – 290)
			0.040	0.012	0.014	0.019	890 (790 – 950)
P7	E/M/A/D	0,040	0,30	0,36	0,48	255 (230 – 280)	
		0.040	0.012	0.014	0.019	840 (760 – 910)	
P8	E/M/A/D	0,040	0,30	0,36	0,48	240 (220 – 260)	
		0.040	0.012	0.014	0.019	790 (730 – 850)	
P11	E/M/A/D	0,036	0,24	0,28	0,38	140 (130 – 150)	
		0.036	0.0095	0.011	0.015	460 (430 – 490)	
P12	E/M/A/D	0,036	0,24	0,28	0,38	80 (73 – 92)	
		0.036	0.0095	0.011	0.015	260 (240 – 300)	
Non ferrous	M1	E/M/A	0,036	0,24	0,28	0,38	165 (150 – 180)
			0.036	0.0095	0.011	0.015	540 (500 – 590)
	M2	E/M/A	0,036	0,24	0,28	0,38	130 (120 – 140)
			0.036	0.0095	0.011	0.015	425 (400 – 450)
	M3	E/M/A	0,036	0,24	0,28	0,38	100 (85 – 110)
		0.036	0.0095	0.011	0.015	330 (280 – 360)	
M4	E/M/A	0,036	0,24	0,28	0,38	75 (64 – 87)	
		0.036	0.0095	0.011	0.015	245 (210 – 280)	
Hard	M5	E/M/A	0,036	0,24	0,28	0,38	65 (53 – 72)
			0.036	0.0095	0.011	0.015	215 (180 – 230)
	S1	E	0,022	0,18	0,22	0,28	45 (31 – 60)
			0.022	0.0070	0.0085	0.011	150 (110 – 190)
	S2	E	0,022	0,18	0,22	0,28	36 (25 – 48)
		0.022	0.0070	0.0085	0.011	120 (83 – 150)	
Plastic and cfrp	S3	E	0,022	0,18	0,22	0,28	31 (21 – 41)
			0.022	0.0070	0.0085	0.011	100 (69 – 130)
	S11	E	0,022	0,18	0,22	0,28	155 (140 – 170)
			0.022	0.0070	0.0085	0.011	510 (460 – 550)
	S12	E	0,022	0,18	0,22	0,28	120 (110 – 130)
		0.022	0.0070	0.0085	0.011	395 (370 – 420)	
S13	E	0,022	0,18	0,22	0,28	95 (82 – 100)	
		0.022	0.0070	0.0085	0.011	310 (270 – 320)	
Graphite	H5	M/A	0,040	0,24	0,28	0,38	100 (86 – 110)
			0.040	0.0095	0.011	0.015	330 (290 – 360)
	H8	M/A	0,040	0,24	0,28	0,38	100 (86 – 110)
			0.040	0.0095	0.011	0.015	330 (290 – 360)
	H11	M/A	0,040	0,24	0,28	0,38	130 (110 – 140)
			0.040	0.0095	0.011	0.015	425 (370 – 450)
	H21	M/A	0,040	0,24	0,28	0,38	100 (86 – 110)
			0.040	0.0095	0.011	0.015	330 (290 – 360)
H31	M/A	0,040	0,24	0,28	0,38	75 (65 – 88)	
		0.040	0.0095	0.011	0.015	245 (220 – 280)	

SMG = Seco material group
Coolant = A=air D=dry E=emulsion M=mist spray
v_c = m/min (sf/min)
f_z = mm (in/tooth)
a_p = mm/DC (in/DC) = factor
a_e = mm/DC (in/DC) = factor
All cutting data are target values

XVE540

General purpose – Universal – Square – 3 Flutes – Corner radius

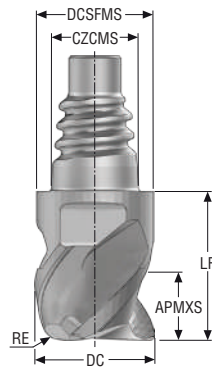

D

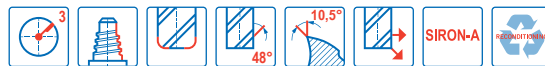

- Tolerances:
- DC= h9
- RE= ±0,015 mm
- Regrind possible if DC is ≥Ø12 mm



Designation	Item number	Length index	Tool shape	CZCMS	DC	DCSFMS	APMXS	LF	RE	PCEDC	SW	Grade
					mm	mm	mm	mm	mm			SIRA
XVE540E10100D1R050Z3	10137981	1	D	E10	10,0	9,7	5,5	12,4	0,5	3	8	■
XVE540E12120D1R050Z3	10137982	1	D	E12	12,0	11,7	6,5	14,5	0,5	3	10	■
XVE540E16160D1R050Z3	10137983	1	D	E16	16,0	15,5	8,5	18,7	0,5	3	12	■
XVE540E20200D1R050Z3	10137984	1	D	E20	20,0	19,3	11,0	21,3	0,5	3	16	■

■ Stocked standard.

Universal

Steel and cast iron

Stainless steel and S-materials

Non ferrous

Hard

Plastic and CFRP

Graphite

X-Heads

Minimaster Plus

Minimaster

XVE540

General purpose – Universal – Square – 3 Flutes – Corner radius

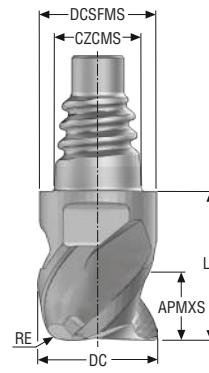

D

- Tolerances:
- DC= h9
- RE= .015 Inch= ±.0006 Inch
- RE= .031 Inch= ±.0012 Inch
- Regrind possible if DC is ≥Ø.500 Inch

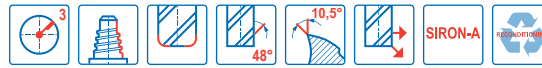

Designation	Item number	Length index	Tool shape	CZCMS	DC	DCSFMS	APMXS	LF	RE	PCEDC	SW	Grade
					<i>Inch</i>	<i>Inch</i>	<i>Inch</i>	<i>Inch</i>	<i>Inch</i>			SIRA
XVE540E10.375D1R015Z3	10137985	1	D	E10	0.375	0.364	0.209	0.488	0.015	3	8	■
XVE540E12.500D1R015Z3	10137986	1	D	E12	0.500	0.484	0.276	0.575	0.015	3	10	■
XVE540E16.625D1R015Z3	10137987	1	D	E16	0.625	0.610	0.335	0.736	0.015	3	12	■
XVE540E20.750D1R031Z3	10137988	1	D	E20	0.750	0.728	0.413	0.839	0.031	3	16	■

■ Stocked standard.

Universal
Steel and cast iron
Stainless steel and S-materials
Non ferrous
Hard
Plastic and CFRP
Graphite
X-Heads
Minimaster Plus
Minimaster

Cutting data – XVE540 – Side milling PCEDC 3

SMG		a _e /DC	a _p /DC	f _z				v _c
				10	12	16	20	
P1	E/M/A/D	0,50	0,50	0,055	0,065	0,080	0,090	175 (140 – 220)
		0,50	0,50	0,0022	0,0026	0,0032	0,0036	570 (460 – 720)
P2	E/M/A/D	0,50	0,50	0,055	0,065	0,080	0,090	170 (130 – 210)
		0,50	0,50	0,0022	0,0026	0,0032	0,0036	560 (430 – 680)
P3	E/M/A/D	0,50	0,50	0,050	0,060	0,075	0,085	150 (120 – 180)
		0,50	0,50	0,0020	0,0024	0,0030	0,0034	490 (400 – 590)
P4	E/M/A/D	0,50	0,50	0,050	0,060	0,075	0,085	135 (100 – 160)
		0,50	0,50	0,0020	0,0024	0,0030	0,0034	445 (330 – 520)
P5	E/M/A/D	0,50	0,50	0,050	0,060	0,070	0,085	125 (96 – 150)
		0,50	0,50	0,0020	0,0024	0,0028	0,0034	410 (320 – 490)
P6	E/M/A/D	0,50	0,50	0,048	0,055	0,070	0,080	145 (110 – 170)
		0,50	0,50	0,0019	0,0022	0,0028	0,0032	475 (370 – 550)
P7	E/M/A/D	0,50	0,50	0,048	0,055	0,070	0,080	135 (110 – 160)
		0,50	0,50	0,0019	0,0022	0,0028	0,0032	445 (370 – 520)
P8	E/M/A/D	0,50	0,50	0,050	0,060	0,075	0,085	125 (96 – 150)
		0,50	0,50	0,0020	0,0024	0,0030	0,0034	410 (320 – 490)
P11	E/M/A/D	0,50	0,50	0,050	0,060	0,075	0,085	80 (70 – 93)
		0,50	0,50	0,0020	0,0024	0,0030	0,0034	260 (230 – 300)
P12	E/M/A/D	0,50	0,50	0,034	0,040	0,050	0,060	50 (45 – 59)
		0,50	0,50	0,0013	0,0016	0,0020	0,0024	165 (150 – 190)
M1	E/M/A	0,50	0,50	0,055	0,065	0,080	0,095	95 (81 – 100)
		0,50	0,50	0,0022	0,0026	0,0032	0,0038	310 (270 – 320)
M2	E/M/A	0,50	0,50	0,050	0,060	0,075	0,085	75 (67 – 88)
		0,50	0,50	0,0020	0,0024	0,0030	0,0034	245 (220 – 280)
M3	E/M/A	0,50	0,50	0,050	0,060	0,075	0,085	50 (39 – 60)
		0,50	0,50	0,0020	0,0024	0,0030	0,0034	165 (130 – 190)
M4	E/M/A	0,50	0,50	0,044	0,050	0,065	0,075	38 (30 – 46)
		0,50	0,50	0,0017	0,0020	0,0026	0,0030	125 (99 – 150)
M5	E/M/A	0,50	0,50	0,044	0,050	0,065	0,075	32 (25 – 39)
		0,50	0,50	0,0017	0,0020	0,0026	0,0030	105 (83 – 120)
K1	E/M/A/D	0,50	0,50	0,050	0,060	0,075	0,085	155 (140 – 170)
		0,50	0,50	0,0020	0,0024	0,0030	0,0034	510 (460 – 550)
K2	E/M/A/D	0,50	0,50	0,046	0,055	0,065	0,075	135 (120 – 150)
		0,50	0,50	0,0018	0,0022	0,0026	0,0030	445 (400 – 490)
K3	E/M/A/D	0,50	0,50	0,046	0,055	0,065	0,075	115 (99 – 130)
		0,50	0,50	0,0018	0,0022	0,0026	0,0030	375 (330 – 420)
K4	E/M/A/D	0,50	0,50	0,046	0,055	0,065	0,075	110 (95 – 120)
		0,50	0,50	0,0018	0,0022	0,0026	0,0030	360 (320 – 390)
K5	E/M/A/D	0,50	0,50	0,050	0,060	0,075	0,085	140 (120 – 150)
		0,50	0,50	0,0020	0,0024	0,0030	0,0034	460 (400 – 490)
K6	E/M/A/D	0,50	0,50	0,055	0,065	0,080	0,095	200 (170 – 220)
		0,50	0,50	0,0022	0,0026	0,0032	0,0038	660 (560 – 720)
K7	E/M/A/D	0,50	0,50	0,050	0,060	0,075	0,085	175 (150 – 190)
		0,50	0,50	0,0020	0,0024	0,0030	0,0034	570 (500 – 620)
N1	E/M/A	0,40	0,50	0,080	0,095	0,12	0,14	550 (510 – 710)
		0,40	0,50	0,0032	0,0038	0,0048	0,0055	1800 (1700 – 2300)
N2	E/M/A	0,40	0,50	0,080	0,095	0,12	0,14	355 (330 – 450)
		0,40	0,50	0,0032	0,0038	0,0048	0,0055	1175 (1100 – 1400)
N3	E/M/A	0,40	0,50	0,080	0,095	0,12	0,14	235 (220 – 300)
		0,40	0,50	0,0032	0,0038	0,0048	0,0055	770 (730 – 980)
N11	E/M/A	0,50	0,50	0,070	0,080	0,11	0,13	300 (250 – 340)
		0,50	0,50	0,0028	0,0032	0,0044	0,0050	980 (830 – 1100)
S1	E	0,50	0,50	0,050	0,060	0,075	0,085	30 (24 – 37)
		0,50	0,50	0,0020	0,0024	0,0030	0,0034	100 (79 – 120)
S2	E	0,50	0,50	0,050	0,060	0,075	0,085	25 (19 – 32)
		0,50	0,50	0,0020	0,0024	0,0030	0,0034	80 (63 – 100)
S3	E	0,50	0,50	0,050	0,060	0,075	0,085	22 (17 – 27)
		0,50	0,50	0,0020	0,0024	0,0030	0,0034	70 (56 – 88)
S11	E	0,50	0,50	0,050	0,060	0,075	0,085	100 (72 – 120)
		0,50	0,50	0,0020	0,0024	0,0030	0,0034	330 (240 – 390)
S12	E	0,50	0,50	0,050	0,060	0,075	0,085	75 (56 – 99)
		0,50	0,50	0,0020	0,0024	0,0030	0,0034	245 (190 – 320)
S13	E	0,50	0,50	0,044	0,050	0,065	0,075	60 (44 – 79)
		0,50	0,50	0,0017	0,0020	0,0026	0,0030	195 (150 – 250)
TS1	A/D	0,40	0,50	0,080	0,095	0,12	0,14	255 (160 – 350)
		0,40	0,50	0,0032	0,0038	0,0048	0,0055	840 (530 – 1100)
TP1	A/D	0,40	0,50	0,080	0,095	0,12	0,14	255 (160 – 350)
		0,40	0,50	0,0032	0,0038	0,0048	0,0055	840 (530 – 1100)
GR1	A/D	0,40	0,50	0,080	0,095	0,12	0,14	610 (510 – 710)
		0,40	0,50	0,0032	0,0038	0,0048	0,0055	2000 (1700 – 2300)

Universal
Steel and cast iron
Stainless steel and S-materials
Non ferrous
Hard
Plastic and CFRP
Graphite
X-Heads
Minimaster Plus
Minimaster

Cutting data – XVE540 – Slot milling PCEDC 3

SMG		a _p /DC	f _z				v _c
			10	12	16	20	
P1	E/M/A/D	0,50	0,034	0,042	0,055	0,070	165 (130 – 200)
		0,50	0,0013	0,0017	0,0022	0,0028	540 (430 – 650)
P2	E/M/A/D	0,50	0,034	0,042	0,055	0,070	160 (120 – 190)
		0,50	0,0013	0,0017	0,0022	0,0028	520 (400 – 620)
P3	E/M/A/D	0,50	0,034	0,042	0,055	0,070	135 (110 – 170)
		0,50	0,0013	0,0017	0,0022	0,0028	445 (370 – 550)
P4	E/M/A/D	0,50	0,034	0,042	0,055	0,070	120 (90 – 140)
		0,50	0,0013	0,0017	0,0022	0,0028	395 (300 – 450)
P5	E/M/A/D	0,50	0,034	0,042	0,055	0,070	115 (86 – 140)
		0,50	0,0013	0,0017	0,0022	0,0028	375 (290 – 450)
P6	E/M/A/D	0,50	0,034	0,042	0,055	0,070	130 (97 – 160)
		0,50	0,0013	0,0017	0,0022	0,0028	425 (320 – 520)
P7	E/M/A/D	0,50	0,034	0,042	0,055	0,070	120 (92 – 150)
		0,50	0,0013	0,0017	0,0022	0,0028	395 (310 – 490)
P8	E/M/A/D	0,50	0,034	0,042	0,055	0,070	115 (86 – 140)
		0,50	0,0013	0,0017	0,0022	0,0028	375 (290 – 450)
P11	E/M/A/D	0,50	0,034	0,042	0,055	0,070	75 (64 – 84)
		0,50	0,0013	0,0017	0,0022	0,0028	245 (210 – 270)
P12	E/M/A/D	0,50	0,034	0,040	0,050	0,060	44 (38 – 49)
		0,50	0,0013	0,0016	0,0020	0,0024	145 (130 – 160)
M1	E/M/A	0,50	0,034	0,042	0,055	0,070	85 (75 – 99)
		0,50	0,0013	0,0017	0,0022	0,0028	280 (250 – 320)
M2	E/M/A	0,50	0,034	0,042	0,055	0,070	70 (60 – 79)
		0,50	0,0013	0,0017	0,0022	0,0028	230 (200 – 250)
M3	E/M/A	0,50	0,034	0,042	0,055	0,070	45 (35 – 55)
		0,50	0,0013	0,0017	0,0022	0,0028	150 (120 – 180)
M4	E/M/A	0,50	0,034	0,042	0,055	0,070	34 (27 – 41)
		0,50	0,0013	0,0017	0,0022	0,0028	110 (89 – 130)
M5	E/M/A	0,50	0,034	0,042	0,055	0,070	28 (22 – 34)
		0,50	0,0013	0,0017	0,0022	0,0028	90 (73 – 110)
K1	E/M/A/D	0,50	0,034	0,042	0,055	0,070	140 (120 – 150)
		0,50	0,0013	0,0017	0,0022	0,0028	460 (400 – 490)
K2	E/M/A/D	0,50	0,034	0,042	0,055	0,070	120 (110 – 130)
		0,50	0,0013	0,0017	0,0022	0,0028	395 (370 – 420)
K3	E/M/A/D	0,50	0,034	0,042	0,055	0,070	105 (89 – 110)
		0,50	0,0013	0,0017	0,0022	0,0028	345 (300 – 360)
K4	E/M/A/D	0,50	0,034	0,042	0,055	0,070	100 (85 – 110)
		0,50	0,0013	0,0017	0,0022	0,0028	330 (280 – 360)
K5	E/M/A/D	0,50	0,034	0,042	0,055	0,070	125 (110 – 140)
		0,50	0,0013	0,0017	0,0022	0,0028	410 (370 – 450)
K6	E/M/A/D	0,50	0,034	0,042	0,055	0,070	185 (150 – 200)
		0,50	0,0013	0,0017	0,0022	0,0028	610 (500 – 650)
K7	E/M/A/D	0,50	0,034	0,042	0,055	0,070	160 (130 – 170)
		0,50	0,0013	0,0017	0,0022	0,0028	520 (430 – 550)
N1	E/M/A	0,30	0,034	0,042	0,055	0,070	540 (510 – 700)
		0,30	0,0013	0,0017	0,0022	0,0028	1775 (1700 – 2200)
N2	E/M/A	0,30	0,034	0,042	0,055	0,070	345 (330 – 450)
		0,30	0,0013	0,0017	0,0022	0,0028	1125 (1100 – 1400)
N3	E/M/A	0,30	0,034	0,042	0,055	0,070	230 (220 – 300)
		0,30	0,0013	0,0017	0,0022	0,0028	750 (730 – 980)
N11	E/M/A	0,30	0,034	0,042	0,055	0,070	300 (260 – 350)
		0,30	0,0013	0,0017	0,0022	0,0028	980 (860 – 1100)
S1	E	0,50	0,034	0,042	0,055	0,070	27 (22 – 34)
		0,50	0,0013	0,0017	0,0022	0,0028	90 (73 – 110)
S2	E	0,50	0,034	0,042	0,055	0,070	23 (18 – 29)
		0,50	0,0013	0,0017	0,0022	0,0028	75 (60 – 95)
S3	E	0,50	0,034	0,042	0,055	0,070	20 (15 – 24)
		0,50	0,0013	0,0017	0,0022	0,0028	65 (50 – 78)
S11	E	0,50	0,034	0,042	0,055	0,070	90 (66 – 110)
		0,50	0,0013	0,0017	0,0022	0,0028	295 (220 – 360)
S12	E	0,50	0,034	0,042	0,055	0,070	70 (51 – 90)
		0,50	0,0013	0,0017	0,0022	0,0028	230 (170 – 290)
S13	E	0,50	0,034	0,042	0,055	0,070	55 (39 – 69)
		0,50	0,0013	0,0017	0,0022	0,0028	180 (130 – 220)
TS1	A/D	0,30	0,034	0,042	0,055	0,070	250 (150 – 350)
		0,30	0,0013	0,0017	0,0022	0,0028	820 (500 – 1100)
TP1	A/D	0,30	0,034	0,042	0,055	0,070	250 (150 – 350)
		0,30	0,0013	0,0017	0,0022	0,0028	820 (500 – 1100)
GR1	A/D	0,30	0,034	0,042	0,055	0,070	600 (500 – 700)
		0,30	0,0013	0,0017	0,0022	0,0028	1975 (1700 – 2200)

Cutting data – XVE540 – Side milling PCEDC 3 inch

SMG		a _e /DC	a _p /DC	f _z				v _c
				3/8	1/2	5/8	3/4	
P1	E/M/A/D	0,50	0,50	0,055	0,065	0,080	0,090	185 (150 – 210)
		0,50	0,50	0,0022	0,0026	0,0032	0,0036	610 (500 – 680)
P2	E/M/A/D	0,50	0,50	0,055	0,065	0,080	0,090	180 (150 – 200)
		0,50	0,50	0,0022	0,0026	0,0032	0,0036	590 (500 – 650)
P3	E/M/A/D	0,50	0,50	0,050	0,060	0,075	0,085	155 (130 – 180)
		0,50	0,50	0,0020	0,0024	0,0030	0,0034	510 (430 – 590)
P4	E/M/A/D	0,50	0,50	0,050	0,060	0,075	0,085	140 (120 – 160)
		0,50	0,50	0,0020	0,0024	0,0030	0,0034	460 (400 – 520)
P5	E/M/A/D	0,50	0,50	0,050	0,060	0,075	0,085	110 (89 – 130)
		0,50	0,50	0,0020	0,0024	0,0030	0,0034	360 (300 – 420)
P6	E/M/A/D	0,50	0,50	0,050	0,060	0,075	0,085	125 (100 – 140)
		0,50	0,50	0,0020	0,0024	0,0030	0,0034	410 (330 – 450)
P7	E/M/A/D	0,50	0,50	0,050	0,060	0,075	0,085	115 (94 – 140)
		0,50	0,50	0,0020	0,0024	0,0030	0,0034	375 (310 – 450)
P8	E/M/A/D	0,50	0,50	0,050	0,060	0,075	0,090	110 (89 – 130)
		0,50	0,50	0,0020	0,0024	0,0030	0,0036	360 (300 – 420)
P11	E/M/A/D	0,50	0,50	0,050	0,060	0,075	0,085	95 (70 – 110)
		0,50	0,50	0,0020	0,0024	0,0030	0,0034	310 (230 – 360)
P12	E/M/A/D	0,50	0,50	0,034	0,040	0,050	0,060	60 (45 – 73)
		0,50	0,50	0,0013	0,0016	0,0020	0,0024	195 (150 – 230)
M1	E/M/A	0,50	0,50	0,055	0,065	0,080	0,095	105 (81 – 130)
		0,50	0,50	0,0022	0,0026	0,0032	0,0038	345 (270 – 420)
M2	E/M/A	0,50	0,50	0,050	0,060	0,075	0,085	90 (67 – 110)
		0,50	0,50	0,0020	0,0024	0,0030	0,0034	295 (220 – 360)
M3	E/M/A	0,50	0,50	0,050	0,060	0,075	0,085	75 (56 – 99)
		0,50	0,50	0,0020	0,0024	0,0030	0,0034	245 (190 – 320)
M4	E/M/A	0,50	0,50	0,044	0,050	0,065	0,075	60 (43 – 76)
		0,50	0,50	0,0017	0,0020	0,0026	0,0030	195 (150 – 240)
M5	E/M/A	0,50	0,50	0,044	0,050	0,065	0,075	50 (36 – 63)
		0,50	0,50	0,0017	0,0020	0,0026	0,0030	165 (120 – 200)
K1	E/M/A/D	0,50	0,50	0,050	0,060	0,075	0,085	140 (120 – 160)
		0,50	0,50	0,0020	0,0024	0,0030	0,0034	460 (400 – 520)
K2	E/M/A/D	0,50	0,50	0,046	0,055	0,065	0,075	120 (110 – 140)
		0,50	0,50	0,0018	0,0022	0,0026	0,0030	395 (370 – 450)
K3	E/M/A/D	0,50	0,50	0,046	0,055	0,065	0,075	105 (87 – 110)
		0,50	0,50	0,0018	0,0022	0,0026	0,0030	345 (290 – 360)
K4	E/M/A/D	0,50	0,50	0,050	0,060	0,075	0,085	110 (89 – 130)
		0,50	0,50	0,0020	0,0024	0,0030	0,0034	360 (300 – 420)
K5	E/M/A/D	0,50	0,50	0,046	0,055	0,065	0,075	65 (54 – 80)
		0,50	0,50	0,0018	0,0022	0,0026	0,0030	215 (180 – 260)
K6	E/M/A/D	0,50	0,50	0,050	0,060	0,075	0,085	95 (78 – 110)
		0,50	0,50	0,0020	0,0024	0,0030	0,0034	310 (260 – 360)
K7	E/M/A/D	0,50	0,50	0,046	0,055	0,065	0,075	85 (69 – 100)
		0,50	0,50	0,0018	0,0022	0,0026	0,0030	280 (230 – 320)
N1	E/M/A	0,40	0,50	0,080	0,095	0,12	0,14	610 (510 – 710)
		0,40	0,50	0,0032	0,0038	0,0048	0,0055	2000 (1700 – 2300)
N2	E/M/A	0,40	0,50	0,080	0,095	0,12	0,14	395 (330 – 450)
		0,40	0,50	0,0032	0,0038	0,0048	0,0055	1300 (1100 – 1400)
N3	E/M/A	0,40	0,50	0,080	0,095	0,12	0,14	260 (220 – 300)
		0,40	0,50	0,0032	0,0038	0,0048	0,0055	850 (730 – 980)
N11	E/M/A	0,50	0,50	0,070	0,080	0,11	0,13	300 (250 – 340)
		0,50	0,30	0,0028	0,0032	0,0044	0,0055	1025 (860 – 1100)
S1	E	0,50	0,50	0,055	0,065	0,080	0,090	39 (32 – 46)
		0,50	0,50	0,0022	0,0026	0,0032	0,0036	130 (110 – 150)
S2	E	0,50	0,50	0,055	0,065	0,080	0,090	31 (26 – 37)
		0,50	0,50	0,0022	0,0026	0,0032	0,0036	100 (86 – 120)
S3	E	0,50	0,50	0,050	0,060	0,075	0,085	28 (23 – 33)
		0,50	0,50	0,0020	0,0024	0,0030	0,0034	90 (76 – 100)
S11	E	0,50	0,50	0,050	0,060	0,075	0,085	115 (87 – 140)
		0,50	0,50	0,0020	0,0024	0,0030	0,0034	375 (290 – 450)
S12	E	0,50	0,50	0,050	0,060	0,075	0,085	90 (67 – 110)
		0,50	0,50	0,0020	0,0024	0,0030	0,0034	295 (220 – 360)
S13	E	0,50	0,50	0,044	0,050	0,065	0,075	70 (53 – 87)
		0,50	0,50	0,0017	0,0020	0,0026	0,0030	230 (180 – 280)
TS1	A/D	0,40	0,50	0,080	0,095	0,12	0,14	255 (160 – 350)
		0,40	0,50	0,0032	0,0038	0,0048	0,0055	840 (530 – 1100)
TP1	A/D	0,40	0,50	0,080	0,095	0,12	0,14	255 (160 – 350)
		0,40	0,50	0,0032	0,0038	0,0048	0,0055	840 (530 – 1100)
GR1	A/D	0,40	0,50	0,080	0,095	0,12	0,14	610 (510 – 710)
		0,40	0,50	0,0032	0,0038	0,0048	0,0055	2000 (1700 – 2300)

Universal
Steel and cast iron
Stainless steel and S-materials
Non ferrous
Hard
Plastic and CFRP
Graphite
X-Heads
Minimaster Plus
Minimaster

Cutting data – XVE540 – Slot milling PCEDC 3 inch

SMG		a _p /DC	f _z				v _c
			3/8	1/2	5/8	3/4	
P1	E/M/A/D	0,50	0,034	0,042	0,055	0,070	170 (140 – 190)
		0,50	0,0013	0,0017	0,0022	0,0028	560 (460 – 620)
P2	E/M/A/D	0,50	0,034	0,042	0,055	0,070	165 (140 – 190)
		0,50	0,0013	0,0017	0,0022	0,0028	540 (460 – 620)
P3	E/M/A/D	0,50	0,034	0,042	0,055	0,070	140 (120 – 160)
		0,50	0,0013	0,0017	0,0022	0,0028	460 (400 – 520)
P4	E/M/A/D	0,50	0,034	0,042	0,055	0,070	125 (100 – 140)
		0,50	0,0013	0,0017	0,0022	0,0028	410 (330 – 450)
P5	E/M/A/D	0,50	0,034	0,042	0,055	0,070	100 (81 – 120)
		0,50	0,0013	0,0017	0,0022	0,0028	330 (270 – 390)
P6	E/M/A/D	0,50	0,034	0,042	0,055	0,070	110 (90 – 130)
		0,50	0,0013	0,0017	0,0022	0,0028	360 (300 – 420)
P7	E/M/A/D	0,50	0,034	0,042	0,055	0,070	105 (85 – 120)
		0,50	0,0013	0,0017	0,0022	0,0028	345 (280 – 390)
P8	E/M/A/D	0,50	0,034	0,042	0,055	0,070	100 (81 – 120)
		0,50	0,0013	0,0017	0,0022	0,0028	330 (270 – 390)
P11	E/M/A/D	0,50	0,034	0,042	0,055	0,070	85 (64 – 100)
		0,50	0,0013	0,0017	0,0022	0,0028	280 (210 – 320)
P12	E/M/A/D	0,50	0,034	0,040	0,050	0,060	50 (38 – 62)
		0,50	0,0013	0,0016	0,0020	0,0024	165 (130 – 200)
M1	E/M/A	0,50	0,034	0,042	0,055	0,070	100 (75 – 120)
		0,50	0,0013	0,0017	0,0022	0,0028	330 (250 – 390)
M2	E/M/A	0,50	0,034	0,042	0,055	0,070	80 (61 – 100)
		0,50	0,0013	0,0017	0,0022	0,0028	260 (210 – 320)
M3	E/M/A	0,50	0,034	0,042	0,055	0,070	70 (50 – 89)
		0,50	0,0013	0,0017	0,0022	0,0028	230 (170 – 290)
M4	E/M/A	0,50	0,034	0,042	0,055	0,070	50 (38 – 67)
		0,50	0,0013	0,0017	0,0022	0,0028	165 (130 – 210)
M5	E/M/A	0,50	0,034	0,042	0,055	0,070	44 (32 – 56)
		0,50	0,0013	0,0017	0,0022	0,0028	145 (110 – 180)
K1	E/M/A/D	0,50	0,034	0,042	0,055	0,070	125 (110 – 140)
		0,50	0,0013	0,0017	0,0022	0,0028	410 (370 – 450)
K2	E/M/A/D	0,50	0,034	0,042	0,055	0,070	110 (92 – 120)
		0,50	0,0013	0,0017	0,0022	0,0028	360 (310 – 390)
K3	E/M/A/D	0,50	0,034	0,042	0,055	0,070	90 (78 – 100)
		0,50	0,0013	0,0017	0,0022	0,0028	295 (260 – 320)
K4	E/M/A/D	0,50	0,034	0,042	0,055	0,070	100 (81 – 120)
		0,50	0,0013	0,0017	0,0022	0,0028	330 (270 – 390)
K5	E/M/A/D	0,50	0,034	0,042	0,055	0,070	60 (48 – 71)
		0,50	0,0013	0,0017	0,0022	0,0028	195 (160 – 230)
K6	E/M/A/D	0,50	0,034	0,042	0,055	0,070	90 (71 – 100)
		0,50	0,0013	0,0017	0,0022	0,0028	295 (240 – 320)
K7	E/M/A/D	0,50	0,034	0,042	0,055	0,070	75 (61 – 91)
		0,50	0,0013	0,0017	0,0022	0,0028	245 (210 – 290)
N1	E/M/A	0,30	0,034	0,042	0,055	0,070	600 (500 – 700)
		0,30	0,0013	0,0017	0,0022	0,0028	1975 (1700 – 2200)
N2	E/M/A	0,30	0,034	0,042	0,055	0,070	385 (330 – 450)
		0,30	0,0013	0,0017	0,0022	0,0028	1275 (1100 – 1400)
N3	E/M/A	0,30	0,034	0,042	0,055	0,070	255 (220 – 300)
		0,30	0,0013	0,0017	0,0022	0,0028	840 (730 – 980)
N11	E/M/A	0,30	0,034	0,042	0,055	0,070	300 (260 – 340)
		0,30	0,0013	0,0017	0,0022	0,0028	980 (860 – 1100)
S1	E	0,50	0,034	0,042	0,055	0,070	36 (29 – 43)
		0,50	0,0013	0,0017	0,0022	0,0028	120 (96 – 140)
S2	E	0,50	0,034	0,042	0,055	0,070	29 (24 – 34)
		0,50	0,0013	0,0017	0,0022	0,0028	95 (79 – 110)
S3	E	0,50	0,034	0,042	0,055	0,070	25 (20 – 30)
		0,50	0,0013	0,0017	0,0022	0,0028	80 (66 – 98)
S11	E	0,50	0,034	0,042	0,055	0,070	105 (79 – 130)
		0,50	0,0013	0,0017	0,0022	0,0028	345 (260 – 420)
S12	E	0,50	0,034	0,042	0,055	0,070	80 (61 – 100)
		0,50	0,0013	0,0017	0,0022	0,0028	260 (210 – 320)
S13	E	0,50	0,034	0,042	0,055	0,070	60 (47 – 77)
		0,50	0,0013	0,0017	0,0022	0,0028	195 (160 – 250)
TS1	A/D	0,30	0,034	0,042	0,055	0,070	250 (150 – 350)
		0,30	0,0013	0,0017	0,0022	0,0028	820 (500 – 1100)
TP1	A/D	0,30	0,034	0,042	0,055	0,070	250 (150 – 350)
		0,30	0,0013	0,0017	0,0022	0,0028	820 (500 – 1100)
GR1	A/D	0,30	0,034	0,042	0,055	0,070	600 (500 – 700)
		0,30	0,0013	0,0017	0,0022	0,0028	1975 (1700 – 2200)

XVE540

General purpose – Universal – Square – 4 Flutes – Corner radius – ICC

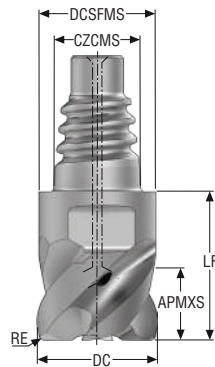

D

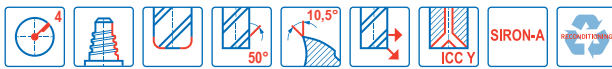

- Tolerances:
- DC= h9
- RE= ±0,015 mm
- Regrind possible if DC is ≥Ø12 mm

Designation	Item number	Length index	Tool shape	CSP	CZCMS	DC	DCSFMS	APMXS	LF	RE	PCEDC	SW	Grade
						mm	mm	mm	mm	mm			SIRA
XVE540E10100D1R050Z4A	10137989	1	D	✓	E10	10,0	9,7	6,0	12,4	0,5	4	8	■
XVE540E12120D1R050Z4A	10137990	1	D	✓	E12	12,0	11,7	7,5	14,5	0,5	4	10	■
XVE540E16160D1R050Z4A	10137991	1	D	✓	E16	16,0	15,5	10,0	18,7	0,5	4	12	■
XVE540E20200D1R050Z4A	10137992	1	D	✓	E20	20,0	19,3	12,0	21,3	0,5	4	16	■

■ Stocked standard.

Universal

Steel and cast iron

Stainless steel and S-materials

Non ferrous

Hard

Plastic and CFRP

Graphite

X-Heads

Minimaster Plus

Minimaster

XVE540

General purpose – Universal – Square – 4 Flutes – Corner radius – ICC – Inch

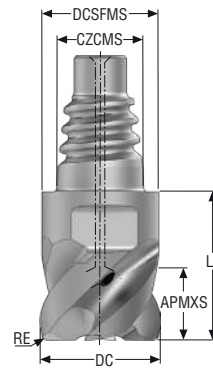

D

- Tolerances:
- DC= h9
- RE= .015 Inch= ±.0006 Inch
- RE= .031 Inch= ±.0012 Inch
- Regrind possible if DC is ≥Ø.500 Inch

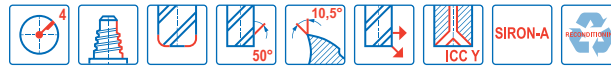

Designation	Item number	Length index	Tool shape	CSP	CZCMS	DC	DCSFMS	APMXS	LF	RE	PCEDC	SW	Grade
						<i>Inch</i>	<i>Inch</i>	<i>Inch</i>	<i>Inch</i>	<i>Inch</i>			SIRA
XVE540E10.375D1R015Z4A	10137993	1	D	✓	E10	0.375	0.364	0.236	0.488	0.015	4	8	■
XVE540E12.500D1R031Z4A	10137994	1	D	✓	E12	0.500	0.484	0.315	0.571	0.031	4	12	■
XVE540E16.625D1R031Z4A	10137995	1	D	✓	E16	0.625	0.610	0.394	0.736	0.031	4	16	■
XVE540E20.750D1R031Z4A	10137996	1	D	✓	E20	0.750	0.728	0.453	0.839	0.031	4	18	■

■ Stocked standard.

Universal

Steel and cast iron

Stainless steel and S-materials

Non ferrous

Hard

Plastic and CFRP

Graphite

X-Heads

Minimaster Plus

Minimaster

Cutting data – XVE540 – Side milling PCEDC 4

SMG		a _e /DC	a _p /DC	f _z				v _c
				10	12	16	20	
P1	E/M/A/D	0,50	0,55	0,055	0,065	0,080	0,090	175 (140 – 210)
		0,50	0,55	0,0022	0,0026	0,0032	0,0036	570 (460 – 680)
P2	E/M/A/D	0,50	0,55	0,055	0,065	0,080	0,090	170 (130 – 210)
		0,50	0,55	0,0022	0,0026	0,0032	0,0036	560 (430 – 680)
P3	E/M/A/D	0,50	0,55	0,050	0,060	0,075	0,085	150 (120 – 180)
		0,50	0,55	0,0020	0,0024	0,0030	0,0034	490 (400 – 590)
P4	E/M/A/D	0,50	0,55	0,050	0,060	0,075	0,085	130 (99 – 160)
		0,50	0,55	0,0020	0,0024	0,0030	0,0034	425 (330 – 520)
P5	E/M/A/D	0,50	0,55	0,050	0,060	0,070	0,085	125 (95 – 150)
		0,50	0,55	0,0020	0,0024	0,0028	0,0034	410 (320 – 490)
P6	E/M/A/D	0,50	0,55	0,048	0,055	0,070	0,080	140 (110 – 170)
		0,50	0,55	0,0019	0,0022	0,0028	0,0032	460 (370 – 550)
P7	E/M/A/D	0,50	0,55	0,048	0,055	0,070	0,080	135 (110 – 160)
		0,50	0,55	0,0019	0,0022	0,0028	0,0032	445 (370 – 520)
P8	E/M/A/D	0,50	0,55	0,050	0,060	0,075	0,085	125 (95 – 150)
		0,50	0,55	0,0020	0,0024	0,0030	0,0034	410 (320 – 490)
P11	E/M/A/D	0,50	0,55	0,050	0,060	0,075	0,085	80 (70 – 92)
		0,50	0,55	0,0020	0,0024	0,0030	0,0034	260 (230 – 300)
P12	E/M/A/D	0,50	0,55	0,034	0,040	0,050	0,060	50 (44 – 58)
		0,50	0,55	0,0013	0,0016	0,0020	0,0024	165 (150 – 190)
M1	E/M/A	0,50	0,55	0,055	0,065	0,080	0,095	95 (80 – 100)
		0,50	0,55	0,0022	0,0026	0,0032	0,0038	310 (270 – 320)
M2	E/M/A	0,50	0,55	0,050	0,060	0,075	0,085	75 (66 – 87)
		0,50	0,55	0,0020	0,0024	0,0030	0,0034	245 (220 – 280)
M3	E/M/A	0,50	0,55	0,050	0,060	0,075	0,085	49 (39 – 60)
		0,50	0,55	0,0020	0,0024	0,0030	0,0034	160 (130 – 190)
M4	E/M/A	0,50	0,55	0,044	0,050	0,065	0,075	38 (30 – 46)
		0,50	0,55	0,0017	0,0020	0,0026	0,0030	125 (99 – 150)
M5	E/M/A	0,50	0,55	0,044	0,050	0,065	0,075	32 (25 – 38)
		0,50	0,55	0,0017	0,0020	0,0026	0,0030	105 (83 – 120)
K1	E/M/A/D	0,50	0,55	0,050	0,060	0,075	0,085	155 (140 – 170)
		0,50	0,55	0,0020	0,0024	0,0030	0,0034	510 (460 – 550)
K2	E/M/A/D	0,50	0,55	0,046	0,055	0,065	0,075	135 (120 – 150)
		0,50	0,55	0,0018	0,0022	0,0026	0,0030	445 (400 – 490)
K3	E/M/A/D	0,50	0,55	0,046	0,055	0,065	0,075	115 (99 – 130)
		0,50	0,55	0,0018	0,0022	0,0026	0,0030	375 (330 – 420)
K4	E/M/A/D	0,50	0,55	0,046	0,055	0,065	0,075	110 (94 – 120)
		0,50	0,55	0,0018	0,0022	0,0026	0,0030	360 (310 – 390)
K5	E/M/A/D	0,50	0,55	0,050	0,060	0,075	0,085	135 (110 – 150)
		0,50	0,55	0,0020	0,0024	0,0030	0,0034	445 (370 – 490)
K6	E/M/A/D	0,50	0,55	0,055	0,065	0,080	0,095	200 (160 – 220)
		0,50	0,55	0,0022	0,0026	0,0032	0,0038	660 (530 – 720)
K7	E/M/A/D	0,50	0,55	0,050	0,060	0,075	0,085	175 (150 – 190)
		0,50	0,55	0,0020	0,0024	0,0030	0,0034	570 (500 – 620)
N1	E/M/A	0,40	0,55	0,080	0,095	0,12	0,14	540 (510 – 700)
		0,40	0,55	0,0032	0,0038	0,0048	0,0055	1775 (1700 – 2200)
N2	E/M/A	0,40	0,55	0,080	0,095	0,12	0,14	350 (330 – 450)
		0,40	0,55	0,0032	0,0038	0,0048	0,0055	1150 (1100 – 1400)
N3	E/M/A	0,40	0,55	0,080	0,095	0,12	0,14	235 (220 – 300)
		0,40	0,55	0,0032	0,0038	0,0048	0,0055	770 (730 – 980)
N11	E/M/A	0,50	0,55	0,070	0,080	0,11	0,13	295 (250 – 340)
		0,50	0,55	0,0028	0,0032	0,0044	0,0050	970 (830 – 1100)
S1	E	0,50	0,55	0,050	0,060	0,075	0,085	30 (24 – 37)
		0,50	0,55	0,0020	0,0024	0,0030	0,0034	100 (79 – 120)
S2	E	0,50	0,55	0,050	0,060	0,075	0,085	25 (19 – 31)
		0,50	0,55	0,0020	0,0024	0,0030	0,0034	80 (63 – 100)
S3	E	0,50	0,55	0,050	0,060	0,075	0,085	22 (17 – 27)
		0,50	0,55	0,0020	0,0024	0,0030	0,0034	70 (56 – 88)
S11	E	0,50	0,55	0,050	0,060	0,075	0,085	100 (72 – 120)
		0,50	0,55	0,0020	0,0024	0,0030	0,0034	330 (240 – 390)
S12	E	0,50	0,55	0,050	0,060	0,075	0,085	75 (55 – 98)
		0,50	0,55	0,0020	0,0024	0,0030	0,0034	245 (190 – 320)
S13	E	0,50	0,55	0,044	0,050	0,065	0,075	60 (44 – 78)
		0,50	0,55	0,0017	0,0020	0,0026	0,0030	195 (150 – 250)
TS1	A/D	0,40	0,55	0,080	0,095	0,12	0,14	250 (160 – 350)
		0,40	0,55	0,0032	0,0038	0,0048	0,0055	820 (530 – 1100)
TP1	A/D	0,40	0,55	0,080	0,095	0,12	0,14	250 (160 – 350)
		0,40	0,55	0,0032	0,0038	0,0048	0,0055	820 (530 – 1100)
GR1	A/D	0,40	0,55	0,080	0,095	0,12	0,14	610 (510 – 700)
		0,40	0,55	0,0032	0,0038	0,0048	0,0055	2000 (1700 – 2200)

Universal
Steel and cast iron
Stainless steel and S-materials
Non ferrous
Hard
Plastic and CFRP
Graphite
X-Heads
Minimaster Plus
Minimaster

Cutting data – XVE540 – Slot milling PCEDC 4

SMG		a _p /DC	f _z				v _c
			10	12	16	20	
P1	E/M/A/D	0,55	0,034	0,042	0,055	0,070	160 (130 – 200)
		0,55	0,0013	0,0017	0,0022	0,0028	520 (430 – 650)
P2	E/M/A/D	0,55	0,034	0,042	0,055	0,070	155 (120 – 190)
		0,55	0,0013	0,0017	0,0022	0,0028	510 (400 – 620)
P3	E/M/A/D	0,55	0,034	0,042	0,055	0,070	135 (110 – 160)
		0,55	0,0013	0,0017	0,0022	0,0028	445 (370 – 520)
P4	E/M/A/D	0,55	0,034	0,042	0,055	0,070	120 (90 – 140)
		0,55	0,0013	0,0017	0,0022	0,0028	395 (300 – 450)
P5	E/M/A/D	0,55	0,034	0,042	0,055	0,070	115 (86 – 140)
		0,55	0,0013	0,0017	0,0022	0,0028	375 (290 – 450)
P6	E/M/A/D	0,55	0,034	0,042	0,055	0,070	125 (96 – 150)
		0,55	0,0013	0,0017	0,0022	0,0028	410 (320 – 490)
P7	E/M/A/D	0,55	0,034	0,042	0,055	0,070	120 (91 – 150)
		0,55	0,0013	0,0017	0,0022	0,0028	395 (300 – 490)
P8	E/M/A/D	0,55	0,034	0,042	0,055	0,070	115 (86 – 140)
		0,55	0,0013	0,0017	0,0022	0,0028	375 (290 – 450)
P11	E/M/A/D	0,55	0,034	0,042	0,055	0,070	75 (63 – 83)
		0,55	0,0013	0,0017	0,0022	0,0028	245 (210 – 270)
P12	E/M/A/D	0,55	0,034	0,040	0,050	0,060	43 (37 – 49)
		0,55	0,0013	0,0016	0,0020	0,0024	140 (130 – 160)
M1	E/M/A	0,55	0,034	0,042	0,055	0,070	85 (74 – 98)
		0,55	0,0013	0,0017	0,0022	0,0028	280 (250 – 320)
M2	E/M/A	0,55	0,034	0,042	0,055	0,070	70 (60 – 79)
		0,55	0,0013	0,0017	0,0022	0,0028	230 (200 – 250)
M3	E/M/A	0,55	0,034	0,042	0,055	0,070	45 (35 – 54)
		0,55	0,0013	0,0017	0,0022	0,0028	150 (120 – 170)
M4	E/M/A	0,55	0,034	0,042	0,055	0,070	33 (26 – 40)
		0,55	0,0013	0,0017	0,0022	0,0028	110 (86 – 130)
M5	E/M/A	0,55	0,034	0,042	0,055	0,070	28 (22 – 34)
		0,55	0,0013	0,0017	0,0022	0,0028	90 (73 – 110)
K1	E/M/A/D	0,55	0,034	0,042	0,055	0,070	140 (120 – 150)
		0,55	0,0013	0,0017	0,0022	0,0028	460 (400 – 490)
K2	E/M/A/D	0,55	0,034	0,042	0,055	0,070	120 (110 – 130)
		0,55	0,0013	0,0017	0,0022	0,0028	395 (370 – 420)
K3	E/M/A/D	0,55	0,034	0,042	0,055	0,070	100 (88 – 110)
		0,55	0,0013	0,0017	0,0022	0,0028	330 (290 – 360)
K4	E/M/A/D	0,55	0,034	0,042	0,055	0,070	95 (84 – 110)
		0,55	0,0013	0,0017	0,0022	0,0028	310 (280 – 360)
K5	E/M/A/D	0,55	0,034	0,042	0,055	0,070	125 (100 – 130)
		0,55	0,0013	0,0017	0,0022	0,0028	410 (330 – 420)
K6	E/M/A/D	0,55	0,034	0,042	0,055	0,070	185 (150 – 200)
		0,55	0,0013	0,0017	0,0022	0,0028	610 (500 – 650)
K7	E/M/A/D	0,55	0,034	0,042	0,055	0,070	160 (130 – 170)
		0,55	0,0013	0,0017	0,0022	0,0028	520 (430 – 550)
N1	E/M/A	0,30	0,034	0,042	0,055	0,070	530 (500 – 690)
		0,30	0,0013	0,0017	0,0022	0,0028	1750 (1700 – 2200)
N2	E/M/A	0,30	0,034	0,042	0,055	0,070	345 (320 – 440)
		0,30	0,0013	0,0017	0,0022	0,0028	1125 (1100 – 1400)
N3	E/M/A	0,30	0,034	0,042	0,055	0,070	230 (220 – 290)
		0,30	0,0013	0,0017	0,0022	0,0028	750 (730 – 950)
N11	E/M/A	0,30	0,034	0,042	0,055	0,070	295 (250 – 340)
		0,30	0,0013	0,0017	0,0022	0,0028	970 (830 – 1100)
S1	E	0,55	0,034	0,042	0,055	0,070	27 (21 – 33)
		0,55	0,0013	0,0017	0,0022	0,0028	90 (69 – 100)
S2	E	0,55	0,034	0,042	0,055	0,070	23 (17 – 28)
		0,55	0,0013	0,0017	0,0022	0,0028	75 (56 – 91)
S3	E	0,55	0,034	0,042	0,055	0,070	20 (15 – 24)
		0,55	0,0013	0,0017	0,0022	0,0028	65 (50 – 78)
S11	E	0,55	0,034	0,042	0,055	0,070	90 (65 – 110)
		0,55	0,0013	0,0017	0,0022	0,0028	295 (220 – 360)
S12	E	0,55	0,034	0,042	0,055	0,070	70 (50 – 89)
		0,55	0,0013	0,0017	0,0022	0,0028	230 (170 – 290)
S13	E	0,55	0,034	0,042	0,055	0,070	55 (39 – 69)
		0,55	0,0013	0,0017	0,0022	0,0028	180 (130 – 220)
TS1	A/D	0,30	0,034	0,042	0,055	0,070	250 (150 – 340)
		0,30	0,0013	0,0017	0,0022	0,0028	820 (500 – 1100)
TP1	A/D	0,30	0,034	0,042	0,055	0,070	250 (150 – 340)
		0,30	0,0013	0,0017	0,0022	0,0028	820 (500 – 1100)
GR1	A/D	0,30	0,034	0,042	0,055	0,070	590 (500 – 690)
		0,30	0,0013	0,0017	0,0022	0,0028	1925 (1700 – 2200)

Cutting data – XVE540 – Side milling PCEDC 4 inch

SMG		a _e /DC	a _p /DC	f _z				v _c
				3/8	1/2	5/8	3/4	
P1	E/M/A/D	0,50	0,55	0,055	0,065	0,080	0,090	180 (150 – 210)
		0,50	0,55	0,0022	0,0026	0,0032	0,0036	590 (500 – 680)
P2	E/M/A/D	0,50	0,55	0,055	0,065	0,080	0,090	175 (150 – 200)
		0,50	0,55	0,0022	0,0026	0,0032	0,0036	570 (500 – 650)
P3	E/M/A/D	0,50	0,55	0,050	0,060	0,075	0,085	155 (130 – 180)
		0,50	0,55	0,0020	0,0024	0,0030	0,0034	510 (430 – 590)
P4	E/M/A/D	0,50	0,55	0,050	0,060	0,075	0,085	135 (110 – 150)
		0,50	0,55	0,0020	0,0024	0,0030	0,0034	445 (370 – 490)
P5	E/M/A/D	0,50	0,55	0,050	0,060	0,075	0,085	110 (88 – 130)
		0,50	0,55	0,0020	0,0024	0,0030	0,0034	360 (290 – 420)
P6	E/M/A/D	0,50	0,55	0,050	0,060	0,075	0,085	125 (99 – 140)
		0,50	0,55	0,0020	0,0024	0,0030	0,0034	410 (330 – 450)
P7	E/M/A/D	0,50	0,55	0,050	0,060	0,075	0,085	115 (93 – 130)
		0,50	0,55	0,0020	0,0024	0,0030	0,0034	375 (310 – 420)
P8	E/M/A/D	0,50	0,55	0,050	0,060	0,075	0,090	110 (88 – 130)
		0,50	0,55	0,0020	0,0024	0,0030	0,0036	360 (290 – 420)
P11	E/M/A/D	0,50	0,55	0,050	0,060	0,075	0,085	90 (70 – 110)
		0,50	0,55	0,0020	0,0024	0,0030	0,0034	295 (230 – 360)
P12	E/M/A/D	0,50	0,55	0,034	0,040	0,050	0,060	60 (44 – 73)
		0,50	0,55	0,0013	0,0016	0,0020	0,0024	195 (150 – 230)
M1	E/M/A	0,50	0,55	0,055	0,065	0,080	0,095	105 (80 – 130)
		0,50	0,55	0,0022	0,0026	0,0032	0,0038	345 (270 – 420)
M2	E/M/A	0,50	0,55	0,050	0,060	0,075	0,085	90 (66 – 100)
		0,50	0,55	0,0020	0,0024	0,0030	0,0034	295 (220 – 320)
M3	E/M/A	0,50	0,55	0,050	0,060	0,075	0,085	75 (55 – 98)
		0,50	0,55	0,0020	0,0024	0,0030	0,0034	245 (190 – 320)
M4	E/M/A	0,50	0,55	0,044	0,050	0,065	0,075	60 (43 – 75)
		0,50	0,55	0,0017	0,0020	0,0026	0,0030	195 (150 – 240)
M5	E/M/A	0,50	0,55	0,044	0,050	0,065	0,075	49 (36 – 63)
		0,50	0,55	0,0017	0,0020	0,0026	0,0030	160 (120 – 200)
K1	E/M/A/D	0,50	0,55	0,050	0,060	0,075	0,085	135 (120 – 150)
		0,50	0,55	0,0020	0,0024	0,0030	0,0034	445 (400 – 490)
K2	E/M/A/D	0,50	0,55	0,046	0,055	0,065	0,075	120 (110 – 130)
		0,50	0,55	0,0018	0,0022	0,0026	0,0030	395 (370 – 420)
K3	E/M/A/D	0,50	0,55	0,046	0,055	0,065	0,075	100 (86 – 110)
		0,50	0,55	0,0018	0,0022	0,0026	0,0030	330 (290 – 360)
K4	E/M/A/D	0,50	0,55	0,050	0,060	0,075	0,085	110 (88 – 130)
		0,50	0,55	0,0020	0,0024	0,0030	0,0034	360 (290 – 420)
K5	E/M/A/D	0,50	0,55	0,046	0,055	0,065	0,075	65 (54 – 79)
		0,50	0,55	0,0018	0,0022	0,0026	0,0030	215 (180 – 250)
K6	E/M/A/D	0,50	0,55	0,050	0,060	0,075	0,085	95 (78 – 110)
		0,50	0,55	0,0020	0,0024	0,0030	0,0034	310 (260 – 360)
K7	E/M/A/D	0,50	0,55	0,046	0,055	0,065	0,075	85 (68 – 100)
		0,50	0,55	0,0018	0,0022	0,0026	0,0030	280 (230 – 320)
N1	E/M/A	0,40	0,55	0,080	0,095	0,12	0,14	610 (510 – 700)
		0,40	0,55	0,0032	0,0038	0,0048	0,0055	2000 (1700 – 2200)
N2	E/M/A	0,40	0,55	0,080	0,095	0,12	0,14	390 (330 – 450)
		0,40	0,55	0,0032	0,0038	0,0048	0,0055	1275 (1100 – 1400)
N3	E/M/A	0,40	0,55	0,080	0,095	0,12	0,14	260 (220 – 300)
		0,40	0,55	0,0032	0,0038	0,0048	0,0055	850 (730 – 980)
N11	E/M/A	0,50	0,55	0,070	0,080	0,11	0,13	295 (250 – 340)
		0,50	0,30	0,0028	0,0032	0,0044	0,0055	1000 (860 – 1100)
S1	E	0,50	0,55	0,055	0,065	0,080	0,090	39 (31 – 46)
		0,50	0,55	0,0022	0,0026	0,0032	0,0036	130 (110 – 150)
S2	E	0,50	0,55	0,055	0,065	0,080	0,090	31 (25 – 37)
		0,50	0,55	0,0022	0,0026	0,0032	0,0036	100 (83 – 120)
S3	E	0,50	0,55	0,050	0,060	0,075	0,085	27 (22 – 32)
		0,50	0,55	0,0020	0,0024	0,0030	0,0034	90 (73 – 100)
S11	E	0,50	0,55	0,050	0,060	0,075	0,085	115 (86 – 140)
		0,50	0,55	0,0020	0,0024	0,0030	0,0034	375 (290 – 450)
S12	E	0,50	0,55	0,050	0,060	0,075	0,085	90 (66 – 100)
		0,50	0,55	0,0020	0,0024	0,0030	0,0034	295 (220 – 320)
S13	E	0,50	0,55	0,044	0,050	0,065	0,075	70 (53 – 87)
		0,50	0,55	0,0017	0,0020	0,0026	0,0030	230 (180 – 280)
TS1	A/D	0,40	0,55	0,080	0,095	0,12	0,14	250 (160 – 350)
		0,40	0,55	0,0032	0,0038	0,0048	0,0055	820 (530 – 1100)
TP1	A/D	0,40	0,55	0,080	0,095	0,12	0,14	250 (160 – 350)
		0,40	0,55	0,0032	0,0038	0,0048	0,0055	820 (530 – 1100)
GR1	A/D	0,40	0,55	0,080	0,095	0,12	0,14	610 (510 – 700)
		0,40	0,55	0,0032	0,0038	0,0048	0,0055	2000 (1700 – 2200)

Universal
Steel and cast iron
Stainless steel and S-materials
Non ferrous
Hard
Plastic and CFRP
Graphite
X-Heads
Minimaster Plus
Minimaster

Cutting data – XVE540 – Slot milling PCEDC 4 inch

SMG		a _p /DC	f _z				v _c
			3/8	1/2	5/8	3/4	
P1	E/M/A/D	0,55	0,034	0,042	0,055	0,070	170 (140 – 190)
		0,55	0,0013	0,0017	0,0022	0,0028	560 (460 – 620)
P2	E/M/A/D	0,55	0,034	0,042	0,055	0,070	165 (140 – 180)
		0,55	0,0013	0,0017	0,0022	0,0028	540 (460 – 590)
P3	E/M/A/D	0,55	0,034	0,042	0,055	0,070	140 (120 – 160)
		0,55	0,0013	0,0017	0,0022	0,0028	460 (400 – 520)
P4	E/M/A/D	0,55	0,034	0,042	0,055	0,070	125 (100 – 140)
		0,55	0,0013	0,0017	0,0022	0,0028	410 (330 – 450)
P5	E/M/A/D	0,55	0,034	0,042	0,055	0,070	100 (80 – 110)
		0,55	0,0013	0,0017	0,0022	0,0028	330 (270 – 360)
P6	E/M/A/D	0,55	0,034	0,042	0,055	0,070	110 (89 – 130)
		0,55	0,0013	0,0017	0,0022	0,0028	360 (300 – 420)
P7	E/M/A/D	0,55	0,034	0,042	0,055	0,070	105 (84 – 120)
		0,55	0,0013	0,0017	0,0022	0,0028	345 (280 – 390)
P8	E/M/A/D	0,55	0,034	0,042	0,055	0,070	100 (80 – 110)
		0,55	0,0013	0,0017	0,0022	0,0028	330 (270 – 360)
P11	E/M/A/D	0,55	0,034	0,042	0,055	0,070	85 (63 – 100)
		0,55	0,0013	0,0017	0,0022	0,0028	280 (210 – 320)
P12	E/M/A/D	0,55	0,034	0,040	0,050	0,060	49 (37 – 61)
		0,55	0,0013	0,0016	0,0020	0,0024	160 (130 – 200)
M1	E/M/A	0,55	0,034	0,042	0,055	0,070	100 (74 – 120)
		0,55	0,0013	0,0017	0,0022	0,0028	330 (250 – 390)
M2	E/M/A	0,55	0,034	0,042	0,055	0,070	80 (60 – 99)
		0,55	0,0013	0,0017	0,0022	0,0028	260 (200 – 320)
M3	E/M/A	0,55	0,034	0,042	0,055	0,070	70 (50 – 89)
		0,55	0,0013	0,0017	0,0022	0,0028	230 (170 – 290)
M4	E/M/A	0,55	0,034	0,042	0,055	0,070	50 (38 – 66)
		0,55	0,0013	0,0017	0,0022	0,0028	165 (130 – 210)
M5	E/M/A	0,55	0,034	0,042	0,055	0,070	43 (31 – 55)
		0,55	0,0013	0,0017	0,0022	0,0028	140 (110 – 180)
K1	E/M/A/D	0,55	0,034	0,042	0,055	0,070	125 (110 – 140)
		0,55	0,0013	0,0017	0,0022	0,0028	410 (370 – 450)
K2	E/M/A/D	0,55	0,034	0,042	0,055	0,070	105 (91 – 120)
		0,55	0,0013	0,0017	0,0022	0,0028	345 (300 – 390)
K3	E/M/A/D	0,55	0,034	0,042	0,055	0,070	90 (77 – 100)
		0,55	0,0013	0,0017	0,0022	0,0028	295 (260 – 320)
K4	E/M/A/D	0,55	0,034	0,042	0,055	0,070	100 (80 – 110)
		0,55	0,0013	0,0017	0,0022	0,0028	330 (270 – 360)
K5	E/M/A/D	0,55	0,034	0,042	0,055	0,070	60 (48 – 70)
		0,55	0,0013	0,0017	0,0022	0,0028	195 (160 – 220)
K6	E/M/A/D	0,55	0,034	0,042	0,055	0,070	85 (70 – 100)
		0,55	0,0013	0,0017	0,0022	0,0028	280 (230 – 320)
K7	E/M/A/D	0,55	0,034	0,042	0,055	0,070	75 (61 – 90)
		0,55	0,0013	0,0017	0,0022	0,0028	245 (210 – 290)
N1	E/M/A	0,30	0,034	0,042	0,055	0,070	590 (500 – 690)
		0,30	0,0013	0,0017	0,0022	0,0028	1925 (1700 – 2200)
N2	E/M/A	0,30	0,034	0,042	0,055	0,070	380 (320 – 440)
		0,30	0,0013	0,0017	0,0022	0,0028	1250 (1100 – 1400)
N3	E/M/A	0,30	0,034	0,042	0,055	0,070	255 (220 – 290)
		0,30	0,0013	0,0017	0,0022	0,0028	840 (730 – 950)
N11	E/M/A	0,30	0,034	0,042	0,055	0,070	295 (250 – 340)
		0,30	0,0013	0,0017	0,0022	0,0028	970 (830 – 1100)
S1	E	0,55	0,034	0,042	0,055	0,070	36 (29 – 42)
		0,55	0,0013	0,0017	0,0022	0,0028	120 (96 – 130)
S2	E	0,55	0,034	0,042	0,055	0,070	29 (23 – 34)
		0,55	0,0013	0,0017	0,0022	0,0028	95 (76 – 110)
S3	E	0,55	0,034	0,042	0,055	0,070	25 (20 – 29)
		0,55	0,0013	0,0017	0,0022	0,0028	80 (66 – 95)
S11	E	0,55	0,034	0,042	0,055	0,070	105 (78 – 120)
		0,55	0,0013	0,0017	0,0022	0,0028	345 (260 – 390)
S12	E	0,55	0,034	0,042	0,055	0,070	80 (60 – 99)
		0,55	0,0013	0,0017	0,0022	0,0028	260 (200 – 320)
S13	E	0,55	0,034	0,042	0,055	0,070	60 (47 – 76)
		0,55	0,0013	0,0017	0,0022	0,0028	195 (160 – 240)
TS1	A/D	0,30	0,034	0,042	0,055	0,070	250 (150 – 340)
		0,30	0,0013	0,0017	0,0022	0,0028	820 (500 – 1100)
TP1	A/D	0,30	0,034	0,042	0,055	0,070	250 (150 – 340)
		0,30	0,0013	0,0017	0,0022	0,0028	820 (500 – 1100)
GR1	A/D	0,30	0,034	0,042	0,055	0,070	590 (500 – 690)
		0,30	0,0013	0,0017	0,0022	0,0028	1925 (1700 – 2200)

XVE510

General purpose – Universal – Square – 2 Flutes – Corner radius

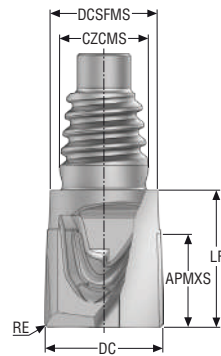

D

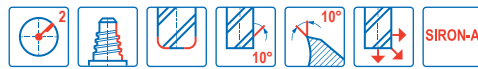

- Tolerances:
- DC= h10
- RE= ±0,015 mm



Designation	Item number	Length index	Tool shape	CZCMS	DC	DCSFMS	APMXS	Lf	RE	PCEDC	SW	Grade
					mm	mm	mm	mm	mm			SIRA
XVE510E10100D1R050Z2	10138003	1	D	E10	10,0	9,7	8,0	11,8	0,5	2	6	■
XVE510E12120D1R050Z2	10138004	1	D	E12	12,0	11,7	10,0	14,0	0,5	2	8	■

■ Stocked standard.

Universal

Steel and cast iron

Stainless steel and S-materials

Non ferrous

Hard

Plastic and CFRP

Graphite

X-Heads

Minimaster Plus

Minimaster

Cutting data – XVE510 Side milling

SMG		a _e /DC	a _p /DC	f _z		v _c	
				10	12		
Universal Steel and cast iron	P1	E/M/A/D 0,10 0.10	0,65 0.65	0,080 0.0032	0,095 0.0038	210 (170 – 250) 690 (560 – 820)	
	P2	E/M/A/D 0,10 0.10	0,65 0.65	0,080 0.0032	0,095 0.0038	205 (170 – 240) 670 (560 – 780)	
	P3	E/M/A/D 0,10 0.10	0,65 0.65	0,080 0.0032	0,095 0.0038	175 (150 – 210) 570 (500 – 680)	
	P4	E/M/A/D 0,10 0.10	0,65 0.65	0,080 0.0032	0,095 0.0038	155 (130 – 180) 510 (430 – 590)	
	P5	E/M/A/D 0,10 0.10	0,65 0.65	0,080 0.0032	0,095 0.0038	155 (130 – 180) 510 (430 – 590)	
	P6	E/M/A/D 0,10 0.10	0,65 0.65	0,080 0.0032	0,095 0.0038	175 (140 – 200) 570 (460 – 650)	
	P7	E/M/A/D 0,10 0.10	0,65 0.65	0,080 0.0032	0,095 0.0038	165 (140 – 190) 540 (460 – 620)	
	P8	E/M/A/D 0,10 0.10	0,65 0.65	0,080 0.0032	0,095 0.0038	155 (130 – 180) 510 (430 – 590)	
	P11	E/M/A/D 0,10 0.10	0,65 0.65	0,080 0.0032	0,095 0.0038	115 (82 – 140) 375 (270 – 450)	
	P12	E/M/A/D 0,10 0.10	0,65 0.65	0,070 0.0028	0,080 0.0032	70 (50 – 89) 230 (170 – 290)	
	Non ferrous	M1	E/M/A 0,10 0.10	0,65 0.65	0,080 0.0032	0,095 0.0038	135 (97 – 170) 445 (320 – 550)
		M2	E/M/A 0,10 0.10	0,65 0.65	0,080 0.0032	0,095 0.0038	110 (78 – 130) 360 (260 – 420)
M3		E/M/A 0,10 0.10	0,65 0.65	0,080 0.0032	0,095 0.0038	70 (55 – 85) 230 (190 – 270)	
M4		E/M/A 0,10 0.10	0,65 0.65	0,080 0.0032	0,095 0.0038	50 (41 – 64) 165 (140 – 200)	
M5		E/M/A 0,10 0.10	0,65 0.65	0,080 0.0032	0,095 0.0038	44 (35 – 53) 145 (120 – 170)	
Hard	K1	E/M/A/D 0,10 0.10	0,65 0.65	0,080 0.0032	0,095 0.0038	185 (160 – 210) 610 (530 – 680)	
	K2	E/M/A/D 0,10 0.10	0,65 0.65	0,080 0.0032	0,095 0.0038	160 (140 – 180) 520 (460 – 590)	
	K3	E/M/A/D 0,10 0.10	0,65 0.65	0,080 0.0032	0,095 0.0038	135 (120 – 150) 445 (400 – 490)	
	K4	E/M/A/D 0,10 0.10	0,65 0.65	0,080 0.0032	0,095 0.0038	130 (110 – 150) 425 (370 – 490)	
	K5	E/M/A/D 0,10 0.10	0,65 0.65	0,080 0.0032	0,095 0.0038	155 (130 – 180) 510 (430 – 590)	
	K6	E/M/A/D 0,10 0.10	0,65 0.65	0,080 0.0032	0,095 0.0038	230 (190 – 270) 750 (630 – 880)	
	K7	E/M/A/D 0,10 0.10	0,65 0.65	0,080 0.0032	0,095 0.0038	100 (83 – 110) 330 (280 – 360)	
Plastic and CFRP	N1	E/M/A 0,20 0.20	0,65 0.65	0,075 0.0030	0,090 0.0036	470 (410 – 530) 1550 (1400 – 1700)	
	N2	E/M/A 0,20 0.20	0,65 0.65	0,075 0.0030	0,090 0.0036	305 (270 – 340) 1000 (890 – 1100)	
	N3	E/M/A 0,20 0.20	0,65 0.65	0,075 0.0030	0,090 0.0036	200 (180 – 230) 660 (600 – 750)	
	N11	E/M/A 0,10 0.10	0,65 0.65	0,10 0.0040	0,12 0.0048	370 (300 – 440) 1225 (990 – 1400)	
X-Heads	S1	E 0,10 0.10	0,65 0.65	0,080 0.0032	0,095 0.0038	60 (39 – 85) 195 (130 – 270)	
	S2	E 0,10 0.10	0,65 0.65	0,080 0.0032	0,095 0.0038	55 (32 – 77) 180 (110 – 250)	
	S3	E 0,10 0.10	0,65 0.65	0,080 0.0032	0,095 0.0038	39 (24 – 54) 130 (79 – 170)	
	S11	E 0,10 0.10	0,65 0.65	0,080 0.0032	0,095 0.0038	120 (110 – 140) 395 (370 – 450)	
	S12	E 0,10 0.10	0,65 0.65	0,080 0.0032	0,095 0.0038	95 (78 – 100) 310 (260 – 320)	
	S13	E 0,10 0.10	0,65 0.65	0,080 0.0032	0,095 0.0038	70 (61 – 84) 230 (210 – 270)	
Minimaster Plus	TS1	A/D 0,10 0.10	0,65 0.65	0,080 0.0032	0,095 0.0038	540 (470 – 620) 1775 (1600 – 2000)	
	TP1	A/D 0,10 0.10	0,65 0.65	0,080 0.0032	0,095 0.0038	540 (470 – 620) 1775 (1600 – 2000)	
Minimaster	GR1	A/D 0,20 0.20	0,65 0.65	0,10 0.0040	0,12 0.0048	570 (510 – 630) 1875 (1700 – 2000)	

Cutting data – XVE510 Slot milling

SMG		a _p /DC	f _z		v _c
			10	12	
P1	E/M/A/D	0,50	0,050	0,060	135 (110 – 160)
		0,50	0,0020	0,0024	445 (370 – 520)
P2	E/M/A/D	0,50	0,050	0,060	130 (110 – 150)
		0,50	0,0020	0,0024	425 (370 – 490)
P3	E/M/A/D	0,50	0,050	0,060	115 (91 – 130)
		0,50	0,0020	0,0024	375 (300 – 420)
P4	E/M/A/D	0,50	0,050	0,060	100 (80 – 110)
		0,50	0,0020	0,0024	330 (270 – 360)
P5	E/M/A/D	0,50	0,050	0,060	100 (81 – 120)
		0,50	0,0020	0,0024	330 (270 – 390)
P6	E/M/A/D	0,50	0,050	0,060	110 (90 – 130)
		0,50	0,0020	0,0024	360 (300 – 420)
P7	E/M/A/D	0,50	0,050	0,060	105 (85 – 120)
		0,50	0,0020	0,0024	345 (280 – 390)
P8	E/M/A/D	0,50	0,050	0,060	100 (81 – 120)
		0,50	0,0020	0,0024	330 (270 – 390)
P11	E/M/A/D	0,50	0,050	0,060	75 (53 – 94)
		0,50	0,0020	0,0024	245 (180 – 300)
P12	E/M/A/D	0,40	0,040	0,048	46 (33 – 58)
		0,40	0,0016	0,0019	150 (110 – 190)
M1	E/M/A	0,50	0,050	0,060	85 (62 – 110)
		0,50	0,0020	0,0024	280 (210 – 360)
M2	E/M/A	0,50	0,050	0,060	70 (50 – 89)
		0,50	0,0020	0,0024	230 (170 – 290)
M3	E/M/A	0,50	0,050	0,060	45 (35 – 54)
		0,50	0,0020	0,0024	150 (120 – 170)
M4	E/M/A	0,38	0,050	0,060	34 (27 – 41)
		0,38	0,0020	0,0024	110 (89 – 130)
M5	E/M/A	0,38	0,050	0,060	28 (23 – 34)
		0,38	0,0020	0,0024	90 (76 – 110)
K1	E/M/A/D	0,50	0,050	0,060	120 (100 – 130)
		0,50	0,0020	0,0024	395 (330 – 420)
K2	E/M/A/D	0,50	0,050	0,060	105 (87 – 120)
		0,50	0,0020	0,0024	345 (290 – 390)
K3	E/M/A/D	0,50	0,050	0,060	90 (74 – 100)
		0,50	0,0020	0,0024	295 (250 – 320)
K4	E/M/A/D	0,50	0,050	0,060	85 (70 – 97)
		0,50	0,0020	0,0024	280 (230 – 310)
K5	E/M/A/D	0,50	0,050	0,060	100 (80 – 120)
		0,50	0,0020	0,0024	330 (270 – 390)
K6	E/M/A/D	0,50	0,050	0,060	150 (120 – 170)
		0,50	0,0020	0,0024	490 (400 – 550)
K7	E/M/A/D	0,50	0,050	0,060	65 (54 – 74)
		0,50	0,0020	0,0024	215 (180 – 240)
N1	E/M/A	0,50	0,050	0,060	350 (300 – 390)
		0,50	0,0020	0,0024	1150 (990 – 1200)
N2	E/M/A	0,50	0,050	0,060	225 (200 – 250)
		0,50	0,0020	0,0024	740 (660 – 820)
N3	E/M/A	0,50	0,050	0,060	150 (130 – 170)
		0,50	0,0020	0,0024	490 (430 – 550)
N11	E/M/A	0,50	0,050	0,060	250 (200 – 290)
		0,50	0,0020	0,0024	820 (660 – 950)
S1	E	0,50	0,050	0,060	40 (25 – 54)
		0,50	0,0020	0,0024	130 (83 – 170)
S2	E	0,50	0,050	0,060	35 (20 – 49)
		0,50	0,0020	0,0024	115 (66 – 160)
S3	E	0,50	0,050	0,060	25 (15 – 34)
		0,50	0,0020	0,0024	80 (50 – 110)
S11	E	0,50	0,050	0,060	80 (65 – 90)
		0,50	0,0020	0,0024	260 (220 – 290)
S12	E	0,50	0,050	0,060	60 (50 – 69)
		0,50	0,0020	0,0024	195 (170 – 220)
S13	E	0,42	0,050	0,060	47 (39 – 54)
		0,42	0,0020	0,0024	155 (130 – 170)
TS1	A/D	0,50	0,050	0,060	350 (300 – 390)
		0,50	0,0020	0,0024	1150 (990 – 1200)
TP1	A/D	0,50	0,050	0,060	350 (300 – 390)
		0,50	0,0020	0,0024	1150 (990 – 1200)
GR1	A/D	0,50	0,050	0,060	450 (400 – 490)
		0,50	0,0020	0,0024	1475 (1400 – 1600)

Universal
Steel and cast iron
Stainless steel and S-materials
Non ferrous
Hard
Plastic and cfrp
Graphite
X-Heads
Minimaster Plus
Minimaster

XVB510

General purpose – Universal – Ball nose – 2 Flutes

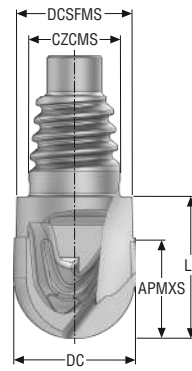

D

- Tolerances:
- DC= h9
- RE= ±0,01 mm

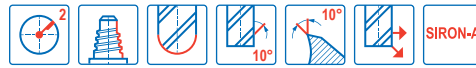

Designation	Item number	Length index	Tool shape	CZCMS	DC	DCSFMS	APMXS	LF	PCEDC	SW	Grade
					mm	mm	mm	mm			SIRA
XVB510E10100D1BZ2	10138005	1	D	E10	10,0	9,7	8,0	11,8	2	6	■
XVB510E12120D1BZ2	10138006	1	D	E12	12,0	11,7	10,0	14,0	2	8	■
XVB510E16160D1BZ2	10138007	1	D	E16	16,0	15,5	13,0	18,1	2	10	■

■ Stocked standard.

Universal
Steel and cast iron
Stainless steel and S-materials
Non ferrous
Hard
Plastic and cfrp
Graphite
X-Heads
Minimaster Plus
Minimaster

XVB510

General purpose – Universal – Ball nose – 2 Flutes – Inch

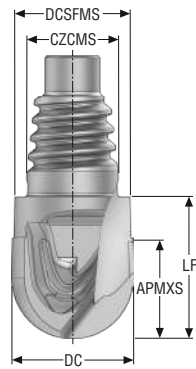

D

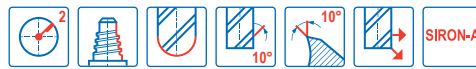

- Tolerances:
- DC= h9
- RE= ±.0004 Inch



Designation	Item number	Length index	Tool shape	CZCMS	DC	DCSFMS	APMXS	LF	PCEDC	SW	Grade
					<i>Inch</i>	<i>Inch</i>	<i>Inch</i>	<i>Inch</i>			SIRA
XVB510E10.375D1BZ2	10138008	1	D	E10	0.375	0.364	0.315	0.465	2	6	■
XVB510E12.500D1BZ2	10138009	1	D	E12	0.500	0.484	0.413	0.551	2	8	■
XVB510E16.625D1BZ2	10138010	1	D	E16	0.624	0.610	0.512	0.713	2	10	■

■ Stocked standard.

Universal

Steel and cast iron

Stainless steel and S-materials

Non ferrous

Hard

Plastic and CFRP

Graphite

X-Heads

Minimaster Plus

Minimaster

Cutting data – XVB510 Copy milling roughing

SMG		a _e /DC	a _p /DC	f _z			v _c
				10	12	16	
P1	E/M/A/D	0,10	0,65	0,070	0,085	0,11	185 (150 – 210)
		0.10	0.65	0.0028	0.0034	0.0044	610 (500 – 680)
P2	E/M/A/D	0,10	0,65	0,070	0,085	0,11	180 (150 – 210)
		0.10	0.65	0.0028	0.0034	0.0044	590 (500 – 680)
P3	E/M/A/D	0,10	0,65	0,070	0,085	0,11	155 (130 – 180)
		0.10	0.65	0.0028	0.0034	0.0044	510 (430 – 590)
P4	E/M/A/D	0,10	0,65	0,070	0,085	0,11	135 (110 – 160)
		0.10	0.65	0.0028	0.0034	0.0044	445 (370 – 520)
P5	E/M/A/D	0,10	0,65	0,070	0,085	0,11	135 (110 – 160)
		0.10	0.65	0.0028	0.0034	0.0044	445 (370 – 520)
P6	E/M/A/D	0,10	0,65	0,070	0,085	0,11	150 (130 – 180)
		0.10	0.65	0.0028	0.0034	0.0044	490 (430 – 590)
P7	E/M/A/D	0,10	0,65	0,070	0,085	0,11	145 (120 – 170)
		0.10	0.65	0.0028	0.0034	0.0044	475 (400 – 550)
P8	E/M/A/D	0,10	0,65	0,070	0,085	0,11	135 (110 – 160)
		0.10	0.65	0.0028	0.0034	0.0044	445 (370 – 520)
P11	E/M/A/D	0,10	0,65	0,070	0,085	0,11	65 (50 – 78)
		0.10	0.65	0.0028	0.0034	0.0044	215 (170 – 250)
P12	E/M/A/D	0,10	0,65	0,060	0,075	0,090	39 (30 – 47)
		0.10	0.65	0.0024	0.0030	0.0036	130 (99 – 150)
M1	E/M/A	0,10	0,65	0,070	0,085	0,11	75 (59 – 91)
		0.10	0.65	0.0028	0.0034	0.0044	245 (200 – 290)
M2	E/M/A	0,10	0,65	0,070	0,085	0,11	60 (48 – 74)
		0.10	0.65	0.0028	0.0034	0.0044	195 (160 – 240)
M3	E/M/A	0,10	0,65	0,070	0,085	0,11	60 (48 – 74)
		0.10	0.65	0.0028	0.0034	0.0044	195 (160 – 240)
M4	E/M/A	0,10	0,65	0,070	0,085	0,11	46 (36 – 55)
		0.10	0.65	0.0028	0.0034	0.0044	150 (120 – 180)
M5	E/M/A	0,10	0,65	0,070	0,085	0,11	38 (30 – 46)
		0.10	0.65	0.0028	0.0034	0.0044	125 (99 – 150)
K1	E/M/A/D	0,10	0,65	0,070	0,085	0,11	180 (150 – 210)
		0.10	0.65	0.0028	0.0034	0.0044	590 (500 – 680)
K2	E/M/A/D	0,10	0,65	0,070	0,085	0,11	155 (130 – 180)
		0.10	0.65	0.0028	0.0034	0.0044	510 (430 – 590)
K3	E/M/A/D	0,10	0,65	0,070	0,085	0,11	130 (110 – 150)
		0.10	0.65	0.0028	0.0034	0.0044	425 (370 – 490)
K4	E/M/A/D	0,10	0,65	0,070	0,085	0,11	125 (110 – 150)
		0.10	0.65	0.0028	0.0034	0.0044	410 (370 – 490)
K5	E/M/A/D	0,10	0,65	0,070	0,085	0,11	80 (63 – 94)
		0.10	0.65	0.0028	0.0034	0.0044	260 (210 – 300)
K6	E/M/A/D	0,10	0,65	0,070	0,085	0,11	115 (93 – 130)
		0.10	0.65	0.0028	0.0034	0.0044	375 (310 – 420)
K7	E/M/A/D	0,10	0,65	0,070	0,085	0,11	100 (81 – 120)
		0.10	0.65	0.0028	0.0034	0.0044	330 (270 – 390)
N1	E/M/A	0,10	0,65	0,10	0,12	0,15	445 (390 – 500)
		0.10	0.65	0.0040	0.0048	0.0060	1450 (1300 – 1600)
N2	E/M/A	0,10	0,65	0,10	0,12	0,15	285 (250 – 320)
		0.10	0.65	0.0040	0.0048	0.0060	940 (830 – 1000)
N3	E/M/A	0,10	0,65	0,10	0,12	0,15	190 (170 – 210)
		0.10	0.65	0.0040	0.0048	0.0060	620 (560 – 680)
N11	E/M/A	0,10	0,65	0,070	0,085	0,11	335 (270 – 400)
		0.10	0.65	0.0028	0.0034	0.0044	1100 (890 – 1300)
S1	E	0,050	0,65	0,060	0,070	0,095	55 (33 – 76)
		0.050	0.65	0.0024	0.0028	0.0038	180 (110 – 240)
S2	E	0,050	0,65	0,060	0,070	0,095	44 (27 – 61)
		0.050	0.65	0.0024	0.0028	0.0038	145 (89 – 200)
S3	E	0,050	0,65	0,060	0,070	0,095	38 (23 – 52)
		0.050	0.65	0.0024	0.0028	0.0038	125 (76 – 170)
S11	E	0,10	0,65	0,070	0,085	0,11	105 (88 – 120)
		0.10	0.65	0.0028	0.0034	0.0044	345 (290 – 390)
S12	E	0,10	0,65	0,070	0,085	0,11	80 (68 – 94)
		0.10	0.65	0.0028	0.0034	0.0044	260 (230 – 300)
S13	E	0,10	0,65	0,070	0,085	0,11	65 (53 – 73)
		0.10	0.65	0.0028	0.0034	0.0044	215 (180 – 230)
TS1	A/D	0,10	0,65	0,10	0,12	0,15	445 (390 – 500)
		0.10	0.65	0.0040	0.0048	0.0060	1450 (1300 – 1600)
TP1	A/D	0,10	0,65	0,10	0,12	0,15	445 (390 – 500)
		0.10	0.65	0.0040	0.0048	0.0060	1450 (1300 – 1600)
GR1	A/D	0,10	0,65	0,070	0,085	0,11	630 (570 – 700)
		0.10	0.65	0.0028	0.0034	0.0044	2075 (1900 – 2200)

Cutting data – XVB510 Copy milling roughing inch

SMG		a _d /DC	a _p /DC	f _z			v _c
				3/8	1/2	5/8	
P1	E/M/A/D	0,10	0,65	0,070	0,085	0,11	365 (320 – 420)
		0,10	0,65	0,0028	0,0034	0,0044	1200 (1100 – 1300)
P2	E/M/A/D	0,10	0,65	0,070	0,085	0,11	355 (310 – 400)
		0,10	0,65	0,0028	0,0034	0,0044	1175 (1100 – 1300)
P3	E/M/A/D	0,10	0,65	0,070	0,085	0,11	305 (270 – 350)
		0,10	0,65	0,0028	0,0034	0,0044	1000 (890 – 1100)
P4	E/M/A/D	0,10	0,65	0,070	0,085	0,11	270 (230 – 310)
		0,10	0,65	0,0028	0,0034	0,0044	890 (760 – 1000)
P5	E/M/A/D	0,10	0,65	0,070	0,085	0,11	175 (140 – 210)
		0,10	0,65	0,0028	0,0034	0,0044	570 (460 – 680)
P6	E/M/A/D	0,10	0,65	0,070	0,085	0,11	195 (160 – 240)
		0,10	0,65	0,0028	0,0034	0,0044	640 (530 – 780)
P7	E/M/A/D	0,10	0,65	0,070	0,085	0,11	185 (150 – 220)
		0,10	0,65	0,0028	0,0034	0,0044	610 (500 – 720)
P8	E/M/A/D	0,10	0,65	0,070	0,085	0,11	175 (140 – 210)
		0,10	0,65	0,0028	0,0034	0,0044	570 (460 – 680)
P11	E/M/A/D	0,10	0,65	0,070	0,085	0,11	155 (130 – 180)
		0,10	0,65	0,0028	0,0034	0,0044	510 (430 – 590)
P12	E/M/A/D	0,10	0,65	0,060	0,075	0,090	95 (78 – 110)
		0,10	0,65	0,0024	0,0030	0,0036	310 (260 – 360)
M1	E/M/A	0,10	0,65	0,070	0,085	0,11	185 (160 – 210)
		0,10	0,65	0,0028	0,0034	0,0044	610 (530 – 680)
M2	E/M/A	0,10	0,65	0,070	0,085	0,11	150 (130 – 170)
		0,10	0,65	0,0028	0,0034	0,0044	490 (430 – 550)
M3	E/M/A	0,10	0,65	0,070	0,085	0,11	120 (95 – 140)
		0,10	0,65	0,0028	0,0034	0,0044	395 (320 – 450)
M4	E/M/A	0,10	0,65	0,070	0,085	0,11	90 (71 – 110)
		0,10	0,65	0,0028	0,0034	0,0044	295 (240 – 360)
M5	E/M/A	0,10	0,65	0,070	0,085	0,11	75 (59 – 92)
		0,10	0,65	0,0028	0,0034	0,0044	245 (200 – 300)
K1	E/M/A/D	0,10	0,65	0,070	0,085	0,11	360 (310 – 410)
		0,10	0,65	0,0028	0,0034	0,0044	1175 (1100 – 1300)
K2	E/M/A/D	0,10	0,65	0,070	0,085	0,11	310 (270 – 350)
		0,10	0,65	0,0028	0,0034	0,0044	1025 (890 – 1100)
K3	E/M/A/D	0,10	0,65	0,070	0,085	0,11	265 (230 – 300)
		0,10	0,65	0,0028	0,0034	0,0044	870 (760 – 980)
K4	E/M/A/D	0,10	0,65	0,070	0,085	0,11	250 (220 – 280)
		0,10	0,65	0,0028	0,0034	0,0044	820 (730 – 910)
K5	E/M/A/D	0,10	0,65	0,070	0,085	0,11	100 (79 – 120)
		0,10	0,65	0,0028	0,0034	0,0044	330 (260 – 390)
K6	E/M/A/D	0,10	0,65	0,070	0,085	0,11	150 (120 – 180)
		0,10	0,65	0,0028	0,0034	0,0044	490 (400 – 590)
K7	E/M/A/D	0,10	0,65	0,070	0,085	0,11	130 (110 – 160)
		0,10	0,65	0,0028	0,0034	0,0044	425 (370 – 520)
N1	E/M/A	0,10	0,65	0,10	0,12	0,15	510 (390 – 630)
		0,10	0,65	0,0040	0,0048	0,0060	1675 (1300 – 2000)
N2	E/M/A	0,10	0,65	0,10	0,12	0,15	330 (250 – 400)
		0,10	0,65	0,0040	0,0048	0,0060	1075 (830 – 1300)
N3	E/M/A	0,10	0,65	0,10	0,12	0,15	220 (170 – 270)
		0,10	0,65	0,0040	0,0048	0,0060	720 (560 – 880)
N11	E/M/A	0,10	0,65	0,070	0,085	0,11	405 (270 – 530)
		0,10	0,65	0,0028	0,0034	0,0044	1325 (890 – 1700)
S1	E	0,050	0,65	0,060	0,070	0,095	110 (66 – 150)
		0,050	0,65	0,0024	0,0028	0,0038	360 (220 – 490)
S2	E	0,050	0,65	0,060	0,070	0,095	90 (53 – 120)
		0,050	0,65	0,0024	0,0028	0,0038	295 (180 – 390)
S3	E	0,050	0,65	0,060	0,070	0,095	75 (46 – 100)
		0,050	0,65	0,0024	0,0028	0,0038	245 (160 – 320)
S11	E	0,10	0,65	0,070	0,085	0,11	175 (130 – 220)
		0,10	0,65	0,0028	0,0034	0,0044	570 (430 – 720)
S12	E	0,10	0,65	0,070	0,085	0,11	135 (95 – 170)
		0,10	0,65	0,0028	0,0034	0,0044	445 (320 – 550)
S13	E	0,10	0,65	0,070	0,085	0,11	105 (74 – 130)
		0,10	0,65	0,0028	0,0034	0,0044	345 (250 – 420)
TS1	A/D	0,10	0,65	0,10	0,12	0,15	320 (200 – 440)
		0,10	0,65	0,0040	0,0048	0,0060	1050 (660 – 1400)
TP1	A/D	0,10	0,65	0,10	0,12	0,15	320 (200 – 440)
		0,10	0,65	0,0040	0,0048	0,0060	1050 (660 – 1400)
GR1	A/D	0,10	0,65	0,070	0,085	0,11	850 (710 – 980)
		0,10	0,65	0,0028	0,0034	0,0044	2800 (2400 – 3200)

Universal
Steel and cast iron
Stainless steel and S-materials
Non ferrous
Hard
Plastic and CFRP
Graphite
X-Heads
Minimaster Plus
Minimaster

XVC506/509/512

General purpose – Universal – Chamfer – 2 Flutes

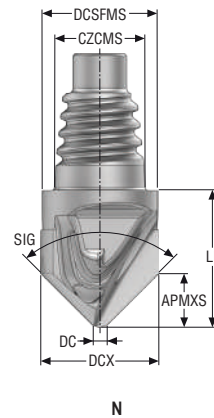

- Tolerances:
- SIG= ±1°

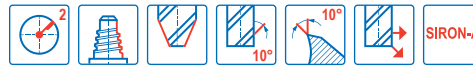

Designation	Item number	Length index	Tool shape	CZCMS	DCX	DC	DCSFMS	APMXS	LF	SIG°	PCEDC	SW	Grade
					mm	mm	mm	mm	mm				SIRA
XVC506E10100N1SZ2	10138012	1	N	E10	10,0	1,5	9,7	7,23	11,8	60,0	2	6	■
XVC506E12120N1SZ2	10138013	1	N	E12	12,0	1,5	11,7	7,73	14,0	60,0	2	8	■
XVC509E10100N1SZ2	10138014	1	N	E10	10,0	1,5	9,7	4,23	11,8	90,0	2	6	■
XVC509E12120N1SZ2	10138015	1	N	E12	12,0	1,5	11,7	5,23	14,0	90,0	2	8	■
XVC509E16160N1SZ2	10138016	1	N	E16	16,0	1,5	15,5	7,23	18,1	90,0	2	10	■
XVC512E12120N1SZ2	10138017	1	N	E12	12,0	1,5	11,7	3,03	14,0	120,0	2	8	■

■ Stocked standard.

Universal
Steel and cast iron
Stainless steel and S-materials
Non ferrous
Hard
Plastic and CFRP
Graphite
X-Heads
Minimaster Plus
Minimaster

Cutting data – XVC506 Chamfering

SMG		a _e /DC		a _p /DC		f _z		v _c
						10	12	
P1	E/M/A/D	0,10	2,0	0,25	0,26	200	(180 – 220)	
		0,10	2,0	0,010	0,010	660	(600 – 720)	
P2	E/M/A/D	0,10	2,0	0,25	0,26	195	(180 – 220)	
		0,10	2,0	0,010	0,010	640	(600 – 720)	
P3	E/M/A/D	0,10	2,0	0,24	0,25	170	(150 – 190)	
		0,10	2,0	0,0095	0,010	560	(500 – 620)	
P4	E/M/A/D	0,10	2,0	0,24	0,25	150	(130 – 160)	
		0,10	2,0	0,0095	0,010	490	(430 – 520)	
P5	E/M/A/D	0,10	2,0	0,24	0,25	150	(140 – 170)	
		0,10	2,0	0,0095	0,010	490	(460 – 550)	
P6	E/M/A/D	0,10	2,0	0,24	0,24	170	(150 – 190)	
		0,10	2,0	0,0095	0,0095	560	(500 – 620)	
P7	E/M/A/D	0,10	2,0	0,24	0,24	160	(140 – 180)	
		0,10	2,0	0,0095	0,0095	520	(460 – 590)	
P8	E/M/A/D	0,10	2,0	0,24	0,26	150	(140 – 170)	
		0,10	2,0	0,0095	0,010	490	(460 – 550)	
P11	E/M/A/D	0,10	2,0	0,24	0,24	105	(86 – 120)	
		0,10	2,0	0,0095	0,0095	345	(290 – 390)	
P12	E/M/A/D	0,10	1,6	0,15	0,16	65	(52 – 76)	
		0,10	1,6	0,0060	0,0065	215	(180 – 240)	
M1	E/M/A	0,10	2,0	0,26	0,28	125	(99 – 140)	
		0,10	2,0	0,010	0,011	410	(330 – 450)	
M2	E/M/A	0,10	2,0	0,24	0,25	100	(80 – 120)	
		0,10	2,0	0,0095	0,010	330	(270 – 390)	
M3	E/M/A	0,10	2,0	0,24	0,25	65	(45 – 84)	
		0,10	2,0	0,0095	0,010	215	(150 – 270)	
M4	E/M/A	0,10	1,5	0,19	0,20	47	(33 – 60)	
		0,10	1,5	0,0075	0,0080	155	(110 – 190)	
M5	E/M/A	0,10	1,5	0,19	0,20	39	(27 – 50)	
		0,10	1,5	0,0075	0,0080	130	(89 – 160)	
K1	E/M/A/D	0,10	2,0	0,25	0,26	200	(180 – 220)	
		0,10	2,0	0,010	0,010	660	(600 – 720)	
K2	E/M/A/D	0,10	2,0	0,22	0,24	175	(160 – 190)	
		0,10	2,0	0,0085	0,0095	570	(530 – 620)	
K3	E/M/A/D	0,10	2,0	0,22	0,24	150	(130 – 160)	
		0,10	2,0	0,0085	0,0095	490	(430 – 520)	
K4	E/M/A/D	0,10	2,0	0,22	0,24	140	(130 – 150)	
		0,10	2,0	0,0085	0,0095	460	(430 – 490)	
K5	E/M/A/D	0,10	2,0	0,20	0,22	85	(74 – 95)	
		0,10	2,0	0,0080	0,0085	280	(250 – 310)	
K6	E/M/A/D	0,10	2,0	0,22	0,24	125	(110 – 140)	
		0,10	2,0	0,0085	0,0095	410	(370 – 450)	
K7	E/M/A/D	0,10	2,0	0,20	0,22	110	(94 – 120)	
		0,10	2,0	0,0080	0,0085	360	(310 – 390)	
N1	E/M/A	0,10	2,0	0,24	0,25	600	(500 – 690)	
		0,10	2,0	0,0095	0,010	1975	(1700 – 2200)	
N2	E/M/A	0,10	2,0	0,24	0,25	385	(330 – 440)	
		0,10	2,0	0,0095	0,010	1275	(1100 – 1400)	
N3	E/M/A	0,10	2,0	0,24	0,25	255	(220 – 290)	
		0,10	2,0	0,0095	0,010	840	(730 – 950)	
N11	E/M/A	0,10	2,0	0,24	0,25	400	(350 – 450)	
		0,10	2,0	0,0095	0,010	1300	(1200 – 1400)	
S1	E	0,10	2,0	0,12	0,13	43	(15 – 71)	
		0,10	2,0	0,0048	0,0050	140	(50 – 230)	
S2	E	0,10	2,0	0,12	0,13	35	(12 – 57)	
		0,10	2,0	0,0048	0,0050	115	(40 – 180)	
S3	E	0,10	2,0	0,12	0,12	30	(10 – 49)	
		0,10	2,0	0,0048	0,0048	100	(33 – 160)	
S11	E	0,10	2,0	0,24	0,25	95	(72 – 120)	
		0,10	2,0	0,0095	0,010	310	(240 – 390)	
S12	E	0,10	2,0	0,24	0,25	75	(55 – 94)	
		0,10	2,0	0,0095	0,010	245	(190 – 300)	
S13	E	0,10	1,7	0,19	0,20	55	(43 – 72)	
		0,10	1,7	0,0075	0,0080	180	(150 – 230)	
H5	M/A	0,050	2,0	0,11	0,12	120	(110 – 140)	
		0,050	2,0	0,0044	0,0048	395	(370 – 450)	
H8	M/A	0,050	1,8	0,080	0,085	120	(99 – 130)	
		0,050	1,8	0,0032	0,0034	395	(330 – 420)	
H21	M/A	0,050	1,8	0,080	0,085	120	(99 – 130)	
		0,050	1,8	0,0032	0,0034	395	(330 – 420)	
H31	M/A	0,050	1,8	0,070	0,075	90	(75 – 100)	
		0,050	1,8	0,0028	0,0030	295	(250 – 320)	
TS1	A/D	0,10	2,0	0,17	0,18	260	(160 – 360)	
		0,10	2,0	0,0065	0,0070	850	(530 – 1100)	
TP1	A/D	0,10	2,0	0,17	0,18	260	(160 – 360)	
		0,10	2,0	0,0065	0,0070	850	(530 – 1100)	
GR1	A/D	0,10	2,0	0,24	0,25	600	(500 – 690)	
		0,10	2,0	0,0095	0,010	1975	(1700 – 2200)	

Universal
Steel and cast iron
Stainless steel and S-materials
Non ferrous
Hard
Plastic and cfrp
Graphite
X-Heads
Minimaster Plus
Minimaster

Cutting data – XVC509 Chamfering

SMG		a _e /DC	a _p /DC	f _z			v _c
				10	12	16	
P1	E/M/A/D	0,10	2,0	0,24	0,25	0,28	200 (180 – 220)
		0.10	2.0	0.0095	0.010	0.011	660 (600 – 720)
P2	E/M/A/D	0,10	2,0	0,24	0,26	0,28	195 (180 – 220)
		0.10	2.0	0.0095	0.010	0.011	640 (600 – 720)
P3	E/M/A/D	0,10	2,0	0,24	0,24	0,26	170 (150 – 190)
		0.10	2.0	0.0095	0.0095	0.010	560 (500 – 620)
P4	E/M/A/D	0,10	2,0	0,22	0,24	0,26	150 (130 – 160)
		0.10	2.0	0.0085	0.0095	0.010	490 (430 – 520)
P5	E/M/A/D	0,10	2,0	0,22	0,24	0,26	150 (140 – 170)
		0.10	2.0	0.0085	0.0095	0.010	490 (460 – 550)
P6	E/M/A/D	0,10	2,0	0,22	0,24	0,26	170 (150 – 190)
		0.10	2.0	0.0085	0.0095	0.010	560 (500 – 620)
P7	E/M/A/D	0,10	2,0	0,22	0,24	0,26	160 (140 – 180)
		0.10	2.0	0.0085	0.0095	0.010	520 (460 – 590)
P8	E/M/A/D	0,10	2,0	0,24	0,25	0,28	150 (130 – 160)
		0.10	2.0	0.0095	0.010	0.011	490 (430 – 520)
P11	E/M/A/D	0,10	2,0	0,22	0,24	0,26	105 (85 – 120)
		0.10	2.0	0.0085	0.0095	0.010	345 (280 – 390)
P12	E/M/A/D	0,10	1,6	0,14	0,15	0,17	60 (50 – 74)
		0.10	1.6	0.0055	0.0060	0.0065	195 (170 – 240)
M1	E/M/A	0,10	2,0	0,25	0,26	0,28	120 (98 – 140)
		0.10	2.0	0.010	0.010	0.011	395 (330 – 450)
M2	E/M/A	0,10	2,0	0,22	0,24	0,26	100 (80 – 120)
		0.10	2.0	0.0085	0.0095	0.010	330 (270 – 390)
M3	E/M/A	0,10	2,0	0,22	0,24	0,26	65 (45 – 84)
		0.10	2.0	0.0085	0.0095	0.010	215 (150 – 270)
M4	E/M/A	0,10	1,5	0,18	0,19	0,20	46 (33 – 60)
		0.10	1.5	0.0070	0.0075	0.0080	150 (110 – 190)
M5	E/M/A	0,10	1,5	0,18	0,19	0,20	39 (27 – 50)
		0.10	1.5	0.0070	0.0075	0.0080	130 (89 – 160)
K1	E/M/A/D	0,10	2,0	0,24	0,26	0,28	200 (180 – 220)
		0.10	2.0	0.0095	0.010	0.011	660 (600 – 720)
K2	E/M/A/D	0,10	2,0	0,22	0,24	0,26	175 (160 – 190)
		0.10	2.0	0.0085	0.0095	0.010	570 (530 – 620)
K3	E/M/A/D	0,10	2,0	0,22	0,24	0,26	145 (130 – 160)
		0.10	2.0	0.0085	0.0095	0.010	475 (430 – 520)
K4	E/M/A/D	0,10	2,0	0,22	0,24	0,26	140 (130 – 150)
		0.10	2.0	0.0085	0.0095	0.010	460 (430 – 490)
K5	E/M/A/D	0,10	2,0	0,20	0,22	0,24	85 (74 – 95)
		0.10	2.0	0.0080	0.0085	0.0095	280 (250 – 310)
K6	E/M/A/D	0,10	2,0	0,22	0,24	0,26	125 (110 – 130)
		0.10	2.0	0.0085	0.0095	0.010	410 (370 – 420)
K7	E/M/A/D	0,10	2,0	0,20	0,22	0,24	110 (94 – 120)
		0.10	2.0	0.0080	0.0085	0.0095	360 (310 – 390)
N1	E/M/A	0,10	2,0	0,22	0,24	0,26	600 (500 – 700)
		0.10	2.0	0.0085	0.0095	0.010	1975 (1700 – 2200)
N2	E/M/A	0,10	2,0	0,22	0,24	0,26	385 (330 – 450)
		0.10	2.0	0.0085	0.0095	0.010	1275 (1100 – 1400)
N3	E/M/A	0,10	2,0	0,22	0,24	0,26	255 (220 – 300)
		0.10	2.0	0.0085	0.0095	0.010	840 (730 – 980)
N11	E/M/A	0,10	2,0	0,22	0,24	0,26	400 (350 – 450)
		0.10	2.0	0.0085	0.0095	0.010	1300 (1200 – 1400)
S1	E	0,10	2,0	0,13	0,13	0,15	43 (15 – 71)
		0.10	2.0	0.0050	0.0050	0.0060	140 (50 – 230)
S2	E	0,10	2,0	0,13	0,13	0,15	35 (12 – 57)
		0.10	2.0	0.0050	0.0050	0.0060	115 (40 – 180)
S3	E	0,10	2,0	0,12	0,12	0,14	30 (10 – 50)
		0.10	2.0	0.0048	0.0048	0.0055	100 (33 – 160)
S11	E	0,10	2,0	0,22	0,24	0,26	100 (72 – 120)
		0.10	2.0	0.0085	0.0095	0.010	330 (240 – 390)
S12	E	0,10	2,0	0,22	0,24	0,26	75 (55 – 94)
		0.10	2.0	0.0085	0.0095	0.010	245 (190 – 300)
S13	E	0,10	1,7	0,19	0,20	0,22	55 (42 – 72)
		0.10	1.7	0.0075	0.0080	0.0085	180 (140 – 230)
H5	M/A	0,10	2,0	0,12	0,12	0,14	120 (110 – 140)
		0.10	2.0	0.0048	0.0048	0.0055	395 (370 – 450)
H8	M/A	0,10	1,8	0,085	0,090	0,10	120 (99 – 130)
		0.10	1.8	0.0034	0.0036	0.0040	395 (330 – 420)
H21	M/A	0,10	1,8	0,085	0,090	0,10	120 (99 – 130)
		0.10	1.8	0.0034	0.0036	0.0040	395 (330 – 420)
H31	M/A	0,10	1,8	0,075	0,080	0,085	90 (75 – 100)
		0.10	1.8	0.0030	0.0032	0.0034	295 (250 – 320)
TS1	A/D	0,10	2,0	0,22	0,24	0,26	250 (150 – 350)
		0.10	2.0	0.0085	0.0095	0.010	820 (500 – 1100)
TP1	A/D	0,10	2,0	0,22	0,24	0,26	250 (150 – 350)
		0.10	2.0	0.0085	0.0095	0.010	820 (500 – 1100)
GR1	A/D	0,10	2,0	0,22	0,24	0,26	600 (500 – 700)
		0.10	2.0	0.0085	0.0095	0.010	1975 (1700 – 2200)

Cutting data – XVC512 Chamfering

SMG		a _d /DC	a _p /DC	f _z		v _c
					12	
P1	E/M/A/D	0,10	1,3	0,36	165 (150 – 180)	
		0,10	1,3	0,014	540 (500 – 590)	
P2	E/M/A/D	0,10	1,3	0,36	160 (140 – 170)	
		0,10	1,3	0,014	520 (460 – 550)	
P3	E/M/A/D	0,10	1,3	0,34	135 (120 – 150)	
		0,10	1,3	0,013	445 (400 – 490)	
P4	E/M/A/D	0,10	1,3	0,34	120 (110 – 130)	
		0,10	1,3	0,013	395 (370 – 420)	
P5	E/M/A/D	0,10	1,3	0,34	120 (110 – 130)	
		0,10	1,3	0,013	395 (370 – 420)	
P6	E/M/A/D	0,10	1,3	0,32	135 (120 – 150)	
		0,10	1,3	0,013	445 (400 – 490)	
P7	E/M/A/D	0,10	1,3	0,32	125 (120 – 140)	
		0,10	1,3	0,013	410 (400 – 450)	
P8	E/M/A/D	0,10	1,3	0,34	120 (110 – 130)	
		0,10	1,3	0,013	395 (370 – 420)	
P11	E/M/A/D	0,10	1,3	0,32	85 (68 – 100)	
		0,10	1,3	0,013	280 (230 – 320)	
P12	E/M/A/D	0,10	1,3	0,22	50 (41 – 61)	
		0,10	1,3	0,0085	165 (140 – 200)	
M1	E/M/A	0,10	1,3	0,36	100 (80 – 110)	
		0,10	1,3	0,014	330 (270 – 360)	
M2	E/M/A	0,10	1,3	0,34	80 (65 – 96)	
		0,10	1,3	0,013	260 (220 – 310)	
M3	E/M/A	0,10	1,3	0,34	50 (37 – 68)	
		0,10	1,3	0,013	165 (130 – 220)	
M4	E/M/A	0,10	1,3	0,30	39 (28 – 51)	
		0,10	1,3	0,012	130 (92 – 160)	
M5	E/M/A	0,10	1,3	0,30	33 (23 – 42)	
		0,10	1,3	0,012	110 (76 – 130)	
K1	E/M/A/D	0,10	1,3	0,36	160 (140 – 180)	
		0,10	1,3	0,014	520 (460 – 590)	
K2	E/M/A/D	0,10	1,3	0,32	140 (130 – 150)	
		0,10	1,3	0,013	460 (430 – 490)	
K3	E/M/A/D	0,10	1,3	0,32	115 (110 – 130)	
		0,10	1,3	0,013	375 (370 – 420)	
K4	E/M/A/D	0,10	1,3	0,32	110 (98 – 120)	
		0,10	1,3	0,013	360 (330 – 390)	
K5	E/M/A/D	0,10	1,3	0,30	65 (58 – 75)	
		0,10	1,3	0,012	215 (200 – 240)	
K6	E/M/A/D	0,10	1,3	0,32	100 (86 – 110)	
		0,10	1,3	0,013	330 (290 – 360)	
K7	E/M/A/D	0,10	1,3	0,30	85 (74 – 96)	
		0,10	1,3	0,012	280 (250 – 310)	
N1	E/M/A	0,10	1,3	0,34	480 (410 – 560)	
		0,10	1,3	0,013	1575 (1400 – 1800)	
N2	E/M/A	0,10	1,3	0,34	310 (260 – 360)	
		0,10	1,3	0,013	1025 (860 – 1100)	
N3	E/M/A	0,10	1,3	0,34	205 (180 – 240)	
		0,10	1,3	0,013	670 (600 – 780)	
N11	E/M/A	0,10	1,3	0,34	320 (290 – 360)	
		0,10	1,3	0,013	1050 (960 – 1100)	
S1	E	0,10	1,3	0,19	35 (12 – 58)	
		0,10	1,3	0,0075	115 (40 – 190)	
S2	E	0,10	1,3	0,19	29 (9,6 – 47)	
		0,10	1,3	0,0075	95 (32 – 150)	
S3	E	0,10	1,3	0,17	25 (8,3 – 41)	
		0,10	1,3	0,0065	80 (28 – 130)	
S11	E	0,10	1,3	0,34	80 (58 – 98)	
		0,10	1,3	0,013	260 (200 – 320)	
S12	E	0,10	1,3	0,34	60 (45 – 76)	
		0,10	1,3	0,013	195 (150 – 240)	
S13	E	0,10	1,3	0,30	47 (35 – 59)	
		0,10	1,3	0,012	155 (120 – 190)	
H5	M/A	0,10	1,3	0,17	100 (83 – 110)	
		0,10	1,3	0,0065	330 (280 – 360)	
H8	M/A	0,10	1,3	0,13	100 (84 – 110)	
		0,10	1,3	0,0050	330 (280 – 360)	
H21	M/A	0,10	1,3	0,13	100 (84 – 110)	
		0,10	1,3	0,0050	330 (280 – 360)	
H31	M/A	0,10	1,3	0,11	75 (64 – 88)	
		0,10	1,3	0,0044	245 (210 – 280)	
TS1	A/D	0,10	1,3	0,34	200 (130 – 280)	
		0,10	1,3	0,013	660 (430 – 910)	
TP1	A/D	0,10	1,3	0,34	200 (130 – 280)	
		0,10	1,3	0,013	660 (430 – 910)	
GR1	A/D	0,10	1,3	0,34	480 (410 – 560)	
		0,10	1,3	0,013	1575 (1400 – 1800)	

Universal
Steel and cast iron
Stainless steel and S-materials
Non ferrous
Hard
Plastic and cfrp
Graphite
X-Heads
Minimaster Plus
Minimaster

XVK310

General purpose – Universal – Concave – 4 Flutes

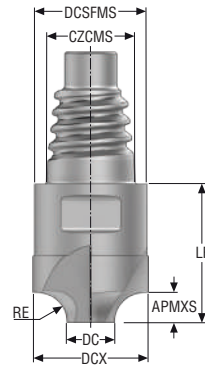

- Tolerances:
- RE= ≤5= ±0,05 mm
- RE= >5= ±0,01 mm

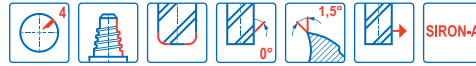

Designation	Item number	Length index	Tool shape	CZCMS	DCX	DC	DCSFMS	APMXS	LF	RE	PCEDC	SW	Grade
					mm	mm	mm	mm	mm	mm			SIRA
XVK310E12120D1K300Z4	10137998	1	D	E12	12,0	5,0	11,7	3,0	14,5	3,0	4	10	■
XVK310E12120D1K400Z4	10137999	1	D	E12	12,0	4,0	11,7	4,0	14,5	4,0	4	10	■
XVK310E16160D1K500Z4	10138000	1	D	E16	16,0	6,0	15,5	5,0	18,7	5,0	4	12	■
XVK310E20200D1K600Z4	10138001	1	D	E20	20,0	8,0	19,3	6,0	21,3	6,0	4	16	■

■ Stocked standard.

Universal
Steel and cast iron
Stainless steel and S-materials
Non ferrous
Hard
Plastic and cfrp
Graphite
X-Heads
Minimaster Plus
Minimaster

Cutting data – XVK310 Side milling roughing

SMG		a _p /D _c	f _z			v _c
			12	16	20	
P1	E/M/A/D	0,24	0,048	0,065	0,080	290 (195 – 310)
		0,24	0,0019	0,0026	0,0032	950 (640 – 1100)
P2	E/M/A/D	0,24	0,050	0,065	0,080	280 (190 – 305)
		0,24	0,0022	0,0026	0,0032	910 (620 – 1000)
P3	E/M/A/D	0,24	0,046	0,060	0,075	240 (165 – 260)
		0,24	0,0018	0,0024	0,003	790 (540 – 850)
P4	E/M/A/D	0,24	0,046	0,060	0,075	210 (145 – 230)
		0,24	0,0018	0,0024	0,003	680 (475 – 760)
P5	E/M/A/D	0,24	0,046	0,060	0,075	205 (135 – 220)
		0,24	0,0018	0,0024	0,003	670 (445 – 730)
P6	E/M/A/D	0,24	0,044	0,060	0,075	230 (155 – 245)
		0,24	0,0017	0,0024	0,003	760 (510 – 800)
P7	E/M/A/D	0,24	0,044	0,060	0,075	215 (145 – 230)
		0,24	0,0017	0,0024	0,003	710 (475 – 760)
P8	E/M/A/D	0,24	0,046	0,060	0,075	205 (140 – 220)
		0,24	0,0018	0,0024	0,003	670 (460 – 730)
P11	E/M/A/D	0,24	0,044	0,060	0,075	210 (140 – 225)
		0,24	0,0017	0,0024	0,003	680 (460 – 740)
M1	E/M/A	0,24	0,050	0,065	0,080	255 (170 – 270)
		0,24	0,0022	0,0026	0,0032	840 (560 – 890)
M2	E/M/A	0,24	0,046	0,060	0,075	205 (135 – 220)
		0,24	0,0018	0,0024	0,003	670 (445 – 730)
M3	E/M/A	0,24	0,036	0,048	0,060	150 (105 – 165)
		0,24	0,0014	0,0019	0,0024	490 (345 – 540)
M4	E/M/A	0,24	0,032	0,042	0,050	110 (75 – 120)
		0,24	0,0013	0,0017	0,0022	360 (250 – 400)
M5	E/M/A	0,24	0,032	0,042	0,050	95 (65 – 100)
		0,24	0,0013	0,0017	0,0022	310 (220 – 320)
K1	E/M/A/D	0,24	0,046	0,060	0,075	205 (135 – 220)
		0,24	0,0018	0,0024	0,003	670 (445 – 730)
K2	E/M/A/D	0,24	0,040	0,055	0,065	175 (120 – 190)
		0,24	0,0016	0,0022	0,0026	570 (400 – 620)
K3	E/M/A/D	0,24	0,040	0,055	0,065	150 (100 – 160)
		0,24	0,0016	0,0022	0,0026	490 (320 – 530)
K4	E/M/A/D	0,24	0,040	0,055	0,065	140 (95 – 150)
		0,24	0,0016	0,0022	0,0026	460 (310 – 490)
K5	E/M/A/D	0,24	0,036	0,050	0,060	85 (55 – 90)
		0,24	0,0014	0,0022	0,0024	280 (180 – 300)
K6	E/M/A/D	0,24	0,040	0,055	0,065	125 (85 – 135)
		0,24	0,0016	0,0022	0,0026	410 (280 – 445)
K7	E/M/A/D	0,24	0,036	0,050	0,060	105 (70 – 115)
		0,24	0,0014	0,0022	0,0024	345 (220 – 375)
N1	E/M/A	0,24	0,046	0,060	0,075	315 (215 – 340)
		0,24	0,0018	0,0024	0,003	1025 (710 – 1125)
N2	E/M/A	0,24	0,046	0,060	0,075	205 (135 – 220)
		0,24	0,0018	0,0024	0,003	670 (445 – 730)
N3	E/M/A	0,24	0,046	0,060	0,075	135 (90 – 145)
		0,24	0,0018	0,0024	0,003	445 (300 – 475)
N11	E/M/A	0,24	0,046	0,060	0,075	205 (135 – 220)
		0,24	0,0018	0,0024	0,003	670 (445 – 730)
S1	E	0,24	0,048	0,065	0,080	205 (140 – 220)
		0,24	0,0019	0,0026	0,0032	670 (460 – 730)
S2	E	0,24	0,048	0,065	0,080	205 (140 – 220)
		0,24	0,0019	0,0026	0,0032	670 (460 – 730)
S3	E	0,24	0,046	0,060	0,075	205 (135 – 220)
		0,24	0,0018	0,0024	0,003	670 (445 – 730)
S11	E	0,24	0,046	0,060	0,075	265 (180 – 285)
		0,24	0,0018	0,0024	0,003	870 (590 – 940)
S12	E	0,24	0,046	0,060	0,075	205 (135 – 220)
		0,24	0,0018	0,0024	0,003	670 (445 – 730)
S13	E	0,24	0,040	0,050	0,065	155 (105 – 165)
		0,24	0,0016	0,0022	0,0026	510 (345 – 540)
TS1	A/D	0,24	0,046	0,060	0,075	205 (135 – 220)
		0,24	0,0018	0,0024	0,003	670 (445 – 730)
TP1	A/D	0,24	0,046	0,060	0,075	205 (135 – 220)
		0,24	0,0018	0,0024	0,003	670 (445 – 730)
GR1	A/D	0,24	0,046	0,060	0,075	205 (135 – 220)
		0,24	0,0018	0,0024	0,003	670 (445 – 730)







Universal
Steel and cast iron
Stainless steel and S-materials
Non ferrous
Hard
Plastic and CFRP
Graphite
X-Heads
Minimaster Plus
Minimaster

Recalculation

Use original standard version side rough cutting data then recalculate parameters!										Use original standard version slotting cutting data then recalculate parameters!							
Straight	Slotting		Side rough			Side finish					Ramping		Helical			Drilling	
	a_p	f_z	a_e	f_z	a_p	v_c	a_e (% of DC)	f_z	a_p	a_p	f_z	f_z	$a_p/360^\circ$ (% of DC)	hole \varnothing (\geq % of DC)	f_z	a_p (% of DC)	
										$\leq 30^\circ$ *							
JS412	100	100	100	100	100	140	3	40	120	80	100	50	10	130	50	100	
LV2										$\leq 10^\circ$ *							
JS413	100	100	100	100	100	150	3	40	120	70	50	50	10	130	X	X	
LV3	X	X	25	60	240	120	3	40	230	70	50	50	10	130	X	X	
										$\leq 30^\circ$ *							
JS452	100	100	100	100	100	140	3	35	120	70	100	50	10	130	50	100	
LV3	50	60	75	60	50	120	3	40	100	70	70	50	10	130	20	10	
										$\leq 10^\circ$ *							
JS453	100	100	100	100	100	140	3	35	120	70	50	50	10	130	20	10	
LV3	X	X	25	60	240	120	3	40	230	70	70	50	10	130	20	10	
										$\leq 30^\circ$ *							
JSE512	100	100	100	100	100	110	3	65	125	40	40	100	5	130	40	40	
										$\leq 5^\circ$ *							
JSE513	100	100	100	100	100	110	3	85	150	100	100	100	5	130	50	40	
LV3	30	100	30	50	200	110	3	85	250	X	X	X	X	X	X	X	
										$\leq 5^\circ$ *							
JSE514	100	100	100	100	100	110	3	60	150	100	100	100	5	130	X	X	
LV3	X	X	25	50	200	110	3	60	250	X	X	X	X	X	X	X	
										$\leq 45^\circ$ *							
JS553	100	100	100	100	100	110	3	55	150	50	55	35	3	130	35	50	
LV2	100	100	100	100	100	110	3	55	150	50	55	35	3	130	35	50	
LV3	40	60	40	105	200	110	3	55	250	50	15	35	3	130	35	50	
										$\leq 5^\circ$ *							
JS554	100	100	100	100	100	110	3	53	150	100	100	100	3	130	X	X	
LV2	100	100	100	100	100	110	3	53	150	100	100	100	3	130	X	X	
LV3	40	60	38	105	200	110	3	53	250	50	50	60	3	130	X	X	
										$\leq 5^\circ$ *							
JS564	X	X	100	100	100	110	3	55	100	X	X	100	2	130	X	X	
LV3	X	X	38	105	140	110	3	55	140	X	X	60	1,5	130	X	X	
										$\leq 5^\circ$ *							
JS565	X	X	100	100	100	110	3	55	100	X	X	100	2	130	X	X	
LV3	X	X	38	105	140	110	3	55	140	X	X	60	1,5	130	X	X	

*Max ramping angle
All values are percentages of original (100%) cutting data.

Recalculation

Use original standard version side rough cutting data then recalculate parameters!										Use original standard version slotting cutting data then recalculate parameters!							
Straight	Slotting		Side rough			Side finish					Ramping		Helical			Drilling	
																	
	a_p	f_z	a_e	f_z	a_p	v_c	a_e (% of DC)	f_z	a_p	a_p	f_z	f_z	$a_p/360^\circ$ (% of DC)	hole \varnothing (\geq % of DC)	f_z	a_p (% of DC)	
J28											$\leq 45^\circ$ *						
LV2	100	100	100	100	100	140	3	100	135	40	25	100	10	130	25	60	
J36											$\leq X^\circ$ *						
LV2	X	X	100	100	100	120	3	85	150	X	X	X	X	X	X	X	
J93F											$\leq 20^\circ$ *						
LV2	100	100	100	100	100	133	3	40	100	100	100	100	3	130	25	30	
JH120											$\leq 1^\circ$						
LV2	100	100	100	100	100	120	3	120	80	17	100	100	2	130	X	X	
JH130											$\leq X^\circ$ *						
LV2	X	X	100	100	100	120	3	120	80	X	X	X	X	X	X	X	
JH142											$\leq X^\circ$ *						
LV2	X	X	100	100	100	110	3	80	70	X	X	30	2	130	X	X	
LV3	X	X	100	100	100	110	3	80	70	X	X	20	1	130	X	X	
LV6	X	X	100	100	100	110	3	80	70	X	X	10	1	130	X	X	
JH830											$\leq 45^\circ$ *						
LV2	100	100	100	100	100	110	3	110	80	9	135	135	3	130	X	X	
JH910											$\leq X^\circ$ *						
LV2	100	100	100	100	100	125	4	100	80	15	140	140	3	130	X	X	
LV3	80	80	100	80	80	125	4	80	65	10	110	110	3	130	X	X	
JH930											$\leq X^\circ$ *						
LV2	X	X	100	100	100	125	2	30	100	X	X	X	X	X	X	X	

*Max ramping angle







All values are percentages of original (100%) cutting data.

Recalculation

Use original standard version side rough cutting data then recalculate parameters!										Use original standard version slotting cutting data then recalculate parameters!							
Straight	Slotting		Side rough			Side finish					Ramping		Helical			Drilling	
	a_p	f_z	a_e	f_z	a_p	v_c	a_e (% of DC)	f_z	a_p	a_p	f_z	f_z	$a_p/360^\circ$ (% of DC)	hole \varnothing (\geq % of DC)	f_z	a_p (% of DC)	
										$\leq 5^\circ$ *							
JH40	100	100	100	100	100	100	3	35	100	83	55	55	25	130	55	80	
LV2	100	100	100	100	100	100	3	35	100	83	55	55	25	130	55	80	
LV3	100	100	100	100	100	100	3	35	100	83	55	55	25	130	55	80	
										$\leq 45^\circ$ *							
JH410	100	100	100	100	100	125	2	25	100	100	67	67	40	130	67	80	
LV2	100	100	100	100	100	125	2	25	100	100	67	67	40	130	67	80	
LV2 (ML)	75	60	80	60	100	125	2	25	100	60	40	40	40	130	40	50	
LV2 (TL)	125	100	100	100	100	100	2	100	100	100	50	100	40	130	150	80	
LV2 (RS)	125	100	100	100	100	100	2	100	100	100	50	100	40	130	150	80	
LV3 (RS)	95	95	80	100	100	100	2	100	100	50	50	50	40	130	75	40	
										$\leq 45^\circ$ *							
JH421	100	100	100	100	100	100	4	35	100	100	100	100	25	130	45	80	
LV2	100	100	100	100	100	100	4	35	100	100	100	100	25	130	45	80	
										$\leq 30^\circ$ *							
JH440	100	100	100	100	100	125	3	40	100	100	100	100	5	130	X	X	
LV2	100	100	100	100	100	125	3	40	100	100	100	100	5	130	X	X	
										$\leq 5^\circ$ *							
JHP750	115	120	115	115	100	100	2	145	100	100	120	120	3	130	10	70	
LV1	115	120	115	115	100	100	2	145	100	100	120	120	3	130	10	70	
LV2	100	100	100	100	100	100	2	145	100	100	100	100	3	130	10	60	
										$\leq 5^\circ$ *							
JHP951	100	100	100	100	100	158	2	50	113	20	100	125	3	130	6	20	
LV2	100	100	100	100	100	158	2	50	113	20	100	125	3	130	6	20	
										$\leq 10^\circ$ *							
JHP993	100	100	100	100	100	X	X	X	X	30	100	100	3	130	4	40	
LV2	100	100	100	100	100	X	X	X	X	30	100	100	3	130	4	40	
LV3	80	80	80	80	80	X	X	X	X	20	80	80	3	130	3	30	
										$\leq X^\circ$ *							
JS520	X	X	100	100	100	133	2	65	100	X	X	X	X	X	X	X	
LV2	X	X	100	100	100	133	2	65	100	X	X	X	X	X	X	X	
LV3	X	X	X	X	X	133	2	65	175	X	X	X	X	X	X	X	
										$\leq X^\circ$ *							
JS522	X	X	100	100	100	129	2	140	100	X	X	X	X	X	X	X	
LV4	X	X	100	100	100	129	2	140	100	X	X	X	X	X	X	X	
										$\leq X^\circ$ *							
JS720	X	X	100	100	100	110	2	65	100	X	X	100	2	130	X	X	
LV2	X	X	100	100	100	110	2	65	100	X	X	100	2	130	X	X	
LV3	X	X	100	100	100	110	2	65	100	X	X	100	2	130	X	X	
										$\leq X^\circ$ *							
JS754	100	100	100	100	100	110	3	55	150	100	100	100	3	130	X	X	
LV1	100	100	100	100	100	110	3	55	150	100	100	100	3	130	X	X	
LV2	100	100	100	100	100	110	3	55	150	100	100	100	3	130	X	X	
LV3	40	60	38	105	200	110	3	55	250	50	50	60	3	130	X	X	
										$\leq X^\circ$ *							
JS755	100	100	100	100	100	110	3	55	150	100	100	100	3	130	X	X	
LV2	100	100	100	100	100	110	3	55	150	100	100	100	3	130	X	X	
LV3	40	60	38	105	100	110	3	55	250	50	50	60	3	130	X	X	

*Max ramping angle
All values are percentages of original (100%) cutting data.

Recalculation

Use original standard version side rough cutting data then recalculate parameters!										Use original standard version side milling cutting data then recalculate parameters!						
Straight	Slotting		Side rough			Side finish				Ramping		Helical			Drilling	
																
	a_p	f_z	a_e	f_z	a_p	v_c	a_e (% of DC)	f_z	a_p	a_p	f_z	f_z	$a_p/360^\circ$ (% of DC)	hole \varnothing (\geq % of DC)	f_z	a_p (% of DC)
										$\leq X^\circ$						
JME542-JME562-JME564																
LV1	100	100	100	100	100	125	2	150	5	X	X	X	X	X	X	X
LV2	63	100	100	100	65	125	2	150	3	X	X	X	X	X	X	X
LV3	25	100	100	100	25	125	2	150	1	X	X	X	X	X	X	X
LV4 (TL)	18	100	100	100	20	125	2	150	1	X	X	X	X	X	X	X
LV4 (XL)	12	100	100	100	10	125	2	150	1	X	X	X	X	X	X	X
LV5	10	100	100	100	10	125	2	150	1	X	X	X	X	X	X	X
LV6	4	100	100	100	5	125	2	150	1	X	X	X	X	X	X	X
LV7	2	100	100	100	2	125	2	150	1	X	X	X	X	X	X	X
										$\leq X^\circ$						
JME142-JME144																
LV1	100	100	100	100	100	100	2	150	5	X	X	X	X	X	X	X
LV2	85	85	100	100	63	100	2	150	3	X	X	X	X	X	X	X
LV3	75	75	100	100	25	100	2	150	1	X	X	X	X	X	X	X
LV4	60	60	100	100	20	100	2	150	1	X	X	X	X	X	X	X
LV5	50	50	100	100	10	100	2	150	1	X	X	X	X	X	X	X
LV6	40	40	100	100	5	100	2	150	1	X	X	X	X	X	X	X
										$\leq X^\circ *$						
JM403-JM404-JM406																
LV1	100	100	100	100	100	X	X	X	X	X	X	X	X	X	X	X
LV2	100	75	100	75	100	X	X	X	X	X	X	X	X	X	X	X
LV3 (L)	100	75	100	75	90	X	X	X	X	X	X	X	X	X	X	X
LV3 (TL)	90	75	100	75	70	X	X	X	X	X	X	X	X	X	X	X
LV4 (XL)	75	75	100	75	70	X	X	X	X	X	X	X	X	X	X	X
LV4 (SL)	75	75	100	75	45	X	X	X	X	X	X	X	X	X	X	X
LV5	50	50	100	50	30	X	X	X	X	X	X	X	X	X	X	X
										≤ 2						
JC898																
LV3	X	X	100	100	100	X	X	X	X	X	50	80	3	130-160	X	X
										$\leq 5^\circ$						
JC899																
LV3	X	X	100	100	100	100	3	50	100	X	X	X	X	X	X	X

*Max ramping angle

All values are percentages of original (100%) cutting data.







Recalculation

Use original standard version side rough cutting data then recalculate parameters!										Use original standard version slotting cutting data then recalculate parameters!								
Straight	Slotting		Side rough			Side finish					Ramping		Helical			Drilling		
	a _p	f _z	a _e	f _z	a _p	v _c	a _e (% of DC)	f _z	a _p	a _p	f _z	f _z	a _p /360° (% of DC)	hole Ø (≥ % of DC)	f _z	a _p (% of DC)		
										≤ 1°								
JHP170 LV2	100	100	100	100	100	130	3	175	80	100	100	100	2	130	X	X		
										≤ 30°								
JHP490 LV2	100	100	100	100	100	X	X	X	X	50	50	35	5	130	30	50		
LV2 (E-Shape)	100	75	100	100	100	X	X	X	X	50	50	35	5	130	30	50		
LV3	100	75	80	100	100	X	X	X	X	50	50	35	5	130	30	50		
LV4	150	75	80	100	100	X	X	X	X	50	50	35	5	130	30	50		
										≤ 5°								
JHP760 LV2	100	100	100	100	100	140	2	125	15	30	100	100	3	130	10	50		
LV3	50	50	100	50	50	140	2	125	15	15	50	50	3	130	5	25		
										≤ 15°								
JHP770 LV2	100	100	100	100	100	170	3	125	100	100	40	40	3	130	X	X		
										≤ 5°								
JHP780 LV1	100	100	100	100	100	160	2	135	140	100	100	35	3	130	35	50		
LV2	100	100	100	100	100	160	2	135	140	100	100	35	3	130	35	50		
										≤ X°								
JD620 LV2	100	100	100	100	100	100	2	110	4	X	X	X	X	X	X	X		
LV3	100	100	100	100	100	100	2	110	4	X	X	X	X	X	X	X		
LV4	20	100	60	100	60	100	2	110	4	X	X	X	X	X	X	X		
										≤ X°								
JD630 LV2	100	100	100	100	100	100	2	110	4	X	X	X	X	X	X	X		
LV3	100	100	100	100	100	100	2	110	4	X	X	X	X	X	X	X		
LV4	100	100	100	100	100	100	2	110	4	X	X	X	X	X	X	X		
										≤ X°								
JD640 LV2	100	100	100	100	100	100	2	110	4	X	X	X	X	X	X	X		
LV3	100	100	100	100	100	100	2	110	4	X	X	X	X	X	X	X		
LV4	100	100	100	100	100	100	2	110	4	X	X	X	X	X	X	X		

*Max ramping angle

All values are percentages of original (100%) cutting data.

Recalculation

Use original standard version side rough cutting data then recalculate parameters!										Use original standard version slotting cutting data then recalculate parameters!									
Straight	Slotting		Side rough			Side finish					Ramping		Helical			Plunging			
																			
	a_p	f_z	a_e	f_z	a_p	v_c	a_e (% of DC)	f_z	a_p	a_p	f_z	f_z	$a_p/360^\circ$ (% of DC)	hole \varnothing (\geq % of DC)	v_c	a_e (% of DC)	f_z	a_e -sd (% of DC)	
JHF181																			
LV1	100	100	100	100	100	X	X	X	X	X	X	100	3,4	130	X	X	X	X	
LV2	80	85	100	85	80	X	X	X	X	X	X	85	3,0	130	X	X	X	X	
LV3	60	70	100	70	60	X	X	X	X	X	X	70	2,5	130	X	X	X	X	
										$\leq 1,5^\circ$ *									
JHF980																			
LV1	100	100	100	100	100	X	X	X	X	100	100	100	3	130	70	30	33	200	
LV2	100	100	100	100	100	X	X	X	X	100	100	100	3	130	70	30	33	200	
LV3	80	85	80	85	80	X	X	X	X	80	85	85	3	130	70	30	33	200	
LV4	50	70	50	70	60	X	X	X	X	60	70	70	3	130	70	30	33	200	

*Max ramping angle

All values are percentages of original (100%) cutting data.







Recalculation

Use original standard version cutting data then recalculate parameters!										Use original standard version slotting cutting data then recalculate parameters!										
BALL	Slotting		Side rough			Side finish					Copy milling roughing			Copy milling finishing				Helical		
	a_p	f_z	a_e	f_z	a_p	v_c	a_e (% of DC)	f_z	a_p		a_e	f_z	a_p	v_c	a_e (% of DC)	f_z	a_p	f_z	$a_p/360^\circ$ (% of DC)	hole \varnothing (\geq % of DC)
JSB512																				
LV2	X	X	100	100	100	125	3	125	10	X	X	X	X	X	X	X	100	5	130	
JS532																				
LV1	X	X	100	100	100	125	3	125	10	X	X	X	X	X	X	X	75	5	130	
LV2	X	X	70	100	70	125	3	125	10	X	X	X	X	X	X	X	75	5	130	
LV3	X	X	X	X	X	125	3	125	10	X	X	X	X	X	X	X	X	X	X	
JS533																				
LV1	X	X	100	100	100	125	3	125	15	X	X	X	X	X	X	X	75	5	130	
LV2	X	X	75	75	75	125	3	125	15	X	X	X	X	X	X	X	75	5	130	
JS534																				
LV1	X	X	100	100	100	125	3	170	20	X	X	X	X	X	X	X	100	3	130	
LV2	X	X	70	100	70	125	3	170	20	X	X	X	X	X	X	X	100	3	130	
LV3	X	X	70	100	70	125	3	170	20	X	X	X	X	X	X	X	100	3	130	
JHB970																				
LV1	X	X	100	100	100	155	2	30	15	X	X	X	X	X	X	X	40	3	130	
LV2	X	X	100	100	100	155	2	30	15	X	X	X	X	X	X	X	40	3	130	
LV3	X	X	100	100	100	155	2	30	15	X	X	X	X	X	X	X	40	3	130	
JHB720																				
LV2	X	X	100	100	100	125	2	90	75	X	X	X	X	X	X	X	40	3	130	
JH112																				
LV1	X	X	100	100	100	110	2	70	100	X	X	X	X	X	X	X	20	2	130	
LV2	X	X	100	100	100	110	2	70	100	X	X	X	X	X	X	X	20	2	130	
LV3	X	X	100	100	100	110	1,6	55	100	X	X	X	X	X	X	X	X	X	X	
LV4	X	X	100	100	100	130	1,4	55	100	X	X	X	X	X	X	X	X	X	X	
LV5	X	X	100	100	100	130	1,4	50	100	X	X	X	X	X	X	X	X	X	X	
LV6	X	X	100	100	100	130	1	35	100	X	X	X	X	X	X	X	X	X	X	
JH150																				
LV2	X	X	100	100	100	165	1	90	35	X	X	X	X	X	X	X	30	2	130	

*Max ramping angle

All values are percentages of original (100%) cutting data.

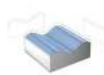
Recalculation

Use original standard version side rough cutting data then recalculate parameters!										Use original standard version slotting cutting data then recalculate parameters!										
BALL	Slotting		Side rough			Side finish					Copy milling roughing			Copy milling finishing				Helical		
																				
	a _p	f _z	a _e	f _z	a _p	v _c	a _e (% of DC)	f _z	a _p	a _e	f _z	a _p	v _c	a _e (% of DC)	f _z	a _p	f _z	a _p /360° (% of DC)	hole Ø (≥ % of DC)	
JH160 Standard (2)	X	X	X	X	X	X	X	X	X	X	X	X	X	X	X	X	X	X	X	
JH450 Standard (2)	X	X	100	100	100	120	5	90	25	X	X	X	X	X	X	X	45	5	130	
JH460 Standard (2)	X	X	100	100	100	120	5	90	25	X	X	X	X	X	X	X	X	X	X	
JMB542-JMB562- JMB563																				
LV1	100	100	X	X	X	X	X	X	X	100	100	100	125	2	150	5	X	X	X	
LV2	65	100	X	X	X	X	X	X	X	100	100	63	125	2	150	3	X	X	X	
LV3	26	100	X	X	X	X	X	X	X	100	100	25	125	2	150	1	X	X	X	
LV4 (TL)	20	100	X	X	X	X	X	X	X	100	100	19	125	2	150	1	X	X	X	
LV4 (XL)	12	100	X	X	X	X	X	X	X	100	100	12	125	2	150	1	X	X	X	
LV5	10	100	X	X	X	X	X	X	X	100	100	10	125	2	150	1	X	X	X	
LV6	4	100	X	X	X	X	X	X	X	100	100	4	125	2	150	1	X	X	X	
LV7	2	100	X	X	X	X	X	X	X	100	100	2	125	2	150	1	X	X	X	
JMB112																				
LV1	100	100	X	X	X	X	X	X	X	100	100	100	118	2	120	5	X	X	X	
LV2	65	100	X	X	X	X	X	X	X	64	85	85	118	2	120	3	X	X	X	
LV3	26	100	X	X	X	X	X	X	X	56	75	75	118	2	120	1	X	X	X	
LV4	20	100	X	X	X	X	X	X	X	45	60	60	118	2	120	1	X	X	X	
LV5	10	100	X	X	X	X	X	X	X	38	50	50	118	2	120	1	X	X	X	
LV6	4	100	X	X	X	X	X	X	X	30	40	40	118	2	120	1	X	X	X	
JM413-JM416																				
LV1	X	X	100	100	100	100	5	40	35	X	X	X	X	X	X	X	X	X	X	
LV2	X	X	100	60	100	100	5	40	15	X	X	X	X	X	X	X	X	X	X	
LV3	X	X	100	80	100	100	5	40	15	X	X	X	X	X	X	X	X	X	X	
LV4	X	X	100	60	75	100	5	40	10	X	X	X	X	X	X	X	X	X	X	
JMB642																				
LV1	100	100	100	100	100	100	2	85	200	X	X	X	X	X	X	X	X	X	X	
LV3	100	100	100	100	100	100	2	85	200	X	X	X	X	X	X	X	X	X	X	
LV5	30	100	60	100	100	100	2	85	200	X	X	X	X	X	X	X	X	X	X	
LV6	30	100	60	100	100	100	2	85	200	X	X	X	X	X	X	X	X	X	X	
LV7	30	100	60	100	100	100	2	85	200	X	X	X	X	X	X	X	X	X	X	
JD660										≤2										
LV1	X	X	100	100	100	100	2	100	100	X	X	X	X	X	X	X	X	X	X	
LV2	X	X	100	100	100	100	2	100	100	X	X	X	X	X	X	X	X	X	X	
LV3	X	X	100	100	100	100	2	100	100	X	X	X	X	X	X	X	X	X	X	
LV4	X	X	100	100	100	100	2	100	100	X	X	X	X	X	X	X	X	X	X	
LV5	X	X	100	100	100	100	2	100	100	X	X	X	X	X	X	X	X	X	X	

*Max ramping angle

All values are percentages of original (100%) cutting data.

Nomenclature and formulae

RPM	
$n = \frac{v_c \cdot 1000}{\pi \cdot D_c}$	(rev/min)
Cutting speed	
$v_c = \frac{n \cdot \pi \cdot D_c}{1000}$	(m/min)
Feed speed	
$v_f = n \cdot z_n \cdot f_z$	(mm/min)
Feed per revolution	
$f = z_n \cdot f_z$	(mm/rev)
Metal removal rate	
$Q = \frac{a_e \cdot a_p \cdot v_f}{1000}$	(cm ³ /min)
Cutting speed and RPM for copying	
$v_c = \frac{n \cdot \pi \cdot D_w}{1000}$	(m/min)
$n = \frac{v_c \cdot 1000}{\pi \cdot D_w}$	(RPM)
$D_w = 2 \cdot \sqrt{a_p (D_c - a_p)}$	(mm)

Calculation of a_p vs. overhang length:

If the overhang length (XS) is longer than 4 x DC and Cylindrical shanks are used it is important to adopt another depth of cut (a_p) value than that indicated in the table.

Use the following formula to calculate the new a_p value

$$a_{p, \text{new}} = a_p \times (4 \times \text{DC} / \text{XS})^2$$

Profile height

$$H = \frac{D_c}{2} - \sqrt{\frac{D_c^2 - a_e^2}{2}}$$

$$D_w = 2 \cdot \sqrt{a_p (D_c - a_p)} \quad (\text{mm})$$

Profile height H (um)

DC	Pitch a_e (μm)						
	0,06	0,08	0,11	0,15	0,20	0,3	0,45
1	0,90	1,60	3,00	5,70	10,0	23,0	53,0
2	0,45	0,80	1,50	2,80	5,0	11,0	26,0
4	0,23	0,40	0,76	1,40	2,5	5,60	13,0
6	0,15	0,27	0,50	0,94	1,7	3,80	8,40
8	0,11	0,20	0,38	0,70	1,3	2,80	6,30
10	0,09	0,16	0,30	0,56	1,0	2,30	5,10
12	0,08	0,13	0,25	0,47	0,83	1,90	4,20

- a_p = Depth of cut mm/axial depth of cut (mm)
- a_e = Width of cut mm/radial depth of cut (mm)
- DC = Cutter diameter
- f = Feed per revolution (mm/rev)
- f_z = Feed per tooth (mm/tooth)
- z_n = No. of teeth
- n = RPM (rev/min)
- Q = Material removal rate (cm³/min)
- v_c = Cutting speed (m/min)
- v_f = Feed speed (mm/min)
- D_w = Working diameter

Operation recommendations

Ramping method

The table below shows the feed rate percentage to use at certain ramping angles

Recommended diameter of hole for helical interpolation ramping

Diameter of end mill DC	Diameter of hole
1-2,5	1,4 x DC
3-6	1,3 x DC
8-12	1,2 x DC
16-32	1,15 x DC



Trochoidal method

The figure below shows a method often called the trochoidal method for milling slots

Recommendation of width of slot

Diameter of end mill DC	Slot width
1-2,5	1,8 x DC
3-6	1,6 x DC
8-12	1,4 x DC
16-32	1,2 x DC

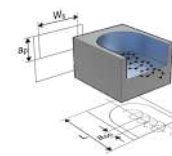



MINIMASTER™ PLUS

Minimaster™ Plus is the next generation line of end mills with replaceable fluted inserts. This replaceable cutting head tool system builds on the success of the industry leading Minimaster™ system and reaches the highest level of precision and productivity.

- Square Shoulder range: 10-16 mm (.375 - .625 inch)
- Ballnose range: 10-16 mm (.375 - .625 inch)
- Center Drilling/Chamfering range: 10-16 mm (.375 - .625 inch)
- High Feed range: 10-16 mm (.375 - .625 inch)

Universal

Steel and cast iron

Stainless steel
and S-materials

Non ferrous

Hard

Plastic and CFRP

Graphite

X-Heads

Minimaster Plus

Minimaster

Code keys

Code key shanks

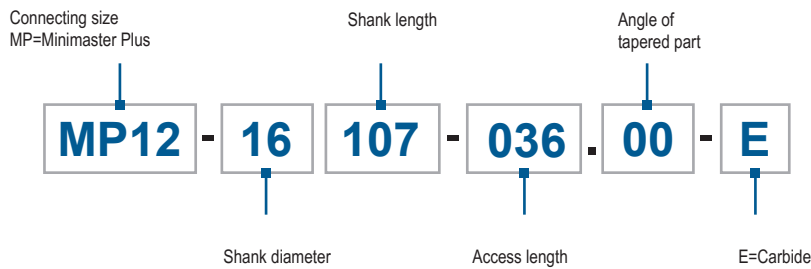

Code key inserts

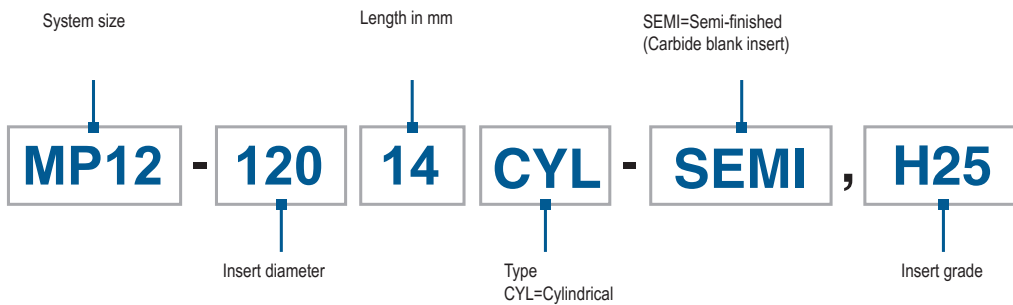
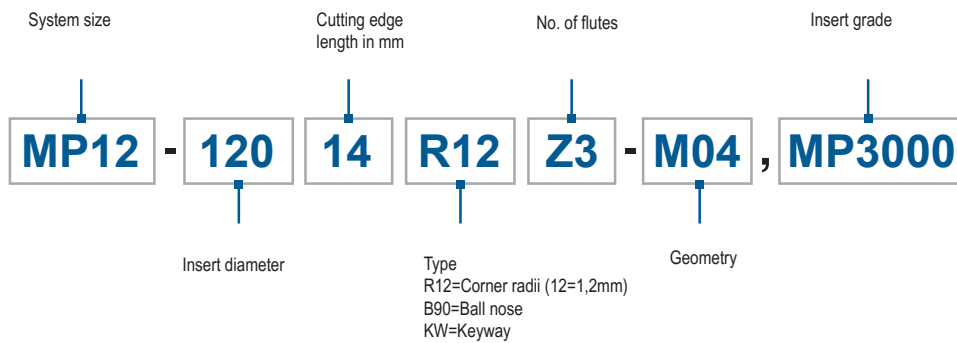

Internal through coolant



Universal

Steel and cast iron

Stainless steel and S-materials

Stainless steel and S-materials

Non ferrous

Hard

Graphite

X-Heads

Minimaster Plus

Minimaster

Selection guide

1. Select taper size

The design of the workpiece and the machining operations determines suitable taper size. Select the largest possible taper size for best strength and stability.

2. Select insert

- Use the tables beginning on page 722 to classify the workpiece material into a Seco material group.
- Look up the pages for the selected taper size and choose a suitable insert in the insert selection table.

3. Select shank

- Look up the pages for the selected taper size and choose a suitable shank in the tool data table.
- Always choose the shortest shank possible to achieve the best possible stability.

Note! Carbide shanks are to be used for Finishing/Semi finishing operations only.

4. Select cutting data

- Cutting speed recommendations are found in the cutting data tables for each selected taper size. Cutting data recommendations are based on stable conditions and might therefore need to be adjusted depending on the stability in the application (tooling, machine & workpiece fixturing). General rule for max ap in slotting is $DC \cdot 0.3 = \text{Max APMXS}$. (See figure 1)
- Feed and cutting speed recommendations are found in the cutting data conversion table.
- Maximum RPM that for safety reasons should never be exceeded, are shown on page N/A.
- If the cutter is not fully engaged the feed per tooth and the cutting speed should be increased compared to the recommendations for a fully engaged cutter. The reason for that is to keep the average chip thickness and the working temperature in the cutting zone.
- Divide the radial depth of cut with the cutter diameter to get the actual cutter engagement percentage ($ae/DC\%$), for ball nose cutters use the effective working diameter D_w instead of DC (See figure 2 & 6)
- Use the percentage to get a correct feed per tooth and cutting speed recommendation for the actual cutter engagement.

5. General



- When milling in corners and bottoms of cavities the feed rate should be reduced due to the increase of the average chip thickness. Use the feed per tooth recommendations for a fully engaged cutter.
- When steep down copying with an angle bigger than 40° or steep up copying with an angle bigger than 30° in combination with small depths of cut, use the diameter (DC) as working diameter instead of D_w .
- When calculating feed per revolution and feed speed, always use the ZAFP-value. That is the effective number of teeth to use for cutting data calculations. The ZAFP-value can be found in the insert selection table.

Note! There will be a deterioration in the surface finish on the workpiece when the feed rate is increased. (See figure 3 & 5)

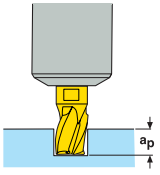
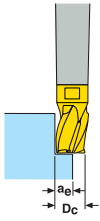
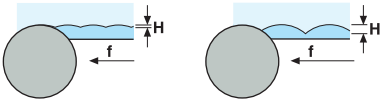
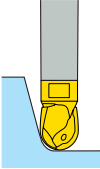
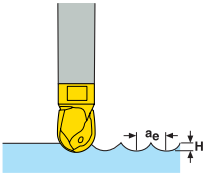
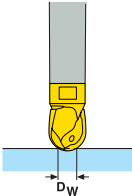
Minimaster Plus figures

Figure 1	Figure 2	Universal
		Steel and cast iron
Figure 3	Figure 4	Stainless steel and S-materials
		Stainless steel and S-materials
Figure 5	Figure 6	Non ferrous
		Hard
		Graphite
		X-Heads
		Minimaster Plus
		Minimaster

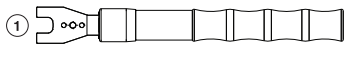
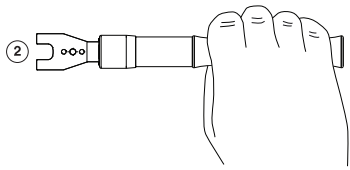
Torque wrench information and user instruction

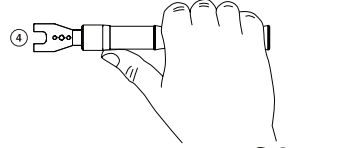
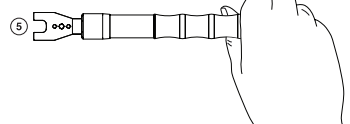
Universal	Torque wrench	
Steel and cast iron		<p>We recommend a torque wrench when mounting the insert for best precision and extended tool life.</p> <p>Different torque values for assembly</p> <ul style="list-style-type: none"> - MP10: 11Nm - MP12: 15Nm - MP16: 19Nm <p>Do not use worn out replaceable blades.</p> <p>Note: Torque wrenches and standard keys must be ordered separately!</p>
Stainless steel and S-materials	 	<p>Use the arched handle (fig. 1) to grip the wrench by hand as shown (fig. 2)</p>
Non ferrous	  	<p>Do not grip the wrench as shown on figure 3-5, there is a risk that the applied torque might be incorrect and the insert will not be properly seated.</p>

MP10 Shank – Metric

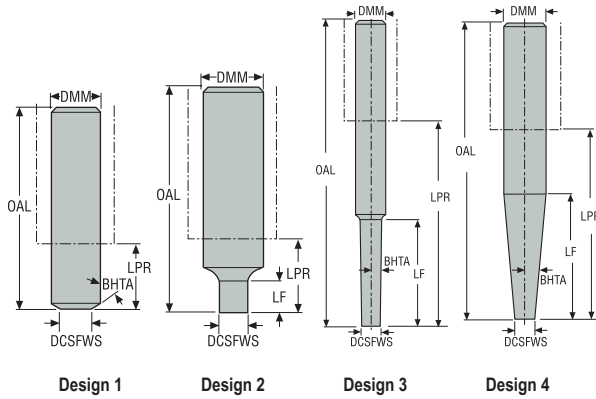

• Cylindrical shank DMM with tolerance h5, compatible for Shrinkfit

Designation	Type of mounting	DCSFWS	DMM	OAL	LPR	LF	RPMX	BHTA°	Design		Weight
		mm	mm	mm	mm	mm				✓	kg
MP10-10055-010.00	Cylindrical	9,8	10,0	55,0	15,0	10,0	80000	0,0	2	✓	0,1
MP10-16068-000.60	Cylindrical	9,5	16,0	68,0	20,0	0,0	80000	60,0	1	✓	0,2
MP10-16073-015.00	Cylindrical	9,8	16,0	73,0	25,0	15,0	80000	0,0	2	✓	0,1
MP10-16118-035.01	Cylindrical	9,5	16,0	118,0	70,0	35,0	80000	1,0	3	✓	0,2
MP10-16158-060.01	Cylindrical	9,5	16,0	158,0	110,0	60,0	80000	1,0	3	✓	0,2
MP10-20100-045.03	Cylindrical	9,5	20,0	100,0	50,0	45,0	80000	3,0	3	✓	0,2
MP10-20140-085.03	Cylindrical	9,5	20,0	140,0	90,0	85,0	80000	3,0	3	✓	0,3
MP10-20140-090.05	Cylindrical	9,5	20,0	140,0	90,0	60,0	80000	5,0	4	✓	0,3
MP10-12095-030.00-E	Cylindrical	9,8	12,0	95,0	50,0	30,0	80000	0,0	2	✓	0,2
MP10-12105-040.00-E	Cylindrical	9,8	12,0	105,0	60,0	40,0	80000	0,0	2	✓	0,2
MP10-12125-060.00-E	Cylindrical	9,8	12,0	125,0	80,0	60,0	80000	0,0	2	✓	0,2
MP10-16120-050.01-E	Cylindrical	9,5	16,0	120,0	72,0	50,0	80000	1,0	3	✓	0,3
MP10-16150-080.01-E	Cylindrical	9,5	16,0	150,0	102,0	80,0	80000	1,0	3	✓	0,3
MP10-16170-100.01-E	Cylindrical	9,5	16,0	170,0	122,0	100,0	80000	1,0	3	✓	0,4
MP10-16140-092.03-E	Cylindrical	9,5	16,0	140,0	92,0	62,0	80000	3,0	4	✓	0,4
MP10-16170-122.03-E	Cylindrical	9,5	16,0	170,0	122,0	62,0	80000	3,0	4	✓	0,4

Accessories

Key	Replacement blade	Torque key
MP1016	MP00-10M	MP00-10.110

Blades are included with the torque key

Universal

Steel and cast iron

Stainless steel and S-materials

Stainless steel and S-materials

Non ferrous

Hard

Graphite

X-Heads

Minimaster Plus

Minimaster

MP10 Shank – Inch

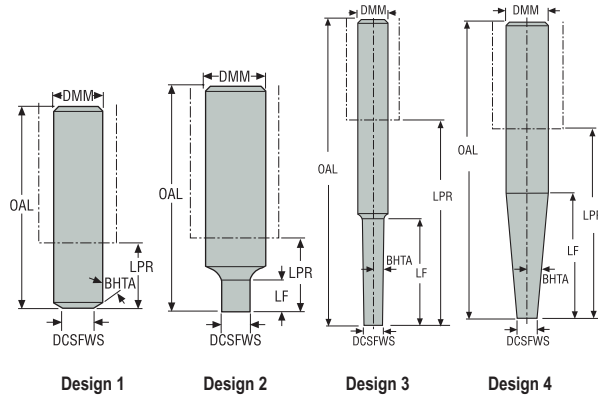

- Cylindrical shank DMM with tolerance h5, compatible for Shrinkfit

Designation	Type of mounting	DCSFWS	DMM	OAL	LPR	LF	RPMX	BHTA°	Design	Weight
		inch	inch	inch	inch	inch				lbs
MP10-0372.1-0.39.00	Cylindrical	0.370	0.375	2.122	0.591	0.394	80000	0,0	2	✓ 0.220
MP10-0622.6-0.00.60	Cylindrical	0.374	0.625	2.662	0.787	0	80000	60,0	1	✓ 0.220
MP10-0622.8-0.59.00	Cylindrical	0.370	0.625	2.859	0.984	0.591	80000	0,0	2	✓ 0.220
MP10-0624.6-1.37.01	Cylindrical	0.374	0.625	4.631	2.756	1.378	80000	1,0	3	✓ 0.440
MP10-0626.2-2.36.01	Cylindrical	0.374	0.625	6.206	4.331	2.362	80000	1,0	3	✓ 0.440
MP10-0753.9-1.80.03	Cylindrical	0.374	0.750	3.969	1.969	1.799	80000	3,0	3	✓ 0.440
MP10-0755.5-3.40.03	Cylindrical	0.374	0.750	5.543	3.543	3.402	80000	3,0	4	✓ 0.660
MP10-0755.5-3.54.05	Cylindrical	0.374	0.750	5.543	3.543	2.150	80000	5,0	4	✓ 0.660
MP10-0504.8-2.36.00-E	Cylindrical	0.370	0.500	4.900	3.150	2.362	80000	0,0	2	✓ 0.440

Accessories

Key	Replacement blade	Torque key
MP1016	MP00-10M	MP00-10.110

Blades are included with the torque key

MP10 High feed

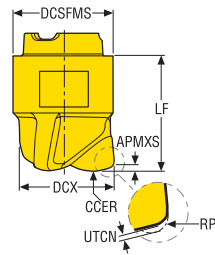

• For insert selection and cutting data recommendations, see page(s) 581-582

Z3



Designation	DCX	DC	APMXS	DCSFMS	CCER	RP	LF	UTCN	RMPX°	C min	C max	ZEFP	Grades	
													Coated	MP3000 F40M
MP10-0950.6HFZ3-MD08	9,525 0.375	4,55 0.179	0,6 0.024	9,4 0.370	6,2 0.244	1,13 0.044	11,0 0.433	0,32 0.013	5,0	10,4	13,4	3	■	
MP10-1000.6HFZ3-MD08	10,0 0.394	5,0 0.197	0,6 0.024	9,6 0.378	6,2 0.244	1,13 0.044	11,0 0.433	0,32 0.013	5,0	10,9	14,8	3	■	

Universal

Steel and cast iron

Stainless steel and S-materials

Stainless steel and S-materials

Non ferrous

Hard

Graphite

X-Heads

Minimaster Plus

Minimaster

MP10 Square shoulder

Slotting and contouring

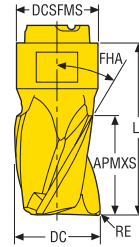

• For insert selection and cutting data recommendations, see page(s) 583-584

Z3



Designation	DC	APMXS	RE	DCSFMS	LF	FHA°	RMPX°	C min	C max	ZEFP	Grades	
											MP3000	F40M
	mm Inch	mm Inch	mm Inch	mm Inch	mm Inch							
MP10-09807KWZ3-E03	9,8 0.386	7,0 0.276	0,3 0.012	9,6 0.378	16,0 0.630	30	15,0	12,0	18,8	3		■
MP10-10007R04Z3-E03	10,0 0.394	7,0 0.276	0,4 0.016	9,6 0.378	16,0 0.630	30	15,0	12,2	19,0	3		■
MP10-10007R04Z3-M03	10,0 0.394	7,0 0.276	0,4 0.016	9,6 0.378	16,0 0.630	30	15,0	12,2	19,0	3	■	
MP10-10007R05Z3-E03	10,0 0.394	7,0 0.276	0,5 0.020	9,6 0.378	16,0 0.630	30	15,0	12,2	18,8	3		■
MP10-10007R08Z3-E03	10,0 0.394	7,0 0.276	0,8 0.031	9,6 0.378	16,0 0.630	30	15,0	12,2	18,2	3		■
MP10-10007R08Z3-M03	10,0 0.394	7,0 0.276	0,8 0.031	9,6 0.378	16,0 0.630	30	15,0	12,2	18,2	3	■	
MP10-10007R20Z3-E03	10,0 0.394	7,0 0.276	2,0 0.079	9,6 0.378	16,0 0.630	30	15,0	12,2	15,8	3		■
MP10-10007R31Z3-E03	10,0 0.394	7,0 0.276	3,1 0.122	9,6 0.378	16,0 0.630	30	15,0	12,2	13,6	3		■

MP10 Square shoulder

Slotting and contouring

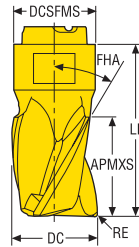

• For insert selection and cutting data recommendations, see page(s) 583-584

Z3



Designation	DC	APMXS	RE	DCSFMS	LF	FHA°	RMPX°	C min	C max	ZEFP	Grades	
											MP3000	F40M
	mm Inch	mm Inch	mm Inch	mm Inch	mm Inch							Coated
MP10-09812KWZ3-E03	9,8 0.386	12,0 0.472	0,3 0.012	9,6 0.378	21,0 0.827	30	15,0	12,0	18,8	3		■
MP10-09512R04Z3-E03	9,525 0.375	12,0 0.472	0,4 0.016	9,6 0.378	21,0 0.827	30	15,0	11,6	18,0	3		■
MP10-09512R04Z3-M03	9,525 0.375	12,0 0.472	0,4 0.016	9,6 0.378	21,0 0.827	30	15,0	11,6	18,0	3	■	
MP10-09512R08Z3-E03	9,525 0.375	12,0 0.472	0,8 0.031	9,6 0.378	21,0 0.827	30	15,0	11,6	17,2	3		■
MP10-09512R08Z3-M03	9,525 0.375	12,0 0.472	0,8 0.031	9,6 0.378	21,0 0.827	30	15,0	11,6	17,2	3	■	
MP10-09512R16Z3-E03	9,525 0.375	12,0 0.472	1,6 0.063	9,6 0.378	21,0 0.827	30	15,0	11,6	15,6	3		■
MP10-09512R31Z3-E03	9,525 0.375	12,0 0.472	3,1 0.122	9,6 0.378	21,0 0.827	30	15,0	11,6	12,6	3		■
MP10-10012R04Z3-E03	10,0 0.394	12,0 0.472	0,4 0.016	9,6 0.378	21,0 0.827	30	15,0	12,2	19,0	3		■
MP10-10012R04Z3-M03	10,0 0.394	12,0 0.472	0,4 0.016	9,6 0.378	21,0 0.827	30	15,0	12,2	19,0	3	■	
MP10-10012R05Z3-E03	10,0 0.394	12,0 0.472	0,5 0.020	9,6 0.378	21,0 0.827	30	15,0	12,2	18,8	3		■
MP10-10012R08Z3-E03	10,0 0.394	12,0 0.472	0,8 0.031	9,6 0.378	21,0 0.827	30	15,0	12,2	18,2	3		■
MP10-10012R08Z3-M03	10,0 0.394	12,0 0.472	0,8 0.031	9,6 0.378	21,0 0.827	30	15,0	12,2	18,2	3	■	
MP10-10012R16Z3-E03	10,0 0.394	12,0 0.472	1,6 0.063	9,6 0.378	21,0 0.827	30	15,0	12,2	16,6	3		■
MP10-10012R20Z3-E03	10,0 0.394	12,0 0.472	2,0 0.079	9,6 0.378	21,0 0.827	30	15,0	12,2	15,8	3		■
MP10-10012R31Z3-E03	10,0 0.394	12,0 0.472	3,1 0.122	9,6 0.378	21,0 0.827	30	15,0	12,2	13,6	3		■

Universal

Steel and cast iron

Stainless steel and S-materials

Stainless steel and S-materials

Non ferrous

Hard

Graphite

X-Heads

Minimaster Plus

Minimaster

MP10 Square shoulder

Slotting and contouring

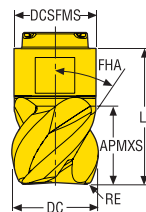

• For insert selection and cutting data recommendations, see page(s) 583-584

Z4



Designation	DC	APMXS	RE	DCSFMS	LF	FHA°	RMPX°	ZEFP	Grades	
									MP3000	F40M
	mm Inch	mm Inch	mm Inch	mm Inch	mm Inch				MP3000	F40M
MP10-10007R04Z4-M02	10,0 0.394	7,0 0.276	0,4 0.016	9,6 0.378	16,0 0.630	50	15,0	4	■	
MP10-10007R05Z4-E02	10,0 0.394	7,0 0.276	0,5 0.020	9,6 0.378	16,0 0.630	50	15,0	4		■
MP10-10007R08Z4-E02	10,0 0.394	7,0 0.276	0,8 0.031	9,6 0.378	16,0 0.630	50	15,0	4		■
MP10-10007R08Z4-M02	10,0 0.394	7,0 0.276	0,8 0.031	9,6 0.378	16,0 0.630	50	15,0	4	■	
MP10-10007R16Z4-E02	10,0 0.394	7,0 0.276	1,6 0.063	9,6 0.378	16,0 0.630	50	15,0	4		■
MP10-10012R04Z4-E02	10,0 0.394	12,0 0.472	0,4 0.016	9,6 0.378	21,0 0.827	50	15,0	4		■
MP10-10012R04Z4-M02	10,0 0.394	12,0 0.472	0,4 0.016	9,6 0.378	21,0 0.827	50	15,0	4	■	
MP10-10012R05Z4-E02	10,0 0.394	12,0 0.472	0,5 0.020	9,6 0.378	21,0 0.827	50	15,0	4		■
MP10-10012R08Z4-E02	10,0 0.394	12,0 0.472	0,8 0.031	9,6 0.378	21,0 0.827	50	15,0	4		■
MP10-10012R08Z4-M02	10,0 0.394	12,0 0.472	0,8 0.031	9,6 0.378	21,0 0.827	50	15,0	4	■	
MP10-10012R16Z4-E02	10,0 0.394	12,0 0.472	1,6 0.063	9,6 0.378	21,0 0.827	50	15,0	4		■
MP10-09512R04Z4-E02	9,525 0.375	12,0 0.472	0,4 0.016	9,6 0.378	21,0 0.827	50	15,0	4		■
MP10-09512R04Z4-M02	9,525 0.375	12,0 0.472	0,4 0.016	9,6 0.378	21,0 0.827	50	15,0	4	■	
MP10-09512R08Z4-E02	9,525 0.375	12,0 0.472	0,8 0.031	9,6 0.378	21,0 0.827	50	15,0	4		■
MP10-09512R08Z4-M02	9,525 0.375	12,0 0.472	0,8 0.031	9,6 0.378	21,0 0.827	50	15,0	4	■	

MP10 Square shoulder

Contouring only

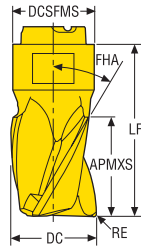

• For insert selection and cutting data recommendations, see page(s) 583-584

Z5



Designation	DC		APMXS		RE		DCSFMS		LF		FHA°		ZEFP		 Grades Coated	
	mm	Inch	mm	Inch	mm	Inch	mm	Inch	mm	Inch					MP3000	F40M
MP10-10012R04Z5-M02	10,0	0.394	12,0	0.472	0,4	0.016	9,6	0.378	21,0	0.827	40	5			■	
MP10-09512R04Z5-M02	9,525	0.375	12,0	0.472	0,4	0.016	9,6	0.378	21,0	0.827	40	5			■	

Universal

Steel and cast iron

Stainless steel and S-materials

Stainless steel and S-materials

Non ferrous

Hard

Graphite

X-Heads

Minimaster Plus

Minimaster

MP10 Ball nose design

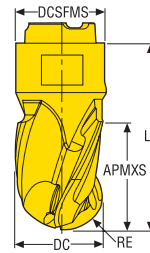

• For insert selection and cutting data recommendations, see page(s) 585-586

Z3



Z4



Designation	DC	APMXS	RE	DCSFMS	LF	FHA°	RMPX°	ZEFP		Grades	
										Coated	
	mm Inch	mm Inch	mm Inch	mm Inch	mm Inch					MP3000	F40M
MP10-10007B90Z3-E03	10,0 0.394	7,0 0.276	5,0 0.197	9,6 0.378	16,0 0.630	30	15,0	3			■
MP10-10007B90Z3-M03	10,0 0.394	7,0 0.276	5,0 0.197	9,6 0.378	16,0 0.630	30	15,0	3		■	
MP10-10007B90Z4-E02	10,0 0.394	7,0 0.276	5,0 0.197	9,6 0.378	16,0 0.630	20	15,0	4			■
MP10-10007B90Z4-M02	10,0 0.394	7,0 0.276	5,0 0.197	9,6 0.378	16,0 0.630	20	15,0	4		■	
MP10-10012B90Z3-E03	10,0 0.394	12,0 0.472	5,0 0.197	9,6 0.378	21,0 0.827	30	15,0	3			■
MP10-10012B90Z3-M03	10,0 0.394	12,0 0.472	5,0 0.197	9,6 0.378	21,0 0.827	30	15,0	3		■	
MP10-09507B90Z3-E03	9,525 0.375	7,0 0.276	4,7625 0.188	9,4 0.370	16,0 0.630	30	15,0	3			■
MP10-09507B90Z3-M03	9,525 0.375	7,0 0.276	4,7625 0.188	9,4 0.370	16,0 0.630	30	15,0	3		■	
MP10-09507B90Z4-E02	9,525 0.375	7,0 0.276	4,7625 0.188	9,4 0.370	16,0 0.630	20	15,0	4			■
MP10-09507B90Z4-M02	9,525 0.375	7,0 0.276	4,7625 0.188	9,4 0.370	16,0 0.630	20	15,0	4		■	
MP10-09512B90Z3-E03	9,525 0.375	12,0 0.472	4,7625 0.188	9,6 0.378	21,0 0.827	30	15,0	3			■
MP10-09512B90Z3-M03	9,525 0.375	12,0 0.472	4,7625 0.188	9,6 0.378	21,0 0.827	30	15,0	3		■	

MP10 Centre drilling/Chamfering

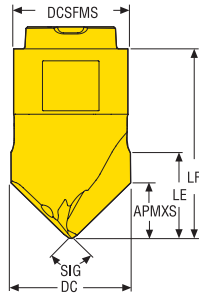

• For insert selection and cutting data recommendations, see page(s) 587-588

Z2



Designation	DC	APMXS	DCSFMS	LE	LF	SIG°	ZEFP		Grades	
									Coated	
	mm Inch	mm Inch	mm Inch	mm Inch	mm Inch				MP3000	F40M
MP10-10006C90Z2-M03	10,0 0.394	4,6 0.181	9,6 0.378	7,1 0.280	16,0 0.630	90,0	2			■

MP10 Chamfering

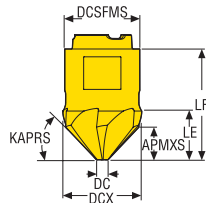

• For insert selection and cutting data recommendations, see page(s) 589-590

Z6



Designation	DCX	DC	APMXS	DCSFMS	LE	LF	KAPRS°	ZEFP		Grades	
										Coated	
	mm Inch	mm Inch	mm Inch	mm Inch	mm Inch	mm Inch				MP3000	F40M
MP10-10006C90Z6-M03	10,1 0.398	1,95 0.077	4,0 0.157	9,6 0.378	5,9 0.232	14,5 0.571	45,0	6			■

Universal

Steel and cast iron

Stainless steel and S-materials

Stainless steel and S-materials

Non ferrous

Hard

Graphite

X-Heads

Minimaster Plus

Minimaster

MP10 Cylindrical blanks

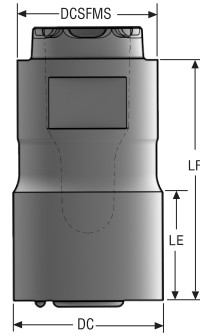

• Cylindrical carbide blanks for production of own geometries



Designation	DC		DCSFMS		LE		LF		Grades	
	mm	Inch	mm	Inch	mm	Inch	mm	Inch	Uncoated	H25
MP10-10007CYL-SEMI	10,15	0.400	9,6	0.378	7,3	0.287	16,3	0.642		■
MP10-10012CYL-SEMI	10,15	0.400	9,6	0.378	12,4	0.488	21,3	0.839		■

- Universal
- Steel and cast iron
- Stainless steel and S-materials
- Non ferrous
- Hard
- Plastic and cfrp
- Graphite
- X-Heads
- Minimaster Plus
- Minimaster

MP10 High feed milling – Insert selection – mm/Inch

SMG		a _p	f _z			
			100%	70%	30%	20%
P1	MP10-1000.6HFZ3-MD08 MP3000	0,42	0,46	0,46	0,60	0,75
		0.017	0.018	0.018	0.024	0.030
P2	MP10-1000.6HFZ3-MD08 MP3000	0,42	0,46	0,48	0,60	0,75
		0.017	0.018	0.019	0.024	0.030
P3	MP10-1000.6HFZ3-MD08 MP3000	0,42	0,44	0,44	0,60	0,70
		0.017	0.017	0.017	0.024	0.028
P4	MP10-1000.6HFZ3-MD08 MP3000	0,42	0,44	0,44	0,55	0,70
		0.017	0.017	0.017	0.022	0.028
P5	MP10-1000.6HFZ3-MD08 MP3000	0,42	0,42	0,42	0,55	0,70
		0.017	0.017	0.017	0.022	0.028
P6	MP10-1000.6HFZ3-MD08 MP3000	0,42	0,42	0,42	0,55	0,70
		0.017	0.017	0.017	0.022	0.028
P7	MP10-1000.6HFZ3-MD08 MP3000	0,42	0,42	0,42	0,55	0,70
		0.017	0.017	0.017	0.022	0.028
P8	MP10-1000.6HFZ3-MD08 MP3000	0,42	0,44	0,44	0,60	0,70
		0.017	0.017	0.017	0.024	0.028
P11	MP10-1000.6HFZ3-MD08 MP3000	0,42	0,42	0,42	0,55	0,70
		0.017	0.017	0.017	0.022	0.028
P12	MP10-0950.6HFZ3-MD08 MP3000	0,34	0,30	0,30	0,38	0,46
		0.013	0.012	0.012	0.015	0.018
M1	MP10-1000.6HFZ3-MD08 MP3000	0,42	0,46	0,48	0,60	0,75
		0.017	0.018	0.019	0.024	0.030
M2	MP10-1000.6HFZ3-MD08 MP3000	0,42	0,42	0,42	0,55	0,70
		0.017	0.017	0.017	0.022	0.028
M3	MP10-1000.6HFZ3-MD08 MP3000	0,34	0,36	0,34	0,44	0,55
		0.013	0.014	0.013	0.017	0.022
M4	MP10-1000.6HFZ3-MD08 MP3000	0,25	0,32	0,30	0,38	0,46
		0.010	0.013	0.012	0.015	0.018
M5	MP10-1000.6HFZ3-MD08 MP3000	0,25	0,32	0,30	0,38	0,46
		0.010	0.013	0.012	0.015	0.018
K1	MP10-1000.6HFZ3-MD08 MP3000	0,42	0,46	0,48	0,60	0,75
		0.017	0.018	0.019	0.024	0.030
K2	MP10-1000.6HFZ3-MD08 MP3000	0,42	0,42	0,42	0,55	0,70
		0.017	0.017	0.017	0.022	0.028
K3	MP10-1000.6HFZ3-MD08 MP3000	0,42	0,42	0,42	0,55	0,70
		0.017	0.017	0.017	0.022	0.028
K4	MP10-1000.6HFZ3-MD08 MP3000	0,42	0,42	0,42	0,55	0,70
		0.017	0.017	0.017	0.022	0.028
K5	MP10-1000.6HFZ3-MD08 MP3000	0,42	0,38	0,38	0,50	0,60
		0.017	0.015	0.015	0.020	0.024
K6	MP10-1000.6HFZ3-MD08 MP3000	0,42	0,42	0,42	0,55	0,70
		0.017	0.017	0.017	0.022	0.028
K7	MP10-1000.6HFZ3-MD08 MP3000	0,42	0,38	0,38	0,50	0,60
		0.017	0.015	0.015	0.020	0.024
N1	MP10-1000.6HFZ3-MD08 MP3000	0,42	0,60	0,60	0,80	1,0
		0.017	0.024	0.024	0.032	0.040
N2	MP10-1000.6HFZ3-MD08 MP3000	0,42	0,60	0,60	0,80	1,0
		0.017	0.024	0.024	0.032	0.040
N3	MP10-1000.6HFZ3-MD08 MP3000	0,42	0,60	0,60	0,80	1,0
		0.017	0.024	0.024	0.032	0.040
N11	MP10-1000.6HFZ3-MD08 MP3000	0,42	0,60	0,60	0,80	1,0
		0.017	0.024	0.024	0.032	0.040
S1	MP10-1000.6HFZ3-MD08 MP3000	0,25	0,32	0,30	0,38	0,46
		0.010	0.013	0.012	0.015	0.018
S2	MP10-1000.6HFZ3-MD08 MP3000	0,25	0,32	0,30	0,38	0,46
		0.010	0.013	0.012	0.015	0.018
S3	MP10-1000.6HFZ3-MD08 MP3000	0,25	0,30	0,28	0,36	0,44
		0.010	0.012	0.011	0.014	0.017
S11	MP10-1000.6HFZ3-MD08 MP3000	0,30	0,36	0,34	0,44	0,55
		0.012	0.014	0.013	0.017	0.022
S12	MP10-1000.6HFZ3-MD08 MP3000	0,30	0,36	0,34	0,44	0,55
		0.012	0.014	0.013	0.017	0.022
S13	MP10-1000.6HFZ3-MD08 MP3000	0,25	0,32	0,30	0,38	0,46
		0.010	0.013	0.012	0.015	0.018
H5	MP10-1000.6HFZ3-MD08 MP3000	0,34	0,30	0,30	0,38	0,46
		0.013	0.012	0.012	0.015	0.018
H8	MP10-1000.6HFZ3-MD08 MP3000	0,30	0,24	0,22	0,28	0,34
		0.012	0.0095	0.0085	0.011	0.013
H11	MP10-1000.6HFZ3-MD08 MP3000	0,34	0,30	0,30	0,38	0,46
		0.013	0.012	0.012	0.015	0.018
H12	MP10-1000.6HFZ3-MD08 MP3000	0,30	0,24	0,22	0,28	0,34
		0.012	0.0095	0.0085	0.011	0.013
H21	MP10-1000.6HFZ3-MD08 MP3000	0,30	0,24	0,22	0,28	0,34
		0.012	0.0095	0.0085	0.011	0.013

SMG = Seco material group
f_z = mm/tooth (in/tooth), v_c = m/min (sf/min), a_p/DC = %
All cutting data are start values

Universal
Steel and cast iron
Stainless steel and S-materials
Stainless steel and S-materials
Non ferrous
Hard
Graphite
X-Heads
Minimaster Plus
Minimaster

MP10 High feed milling – Cutting data $v_c = (m/min)/(sf/min)$

	SMG	MP3000			
		100%	70%	30%	20%
Universal	P1	250	305	355	370
		820	1000	1175	1225
Steel and cast iron	P2	245	295	345	360
		800	970	1125	1175
Stainless steel and S-materials	P3	215	260	295	315
		710	850	970	1025
	P4	190	230	265	275
		620	750	870	900
	P5	180	220	255	265
		590	720	840	870
	P6	205	245	285	295
		670	800	940	970
	P7	190	235	270	280
		620	770	890	920
	P8	180	220	250	265
		590	720	820	870
	P11	185	225	260	275
		610	740	850	900
	P12	120	145	165	175
		395	475	540	570
Non ferrous	M1	185	220	255	270
		610	720	840	890
	M2	150	185	210	220
		490	610	690	720
	M3	120	145	170	180
		395	475	560	590
	M4	95	115	130	140
		310	375	425	460
Hard	M5	80	95	110	115
		260	310	360	375
	K1	195	235	275	285
		640	770	900	940
	K2	170	210	240	250
		560	690	790	820
	K3	145	175	205	215
		475	570	670	710
	K4	140	170	195	205
		460	560	640	670
	K5	85	105	120	125
		280	345	395	410
	K6	120	150	170	180
		395	490	560	590
	K7	110	130	150	160
		360	425	490	520
Graphite	N1	1450	1750	2025	2100
		4750	5750	6650	6900
	N2	580	710	810	850
		1900	2325	2650	2800
	N3	390	470	540	570
		1275	1550	1775	1875
	N11	445	540	620	650
		1450	1775	2025	2125
X-Heads	S1	45	55	60	65
		150	180	195	215
	S2	36	42	49	50
		120	140	160	165
	S3	31	37	43	45
		100	120	140	150
	S11	60	75	85	90
		195	245	280	295
Minimaster Plus	S12	43	50	60	60
		140	165	195	195
	S13	25	30	34	36
		80	100	110	120
	H5	37	45	50	55
		120	150	165	180
	H8	39	47	55	60
		130	155	180	195
	H11	48	55	65	70
		155	180	215	230
Minimaster	H12	75	90	105	110
		245	295	345	360
	H21	39	47	55	60
		130	155	180	195

MP10 Slot and Side milling – Insert selection – mm/Inch

SMG		a _p	f _z			
			100%	30%	10%	5%
P1	MP10-10007R04Z3-M03 MP3000	3,5 0.14	0,042 0.0017	0,046 0.0018	0,070 0.0028	0,10 0.0040
P2	MP10-10007R04Z3-M03 MP3000	3,5 0.14	0,044 0.0017	0,048 0.0019	0,070 0.0028	0,10 0.0040
P3	MP10-10007R04Z3-M03 MP3000	3,5 0.14	0,040 0.0016	0,044 0.0017	0,070 0.0028	0,095 0.0038
P4	MP10-10007R04Z3-M03 MP3000	3,5 0.14	0,040 0.0016	0,044 0.0017	0,065 0.0026	0,095 0.0038
P5	MP10-10007R04Z3-M03 MP3000	3,5 0.14	0,040 0.0016	0,042 0.0017	0,065 0.0026	0,090 0.0036
P6	MP10-10007R04Z3-M03 MP3000	3,5 0.14	0,038 0.0015	0,042 0.0017	0,065 0.0026	0,090 0.0036
P7	MP10-10007R04Z3-M03 MP3000	3,5 0.14	0,038 0.0015	0,042 0.0017	0,065 0.0026	0,090 0.0036
P8	MP10-10007R04Z3-M03 MP3000	3,5 0.14	0,040 0.0016	0,044 0.0017	0,070 0.0028	0,095 0.0038
P11	MP10-10007R04Z3-M03 MP3000	3,5 0.14	0,038 0.0015	0,042 0.0017	0,065 0.0026	0,090 0.0036
P12	MP10-10007R04Z3-M03 MP3000	2,5 0.10	0,026 0.0010	0,030 0.0012	0,044 0.0017	0,060 0.0024
M1	MP10-10007R04Z3-E03 F40M	3,5 0.14	0,044 0.0017	0,048 0.0019	0,070 0.0028	0,10 0.0040
M2	MP10-10007R04Z3-E03 F40M	3,5 0.14	0,040 0.0016	0,042 0.0017	0,065 0.0026	0,090 0.0036
M3	MP10-10007R04Z3-E03 F40M	2,5 0.10	0,032 0.0013	0,034 0.0013	0,055 0.0022	0,075 0.0030
M4	MP10-10007R04Z3-E03 F40M	2,0 0.080	0,028 0.0011	0,030 0.0012	0,046 0.0018	0,065 0.0026
M5	MP10-10007R04Z3-E03 F40M	2,0 0.080	0,028 0.0011	0,030 0.0012	0,046 0.0018	0,065 0.0026
K1	MP10-10007R04Z3-M03 MP3000	3,5 0.14	0,044 0.0017	0,048 0.0019	0,070 0.0028	0,10 0.0040
K2	MP10-10007R04Z3-M03 MP3000	3,5 0.14	0,040 0.0016	0,042 0.0017	0,065 0.0026	0,090 0.0036
K3	MP10-10007R04Z3-M03 MP3000	3,5 0.14	0,040 0.0016	0,042 0.0017	0,065 0.0026	0,090 0.0036
K4	MP10-10007R04Z3-M03 MP3000	3,5 0.14	0,040 0.0016	0,042 0.0017	0,065 0.0026	0,090 0.0036
K5	MP10-10007R04Z3-M03 MP3000	3,5 0.14	0,036 0.0014	0,038 0.0015	0,060 0.0024	0,080 0.0032
K6	MP10-10007R04Z3-M03 MP3000	3,5 0.14	0,036 0.0016	0,038 0.0017	0,060 0.0026	0,080 0.0036
K7	MP10-10007R04Z3-M03 MP3000	3,5 0.14	0,036 0.0014	0,038 0.0015	0,060 0.0024	0,080 0.0032
N1	MP10-10007R04Z3-E03 F40M	3,5 0.14	0,055 0.0022	0,060 0.0024	0,090 0.0036	0,13 0.0050
N2	MP10-10007R04Z3-E03 F40M	3,5 0.14	0,055 0.0022	0,060 0.0024	0,090 0.0036	0,13 0.0050
N3	MP10-10007R04Z3-E03 F40M	3,5 0.14	0,055 0.0022	0,060 0.0024	0,090 0.0036	0,13 0.0050
N11	MP10-10007R04Z3-E03 F40M	3,5 0.14	0,055 0.0022	0,060 0.0024	0,090 0.0036	0,13 0.0050
S1	MP10-10007R04Z3-E03 F40M	2,0 0.080	0,028 0.0011	0,030 0.0012	0,046 0.0018	0,065 0.0026
S2	MP10-10007R04Z3-E03 F40M	2,0 0.080	0,028 0.0011	0,030 0.0012	0,046 0.0018	0,065 0.0026
S3	MP10-10007R04Z3-E03 F40M	2,0 0.080	0,026 0.0010	0,028 0.0011	0,042 0.0017	0,060 0.0024
S11	MP10-10007R04Z3-E03 F40M	2,5 0.10	0,032 0.0013	0,034 0.0013	0,055 0.0022	0,075 0.0030
S12	MP10-10007R04Z3-E03 F40M	2,5 0.10	0,032 0.0013	0,034 0.0013	0,055 0.0022	0,075 0.0030
S13	MP10-10007R04Z3-E03 F40M	2,0 0.080	0,028 0.0011	0,030 0.0012	0,046 0.0018	0,065 0.0026
H5	MP10-10007R04Z3-M03 MP3000	2,5 0.10	0,026 0.0010	0,030 0.0012	0,044 0.0017	0,060 0.0024
H8	MP10-10007R04Z3-M03 MP3000	2,5 0.10	0,020 0.00080	0,022 0.00085	0,034 0.0013	0,048 0.0019
H11	MP10-10007R04Z3-M03 MP3000	2,5 0.10	0,026 0.0010	0,030 0.0012	0,044 0.0017	0,060 0.0024
H12	MP10-10007R04Z3-M03 MP3000	2,5 0.10	0,020 0.00080	0,022 0.00085	0,034 0.0013	0,048 0.0019
H21	MP10-10007R04Z3-M03 MP3000	2,5 0.10	0,020 0.00080	0,022 0.00085	0,034 0.0013	0,048 0.0019

SMG = Seco material group
f_z = mm/tooth (in/tooth), v_c = m/min (sf/min), a_p/DC = %
All cutting data are start values

Universal
Steel and cast iron
Stainless steel and S-materials
Stainless steel and S-materials
Non ferrous
Hard
Graphite
X-Heads
Minimaster Plus
Minimaster

MP10 Slot and Side milling – Cutting data $v_c = (m/min)/(sf/min)$

SMG	MP3000				F40M			
	100%	30%	10%	5%	100%	30%	10%	5%
P1	265	345	405	435	250	325	380	410
	870	1125	1325	1425	820	1075	1250	1350
P2	255	335	395	425	240	315	370	400
	840	1100	1300	1400	790	1025	1225	1300
P3	225	290	340	365	210	275	320	345
	740	950	1125	1200	690	900	1050	1125
P4	195	255	300	325	185	240	285	305
	640	840	980	1075	610	790	940	1000
P5	190	245	290	310	175	235	270	295
	620	800	950	1025	570	770	890	970
P6	215	275	325	350	200	260	305	330
	710	900	1075	1150	660	850	1000	1075
P7	200	260	305	330	190	245	290	310
	660	850	1000	1075	620	800	950	1025
P8	190	245	285	310	175	230	270	290
	620	800	940	1025	570	750	890	950
P11	195	255	295	320	185	240	280	305
	640	840	970	1050	610	790	920	1000
P12	125	160	185	200	115	150	175	190
	410	520	610	660	375	490	570	620
M1	190	250	295	315	195	255	300	320
	620	820	970	1025	640	840	980	1050
M2	155	205	240	260	160	210	245	265
	510	670	790	850	520	690	800	870
M3	125	165	190	205	125	165	195	210
	410	540	620	670	410	540	640	690
M4	95	125	145	155	100	125	145	160
	310	410	475	510	330	410	475	520
M5	80	105	120	130	80	105	125	135
	260	345	395	425	260	345	410	445
K1	200	265	310	335	190	250	295	315
	660	870	1025	1100	620	820	970	1025
K2	180	235	275	295	170	220	260	280
	590	770	900	970	560	720	850	920
K3	150	200	230	250	140	185	220	235
	490	660	750	820	460	610	720	770
K4	145	190	220	240	135	180	210	225
	475	620	720	790	445	590	690	740
K5	85	115	135	145	80	110	125	135
	280	375	445	475	260	360	410	445
K6	125	165	195	210	120	155	185	200
	410	540	640	690	395	510	610	660
K7	110	145	170	185	105	140	160	175
	360	475	560	610	345	460	520	570
N1	1525	2000	2350	2525	1450	1875	2225	2375
	5000	6550	7700	8275	4750	6150	7300	7800
N2	620	810	950	1025	580	760	900	960
	2025	2650	3125	3375	1900	2500	2950	3150
N3	410	540	630	680	390	510	600	640
	1350	1775	2075	2225	1275	1675	1975	2100
N11	470	610	720	780	445	580	680	730
	1550	2000	2350	2550	1450	1900	2225	2400
S1	45	60	70	75	46	60	70	75
	150	195	230	245	150	195	230	245
S2	36	47	55	60	37	48	55	60
	120	155	180	195	120	155	180	195
S3	31	41	47	50	32	42	48	50
	100	135	155	165	105	140	155	165
S11	65	80	95	105	65	85	100	105
	215	260	310	345	215	280	330	345
S12	44	55	65	70	45	60	70	75
	145	180	215	230	150	195	230	245
S13	25	33	38	41	26	33	39	42
	80	110	125	135	85	110	130	140
H5	38	49	60	60	39	50	60	65
	125	160	195	195	130	165	195	215
H8	40	50	60	65	40	50	60	65
	130	165	195	215	130	165	195	215
H11	49	65	75	80	49	65	75	80
	160	215	245	260	160	215	245	260
H12	75	100	115	125	70	95	110	115
	245	330	375	410	230	310	360	375
H21	40	50	60	65	40	50	60	65
	130	165	195	215	130	165	195	215

MP10 Copy milling – Insert selection – mm/Inch

SMG		a _p	f _z				
			100%	30%	10%	5%	2%
P1	MP10-10007B90Z3-M03 MP3000	3,5	0,048	0,050	0,075	0,10	0,17
		0.14	0.0019	0.0020	0.0030	0.0040	0.0065
P2	MP10-10007B90Z3-M03 MP3000	3,5	0,048	0,050	0,075	0,11	0,17
		0.14	0.0019	0.0020	0.0030	0.0044	0.0065
P3	MP10-10007B90Z3-M03 MP3000	3,5	0,046	0,048	0,070	0,10	0,16
		0.14	0.0018	0.0019	0.0028	0.0040	0.0065
P4	MP10-10007B90Z3-M03 MP3000	3,5	0,046	0,048	0,070	0,10	0,16
		0.14	0.0018	0.0019	0.0028	0.0040	0.0065
P5	MP10-10007B90Z3-M03 MP3000	3,5	0,044	0,046	0,070	0,095	0,15
		0.14	0.0017	0.0018	0.0028	0.0038	0.0060
P6	MP10-10007B90Z3-M03 MP3000	3,5	0,044	0,046	0,070	0,095	0,15
		0.14	0.0017	0.0018	0.0028	0.0038	0.0060
P7	MP10-10007B90Z3-M03 MP3000	3,5	0,044	0,046	0,070	0,095	0,15
		0.14	0.0017	0.0018	0.0028	0.0038	0.0060
P8	MP10-10007B90Z3-M03 MP3000	3,5	0,046	0,048	0,070	0,10	0,16
		0.14	0.0018	0.0019	0.0028	0.0040	0.0065
P11	MP10-10007B90Z3-M03 MP3000	3,5	0,044	0,046	0,070	0,095	0,15
		0.14	0.0017	0.0018	0.0028	0.0038	0.0060
P12	MP10-10007B90Z3-M03 MP3000	2,5	0,032	0,032	0,046	0,065	0,10
		0.10	0.0013	0.0013	0.0018	0.0026	0.0040
M1	MP10-10007B90Z3-E03 F40M	3,5	0,048	0,050	0,075	0,11	0,17
		0.14	0.0019	0.0020	0.0030	0.0044	0.0065
M2	MP10-10007B90Z3-E03 F40M	3,5	0,044	0,046	0,070	0,095	0,15
		0.14	0.0017	0.0018	0.0028	0.0038	0.0060
M3	MP10-10007B90Z3-E03 F40M	2,5	0,038	0,038	0,055	0,075	0,12
		0.10	0.0015	0.0015	0.0022	0.0030	0.0048
M4	MP10-10007B90Z3-E03 F40M	2,0	0,034	0,036	0,048	0,065	0,11
		0.080	0.0013	0.0014	0.0019	0.0026	0.0044
M5	MP10-10007B90Z3-E03 F40M	2,0	0,034	0,036	0,048	0,065	0,11
		0.080	0.0013	0.0014	0.0019	0.0026	0.0044
K1	MP10-10007B90Z3-M03 MP3000	3,5	0,048	0,050	0,075	0,11	0,17
		0.14	0.0019	0.0020	0.0030	0.0044	0.0065
K2	MP10-10007B90Z3-M03 MP3000	3,5	0,044	0,046	0,070	0,095	0,15
		0.14	0.0017	0.0018	0.0028	0.0038	0.0060
K3	MP10-10007B90Z3-M03 MP3000	3,5	0,044	0,046	0,070	0,095	0,15
		0.14	0.0017	0.0018	0.0028	0.0038	0.0060
K4	MP10-10007B90Z3-M03 MP3000	3,5	0,044	0,046	0,070	0,095	0,15
		0.14	0.0017	0.0018	0.0028	0.0038	0.0060
K5	MP10-10007B90Z3-M03 MP3000	3,5	0,040	0,042	0,060	0,085	0,14
		0.14	0.0016	0.0017	0.0024	0.0034	0.0055
K6	MP10-10007B90Z3-M03 MP3000	3,5	0,044	0,046	0,070	0,095	0,15
		0.14	0.0017	0.0018	0.0028	0.0038	0.0060
K7	MP10-10007B90Z3-M03 MP3000	3,5	0,040	0,042	0,060	0,085	0,14
		0.14	0.0016	0.0017	0.0024	0.0034	0.0055
N1	MP10-10007B90Z3-E03 F40M	3,5	0,060	0,065	0,095	0,13	0,22
		0.14	0.0024	0.0026	0.0038	0.0050	0.0085
N2	MP10-10007B90Z3-E03 F40M	3,5	0,060	0,065	0,095	0,13	0,22
		0.14	0.0024	0.0026	0.0038	0.0050	0.0085
N3	MP10-10007B90Z3-E03 F40M	3,5	0,060	0,065	0,095	0,13	0,22
		0.14	0.0024	0.0026	0.0038	0.0050	0.0085
N11	MP10-10007B90Z3-E03 F40M	3,5	0,060	0,065	0,095	0,13	0,22
		0.14	0.0024	0.0026	0.0038	0.0050	0.0085
S1	MP10-10007B90Z3-E03 F40M	2,0	0,034	0,036	0,048	0,065	0,11
		0.080	0.0013	0.0014	0.0019	0.0026	0.0044
S2	MP10-10007B90Z3-E03 F40M	2,0	0,034	0,036	0,048	0,065	0,11
		0.080	0.0013	0.0014	0.0019	0.0026	0.0044
S3	MP10-10007B90Z3-E03 F40M	2,0	0,032	0,032	0,044	0,060	0,10
		0.080	0.0013	0.0013	0.0017	0.0024	0.0040
S11	MP10-10007B90Z3-E03 F40M	2,5	0,038	0,038	0,055	0,075	0,12
		0.10	0.0015	0.0015	0.0022	0.0030	0.0048
S12	MP10-10007B90Z3-E03 F40M	2,5	0,038	0,038	0,055	0,075	0,12
		0.10	0.0015	0.0015	0.0022	0.0030	0.0048
S13	MP10-10007B90Z3-E03 F40M	2,0	0,034	0,036	0,048	0,065	0,11
		0.080	0.0013	0.0014	0.0019	0.0026	0.0044
H5	MP10-10007B90Z3-M03 MP3000	2,5	0,032	0,032	0,046	0,065	0,10
		0.10	0.0013	0.0013	0.0018	0.0026	0.0040
H8	MP10-10007B90Z3-M03 MP3000	2,5	0,025	0,025	0,036	0,050	0,080
		0.10	0.0010	0.0010	0.0014	0.0020	0.0032
H11	MP10-10007B90Z3-M03 MP3000	2,5	0,032	0,032	0,046	0,065	0,10
		0.10	0.0013	0.0013	0.0018	0.0026	0.0040
H12	MP10-10007B90Z3-M03 MP3000	2,5	0,025	0,025	0,036	0,050	0,080
		0.10	0.0010	0.0010	0.0014	0.0020	0.0032
H21	MP10-10007B90Z3-M03 MP3000	2,5	0,025	0,025	0,036	0,050	0,080
		0.10	0.0010	0.0010	0.0014	0.0020	0.0032

SMG = Seco material group
f_z = mm/tooth (in/tooth), v_c = m/min (sf/min), a_p/DC = %
All cutting data are start values

Universal
Steel and cast iron
Stainless steel and S-materials
Stainless steel and S-materials
Non ferrous
Hard
Graphite
X-Heads
Minimaster Plus
Minimaster

MP10 Copy milling – Cutting data $v_c = (m/min)/(sf/min)$

SMG	MP3000					F40M				
	100%	30%	10%	5%	2%	100%	30%	10%	5%	2%
P1	275	330	360	385	385	260	310	340	365	365
	900	1075	1175	1275	1275	850	1025	1125	1200	1200
P2	265	320	345	375	375	250	300	325	355	355
	870	1050	1125	1225	1225	820	980	1075	1175	1175
P3	230	280	300	325	325	220	265	285	310	305
	750	920	980	1075	1075	720	870	940	1025	1000
P4	205	245	265	290	290	195	230	250	270	270
	670	800	870	950	950	640	750	820	890	890
P5	195	235	255	275	275	185	220	240	260	260
	640	770	840	900	900	610	720	790	850	850
P6	220	265	285	310	310	205	250	270	295	290
	720	870	940	1025	1025	670	820	890	970	950
P7	205	250	270	295	290	195	235	255	275	275
	670	820	890	970	950	640	770	840	900	900
P8	195	235	255	275	270	185	220	240	260	255
	640	770	840	900	890	610	720	790	850	840
P11	200	245	265	285	285	190	230	250	270	265
	660	800	870	940	940	620	750	820	890	870
P12	125	155	160	175	175	120	145	155	165	165
	410	510	520	570	570	395	475	510	540	540
M1	200	240	260	280	280	205	245	265	285	285
	660	790	850	920	920	670	800	870	940	940
M2	165	195	215	230	230	165	200	215	235	235
	540	640	710	750	750	540	660	710	770	770
M3	130	160	165	180	180	135	160	170	185	185
	425	520	540	590	590	445	520	560	610	610
M4	100	125	125	140	140	105	125	130	140	140
	330	410	410	460	460	345	410	425	460	460
M5	85	100	105	115	115	85	105	110	115	115
	280	330	345	375	375	280	345	360	375	375
K1	210	255	275	300	300	200	240	260	280	280
	690	840	900	980	980	660	790	850	920	920
K2	185	220	245	260	260	175	210	230	245	245
	610	720	800	850	850	570	690	750	800	800
K3	155	190	205	220	220	150	180	195	210	210
	510	620	670	720	720	490	590	640	690	690
K4	150	180	195	210	210	140	170	185	200	200
	490	590	640	690	690	460	560	610	660	660
K5	90	110	120	125	130	85	105	110	120	120
	295	360	395	410	425	280	345	360	395	395
K6	130	160	175	185	185	125	150	165	175	175
	425	520	570	610	610	410	490	540	570	570
K7	115	140	150	165	165	110	130	145	155	155
	375	460	490	540	540	360	425	475	510	510
N1	1600	1925	2100	2275	2250	1500	1825	1975	2150	2125
	5250	6325	6900	7475	7375	4925	6000	6475	7050	6975
N2	650	780	840	920	900	610	730	800	860	850
	2125	2550	2750	3025	2950	2000	2400	2625	2825	2800
N3	430	520	560	610	600	405	490	530	580	570
	1400	1700	1825	2000	1975	1325	1600	1750	1900	1875
N11	490	590	640	700	690	465	560	610	660	650
	1600	1925	2100	2300	2275	1525	1825	2000	2175	2125
S1	47	55	60	65	65	48	60	60	65	65
	155	180	195	215	215	155	195	195	215	215
S2	38	46	48	50	50	39	47	49	55	55
	125	150	155	165	165	130	155	160	180	180
S3	33	40	41	45	45	34	41	42	46	46
	110	130	135	150	150	110	135	140	150	150
S11	65	80	85	90	90	70	85	85	95	95
	215	260	280	295	295	230	280	280	310	310
S12	46	55	60	65	65	47	55	60	65	65
	150	180	195	215	215	155	180	195	215	215
S13	27	32	33	36	36	27	33	34	37	37
	90	105	110	120	120	90	110	110	120	120
H5	39	48	50	55	55	40	48	50	55	55
	130	155	165	180	180	130	155	165	180	180
H8	41	50	50	55	55	41	50	50	55	55
	135	165	165	180	180	135	165	165	180	180
H11	50	60	65	70	70	50	60	65	70	70
	165	195	215	230	230	165	195	215	230	230
H12	80	95	100	110	110	75	90	95	100	100
	260	310	330	360	360	245	295	310	330	330
H21	41	50	50	55	55	41	50	50	55	55
	135	165	165	180	180	135	165	165	180	180

MP10 Centre drilling – Insert selection – mm/Inch

SMG		f_z	a_{so}
			100%
P1	MP10-10006C90Z2-M03 F40M	0,042 0,0017	3,0 0,12
P2	MP10-10006C90Z2-M03 F40M	0,042 0,0017	3,0 0,12
P3	MP10-10006C90Z2-M03 F40M	0,040 0,0016	3,0 0,12
P4	MP10-10006C90Z2-M03 F40M	0,040 0,0016	3,0 0,12
P5	MP10-10006C90Z2-M03 F40M	0,040 0,0016	3,0 0,12
P6	MP10-10006C90Z2-M03 F40M	0,038 0,0015	3,0 0,12
P7	MP10-10006C90Z2-M03 F40M	0,038 0,0015	3,0 0,12
P8	MP10-10006C90Z2-M03 F40M	0,040 0,0016	3,0 0,12
P11	MP10-10006C90Z2-M03 F40M	0,038 0,0015	3,0 0,12
P12	MP10-10006C90Z2-M03 F40M	0,026 0,0010	2,0 0,080
M1	MP10-10006C90Z2-M03 F40M	0,042 0,0017	3,0 0,12
M2	MP10-10006C90Z2-M03 F40M	0,040 0,0016	3,0 0,12
M3	MP10-10006C90Z2-M03 F40M	0,032 0,0013	2,0 0,080
M4	MP10-10006C90Z2-M03 F40M	0,028 0,0011	1,7 0,065
M5	MP10-10006C90Z2-M03 F40M	0,028 0,0011	1,7 0,065
K1	MP10-10006C90Z2-M03 F40M	0,042 0,0017	3,0 0,12
K2	MP10-10006C90Z2-M03 F40M	0,040 0,0016	3,0 0,12
K3	MP10-10006C90Z2-M03 F40M	0,040 0,0016	3,0 0,12
K4	MP10-10006C90Z2-M03 F40M	0,040 0,0016	3,0 0,12
K5	MP10-10006C90Z2-M03 F40M	0,036 0,0014	3,0 0,12
K6	MP10-10006C90Z2-M03 F40M	0,040 0,0016	3,0 0,12
K7	MP10-10006C90Z2-M03 F40M	0,036 0,0014	3,0 0,12
N1	MP10-10006C90Z2-M03 F40M	0,055 0,0022	3,0 0,12
N2	MP10-10006C90Z2-M03 F40M	0,055 0,0022	3,0 0,12
N3	MP10-10006C90Z2-M03 F40M	0,055 0,0022	3,0 0,12
N11	MP10-10006C90Z2-M03 F40M	0,055 0,0022	3,0 0,12
S1	MP10-10006C90Z2-M03 F40M	0,028 0,0011	1,7 0,065
S2	MP10-10006C90Z2-M03 F40M	0,028 0,0011	1,7 0,065
S3	MP10-10006C90Z2-M03 F40M	0,025 0,0010	1,7 0,065
S11	MP10-10006C90Z2-M03 F40M	0,032 0,0013	1,9 0,075
S12	MP10-10006C90Z2-M03 F40M	0,032 0,0013	1,9 0,075
S13	MP10-10006C90Z2-M03 F40M	0,028 0,0011	1,7 0,065
H5	MP10-10006C90Z2-M03 F40M	0,026 0,0010	2,0 0,080
H8	MP10-10006C90Z2-M03 F40M	0,020 0,00080	1,9 0,075
H11	MP10-10006C90Z2-M03 F40M	0,026 0,0010	2,0 0,080
H12	MP10-10006C90Z2-M03 F40M	0,020 0,00080	1,9 0,075
H21	MP10-10006C90Z2-M03 F40M	0,020 0,00080	1,9 0,075

SMG = Seco material group
 f_z = mm/tooth (in/tooth), v_c = m/min (sf/min), a_g/DC = %
 All cutting data are start values

Universal
 Steel and cast iron
 Stainless steel and S-materials
 Stainless steel and S-materials
 Non ferrous
 Hard
 Graphite
 X-Heads
 Minimaster Plus
 Minimaster

MP10 Centre drilling – Cutting data $v_c = (m/min)/(sf/min)$

	MP10 Centre drilling – Cutting data $v_c = (m/min)/(sf/min)$	
	SMG	F40M
Universal		100%
	P1	305 1000
Steel and cast iron	P2	295 970
	P3	260 850
	P4	225 740
	P5	215 710
	P6	245 800
	P7	230 750
Stainless steel and S-materials	P8	215 710
	P11	225 740
	P12	135 445
	M1	240 790
	M2	195 640
Non ferrous	M3	150 490
	M4	110 360
	M5	95 310
	K1	235 770
Hard	K2	205 670
	K3	175 570
Plastic and cfrp	K4	165 540
	K5	100 330
	K6	145 475
	K7	130 425
	Graphite	N1
N2		710 2325
N3		475 1550
N11		540 1775
X-Heads	S1	50 165
	S2	42 140
	S3	36 120
	S11	75 245
	S12	50 165
Minimaster Plus	S13	29 95
	H5	45 150
	H8	46 150
Minimaster	H11	55 180
	H12	85 280
	H21	46 150

MP10 Chamfering – Insert selection – mm/Inch

SMG		a _p	f _z				
			100%	50%	30%	20%	10%
P1	MP10-10006C90Z2-M03 F40M	2,0	0,060	0,060	0,060	0,060	0,075
		0,080	0,0024	0,0024	0,0024	0,0024	0,0030
P2	MP10-10006C90Z2-M03 F40M	2,0	0,060	0,060	0,060	0,060	0,075
		0,080	0,0024	0,0024	0,0024	0,0024	0,0030
P3	MP10-10006C90Z2-M03 F40M	2,0	0,055	0,055	0,055	0,055	0,070
		0,080	0,0022	0,0022	0,0022	0,0022	0,0028
P4	MP10-10006C90Z2-M03 F40M	2,0	0,055	0,055	0,055	0,055	0,070
		0,080	0,0022	0,0022	0,0022	0,0022	0,0028
P5	MP10-10006C90Z2-M03 F40M	2,0	0,055	0,055	0,055	0,055	0,065
		0,080	0,0022	0,0022	0,0022	0,0022	0,0026
P6	MP10-10006C90Z2-M03 F40M	2,0	0,055	0,055	0,055	0,055	0,065
		0,080	0,0022	0,0022	0,0022	0,0022	0,0026
P7	MP10-10006C90Z2-M03 F40M	2,0	0,055	0,055	0,055	0,055	0,065
		0,080	0,0022	0,0022	0,0022	0,0022	0,0026
P8	MP10-10006C90Z2-M03 F40M	2,0	0,055	0,055	0,055	0,055	0,070
		0,080	0,0022	0,0022	0,0022	0,0022	0,0028
P11	MP10-10006C90Z2-M03 F40M	2,0	0,055	0,055	0,055	0,055	0,065
		0,080	0,0022	0,0022	0,0022	0,0022	0,0026
P12	MP10-10006C90Z2-M03 F40M	1,8	0,038	0,038	0,038	0,038	0,046
		0,070	0,0015	0,0015	0,0015	0,0015	0,0018
M1	MP10-10006C90Z2-M03 F40M	2,0	0,060	0,060	0,060	0,060	0,075
		0,080	0,0024	0,0024	0,0024	0,0024	0,0030
M2	MP10-10006C90Z2-M03 F40M	2,0	0,055	0,055	0,055	0,055	0,065
		0,080	0,0022	0,0022	0,0022	0,0022	0,0026
M3	MP10-10006C90Z2-M03 F40M	1,8	0,044	0,044	0,044	0,044	0,055
		0,070	0,0017	0,0017	0,0017	0,0017	0,0022
M4	MP10-10006C90Z2-M03 F40M	1,3	0,038	0,038	0,038	0,038	0,048
		0,050	0,0015	0,0015	0,0015	0,0015	0,0019
M5	MP10-10006C90Z2-M03 F40M	1,3	0,038	0,038	0,038	0,038	0,048
		0,050	0,0015	0,0015	0,0015	0,0015	0,0019
K1	MP10-10006C90Z2-M03 F40M	2,0	0,060	0,060	0,060	0,060	0,075
		0,080	0,0024	0,0024	0,0024	0,0024	0,0030
K2	MP10-10006C90Z2-M03 F40M	2,0	0,055	0,055	0,055	0,055	0,065
		0,080	0,0022	0,0022	0,0022	0,0022	0,0026
K3	MP10-10006C90Z2-M03 F40M	2,0	0,055	0,055	0,055	0,055	0,065
		0,080	0,0022	0,0022	0,0022	0,0022	0,0026
K4	MP10-10006C90Z2-M03 F40M	2,0	0,055	0,055	0,055	0,055	0,065
		0,080	0,0022	0,0022	0,0022	0,0022	0,0026
K5	MP10-10006C90Z2-M03 F40M	2,0	0,050	0,050	0,050	0,050	0,060
		0,080	0,0020	0,0020	0,0020	0,0020	0,0024
K6	MP10-10006C90Z2-M03 F40M	2,0	0,055	0,055	0,055	0,055	0,065
		0,080	0,0022	0,0022	0,0022	0,0022	0,0026
K7	MP10-10006C90Z2-M03 F40M	2,0	0,050	0,050	0,050	0,050	0,060
		0,080	0,0020	0,0020	0,0020	0,0020	0,0024
N1	MP10-10006C90Z2-M03 F40M	2,0	0,075	0,075	0,075	0,075	0,095
		0,080	0,0030	0,0030	0,0030	0,0030	0,0038
N2	MP10-10006C90Z2-M03 F40M	2,0	0,075	0,075	0,075	0,075	0,095
		0,080	0,0030	0,0030	0,0030	0,0030	0,0038
N3	MP10-10006C90Z2-M03 F40M	2,0	0,075	0,075	0,075	0,075	0,095
		0,080	0,0030	0,0030	0,0030	0,0030	0,0038
N11	MP10-10006C90Z2-M03 F40M	2,0	0,075	0,075	0,075	0,075	0,095
		0,080	0,0030	0,0030	0,0030	0,0030	0,0038
S1	MP10-10006C90Z2-M03 F40M	1,3	0,038	0,038	0,038	0,038	0,048
		0,050	0,0015	0,0015	0,0015	0,0015	0,0019
S2	MP10-10006C90Z2-M03 F40M	1,3	0,038	0,038	0,038	0,038	0,048
		0,050	0,0015	0,0015	0,0015	0,0015	0,0019
S3	MP10-10006C90Z2-M03 F40M	1,3	0,036	0,036	0,036	0,036	0,044
		0,050	0,0014	0,0014	0,0014	0,0014	0,0017
S11	MP10-10006C90Z2-M03 F40M	1,5	0,044	0,044	0,044	0,044	0,055
		0,060	0,0017	0,0017	0,0017	0,0017	0,0022
S12	MP10-10006C90Z2-M03 F40M	1,5	0,044	0,044	0,044	0,044	0,055
		0,060	0,0017	0,0017	0,0017	0,0017	0,0022
S13	MP10-10006C90Z2-M03 F40M	1,3	0,038	0,038	0,038	0,038	0,048
		0,050	0,0015	0,0015	0,0015	0,0015	0,0019
H5	MP10-10006C90Z2-M03 F40M	1,8	0,038	0,038	0,038	0,038	0,046
		0,070	0,0015	0,0015	0,0015	0,0015	0,0018
H8	MP10-10006C90Z2-M03 F40M	1,5	0,028	0,028	0,028	0,028	0,034
		0,060	0,0011	0,0011	0,0011	0,0011	0,0013
H11	MP10-10006C90Z2-M03 F40M	1,8	0,038	0,038	0,038	0,038	0,046
		0,070	0,0015	0,0015	0,0015	0,0015	0,0018
H12	MP10-10006C90Z2-M03 F40M	1,5	0,028	0,028	0,028	0,028	0,034
		0,060	0,0011	0,0011	0,0011	0,0011	0,0013
H21	MP10-10006C90Z2-M03 F40M	1,5	0,028	0,028	0,028	0,028	0,034
		0,060	0,0011	0,0011	0,0011	0,0011	0,0013

SMG = Seco material group
f_z = mm/tooth (in/tooth), v_c = m/min (sf/min), a_p/DC = %
All cutting data are start values

Universal
Steel and cast iron
Stainless steel and S-materials
Stainless steel and S-materials
Non ferrous
Hard
Graphite
X-Heads
Minimaster Plus
Minimaster

MP10 Chamfering – Cutting data $v_c = (m/min)/(sf/min)$

	SMG		F40M			
	100%	50%	30%	20%	10%	
Universal	P1	330	300	360	395	465
		1075	980	1175	1300	1525
Steel and cast iron	P2	320	290	350	385	455
		1050	950	1150	1275	1500
Stainless steel and S-materials	P3	285	255	305	340	395
		940	840	1000	1125	1300
Non ferrous	P4	250	225	270	300	350
		820	740	890	980	1150
Hard	P5	240	215	260	285	335
		790	710	850	940	1100
Plastic and CFRP	P6	265	240	290	320	380
		870	790	950	1050	1250
Graphite	P7	250	230	275	300	355
		820	750	900	980	1175
X-Heads	P8	240	215	260	285	330
		790	710	850	940	1075
Minimaster Plus	P11	245	220	265	295	345
		800	720	870	970	1125
Minimaster	P12	155	140	160	175	220
		510	460	520	570	720
Universal	M1	260	235	280	310	365
		850	770	920	1025	1200
Steel and cast iron	M2	215	195	230	255	305
		710	640	750	840	1000
Stainless steel and S-materials	M3	170	150	175	195	240
		560	490	570	640	790
Non ferrous	M4	130	110	125	140	185
		425	360	410	460	610
Hard	M5	105	90	105	120	155
		345	295	345	395	510
Plastic and CFRP	K1	255	230	275	305	360
		840	750	900	1000	1175
Graphite	K2	225	205	245	270	320
		740	670	800	890	1050
X-Heads	K3	190	175	205	230	270
		620	570	670	750	890
Minimaster Plus	K4	180	165	200	220	260
		590	540	660	720	850
Minimaster	K5	110	100	120	135	155
		360	330	395	445	510
Universal	K6	160	145	175	190	230
		520	475	570	620	750
Steel and cast iron	K7	140	130	155	170	200
		460	425	510	560	660
Stainless steel and S-materials	N1	1925	1725	2075	2300	2700
		6325	5650	6800	7550	8850
Non ferrous	N2	770	690	840	930	1100
		2525	2275	2750	3050	3600
Hard	N3	520	465	560	620	730
		1700	1525	1825	2025	2400
Plastic and CFRP	N11	590	530	640	710	830
		1925	1750	2100	2325	2725
Graphite	S1	60	50	60	65	85
		195	165	195	215	280
X-Heads	S2	48	41	47	55	70
		155	135	155	180	230
Minimaster Plus	S3	42	36	41	46	60
		140	120	135	150	195
Minimaster	S11	85	75	85	95	120
		280	245	280	310	395
Universal	S12	60	50	60	65	85
		195	165	195	215	280
Steel and cast iron	S13	34	29	33	37	48
		110	95	110	120	155
Stainless steel and S-materials	H5	50	46	50	60	75
		165	150	165	195	245
Non ferrous	H8	55	47	55	60	75
		180	155	180	195	245
Hard	H11	65	60	65	75	90
		215	195	215	245	295
Plastic and CFRP	H12	95	85	95	110	135
		310	280	310	360	445
Graphite	H21	55	47	55	60	75
		180	155	180	195	245

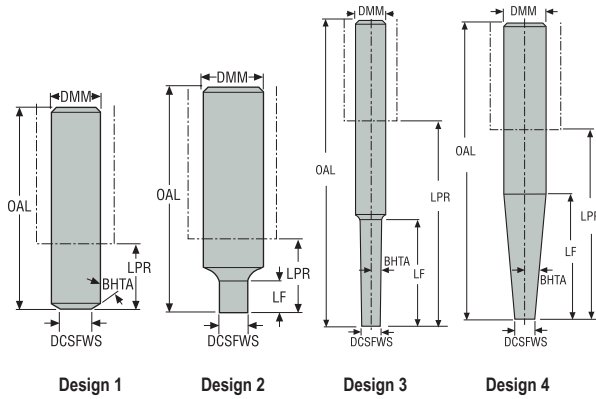

MP12 Shank – Metric



• Cylindrical shank DMM with tolerance h5, compatible for Shrinkfit

Designation	Type of mounting	DCSFWS	DMM	OAL	LPR	LF	RPMX	BHTA°	Design	Weight
		mm	mm	mm	mm	mm				kg
MP12-12060-012.00	Cylindrical	11,5	12,0	60,0	15,0	12,0	72700	0,0	2	0,1
MP12-16068-000.60	Cylindrical	11,5	16,0	68,0	20,0	0,0	72700	60,0	1	0,2
MP12-16078-018.00	Cylindrical	11,5	16,0	78,0	30,0	18,0	72700	0,0	2	0,1
MP12-16153-042.01	Cylindrical	11,5	16,0	153,0	105,0	42,0	72700	1,0	3	0,2
MP12-20170-072.01	Cylindrical	11,5	20,0	170,0	120,0	72,0	72700	1,0	3	0,3
MP12-20110-055.03	Cylindrical	11,5	20,0	110,0	60,0	55,0	72700	3,0	3	0,2
MP12-20150-100.03	Cylindrical	11,5	20,0	150,0	100,0	81,1	72700	3,0	3	0,3
MP12-20155-105.05	Cylindrical	11,5	20,0	155,0	105,0	48,6	72700	5,0	4	0,4
MP12-16107-036.00-E	Cylindrical	11,5	16,0	107,0	59,0	36,0	72700	0,0	2	0,3
MP12-16120-048.00-E	Cylindrical	11,5	16,0	120,0	72,0	48,0	72700	0,0	2	0,3
MP12-16150-072.00-E	Cylindrical	11,5	16,0	150,0	102,0	72,0	72700	0,0	2	0,3
MP12-16120-060.01-E	Cylindrical	11,5	16,0	120,0	72,0	60,0	72700	1,0	3	0,3
MP12-16150-096.01-E	Cylindrical	11,5	16,0	150,0	102,0	96,0	72700	1,0	3	0,4
MP12-16175-120.01-E	Cylindrical	11,5	16,0	175,0	127,0	120,0	72700	1,0	3	0,4
MP12-16155-107.03-E	Cylindrical	11,5	16,0	155,0	107,0	42,9	72700	3,0	4	0,4
MP12-16180-132.03-E	Cylindrical	11,5	16,0	180,0	132,0	42,9	72700	3,0	4	0,5

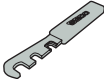
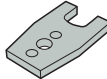
Accessories

Key	Replacement blade	Torque key
		
MP1016	MP00-12M	MP00-12.150

Blades are included with the torque key

Universal

Steel and cast iron

Stainless steel and S-materials

Stainless steel and S-materials

Non ferrous

Hard

Graphite

X-Heads

Minimaster Plus

Minimaster

MP12 Shank – Inch

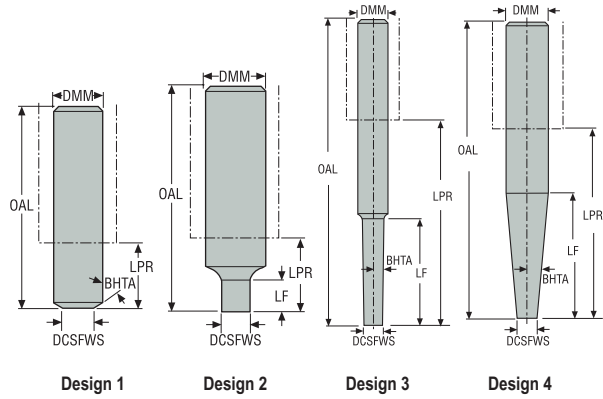

- Cylindrical shank DMM with tolerance h5, compatible for Shrinkfit

Designation	Type of mounting	DCSFWS	DMM	OAL	LPR	LF	RPMX	BHTA°	Design	Weight
		inch	inch	inch	inch	inch				lbs
MP12-0502.3-0.47.00	Cylindrical	0.453	0.500	2.341	0.591	0.472	72700	0,0	2	✓ 0.220
MP12-0622.6-0.00.60	Cylindrical	0.453	0.625	2.662	0.787	0	72700	60,0	1	✓ 0.220
MP12-0623.0-0.70.00	Cylindrical	0.453	0.625	3.056	1.181	0.709	72700	0,0	2	✓ 0.220
MP12-0626.0-1.65.01	Cylindrical	0.453	0.625	6.009	4.134	1.654	72700	1,0	3	✓ 0.440
MP12-0754.3-2.20.03	Cylindrical	0.453	0.750	4.362	2.362	2.201	72700	3,0	3	✓ 0.440
MP12-0755.9-3.93.03	Cylindrical	0.453	0.750	5.937	3.937	2.835	72700	3,0	3	✓ 0.660
MP12-0756.1-4.13.05	Cylindrical	0.453	0.750	6.134	4.134	1.697	72700	5,0	4	✓ 0.660
MP12-0756.7-2.83.01	Cylindrical	0.453	0.750	6.724	4.724	2.835	72700	1,0	4	✓ 0.660
MP12-0627.0-5.19.03-E	Cylindrical	0.453	0.625	7.072	5.197	1.654	72700	3,0	4	✓ 1.100
MP12-0625.8-2.83.00-E	Cylindrical	0.453	0.625	5.891	4.016	2.835	72700	0,0	2	✓ 0.660

Accessories

Key	Replacement blade	Torque key
MP1016	MP00-12M	MP00-12.150

Blades are included with the torque key

Universal

Steel and cast iron

Stainless steel and S-materials

Non ferrous

Hard

Plastic and CFRP

Graphite

X-Heads

Minimaster Plus

Minimaster

MP12 High feed

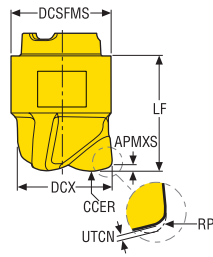

• For insert selection and cutting data recommendations, see page(s) 601-602

Z3



Designation	DCX	DC	APMXS	DCSFMS	CCER	RP	LF	UTCN	RMPX°	C min	C max	ZEFP	Grades	
													MP3000	F40M
MP12-1200.7HFZ3-MD10	12,0 0.472	6,0 0.236	0,7 0.028	11,52 0.454	7,5 0.295	1,66 0.065	13,3 0.524	0,33 0.013	5,0	13,1	17,8	3	■	
MP12-1270.7HFZ3-MD10	12,7 0.500	6,7 0.264	0,7 0.028	11,52 0.454	7,5 0.295	1,66 0.065	13,3 0.524	0,32 0.013	5,0	13,8	19,2	3	■	

Universal

Steel and cast iron

Stainless steel and S-materials

Stainless steel and S-materials

Non ferrous

Hard

Graphite

X-Heads

Minimaster Plus

Minimaster

MP12 Square shoulder

Slotting and contouring

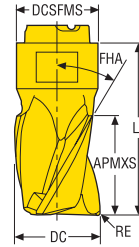

• For insert selection and cutting data recommendations, see page(s) 603-604

Z3



Designation	DC	APMXS	RE	DCSFMS	FHA°	LF	RMPX°	C min	C max	ZEFP	Grades	
											MP3000	F40M
	mm Inch	mm Inch	mm Inch	mm Inch	mm Inch	mm Inch						
MP12-12008R04Z3-E04	12,0 0.472	8,0 0.315	0,4 0.016	11,5 0.453	30 1.181	18,8 0.740	15,0	14,6	23,0	3		■
MP12-12008R04Z3-M04	12,0 0.472	8,0 0.315	0,4 0.016	11,5 0.453	30 1.181	18,8 0.740	15,0	14,6	23,0	3	■	
MP12-12008R05Z3-E04	12,0 0.472	8,0 0.315	0,5 0.020	11,5 0.453	30 1.181	18,8 0.740	15,0	14,6	22,8	3		■
MP12-12008R08Z3-E04	12,0 0.472	8,0 0.315	0,8 0.031	11,5 0.453	30 1.181	18,8 0.740	15,0	14,6	22,2	3		■
MP12-12008R08Z3-M04	12,0 0.472	8,0 0.315	0,8 0.031	11,5 0.453	30 1.181	18,8 0.740	15,0	14,6	22,2	3	■	
MP12-12008R16Z3-E04	12,0 0.472	8,0 0.315	1,6 0.063	11,5 0.453	30 1.181	18,8 0.740	15,0	14,6	20,6	3		■
MP12-12008R31Z3-E04	12,0 0.472	8,0 0.315	3,1 0.122	11,5 0.453	30 1.181	18,8 0.740	15,0	14,6	17,6	3		■
MP12-12708R08Z3-M04	12,7 0.500	8,0 0.315	0,8 0.031	11,5 0.453	30 1.181	18,8 0.740	15,0	15,4	23,6	3	■	

Universal

Steel and cast iron

Stainless steel
and S-materials

Non ferrous

Hard

Plastic and CFRP

Graphite

X-Heads

Minimaster Plus

Minimaster

MP12 Square shoulder

Slotting and contouring

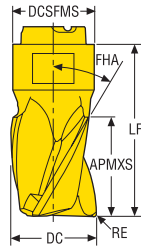

• For insert selection and cutting data recommendations, see page(s) 603-604

Z3



Designation	DC	APMXS	RE	DCSFMS	FHA°	LF	RMPX°	C min	C max	ZEFP	Grades	
											MP3000	F40M
	mm Inch	mm Inch	mm Inch	mm Inch	mm Inch	mm Inch						Coated
MP12-11714KWZ3-E04	11,7 0.461	14,0 0.551	0,3 0.012	11,5 0.453	30 1.181	24,0 0.945	15,0	14,2	22,6	3		■
MP12-12014R04Z3-E04	12,0 0.472	14,0 0.551	0,4 0.016	11,5 0.453	30 1.181	24,0 0.945	15,0	14,6	23,0	3		■
MP12-12014R04Z3-M04	12,0 0.472	14,0 0.551	0,4 0.016	11,5 0.453	30 1.181	24,0 0.945	15,0	14,6	23,0	3	■	
MP12-12014R05Z3-E04	12,0 0.472	14,0 0.551	0,5 0.020	11,5 0.453	30 1.181	24,0 0.945	15,0	14,6	22,8	3		■
MP12-12014R08Z3-M04	12,0 0.472	14,0 0.551	0,8 0.031	11,5 0.453	30 1.181	24,0 0.945	15,0	14,6	22,2	3	■	
MP12-12014R12Z3-E04	12,0 0.472	14,0 0.551	1,2 0.047	11,5 0.453	30 1.181	24,0 0.945	15,0	14,6	21,4	3		■
MP12-12014R12Z3-M04	12,0 0.472	14,0 0.551	1,2 0.047	11,5 0.453	30 1.181	24,0 0.945	15,0	14,6	21,4	3	■	
MP12-12014R20Z3-E04	12,0 0.472	14,0 0.551	2,0 0.079	11,5 0.453	30 1.181	24,0 0.945	15,0	14,6	19,8	3		■
MP12-12014R31Z3-E04	12,0 0.472	14,0 0.551	3,1 0.122	11,5 0.453	30 1.181	24,0 0.945	15,0	14,6	17,6	3		■
MP12-12714R04Z3-E04	12,7 0.500	14,0 0.551	0,4 0.016	11,5 0.453	30 1.181	24,0 0.945	15,0	15,4	24,4	3		■
MP12-12714R04Z3-M04	12,7 0.500	14,0 0.551	0,4 0.016	11,5 0.453	30 1.181	24,0 0.945	15,0	15,4	24,4	3	■	

Universal

Steel and cast iron

Stainless steel and S-materials

Stainless steel and S-materials

Non ferrous

Hard

Graphite

X-Heads

Minimaster Plus

Minimaster

MP12 Square shoulder

Slotting and contouring

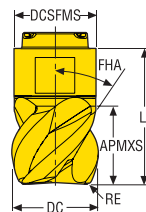

• For insert selection and cutting data recommendations, see page(s) 603-604

Z4



Designation	DC	APMXS	RE	DCSFMS	FHA°	LF	RMPX°	C min	C max	ZEFP	Grades	
											MP3000	F40M
	mm Inch	mm Inch	mm Inch	mm Inch	mm Inch	mm Inch						
MP12-12008R04Z4-M03	12,0 0.472	8,0 0.315	0,4 0.016	11,5 0.453	50 1.969	18,8 0.740	15,0	14,6	23,0	4	■	
MP12-12008R05Z4-E03	12,0 0.472	8,0 0.315	0,5 0.020	11,5 0.453	50 1.969	18,8 0.740	15,0	14,6	22,8	4		■
MP12-12008R08Z4-E03	12,0 0.472	8,0 0.315	0,8 0.031	11,5 0.453	50 1.969	18,8 0.740	15,0	14,6	22,2	4		■
MP12-12008R08Z4-M03	12,0 0.472	8,0 0.315	0,8 0.031	11,5 0.453	50 1.969	18,8 0.740	15,0	14,6	22,2	4	■	
MP12-12008R12Z4-M03	12,0 0.472	8,0 0.315	1,2 0.047	11,5 0.453	50 1.969	18,8 0.740	15,0	14,6	21,4	4	■	
MP12-12008R24Z4-E03	12,0 0.472	8,0 0.315	2,4 0.094	11,5 0.453	50 1.969	18,8 0.740	15,0	14,6	19,0	4		■
MP12-12014R04Z4-M03	12,0 0.472	14,0 0.551	0,4 0.016	11,5 0.453	50 1.969	24,0 0.945	15,0	14,6	23,0	4	■	
MP12-12014R05Z4-E03	12,0 0.472	14,0 0.551	0,5 0.020	11,5 0.453	50 1.969	24,0 0.945	15,0	14,6	22,8	4		■
MP12-12014R08Z4-E03	12,0 0.472	14,0 0.551	0,8 0.031	11,5 0.453	50 1.969	24,0 0.945	15,0	14,6	22,2	4		■
MP12-12014R08Z4-M03	12,0 0.472	14,0 0.551	0,8 0.031	11,5 0.453	50 1.969	24,0 0.945	15,0	14,6	22,2	4	■	
MP12-12014R12Z4-E03	12,0 0.472	14,0 0.551	1,2 0.047	11,5 0.453	50 1.969	24,0 0.945	15,0	14,6	21,4	4		■
MP12-12014R12Z4-M03	12,0 0.472	14,0 0.551	1,2 0.047	11,5 0.453	50 1.969	24,0 0.945	15,0	14,6	21,4	4	■	
MP12-12014R16Z4-E03	12,0 0.472	14,0 0.551	1,6 0.063	11,5 0.453	50 1.969	24,0 0.945	15,0	14,6	20,6	4		■
MP12-12714R04Z4-E03	12,7 0.500	14,0 0.551	0,4 0.016	11,5 0.453	50 1.969	24,0 0.945	15,0	15,4	24,4	4		■
MP12-12714R04Z4-M03	12,7 0.500	14,0 0.551	0,4 0.016	11,5 0.453	50 1.969	24,0 0.945	15,0	15,4	24,4	4	■	
MP12-12714R08Z4-E03	12,7 0.500	14,0 0.551	0,8 0.031	11,5 0.453	50 1.969	24,0 0.945	15,0	15,4	23,9	4		■
MP12-12714R08Z4-M03	12,7 0.500	14,0 0.551	0,8 0.031	11,5 0.453	50 1.969	24,0 0.945	15,0	15,4	23,6	4	■	

MP12 Square shoulder

Contouring only

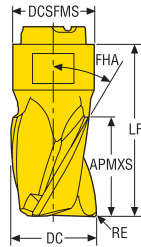

• For insert selection and cutting data recommendations, see page(s) 603-604

Z6



Designation	DC		APMXS		RE		DCSFMS		LF		FHA°		ZEFP		 Grades Coated	
	mm	Inch	mm	Inch	mm	Inch	mm	Inch	mm	Inch					MP3000	F40M
MP12-12014R04Z6-M03	12,0	0.472	14,0	0.551	0,4	0.016	11,5	0.453	24,0	0.945	40	6			■	
MP12-12714R04Z6-M03	12,7	0.500	14,0	0.551	0,4	0.016	11,5	0.453	24,0	0.945	40	6			■	

Universal

Steel and cast iron

Stainless steel and S-materials

Stainless steel and S-materials

Non ferrous

Hard

Graphite

X-Heads

Minimaster Plus

Minimaster

MP12 Ball nose design

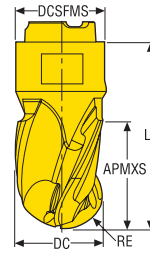

• For insert selection and cutting data recommendations, see page(s) 605-606

Z3



Z4



Designation	DC	APMXS	RE	DCSFMS	LF	FHA°	RMPX°	ZEFP	Grades	
									MP3000	F40M
	mm <i>Inch</i>	mm <i>Inch</i>	mm <i>Inch</i>	mm <i>Inch</i>	mm <i>Inch</i>				Coated	
MP12-12008B90Z3-E04	12,0 <i>0.472</i>	8,0 <i>0.315</i>	6,0 <i>0.236</i>	11,5 <i>0.453</i>	18,8 <i>0.740</i>	30	15,0	3		■
MP12-12008B90Z3-M04	12,0 <i>0.472</i>	8,0 <i>0.315</i>	6,0 <i>0.236</i>	11,5 <i>0.453</i>	18,8 <i>0.740</i>	30	15,0	3	■	
MP12-12008B90Z4-E03	12,0 <i>0.472</i>	8,0 <i>0.315</i>	6,0 <i>0.236</i>	11,5 <i>0.453</i>	18,7 <i>0.736</i>	20	15,0	4		■
MP12-12008B90Z4-M03	12,0 <i>0.472</i>	8,0 <i>0.315</i>	6,0 <i>0.236</i>	11,5 <i>0.453</i>	18,7 <i>0.736</i>	20	15,0	4	■	
MP12-12014B90Z3-E04	12,0 <i>0.472</i>	14,0 <i>0.551</i>	6,0 <i>0.236</i>	11,5 <i>0.453</i>	24,0 <i>0.945</i>	30	15,0	3		■
MP12-12014B90Z3-M04	12,0 <i>0.472</i>	14,0 <i>0.551</i>	6,0 <i>0.236</i>	11,5 <i>0.453</i>	24,0 <i>0.945</i>	30	15,0	3	■	
MP12-12708B90Z3-E04	12,7 <i>0.500</i>	8,0 <i>0.315</i>	6,35 <i>0.250</i>	11,5 <i>0.453</i>	18,8 <i>0.740</i>	30	15,0	3		■
MP12-12708B90Z3-M04	12,7 <i>0.500</i>	8,0 <i>0.315</i>	6,35 <i>0.250</i>	11,5 <i>0.453</i>	18,8 <i>0.740</i>	30	15,0	3	■	
MP12-12708B90Z4-E03	12,7 <i>0.500</i>	8,0 <i>0.315</i>	6,35 <i>0.250</i>	11,5 <i>0.453</i>	18,7 <i>0.736</i>	20	15,0	4		■
MP12-12708B90Z4-M03	12,7 <i>0.500</i>	8,0 <i>0.315</i>	6,35 <i>0.250</i>	11,5 <i>0.453</i>	18,7 <i>0.736</i>	20	15,0	4	■	
MP12-12714B90Z3-E04	12,7 <i>0.500</i>	14,0 <i>0.551</i>	6,35 <i>0.250</i>	11,5 <i>0.453</i>	24,0 <i>0.945</i>	30	15,0	3		■
MP12-12714B90Z3-M04	12,7 <i>0.500</i>	14,0 <i>0.551</i>	6,35 <i>0.250</i>	11,5 <i>0.453</i>	24,0 <i>0.945</i>	30	15,0	3	■	

MP12 Centre drilling/Chamfering

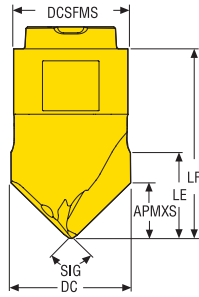

• For insert selection and cutting data recommendations, see page(s) 607-608

Z2



Designation	DC	APMXS	DCSFMS	LE	LF	SIG°	ZEFP		Grades	
									MP3000	Coated
	mm Inch	mm Inch	mm Inch	mm Inch	mm Inch				MP3000	F40M
MP12-12007C90Z2-M04	12,0 0.472	5,6 0.220	11,5 0.453	8,7 0.343	19,0 0.748	90,0	2			■

MP12 Chamfering

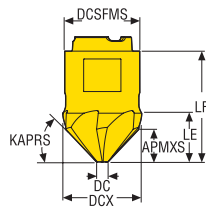

• For insert selection and cutting data recommendations, see page(s) 609-610

Z6



Designation	DCX	DC	APMXS	DCSFMS	LE	LF	KAPRS°	ZEFP		Grades	
										MP3000	Coated
	mm Inch	mm Inch	mm Inch	mm Inch	mm Inch	mm Inch				MP3000	F40M
MP12-12007C90Z6-M04	12,1 0.476	2,95 0.116	4,4 0.173	11,5 0.453	7,5 0.295	18,0 0.709	45,0	6			■

Universal
Steel and cast iron
Stainless steel and S-materials
Stainless steel and S-materials
Non ferrous
Hard
Graphite
X-Heads
Minimaster Plus
Minimaster

MP12 Cylindrical blanks

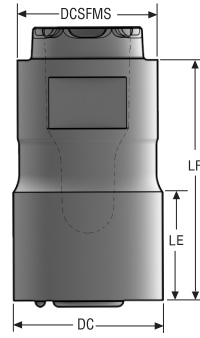

- Cylindrical carbide blanks for production of own geometries



Designation	DC		DCSFMS		LE		LF		Grades	
	mm	Inch	mm	Inch	mm	Inch	mm	Inch	Uncoated	H25
MP12-12008CYL-SEMI	12,95	0.510	11,5	0.453	9,4	0.370	19,35	0.762		■
MP12-12014CYL-SEMI	12,95	0.510	11,5	0.453	14,3	0.563	24,15	0.951		■

MP12 High feed milling – Insert selection – mm/Inch

SMG		a _p	f _z			
			100%	70%	30%	20%
P1	MP12-1200.7HFZ3-MD10 MP3000	0,48	0,55	0,55	0,70	0,90
		0.019	0.022	0.022	0.028	0.036
P2	MP12-1200.7HFZ3-MD10 MP3000	0,48	0,55	0,55	0,75	0,90
		0.019	0.022	0.022	0.030	0.036
P3	MP12-1200.7HFZ3-MD10 MP3000	0,48	0,55	0,55	0,70	0,85
		0.019	0.022	0.022	0.028	0.034
P4	MP12-1200.7HFZ3-MD10 MP3000	0,48	0,50	0,50	0,70	0,85
		0.019	0.020	0.020	0.028	0.034
P5	MP12-1200.7HFZ3-MD10 MP3000	0,48	0,50	0,50	0,65	0,80
		0.019	0.020	0.020	0.026	0.032
P6	MP12-1200.7HFZ3-MD10 MP3000	0,48	0,50	0,50	0,65	0,80
		0.019	0.020	0.020	0.026	0.032
P7	MP12-1200.7HFZ3-MD10 MP3000	0,48	0,50	0,50	0,65	0,80
		0.019	0.020	0.020	0.026	0.032
P8	MP12-1200.7HFZ3-MD10 MP3000	0,48	0,55	0,55	0,70	0,85
		0.019	0.022	0.022	0.028	0.034
P11	MP12-1200.7HFZ3-MD10 MP3000	0,48	0,50	0,50	0,65	0,80
		0.019	0.020	0.020	0.026	0.032
P12	MP12-1200.7HFZ3-MD10 MP3000	0,40	0,36	0,34	0,44	0,55
		0.016	0.014	0.013	0.017	0.022
M1	MP12-1200.7HFZ3-MD10 MP3000	0,48	0,55	0,55	0,75	0,90
		0.019	0.022	0.022	0.030	0.036
M2	MP12-1200.7HFZ3-MD10 MP3000	0,48	0,50	0,50	0,65	0,80
		0.019	0.020	0.020	0.026	0.032
M3	MP12-1200.7HFZ3-MD10 MP3000	0,40	0,42	0,42	0,55	0,65
		0.016	0.017	0.017	0.022	0.026
M4	MP12-1200.7HFZ3-MD10 MP3000	0,30	0,36	0,36	0,46	0,55
		0.012	0.014	0.014	0.018	0.022
M5	MP12-1200.7HFZ3-MD10 MP3000	0,30	0,36	0,36	0,46	0,55
		0.012	0.014	0.014	0.018	0.022
K1	MP12-1200.7HFZ3-MD10 MP3000	0,48	0,55	0,55	0,75	0,90
		0.019	0.022	0.022	0.030	0.036
K2	MP12-1200.7HFZ3-MD10 MP3000	0,48	0,50	0,50	0,65	0,80
		0.019	0.020	0.020	0.026	0.032
K3	MP12-1200.7HFZ3-MD10 MP3000	0,48	0,50	0,50	0,65	0,80
		0.019	0.020	0.020	0.026	0.032
K4	MP12-1200.7HFZ3-MD10 MP3000	0,48	0,50	0,50	0,65	0,80
		0.019	0.020	0.020	0.026	0.032
K5	MP12-1200.7HFZ3-MD10 MP3000	0,48	0,46	0,46	0,60	0,75
		0.019	0.018	0.018	0.024	0.030
K6	MP12-1200.7HFZ3-MD10 MP3000	0,48	0,50	0,50	0,65	0,80
		0.019	0.020	0.020	0.026	0.032
K7	MP12-1200.7HFZ3-MD10 MP3000	0,48	0,46	0,46	0,60	0,75
		0.019	0.018	0.018	0.024	0.030
N1	MP12-1200.7HFZ3-MD10 MP3000	0,48	0,70	0,70	0,95	1,2
		0.019	0.028	0.028	0.038	0.048
N2	MP12-1200.7HFZ3-MD10 MP3000	0,48	0,70	0,70	0,95	1,2
		0.019	0.028	0.028	0.038	0.048
N3	MP12-1200.7HFZ3-MD10 MP3000	0,48	0,70	0,70	0,95	1,2
		0.019	0.028	0.028	0.038	0.048
N11	MP12-1200.7HFZ3-MD10 MP3000	0,48	0,70	0,70	0,95	1,2
		0.019	0.028	0.028	0.038	0.048
S1	MP12-1200.7HFZ3-MD10 MP3000	0,30	0,36	0,36	0,46	0,55
		0.012	0.014	0.014	0.018	0.022
S2	MP12-1200.7HFZ3-MD10 MP3000	0,30	0,36	0,36	0,46	0,55
		0.012	0.014	0.014	0.018	0.022
S3	MP12-1200.7HFZ3-MD10 MP3000	0,30	0,34	0,34	0,42	0,50
		0.012	0.013	0.013	0.017	0.020
S11	MP12-1200.7HFZ3-MD10 MP3000	0,34	0,42	0,42	0,55	0,65
		0.013	0.017	0.017	0.022	0.026
S12	MP12-1200.7HFZ3-MD10 MP3000	0,34	0,42	0,42	0,55	0,65
		0.013	0.017	0.017	0.022	0.026
S13	MP12-1200.7HFZ3-MD10 MP3000	0,30	0,36	0,36	0,46	0,55
		0.012	0.014	0.014	0.018	0.022
H5	MP12-1200.7HFZ3-MD10 MP3000	0,40	0,36	0,34	0,44	0,55
		0.016	0.014	0.013	0.017	0.022
H8	MP12-1200.7HFZ3-MD10 MP3000	0,34	0,28	0,26	0,34	0,40
		0.013	0.011	0.010	0.013	0.016
H11	MP12-1200.7HFZ3-MD10 MP3000	0,40	0,36	0,34	0,44	0,55
		0.016	0.014	0.013	0.017	0.022
H12	MP12-1200.7HFZ3-MD10 MP3000	0,34	0,28	0,26	0,34	0,40
		0.013	0.011	0.010	0.013	0.016
H21	MP12-1200.7HFZ3-MD10 MP3000	0,34	0,28	0,26	0,34	0,40
		0.013	0.011	0.010	0.013	0.016

SMG = Seco material group
 f_z = mm/tooth (in/tooth), v_c = m/min (sf/min), a_p/DC = %
 All cutting data are start values

Universal
 Steel and cast iron
 Stainless steel and S-materials
 Stainless steel and S-materials
 Non ferrous
 Hard
 Graphite
 X-Heads
 Minimaster Plus
 Minimaster

MP12 High feed milling – Cutting data $v_c = (m/min)/(sf/min)$

	SMG	MP3000			
		100%	70%	30%	20%
Universal	P1	240	295	340	355
		790	970	1125	1175
Steel and cast iron	P2	235	285	325	345
		770	940	1075	1125
Stainless steel and S-materials	P3	205	245	285	300
		670	800	940	980
Non ferrous	P4	185	220	250	265
		610	720	820	870
Hard	P5	175	210	245	255
		570	690	800	840
Plastic and cfrp	P6	195	240	275	290
		640	790	900	950
Graphite	P7	185	225	260	275
		610	740	850	900
X-Heads	P8	170	205	240	255
		560	670	790	840
Minimaster Plus	P11	180	220	250	265
		590	720	820	870
Minimaster	P12	115	140	160	170
		375	460	520	560
Universal	M1	175	215	245	260
		570	710	800	850
Steel and cast iron	M2	145	175	205	215
		475	570	670	710
Stainless steel and S-materials	M3	120	140	160	170
		395	460	520	560
Non ferrous	M4	95	110	125	135
		310	360	410	445
Hard	M5	80	90	105	110
		260	295	345	360
Plastic and cfrp	K1	185	225	260	275
		610	740	850	900
Graphite	K2	165	200	230	245
		540	660	750	800
X-Heads	K3	140	170	195	205
		460	560	640	670
Minimaster Plus	K4	135	160	190	195
		445	520	620	640
Minimaster	K5	80	100	115	120
		260	330	375	395
Universal	K6	120	145	165	175
		395	475	540	570
Steel and cast iron	K7	105	125	145	150
		345	410	475	490
Stainless steel and S-materials	N1	1400	1700	1925	2025
		4600	5575	6325	6650
Non ferrous	N2	560	680	780	820
		1825	2225	2550	2700
Hard	N3	375	455	520	540
		1225	1500	1700	1775
Plastic and cfrp	N11	430	520	600	620
		1400	1700	1975	2025
Graphite	S1	44	50	60	60
		145	165	195	195
X-Heads	S2	35	41	47	50
		115	135	155	165
Minimaster Plus	S3	31	36	42	44
		100	120	140	145
Minimaster	S11	60	70	80	85
		195	230	260	280
Universal	S12	42	49	55	60
		140	160	180	195
Steel and cast iron	S13	25	29	33	35
		80	95	110	115
Stainless steel and S-materials	H5	36	44	50	55
		120	145	165	180
Non ferrous	H8	39	46	55	55
		130	150	180	180
Hard	H11	46	55	65	65
		150	180	215	215
Plastic and cfrp	H12	75	90	100	110
		245	295	330	360
Graphite	H21	39	46	55	55
		130	150	180	180

MP12 Slot and Side milling – Insert selection – Metric / Inch

SMG		a _p	f _z			
			100%	30%	10%	5%
P1	MP12-12008R04Z3-M04 MP3000	4,0	0,055	0,060	0,095	0,13
		0.16	0.0022	0.0024	0.0038	0.0050
P2	MP12-12008R04Z3-M04 MP3000	4,0	0,055	0,065	0,095	0,13
		0.16	0.0022	0.0026	0.0038	0.0050
P3	MP12-12008R04Z3-M04 MP3000	4,0	0,055	0,060	0,090	0,13
		0.16	0.0022	0.0024	0.0036	0.0050
P4	MP12-12008R04Z3-M04 MP3000	4,0	0,055	0,060	0,090	0,12
		0.16	0.0022	0.0024	0.0036	0.0048
P5	MP12-12008R04Z3-M04 MP3000	4,0	0,050	0,055	0,090	0,12
		0.16	0.0020	0.0022	0.0036	0.0048
P6	MP12-12008R04Z3-M04 MP3000	4,0	0,050	0,055	0,085	0,12
		0.16	0.0020	0.0022	0.0034	0.0048
P7	MP12-12008R04Z3-M04 MP3000	4,0	0,050	0,055	0,085	0,12
		0.16	0.0020	0.0022	0.0034	0.0048
P8	MP12-12008R04Z3-M04 MP3000	4,0	0,055	0,060	0,090	0,13
		0.16	0.0022	0.0024	0.0036	0.0050
P11	MP12-12008R04Z3-M04 MP3000	4,0	0,050	0,055	0,085	0,12
		0.16	0.0020	0.0022	0.0034	0.0048
P12	MP12-12008R08Z3-M04 MP3000	3,0	0,036	0,040	0,060	0,085
		0.12	0.0014	0.0016	0.0024	0.0034
M1	MP12-12008R04Z3-E04 F40M	4,0	0,055	0,065	0,095	0,13
		0.16	0.0022	0.0026	0.0038	0.0050
M2	MP12-12008R04Z3-E04 F40M	4,0	0,050	0,055	0,090	0,12
		0.16	0.0020	0.0022	0.0036	0.0048
M3	MP12-12008R04Z3-E04 F40M	3,0	0,042	0,046	0,070	0,095
		0.12	0.0017	0.0018	0.0028	0.0038
M4	MP12-12008R04Z3-E04 F40M	2,5	0,036	0,040	0,060	0,085
		0.10	0.0014	0.0016	0.0024	0.0034
M5	MP12-12008R04Z3-E04 F40M	2,5	0,036	0,040	0,060	0,085
		0.10	0.0014	0.0016	0.0024	0.0034
K1	MP12-12008R04Z3-M04 MP3000	4,0	0,055	0,065	0,095	0,13
		0.16	0.0022	0.0026	0.0038	0.0050
K2	MP12-12008R04Z3-M04 MP3000	4,0	0,050	0,055	0,090	0,12
		0.16	0.0020	0.0022	0.0036	0.0048
K3	MP12-12008R04Z3-M04 MP3000	4,0	0,050	0,055	0,090	0,12
		0.16	0.0020	0.0022	0.0036	0.0048
K4	MP12-12008R04Z3-M04 MP3000	4,0	0,050	0,055	0,090	0,12
		0.16	0.0020	0.0022	0.0036	0.0048
K5	MP12-12008R04Z3-M04 MP3000	4,0	0,048	0,050	0,080	0,11
		0.16	0.0019	0.0020	0.0032	0.0044
K6	MP12-12008R04Z3-M04 MP3000	4,0	0,050	0,055	0,090	0,12
		0.16	0.0020	0.0022	0.0036	0.0048
K7	MP12-12008R04Z3-M04 MP3000	4,0	0,048	0,050	0,080	0,11
		0.16	0.0019	0.0020	0.0032	0.0044
N1	MP12-12008R04Z3-E04 F40M	4,0	0,075	0,080	0,12	0,17
		0.16	0.0030	0.0032	0.0048	0.0065
N2	MP12-12008R04Z3-E04 F40M	4,0	0,075	0,080	0,12	0,17
		0.16	0.0030	0.0032	0.0048	0.0065
N3	MP12-12008R04Z3-E04 F40M	4,0	0,075	0,080	0,12	0,17
		0.16	0.0030	0.0032	0.0048	0.0065
N11	MP12-12008R04Z3-E04 F40M	4,0	0,075	0,080	0,12	0,17
		0.16	0.0030	0.0032	0.0048	0.0065
S1	MP12-12008R04Z3-E04 F40M	2,5	0,036	0,040	0,060	0,085
		0.10	0.0014	0.0016	0.0024	0.0034
S2	MP12-12008R04Z3-E04 F40M	2,5	0,036	0,040	0,060	0,085
		0.10	0.0014	0.0016	0.0024	0.0034
S3	MP12-12008R04Z3-E04 F40M	2,5	0,034	0,038	0,055	0,080
		0.10	0.0013	0.0015	0.0022	0.0032
S11	MP12-12008R04Z3-E04 F40M	2,5	0,042	0,046	0,070	0,095
		0.10	0.0017	0.0018	0.0028	0.0038
S12	MP12-12008R04Z3-E04 F40M	2,5	0,042	0,046	0,070	0,095
		0.10	0.0017	0.0018	0.0028	0.0038
S13	MP12-12008R04Z3-E04 F40M	2,5	0,036	0,040	0,060	0,085
		0.10	0.0014	0.0016	0.0024	0.0034
H5	MP12-12008R04Z3-M04 MP3000	3,0	0,036	0,038	0,060	0,080
		0.12	0.0014	0.0015	0.0024	0.0032
H8	MP12-12008R04Z3-M04 MP3000	2,5	0,028	0,030	0,046	0,065
		0.10	0.0011	0.0012	0.0018	0.0026
H11	MP12-12008R04Z3-M04 MP3000	3,0	0,036	0,038	0,060	0,080
		0.12	0.0014	0.0015	0.0024	0.0032
H12	MP12-12008R04Z3-M04 MP3000	2,5	0,028	0,030	0,046	0,065
		0.10	0.0011	0.0012	0.0018	0.0026
H21	MP12-12008R04Z3-M04 MP3000	2,5	0,028	0,030	0,046	0,065
		0.10	0.0011	0.0012	0.0018	0.0026

SMG = Seco material group
 f_z = mm/tooth (in/tooth), v_c = m/min (sf/min), a_p/DC = %
 All cutting data are start values

Universal
 Steel and cast iron
 Stainless steel and S-materials
 Stainless steel and S-materials
 Non ferrous
 Hard
 Graphite
 X-Heads
 Minimaster Plus
 Minimaster

MP12 Slot and Side milling – Cutting data $v_c = (m/min)/(sf/min)$

SMG	MP3000				F40M			
	100%	30%	10%	5%	100%	30%	10%	5%
P1	250	325	380	415	235	310	360	390
	820	1075	1250	1350	770	1025	1175	1275
P2	240	315	370	405	225	295	350	380
	790	1025	1225	1325	740	970	1150	1250
P3	210	275	320	345	200	260	305	325
	690	900	1050	1125	660	850	1000	1075
P4	185	240	285	310	175	230	270	295
	610	790	940	1025	570	750	890	970
P5	180	235	275	295	170	220	260	280
	590	770	900	970	560	720	850	920
P6	200	265	310	330	190	250	290	315
	660	870	1025	1075	620	820	950	1025
P7	190	250	290	315	180	235	275	295
	620	820	950	1025	590	770	900	970
P8	175	230	270	290	165	215	255	275
	570	750	890	950	540	710	840	900
P11	185	240	280	305	175	230	265	290
	610	790	920	1000	570	750	870	950
P12	115	150	175	195	110	145	165	180
	375	490	570	640	360	475	540	590
M1	180	235	275	300	180	240	280	305
	590	770	900	980	590	790	920	1000
M2	150	195	230	245	150	200	235	250
	490	640	750	800	490	660	770	820
M3	120	155	180	195	120	155	185	200
	395	510	590	640	395	510	610	660
M4	90	120	140	150	95	120	140	155
	295	395	460	490	310	395	460	510
M5	75	100	115	125	75	100	120	125
	245	330	375	410	245	330	395	410
K1	190	250	295	320	180	235	275	300
	620	820	970	1050	590	770	900	980
K2	170	220	260	280	160	210	245	265
	560	720	850	920	520	690	800	870
K3	145	190	220	240	135	180	210	225
	475	620	720	790	445	590	690	740
K4	140	180	210	225	130	170	200	215
	460	590	690	740	425	560	660	710
K5	85	110	125	135	80	105	120	130
	280	360	410	445	260	345	395	425
K6	120	160	185	200	115	150	175	190
	395	520	610	660	375	490	570	620
K7	105	140	160	175	100	130	155	165
	345	460	520	570	330	425	510	540
N1	1425	1875	2200	2375	1350	1775	2100	2250
	4675	6150	7225	7800	4425	5825	6900	7375
N2	570	760	890	960	540	720	840	910
	1875	2500	2925	3150	1775	2350	2750	2975
N3	385	500	600	640	360	475	560	610
	1275	1650	1975	2100	1175	1550	1825	2000
N11	440	580	680	730	415	540	640	690
	1450	1900	2225	2400	1350	1775	2100	2275
S1	43	55	65	70	43	55	65	70
	140	180	215	230	140	180	215	230
S2	34	45	50	55	35	46	55	55
	110	150	165	180	115	150	180	180
S3	30	39	46	49	31	40	46	50
	100	130	150	160	100	130	150	165
S11	60	80	90	100	60	80	95	100
	195	260	295	330	195	260	310	330
S12	42	55	65	70	42	55	65	70
	140	180	215	230	140	180	215	230
S13	24	31	36	39	24	32	37	40
	80	100	120	130	80	105	120	130
H5	36	47	55	60	36	48	55	60
	120	155	180	195	120	155	180	195
H8	38	49	55	60	38	50	60	60
	125	160	180	195	125	165	195	195
H11	46	60	70	75	46	60	70	75
	150	195	230	245	150	195	230	245
H12	70	95	110	120	70	90	105	110
	230	310	360	395	230	295	345	360
H21	38	49	55	60	38	50	60	60
	125	160	180	195	125	165	195	195

MP12 Copy milling – Insert selection – Metric / Inch

SMG		a _p	f _z				
			100%	30%	10%	5%	2%
P1	MP12-12008B90Z3-M04 MP3000	4,0	0,065	0,065	0,10	0,14	0,22
		0.16	0.0026	0.0026	0.0040	0.0055	0.0085
P2	MP12-12008B90Z3-M04 MP3000	4,0	0,065	0,070	0,10	0,14	0,22
		0.16	0.0026	0.0028	0.0040	0.0055	0.0085
P3	MP12-12008B90Z3-M04 MP3000	4,0	0,060	0,065	0,095	0,13	0,22
		0.16	0.0024	0.0026	0.0038	0.0050	0.0085
P4	MP12-12008B90Z3-M04 MP3000	4,0	0,060	0,065	0,095	0,13	0,22
		0.16	0.0024	0.0026	0.0038	0.0050	0.0085
P5	MP12-12008B90Z3-M04 MP3000	4,0	0,060	0,060	0,090	0,13	0,20
		0.16	0.0024	0.0024	0.0036	0.0050	0.0080
P6	MP12-12008B90Z3-M04 MP3000	4,0	0,060	0,060	0,090	0,13	0,20
		0.16	0.0024	0.0024	0.0036	0.0050	0.0080
P7	MP12-12008B90Z3-M04 MP3000	4,0	0,060	0,060	0,090	0,13	0,20
		0.16	0.0024	0.0024	0.0036	0.0050	0.0080
P8	MP12-12008B90Z3-M04 MP3000	4,0	0,060	0,065	0,095	0,13	0,22
		0.16	0.0024	0.0026	0.0038	0.0050	0.0085
P11	MP12-12008B90Z3-M04 MP3000	4,0	0,060	0,060	0,090	0,13	0,20
		0.16	0.0024	0.0024	0.0036	0.0050	0.0080
P12	MP12-12008B90Z3-M04 MP3000	3,0	0,044	0,044	0,060	0,085	0,14
		0.12	0.0017	0.0017	0.0024	0.0034	0.0055
M1	MP12-12008B90Z3-E04 F40M	4,0	0,065	0,070	0,10	0,14	0,22
		0.16	0.0026	0.0028	0.0040	0.0055	0.0085
M2	MP12-12008B90Z3-E04 F40M	4,0	0,060	0,060	0,090	0,13	0,20
		0.16	0.0024	0.0024	0.0036	0.0050	0.0080
M3	MP12-12008B90Z3-E04 F40M	3,0	0,050	0,050	0,075	0,10	0,16
		0.12	0.0020	0.0020	0.0030	0.0040	0.0065
M4	MP12-12008B90Z3-E04 F40M	2,5	0,046	0,046	0,065	0,090	0,14
		0.10	0.0018	0.0018	0.0026	0.0036	0.0055
M5	MP12-12008B90Z3-E04 F40M	2,5	0,046	0,046	0,065	0,090	0,14
		0.10	0.0018	0.0018	0.0026	0.0036	0.0055
K1	MP12-12008B90Z3-M04 MP3000	4,0	0,065	0,070	0,10	0,14	0,22
		0.16	0.0026	0.0028	0.0040	0.0055	0.0085
K2	MP12-12008B90Z3-M04 MP3000	4,0	0,060	0,060	0,090	0,13	0,20
		0.16	0.0024	0.0024	0.0036	0.0050	0.0080
K3	MP12-12008B90Z3-M04 MP3000	4,0	0,060	0,060	0,090	0,13	0,20
		0.16	0.0024	0.0024	0.0036	0.0050	0.0080
K4	MP12-12008B90Z3-M04 MP3000	4,0	0,060	0,060	0,090	0,13	0,20
		0.16	0.0024	0.0024	0.0036	0.0050	0.0080
K5	MP12-12008B90Z3-M04 MP3000	4,0	0,055	0,055	0,085	0,11	0,18
		0.16	0.0022	0.0022	0.0034	0.0044	0.0070
K6	MP12-12008B90Z3-M04 MP3000	4,0	0,060	0,060	0,090	0,13	0,20
		0.16	0.0024	0.0024	0.0036	0.0050	0.0080
K7	MP12-12008B90Z3-M04 MP3000	4,0	0,055	0,055	0,085	0,11	0,18
		0.16	0.0022	0.0022	0.0034	0.0044	0.0070
N1	MP12-12008B90Z3-E04 F40M	4,0	0,085	0,085	0,13	0,18	0,30
		0.16	0.0034	0.0034	0.0050	0.0070	0.012
N2	MP12-12008B90Z3-E04 F40M	4,0	0,085	0,085	0,13	0,18	0,30
		0.16	0.0034	0.0034	0.0050	0.0070	0.012
N3	MP12-12008B90Z3-E04 F40M	4,0	0,085	0,085	0,13	0,18	0,30
		0.16	0.0034	0.0034	0.0050	0.0070	0.012
N11	MP12-12008B90Z3-E04 F40M	4,0	0,085	0,085	0,13	0,18	0,30
		0.16	0.0034	0.0034	0.0050	0.0070	0.012
S1	MP12-12008B90Z3-E04 F40M	2,5	0,046	0,046	0,065	0,090	0,14
		0.10	0.0018	0.0018	0.0026	0.0036	0.0055
S2	MP12-12008B90Z3-E04 F40M	2,5	0,046	0,046	0,065	0,090	0,14
		0.10	0.0018	0.0018	0.0026	0.0036	0.0055
S3	MP12-12008B90Z3-E04 F40M	2,5	0,042	0,044	0,060	0,080	0,13
		0.10	0.0017	0.0017	0.0024	0.0032	0.0050
S11	MP12-12008B90Z3-E04 F40M	2,5	0,055	0,050	0,075	0,10	0,16
		0.10	0.0022	0.0020	0.0030	0.0040	0.0065
S12	MP12-12008B90Z3-E04 F40M	2,5	0,055	0,050	0,075	0,10	0,16
		0.10	0.0022	0.0020	0.0030	0.0040	0.0065
S13	MP12-12008B90Z3-E04 F40M	2,5	0,046	0,046	0,065	0,090	0,14
		0.10	0.0018	0.0018	0.0026	0.0036	0.0055
H5	MP12-12008B90Z3-M04 MP3000	3,0	0,044	0,044	0,060	0,085	0,14
		0.12	0.0017	0.0017	0.0024	0.0034	0.0055
H8	MP12-12008B90Z3-M04 MP3000	2,5	0,034	0,034	0,048	0,065	0,10
		0.10	0.0013	0.0013	0.0019	0.0026	0.0040
H11	MP12-12008B90Z3-M04 MP3000	3,0	0,044	0,044	0,060	0,085	0,14
		0.12	0.0017	0.0017	0.0024	0.0034	0.0055
H12	MP12-12008B90Z3-M04 MP3000	2,5	0,034	0,034	0,048	0,065	0,10
		0.10	0.0013	0.0013	0.0019	0.0026	0.0040
H21	MP12-12008B90Z3-M04 MP3000	2,5	0,034	0,034	0,048	0,065	0,10
		0.10	0.0013	0.0013	0.0019	0.0026	0.0040

SMG = Seco material group
f_z = mm/tooth (in/tooth), v_c = m/min (sf/min), a_p/DC = %
All cutting data are start values

Universal
Steel and cast iron
Stainless steel and S-materials
Stainless steel and S-materials
Non ferrous
Hard
Graphite
X-Heads
Minimaster Plus
Minimaster

MP12 Copy milling – Cutting data $v_c = (m/min)/(sf/min)$

SMG	MP3000					F40M				
	100%	30%	10%	5%	2%	100%	30%	10%	5%	2%
P1	265	320	345	375	370	250	300	325	355	350
	870	1050	1125	1225	1225	820	980	1075	1175	1150
P2	255	310	330	360	360	240	295	315	340	340
	840	1025	1075	1175	1175	790	970	1025	1125	1125
P3	220	265	290	315	315	210	255	270	295	295
	720	870	950	1025	1025	690	840	890	970	970
P4	195	240	255	275	275	185	225	240	260	260
	640	790	840	900	900	610	740	790	850	850
P5	190	230	245	265	265	175	215	230	250	250
	620	750	800	870	870	570	710	750	820	820
P6	210	255	275	300	295	200	240	260	285	280
	690	840	900	980	970	660	790	850	940	920
P7	200	240	260	285	280	190	230	245	265	265
	660	790	850	940	920	620	750	800	870	870
P8	185	225	240	265	265	175	210	230	250	250
	610	740	790	870	870	570	690	750	820	820
P11	195	235	250	275	270	185	220	240	260	255
	640	770	820	900	890	610	720	790	850	840
P12	120	150	160	170	170	115	140	150	160	160
	395	490	520	560	560	375	460	490	520	520
M1	190	230	250	270	270	190	235	255	275	275
	620	750	820	890	890	620	770	840	900	900
M2	155	190	205	225	220	160	195	210	225	225
	510	620	670	740	720	520	640	690	740	740
M3	125	155	160	175	175	130	155	165	180	175
	410	510	520	570	570	425	510	540	590	570
M4	100	120	125	135	135	100	120	125	135	135
	330	395	410	445	445	330	395	410	445	445
M5	85	100	105	110	110	85	100	105	115	115
	280	330	345	360	360	280	330	345	375	375
K1	200	245	265	285	285	190	235	250	270	270
	660	800	870	940	940	620	770	820	890	890
K2	180	215	230	255	250	170	205	220	240	235
	590	710	750	840	820	560	670	720	790	770
K3	150	185	195	215	210	140	175	185	200	200
	490	610	640	710	690	460	570	610	660	660
K4	145	175	185	205	205	135	165	175	195	190
	475	570	610	670	670	445	540	570	640	620
K5	85	105	115	125	125	80	100	105	115	115
	280	345	375	410	410	260	330	345	375	375
K6	125	155	165	180	180	120	145	155	170	170
	410	510	540	590	590	395	475	510	560	560
K7	110	135	145	160	155	105	130	135	150	150
	360	445	475	520	510	345	425	445	490	490
N1	1525	1850	1975	2150	2150	1450	1750	1875	2025	2025
	5000	6075	6475	7050	7050	4750	5750	6150	6650	6650
N2	620	750	800	870	870	580	710	760	820	820
	2025	2450	2625	2850	2850	1900	2325	2500	2700	2700
N3	410	500	530	580	580	390	470	500	550	550
	1350	1650	1750	1900	1900	1275	1550	1650	1800	1800
N11	470	570	610	660	660	445	540	580	620	630
	1550	1875	2000	2175	2175	1450	1775	1900	2025	2075
S1	46	55	60	65	60	47	55	60	65	65
	150	180	195	215	195	155	180	195	215	215
S2	37	45	47	50	50	38	45	47	50	50
	120	150	155	165	165	125	150	155	165	165
S3	32	39	40	44	44	33	40	41	45	44
	105	130	130	145	145	110	130	135	150	145
S11	65	80	80	90	90	65	80	85	90	90
	215	260	260	295	295	215	260	280	295	295
S12	44	55	55	60	60	45	55	60	60	60
	145	180	180	195	195	150	180	195	195	195
S13	26	31	33	35	35	27	32	33	36	36
	85	100	110	115	115	90	105	110	120	120
H5	38	47	49	55	55	38	47	49	55	55
	125	155	160	180	180	125	155	160	180	180
H8	40	48	50	55	55	40	49	50	55	55
	130	155	165	180	180	130	160	165	180	180
H11	48	60	60	65	70	49	60	65	70	70
	155	195	195	215	230	160	195	215	230	230
H12	75	95	95	105	105	70	85	90	100	100
	245	310	310	345	345	230	280	295	330	330
H21	40	48	50	55	55	40	49	50	55	55
	130	155	165	180	180	130	160	165	180	180

MP12 Centre drilling – Insert selection – Metric / Inch

SMG		f_z	a_{so}
			100%
P1	MP12-12007C90Z2-M04 F40M	0,055 0,0022	3,5 0,14
P2	MP12-12007C90Z2-M04 F40M	0,055 0,0022	3,5 0,14
P3	MP12-12007C90Z2-M04 F40M	0,055 0,0022	3,5 0,14
P4	MP12-12007C90Z2-M04 F40M	0,055 0,0022	3,5 0,14
P5	MP12-12007C90Z2-M04 F40M	0,050 0,0020	3,5 0,14
P6	MP12-12007C90Z2-M04 F40M	0,050 0,0020	3,5 0,14
P7	MP12-12007C90Z2-M04 F40M	0,050 0,0020	3,5 0,14
P8	MP12-12007C90Z2-M04 F40M	0,055 0,0022	3,5 0,14
P11	MP12-12007C90Z2-M04 F40M	0,050 0,0020	3,5 0,14
P12	MP12-12007C90Z2-M04 F40M	0,036 0,0014	2,5 0,10
M1	MP12-12007C90Z2-M04 F40M	0,055 0,0022	3,5 0,14
M2	MP12-12007C90Z2-M04 F40M	0,050 0,0020	3,5 0,14
M3	MP12-12007C90Z2-M04 F40M	0,042 0,0017	2,5 0,10
M4	MP12-12007C90Z2-M04 F40M	0,036 0,0014	2,0 0,080
M5	MP12-12007C90Z2-M04 F40M	0,036 0,0014	2,0 0,080
K1	MP12-12007C90Z2-M04 F40M	0,055 0,0022	3,5 0,14
K2	MP12-12007C90Z2-M04 F40M	0,050 0,0020	3,5 0,14
K3	MP12-12007C90Z2-M04 F40M	0,050 0,0020	3,5 0,14
K4	MP12-12007C90Z2-M04 F40M	0,050 0,0020	3,5 0,14
K5	MP12-12007C90Z2-M04 F40M	0,046 0,0018	3,5 0,14
K6	MP12-12007C90Z2-M04 F40M	0,050 0,0020	3,5 0,14
K7	MP12-12007C90Z2-M04 F40M	0,046 0,0018	3,5 0,14
N1	MP12-12007C90Z2-M04 F40M	0,075 0,0030	3,5 0,14
N2	MP12-12007C90Z2-M04 F40M	0,075 0,0030	3,5 0,14
N3	MP12-12007C90Z2-M04 F40M	0,075 0,0030	3,5 0,14
N11	MP12-12007C90Z2-M04 F40M	0,075 0,0030	3,5 0,14
S1	MP12-12007C90Z2-M04 F40M	0,036 0,0014	2,0 0,080
S2	MP12-12007C90Z2-M04 F40M	0,036 0,0014	2,0 0,080
S3	MP12-12007C90Z2-M04 F40M	0,034 0,0013	2,0 0,080
S11	MP12-12007C90Z2-M04 F40M	0,042 0,0017	2,5 0,10
S12	MP12-12007C90Z2-M04 F40M	0,042 0,0017	2,5 0,10
S13	MP12-12007C90Z2-M04 F40M	0,036 0,0014	2,0 0,080
H5	MP12-12007C90Z2-M04 F40M	0,036 0,0014	2,5 0,10
H8	MP12-12007C90Z2-M04 F40M	0,028 0,0011	2,5 0,10
H11	MP12-12007C90Z2-M04 F40M	0,036 0,0014	2,5 0,10
H12	MP12-12007C90Z2-M04 F40M	0,028 0,0011	2,5 0,10
H21	MP12-12007C90Z2-M04 F40M	0,028 0,0011	2,5 0,10

SMG = Seco material group
 f_z = mm/tooth (in/tooth), v_c = m/min (sf/min), a_g/DC = %
 All cutting data are start values

Universal
 Steel and cast iron
 Stainless steel and S-materials
 Stainless steel and S-materials
 Non ferrous
 Hard
 Graphite
 X-Heads
 Minimaster Plus
 Minimaster

MP12 Centre drilling – Cutting data $v_c = (m/min)/(sf/min)$

	Universal		
	SMG	F40M	
Steel and cast iron	P1	100% 275 900	
	P2	265 870	
	P3	235 770	
	P4	205 670	
	P5	195 640	
	P6	220 720	
	Stainless steel and S-materials	P7	205 670
		P8	195 640
		P11	200 660
		P12	125 410
	Non ferrous	M1	215 710
		M2	175 570
M3		140 460	
M4		105 345	
M5		85 280	
Hard	K1	210 690	
	K2	185 610	
	K3	155 510	
	K4	150 490	
	K5	90 295	
	K6	130 425	
	K7	120 395	
Graphite	N1	1575 5175	
	N2	640	
	N3	2100 425 1400	
	N11	490 1600	
X-Heads	S1	49 160	
	S2	39 130	
	S3	34 110	
	S11	70 230	
	Minimaster Plus	S12	48 155
		S13	27 90
H5		42 140	
H8		43 140	
Minimaster		H11	55 180
	H12	80 260	
	H21	43 140	

MP12 Chamfering – Insert selection – Metric / Inch

SMG		a _p	f _z				
			100%	50%	30%	20%	10%
P1	MP12-12007C90Z2-M04 F40M	2,5	0,080	0,080	0,080	0,080	0,10
		0,10	0,0032	0,0032	0,0032	0,0032	0,0040
P2	MP12-12007C90Z2-M04 F40M	2,5	0,080	0,080	0,080	0,080	0,10
		0,10	0,0032	0,0032	0,0032	0,0032	0,0040
P3	MP12-12007C90Z2-M04 F40M	2,5	0,075	0,075	0,075	0,075	0,095
		0,10	0,0030	0,0030	0,0030	0,0030	0,0038
P4	MP12-12007C90Z2-M04 F40M	2,5	0,075	0,075	0,075	0,075	0,095
		0,10	0,0030	0,0030	0,0030	0,0030	0,0038
P5	MP12-12007C90Z2-M04 F40M	2,5	0,075	0,075	0,075	0,075	0,090
		0,10	0,0030	0,0030	0,0030	0,0030	0,0036
P6	MP12-12007C90Z2-M04 F40M	2,5	0,075	0,075	0,075	0,075	0,090
		0,10	0,0030	0,0030	0,0030	0,0030	0,0036
P7	MP12-12007C90Z2-M04 F40M	2,5	0,075	0,075	0,075	0,075	0,090
		0,10	0,0030	0,0030	0,0030	0,0030	0,0036
P8	MP12-12007C90Z2-M04 F40M	2,5	0,075	0,075	0,075	0,075	0,095
		0,10	0,0030	0,0030	0,0030	0,0030	0,0038
P11	MP12-12007C90Z2-M04 F40M	2,5	0,075	0,075	0,075	0,075	0,090
		0,10	0,0030	0,0030	0,0030	0,0030	0,0036
P12	MP12-12007C90Z2-M04 F40M	2,0	0,050	0,050	0,050	0,050	0,060
		0,080	0,0020	0,0020	0,0020	0,0020	0,0024
M1	MP12-12007C90Z2-M04 F40M	2,5	0,080	0,080	0,080	0,080	0,10
		0,10	0,0032	0,0032	0,0032	0,0032	0,0040
M2	MP12-12007C90Z2-M04 F40M	2,5	0,075	0,075	0,075	0,075	0,090
		0,10	0,0030	0,0030	0,0030	0,0030	0,0036
M3	MP12-12007C90Z2-M04 F40M	2,0	0,060	0,060	0,060	0,060	0,075
		0,080	0,0024	0,0024	0,0024	0,0024	0,0030
M4	MP12-12007C90Z2-M04 F40M	1,6	0,050	0,050	0,050	0,050	0,065
		0,065	0,0020	0,0020	0,0020	0,0020	0,0026
M5	MP12-12007C90Z2-M04 F40M	1,6	0,050	0,050	0,050	0,050	0,065
		0,065	0,0020	0,0020	0,0020	0,0020	0,0026
K1	MP12-12007C90Z2-M04 F40M	2,5	0,080	0,080	0,080	0,080	0,10
		0,10	0,0032	0,0032	0,0032	0,0032	0,0040
K2	MP12-12007C90Z2-M04 F40M	2,5	0,075	0,075	0,075	0,075	0,090
		0,10	0,0030	0,0030	0,0030	0,0030	0,0036
K3	MP12-12007C90Z2-M04 F40M	2,5	0,075	0,075	0,075	0,075	0,090
		0,10	0,0030	0,0030	0,0030	0,0030	0,0036
K4	MP12-12007C90Z2-M04 F40M	2,5	0,075	0,075	0,075	0,075	0,090
		0,10	0,0030	0,0030	0,0030	0,0030	0,0036
K5	MP12-12007C90Z2-M04 F40M	2,5	0,065	0,065	0,065	0,065	0,085
		0,10	0,0026	0,0026	0,0026	0,0026	0,0034
K6	MP12-12007C90Z2-M04 F40M	2,5	0,075	0,075	0,075	0,075	0,090
		0,10	0,0030	0,0030	0,0030	0,0030	0,0036
K7	MP12-12007C90Z2-M04 F40M	2,5	0,065	0,065	0,065	0,065	0,085
		0,10	0,0026	0,0026	0,0026	0,0026	0,0034
N1	MP12-12007C90Z2-M04 F40M	2,5	0,10	0,10	0,10	0,10	0,13
		0,10	0,0040	0,0040	0,0040	0,0040	0,0050
N2	MP12-12007C90Z2-M04 F40M	2,5	0,10	0,10	0,10	0,10	0,13
		0,10	0,0040	0,0040	0,0040	0,0040	0,0050
N3	MP12-12007C90Z2-M04 F40M	2,5	0,10	0,10	0,10	0,10	0,13
		0,10	0,0040	0,0040	0,0040	0,0040	0,0050
N11	MP12-12007C90Z2-M04 F40M	2,5	0,10	0,10	0,10	0,10	0,13
		0,10	0,0040	0,0040	0,0040	0,0040	0,0050
S1	MP12-12007C90Z2-M04 F40M	1,6	0,050	0,050	0,050	0,050	0,065
		0,065	0,0020	0,0020	0,0020	0,0020	0,0026
S2	MP12-12007C90Z2-M04 F40M	1,6	0,050	0,050	0,050	0,050	0,065
		0,065	0,0020	0,0020	0,0020	0,0020	0,0026
S3	MP12-12007C90Z2-M04 F40M	1,6	0,048	0,048	0,048	0,048	0,060
		0,065	0,0019	0,0019	0,0019	0,0019	0,0024
S11	MP12-12007C90Z2-M04 F40M	1,9	0,060	0,060	0,060	0,060	0,075
		0,075	0,0024	0,0024	0,0024	0,0024	0,0030
S12	MP12-12007C90Z2-M04 F40M	1,9	0,060	0,060	0,060	0,060	0,075
		0,075	0,0024	0,0024	0,0024	0,0024	0,0030
S13	MP12-12007C90Z2-M04 F40M	1,6	0,050	0,050	0,050	0,050	0,065
		0,065	0,0020	0,0020	0,0020	0,0020	0,0026
H5	MP12-12007C90Z2-M04 F40M	2,0	0,050	0,050	0,050	0,050	0,060
		0,080	0,0020	0,0020	0,0020	0,0020	0,0024
H8	MP12-12007C90Z2-M04 F40M	1,9	0,038	0,038	0,038	0,038	0,048
		0,075	0,0015	0,0015	0,0015	0,0015	0,0019
H11	MP12-12007C90Z2-M04 F40M	2,0	0,050	0,050	0,050	0,050	0,060
		0,080	0,0020	0,0020	0,0020	0,0020	0,0024
H12	MP12-12007C90Z2-M04 F40M	1,9	0,038	0,038	0,038	0,038	0,048
		0,075	0,0015	0,0015	0,0015	0,0015	0,0019
H21	MP12-12007C90Z2-M04 F40M	1,9	0,038	0,038	0,038	0,038	0,048
		0,075	0,0015	0,0015	0,0015	0,0015	0,0019

SMG = Seco material group
f_z = mm/tooth (in/tooth), v_c = m/min (sf/min), a_p/DC = %
All cutting data are start values

Universal
Steel and cast iron
Stainless steel and S-materials
Stainless steel and S-materials
Non ferrous
Hard
Graphite
X-Heads
Minimaster Plus
Minimaster

MP12 Chamfering – Cutting data $v_c = (m/min)/(sf/min)$

	SMG		F40M			
	100%	50%	30%	20%	10%	
Universal	P1	300	275	330	365	430
		980	900	1075	1200	1400
Steel and cast iron	P2	290	270	320	355	415
		950	890	1050	1175	1350
Stainless steel and S-materials	P3	255	235	280	310	360
		840	770	920	1025	1175
	P4	225	210	250	275	320
		740	690	820	900	1050
	P5	215	200	235	260	310
		710	660	770	850	1025
	P6	240	225	265	295	345
		790	740	870	970	1125
	P7	225	210	250	275	325
		740	690	820	900	1075
	P8	215	200	235	260	305
		710	660	770	850	1000
	P11	220	205	245	270	320
		720	670	800	890	1050
	P12	140	125	150	165	205
		460	410	490	540	670
Non ferrous	M1	235	220	260	285	335
		770	720	850	940	1100
	M2	190	180	215	235	280
		620	590	710	770	920
	M3	150	135	165	180	220
		490	445	540	590	720
	M4	115	100	115	130	170
		375	330	375	425	560
	M5	95	85	95	110	140
		310	280	310	360	460
Hard	K1	230	215	255	280	330
		750	710	840	920	1075
	K2	200	190	225	250	295
		660	620	740	820	970
	K3	170	160	190	210	250
		560	520	620	690	820
Plastic and cfrp	K4	165	150	180	200	235
		540	490	590	660	770
	K5	100	95	110	125	145
		330	310	360	410	475
	K6	145	135	160	175	210
		475	445	520	570	690
	K7	130	120	145	160	185
		425	395	475	520	610
Graphite	N1	1725	1600	1900	2100	2450
		5650	5250	6225	6900	8050
	N2	690	640	770	850	990
		2275	2100	2525	2800	3250
	N3	460	430	510	570	660
		1500	1400	1675	1875	2175
	N11	530	490	590	650	750
		1750	1600	1925	2125	2450
X-Heads	S1	55	47	55	60	80
		180	155	180	195	260
	S2	44	38	44	50	65
		145	125	145	165	215
	S3	38	33	38	43	55
		125	110	125	140	180
	S11	75	70	80	85	110
		245	230	260	280	360
Minimaster Plus	S12	55	47	55	60	75
		180	155	180	195	245
	S13	30	27	30	35	45
		100	90	100	115	150
	H5	46	42	50	55	70
		150	140	165	180	230
	H8	49	44	50	55	70
		160	145	165	180	230
	H11	60	55	65	70	85
		195	180	215	230	280
Minimaster	H12	85	80	90	100	125
		280	260	295	330	410
	H21	49	44	50	55	70
		160	145	165	180	230

MP16 Shank – Metric

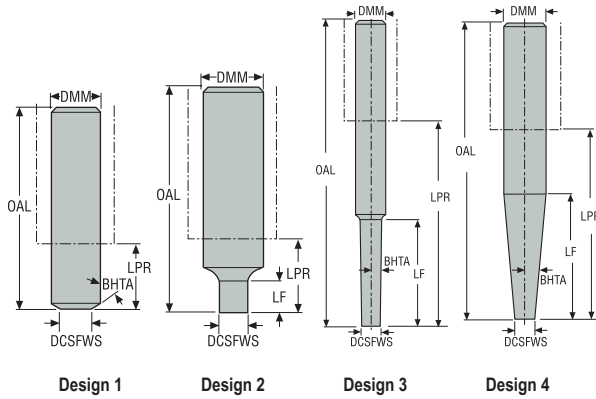

• Cylindrical shank DMM with tolerance h5, compatible for Shrinkfit

Designation	Type of mounting	DCSFWS	DMM	OAL	LPR	LF	RPMX	BHTA°	Design		Weight
		mm	mm	mm	mm	mm					kg
MP16-16068-016.00	Cylindrical	15,2	16,0	68,0	20,0	16,0	63600	0,0	2	✓	0,1
MP16-20070-000.60	Cylindrical	15,2	20,0	70,0	20,0	0,0	63600	60,0	1	✓	0,2
MP16-20090-024.00	Cylindrical	15,2	20,0	90,0	40,0	24,0	63600	0,0	2	✓	0,2
MP16-20190-056.01	Cylindrical	15,2	20,0	190,0	140,0	56,0	63600	1,0	3	✓	0,4
MP16-20195-095.01	Cylindrical	15,2	20,0	195,0	145,0	95,0	63600	1,0	3	✓	0,4
MP16-25136-075.03	Cylindrical	15,2	25,0	136,0	80,0	75,0	63600	3,0	3	✓	0,4
MP16-25181-125.03	Cylindrical	15,2	25,0	181,0	125,0	93,5	63600	3,0	4	✓	0,6
MP16-25181-125.05	Cylindrical	15,2	25,0	181,0	125,0	56,0	63600	5,0	4	✓	0,6
MP16-16126-048.00-E	Cylindrical	15,2	16,0	126,0	78,0	48,0	63600	0,0	2	✓	0,4
MP16-16140-064.00-E	Cylindrical	15,2	16,0	140,0	92,0	64,0	63600	0,0	2	✓	0,4
MP16-16180-096.00-E	Cylindrical	15,2	16,0	180,0	132,0	96,0	63600	0,0	2	✓	0,5
MP16-20135-080.01-E	Cylindrical	15,2	20,0	135,0	85,0	80,0	63600	1,0	3	✓	0,5
MP16-20180-128.01-E	Cylindrical	15,2	20,0	180,0	130,0	128,0	63600	1,0	3	✓	0,7
MP16-20200-150.01-E	Cylindrical	15,2	20,0	200,0	150,0	137,5	63600	1,0	4	✓	0,8
MP16-20180-130.03-E	Cylindrical	15,2	20,0	180,0	130,0	45,8	63600	3,0	4	✓	0,8
MP16-20210-160.03-E	Cylindrical	15,2	20,0	210,0	160,0	45,8	63600	3,0	4	✓	0,9

Accessories

Key	Replacement blade	Torque key
MP1016	MP00-16M	MP00-16.190

Blades are included with the torque key

Universal
Steel and cast iron
Stainless steel and S-materials
Stainless steel and S-materials
Non ferrous
Hard
Graphite
X-Heads
Minimaster Plus
Minimaster

MP16 Shank – Inch

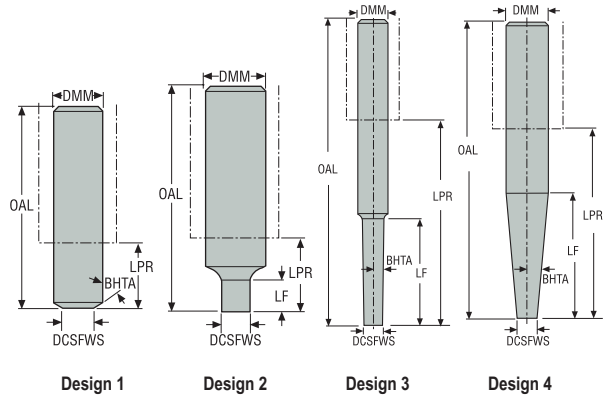

- Cylindrical shank DMM with tolerance h5, compatible for Shrinkfit

Designation	Type of mounting	DCSFWS	DMM	OAL	LPR	LF	RPMX	BHTA°	Design	Weight
		inch	inch	inch	inch	inch				lbs
MP16-0622.6-0.63.00	Cylindrical	0.598	0.625	2.662	0.787	0.630	63600	0,0	2	✓ 0.220
MP16-0752.7-0.00.60	Cylindrical	0.598	0.750	2.787	0.787	0	63600	60,0	1	✓ 1.540
MP16-0753.5-0.94.00	Cylindrical	0.598	0.750	3.575	1.575	0.945	63600	0,0	2	✓ 0.440
MP16-0757.5-2.20.01	Cylindrical	0.598	0.750	7.512	5.512	2.205	63600	1,0	3	✓ 0.880
MP16-0757.7-3.74.01	Cylindrical	0.598	0.750	7.709	5.709	3.740	63600	1,0	3	✓ 0.880
MP16-1007.1-4.92.05	Cylindrical	0.598	1.000	7.171	4.921	2.295	63600	5,0	4	✓ 0.440
MP16-0627.0-3.77.00-E	Cylindrical	0.598	0.625	7.072	5.197	3.780	63600	0,0	2	✓ 1.100
MP16-0757.9-5.90.01-E	Cylindrical	0.598	0.750	7.906	5.906	4.342	63600	1,0	4	✓ 1.540
MP16-0758.2-6.29.03-E	Cylindrical	0.598	0.750	8.299	6.299	1.446	63600	3,0	4	✓ 1.760

Accessories

Key	Replacement blade	Torque key
MP1016	MP00-16M	MP00-16.190

Blades are included with the torque key

MP16 High feed

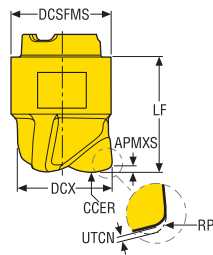

• For insert selection and cutting data recommendations, see page(s) 620-621

Z3



Designation	DCX	DC	APMXS	DCSFMS	CCER	RP	LF	UTCN	RMPX°	C min	C max	ZEFP	Grades	
													MP3000	F40M
	mm Inch	mm Inch	mm Inch	mm Inch	mm Inch	mm Inch	mm Inch	mm Inch						
MP16-1580.9HFZ3-MD12	15,875 0.625	7,88 0.310	0,9 0.035	15,4 0.606	7,8 0.307	1,79 0.070	18,5 0.728	0,46 0.018	5,0	17,2	23,5	3	■	
MP16-1600.9HFZ3-MD12	16,0 0.630	8,0 0.315	0,9 0.035	15,4 0.606	7,8 0.307	1,79 0.070	18,5 0.728	0,46 0.018	5,0	17,3	23,8	3	■	

Universal

Steel and cast iron

Stainless steel and S-materials

Stainless steel and S-materials

Non ferrous

Hard

Graphite

X-Heads

Minimaster Plus

Minimaster

MP16 Square shoulder

Slotting and contouring

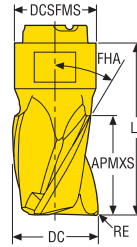

• For insert selection and cutting data recommendations, see page(s) 622-623

Z3



Designation	DC	APMXS	RE	DCSFMS	FHA°	LF	RMPX°	C min	C max	ZEFP	Grades	
											MP3000	F40M
	mm Inch	mm Inch	mm Inch	mm Inch	mm Inch	mm Inch						
MP16-15719KWZ3-E05	15,7 0.618	19,0 0.748	0,3 0.012	15,4 0.606	30 1.181	32,6 1.283	15,0	19,0	29,6	3		■
MP16-15919R04Z3-E05	15,875 0.625	19,0 0.748	0,4 0.016	15,4 0.606	30 1.181	32,6 1.283	15,0	19,3	30,7	3		■
MP16-15919R04Z3-M05	15,875 0.625	19,0 0.748	0,4 0.016	15,4 0.606	30 1.181	32,6 1.283	15,0	19,3	30,7	3	■	
MP16-15919R08Z3-E05	15,875 0.625	19,0 0.748	0,8 0.031	15,4 0.606	30 1.181	32,6 1.283	15,0	19,3	29,9	3		■
MP16-15919R08Z3-M05	15,875 0.625	19,0 0.748	0,8 0.031	15,4 0.606	30 1.181	32,6 1.283	15,0	19,3	29,9	3	■	
MP16-15919R31Z3-E05	15,875 0.625	19,0 0.748	3,1 0.122	15,4 0.606	30 1.181	32,6 1.283	15,0	19,3	25,3	3		■
MP16-16010R04Z3-M05	16,0 0.630	10,0 0.394	0,4 0.016	15,4 0.606	30 1.181	24,6 0.969	15,0	19,4	31,0	3	■	
MP16-16010R05Z3-E05	16,0 0.630	10,0 0.394	0,5 0.020	15,4 0.606	30 1.181	24,6 0.969	15,0	19,4	30,8	3		■
MP16-16010R08Z3-E05	16,0 0.630	10,0 0.394	0,8 0.031	15,4 0.606	30 1.181	24,6 0.969	15,0	19,4	30,0	3		■
MP16-16010R08Z3-M05	16,0 0.630	10,0 0.394	0,8 0.031	15,4 0.606	30 1.181	24,6 0.969	15,0	19,4	30,0	3	■	
MP16-16010R12Z3-E05	16,0 0.630	10,0 0.394	1,2 0.047	15,4 0.606	30 1.181	24,6 0.969	15,0	19,4	29,4	3		■
MP16-16010R20Z3-E05	16,0 0.630	10,0 0.394	2,0 0.079	15,4 0.606	30 1.181	24,6 0.969	15,0	19,4	27,8	3		■
MP16-16010R31Z3-E05	16,0 0.630	10,0 0.394	3,1 0.122	15,4 0.606	30 1.181	24,6 0.969	15,0	19,4	25,6	3		■
MP16-16019R04Z3-M05	16,0 0.630	19,0 0.748	0,4 0.016	15,4 0.606	30 1.181	32,6 1.283	15,0	19,4	31,0	3	■	
MP16-16019R05Z3-E05	16,0 0.630	19,0 0.748	0,5 0.020	15,4 0.606	30 1.181	32,6 1.283	15,0	19,4	30,8	3		■
MP16-16019R08Z3-E05	16,0 0.630	19,0 0.748	0,8 0.031	15,4 0.606	30 1.181	32,6 1.283	15,0	19,4	30,2	3		■
MP16-16019R08Z3-M05	16,0 0.630	19,0 0.748	0,8 0.031	15,4 0.606	30 1.181	32,6 1.283	15,0	19,4	30,2	3	■	
MP16-16019R20Z3-E05	16,0 0.630	19,0 0.748	2,0 0.079	15,4 0.606	30 1.181	32,6 1.283	15,0	19,4	27,8	3		■
MP16-16019R31Z3-E05	16,0 0.630	19,0 0.748	3,1 0.122	15,4 0.606	30 1.181	32,6 1.283	15,0	19,4	25,6	3		■

MP16 Square shoulder

Slotting and contouring

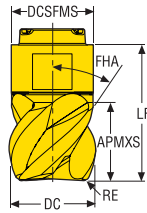

• For insert selection and cutting data recommendations, see page(s) 622-623

Z4



Designation	DC	APMXS	RE	DCSFMS	FHA°	LF	RMPX°	C min	C max	ZEFP	Grades	
											Coated	
	mm Inch	mm Inch	mm Inch	mm Inch	mm Inch	mm Inch					MP3000	F40M
MP16-15919R04Z4-E04	15,875 0.625	19,0 0.748	0,4 0.016	15,4 0.606	50 1.969	32,6 1.283	15,0	19,3	30,7	4		■
MP16-15919R04Z4-M04	15,875 0.625	19,0 0.748	0,4 0.016	15,4 0.606	50 1.969	32,6 1.283	15,0	19,3	30,7	4	■	
MP16-15919R08Z4-E04	15,875 0.625	19,0 0.748	0,8 0.031	15,4 0.606	50 1.969	32,6 1.283	15,0	19,3	29,9	4		■
MP16-15919R08Z4-M04	15,875 0.625	19,0 0.748	0,8 0.031	15,4 0.606	50 1.969	32,6 1.283	15,0	19,3	29,9	4	■	
MP16-16010R04Z4-M04	16,0 0.630	10,0 0.394	0,4 0.016	15,4 0.606	50 1.969	24,6 0.969	15,0	19,4	31,0	4	■	
MP16-16010R05Z4-E04	16,0 0.630	10,0 0.394	0,5 0.020	15,4 0.606	50 1.969	24,6 0.969	15,0	19,4	30,8	4		■
MP16-16010R08Z4-E04	16,0 0.630	10,0 0.394	0,8 0.031	15,4 0.606	50 1.969	24,6 0.969	15,0	19,4	30,2	4		■
MP16-16010R08Z4-M04	16,0 0.630	10,0 0.394	0,8 0.031	15,4 0.606	50 1.969	24,6 0.969	15,0	19,4	30,2	4	■	
MP16-16010R16Z4-M04	16,0 0.630	10,0 0.394	1,6 0.063	15,4 0.606	50 1.969	24,6 0.969	15,0	19,4	28,6	4	■	
MP16-16010R31Z4-E04	16,0 0.630	10,0 0.394	3,1 0.122	15,4 0.606	50 1.969	24,6 0.969	15,0	19,4	25,6	4		■
MP16-16019R04Z4-E04	16,0 0.630	19,0 0.748	0,4 0.016	15,4 0.606	50 1.969	32,6 1.283	15,0	19,4	31,0	4		■
MP16-16019R04Z4-M04	16,0 0.630	19,0 0.748	0,4 0.016	15,4 0.606	50 1.969	32,6 1.283	15,0	19,4	31,0	4	■	
MP16-16019R05Z4-E04	16,0 0.630	19,0 0.748	0,5 0.020	15,4 0.606	50 1.969	32,6 1.283	15,0	19,4	30,8	4		■
MP16-16019R08Z4-E04	16,0 0.630	19,0 0.748	0,8 0.031	15,4 0.606	50 1.969	32,6 1.283	15,0	19,4	30,2	4		■
MP16-16019R08Z4-M04	16,0 0.630	19,0 0.748	0,8 0.031	15,4 0.606	50 1.969	32,6 1.283	15,0	19,4	30,2	4	■	
MP16-16019R16Z4-E04	16,0 0.630	19,0 0.748	1,6 0.063	15,4 0.606	50 1.969	32,6 1.283	15,0	19,4	28,6	4		■
MP16-16019R20Z4-E04	16,0 0.630	19,0 0.748	2,0 0.079	15,4 0.606	50 1.969	32,6 1.283	15,0	19,4	27,8	4		■

Universal

Steel and cast iron

Stainless steel and S-materials

Stainless steel and S-materials

Non ferrous

Hard

Graphite

X-Heads

Minimaster Plus

Minimaster

MP16 Square shoulder

Contouring only

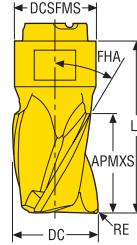

• For insert selection and cutting data recommendations, see page(s) 622-623

Z6/Z8



Designation	DC	APMXS	RE	DCSFMS	LF	FHA°	ZEPF		Grades	
									Coated	
	mm <i>Inch</i>	mm <i>Inch</i>	mm <i>Inch</i>	mm <i>Inch</i>	mm <i>Inch</i>				MP3000	F40M
MP16-15919R04Z6-M04	15,875 0.625	19,0 0.748	0,4 0.016	15,4 0.606	32,6 1.283	40	6		■	
MP16-16019R04Z6-M04	16,0 0.630	19,0 0.748	0,4 0.016	15,4 0.606	32,6 1.283	40	6		■	
MP16-16019R04Z8-M04	16,0 0.630	19,0 0.748	0,4 0.016	15,4 0.606	32,6 1.283	40	8		■	

- Universal
- Steel and cast iron
- Stainless steel and S-materials
- Non ferrous
- Hard
- Plastic and CFRP
- Graphite
- X-Heads
- Minimaster Plus
- Minimaster

MP16 Ball nose design

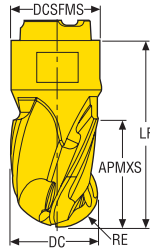

• For insert selection and cutting data recommendations, see page(s) 624-625

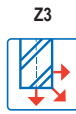

Designation	DC	APMXS	RE	DCSFMS	LF	FHA°	RMPX°	ZEFP	Grades	
									MP3000	F40M
	mm Inch	mm Inch	mm Inch	mm Inch	mm Inch				Coated	
MP16-15910B90Z3-E05	15,875 0.625	10,0 0.394	7,9375 0.313	15,4 0.606	24,6 0.969	30	15,0	3		■
MP16-15910B90Z3-M05	15,875 0.625	10,0 0.394	7,9375 0.313	15,4 0.606	24,6 0.969	30	15,0	3	■	
MP16-15910B90Z4-E04	15,875 0.625	10,0 0.394	7,9375 0.313	15,4 0.606	24,6 0.969	20	15,0	4		■
MP16-15910B90Z4-M04	15,875 0.625	10,0 0.394	7,9375 0.313	15,4 0.606	24,6 0.969	20	15,0	4	■	
MP16-15919B90Z3-E05	15,875 0.625	19,0 0.748	7,9375 0.313	15,4 0.606	32,6 1.283	30	15,0	3		■
MP16-15919B90Z3-M05	15,875 0.625	19,0 0.748	7,9375 0.313	15,4 0.606	32,6 1.283	30	15,0	3	■	
MP16-16010B90Z3-E05	16,0 0.630	10,0 0.394	8,0 0.315	15,4 0.606	24,6 0.969	30	15,0	3		■
MP16-16010B90Z3-M05	16,0 0.630	10,0 0.394	8,0 0.315	15,4 0.606	24,6 0.969	30	15,0	3	■	
MP16-16010B90Z4-E04	16,0 0.630	10,0 0.394	8,0 0.315	15,4 0.606	24,6 0.969	20	15,0	4		■
MP16-16010B90Z4-M04	16,0 0.630	10,0 0.394	8,0 0.315	15,4 0.606	24,6 0.969	20	15,0	4	■	
MP16-16019B90Z3-E05	16,0 0.630	19,0 0.748	8,0 0.315	15,4 0.606	32,6 1.283	30	15,0	3		■
MP16-16019B90Z3-M05	16,0 0.630	19,0 0.748	8,0 0.315	15,4 0.606	32,6 1.283	30	15,0	3	■	

Universal
Steel and cast iron
Stainless steel and S-materials
Stainless steel and S-materials
Non ferrous
Hard
Graphite
X-Heads
Minimaster Plus
Minimaster

MP16 Centre drilling/Chamfering

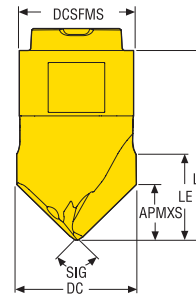

• For insert selection and cutting data recommendations, see page(s) 626-627

Z2



Designation	DC	APMXS	DCSFMS	LE	LF	SIG°	ZEPF		Grades	
									Coated	
	mm Inch	mm Inch	mm Inch	mm Inch	mm Inch				MP3000	F40M
MP16-16009C90Z2-M05	16,0 0.630	7,4 0.291	15,4 0.606	12,0 0.472	26,4 1.039	90,0	2			■

MP16 Chamfering

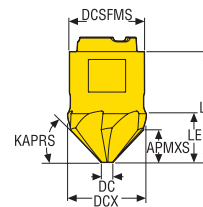

• For insert selection and cutting data recommendations, see page(s) 628-629

Z6



Designation	DCX	DC	APMXS	DCSFMS	LE	LF	KAPRS°	ZEPF		Grades	
										Coated	
	mm Inch	mm Inch	mm Inch	mm Inch	mm Inch	mm Inch				MP3000	F40M
MP16-16009C90Z6-M05	16,4 0.646	3,95 0.156	6,0 0.236	15,4 0.606	10,4 0.409	23,5 0.925	45,0	6			■

MP16 Cylindrical blanks

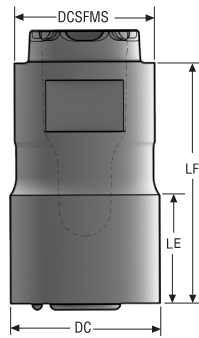

• Cylindrical carbide blanks for production of own geometries



Designation	DC	DCSFMS	LE	LF		Grades
						Uncoated
	mm Inch	mm Inch	mm Inch	mm Inch		H25
MP16-16010CYL-SEMI	16,4 0.646	15,4 0.606	11,4 0.449	24,8 0.976		■
MP16-16019CYL-SEMI	16,4 0.646	15,4 0.606	19,5 0.768	32,85 1.293	✓	■

Universal

Steel and cast iron

Stainless steel and S-materials

Stainless steel and S-materials

Non ferrous

Hard

Graphite

X-Heads

Minimaster Plus

Minimaster

MP16 High feed milling – Insert selection – mm/Inch

SMG		a_p		f_z			
				100%	70%	30%	20%
P1	MP16-1600.9HFZ3-MD12 MP3000	0,65	0,60	0,65	0,85	1,0	
		0,026	0,024	0,026	0,034	0,040	
P2	MP16-1600.9HFZ3-MD12 MP3000	0,65	0,65	0,65	0,85	1,0	
		0,026	0,026	0,026	0,034	0,040	
P3	MP16-1600.9HFZ3-MD12 MP3000	0,65	0,60	0,60	0,80	1,0	
		0,026	0,024	0,024	0,032	0,040	
P4	MP16-1600.9HFZ3-MD12 MP3000	0,65	0,60	0,60	0,80	0,95	
		0,026	0,024	0,024	0,032	0,038	
P5	MP16-1600.9HFZ3-MD12 MP3000	0,65	0,60	0,60	0,75	0,95	
		0,026	0,024	0,024	0,030	0,038	
P6	MP16-1600.9HFZ3-MD12 MP3000	0,65	0,55	0,60	0,75	0,95	
		0,026	0,022	0,024	0,030	0,038	
P7	MP16-1600.9HFZ3-MD12 MP3000	0,65	0,55	0,60	0,75	0,95	
		0,026	0,022	0,024	0,030	0,038	
P8	MP16-1600.9HFZ3-MD12 MP3000	0,65	0,60	0,60	0,80	1,0	
		0,026	0,024	0,024	0,032	0,040	
P11	MP16-1600.9HFZ3-MD12 MP3000	0,65	0,55	0,60	0,75	0,95	
		0,026	0,022	0,024	0,030	0,038	
P12	MP16-1600.9HFZ3-MD12 MP3000	0,50	0,44	0,40	0,50	0,60	
		0,020	0,017	0,016	0,020	0,024	
M1	MP16-1600.9HFZ3-MD12 MP3000	0,65	0,65	0,65	0,85	1,0	
		0,026	0,026	0,026	0,034	0,040	
M2	MP16-1600.9HFZ3-MD12 MP3000	0,65	0,60	0,60	0,75	0,95	
		0,026	0,024	0,024	0,030	0,038	
M3	MP16-1600.9HFZ3-MD12 MP3000	0,50	0,55	0,46	0,60	0,75	
		0,020	0,022	0,018	0,024	0,030	
M4	MP16-1600.9HFZ3-MD12 MP3000	0,38	0,48	0,40	0,55	0,65	
		0,015	0,019	0,016	0,022	0,026	
M5	MP16-1600.9HFZ3-MD12 MP3000	0,38	0,48	0,40	0,55	0,65	
		0,015	0,019	0,016	0,022	0,026	
K1	MP16-1600.9HFZ3-MD12 MP3000	0,65	0,65	0,65	0,85	1,0	
		0,026	0,026	0,026	0,034	0,040	
K2	MP16-1600.9HFZ3-MD12 MP3000	0,65	0,60	0,60	0,75	0,95	
		0,026	0,024	0,024	0,030	0,038	
K3	MP16-1600.9HFZ3-MD12 MP3000	0,65	0,60	0,60	0,75	0,95	
		0,026	0,024	0,024	0,030	0,038	
K4	MP16-1600.9HFZ3-MD12 MP3000	0,65	0,60	0,60	0,75	0,95	
		0,026	0,024	0,024	0,030	0,038	
K5	MP16-1600.9HFZ3-MD12 MP3000	0,65	0,50	0,50	0,70	0,85	
		0,026	0,020	0,020	0,028	0,034	
K6	MP16-1600.9HFZ3-MD12 MP3000	0,65	0,60	0,60	0,75	0,95	
		0,026	0,024	0,024	0,030	0,038	
K7	MP16-1600.9HFZ3-MD12 MP3000	0,65	0,50	0,50	0,70	0,85	
		0,026	0,020	0,020	0,028	0,034	
N1	MP16-1600.9HFZ3-MD12 MP3000	0,65	0,80	0,80	1,1	1,4	
		0,026	0,032	0,032	0,044	0,055	
N2	MP16-1600.9HFZ3-MD12 MP3000	0,65	0,80	0,80	1,1	1,4	
		0,026	0,032	0,032	0,044	0,055	
N3	MP16-1600.9HFZ3-MD12 MP3000	0,65	0,80	0,80	1,1	1,4	
		0,026	0,032	0,032	0,044	0,055	
N11	MP16-1600.9HFZ3-MD12 MP3000	0,65	0,80	0,80	1,1	1,4	
		0,026	0,032	0,032	0,044	0,055	
S1	MP16-1600.9HFZ3-MD12 MP3000	0,38	0,48	0,40	0,55	0,65	
		0,015	0,019	0,016	0,022	0,026	
S2	MP16-1600.9HFZ3-MD12 MP3000	0,38	0,48	0,40	0,55	0,65	
		0,015	0,019	0,016	0,022	0,026	
S3	MP16-1600.9HFZ3-MD12 MP3000	0,38	0,44	0,38	0,50	0,60	
		0,015	0,017	0,015	0,020	0,024	
S11	MP16-1600.9HFZ3-MD12 MP3000	0,44	0,55	0,46	0,60	0,75	
		0,017	0,022	0,018	0,024	0,030	
S12	MP16-1600.9HFZ3-MD12 MP3000	0,44	0,55	0,46	0,60	0,75	
		0,017	0,022	0,018	0,024	0,030	
S13	MP16-1600.9HFZ3-MD12 MP3000	0,38	0,48	0,40	0,55	0,65	
		0,015	0,019	0,016	0,022	0,026	
H5	MP16-1600.9HFZ3-MD12 MP3000	0,50	0,44	0,40	0,50	0,60	
		0,020	0,017	0,016	0,020	0,024	
H8	MP16-1600.9HFZ3-MD12 MP3000	0,44	0,34	0,30	0,40	0,46	
		0,017	0,013	0,012	0,016	0,018	
H11	MP16-1600.9HFZ3-MD12 MP3000	0,50	0,44	0,40	0,50	0,60	
		0,020	0,017	0,016	0,020	0,024	
H12	MP16-1600.9HFZ3-MD12 MP3000	0,44	0,34	0,30	0,40	0,46	
		0,017	0,013	0,012	0,016	0,018	
H21	MP16-1600.9HFZ3-MD12 MP3000	0,44	0,34	0,30	0,40	0,46	
		0,017	0,013	0,012	0,016	0,018	

SMG = Seco material group
 f_z = mm/tooth (in/tooth), v_c = m/min (sf/min), a_p/DC = %
 All cutting data are start values

MP16 High feed milling – Cutting data $v_c = (m/min)/(sf/min)$

SMG	MP3000				
	100%	70%	30%	20%	
P1	225	270	315	335	Universal
	740	890	1025	1100	
P2	215	265	305	325	Steel and cast iron
	710	870	1000	1075	
P3	190	230	265	280	Stainless steel and S-materials
	620	750	870	920	
P4	165	205	235	250	Stainless steel and S-materials
	540	670	770	820	
P5	160	195	230	240	Stainless steel and S-materials
	520	640	750	790	
P6	180	220	255	265	Stainless steel and S-materials
	590	720	840	870	
P7	170	205	240	250	Stainless steel and S-materials
	560	670	790	820	
P8	160	195	225	235	Stainless steel and S-materials
	520	640	740	770	
P11	165	200	235	245	Stainless steel and S-materials
	540	660	770	800	
P12	105	130	150	160	Stainless steel and S-materials
	345	425	490	520	
M1	160	195	230	245	Stainless steel and S-materials
	520	640	750	800	
M2	130	165	190	200	Stainless steel and S-materials
	425	540	620	660	
M3	105	135	155	160	Stainless steel and S-materials
	345	445	510	520	
M4	85	105	115	125	Non ferrous
	280	345	375	410	
M5	70	85	100	105	Non ferrous
	230	280	330	345	
K1	170	210	240	255	Non ferrous
	560	690	790	840	
K2	150	185	215	225	Non ferrous
	490	610	710	740	
K3	125	155	185	190	Hard
	410	510	610	620	
K4	120	150	175	180	Hard
	395	490	570	590	
K5	75	95	105	110	Hard
	245	310	345	360	
K6	105	130	155	160	Hard
	345	425	510	520	
K7	95	120	135	145	Hard
	310	395	445	475	
N1	1275	1550	1775	1850	Graphite
	4175	5075	5825	6075	
N2	510	630	720	750	Graphite
	1675	2075	2350	2450	
N3	340	420	480	500	Graphite
	1125	1375	1575	1650	
N11	390	480	550	570	Graphite
	1275	1575	1800	1875	
S1	40	48	55	60	X-Heads
	130	155	180	195	
S2	32	39	44	47	X-Heads
	105	130	145	155	
S3	28	34	39	41	X-Heads
	90	110	130	135	
S11	55	65	75	80	X-Heads
	180	215	245	260	
S12	38	46	55	55	Minimaster Plus
	125	150	180	180	
S13	22	27	31	33	Minimaster Plus
	70	90	100	110	
H5	33	41	47	50	Minimaster Plus
	110	135	155	165	
H8	36	43	50	55	Minimaster Plus
	120	140	165	180	
H11	42	50	60	65	Minimaster Plus
	140	165	195	215	
H12	70	85	95	100	Minimaster Plus
	230	280	310	330	
H21	36	43	50	55	Minimaster Plus
	120	140	165	180	

MP16 Slot and Side milling – Insert selection – Metric / Inch

SMG		a _p	f _z			
			100%	30%	10%	5%
P1	MP16-16010R04Z3-M05 MP3000	5,0	0,070	0,075	0,12	0,16
		0,20	0,0028	0,0030	0,0048	0,0065
P2	MP16-16010R04Z3-M05 MP3000	5,0	0,070	0,080	0,12	0,17
		0,20	0,0028	0,0032	0,0048	0,0065
P3	MP16-16010R04Z3-M05 MP3000	5,0	0,070	0,075	0,11	0,16
		0,20	0,0028	0,0030	0,0044	0,0065
P4	MP16-16010R04Z3-M05 MP3000	5,0	0,065	0,075	0,11	0,16
		0,20	0,0026	0,0030	0,0044	0,0065
P5	MP16-16010R04Z3-M05 MP3000	5,0	0,065	0,070	0,11	0,15
		0,20	0,0026	0,0028	0,0044	0,0060
P6	MP16-16010R04Z3-M05 MP3000	5,0	0,065	0,070	0,11	0,15
		0,20	0,0026	0,0028	0,0044	0,0060
P7	MP16-16010R04Z3-M05 MP3000	5,0	0,065	0,070	0,11	0,15
		0,20	0,0026	0,0028	0,0044	0,0060
P8	MP16-16010R04Z3-M05 MP3000	5,0	0,070	0,075	0,11	0,16
		0,20	0,0028	0,0030	0,0044	0,0065
P11	MP16-16010R04Z3-M05 MP3000	5,0	0,065	0,070	0,11	0,15
		0,20	0,0026	0,0028	0,0044	0,0060
P12	MP16-16010R04Z3-M05 MP3000	4,0	0,044	0,048	0,075	0,10
		0,16	0,0017	0,0019	0,0030	0,0040
M1	MP16-16010R05Z3-E05 F40M	5,0	0,070	0,080	0,12	0,17
		0,20	0,0028	0,0032	0,0048	0,0065
M2	MP16-16010R05Z3-E05 F40M	5,0	0,065	0,070	0,11	0,15
		0,20	0,0026	0,0028	0,0044	0,0060
M3	MP16-16010R05Z3-E05 F40M	4,0	0,050	0,055	0,085	0,12
		0,16	0,0020	0,0022	0,0034	0,0048
M4	MP16-16010R05Z3-E05 F40M	3,0	0,046	0,050	0,075	0,11
		0,12	0,0018	0,0020	0,0030	0,0044
M5	MP16-16010R05Z3-E05 F40M	3,0	0,046	0,050	0,075	0,11
		0,12	0,0018	0,0020	0,0030	0,0044
K1	MP16-16010R04Z3-M05 MP3000	5,0	0,070	0,080	0,12	0,17
		0,20	0,0028	0,0032	0,0048	0,0065
K2	MP16-16010R04Z3-M05 MP3000	5,0	0,065	0,070	0,11	0,15
		0,20	0,0026	0,0028	0,0044	0,0060
K3	MP16-16010R04Z3-M05 MP3000	5,0	0,065	0,070	0,11	0,15
		0,20	0,0026	0,0028	0,0044	0,0060
K4	MP16-16010R04Z3-M05 MP3000	5,0	0,065	0,070	0,11	0,15
		0,20	0,0026	0,0028	0,0044	0,0060
K5	MP16-16010R04Z3-M05 MP3000	5,0	0,060	0,065	0,10	0,14
		0,20	0,0024	0,0026	0,0040	0,0055
K6	MP16-16010R04Z3-M05 MP3000	5,0	0,065	0,070	0,11	0,15
		0,20	0,0026	0,0028	0,0044	0,0060
K7	MP16-16010R04Z3-M05 MP3000	5,0	0,060	0,065	0,10	0,14
		0,20	0,0024	0,0026	0,0040	0,0055
N1	MP16-16010R05Z3-E05 F40M	5,0	0,090	0,10	0,15	0,22
		0,20	0,0036	0,0040	0,0060	0,0085
N2	MP16-16010R05Z3-E05 F40M	5,0	0,090	0,10	0,15	0,22
		0,20	0,0036	0,0040	0,0060	0,0085
N3	MP16-16010R05Z3-E05 F40M	5,0	0,090	0,10	0,15	0,22
		0,20	0,0036	0,0040	0,0060	0,0085
N11	MP16-16010R05Z3-E05 F40M	5,0	0,090	0,10	0,15	0,22
		0,20	0,0036	0,0040	0,0060	0,0085
S1	MP16-16010R05Z3-E05 F40M	3,0	0,046	0,050	0,075	0,11
		0,12	0,0018	0,0020	0,0030	0,0044
S2	MP16-16010R05Z3-E05 F40M	3,0	0,046	0,050	0,075	0,11
		0,12	0,0018	0,0020	0,0030	0,0044
S3	MP16-16010R05Z3-E05 F40M	3,0	0,042	0,046	0,070	0,10
		0,12	0,0017	0,0018	0,0028	0,0040
S11	MP16-16010R05Z3-E05 F40M	3,5	0,055	0,055	0,085	0,12
		0,14	0,0022	0,0022	0,0034	0,0048
S12	MP16-16010R05Z3-E05 F40M	3,5	0,055	0,055	0,085	0,12
		0,14	0,0022	0,0022	0,0034	0,0048
S13	MP16-16010R05Z3-E05 F40M	3,0	0,046	0,050	0,075	0,11
		0,12	0,0018	0,0020	0,0030	0,0044
H5	MP16-16010R04Z3-M05 MP3000	4,0	0,044	0,048	0,075	0,10
		0,16	0,0017	0,0019	0,0030	0,0040
H8	MP16-16010R04Z3-M05 MP3000	3,5	0,034	0,038	0,055	0,080
		0,14	0,0013	0,0015	0,0022	0,0032
H11	MP16-16010R04Z3-M05 MP3000	4,0	0,044	0,048	0,075	0,10
		0,16	0,0017	0,0019	0,0030	0,0040
H12	MP16-16010R04Z3-M05 MP3000	3,5	0,034	0,038	0,055	0,080
		0,14	0,0013	0,0015	0,0022	0,0032
H21	MP16-16010R04Z3-M05 MP3000	3,5	0,034	0,038	0,055	0,080
		0,14	0,0013	0,0015	0,0022	0,0032

SMG = Seco material group
f_z = mm/tooth (in/tooth), v_c = m/min (sf/min), a_p/DC = %
All cutting data are start values

MP16 Slot and Side milling – Cutting data $v_c = (m/min)/(sf/min)$

SMG	MP3000				F40M									
	100%	30%	10%	5%	100%	30%	10%	5%						
P1	235	310	360	395	225	295	340	375	Universal					
	770	1025	1175	1300	740	970	1125	1225						
P2	230	300	350	380	215	280	335	360		Steel and cast iron				
	750	980	1150	1250	710	920	1100	1175						
P3	195	260	310	330	185	245	290	315			Stainless steel and S-materials			
	640	850	1025	1075	610	800	950	1025						
P4	175	230	270	290	165	215	255	275				Stainless steel and S-materials		
	570	750	890	950	540	710	840	900						
P5	170	220	260	280	160	210	245	265					Stainless steel and S-materials	
	560	720	850	920	520	690	800	870						
P6	190	250	290	315	180	235	275	300						Stainless steel and S-materials
	620	820	950	1025	590	770	900	980						
P7	180	235	275	300	170	225	260	285	Stainless steel and S-materials					
	590	770	900	980	560	740	850	940						
P8	165	220	260	280	155	205	245	265		Stainless steel and S-materials				
	540	720	850	920	510	670	800	870						
P11	175	230	265	290	165	215	255	275			Stainless steel and S-materials			
	570	750	870	950	540	710	840	900						
P12	110	145	170	185	105	140	160	175				Stainless steel and S-materials		
	360	475	560	610	345	460	520	570						
M1	170	225	265	285	175	225	270	290					Stainless steel and S-materials	
	560	740	870	940	570	740	890	950						
M2	140	185	215	235	145	190	220	240						Stainless steel and S-materials
	460	610	710	770	475	620	720	790						
M3	115	150	175	190	115	150	175	190	Stainless steel and S-materials					
	375	490	570	620	375	490	570	620						
M4	85	115	135	145	90	115	135	145		Stainless steel and S-materials				
	280	375	445	475	295	375	445	475						
M5	75	95	110	120	75	95	115	120			Non ferrous			
	245	310	360	395	245	310	375	395						
K1	180	235	280	300	170	225	265	285				Non ferrous		
	590	770	920	980	560	740	870	940						
K2	160	210	245	270	150	200	235	255					Non ferrous	
	520	690	800	890	490	660	770	840						
K3	135	180	210	225	130	170	195	215						Hard
	445	590	690	740	425	560	640	710						
K4	130	170	200	215	120	160	190	205	Hard					
	425	560	660	710	395	520	620	670						
K5	80	105	120	130	75	95	115	125		Hard				
	260	345	395	425	245	310	375	410						
K6	115	150	175	190	110	140	165	180			Hard			
	375	490	570	620	360	460	540	590						
K7	100	130	155	165	95	125	145	160				Hard		
	330	425	510	540	310	410	475	520						
N1	1350	1775	2100	2250	1275	1675	1975	2125					Graphite	
	4425	5825	6900	7375	4175	5500	6475	6975						
N2	550	720	850	910	520	680	800	860						Graphite
	1800	2350	2800	2975	1700	2225	2625	2825						
N3	365	475	560	600	345	450	530	570	Graphite					
	1200	1550	1825	1975	1125	1475	1750	1875						
N11	415	540	640	690	395	520	610	650		Graphite				
	1350	1775	2100	2275	1300	1700	2000	2125						
S1	41	55	60	65	42	55	65	70			X-Heads			
	135	180	195	215	140	180	215	230						
S2	33	43	50	55	34	44	50	55				X-Heads		
	110	140	165	180	110	145	165	180						
S3	29	38	44	47	29	38	45	48					X-Heads	
	95	125	145	155	95	125	150	155						
S11	60	75	90	95	60	75	90	95						X-Heads
	195	245	295	310	195	245	295	310						
S12	40	50	60	65	40	55	60	65	X-Heads					
	130	165	195	215	130	180	195	215						
S13	23	30	35	38	23	31	36	38		X-Heads				
	75	100	115	125	75	100	120	125						
H5	35	45	55	60	35	46	55	60			Minimaster Plus			
	115	150	180	195	115	150	180	195						
H8	36	47	55	60	37	48	55	60				Minimaster Plus		
	120	155	180	195	120	155	180	195						
H11	44	60	65	75	45	60	70	75					Minimaster Plus	
	145	195	215	245	150	195	230	245						
H12	70	90	105	115	65	85	100	110						Minimaster Plus
	230	295	345	375	215	280	330	360						
H21	36	47	55	60	37	48	55	60	Minimaster Plus					
	120	155	180	195	120	155	180	195						

MP16 Copy milling – Insert selection – mm/Inch

SMG		a _p	f _z				
			100%	30%	10%	5%	2%
P1	MP16-16010B90Z3-M05 MP3000	5,0	0,080	0,085	0,12	0,17	0,28
		0,20	0,0032	0,0034	0,0048	0,0065	0,011
P2	MP16-16010B90Z3-M05 MP3000	5,0	0,085	0,085	0,13	0,18	0,28
		0,20	0,0034	0,0034	0,0050	0,0070	0,011
P3	MP16-16010B90Z3-M05 MP3000	5,0	0,080	0,080	0,12	0,17	0,26
		0,20	0,0032	0,0032	0,0048	0,0065	0,010
P4	MP16-16010B90Z3-M05 MP3000	5,0	0,075	0,080	0,12	0,16	0,26
		0,20	0,0030	0,0032	0,0048	0,0065	0,010
P5	MP16-16010B90Z3-M05 MP3000	5,0	0,075	0,080	0,12	0,16	0,26
		0,20	0,0030	0,0032	0,0048	0,0065	0,010
P6	MP16-16010B90Z3-M05 MP3000	5,0	0,075	0,080	0,11	0,16	0,26
		0,20	0,0030	0,0032	0,0044	0,0065	0,010
P7	MP16-16010B90Z3-M05 MP3000	5,0	0,075	0,080	0,11	0,16	0,26
		0,20	0,0030	0,0032	0,0044	0,0065	0,010
P8	MP16-16010B90Z3-M05 MP3000	5,0	0,080	0,080	0,12	0,17	0,26
		0,20	0,0032	0,0032	0,0048	0,0065	0,010
P11	MP16-16010B90Z3-M05 MP3000	5,0	0,075	0,080	0,11	0,16	0,26
		0,20	0,0030	0,0032	0,0044	0,0065	0,010
P12	MP16-16010B90Z3-M05 MP3000	4,0	0,055	0,055	0,080	0,11	0,17
		0,16	0,0022	0,0022	0,0032	0,0044	0,0065
M1	MP16-16010B90Z3-E05 F40M	5,0	0,085	0,085	0,13	0,18	0,28
		0,20	0,0034	0,0034	0,0050	0,0070	0,011
M2	MP16-16010B90Z3-E05 F40M	5,0	0,075	0,080	0,12	0,16	0,26
		0,20	0,0030	0,0032	0,0048	0,0065	0,010
M3	MP16-16010B90Z3-E05 F40M	4,0	0,065	0,065	0,090	0,13	0,20
		0,16	0,0026	0,0026	0,0036	0,0050	0,0080
M4	MP16-16010B90Z3-E05 F40M	3,0	0,060	0,060	0,080	0,11	0,18
		0,12	0,0024	0,0024	0,0032	0,0044	0,0070
M5	MP16-16010B90Z3-E05 F40M	3,0	0,060	0,060	0,080	0,11	0,18
		0,12	0,0024	0,0024	0,0032	0,0044	0,0070
K1	MP16-16010B90Z3-M05 MP3000	5,0	0,085	0,085	0,13	0,18	0,28
		0,20	0,0034	0,0034	0,0050	0,0070	0,011
K2	MP16-16010B90Z3-M05 MP3000	5,0	0,075	0,080	0,12	0,16	0,26
		0,20	0,0030	0,0032	0,0048	0,0065	0,010
K3	MP16-16010B90Z3-M05 MP3000	5,0	0,075	0,080	0,12	0,16	0,26
		0,20	0,0030	0,0032	0,0048	0,0065	0,010
K4	MP16-16010B90Z3-M05 MP3000	5,0	0,075	0,080	0,12	0,16	0,26
		0,20	0,0030	0,0032	0,0048	0,0065	0,010
K5	MP16-16010B90Z3-M05 MP3000	5,0	0,070	0,070	0,10	0,14	0,24
		0,20	0,0028	0,0028	0,0040	0,0055	0,0095
K6	MP16-16010B90Z3-M05 MP3000	5,0	0,075	0,080	0,12	0,16	0,26
		0,20	0,0030	0,0032	0,0048	0,0065	0,010
K7	MP16-16010B90Z3-M05 MP3000	5,0	0,070	0,070	0,10	0,14	0,24
		0,20	0,0028	0,0028	0,0040	0,0055	0,0095
N1	MP16-16010B90Z3-E05 F40M	5,0	0,11	0,11	0,16	0,22	0,38
		0,20	0,0044	0,0044	0,0065	0,0085	0,015
N2	MP16-16010B90Z3-E05 F40M	5,0	0,11	0,11	0,16	0,22	0,38
		0,20	0,0044	0,0044	0,0065	0,0085	0,015
N3	MP16-16010B90Z3-E05 F40M	5,0	0,11	0,11	0,16	0,22	0,38
		0,20	0,0044	0,0044	0,0065	0,0085	0,015
N11	MP16-16010B90Z3-E05 F40M	5,0	0,11	0,11	0,16	0,22	0,38
		0,20	0,0044	0,0044	0,0065	0,0085	0,015
S1	MP16-16010B90Z3-E05 F40M	3,0	0,060	0,060	0,080	0,11	0,18
		0,12	0,0024	0,0024	0,0032	0,0044	0,0070
S2	MP16-16010B90Z3-E05 F40M	3,0	0,060	0,060	0,080	0,11	0,18
		0,12	0,0024	0,0024	0,0032	0,0044	0,0070
S3	MP16-16010B90Z3-E05 F40M	3,0	0,055	0,055	0,075	0,10	0,16
		0,12	0,0022	0,0022	0,0030	0,0040	0,0065
S11	MP16-16010B90Z3-E05 F40M	3,5	0,065	0,065	0,090	0,13	0,20
		0,14	0,0026	0,0026	0,0036	0,0050	0,0080
S12	MP16-16010B90Z3-E05 F40M	3,5	0,065	0,065	0,090	0,13	0,20
		0,14	0,0026	0,0026	0,0036	0,0050	0,0080
S13	MP16-16010B90Z3-E05 F40M	3,0	0,060	0,060	0,080	0,11	0,18
		0,12	0,0024	0,0024	0,0032	0,0044	0,0070
H5	MP16-16010B90Z3-M05 MP3000	4,0	0,055	0,055	0,080	0,11	0,17
		0,16	0,0022	0,0022	0,0032	0,0044	0,0065
H8	MP16-16010B90Z3-M05 MP3000	3,5	0,042	0,042	0,060	0,080	0,13
		0,14	0,0017	0,0017	0,0024	0,0032	0,0050
H11	MP16-16010B90Z3-M05 MP3000	4,0	0,055	0,055	0,080	0,11	0,17
		0,16	0,0022	0,0022	0,0032	0,0044	0,0065
H12	MP16-16010B90Z3-M05 MP3000	3,5	0,042	0,042	0,060	0,080	0,13
		0,14	0,0017	0,0017	0,0024	0,0032	0,0050
H21	MP16-16010B90Z3-M05 MP3000	3,5	0,042	0,042	0,060	0,080	0,13
		0,14	0,0017	0,0017	0,0024	0,0032	0,0050

SMG = Seco material group
f_z = mm/tooth (in/tooth), v_c = m/min (sf/min), a_p/DC = %
All cutting data are start values

MP16 Copy milling – Cutting data $v_c = (m/min)/(sf/min)$

SMG	MP3000					F40M				
	100%	30%	10%	5%	2%	100%	30%	10%	5%	2%
P1	250	305	330	355	350	235	290	310	335	330
	820	1000	1075	1175	1150	770	950	1025	1100	1075
P2	240	295	320	345	340	225	275	300	325	325
	790	970	1050	1125	1125	740	900	980	1075	1075
P3	210	255	275	300	300	200	240	260	285	280
	690	840	900	980	980	660	790	850	940	920
P4	185	225	245	265	265	175	215	235	250	250
	610	740	800	870	870	570	710	770	820	820
P5	180	215	235	255	255	170	205	220	240	240
	590	710	770	840	840	560	670	720	790	790
P6	200	245	265	285	285	190	230	250	270	270
	660	800	870	940	940	620	750	820	890	890
P7	190	230	250	270	270	180	215	235	255	255
	620	750	820	890	890	590	710	770	840	840
P8	175	215	230	250	250	165	205	220	240	235
	570	710	750	820	820	540	670	720	790	770
P11	185	225	240	265	260	175	210	230	250	245
	610	740	790	870	850	570	690	750	820	800
P12	120	145	150	165	165	110	135	145	155	155
	395	475	490	540	540	360	445	475	510	510
M1	180	220	240	260	255	185	225	245	265	260
	590	720	790	850	840	610	740	800	870	850
M2	150	180	195	215	210	150	185	200	215	215
	490	590	640	710	690	490	610	660	710	710
M3	120	145	155	170	165	125	150	160	170	170
	395	475	510	560	540	410	490	520	560	560
M4	95	115	120	130	130	95	120	120	130	130
	310	375	395	425	425	310	395	395	425	425
M5	80	95	100	105	105	80	100	100	110	110
	260	310	330	345	345	260	330	330	360	360
K1	190	230	255	275	270	180	220	240	260	255
	620	750	840	900	890	590	720	790	850	840
K2	170	205	225	245	240	160	195	210	230	225
	560	670	740	800	790	520	640	690	750	740
K3	145	175	190	205	205	135	165	180	195	190
	475	570	620	670	670	445	540	590	640	620
K4	135	165	180	195	195	130	155	170	185	185
	445	540	590	640	640	425	510	560	610	610
K5	80	100	110	120	120	80	95	105	110	110
	260	330	360	395	395	260	310	345	360	360
K6	120	145	160	175	170	115	140	150	165	160
	395	475	520	570	560	375	460	490	540	520
K7	105	130	140	150	150	100	120	130	145	145
	345	425	460	490	490	330	395	425	475	475
N1	1425	1750	1900	2050	2025	1350	1650	1775	1950	1925
	4675	5750	6225	6725	6650	4425	5425	5825	6400	6325
N2	580	700	760	830	820	550	660	720	780	780
	1900	2300	2500	2725	2700	1800	2175	2350	2550	2550
N3	385	470	510	550	550	365	445	480	520	520
	1275	1550	1675	1800	1800	1200	1450	1575	1700	1700
N11	440	540	580	630	630	415	510	550	600	590
	1450	1775	1900	2075	2075	1350	1675	1800	1975	1925
S1	44	55	55	60	60	45	55	55	60	60
	145	180	180	195	195	150	180	180	195	195
S2	36	44	45	48	48	36	44	45	49	49
	120	145	150	155	155	120	145	150	160	160
S3	31	38	39	42	42	32	38	40	43	43
	100	125	130	140	140	105	125	130	140	140
S11	60	75	80	85	85	65	75	80	85	85
	195	245	260	280	280	215	245	260	280	280
S12	43	50	55	60	60	44	55	55	60	60
	140	165	180	195	195	145	180	180	195	195
S13	25	30	31	34	34	25	31	32	34	34
	80	100	100	110	110	80	100	105	110	110
H5	37	45	47	50	50	37	45	48	50	50
	120	150	155	165	165	120	150	155	165	165
H8	39	47	49	55	55	39	48	49	55	55
	130	155	160	180	180	130	155	160	180	180
H11	47	55	60	65	65	47	60	60	65	65
	155	180	195	215	215	155	195	195	215	215
H12	75	90	95	100	100	70	85	90	95	95
	245	295	310	330	330	230	280	295	310	310
H21	39	47	49	55	55	39	48	49	55	55
	130	155	160	180	180	130	155	160	180	180

Universal
Steel and cast iron
Stainless steel and S-materials
Stainless steel and S-materials
Non ferrous
Hard
Graphite
X-Heads
Minimaster Plus
Minimaster

MP16 Centre drilling – Insert selection – Metric / Inch

SMG		f_z	a_{so}
			100%
P1	MP16-16009C90Z2-M05 F40M	0,070 0.0028	4,5 0.18
P2	MP16-16009C90Z2-M05 F40M	0,070 0.0028	4,5 0.18
P3	MP16-16009C90Z2-M05 F40M	0,070 0.0028	4,5 0.18
P4	MP16-16009C90Z2-M05 F40M	0,065 0.0026	4,5 0.18
P5	MP16-16009C90Z2-M05 F40M	0,065 0.0026	4,5 0.18
P6	MP16-16009C90Z2-M05 F40M	0,065 0.0026	4,5 0.18
P7	MP16-16009C90Z2-M05 F40M	0,065 0.0026	4,5 0.18
P8	MP16-16009C90Z2-M05 F40M	0,070 0.0028	4,5 0.18
P11	MP16-16009C90Z2-M05 F40M	0,065 0.0026	4,5 0.18
P12	MP16-16009C90Z2-M05 F40M	0,044 0.0017	3,5 0.14
M1	MP16-16009C90Z2-M05 F40M	0,070 0.0028	4,5 0.18
M2	MP16-16009C90Z2-M05 F40M	0,065 0.0026	4,5 0.18
M3	MP16-16009C90Z2-M05 F40M	0,050 0.0020	3,5 0.14
M4	MP16-16009C90Z2-M05 F40M	0,046 0.0018	2,5 0.10
M5	MP16-16009C90Z2-M05 F40M	0,046 0.0018	2,5 0.10
K1	MP16-16009C90Z2-M05 F40M	0,070 0.0028	4,5 0.18
K2	MP16-16009C90Z2-M05 F40M	0,065 0.0026	4,5 0.18
K3	MP16-16009C90Z2-M05 F40M	0,065 0.0026	4,5 0.18
K4	MP16-16009C90Z2-M05 F40M	0,065 0.0026	4,5 0.18
K5	MP16-16009C90Z2-M05 F40M	0,060 0.0024	4,5 0.18
K6	MP16-16009C90Z2-M05 F40M	0,065 0.0026	4,5 0.18
K7	MP16-16009C90Z2-M05 F40M	0,060 0.0024	4,5 0.18
N1	MP16-16009C90Z2-M05 F40M	0,090 0.0036	4,5 0.18
N2	MP16-16009C90Z2-M05 F40M	0,090 0.0036	4,5 0.18
N3	MP16-16009C90Z2-M05 F40M	0,090 0.0036	4,5 0.18
N11	MP16-16009C90Z2-M05 F40M	0,090 0.0036	4,5 0.18
S1	MP16-16009C90Z2-M05 F40M	0,046 0.0018	2,5 0.10
S2	MP16-16009C90Z2-M05 F40M	0,046 0.0018	2,5 0.10
S3	MP16-16009C90Z2-M05 F40M	0,042 0.0017	2,5 0.10
S11	MP16-16009C90Z2-M05 F40M	0,050 0.0020	3,0 0.12
S12	MP16-16009C90Z2-M05 F40M	0,050 0.0020	3,0 0.12
S13	MP16-16009C90Z2-M05 F40M	0,046 0.0018	2,5 0.10
H5	MP16-16009C90Z2-M05 F40M	0,044 0.0017	3,5 0.14
H8	MP16-16009C90Z2-M05 F40M	0,034 0.0013	3,0 0.12
H11	MP16-16009C90Z2-M05 F40M	0,044 0.0017	3,5 0.14
H12	MP16-16009C90Z2-M05 F40M	0,034 0.0013	3,0 0.12
H21	MP16-16009C90Z2-M05 F40M	0,034 0.0013	3,0 0.12

SMG = Seco material group
 f_z = mm/tooth (in/tooth), v_c = m/min (sf/min), a_e/DC = %
 All cutting data are start values

MP16 Centre drilling – Cutting data $v_c = (m/min)/(sf/min)$

SMG	F40M			
		100%		
P1		290	Universal	
		950		
P2		285	Steel and cast iron	
		940		
P3		250		
		820		
P4		220		
		720		
P5		210		
		690		
P6		235	Stainless steel and S-materials	
		770		
P7		225		
		740		
P8		210		
		690		
P11		220	Stainless steel and S-materials	
		720		
P12		140	Stainless steel and S-materials	
		460		
M1		230		
		750		
M2		190		Stainless steel and S-materials
		620		
M3		150		
		490		
M4		115		
		375		
M5		95	Non ferrous	
		310		
K1		225		
		740		
K2		200		Non ferrous
		660		
K3		170		
		560		
K4		160	Hard	
		520		
K5		100		
		330		
K6		145		
		475		
K7		125		
		410		
N1		1650	Graphite	
		5425		
N2		670		
		2200		
N3		445		
		1450		
N11		510	Minimaster Plus	
		1675		
S1		55		
		180		
S2		43		
		140		
S3		37		
		120		
S11		75		
		245		
S12		50		
		165		
S13		30		
		100		
H5		46	Minimaster	
		150		
H8		48		
		155		
H11		60		
		195		
H12		85		
		280		
H21		48		
		155		

MP16 Chamfering – Insert selection – Metric / Inch

SMG		a _p	f _z				
			100%	50%	30%	20%	10%
P1	MP16-16009C90Z2-M05 F40M	3,5	0,10	0,10	0,10	0,10	0,12
		0,14	0,0040	0,0040	0,0040	0,0040	0,0048
P2	MP16-16009C90Z2-M05 F40M	3,5	0,10	0,10	0,10	0,10	0,12
		0,14	0,0040	0,0040	0,0040	0,0040	0,0048
P3	MP16-16009C90Z2-M05 F40M	3,5	0,095	0,095	0,095	0,095	0,12
		0,14	0,0038	0,0038	0,0038	0,0038	0,0048
P4	MP16-16009C90Z2-M05 F40M	3,5	0,095	0,095	0,095	0,095	0,11
		0,14	0,0038	0,0038	0,0038	0,0038	0,0044
P5	MP16-16009C90Z2-M05 F40M	3,5	0,090	0,090	0,090	0,090	0,11
		0,14	0,0036	0,0036	0,0036	0,0036	0,0044
P6	MP16-16009C90Z2-M05 F40M	3,5	0,090	0,090	0,090	0,090	0,11
		0,14	0,0036	0,0036	0,0036	0,0036	0,0044
P7	MP16-16009C90Z2-M05 F40M	3,5	0,090	0,090	0,090	0,090	0,11
		0,14	0,0036	0,0036	0,0036	0,0036	0,0044
P8	MP16-16009C90Z2-M05 F40M	3,5	0,095	0,095	0,095	0,095	0,12
		0,14	0,0038	0,0038	0,0038	0,0038	0,0048
P11	MP16-16009C90Z2-M05 F40M	3,5	0,090	0,090	0,090	0,090	0,11
		0,14	0,0036	0,0036	0,0036	0,0036	0,0044
P12	MP16-16009C90Z2-M05 F40M	3,0	0,065	0,065	0,065	0,065	0,075
		0,12	0,0026	0,0026	0,0026	0,0026	0,0030
M1	MP16-16009C90Z2-M05 F40M	3,5	0,10	0,10	0,10	0,10	0,12
		0,14	0,0040	0,0040	0,0040	0,0040	0,0048
M2	MP16-16009C90Z2-M05 F40M	3,5	0,090	0,090	0,090	0,090	0,11
		0,14	0,0036	0,0036	0,0036	0,0036	0,0044
M3	MP16-16009C90Z2-M05 F40M	3,0	0,075	0,075	0,075	0,075	0,090
		0,12	0,0030	0,0030	0,0030	0,0030	0,0036
M4	MP16-16009C90Z2-M05 F40M	2,0	0,065	0,065	0,065	0,065	0,080
		0,080	0,0026	0,0026	0,0026	0,0026	0,0032
M5	MP16-16009C90Z2-M05 F40M	2,0	0,065	0,065	0,065	0,065	0,080
		0,080	0,0026	0,0026	0,0026	0,0026	0,0032
K1	MP16-16009C90Z2-M05 F40M	3,5	0,10	0,10	0,10	0,10	0,12
		0,14	0,0040	0,0040	0,0040	0,0040	0,0048
K2	MP16-16009C90Z2-M05 F40M	3,5	0,090	0,090	0,090	0,090	0,11
		0,14	0,0036	0,0036	0,0036	0,0036	0,0044
K3	MP16-16009C90Z2-M05 F40M	3,5	0,090	0,090	0,090	0,090	0,11
		0,14	0,0036	0,0036	0,0036	0,0036	0,0044
K4	MP16-16009C90Z2-M05 F40M	3,5	0,090	0,090	0,090	0,090	0,11
		0,14	0,0036	0,0036	0,0036	0,0036	0,0044
K5	MP16-16009C90Z2-M05 F40M	3,5	0,085	0,085	0,085	0,085	0,10
		0,14	0,0034	0,0034	0,0034	0,0034	0,0040
K6	MP16-16009C90Z2-M05 F40M	3,5	0,090	0,090	0,090	0,090	0,11
		0,14	0,0036	0,0036	0,0036	0,0036	0,0044
K7	MP16-16009C90Z2-M05 F40M	3,5	0,085	0,085	0,085	0,085	0,10
		0,14	0,0034	0,0034	0,0034	0,0034	0,0040
N1	MP16-16009C90Z2-M05 F40M	3,5	0,13	0,13	0,13	0,13	0,16
		0,14	0,0050	0,0050	0,0050	0,0050	0,0065
N2	MP16-16009C90Z2-M05 F40M	3,5	0,13	0,13	0,13	0,13	0,16
		0,14	0,0050	0,0050	0,0050	0,0050	0,0065
N3	MP16-16009C90Z2-M05 F40M	3,5	0,13	0,13	0,13	0,13	0,16
		0,14	0,0050	0,0050	0,0050	0,0050	0,0065
N11	MP16-16009C90Z2-M05 F40M	3,5	0,13	0,13	0,13	0,13	0,16
		0,14	0,0050	0,0050	0,0050	0,0050	0,0065
S1	MP16-16009C90Z2-M05 F40M	2,0	0,065	0,065	0,065	0,065	0,080
		0,080	0,0026	0,0026	0,0026	0,0026	0,0032
S2	MP16-16009C90Z2-M05 F40M	2,0	0,065	0,065	0,065	0,065	0,080
		0,080	0,0026	0,0026	0,0026	0,0026	0,0032
S3	MP16-16009C90Z2-M05 F40M	2,0	0,060	0,060	0,060	0,060	0,070
		0,080	0,0024	0,0024	0,0024	0,0024	0,0028
S11	MP16-16009C90Z2-M05 F40M	2,5	0,075	0,075	0,075	0,075	0,090
		0,10	0,0030	0,0030	0,0030	0,0030	0,0036
S12	MP16-16009C90Z2-M05 F40M	2,5	0,075	0,075	0,075	0,075	0,090
		0,10	0,0030	0,0030	0,0030	0,0030	0,0036
S13	MP16-16009C90Z2-M05 F40M	2,0	0,065	0,065	0,065	0,065	0,080
		0,080	0,0026	0,0026	0,0026	0,0026	0,0032
H5	MP16-16009C90Z2-M05 F40M	3,0	0,065	0,065	0,065	0,065	0,075
		0,12	0,0026	0,0026	0,0026	0,0026	0,0030
H8	MP16-16009C90Z2-M05 F40M	2,5	0,048	0,048	0,048	0,048	0,060
		0,10	0,0019	0,0019	0,0019	0,0019	0,0024
H11	MP16-16009C90Z2-M05 F40M	3,0	0,065	0,065	0,065	0,065	0,075
		0,12	0,0026	0,0026	0,0026	0,0026	0,0030
H12	MP16-16009C90Z2-M05 F40M	2,5	0,048	0,048	0,048	0,048	0,060
		0,10	0,0019	0,0019	0,0019	0,0019	0,0024
H21	MP16-16009C90Z2-M05 F40M	2,5	0,048	0,048	0,048	0,048	0,060
		0,10	0,0019	0,0019	0,0019	0,0019	0,0024

SMG = Seco material group
f_z = mm/tooth (in/tooth), v_c = m/min (sf/min), a_p/DC = %
All cutting data are start values

MP16 Chamfering – Cutting data $v_c = (m/min)/(sf/min)$

SMG	F40M				
	100%	50%	30%	20%	10%
P1	290	270	315	350	415
	950	890	1025	1150	1350
P2	285	260	310	345	400
	940	850	1025	1125	1300
P3	250	230	270	300	345
	820	750	890	980	1125
P4	220	200	235	265	310
	720	660	770	870	1025
P5	210	195	230	255	295
	690	640	750	840	970
P6	235	220	260	285	335
	770	720	850	940	1100
P7	225	205	245	270	315
	740	670	800	890	1025
P8	210	190	225	250	290
	690	620	740	820	950
P11	220	200	235	260	305
	720	660	770	850	1000
P12	140	125	140	160	195
	460	410	460	520	640
M1	230	210	250	275	325
	750	690	820	900	1075
M2	190	175	205	230	265
	620	570	670	750	870
M3	150	135	155	175	215
	490	445	510	570	710
M4	115	95	115	125	165
	375	310	375	410	540
M5	95	80	95	105	135
	310	260	310	345	445
K1	225	205	245	270	320
	740	670	800	890	1050
K2	200	185	220	240	280
	660	610	720	790	920
K3	170	155	185	205	240
	560	510	610	670	790
K4	160	150	175	195	230
	520	490	570	640	750
K5	100	90	105	120	140
	330	295	345	395	460
K6	145	130	155	170	200
	475	425	510	560	660
K7	125	115	135	150	175
	410	375	445	490	570
N1	1650	1500	1800	2000	2325
	5425	4925	5900	6550	7625
N2	670	610	720	810	940
	2200	2000	2350	2650	3075
N3	445	405	485	540	630
	1450	1325	1600	1775	2075
N11	510	465	550	610	720
	1675	1525	1800	2000	2350
S1	55	44	55	60	75
	180	145	180	195	245
S2	43	35	43	47	60
	140	115	140	155	195
S3	37	31	38	42	55
	120	100	125	140	180
S11	75	65	75	85	110
	245	215	245	280	360
S12	50	45	50	60	75
	165	150	165	195	245
S13	30	25	30	33	43
	100	80	100	110	140
H5	46	41	47	55	65
	150	135	155	180	215
H8	48	42	48	55	70
	155	140	155	180	230
H11	60	50	60	70	85
	195	165	195	230	280
H12	85	75	85	100	125
	280	245	280	330	410
H21	48	42	48	55	70
	155	140	155	180	230

Universal
Steel and cast iron
Stainless steel and S-materials
Stainless steel and S-materials
Non ferrous
Hard
Graphite
X-Heads
Minimaster Plus
Minimaster



MINIMASTER™

Minimaster™ is a unique, versatile end milling system that can combine different solutions for optimum accessibility and maximum stability and security.

The flexible two-piece design combines shanks and inserts to save time, money and create a versatile tool that enables users to find a solution for almost every application – whether they need to minimize the overhang, attain maximum stability, or more.

- Square Shoulder range: 6-20 mm (.25 - .75 inch)
- Ballnose range: 6-20 mm (.25 - .75 inch)
- Center Drilling/Chamfering range: 6-19,05mm (.25 - .750 inch)
- High Feed range: 8-12 mm (.375 - .625 inch)
- Plunging range: 6-16 mm (.25 - .625 inch)
- Concave Radius range: 12 mm (.472 inch)

Universal

Steel and cast iron

Stainless steel
and S-materials

Non ferrous

Hard

Plastic and CFRP

Graphite

X-Heads

Minimaster Plus

Minimaster

Code keys

Shanks

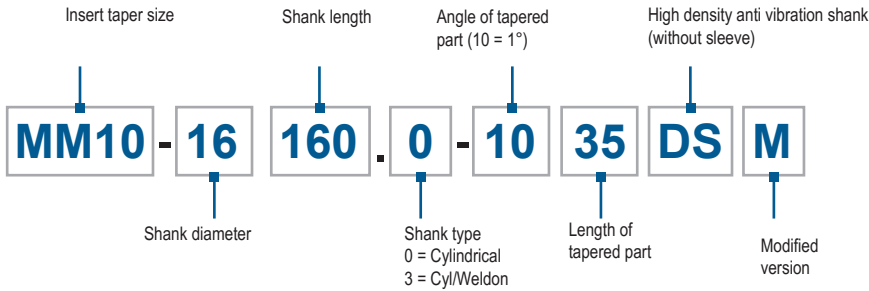

3-flute Minimaster inserts

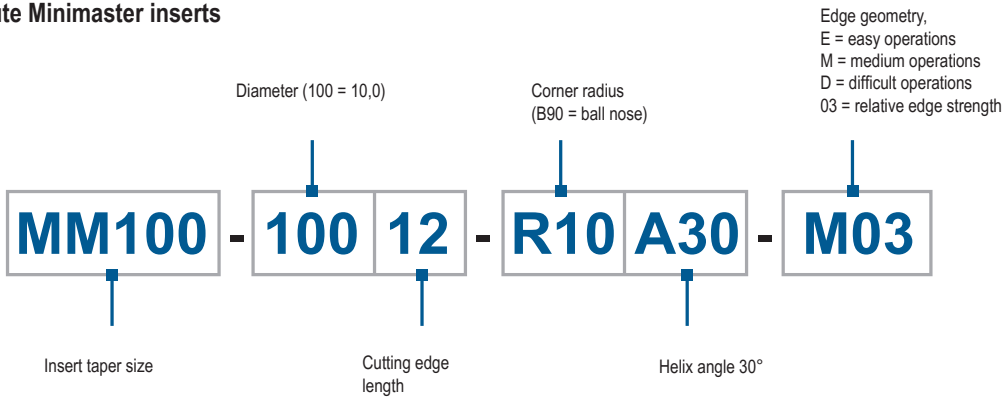

2-flute Minimaster inserts

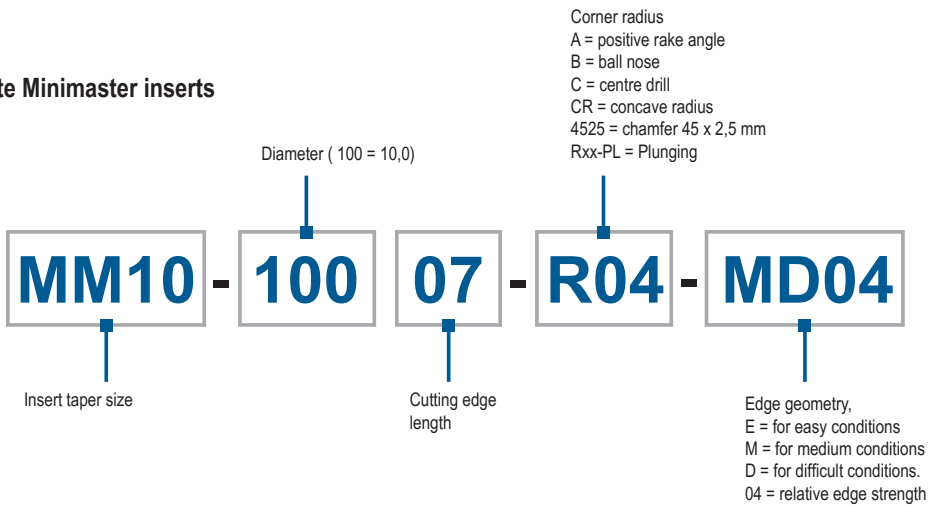

Note that parts of the code can vary for different types of insert or shanks

Internal through coolant



- Universal
- Steel and cast iron
- Stainless steel and S-materials
- Stainless steel and S-materials
- Non ferrous
- Hard
- Graphite
- X-Heads
- Minimaster Plus
- Minimaster

Mounting instructions for 2-flute Minimaster

Torque wrench	
<p>Sleeve Shank Tension screw Insert</p>	<p>The sleeve must be securely tightened in the shank before the tension screw and insert are fitted. If the wrench cannot be used for changing the insert (If the insert has broken off or jammed in the shank) , the sleeve can be released, which will also release the insert. Use Allen key (turn it anti-clockwise) to back off the sleeve until the insert is free. Re-tighten the sleeve in the shank before fitting the tension screw and the new insert. For 3-flute Minimaster another key (MM0416) must be used (Key grip on hexagonal part of the insert.)</p>
	<p>Make sure that the wrench is used correctly</p>
	<p>If the wrench is used on the wrong side, it will cause damage</p>
	<p>Do not use excessive force</p>
	<p>Normal hand-power is quite sufficient</p>

Universal

Steel and cast iron

Stainless steel and S-materials

Non ferrous

Hard

Plastic and CFRP

Graphite

X-Heads

Minimaster Plus

Minimaster

Selection guide

1. Select taper size

The design of the workpiece and the machining operations determines suitable taper size. Select the largest possible taper size for best strength and stability.

2. Select insert

- Use the tables beginning on page 722 to classify the workpiece material into a Seco material group.
- Look up the pages for the selected taper size and choose a suitable insert in the insert selection table.

3. Select shank

- Look up the pages for the selected taper size and choose a suitable shank in the tool data table.
- Always choose the shortest shank possible to achieve the best possible stability.

4. Select cutting data

- Cutting speed recommendations are found in the cutting data tables for each selected taper size. Cutting data recommendations are based on stable conditions and might therefore need to be adjusted depending on the stability in the application (tooling, machine & workpiece fixturing). General rule for max ap in slotting is $DC^{*0.3} = \text{Max APMXS}$. (See figure 1)
- Feed and cutting speed recommendations are found in the cutting data conversion table.
- Maximum RPM that for safety reasons should never be exceeded, are shown on page N/A.
- If the cutter is not fully engaged the feed per tooth and the cutting speed should be increased compared to the recommendations for a fully engaged cutter. The reason for that is to keep the average chip thickness and the working temperature in the cutting zone.
- Divide the radial depth of cut with the cutter diameter to get the actual cutter engagement percentage ($a_e/DC\%$), for ball nose cutters use the effective working diameter D_w instead of DC (See figure 2 & 6)
- Use the percentage to get a correct feed per tooth and cutting speed recommendation for the actual cutter engagement.

5. General



- When milling in corners and bottoms of cavities the feed rate should be reduced due to the increase of the average chip thickness. Use the feed per tooth recommendations for a fully engaged cutter.
- When steep down copying with an angle bigger than 40° or steep up copying with an angle bigger than 30° in combination with small depths of cut, use the diameter (DC) as working diameter instead of D_w .
- When calculating feed per revolution and feed speed, always use the ZAFP-value. That is the effective number of teeth to use for cutting data calculations. The ZAFP-value can be found in the insert selection table.

Note! There will be a deterioration in the surface finish on the workpiece when the feed rate is increased. (See figure 3 & 5)

Minimaster figures

Universal	Figure 1	Figure 2
Steel and cast iron		
Stainless steel and S-materials	Figure 3	Figure 4
Non ferrous		
Hard	Figure 5	Figure 6
Plastic and cfrp		
Graphite		
X-Heads		
Minimaster Plus		
Minimaster		

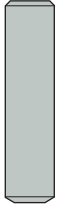
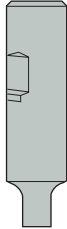
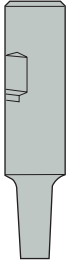
Shank design

Design 1, Keyway shank	Design 2, Cylindrical/Weldon back end and 90° front
	
Design 3, Cylindrical/Weldon back end tapered front 87°/89°	Design 4, Cylindrical/Weldon back end tapered front 80°/85°/87°
	
Design 5, Cylindrical back end double tapered front end 89°/85°	
	

Universal
Steel and cast iron
Stainless steel and S-materials
Stainless steel and S-materials
Non ferrous
Hard
Graphite
X-Heads
Minimaster Plus
Minimaster

MM06 Shank – Metric

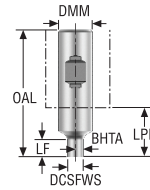

Designation	Item number	Type of mounting	DCSFWS	DMM	OAL	LF	LPR	BHTA°	Design		RPMX	Weight	Spare part no.
												mm	
MM06-12070.3-0005	75080695	Weldon	5,75	12,0	70,0	5,0	25,0	0,0	2	✓	80000	0,1	1
MM06-16075.3-3009	75080696	Weldon	5,75	16,0	75,0	9,0	27,0	3,0	3	✓	80000	0,1	1
MM06-16110.3-5058	75080697	Weldon	5,75	16,0	110,0	58,6	62,0	5,0	4	✓	80000	0,2	4
MM06-10040.0-0007	00094747	Cylindrical	5,75	10,0	40,0	7,0	7,0	0,0	2	✓	80000	0,1	2
MM06-12065.0-0000	75080694	Cylindrical	5,7	12,0	65,0	0,0	15,0	60,0	1	✓	80000	0,1	1
MM06-16140.0-1020M	00027102	Cylindrical	5,75	16,0	140,0	20,0	92,0	1,0	3	✓	80000	0,2	5
MM06-16140.0-1035M	00027103	Cylindrical	5,75	16,0	140,0	35,0	92,0	1,0	3	✓	80000	0,2	6
MM06-16140.0-1050M	00094748	Cylindrical	5,75	16,0	140,0	50,0	92,0	1,0	3	✓	80000	0,2	6
MM06-10050.0-0007DS	02580666	Cylindrical	5,75	10,0	50,0	7,0	7,0	0,0	2	✓	80000	0,1	3
MM06-10075.0-3041DS	02580701	Cylindrical	5,75	10,0	75,0	40,5	35,0	3,0	4	✓	80000	0,1	3
MM06-10100.0-1035DS	02580713	Cylindrical	5,75	10,0	100,0	35,0	60,0	1,0	3	✓	80000	0,1	3
MM06-12120.0-1050DS	02580714	Cylindrical	5,75	12,0	120,0	50,0	75,0	1,0	3	✓	80000	0,2	3
MM06-16090.0-0012DS	02580670	Cylindrical	5,75	16,0	90,0	12,0	42,0	0,0	2	✓	80000	0,3	3
MM06-16095.0-0024DS	02580673	Cylindrical	5,75	16,0	95,0	24,0	47,0	0,0	2	✓	80000	0,3	3
MM06-16140.0-1050DS	02580717	Cylindrical	5,75	16,0	140,0	50,0	92,0	1,0	3	✓	80000	0,3	3
MM06-16140.0-1035DS	02580716	Cylindrical	5,75	16,0	140,0	35,0	92,0	1,0	3	✓	80000	0,4	3
MM06-20250.0-1035DS	02580718	Cylindrical	5,75	20,0	250,0	35,0	190,0	1,0	5	✓	80000	1,0	3

Spare Parts, included in delivery

Accessories

For cutter	Sleeve	Tension screw	Sleeve key
1	MM-035046	MM06-03518	H05-4
4	MM-035091	MM06-03518	H05-4
2	MM-035023	MM06-03518	H05-4
5	MM-035046	MM06-03544	H05-4
6	MM-035046	MM06-03564	H05-4
3	-	MM06-03518	-

MM06 Shank – Inch

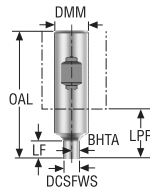

Designation	Item number	Type of mounting	DCSFWS	DMM	OAL	LF	LPR	BHTA°	Design		RPMX	Weight	Spare part no.
			inch	inch	inch	inch	inch					lbs	
MM06-0.50-2.8-3-0002	00096108	Weldon	0.224	0.500	2.756	0.197	0.984	0,0	2	✓	80000	0.220	1
MM06-0.62-3.0-3-3003	00096116	Weldon	0.224	0.625	2.953	0.354	1.063	3,0	1	✓	80000	0.220	1
MM06-0.62-4.3-3-5022	00096117	Weldon	0.224	0.625	4.331	2.291	2.441	5,0	2	✓	80000	0.440	4
MM06-0.38-1.6-0-0002	00096107	Cylindrical	0.224	0.375	1.575	0.276	0.276	0,0	2	✓	80000	0.220	2
MM06-0.50-2.6-0-0000	00096106	Cylindrical	0.224	0.500	2.559	0	0.787	60,0	1	✓	80000	0.220	1
MM06-0.62-5.5-0-1007	00096111	Cylindrical	0.224	0.625	5.512	0.787	3.622	1,0	3	✓	80000	0.440	5
MM06-0.62-5.5-0-1013	00096112	Cylindrical	0.224	0.625	5.512	1.378	3.622	1,0	3	✓	80000	0.440	6
MM06-0.62-5.5-0-1019	00096114	Cylindrical	0.224	0.625	5.512	1.969	3.622	1,0	3	✓	80000	0.440	6
MM06-0.62-3.5-0-0004DS	02593394	Cylindrical	0.224	0.625	3.543	0.472	1.654	0,0	2	✓	80000	0.660	3
MM06-0.62-3.7-0-0009DS	02593395	Cylindrical	0.224	0.625	3.740	0.945	1.850	0,0	2	✓	80000	0.660	3
MM06-0.62-5.5-0-1013DS	02593396	Cylindrical	0.224	0.625	5.512	1.378	3.622	1,0	3	✓	80000	0.880	3
MM06-0.62-5.5-0-1019DS	02593397	Cylindrical	0.224	0.625	5.512	1.969	3.622	1,0	3	✓	80000	0.660	3
MM06-0.75-10.0-0-1013DS	02593399	Cylindrical	0.224	0.750	9.843	1.378	7.874	1,0	5	✓	80000	1.980	3

Spare Parts, included in delivery

Accessories

For cutter	Sleeve	Tension screw	Sleeve key
1	MM-035046	MM06-03518	H05-4
4	MM-035091	MM06-03518	H05-4
2	MM-035023	MM06-03518	H05-4
5	MM-035046	MM06-03544	H05-4
6	MM-035046	MM06-03564	H05-4
3	–	MM06-03518	–

Universal

Steel and cast iron

Stainless steel and S-materials

Stainless steel and S-materials

Non ferrous

Hard

Graphite

X-Heads

Minimaster Plus

Minimaster

Slot milling/square shoulder milling

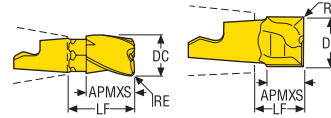

• For Torque keys and torque values, see page 720

Designation	DC	APMXS	RE	LF	RMPX°	C min	C max	FHA°	ZEPF	Wrench	Grades			
											Coated			
	mm Inch	mm Inch	mm Inch	mm Inch							T60M	F15M	F30M	F40M
MM06-05804T-R02-D02	5,8 0.228	4,1 0.161	0,2 0.008	5,1 0.201	15,0	7,2	11,0	0	2		■			
MM06-05807-R02A30-M02	5,8 0.228	7,5 0.295	0,2 0.008	9,9 0.390	15,0	7,2	11,0	30	3					■
MM06-06004-M02	6,0 0.236	4,1 0.161	0,0 -	5,1 0.201	15,0	7,4	11,8	0	2		■			
MM06-06004-R04-MD02	6,0 0.236	4,1 0.161	0,4 0.016	5,1 0.201	15,0	7,4	11,0	0	2		■		■	
MM06-06004-R10-MD02	6,0 0.236	4,1 0.161	1,0 0.039	5,1 0.201	15,0	7,4	9,8	0	2				■	
MM06-06007-A30-E02	6,0 0.236	7,5 0.295	0,0 -	9,9 0.390	15,0	7,4	11,8	30	3				■	
MM06-06007-R05A30-M02	6,0 0.236	7,5 0.295	0,5 0.020	9,9 0.390	15,0	7,4	10,8	30	3					■
MM06-06007-R10A30-D02	6,0 0.236	7,5 0.295	1,0 0.039	9,9 0.390	15,0	7,4	9,8	30	3				■	
MM06-06007-R10A30-E02	6,0 0.236	7,5 0.295	1,0 0.039	9,9 0.390	15,0	7,4	9,8	30	3				■	
MM06-06007-R10A30-M02	6,0 0.236	7,5 0.295	1,0 0.039	9,9 0.390	15,0	7,4	9,8	30	3					■
MM06-06007-R20A30-M02	6,0 0.236	7,5 0.295	2,0 0.079	9,9 0.390	15,0	7,4	7,8	30	3					■
MM06-06407-A30-E02	6,35 0.250	7,5 0.295	0,0 -	9,9 0.390	15,0	7,8	12,5	30	3				■	
MM06-06407-R04A30-M02	6,35 0.250	7,5 0.295	0,4 0.016	9,9 0.390	15,0	7,8	11,7	30	3					■
MM06-06407-R08A30-M02	6,35 0.250	7,5 0.295	0,8 0.031	9,9 0.390	15,0	7,8	10,9	30	3					■

Universal

Steel and cast iron

Stainless steel
and S-materials

Non ferrous

Hard

Plastic and cfrp

Graphite

X-Heads



Minimaster Plus

Minimaster

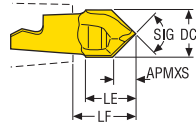
Centre drilling





• For Torque keys and torque values, see page 720

Designation	DC	APMXS	LE	LF	SIG°	ZEFP	Wrench 	Grades			
								Coated			
								T60M	F15M	F30M	F40M
MM06-06003-C120-M02	6,0 0.236	1,6 0.063	6,27 0.247	7,19 0.283	120,0	2		<input checked="" type="checkbox"/>			
MM06-06003-C90-M02	6,0 0.236	2,86 0.113	6,0 0.236	7,12 0.280	90,0	2		<input checked="" type="checkbox"/>			

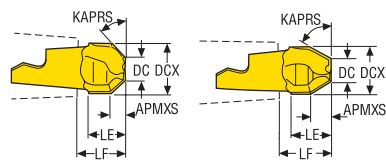
Chamfering



• For Torque keys and torque values, see page 720

Designation	DCX	DC	APMXS	LE	LF	KAPRS°	ZEFP	Wrench 	Grades			
									Coated			
									T60M	F15M	F30M	F40M
MM06-06004-4515-E02	6,0 0.236	1,8 0.071	2,1 0.083	4,0 0.157	5,1 0.201	45,0	2		<input checked="" type="checkbox"/>			
MM06-06004-6015-E02	6,0 0.236	3,14 0.124	2,4 0.094	4,6 0.181	5,75 0.226	60,0	2		<input checked="" type="checkbox"/>			

Universal

Steel and cast iron

Stainless steel and S-materials

Stainless steel and S-materials

Non ferrous

Hard

Graphite

X-Heads

Minimaster Plus

Minimaster

Double chamfering

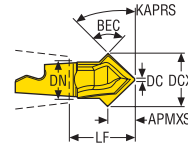

• For Torque keys and torque values, see page 720

Designation	DCX	DC	APMXS	LF	DN	BEC°	KAPRS°	ZFP	Wrench	Grades			
										T60M	F15M	F30M	F40M
MM06-08008-D4510P-M02	8,0 0.315	0,6 0.024	3,7 0.146	8,5 0.335	6,0 0.236	90,0	45,0	2		■			

Plunge milling

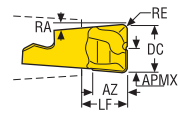

• For Torque keys and torque values, see page 720

Designation	DC	APMXE	RE	AZ	LF	RA°	ZFP	Wrench	Grades			
									T60M	F15M	F30M	F40M
MM06-06004-R10-PL-MD02	6,0 0.236	3,0 0.118	1,0 0.039	4,3 0.169	5,08 0.200	5,0	2			■		

Universal

Steel and cast iron

Stainless steel and S-materials

Non ferrous

Hard

Plastic and CFRP

Graphite

X-Heads

Minimaster Plus

Minimaster

Precision inserts for semi-finishing in all materials

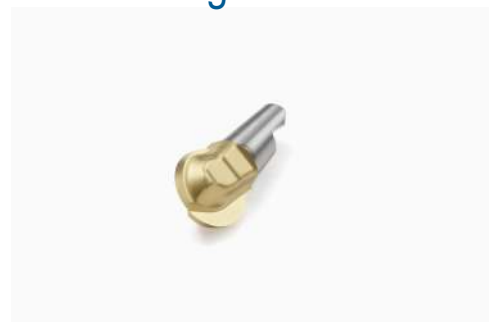
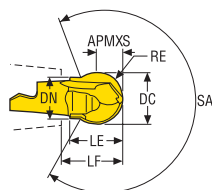

• For Torque keys and torque values, see page 720

Designation	DC	APMXS	RE	LE	LF	DN	SA°	ZAFP	Wrench	Grades			
										T60M	F15M	F30M	F40M
MM06-08008-B120PF-M01	8,0 0.315	4,0 0.157	4,0 0.157	8,0 0.315	8,73 0.344	6,0 0.236	263,0	2		■			
MM06-08008-B120P-M03	8,0 0.315	4,0 0.157	4,0 0.157	8,0 0.315	8,73 0.344	6,0 0.236	263,0	2			■		

Copy milling

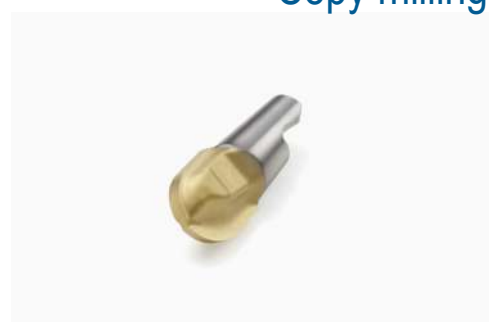
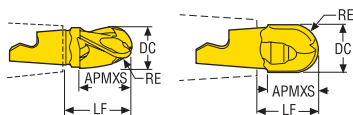

• For Torque keys and torque values, see page 720

Designation	DC	APMXS	RE	LF	FHA°	ZAFP	Wrench	Grades			
								T60M	F15M	F30M	F40M
MM06-06006-B90-MD02	6,0 0.236	6,1 0.240	3,0 0.118	7,06 0.278	0,0	2		■		■	
MM06-06006-B90PF-M01	6,0 0.236	5,2 0.205	3,0 0.118	7,04 0.277	0,0	2			■		
MM06-06006-B90P-M02	6,0 0.236	5,2 0.205	3,0 0.118	7,04 0.277	0,0	2				■	
MM06-06006-B90S-E02	6,0 0.236	6,1 0.240	3,0 0.118	7,06 0.278	0,0	2				■	
MM06-06007-B90A30-E02	6,0 0.236	7,4 0.291	3,0 0.118	9,85 0.388	30,0	3				■	
MM06-06007-B90A30-M02	6,0 0.236	7,4 0.291	3,0 0.118	9,85 0.388	30,0	3					■
MM06-06406-B90P-M02	6,35 0.250	5,4 0.213	3,175 0.125	7,22 0.284	0,0	2				■	
MM06-06406-B90S-E02	6,35 0.250	6,3 0.248	3,175 0.125	7,24 0.285	0,0	2				■	

Universal

Steel and cast iron

Stainless steel and S-materials

Stainless steel and S-materials

Non ferrous

Hard

Graphite

X-Heads

Minimaster Plus

Minimaster

MM06 - Slot and Side milling – Insert selection – Metric / Inch

SMG		a _p	f _z			
			100%	40%	20%	10%
P1	MM06-06007-R05A30-M02 F40M	1,3	0,030	0,030	0,036	0,048
		0,050	0,0012	0,0012	0,0014	0,0019
P2	MM06-06007-R05A30-M02 F40M	1,3	0,030	0,030	0,036	0,048
		0,050	0,0012	0,0012	0,0014	0,0019
P3	MM06-06007-R05A30-M02 F40M	1,3	0,028	0,028	0,034	0,046
		0,050	0,0011	0,0011	0,0013	0,0018
P4	MM06-06007-R05A30-M02 F40M	1,3	0,028	0,028	0,034	0,044
		0,050	0,0011	0,0011	0,0013	0,0017
P5	MM06-06007-R05A30-M02 F40M	1,3	0,028	0,028	0,032	0,044
		0,050	0,0011	0,0011	0,0013	0,0017
P6	MM06-06007-R05A30-M02 F40M	1,3	0,028	0,028	0,032	0,044
		0,050	0,0011	0,0011	0,0013	0,0017
P7	MM06-06007-R05A30-M02 F40M	1,3	0,028	0,028	0,032	0,044
		0,050	0,0011	0,0011	0,0013	0,0017
P8	MM06-06007-R05A30-M02 F40M	1,3	0,028	0,028	0,034	0,046
		0,050	0,0011	0,0011	0,0013	0,0018
P11	MM06-06007-R05A30-M02 F40M	1,3	0,028	0,028	0,032	0,044
		0,050	0,0011	0,0011	0,0013	0,0017
P12	MM06-06007-R05A30-M02 F40M	1,0	0,020	0,020	0,022	0,030
		0,040	0,00080	0,00080	0,00085	0,0012
M1	MM06-06007-R05A30-M02 F40M	1,3	0,030	0,030	0,036	0,048
		0,050	0,0012	0,0012	0,0014	0,0019
M2	MM06-06007-R05A30-M02 F40M	1,3	0,028	0,028	0,032	0,044
		0,050	0,0011	0,0011	0,0013	0,0017
M3	MM06-06007-R05A30-M02 F40M	1,0	0,024	0,024	0,026	0,036
		0,040	0,00095	0,00095	0,0010	0,0014
M4	MM06-06007-R05A30-M02 F40M	0,80	0,022	0,020	0,024	0,030
		0,032	0,00085	0,00080	0,00095	0,0012
M5	MM06-06007-R05A30-M02 F40M	0,80	0,022	0,020	0,024	0,030
		0,032	0,00085	0,00080	0,00095	0,0012
K1	MM06-06007-R10A30-D02 F30M	1,3	0,036	0,034	0,038	0,050
		0,050	0,0014	0,0013	0,0015	0,0020
K2	MM06-06007-R10A30-D02 F30M	1,3	0,032	0,032	0,034	0,044
		0,050	0,0013	0,0013	0,0013	0,0017
K3	MM06-06007-R10A30-D02 F30M	1,3	0,032	0,032	0,034	0,044
		0,050	0,0013	0,0013	0,0013	0,0017
K4	MM06-06007-R10A30-D02 F30M	1,3	0,032	0,032	0,034	0,044
		0,050	0,0013	0,0013	0,0013	0,0017
K5	MM06-06007-R10A30-D02 F30M	1,3	0,030	0,028	0,030	0,040
		0,050	0,0012	0,0011	0,0012	0,0016
K6	MM06-06007-R10A30-D02 F30M	1,3	0,032	0,032	0,034	0,044
		0,050	0,0013	0,0013	0,0013	0,0017
K7	MM06-06007-R10A30-D02 F30M	1,3	0,030	0,028	0,030	0,040
		0,050	0,0012	0,0011	0,0012	0,0016
N1	MM06-06007-R10A30-E02 F30M	1,3	0,046	0,044	0,048	0,065
		0,050	0,0018	0,0017	0,0019	0,0026
N2	MM06-06007-R10A30-E02 F30M	1,3	0,046	0,044	0,048	0,065
		0,050	0,0018	0,0017	0,0019	0,0026
N3	MM06-06007-R10A30-E02 F30M	1,3	0,046	0,044	0,048	0,065
		0,050	0,0018	0,0017	0,0019	0,0026
N11	MM06-06007-R10A30-E02 F30M	1,3	0,046	0,044	0,048	0,065
		0,050	0,0018	0,0017	0,0019	0,0026
S1	MM06-06007-R10A30-D02 F30M	0,80	0,028	0,026	0,025	0,032
		0,032	0,0011	0,0010	0,0010	0,0013
S2	MM06-06007-R10A30-D02 F30M	0,80	0,028	0,026	0,025	0,032
		0,032	0,0011	0,0010	0,0010	0,0013
S3	MM06-06007-R10A30-D02 F30M	0,80	0,026	0,025	0,024	0,028
		0,032	0,0010	0,0010	0,00095	0,0012
S11	MM06-06007-R05A30-M02 F40M	0,90	0,024	0,024	0,026	0,036
		0,036	0,00095	0,00095	0,0010	0,0014
S12	MM06-06007-R05A30-M02 F40M	0,90	0,024	0,024	0,026	0,036
		0,036	0,00095	0,00095	0,0010	0,0014
S13	MM06-06007-R05A30-M02 F40M	0,80	0,022	0,020	0,024	0,030
		0,032	0,00085	0,00080	0,00095	0,0012
H5	MM06-06007-R10A30-D02 F30M	1,0	0,025	0,024	0,024	0,030
		0,040	0,0010	0,00095	0,00095	0,0012
H8	MM06-06007-R10A30-D02 F30M	0,90	0,020	0,019	0,018	0,024
		0,036	0,00080	0,00075	0,00070	0,00095
H11	MM06-06007-R10A30-D02 F30M	1,0	0,025	0,024	0,024	0,030
		0,040	0,0010	0,00095	0,00095	0,0012
H12	MM06-06007-R10A30-D02 F30M	0,90	0,020	0,019	0,018	0,024
		0,036	0,00080	0,00075	0,00070	0,00095
H21	MM06-06007-R10A30-D02 F30M	0,90	0,020	0,019	0,018	0,024
		0,036	0,00080	0,00075	0,00070	0,00095

SMG = Seco material group
f_z = mm/tooth (in/tooth), v_c = m/min (sf/min), a_p/DC = %
All cutting data are start values

MM06 - Slot and Side milling – Cutting data $v_c = (m/min)/(sf/min)$

SMG	F30M				F40M				T60M			
	100%	40%	20%	10%	100%	40%	20%	10%	100%	40%	20%	10%
P1	280	350	395	435	270	335	375	415	220	270	300	330
	920	1150	1300	1425	890	1100	1225	1350	720	890	980	1075
P2	275	340	380	420	260	325	365	400	210	260	295	320
	900	1125	1250	1375	850	1075	1200	1300	690	850	970	1050
P3	240	295	330	365	225	285	315	350	185	230	255	280
	790	970	1075	1200	740	940	1025	1150	610	750	840	920
P4	210	260	295	320	200	250	280	305	160	200	225	245
	690	850	970	1050	660	820	920	1000	520	660	740	800
P5	200	250	280	310	190	240	265	295	155	190	215	235
	660	820	920	1025	620	790	870	970	510	620	710	770
P6	225	285	315	345	215	270	300	330	175	215	240	265
	740	940	1025	1125	710	890	980	1075	570	710	790	870
P7	215	265	295	325	205	255	285	310	165	205	230	250
	710	870	970	1075	670	840	940	1025	540	670	750	820
P8	200	250	280	305	190	240	265	290	155	190	215	235
	660	820	920	1000	620	790	870	950	510	620	710	770
P11	210	260	290	320	200	245	275	305	160	200	220	245
	690	850	950	1050	660	800	900	1000	520	660	720	800
P12	130	160	175	195	125	150	170	185	100	125	135	150
	425	520	570	640	410	490	560	610	330	410	445	490
M1	—	—	—	—	210	265	295	320	170	210	235	260
	—	—	—	—	690	870	970	1050	560	690	770	850
M2	—	—	—	—	175	215	240	265	140	170	195	210
	—	—	—	—	570	710	790	870	460	560	640	690
M3	—	—	—	—	135	165	190	205	110	135	150	165
	—	—	—	—	445	540	620	670	360	445	490	540
M4	—	—	—	—	105	130	145	155	85	105	115	125
	—	—	—	—	345	425	475	510	280	345	375	410
M5	—	—	—	—	85	105	120	130	70	85	95	105
	—	—	—	—	280	345	395	425	230	280	310	345
K1	215	270	305	335	205	260	290	315	165	210	230	255
	710	890	1000	1100	670	850	950	1025	540	690	750	840
K2	190	235	265	295	180	225	255	280	150	180	205	225
	620	770	870	970	590	740	840	920	490	590	670	740
K3	160	200	225	250	155	190	215	235	125	155	175	190
	520	660	740	820	510	620	710	770	410	510	570	620
K4	155	190	215	235	145	180	205	225	120	145	165	180
	510	620	710	770	475	590	670	740	395	475	540	590
K5	95	115	130	145	90	110	125	135	70	90	100	110
	310	375	425	475	295	360	410	445	230	295	330	360
K6	135	170	190	210	130	160	180	200	105	130	145	160
	445	560	620	690	425	520	590	660	345	425	475	520
K7	120	150	165	180	115	140	160	175	90	115	125	140
	395	490	540	590	375	460	520	570	295	375	410	460
N1	1650	2050	2325	2525	1575	1975	2200	2400	1275	1575	1775	1950
	5425	6725	7625	8275	5175	6475	7225	7875	4175	5175	5825	6400
N2	670	830	930	1025	640	790	890	970	510	640	710	790
	2200	2725	3050	3375	2100	2600	2925	3175	1675	2100	2325	2600
N3	445	560	620	680	425	530	590	650	340	425	475	530
	1450	1825	2025	2225	1400	1750	1925	2125	1125	1400	1550	1750
N11	510	630	710	780	485	600	680	740	390	485	540	600
	1675	2075	2325	2550	1600	1975	2225	2425	1275	1600	1775	1975
S1	50	65	70	75	49	60	65	75	39	49	55	60
	165	215	230	245	160	195	215	245	130	160	180	195
S2	41	50	55	60	39	48	55	60	32	39	44	48
	135	165	180	195	130	155	180	195	105	130	145	155
S3	36	44	49	55	34	42	47	50	27	34	38	41
	120	145	160	180	110	140	155	165	90	110	125	135
S11	—	—	—	—	70	85	95	105	55	70	75	85
	—	—	—	—	230	280	310	345	180	230	245	280
S12	—	—	—	—	48	60	65	70	38	48	55	60
	—	—	—	—	155	195	215	245	125	155	180	195
S13	—	—	—	—	27	34	38	41	22	27	30	33
	—	—	—	—	90	110	125	135	70	90	100	110
H5	43	55	60	65	41	50	55	60	33	41	45	50
	140	180	195	215	135	165	180	195	110	135	150	165
H8	44	55	60	65	42	50	60	65	34	42	47	50
	145	180	195	215	140	165	195	215	110	140	155	165
H11	55	65	75	85	50	65	70	80	42	50	60	65
	180	215	245	280	165	215	230	260	140	165	195	215
H12	80	95	110	120	75	90	105	115	60	75	85	90
	260	310	360	395	245	295	345	375	195	245	280	295
H21	44	55	60	65	42	50	60	65	34	42	47	50
	145	180	195	215	140	165	195	215	110	140	155	165

Universal
Steel and cast iron
Stainless steel and S-materials
Stainless steel and S-materials
Non ferrous
Hard
Graphite
X-Heads
Minimaster Plus
Minimaster

MM06 Z3-Copy milling – Insert selection – Roughing – mm/Inch

SMG		a_p		f_z			
				100%	40%	20%	10%
P1	MM06-06007-B90A30-M02 F40M	1,3	0,036	0,036	0,034	0,036	0,048
		0,050	0,0014	0,0013	0,0013	0,0014	0,0019
P2	MM06-06007-B90A30-M02 F40M	1,3	0,036	0,036	0,034	0,036	0,048
		0,050	0,0014	0,0013	0,0013	0,0014	0,0019
P3	MM06-06007-B90A30-M02 F40M	1,3	0,034	0,034	0,034	0,034	0,046
		0,050	0,0013	0,0013	0,0013	0,0013	0,0018
P4	MM06-06007-B90A30-M02 F40M	1,3	0,034	0,034	0,032	0,034	0,044
		0,050	0,0013	0,0013	0,0013	0,0013	0,0017
P5	MM06-06007-B90A30-M02 F40M	1,3	0,032	0,032	0,032	0,034	0,044
		0,050	0,0013	0,0013	0,0013	0,0013	0,0017
P6	MM06-06007-B90A30-M02 F40M	1,3	0,032	0,032	0,032	0,034	0,044
		0,050	0,0013	0,0013	0,0013	0,0013	0,0017
P7	MM06-06007-B90A30-M02 F40M	1,3	0,032	0,032	0,032	0,034	0,044
		0,050	0,0013	0,0013	0,0013	0,0013	0,0017
P8	MM06-06007-B90A30-M02 F40M	1,3	0,034	0,034	0,034	0,034	0,046
		0,050	0,0013	0,0013	0,0013	0,0013	0,0018
P11	MM06-06007-B90A30-M02 F40M	1,3	0,032	0,032	0,032	0,034	0,044
		0,050	0,0013	0,0013	0,0013	0,0013	0,0017
P12	MM06-06007-B90A30-M02 F40M	1,0	0,024	0,024	0,022	0,024	0,030
		0,040	0,00095	0,00085	0,00085	0,00095	0,0012
M1	MM06-06007-B90A30-M02 F40M	1,3	0,036	0,036	0,034	0,036	0,048
		0,050	0,0014	0,0013	0,0013	0,0014	0,0019
M2	MM06-06007-B90A30-M02 F40M	1,3	0,032	0,032	0,032	0,034	0,044
		0,050	0,0013	0,0013	0,0013	0,0013	0,0017
M3	MM06-06007-B90A30-M02 F40M	1,0	0,028	0,028	0,026	0,028	0,036
		0,040	0,0011	0,0010	0,0010	0,0011	0,0014
M4	MM06-06007-B90A30-M02 F40M	0,80	0,025	0,025	0,025	0,025	0,030
		0,032	0,0010	0,0010	0,0010	0,0010	0,0013
M5	MM06-06007-B90A30-M02 F40M	0,80	0,025	0,025	0,025	0,025	0,030
		0,032	0,0010	0,0010	0,0010	0,0010	0,0013
K1	MM06-06007-B90A30-E02 F30M	1,3	0,036	0,036	0,034	0,036	0,048
		0,050	0,0014	0,0013	0,0013	0,0014	0,0019
K2	MM06-06007-B90A30-E02 F30M	1,3	0,032	0,032	0,032	0,034	0,044
		0,050	0,0013	0,0013	0,0013	0,0013	0,0017
K3	MM06-06007-B90A30-E02 F30M	1,3	0,032	0,032	0,032	0,034	0,044
		0,050	0,0013	0,0013	0,0013	0,0013	0,0017
K4	MM06-06007-B90A30-E02 F30M	1,3	0,032	0,032	0,032	0,034	0,044
		0,050	0,0013	0,0013	0,0013	0,0013	0,0017
K5	MM06-06007-B90A30-M02 F40M	1,3	0,030	0,030	0,028	0,030	0,040
		0,050	0,0012	0,0011	0,0011	0,0012	0,0016
K6	MM06-06007-B90A30-M02 F40M	1,3	0,032	0,032	0,032	0,034	0,044
		0,050	0,0013	0,0013	0,0013	0,0013	0,0017
K7	MM06-06007-B90A30-M02 F40M	1,3	0,030	0,030	0,028	0,030	0,040
		0,050	0,0012	0,0011	0,0011	0,0012	0,0016
N1	MM06-06007-B90A30-E02 F30M	1,3	0,046	0,046	0,044	0,046	0,060
		0,050	0,0018	0,0017	0,0017	0,0018	0,0024
N2	MM06-06007-B90A30-E02 F30M	1,3	0,046	0,046	0,044	0,046	0,060
		0,050	0,0018	0,0017	0,0017	0,0018	0,0024
N3	MM06-06007-B90A30-E02 F30M	1,3	0,046	0,046	0,044	0,046	0,060
		0,050	0,0018	0,0017	0,0017	0,0018	0,0024
N11	MM06-06007-B90A30-E02 F30M	1,3	0,046	0,046	0,044	0,046	0,060
		0,050	0,0018	0,0017	0,0017	0,0018	0,0024
S1	MM06-06007-B90A30-M02 F40M	0,80	0,025	0,025	0,025	0,025	0,030
		0,032	0,0010	0,0010	0,0010	0,0010	0,0013
S2	MM06-06007-B90A30-M02 F40M	0,80	0,025	0,025	0,025	0,025	0,030
		0,032	0,0010	0,0010	0,0010	0,0010	0,0013
S3	MM06-06007-B90A30-M02 F40M	0,80	0,024	0,024	0,022	0,022	0,028
		0,032	0,00095	0,00085	0,00085	0,00085	0,0012
S11	MM06-06007-B90A30-M02 F40M	0,90	0,028	0,028	0,028	0,028	0,036
		0,036	0,0011	0,0011	0,0011	0,0011	0,0014
S12	MM06-06007-B90A30-M02 F40M	0,90	0,028	0,028	0,028	0,028	0,036
		0,036	0,0011	0,0011	0,0011	0,0011	0,0014
S13	MM06-06007-B90A30-M02 F40M	0,80	0,025	0,025	0,025	0,025	0,030
		0,032	0,0010	0,0010	0,0010	0,0010	0,0013
H5	MM06-06007-B90A30-E02 F30M	1,0	0,024	0,024	0,022	0,024	0,030
		0,040	0,00095	0,00085	0,00085	0,00095	0,0012
H8	MM06-06007-B90A30-E02 F30M	0,90	0,018	0,018	0,018	0,018	0,022
		0,036	0,00070	0,00070	0,00070	0,00070	0,00095
H11	MM06-06007-B90A30-E02 F30M	1,0	0,024	0,024	0,022	0,024	0,030
		0,040	0,00095	0,00085	0,00085	0,00095	0,0012
H12	MM06-06007-B90A30-E02 F30M	0,90	0,018	0,018	0,018	0,018	0,022
		0,036	0,00070	0,00070	0,00070	0,00070	0,00095
H21	MM06-06007-B90A30-E02 F30M	0,90	0,018	0,018	0,018	0,018	0,022
		0,036	0,00070	0,00070	0,00070	0,00070	0,00095

SMG = Seco material group
 f_z = mm/tooth (in/tooth), v_c = m/min (sf/min), a_p/DC = %
 All cutting data are start values

MM06 Z3-Copy milling – Insert selection – Finishing – mm/Inch

SMG		a _p	f _z			
			15%	10%	5%	2%
P1	MM06-06007-B90A30-E02 F30M	1,3	0,040	0,048	0,065	0,11
		0.050	0.0016	0.0019	0.0026	0.0044
P2	MM06-06007-B90A30-E02 F30M	1,3	0,040	0,048	0,065	0,11
		0.050	0.0016	0.0019	0.0026	0.0044
P3	MM06-06007-B90A30-E02 F30M	1,3	0,038	0,046	0,065	0,10
		0.050	0.0015	0.0018	0.0026	0.0040
P4	MM06-06007-B90A30-E02 F30M	1,3	0,038	0,044	0,060	0,10
		0.050	0.0015	0.0017	0.0024	0.0040
P5	MM06-06007-B90A30-E02 F30M	1,3	0,036	0,044	0,060	0,10
		0.050	0.0014	0.0017	0.0024	0.0040
P6	MM06-06007-B90A30-E02 F30M	1,3	0,036	0,044	0,060	0,10
		0.050	0.0014	0.0017	0.0024	0.0040
P7	MM06-06007-B90A30-E02 F30M	1,3	0,036	0,044	0,060	0,10
		0.050	0.0014	0.0017	0.0024	0.0040
P8	MM06-06007-B90A30-E02 F30M	1,3	0,038	0,046	0,065	0,10
		0.050	0.0015	0.0018	0.0026	0.0040
P11	MM06-06007-B90A30-E02 F30M	1,3	0,036	0,044	0,060	0,10
		0.050	0.0014	0.0017	0.0024	0.0040
P12	MM06-06007-B90A30-E02 F30M	1,0	0,026	0,030	0,042	0,065
		0.040	0.0010	0.0012	0.0017	0.0026
M1	MM06-06007-B90A30-E02 F30M	1,3	0,040	0,048	0,065	0,11
		0.050	0.0016	0.0019	0.0026	0.0044
M2	MM06-06007-B90A30-E02 F30M	1,3	0,036	0,044	0,060	0,10
		0.050	0.0014	0.0017	0.0024	0.0040
M3	MM06-06007-B90A30-E02 F30M	1,0	0,030	0,036	0,048	0,080
		0.040	0.0012	0.0014	0.0019	0.0032
M4	MM06-06007-B90A30-E02 F30M	0,80	0,026	0,030	0,042	0,070
		0.032	0.0010	0.0013	0.0017	0.0028
M5	MM06-06007-B90A30-E02 F30M	0,80	0,026	0,030	0,042	0,070
		0.032	0.0010	0.0013	0.0017	0.0028
K1	MM06-06007-B90A30-E02 F30M	1,3	0,040	0,048	0,065	0,11
		0.050	0.0016	0.0019	0.0026	0.0044
K2	MM06-06007-B90A30-E02 F30M	1,3	0,036	0,044	0,060	0,10
		0.050	0.0014	0.0017	0.0024	0.0040
K3	MM06-06007-B90A30-E02 F30M	1,3	0,036	0,044	0,060	0,10
		0.050	0.0014	0.0017	0.0024	0.0040
K4	MM06-06007-B90A30-E02 F30M	1,3	0,036	0,044	0,060	0,10
		0.050	0.0014	0.0017	0.0024	0.0040
K5	MM06-06007-B90A30-E02 F30M	1,3	0,034	0,040	0,055	0,090
		0.050	0.0013	0.0016	0.0022	0.0036
K6	MM06-06007-B90A30-E02 F30M	1,3	0,036	0,044	0,060	0,10
		0.050	0.0014	0.0017	0.0024	0.0040
K7	MM06-06007-B90A30-E02 F30M	1,3	0,034	0,040	0,055	0,090
		0.050	0.0013	0.0016	0.0022	0.0036
N1	MM06-06007-B90A30-E02 F30M	1,3	0,050	0,060	0,085	0,14
		0.050	0.0020	0.0024	0.0034	0.0055
N2	MM06-06007-B90A30-E02 F30M	1,3	0,050	0,060	0,085	0,14
		0.050	0.0020	0.0024	0.0034	0.0055
N3	MM06-06007-B90A30-E02 F30M	1,3	0,050	0,060	0,085	0,14
		0.050	0.0020	0.0024	0.0034	0.0055
N11	MM06-06007-B90A30-E02 F30M	1,3	0,050	0,060	0,085	0,14
		0.050	0.0020	0.0024	0.0034	0.0055
S1	MM06-06007-B90A30-E02 F30M	0,80	0,026	0,030	0,042	0,070
		0.032	0.0010	0.0013	0.0017	0.0028
S2	MM06-06007-B90A30-E02 F30M	0,80	0,026	0,030	0,042	0,070
		0.032	0.0010	0.0013	0.0017	0.0028
S3	MM06-06007-B90A30-E02 F30M	0,80	0,025	0,028	0,040	0,065
		0.032	0.0010	0.0012	0.0016	0.0026
S11	MM06-06007-B90A30-E02 F30M	0,90	0,030	0,036	0,048	0,080
		0.036	0.0012	0.0014	0.0019	0.0032
S12	MM06-06007-B90A30-E02 F30M	0,90	0,030	0,036	0,048	0,080
		0.036	0.0012	0.0014	0.0019	0.0032
S13	MM06-06007-B90A30-E02 F30M	0,80	0,026	0,030	0,042	0,070
		0.032	0.0010	0.0013	0.0017	0.0028
H5	MM06-06007-B90A30-E02 F30M	1,0	0,026	0,030	0,042	0,065
		0.040	0.0010	0.0012	0.0017	0.0026
H8	MM06-06007-B90A30-E02 F30M	0,90	0,020	0,022	0,032	0,050
		0.036	0.00080	0.00095	0.0013	0.0020
H11	MM06-06007-B90A30-E02 F30M	1,0	0,026	0,030	0,042	0,065
		0.040	0.0010	0.0012	0.0017	0.0026
H12	MM06-06007-B90A30-E02 F30M	0,90	0,020	0,022	0,032	0,050
		0.036	0.00080	0.00095	0.0013	0.0020
H21	MM06-06007-B90A30-E02 F30M	0,90	0,020	0,022	0,032	0,050
		0.036	0.00080	0.00095	0.0013	0.0020

SMG = Seco material group
 f_z = mm/tooth (in/tooth), v_c = m/min (sf/min), a_p/DC = %
 All cutting data are start values

Universal
 Steel and cast iron
 Stainless steel and S-materials
 Stainless steel and S-materials
 Non ferrous
 Hard
 Graphite
 X-Heads
 Minimaster Plus
 Minimaster

MM06 Z3-Copy milling – Cutting data $v_c = (m/min)/(sf/min)$

SMG	F30M					F40M				
	100%	20%	10%	5%	2%	100%	20%	10%	5%	2%
P1	295	350	370	405	400	280	330	355	385	380
	970	1150	1225	1325	1300	920	1075	1175	1275	1250
P2	285	340	360	395	390	275	325	345	375	370
	940	1125	1175	1300	1275	900	1075	1125	1225	1225
P3	250	295	315	340	340	235	280	300	320	325
	820	970	1025	1125	1125	770	920	980	1050	1075
P4	220	260	275	300	300	210	245	265	285	285
	720	850	900	980	980	690	800	870	940	940
P5	210	245	265	285	285	200	235	250	275	270
	690	800	870	940	940	660	770	820	900	890
P6	235	275	295	320	320	225	265	285	305	305
	770	900	970	1050	1050	740	870	940	1000	1000
P7	225	260	280	305	300	210	250	265	290	285
	740	850	920	1000	980	690	820	870	950	940
P8	210	245	265	285	285	200	235	250	270	270
	690	800	870	940	940	660	770	820	890	890
P11	215	255	270	295	295	205	240	260	280	280
	710	840	890	970	970	670	790	850	920	920
P12	135	160	165	180	180	125	150	160	170	170
	445	520	560	590	590	410	490	520	560	560
M1	230	275	290	315	315	220	260	280	300	300
	750	900	950	1025	1025	720	850	920	980	980
M2	190	220	240	260	255	180	210	225	245	245
	620	720	790	850	840	590	690	740	800	800
M3	150	180	185	200	200	140	170	175	190	190
	490	590	610	660	660	460	560	590	620	620
M4	105	145	140	150	150	100	135	135	145	145
	345	475	490	490	490	330	445	460	475	475
M5	85	120	115	125	125	85	115	110	120	120
	280	395	410	410	410	280	375	395	395	395
K1	230	270	285	310	310	215	255	275	295	295
	750	890	940	1025	1025	710	840	900	970	970
K2	200	235	250	270	270	190	225	240	260	255
	660	770	820	890	890	620	740	790	850	840
K3	170	200	210	230	230	160	190	200	220	220
	560	660	690	750	750	520	620	660	720	720
K4	160	190	205	220	220	155	180	195	210	210
	520	620	670	720	720	510	590	640	690	690
K5	95	115	120	130	130	90	110	115	125	125
	310	375	395	425	425	295	360	375	410	410
K6	140	165	180	195	190	135	160	170	185	185
	460	540	590	640	620	445	520	560	610	610
K7	125	145	155	170	170	120	140	150	160	160
	410	475	510	560	560	395	460	490	520	520
N1	1750	2075	2200	2375	2375	1675	1975	2100	2275	2250
	5750	6800	7225	7800	7800	5500	6475	6900	7475	7375
N2	710	830	890	960	950	670	790	850	920	910
	2325	2725	2925	3150	3125	2200	2600	2800	3025	2975
N3	470	560	590	640	640	450	530	570	610	610
	1550	1825	1925	2100	2100	1475	1750	1875	2000	2000
N11	540	630	680	730	730	510	600	650	700	690
	1775	2075	2225	2400	2400	1675	1975	2125	2300	2275
S1	49	65	65	70	70	46	65	65	70	65
	160	215	230	230	230	150	215	215	230	215
S2	39	55	55	55	55	37	50	50	55	55
	130	180	180	180	180	120	165	180	180	180
S3	34	47	46	50	49	32	44	44	47	47
	110	155	155	165	160	105	145	150	155	155
S11	75	95	95	100	100	70	90	90	95	95
	245	310	310	330	330	230	295	295	310	310
S12	50	65	65	70	70	48	60	60	65	65
	165	215	215	230	230	155	195	215	215	215
S13	27	38	37	40	40	26	36	35	38	38
	90	125	130	130	130	85	120	120	125	125
H5	44	55	55	60	60	42	50	55	55	55
	145	180	180	195	195	140	165	180	180	180
H8	44	55	55	60	60	42	55	55	60	60
	145	180	195	195	195	140	180	180	195	195
H11	55	70	70	75	75	55	65	65	70	75
	180	230	230	245	245	180	215	230	230	245
H12	80	100	100	110	110	75	95	95	105	105
	260	330	345	360	360	245	310	330	345	345
H21	44	55	55	60	60	42	55	55	60	60
	145	180	195	195	195	140	180	180	195	195

MM06 Z2-Copy milling – Insert selection – Roughing – mm/Inch

SMG		a _p	f _z			
			100%	40%	20%	10%
P1	MM06-06006-B90S-E02 F30M	2,5	0,030	0,032	0,036	0,048
		0.10	0.0012	0.0013	0.0014	0.0019
P2	MM06-06006-B90S-E02 F30M	2,5	0,032	0,032	0,036	0,048
		0.10	0.0013	0.0013	0.0014	0.0019
P3	MM06-06006-B90S-E02 F30M	2,5	0,030	0,030	0,034	0,046
		0.10	0.0012	0.0012	0.0013	0.0018
P4	MM06-06006-B90-MD02 F30M	2,5	0,030	0,030	0,034	0,044
		0.10	0.0012	0.0012	0.0013	0.0017
P5	MM06-06006-B90-MD02 F30M	2,5	0,028	0,028	0,034	0,044
		0.10	0.0011	0.0011	0.0013	0.0017
P6	MM06-06006-B90-MD02 F30M	2,5	0,028	0,028	0,032	0,044
		0.10	0.0011	0.0011	0.0013	0.0017
P7	MM06-06006-B90-MD02 F30M	2,5	0,028	0,028	0,032	0,044
		0.10	0.0011	0.0011	0.0013	0.0017
P8	MM06-06006-B90-MD02 F30M	2,5	0,030	0,030	0,034	0,046
		0.10	0.0012	0.0012	0.0013	0.0018
P11	MM06-06006-B90-MD02 F30M	2,5	0,028	0,028	0,032	0,044
		0.10	0.0011	0.0011	0.0013	0.0017
P12	MM06-06006-B90-MD02 F30M	2,0	0,020	0,020	0,024	0,030
		0.080	0.00080	0.00080	0.00095	0.0012
M1	MM06-06006-B90S-E02 F30M	2,5	0,032	0,032	0,036	0,048
		0.10	0.0013	0.0013	0.0014	0.0019
M2	MM06-06006-B90S-E02 F30M	2,5	0,028	0,028	0,034	0,044
		0.10	0.0011	0.0011	0.0013	0.0017
M3	MM06-06006-B90S-E02 F30M	2,0	0,024	0,024	0,028	0,036
		0.080	0.00095	0.00095	0.0011	0.0014
M4	MM06-06006-B90-MD02 F30M	1,5	0,022	0,022	0,024	0,030
		0.060	0.00085	0.00085	0.00095	0.0013
M5	MM06-06006-B90-MD02 F30M	1,5	0,022	0,022	0,024	0,030
		0.060	0.00085	0.00085	0.00095	0.0013
K1	MM06-06006-B90S-E02 F30M	2,5	0,032	0,032	0,036	0,048
		0.10	0.0013	0.0013	0.0014	0.0019
K2	MM06-06006-B90S-E02 F30M	2,5	0,028	0,028	0,034	0,044
		0.10	0.0011	0.0011	0.0013	0.0017
K3	MM06-06006-B90S-E02 F30M	2,5	0,028	0,028	0,034	0,044
		0.10	0.0011	0.0011	0.0013	0.0017
K4	MM06-06006-B90S-E02 F30M	2,5	0,028	0,028	0,034	0,044
		0.10	0.0011	0.0011	0.0013	0.0017
K5	MM06-06006-B90S-E02 F30M	2,5	0,026	0,026	0,030	0,040
		0.10	0.0010	0.0010	0.0012	0.0016
K6	MM06-06006-B90-MD02 F30M	2,5	0,028	0,028	0,034	0,044
		0.10	0.0011	0.0011	0.0013	0.0017
K7	MM06-06006-B90-MD02 F30M	2,5	0,026	0,026	0,030	0,040
		0.10	0.0010	0.0010	0.0012	0.0016
N1	MM06-06006-B90S-E02 F30M	2,5	0,040	0,040	0,046	0,060
		0.10	0.0016	0.0016	0.0018	0.0024
N2	MM06-06006-B90S-E02 F30M	2,5	0,040	0,040	0,046	0,060
		0.10	0.0016	0.0016	0.0018	0.0024
N3	MM06-06006-B90S-E02 F30M	2,5	0,040	0,040	0,046	0,060
		0.10	0.0016	0.0016	0.0018	0.0024
N11	MM06-06006-B90S-E02 F30M	2,5	0,040	0,040	0,046	0,060
		0.10	0.0016	0.0016	0.0018	0.0024
S1	MM06-06006-B90-MD02 F30M	1,5	0,022	0,022	0,024	0,030
		0.060	0.00085	0.00085	0.00095	0.0013
S2	MM06-06006-B90-MD02 F30M	1,5	0,022	0,022	0,024	0,030
		0.060	0.00085	0.00085	0.00095	0.0013
S3	MM06-06006-B90-MD02 F30M	1,5	0,020	0,020	0,022	0,028
		0.060	0.00080	0.00080	0.00085	0.0012
S11	MM06-06006-B90-MD02 F30M	1,7	0,025	0,024	0,028	0,036
		0.065	0.0010	0.00095	0.0011	0.0014
S12	MM06-06006-B90-MD02 F30M	1,7	0,025	0,024	0,028	0,036
		0.065	0.0010	0.00095	0.0011	0.0014
S13	MM06-06006-B90-MD02 F30M	1,5	0,022	0,022	0,024	0,030
		0.060	0.00085	0.00085	0.00095	0.0013
H5	MM06-06006-B90-MD02 F30M	2,0	0,020	0,020	0,024	0,030
		0.080	0.00080	0.00080	0.00095	0.0012
H8	MM06-06006-B90-MD02 F30M	1,7	0,016	0,016	0,018	0,022
		0.065	0.00065	0.00065	0.00070	0.00095
H11	MM06-06006-B90-MD02 F30M	2,0	0,020	0,020	0,024	0,030
		0.080	0.00080	0.00080	0.00095	0.0012
H12	MM06-06006-B90-MD02 F30M	1,7	0,016	0,016	0,018	0,022
		0.065	0.00065	0.00065	0.00070	0.00095
H21	MM06-06006-B90-MD02 F30M	1,7	0,016	0,016	0,018	0,022
		0.065	0.00065	0.00065	0.00070	0.00095

SMG = Seco material group
 f_z = mm/tooth (in/tooth), v_c = m/min (sf/min), a_p/DC = %
 All cutting data are start values

Universal
 Steel and cast iron
 Stainless steel and S-materials
 Stainless steel and S-materials
 Non ferrous
 Hard
 Graphite
 X-Heads
 Minimaster Plus
 Minimaster

MM06 Z2-Copy milling – Insert selection – Finishing – mm/Inch

SMG		a_p		f_z			
				15%	10%	5%	2%
P1	MM06-06006-B90PF-M01 F15M	2,0	0,020	0,024	0,034	0,055	
		0,080	0,00080	0,00095	0,0013	0,0022	
P2	MM06-06006-B90PF-M01 F15M	2,0	0,020	0,024	0,034	0,055	
		0,080	0,00080	0,00095	0,0013	0,0022	
P3	MM06-06006-B90PF-M01 F15M	2,0	0,020	0,024	0,032	0,050	
		0,080	0,00080	0,00095	0,0013	0,0020	
P4	MM06-06006-B90PF-M01 F15M	2,0	0,019	0,022	0,032	0,050	
		0,080	0,00075	0,00085	0,0013	0,0020	
P5	MM06-06006-B90PF-M01 F15M	2,0	0,019	0,022	0,030	0,048	
		0,080	0,00075	0,00085	0,0012	0,0019	
P6	MM06-06006-B90PF-M01 F15M	2,0	0,019	0,022	0,030	0,048	
		0,080	0,00075	0,00085	0,0012	0,0019	
P7	MM06-06006-B90PF-M01 F15M	2,0	0,019	0,022	0,030	0,048	
		0,080	0,00075	0,00085	0,0012	0,0019	
P8	MM06-06006-B90PF-M01 F15M	2,0	0,020	0,024	0,032	0,050	
		0,080	0,00080	0,00095	0,0013	0,0020	
P11	MM06-06006-B90PF-M01 F15M	2,0	0,019	0,022	0,030	0,048	
		0,080	0,00075	0,00085	0,0012	0,0019	
P12	MM06-06006-B90PF-M01 F15M	1,7	0,013	0,015	0,020	0,032	
		0,065	0,00050	0,00060	0,00080	0,0013	
M1	MM06-06006-B90PF-M01 F15M	2,0	0,020	0,024	0,034	0,055	
		0,080	0,00080	0,00095	0,0013	0,0022	
M2	MM06-06006-B90PF-M01 F15M	2,0	0,019	0,022	0,030	0,048	
		0,080	0,00075	0,00085	0,0012	0,0019	
M3	MM06-06006-B90PF-M01 F15M	1,7	0,015	0,018	0,025	0,038	
		0,065	0,00060	0,00070	0,0010	0,0015	
M4	MM06-06006-B90PF-M01 F15M	1,2	0,014	0,016	0,022	0,034	
		0,048	0,00055	0,00065	0,00085	0,0013	
M5	MM06-06006-B90PF-M01 F15M	1,2	0,014	0,016	0,022	0,034	
		0,048	0,00055	0,00065	0,00085	0,0013	
K1	MM06-06006-B90PF-M01 F15M	2,0	0,020	0,024	0,034	0,055	
		0,080	0,00080	0,00095	0,0013	0,0022	
K2	MM06-06006-B90PF-M01 F15M	2,0	0,019	0,022	0,030	0,048	
		0,080	0,00075	0,00085	0,0012	0,0019	
K3	MM06-06006-B90PF-M01 F15M	2,0	0,019	0,022	0,030	0,048	
		0,080	0,00075	0,00085	0,0012	0,0019	
K4	MM06-06006-B90PF-M01 F15M	2,0	0,019	0,022	0,030	0,048	
		0,080	0,00075	0,00085	0,0012	0,0019	
K5	MM06-06006-B90PF-M01 F15M	2,0	0,017	0,020	0,028	0,044	
		0,080	0,00065	0,00080	0,0011	0,0017	
K6	MM06-06006-B90PF-M01 F15M	2,0	0,019	0,022	0,030	0,048	
		0,080	0,00075	0,00085	0,0012	0,0019	
K7	MM06-06006-B90PF-M01 F15M	2,0	0,017	0,020	0,028	0,044	
		0,080	0,00065	0,00080	0,0011	0,0017	
N1	MM06-06006-B90PF-M01 F15M	2,0	0,026	0,032	0,044	0,070	
		0,080	0,0010	0,0013	0,0017	0,0028	
N2	MM06-06006-B90PF-M01 F15M	2,0	0,026	0,032	0,044	0,070	
		0,080	0,0010	0,0013	0,0017	0,0028	
N3	MM06-06006-B90PF-M01 F15M	2,0	0,026	0,032	0,044	0,070	
		0,080	0,0010	0,0013	0,0017	0,0028	
N11	MM06-06006-B90PF-M01 F15M	2,0	0,026	0,032	0,044	0,070	
		0,080	0,0010	0,0013	0,0017	0,0028	
S1	MM06-06006-B90PF-M01 F15M	1,2	0,014	0,016	0,022	0,034	
		0,048	0,00055	0,00065	0,00085	0,0013	
S2	MM06-06006-B90PF-M01 F15M	1,2	0,014	0,016	0,022	0,034	
		0,048	0,00055	0,00065	0,00085	0,0013	
S3	MM06-06006-B90PF-M01 F15M	1,2	0,013	0,014	0,020	0,032	
		0,048	0,00050	0,00060	0,00080	0,0013	
S11	MM06-06006-B90PF-M01 F15M	1,5	0,015	0,018	0,025	0,038	
		0,060	0,00060	0,00070	0,0010	0,0015	
S12	MM06-06006-B90PF-M01 F15M	1,5	0,015	0,018	0,025	0,038	
		0,060	0,00060	0,00070	0,0010	0,0015	
S13	MM06-06006-B90PF-M01 F15M	1,2	0,014	0,016	0,022	0,034	
		0,048	0,00055	0,00065	0,00085	0,0013	
H5	MM06-06006-B90PF-M01 F15M	1,7	0,013	0,015	0,020	0,032	
		0,065	0,00050	0,00060	0,00080	0,0013	
H8	MM06-06006-B90PF-M01 F15M	1,5	0,010	0,012	0,016	0,025	
		0,060	0,00040	0,00048	0,00065	0,0010	
H11	MM06-06006-B90PF-M01 F15M	1,7	0,013	0,015	0,020	0,032	
		0,065	0,00050	0,00060	0,00080	0,0013	
H12	MM06-06006-B90PF-M01 F15M	1,5	0,010	0,012	0,016	0,025	
		0,060	0,00040	0,00048	0,00065	0,0010	
H21	MM06-06006-B90PF-M01 F15M	1,5	0,010	0,012	0,016	0,025	
		0,060	0,00040	0,00048	0,00065	0,0010	



SMG = Seco material group
 f_z = mm/tooth (in/tooth), v_c = m/min (sf/min), a_p/DC = %
 All cutting data are start values

MM06 Z2-Copy milling – Cutting data $v_c = (m/min)/(sf/min)$

SMG	F15M					F30M					T60M				
	100%	20%	10%	5%	2%	100%	20%	10%	5%	2%	100%	20%	10%	5%	2%
P1	325	415	430	470	465	275	345	375	405	405	225	280	305	330	325
	1075	1350	1400	1550	1525	900	1125	1225	1325	1325	740	920	1000	1075	1075
P2	320	400	420	455	455	265	335	365	395	395	215	270	295	320	320
	1050	1300	1375	1500	1500	870	1100	1200	1300	1300	710	890	970	1050	1050
P3	275	345	360	395	395	230	290	315	340	340	190	235	255	275	275
	900	1125	1175	1300	1300	750	950	1025	1125	1125	620	770	840	900	900
P4	240	305	320	345	345	205	255	280	305	300	165	205	225	245	245
	790	1000	1050	1125	1125	670	840	920	1000	980	540	670	740	800	800
P5	230	290	305	330	330	195	245	265	290	290	160	200	215	235	235
	750	950	1000	1075	1075	640	800	870	950	950	520	660	710	770	770
P6	260	330	345	370	370	220	275	300	325	325	180	225	245	265	260
	850	1075	1125	1225	1225	720	900	980	1075	1075	590	740	800	870	850
P7	245	310	325	350	350	210	260	285	305	305	170	210	230	250	245
	800	1025	1075	1150	1150	690	850	940	1000	1000	560	690	750	820	800
P8	230	290	305	330	330	195	245	265	285	290	160	200	215	230	235
	750	950	1000	1075	1075	640	800	870	940	950	520	660	710	750	770
P11	240	300	315	340	340	200	255	275	300	295	165	205	220	240	240
	790	980	1025	1125	1125	660	840	900	980	970	540	670	720	790	790
P12	145	185	190	205	205	130	160	170	180	180	105	130	135	145	145
	475	610	620	670	670	425	520	560	590	590	345	425	445	475	475
M1	255	325	340	365	365	215	270	295	320	315	175	220	240	260	255
	840	1075	1125	1200	1200	710	890	970	1050	1025	570	720	790	850	840
M2	210	265	275	300	300	175	220	240	260	260	145	180	195	210	210
	690	870	900	980	980	570	720	790	850	850	475	590	640	690	690
M3	165	210	210	230	230	140	180	185	205	200	115	145	150	165	165
	540	690	710	750	750	460	590	620	670	660	375	475	510	540	540
M4	125	160	160	170	170	110	140	140	155	155	90	115	115	125	125
	410	520	560	560	560	360	460	490	510	510	295	375	395	410	410
M5	105	135	130	145	145	95	120	120	130	130	75	95	95	105	105
	345	445	475	475	475	310	395	410	425	425	245	310	330	345	345
K1	250	320	335	360	360	210	265	290	315	310	170	215	235	255	250
	820	1050	1100	1175	1175	690	870	950	1025	1025	560	710	770	840	820
K2	220	275	290	315	315	185	230	255	275	275	150	190	205	220	220
	720	900	950	1025	1025	610	750	840	900	900	490	620	670	720	720
K3	185	235	245	265	265	160	195	215	230	230	130	160	175	190	185
	610	770	800	870	870	520	640	710	750	750	425	520	570	620	610
K4	175	225	235	255	255	150	185	205	220	220	120	150	165	180	180
	570	740	770	840	840	490	610	670	720	720	395	490	540	590	590
K5	105	135	140	150	150	90	115	125	135	135	75	90	100	110	105
	345	445	460	490	490	295	375	410	445	445	245	295	330	360	345
K6	155	195	205	225	225	135	165	180	195	195	105	135	145	160	155
	510	640	670	740	740	445	540	590	640	640	345	445	475	520	510
K7	135	170	180	195	195	115	145	155	170	170	95	115	125	140	140
	445	560	590	640	640	375	475	510	560	560	310	375	410	460	460
N1	1975	2475	2600	2800	2800	1625	2050	2225	2400	2375	1325	1650	1800	1950	1925
	6475	8125	8525	9175	9175	5325	6725	7300	7875	7800	4350	5425	5900	6400	6325
N2	790	1000	1050	1125	1125	660	820	900	970	960	530	670	730	790	780
	2600	3275	3450	3700	3700	2175	2700	2950	3175	3150	1750	2200	2400	2600	2550
N3	530	670	700	760	750	440	550	600	650	640	355	445	485	520	520
	1750	2200	2300	2500	2450	1450	1800	1975	2125	2100	1175	1450	1600	1700	1700
N11	600	760	800	860	860	500	630	680	740	730	405	510	550	600	590
	1975	2500	2625	2825	2825	1650	2075	2225	2425	2400	1325	1675	1800	1975	1925
S1	60	75	75	80	80	50	65	65	70	70	42	55	60	60	60
	195	245	260	260	260	165	215	230	230	230	140	180	180	195	195
S2	47	60	60	65	65	42	55	55	60	60	34	43	43	47	47
	155	195	215	215	215	140	180	180	195	195	110	140	150	155	155
S3	41	50	50	55	55	36	46	46	50	50	29	37	38	40	40
	135	165	180	180	180	120	150	160	165	165	95	120	130	130	130
S11	85	105	105	115	115	75	95	95	105	100	60	75	75	85	85
	280	345	360	375	375	245	310	310	345	330	195	245	260	280	280
S12	55	75	75	80	80	50	65	65	70	70	41	55	55	55	55
	180	245	245	260	260	165	215	215	230	230	135	180	180	180	180
S13	33	42	42	45	45	29	37	37	40	40	24	30	30	33	33
	110	140	150	150	150	95	120	130	130	130	80	100	105	110	110
H5	48	60	60	65	65	42	55	55	60	60	34	43	45	49	49
	155	195	215	215	215	140	180	180	195	195	110	140	150	160	160
H8	48	60	60	65	65	44	55	55	60	60	36	46	46	50	50
	155	195	215	215	215	145	180	195	195	195	120	150	155	165	165
H11	60	80	80	85	85	55	70	70	75	75	44	55	55	60	60
	195	260	260	280	280	180	230	230	245	245	145	180	195	195	195
H12	85	110	110	120	120	80	100	100	110	110	65	80	85	90	90
	280	360	375	395	395	260	330	345	360	360	215	260	280	295	295
H21	48	60	60	65	65	44	55	55	60	60	36	46	46	50	50
	155	195	215	215	215	145	180	195	195	195	120	150	155	165	165

Universal
Steel and cast iron
Stainless steel and S-materials
Stainless steel and S-materials
Non ferrous
Hard
Graphite
X-Heads
Minimaster Plus
Minimaster

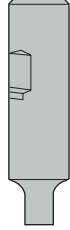
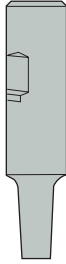
Shank design

Universal	Design 1, Keyway shank	Design 2, Cylindrical/Weldon back end and 90° front
Steel and cast iron		
Stainless steel and S-materials		
	Design 3, Cylindrical/Weldon back end tapered front 87°/89°	Design 4, Cylindrical/Weldon back end tapered front 80°/85°/87°
Non ferrous		
Hard		
Plastic and cfrp	Design 5, Cylindrical back end double tapered front end 89°/85°	
Graphite		
X-Heads		
Minimaster Plus		

MM08 Shank – Metric

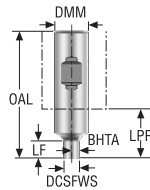

Designation	Item number	Type of mounting	DCSFWS	DMM	OAL	LF	LPR	BHTA°	Design		RPMX	Weight	Spare part no.
MM08-16070.3-0007	75034241	Weldon	7,6	16,0	70,0	7,6	22,0	0,0	2	✓	80000	0,1	1
MM08-16075.3-3012	75034242	Weldon	7,6	16,0	75,0	12,0	27,0	3,0	3	✓	80000	0,1	1
MM08-16120.3-5048M	00042863	Weldon	7,6	16,0	120,0	48,0	72,0	5,0	4	✓	80000	0,2	5
MM08-10040.0-0007	00083980	Cylindrical	7,6	10,0	40,0	7,0	7,0	0,0	2	✓	80000	0,1	2
MM08-12065.0-0000	75034240	Cylindrical	7,6	12,0	65,0	0,0	20,0	60,0	1	✓	80000	0,1	1
MM08-16150.0-1030M	00094751	Cylindrical	7,6	16,0	150,0	30,0	102,0	1,0	3	✓	80000	0,2	5
MM08-16150.0-1050M	00094752	Cylindrical	7,6	16,0	150,0	50,0	102,0	1,0	3	✓	80000	0,2	4
MM08-16150.0-1070M	00094754	Cylindrical	7,6	16,0	150,0	70,0	102,0	1,0	3	✓	80000	0,2	4
MM08-10050.0-0007DS	02580665	Cylindrical	7,6	10,0	50,0	7,0	10,0	0,0	2	✓	80000	0,1	3
MM08-10080.0-3023DS	02580702	Cylindrical	7,6	10,0	80,0	22,9	40,0	3,0	4	✓	80000	0,1	3
MM08-12100.0-1035DS	02580719	Cylindrical	7,6	12,0	100,0	35,0	55,0	1,0	3	✓	80000	0,2	3
MM08-12120.0-1050DS	02580720	Cylindrical	7,6	12,0	120,0	50,0	75,0	1,0	3	✓	80000	0,2	3
MM08-16085.0-0016DS	02580675	Cylindrical	7,6	16,0	85,0	16,0	37,0	0,0	2	✓	80000	0,3	3
MM08-16100.0-0032DS	02580687	Cylindrical	7,6	16,0	100,0	32,0	52,0	0,0	2	✓	80000	0,3	3
MM08-16150.0-1050DS	02580722	Cylindrical	7,6	16,0	150,0	50,0	102,0	1,0	3	✓	80000	0,4	3
MM08-16150.0-1070DS	02580727	Cylindrical	7,6	16,0	150,0	70,0	102,0	1,0	3	✓	80000	0,3	3

Spare Parts, included in delivery

Accessories

For cutter	Sleeve	Tension screw	Sleeve key
1	MM-05044	MM08-0524	H05-4
5	MM-05044	MM08-0543	H05-4
2	MM-05019	MM08-0524	H05-4
4	MM-05044	MM08-0582	H05-4
3	–	MM08-0524	–

Universal

Steel and cast iron

Stainless steel and S-materials

Stainless steel and S-materials

Non ferrous

Hard

Graphite

X-Heads

Minimaster Plus

Minimaster

MM08 Shank – Inch

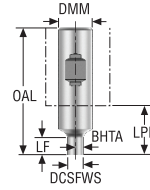

Designation	Item number	Type of mounting	DCSFWS	DMM	OAL	LF	LPR	BHTA°	Design		RPMX	Weight	Spare part no.
MM08-0.62-2.8-3-0003	75054600	Weldon	0.299	0.625	2.756	0.299	0.866	0,0	2	✓	80000	0.220	1
MM08-0.62-3.0-3-3004	75054601	Weldon	0.299	0.625	2.953	0.472	1.063	3,0	3	✓	80000	0.220	1
MM08-0.62-4.7-3-5018	75054602	Weldon	0.299	0.625	4.724	1.850	2.835	5,0	4	✓	80000	0.440	2
MM08-0.38-1.6-0-0002	00096119	Cylindrical	0.299	0.375	1.575	0.276	0.276	0,0	2	✓	80000	0.220	3
MM08-0.50-2.6-0-0000	75054599	Cylindrical	0.299	0.500	2.559	0	0.787	60,0	1	✓	80000	0.220	1
MM08-0.62-5.9-0-1011	75054604	Cylindrical	0.299	0.625	5.906	1.181	4.016	1,0	3	✓	80000	0.440	2
MM08-0.62-3.3-0-0006DS	02593402	Cylindrical	0.299	0.625	3.346	0.630	1.457	0,0	2	✓	80000	0.660	4
MM08-0.62-4.0-0-0012DS	02593403	Cylindrical	0.299	0.625	3.937	1.260	2.047	0,0	2	✓	80000	0.660	4
MM08-0.62-5.9-0-1019DS	02593407	Cylindrical	0.299	0.625	5.906	1.969	4.016	1,0	3	✓	80000	0.880	4
MM08-0.62-5.9-0-1027DS	02593410	Cylindrical	0.299	0.625	5.906	2.756	4.016	1,0	3	✓	80000	0.660	4
MM08-0.75-10.0-0-1019DS	02593413	Cylindrical	0.299	0.750	9.843	1.969	7.874	1,0	5	✓	80000	1.980	4

Spare Parts, included in delivery

Accessories

For cutter	Sleeve	Tension screw	Sleeve key
1	MM-05044	MM08-0524	H05-4
2	MM-05044	MM08-0543	H05-4
3	MM-05019	MM08-0524	H05-4
4	–	MM08-0524	–

Universal

Steel and cast iron

Stainless steel and S-materials

Non ferrous

Hard

Plastic and CFRP

Graphite

X-Heads

Minimaster Plus

Minimaster

Slot milling/square shoulder milling

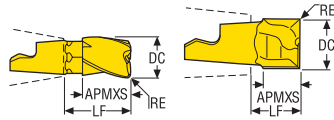

• For Torque keys and torque values, see page 720

Designation	DC	APMXS	RE	LF	RMPX°	C min	C max	FHA°	ZEPF	Wrench	Grades					
											Coated					
											T60M	F15M	F30M	F40M		
	mm Inch	mm Inch	mm Inch	mm Inch												
MM08-07805T-R02-D03	7,8 0.307	5,4 0.213	0,2 0.008	6,8 0.268	15,0	9,6	15,0	0	2		■					
MM08-07809-R02A30-M03	7,8 0.307	10,0 0.394	0,2 0.008	13,0 0.512	15,0	9,6	15,0	30	3							■
MM08-08005-M03	8,0 0.315	5,5 0.217	0,0 -	6,8 0.268	15,0	9,8	15,8	0	2		■					
MM08-08005-R04A8-E03	8,0 0.315	5,4 0.213	0,4 0.016	6,7 0.264	15,0	9,8	15,0	8	2		■			■		
MM08-08005-R04-MD03	8,0 0.315	5,5 0.217	0,4 0.016	6,8 0.268	15,0	9,8	15,0	0	2		■			■		
MM08-08005-R04P-M02	8,0 0.315	5,4 0.213	0,4 0.016	6,7 0.264	15,0	9,8	15,0	0	2					■		
MM08-08005-R10-MD03	8,0 0.315	5,4 0.213	1,0 0.039	6,8 0.268	15,0	9,8	13,8	0	2					■		
MM08-08009-A30-E03	8,0 0.315	10,0 0.394	0,0 -	13,0 0.512	15,0	9,8	15,0	30	3					■		
MM08-08009-R05A30-M03	8,0 0.315	10,0 0.394	0,5 0.020	13,0 0.512	15,0	9,8	14,8	30	3							■
MM08-08009-R10A30-D03	8,0 0.315	10,0 0.394	1,0 0.039	13,0 0.512	15,0	9,8	13,8	30	3					■		
MM08-08009-R10A30-E03	8,0 0.315	10,0 0.394	1,0 0.039	13,0 0.512	15,0	9,8	13,8	30	3					■		
MM08-08009-R10A30-M03	8,0 0.315	10,0 0.394	1,0 0.039	13,0 0.512	15,0	9,8	13,8	30	3							■
MM08-08009-R20A30-M03	8,0 0.315	10,0 0.394	2,0 0.079	13,0 0.512	15,0	9,8	11,8	30	3							■
MM08-08009-R30A30-M03	8,0 0.315	10,0 0.394	3,0 0.118	13,0 0.512	15,0	9,8	9,8	30	3							■

Universal

Steel and cast iron

Stainless steel and S-materials

Stainless steel and S-materials

Non ferrous

Hard

Graphite

X-Heads

Minimaster Plus

Minimaster

Centre drilling

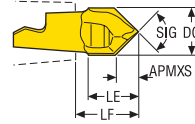

• For Torque keys and torque values, see page 720

Designation	DC	APMXS	LE	LF	SIG°	ZEFP	Wrench	Grades			
								T60M	F15M	F30M	F40M
MM08-08004-C90-M03	8,0 0.315	3,79 0.149	8,0 0.315	9,5 0.374	90,0	2		■			
MM08-08006-C120-M03	8,0 0.315	2,15 0.085	8,32 0.328	9,46 0.372	120,0	2		■			

Chamfering

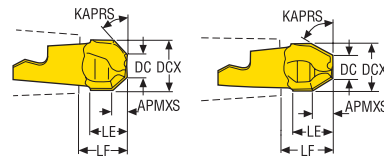

• For Torque keys and torque values, see page 720

Designation	DCX	DC	APMXS	LE	LF	KAPRS°	ZEFP	Wrench	Grades			
									T60M	F15M	F30M	F40M
MM08-08005-4520-E03	8,0 0.315	3,87 0.152	2,1 0.083	5,5 0.217	6,7 0.264	45,0	2		■			
MM08-08006-6030-E03	8,0 0.315	4,19 0.165	3,3 0.130	6,45 0.254	7,66 0.302	60,0	2		■			

Plunge milling

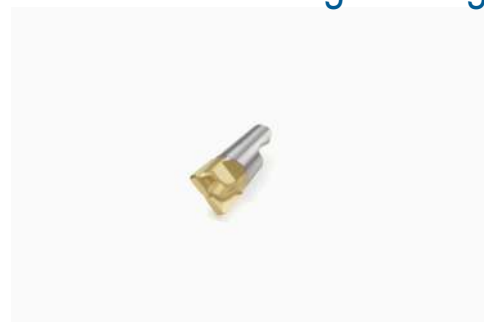
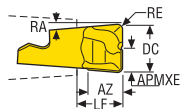

• For Torque keys and torque values, see page 720

Designation	DC	APMXE	RE	AZ	LF	RA°	ZEFP	Wrench	Grades			
									T60M	F15M	F30M	F40M
MM08-08005-R10-PL-MD03	8,0 0.315	4,0 0.157	1,0 0.039	5,7 0.224	6,78 0.267	5,0	2			■		

Universal

Steel and cast iron

Stainless steel and S-materials

Stainless steel and S-materials

Precision inserts for semi-finishing in all materials

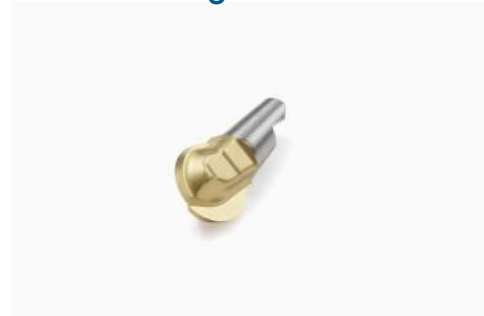
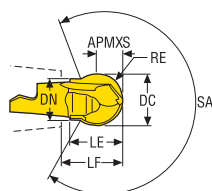

• For Torque keys and torque values, see page 720

Designation	DC	APMXS	RE	LE	LF	DN	SA°	ZEFP	Wrench	Grades			
										T60M	F15M	F30M	F40M
MM08-10010-B120PF-M02	10,0 0.394	5,0 0.197	5,0 0.197	10,0 0.394	10,97 0.432	8,0 0.315	254,0	2		■			
MM08-10010-B120P-M04	10,0 0.394	5,0 0.197	5,0 0.197	10,0 0.394	10,97 0.432	8,0 0.315	254,0	2			■		

Non ferrous

Hard

Graphite

X-Heads

Minimaster Plus

Minimaster

Copy milling

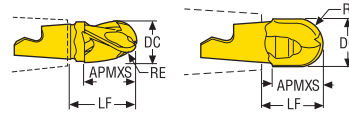

• For Torque keys and torque values, see page 720

Designation	DC	APMXS	RE	LF	FHA°	ZEFP	Wrench	Grades			
								T60M	F15M	F30M	F40M
MM08-08008-B90-MD03	8,0 0.315	8,1 0.319	4,0 0.157	9,42 0.371	0,0	2		■		■	
MM08-08008-B90PF-M01	8,0 0.315	6,9 0.272	4,0 0.157	9,39 0.370	0,0	2			■		
MM08-08008-B90P-M03	8,0 0.315	6,9 0.272	4,0 0.157	9,39 0.370	0,0	2				■	
MM08-08008-B90S-E03	8,0 0.315	8,1 0.319	4,0 0.157	9,42 0.371	0,0	2				■	
MM08-08009-B90A30-E03	8,0 0.315	10,0 0.394	4,0 0.157	13,0 0.512	30,0	3				■	
MM08-08009-B90A30-M03	8,0 0.315	10,0 0.394	4,0 0.157	13,0 0.512	30,0	3					■

High feed

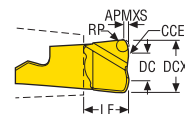

• For Torque keys and torque values, see page 720

Designation	DCX	DC	APMXS	RP	CCER	LF	RMPX°	C min	C max	ZEFP	Wrench	Grades			
												T60M	F15M	F30M	F40M
MM08-08.40-HF-MD06	8,0 0.315	4,0 0.157	0,37 0.015	0,88 0.035	4,0 0.157	6,84 0.269	5,0	9,8	14,6	2			■		

MM08 - Slot and Side milling – Insert selection – mm/Inch

SMG		a _p	f _z			
			100%	40%	20%	10%
P1	MM08-08009-R05A30-M03 F40M	1,8	0,044	0,044	0,055	0,070
		0,070	0,0017	0,0017	0,0022	0,0028
P2	MM08-08009-R05A30-M03 F40M	1,8	0,044	0,046	0,055	0,070
		0,070	0,0017	0,0018	0,0022	0,0028
P3	MM08-08009-R05A30-M03 F40M	1,8	0,042	0,042	0,050	0,070
		0,070	0,0017	0,0017	0,0020	0,0028
P4	MM08-08009-R05A30-M03 F40M	1,8	0,042	0,042	0,050	0,065
		0,070	0,0017	0,0017	0,0020	0,0026
P5	MM08-08009-R05A30-M03 F40M	1,8	0,040	0,042	0,050	0,065
		0,070	0,0016	0,0017	0,0020	0,0026
P6	MM08-08009-R05A30-M03 F40M	1,8	0,040	0,040	0,048	0,065
		0,070	0,0016	0,0016	0,0019	0,0026
P7	MM08-08009-R05A30-M03 F40M	1,8	0,040	0,040	0,048	0,065
		0,070	0,0016	0,0016	0,0019	0,0026
P8	MM08-08009-R05A30-M03 F40M	1,8	0,042	0,042	0,050	0,070
		0,070	0,0017	0,0017	0,0020	0,0028
P11	MM08-08009-R05A30-M03 F40M	1,8	0,040	0,040	0,048	0,065
		0,070	0,0016	0,0016	0,0019	0,0026
P12	MM08-08009-R05A30-M03 F40M	1,4	0,028	0,028	0,034	0,044
		0,055	0,0011	0,0011	0,0013	0,0017
M1	MM08-08009-R05A30-M03 F40M	1,8	0,044	0,046	0,055	0,070
		0,070	0,0017	0,0018	0,0022	0,0028
M2	MM08-08009-R05A30-M03 F40M	1,8	0,040	0,042	0,050	0,065
		0,070	0,0016	0,0017	0,0020	0,0026
M3	MM08-08009-R05A30-M03 F40M	1,4	0,034	0,034	0,040	0,055
		0,055	0,0013	0,0013	0,0016	0,0022
M4	MM08-08009-R05A30-M03 F40M	1,0	0,030	0,030	0,034	0,046
		0,040	0,0012	0,0012	0,0013	0,0018
M5	MM08-08009-R05A30-M03 F40M	1,0	0,030	0,030	0,034	0,046
		0,040	0,0012	0,0012	0,0013	0,0018
K1	MM08-08009-R10A30-E03 F30M	1,8	0,050	0,048	0,055	0,075
		0,070	0,0020	0,0019	0,0022	0,0030
K2	MM08-08009-R10A30-E03 F30M	1,8	0,044	0,044	0,050	0,065
		0,070	0,0017	0,0017	0,0020	0,0026
K3	MM08-08009-R10A30-E03 F30M	1,8	0,044	0,044	0,050	0,065
		0,070	0,0017	0,0017	0,0020	0,0026
K4	MM08-08009-R10A30-E03 F30M	1,8	0,044	0,044	0,050	0,065
		0,070	0,0017	0,0017	0,0020	0,0026
K5	MM08-08009-R10A30-D03 F30M	1,8	0,040	0,040	0,046	0,060
		0,070	0,0016	0,0016	0,0018	0,0024
K6	MM08-08009-R10A30-D03 F30M	1,8	0,044	0,044	0,050	0,065
		0,070	0,0017	0,0017	0,0020	0,0026
K7	MM08-08009-R10A30-D03 F30M	1,8	0,040	0,040	0,046	0,060
		0,070	0,0016	0,0016	0,0018	0,0024
N1	MM08-08009-R10A30-E03 F30M	1,8	0,060	0,060	0,070	0,095
		0,070	0,0024	0,0024	0,0028	0,0038
N2	MM08-08009-R10A30-E03 F30M	1,8	0,060	0,060	0,070	0,095
		0,070	0,0024	0,0024	0,0028	0,0038
N3	MM08-08009-R10A30-E03 F30M	1,8	0,060	0,060	0,070	0,095
		0,070	0,0024	0,0024	0,0028	0,0038
N11	MM08-08009-R10A30-E03 F30M	1,8	0,060	0,060	0,070	0,095
		0,070	0,0024	0,0024	0,0028	0,0038
S1	MM08-08009-R10A30-D03 F30M	1,0	0,038	0,036	0,036	0,046
		0,040	0,0015	0,0014	0,0014	0,0019
S2	MM08-08009-R10A30-D03 F30M	1,0	0,036	0,036	0,036	0,046
		0,040	0,0014	0,0013	0,0013	0,0017
S3	MM08-08009-R10A30-D03 F30M	1,2	0,034	0,034	0,040	0,055
		0,048	0,0013	0,0013	0,0016	0,0022
S11	MM08-08009-R05A30-M03 F40M	1,2	0,034	0,034	0,040	0,055
		0,048	0,0013	0,0013	0,0016	0,0022
S12	MM08-08009-R05A30-M03 F40M	1,2	0,034	0,034	0,040	0,055
		0,048	0,0013	0,0013	0,0016	0,0022
S13	MM08-08009-R05A30-M03 F40M	1,0	0,030	0,030	0,034	0,046
		0,040	0,0012	0,0012	0,0013	0,0018
H5	MM08-08009-R10A30-E03 F30M	1,4	0,032	0,032	0,034	0,044
		0,055	0,0013	0,0013	0,0013	0,0018
H8	MM08-08009-R10A30-E03 F30M	1,2	0,026	0,025	0,026	0,034
		0,048	0,0010	0,0010	0,0010	0,0013
H11	MM08-08009-R10A30-E03 F30M	1,4	0,032	0,032	0,034	0,044
		0,055	0,0013	0,0013	0,0013	0,0018
H12	MM08-08009-R10A30-E03 F30M	1,2	0,026	0,025	0,026	0,034
		0,048	0,0010	0,0010	0,0010	0,0013
H21	MM08-08009-R10A30-E03 F30M	1,2	0,026	0,025	0,026	0,034
		0,048	0,0010	0,0010	0,0010	0,0013

SMG = Seco material group
 f_z = mm/tooth (in/tooth), v_c = m/min (sf/min), a_p/DC = %
 All cutting data are start values

Universal
 Steel and cast iron
 Stainless steel and S-materials
 Stainless steel and S-materials
 Non ferrous
 Hard
 Graphite
 X-Heads
 Minimaster Plus
 Minimaster

MM08 - Slot and Side milling – Cutting data $v_c = (m/min)/(sf/min)$

SMG	F30M				F40M				T60M			
	100%	40%	20%	10%	100%	40%	20%	10%	100%	40%	20%	10%
P1	265	330	370	410	255	315	350	385	205	250	280	310
	870	1075	1225	1350	840	1025	1150	1275	670	820	920	1025
P2	255	320	360	390	245	305	340	375	195	245	275	300
	840	1050	1175	1275	800	1000	1125	1225	640	800	900	980
P3	225	280	315	340	215	265	295	325	170	210	240	260
	740	920	1025	1125	710	870	970	1075	560	690	790	850
P4	195	245	275	300	190	235	260	290	150	185	210	230
	640	800	900	980	620	770	850	950	490	610	690	750
P5	190	235	265	290	180	225	250	275	145	180	200	220
	620	770	870	950	590	740	820	900	475	590	660	720
P6	215	265	295	325	205	255	280	310	160	200	225	250
	710	870	970	1075	670	840	920	1025	520	660	740	820
P7	200	250	280	310	190	240	265	290	155	190	215	235
	660	820	920	1025	620	790	870	950	510	620	710	770
P8	190	235	265	285	180	225	250	270	145	180	200	220
	620	770	870	940	590	740	820	890	475	590	660	720
P11	195	245	270	300	185	230	260	285	150	185	210	230
	640	800	890	980	610	750	850	940	490	610	690	750
P12	120	150	170	185	115	145	160	175	95	115	130	145
	395	490	560	610	375	475	520	570	310	375	425	475
M1	—	—	—	—	200	245	275	305	160	195	220	240
	—	—	—	—	660	800	900	1000	520	640	720	790
M2	—	—	—	—	165	200	225	250	130	160	180	200
	—	—	—	—	540	660	740	820	425	520	590	660
M3	—	—	—	—	130	160	175	195	105	130	145	155
	—	—	—	—	425	520	570	640	345	425	475	510
M4	—	—	—	—	100	120	135	150	80	100	110	120
	—	—	—	—	330	395	445	490	260	330	360	395
M5	—	—	—	—	80	100	115	125	65	85	90	100
	—	—	—	—	260	330	375	410	215	280	295	330
K1	205	255	285	310	195	240	270	300	155	195	215	235
	670	840	940	1025	640	790	890	980	510	640	710	770
K2	180	225	250	275	170	210	235	260	135	170	190	210
	590	740	820	900	560	690	770	850	445	560	620	690
K3	155	190	210	235	145	180	200	220	115	145	160	180
	510	620	690	770	475	590	660	720	375	475	520	590
K4	145	180	200	225	140	170	190	210	110	140	155	170
	475	590	660	740	460	560	620	690	360	460	510	560
K5	90	110	120	135	85	105	115	125	65	85	95	100
	295	360	395	445	280	345	375	410	215	280	310	330
K6	130	160	180	195	120	150	170	185	95	120	135	150
	425	520	590	640	395	490	560	610	310	395	445	490
K7	115	140	155	170	110	135	150	165	85	105	120	130
	375	460	510	560	360	445	490	540	280	345	395	425
N1	1550	1950	2150	2350	1475	1850	2025	2250	1175	1475	1625	1800
	5075	6400	7050	7700	4850	6075	6650	7375	3850	4850	5325	5900
N2	630	780	870	950	600	750	820	910	475	590	660	720
	2075	2550	2850	3125	1975	2450	2700	2975	1550	1925	2175	2350
N3	420	520	580	630	400	495	550	610	315	395	440	485
	1375	1700	1900	2075	1300	1625	1800	2000	1025	1300	1450	1600
N11	480	600	660	720	455	570	630	690	360	455	500	550
	1575	1975	2175	2350	1500	1875	2075	2275	1175	1500	1650	1800
S1	48	60	65	75	46	55	65	70	37	46	50	55
	155	195	215	245	150	180	215	230	120	150	165	180
S2	39	48	55	60	37	46	50	55	30	37	41	45
	130	155	180	195	120	150	165	180	100	120	135	150
S3	34	42	47	50	32	40	45	49	26	32	36	39
	110	140	155	165	105	130	150	160	85	105	120	130
S11	—	—	—	—	65	80	90	100	50	65	75	80
	—	—	—	—	215	260	295	330	165	215	245	260
S12	—	—	—	—	45	55	60	70	36	45	50	55
	—	—	—	—	150	180	195	230	120	150	165	180
S13	—	—	—	—	26	32	36	39	21	26	29	31
	—	—	—	—	85	105	120	130	70	85	95	100
H5	41	50	55	60	39	48	55	60	31	39	43	47
	135	165	180	195	130	155	180	195	100	130	140	155
H8	42	50	60	65	40	50	55	60	33	40	45	49
	140	165	195	215	130	165	180	195	110	130	150	160
H11	50	65	70	80	49	60	70	75	39	49	55	60
	165	215	230	260	160	195	230	245	130	160	180	195
H12	75	95	105	115	70	90	100	110	60	70	80	90
	245	310	345	375	230	295	330	360	195	230	260	295
H21	42	50	60	65	40	50	55	60	33	40	45	49
	140	165	195	215	130	165	180	195	110	130	150	160

MM08 Z3 – Copy milling – Insert selection – Roughing – mm/Inch

SMG		a _p	f _z			
			100%	40%	20%	10%
P1	MM08-08009-B90A30-M03 F40M	1,8	0,055	0,050	0,055	0,070
		0,070	0,0022	0,0020	0,0022	0,0028
P2	MM08-08009-B90A30-M03 F40M	1,8	0,055	0,050	0,055	0,070
		0,070	0,0022	0,0020	0,0022	0,0028
P3	MM08-08009-B90A30-M03 F40M	1,8	0,050	0,050	0,050	0,070
		0,070	0,0020	0,0020	0,0020	0,0028
P4	MM08-08009-B90A30-M03 F40M	1,8	0,050	0,048	0,050	0,065
		0,070	0,0020	0,0019	0,0020	0,0026
P5	MM08-08009-B90A30-M03 F40M	1,8	0,048	0,048	0,050	0,065
		0,070	0,0019	0,0019	0,0020	0,0026
P6	MM08-08009-B90A30-M03 F40M	1,8	0,048	0,048	0,050	0,065
		0,070	0,0019	0,0019	0,0020	0,0026
P7	MM08-08009-B90A30-M03 F40M	1,8	0,048	0,048	0,050	0,065
		0,070	0,0019	0,0019	0,0020	0,0026
P8	MM08-08009-B90A30-M03 F40M	1,8	0,050	0,050	0,050	0,070
		0,070	0,0020	0,0020	0,0020	0,0028
P11	MM08-08009-B90A30-M03 F40M	1,8	0,048	0,048	0,050	0,065
		0,070	0,0019	0,0019	0,0020	0,0026
P12	MM08-08009-B90A30-M03 F40M	1,4	0,034	0,034	0,034	0,044
		0,055	0,0013	0,0013	0,0013	0,0017
M1	MM08-08009-B90A30-M03 F40M	1,8	0,055	0,050	0,055	0,070
		0,070	0,0022	0,0020	0,0022	0,0028
M2	MM08-08009-B90A30-M03 F40M	1,8	0,048	0,048	0,050	0,065
		0,070	0,0019	0,0019	0,0020	0,0026
M3	MM08-08009-B90A30-M03 F40M	1,4	0,040	0,040	0,040	0,055
		0,055	0,0016	0,0016	0,0016	0,0022
M4	MM08-08009-B90A30-M03 F40M	1,0	0,038	0,036	0,036	0,046
		0,040	0,0015	0,0014	0,0014	0,0019
M5	MM08-08009-B90A30-M03 F40M	1,0	0,038	0,036	0,036	0,046
		0,040	0,0015	0,0014	0,0014	0,0019
K1	MM08-08009-B90A30-E03 F30M	1,8	0,055	0,050	0,055	0,070
		0,070	0,0022	0,0020	0,0022	0,0028
K2	MM08-08009-B90A30-E03 F30M	1,8	0,048	0,048	0,050	0,065
		0,070	0,0019	0,0019	0,0020	0,0026
K3	MM08-08009-B90A30-E03 F30M	1,8	0,048	0,048	0,050	0,065
		0,070	0,0019	0,0019	0,0020	0,0026
K4	MM08-08009-B90A30-E03 F30M	1,8	0,048	0,048	0,050	0,065
		0,070	0,0019	0,0019	0,0020	0,0026
K5	MM08-08009-B90A30-M03 F40M	1,8	0,044	0,042	0,046	0,060
		0,070	0,0017	0,0017	0,0018	0,0024
K6	MM08-08009-B90A30-M03 F40M	1,8	0,048	0,048	0,050	0,065
		0,070	0,0019	0,0019	0,0020	0,0026
K7	MM08-08009-B90A30-M03 F40M	1,8	0,044	0,042	0,046	0,060
		0,070	0,0017	0,0017	0,0018	0,0024
N1	MM08-08009-B90A30-E03 F30M	1,8	0,070	0,065	0,070	0,090
		0,070	0,0028	0,0026	0,0028	0,0036
N2	MM08-08009-B90A30-E03 F30M	1,8	0,070	0,065	0,070	0,090
		0,070	0,0028	0,0026	0,0028	0,0036
N3	MM08-08009-B90A30-E03 F30M	1,8	0,070	0,065	0,070	0,090
		0,070	0,0028	0,0026	0,0028	0,0036
N11	MM08-08009-B90A30-E03 F30M	1,8	0,070	0,065	0,070	0,090
		0,070	0,0028	0,0026	0,0028	0,0036
S1	MM08-08009-B90A30-M03 F40M	1,0	0,038	0,036	0,036	0,046
		0,040	0,0015	0,0014	0,0014	0,0019
S2	MM08-08009-B90A30-M03 F40M	1,0	0,036	0,034	0,034	0,042
		0,040	0,0014	0,0013	0,0013	0,0017
S3	MM08-08009-B90A30-M03 F40M	1,2	0,042	0,040	0,042	0,055
		0,048	0,0017	0,0016	0,0017	0,0022
S11	MM08-08009-B90A30-M03 F40M	1,2	0,042	0,040	0,042	0,055
		0,048	0,0017	0,0016	0,0017	0,0022
S12	MM08-08009-B90A30-M03 F40M	1,0	0,038	0,036	0,036	0,046
		0,040	0,0015	0,0014	0,0014	0,0019
S13	MM08-08009-B90A30-M03 F40M	1,0	0,038	0,036	0,036	0,046
		0,040	0,0015	0,0014	0,0014	0,0019
H5	MM08-08009-B90A30-E03 F30M	1,4	0,034	0,034	0,034	0,044
		0,055	0,0013	0,0013	0,0013	0,0017
H8	MM08-08009-B90A30-E03 F30M	1,2	0,028	0,026	0,026	0,034
		0,048	0,0011	0,0010	0,0010	0,0013
H11	MM08-08009-B90A30-E03 F30M	1,4	0,034	0,034	0,034	0,044
		0,055	0,0013	0,0013	0,0013	0,0017
H12	MM08-08009-B90A30-E03 F30M	1,2	0,028	0,026	0,026	0,034
		0,048	0,0011	0,0010	0,0010	0,0013
H21	MM08-08009-B90A30-E03 F30M	1,2	0,028	0,026	0,026	0,034
		0,048	0,0011	0,0010	0,0010	0,0013

SMG = Seco material group
 f_z = mm/tooth (in/tooth), v_c = m/min (sf/min), a_p/DC = %
 All cutting data are start values

Universal
 Steel and cast iron
 Stainless steel and S-materials
 Stainless steel and S-materials
 Non ferrous
 Hard
 Graphite
 X-Heads
 Minimaster Plus
 Minimaster

MM08 Z3 – Copy milling – Insert selection – Finishing – mm/Inch

SMG		a_p		f_z			
				15%	10%	5%	2%
P1	MM08-08009-B90A30-E03 F30M	1,8	0,060	0,070	0,10	0,16	
		0,070	0,0024	0,0028	0,0040	0,0065	
P2	MM08-08009-B90A30-E03 F30M	1,8	0,060	0,070	0,10	0,17	
		0,070	0,0024	0,0028	0,0040	0,0065	
P3	MM08-08009-B90A30-E03 F30M	1,8	0,060	0,070	0,095	0,16	
		0,070	0,0024	0,0028	0,0038	0,0065	
P4	MM08-08009-B90A30-E03 F30M	1,8	0,055	0,065	0,095	0,15	
		0,070	0,0022	0,0026	0,0038	0,0060	
P5	MM08-08009-B90A30-E03 F30M	1,8	0,055	0,065	0,090	0,15	
		0,070	0,0022	0,0026	0,0036	0,0060	
P6	MM08-08009-B90A30-E03 F30M	1,8	0,055	0,065	0,090	0,15	
		0,070	0,0022	0,0026	0,0036	0,0060	
P7	MM08-08009-B90A30-E03 F30M	1,8	0,055	0,065	0,090	0,15	
		0,070	0,0022	0,0026	0,0036	0,0060	
P8	MM08-08009-B90A30-E03 F30M	1,8	0,060	0,070	0,095	0,16	
		0,070	0,0024	0,0028	0,0038	0,0065	
P11	MM08-08009-B90A30-E03 F30M	1,8	0,055	0,065	0,090	0,15	
		0,070	0,0022	0,0026	0,0036	0,0060	
P12	MM08-08009-B90A30-E03 F30M	1,4	0,038	0,044	0,060	0,10	
		0,055	0,0015	0,0017	0,0024	0,0040	
M1	MM08-08009-B90A30-E03 F30M	1,8	0,060	0,070	0,10	0,17	
		0,070	0,0024	0,0028	0,0040	0,0065	
M2	MM08-08009-B90A30-E03 F30M	1,8	0,055	0,065	0,090	0,15	
		0,070	0,0022	0,0026	0,0036	0,0060	
M3	MM08-08009-B90A30-E03 F30M	1,4	0,046	0,055	0,075	0,12	
		0,055	0,0018	0,0022	0,0030	0,0048	
M4	MM08-08009-B90A30-E03 F30M	1,0	0,040	0,046	0,065	0,10	
		0,040	0,0016	0,0019	0,0026	0,0040	
M5	MM08-08009-B90A30-E03 F30M	1,0	0,040	0,046	0,065	0,10	
		0,040	0,0016	0,0019	0,0026	0,0040	
K1	MM08-08009-B90A30-E03 F30M	1,8	0,060	0,070	0,10	0,17	
		0,070	0,0024	0,0028	0,0040	0,0065	
K2	MM08-08009-B90A30-E03 F30M	1,8	0,055	0,065	0,090	0,15	
		0,070	0,0022	0,0026	0,0036	0,0060	
K3	MM08-08009-B90A30-E03 F30M	1,8	0,055	0,065	0,090	0,15	
		0,070	0,0022	0,0026	0,0036	0,0060	
K4	MM08-08009-B90A30-E03 F30M	1,8	0,055	0,065	0,090	0,15	
		0,070	0,0022	0,0026	0,0036	0,0060	
K5	MM08-08009-B90A30-E03 F30M	1,8	0,050	0,060	0,080	0,13	
		0,070	0,0020	0,0024	0,0032	0,0050	
K6	MM08-08009-B90A30-E03 F30M	1,8	0,055	0,065	0,090	0,15	
		0,070	0,0022	0,0026	0,0036	0,0060	
K7	MM08-08009-B90A30-E03 F30M	1,8	0,050	0,060	0,080	0,13	
		0,070	0,0020	0,0024	0,0032	0,0050	
N1	MM08-08009-B90A30-E03 F30M	1,8	0,080	0,090	0,13	0,22	
		0,070	0,0032	0,0036	0,0050	0,0085	
N2	MM08-08009-B90A30-E03 F30M	1,8	0,080	0,090	0,13	0,22	
		0,070	0,0032	0,0036	0,0050	0,0085	
N3	MM08-08009-B90A30-E03 F30M	1,8	0,080	0,090	0,13	0,22	
		0,070	0,0032	0,0036	0,0050	0,0085	
N11	MM08-08009-B90A30-E03 F30M	1,8	0,080	0,090	0,13	0,22	
		0,070	0,0032	0,0036	0,0050	0,0085	
S1	MM08-08009-B90A30-E03 F30M	1,0	0,040	0,046	0,065	0,10	
		0,040	0,0016	0,0019	0,0026	0,0040	
S2	MM08-08009-B90A30-E03 F30M	1,0	0,040	0,046	0,065	0,10	
		0,040	0,0016	0,0019	0,0026	0,0040	
S3	MM08-08009-B90A30-E03 F30M	1,0	0,038	0,042	0,060	0,095	
		0,040	0,0015	0,0017	0,0024	0,0038	
S11	MM08-08009-B90A30-E03 F30M	1,2	0,046	0,055	0,075	0,12	
		0,048	0,0018	0,0022	0,0030	0,0048	
S12	MM08-08009-B90A30-E03 F30M	1,2	0,046	0,055	0,075	0,12	
		0,048	0,0018	0,0022	0,0030	0,0048	
S13	MM08-08009-B90A30-E03 F30M	1,0	0,040	0,046	0,065	0,10	
		0,040	0,0016	0,0019	0,0026	0,0040	
H5	MM08-08009-B90A30-E03 F30M	1,4	0,038	0,044	0,060	0,10	
		0,055	0,0015	0,0017	0,0024	0,0040	
H8	MM08-08009-B90A30-E03 F30M	1,2	0,030	0,034	0,048	0,075	
		0,048	0,0012	0,0013	0,0019	0,0030	
H11	MM08-08009-B90A30-E03 F30M	1,4	0,038	0,044	0,060	0,10	
		0,055	0,0015	0,0017	0,0024	0,0040	
H12	MM08-08009-B90A30-E03 F30M	1,2	0,030	0,034	0,048	0,075	
		0,048	0,0012	0,0013	0,0019	0,0030	
H21	MM08-08009-B90A30-E03 F30M	1,2	0,030	0,034	0,048	0,075	
		0,048	0,0012	0,0013	0,0019	0,0030	

SMG = Seco material group
 f_z = mm/tooth (in/tooth), v_c = m/min (sf/min), a_p/DC = %
 All cutting data are start values

MM08 Z3 – Copy milling – Cutting data $v_c = (m/min)/(sf/min)$

SMG	F30M					F40M				
	100%	20%	10%	5%	2%	100%	20%	10%	5%	2%
P1	280	330	355	380	380	265	315	335	360	360
	920	1075	1175	1250	1250	870	1025	1100	1175	1175
P2	270	325	345	370	365	260	310	325	350	350
	890	1075	1125	1225	1200	850	1025	1075	1150	1150
P3	235	280	295	320	320	225	270	280	305	300
	770	920	970	1050	1050	740	890	920	1000	980
P4	210	250	265	280	280	200	235	250	270	270
	690	820	870	920	920	660	770	820	890	890
P5	200	235	250	270	270	190	225	240	260	255
	660	770	820	890	890	620	740	790	850	840
P6	225	265	280	305	305	215	255	270	290	290
	740	870	920	1000	1000	710	840	890	950	950
P7	210	250	265	290	285	200	240	255	275	270
	690	820	870	950	940	660	790	840	900	890
P8	200	235	250	270	265	190	225	235	255	255
	660	770	820	890	870	620	740	770	840	840
P11	205	245	260	280	275	195	230	245	265	265
	670	800	850	920	900	640	750	800	870	870
P12	130	155	160	175	175	125	150	155	165	165
	425	510	520	570	570	410	490	510	540	540
M1	220	260	275	300	295	210	250	265	285	280
	720	850	900	980	970	690	820	870	940	920
M2	180	215	225	245	245	170	205	215	235	230
	590	710	740	800	800	560	670	710	770	750
M3	145	170	175	190	190	135	165	170	180	180
	475	560	570	620	620	445	540	560	590	590
M4	100	135	135	145	145	95	130	130	140	140
	330	445	475	475	475	310	425	445	460	460
M5	80	115	115	120	120	80	110	105	115	115
	260	375	395	395	395	260	360	375	375	375
K1	215	255	270	295	290	205	245	260	280	275
	710	840	890	970	950	670	800	850	920	900
K2	190	225	240	260	255	180	215	225	245	245
	620	740	790	850	840	590	710	740	800	800
K3	160	190	200	220	215	155	180	190	210	205
	520	620	660	720	710	510	590	620	690	670
K4	155	180	190	210	205	145	175	185	200	195
	510	590	620	690	670	475	570	610	660	640
K5	90	110	115	125	125	90	105	110	120	120
	295	360	375	410	410	295	345	360	395	395
K6	135	160	170	185	180	130	150	160	175	175
	445	520	560	610	590	425	490	520	570	570
K7	120	140	150	160	160	110	135	140	155	155
	395	460	490	520	520	360	445	460	510	510
N1	1625	1950	2075	2225	2200	1550	1850	1975	2125	2100
	5325	6400	6800	7300	7225	5075	6075	6475	6975	6900
N2	660	790	830	900	890	630	750	790	850	840
	2175	2600	2725	2950	2925	2075	2450	2600	2800	2750
N3	440	520	560	600	590	420	500	530	570	560
	1450	1700	1825	1975	1925	1375	1650	1750	1875	1825
N11	500	600	640	680	670	480	570	610	650	640
	1650	1975	2100	2225	2200	1575	1875	2000	2125	2100
S1	46	65	65	70	70	44	60	60	65	65
	150	215	215	230	230	145	195	215	215	215
S2	37	50	50	55	55	35	49	48	50	50
	120	165	180	180	180	115	160	165	165	165
S3	32	45	44	48	48	31	43	42	45	45
	105	150	155	155	155	100	140	150	150	150
S11	70	90	90	95	95	65	85	85	90	90
	230	295	295	310	310	215	280	280	295	295
S12	49	60	60	65	65	47	60	60	65	65
	160	195	215	215	215	155	195	195	215	215
S13	26	36	35	38	38	25	34	34	36	37
	85	120	125	125	125	80	110	120	120	120
H5	43	50	55	60	55	41	49	50	55	55
	140	165	180	195	180	135	160	165	180	180
H8	43	55	55	60	60	41	50	50	55	55
	140	180	180	195	195	135	165	180	180	180
H11	55	65	70	75	75	50	60	65	70	70
	180	215	230	245	245	165	195	215	230	230
H12	75	95	100	105	105	75	95	95	100	100
	245	310	330	345	345	245	310	310	330	330
H21	43	55	55	60	60	41	50	50	55	55
	140	180	180	195	195	135	165	180	180	180

Universal
Steel and cast iron
Stainless steel and S-materials
Stainless steel and S-materials
Non ferrous
Hard
Graphite
X-Heads
Minimaster Plus
Minimaster

MM08 Z2 – Copy milling – Insert selection – Roughing – mm/Inch

SMG		a _p	f _z			
			100%	40%	20%	10%
P1	MM08-08008-B90S-E03 F30M	3,0	0,048	0,046	0,055	0,070
		0.12	0.0019	0.0018	0.0022	0.0028
P2	MM08-08008-B90S-E03 F30M	3,0	0,048	0,048	0,055	0,075
		0.12	0.0019	0.0019	0.0022	0.0030
P3	MM08-08008-B90S-E03 F30M	3,0	0,046	0,044	0,050	0,070
		0.12	0.0018	0.0017	0.0020	0.0028
P4	MM08-08008-B90-MD03 F30M	3,0	0,044	0,044	0,050	0,070
		0.12	0.0017	0.0017	0.0020	0.0028
P5	MM08-08008-B90-MD03 F30M	3,0	0,044	0,042	0,050	0,065
		0.12	0.0017	0.0017	0.0020	0.0026
P6	MM08-08008-B90-MD03 F30M	3,0	0,044	0,042	0,050	0,065
		0.12	0.0017	0.0017	0.0020	0.0026
P7	MM08-08008-B90-MD03 F30M	3,0	0,044	0,042	0,050	0,065
		0.12	0.0017	0.0017	0.0020	0.0026
P8	MM08-08008-B90-MD03 F30M	3,0	0,046	0,044	0,050	0,070
		0.12	0.0018	0.0017	0.0020	0.0028
P11	MM08-08008-B90-MD03 F30M	3,0	0,044	0,042	0,050	0,065
		0.12	0.0017	0.0017	0.0020	0.0026
P12	MM08-08008-B90-MD03 F30M	2,5	0,030	0,030	0,034	0,044
		0.10	0.0012	0.0012	0.0013	0.0018
M1	MM08-08008-B90S-E03 F30M	3,0	0,048	0,048	0,055	0,075
		0.12	0.0019	0.0019	0.0022	0.0030
M2	MM08-08008-B90S-E03 F30M	3,0	0,044	0,042	0,050	0,065
		0.12	0.0017	0.0017	0.0020	0.0026
M3	MM08-08008-B90S-E03 F30M	2,5	0,036	0,036	0,040	0,055
		0.10	0.0014	0.0014	0.0016	0.0022
M4	MM08-08008-B90-MD03 F30M	1,9	0,034	0,034	0,036	0,046
		0.075	0.0013	0.0013	0.0014	0.0019
M5	MM08-08008-B90-MD03 F30M	1,9	0,034	0,034	0,036	0,046
		0.075	0.0013	0.0013	0.0014	0.0019
K1	MM08-08008-B90S-E03 F30M	3,0	0,048	0,048	0,055	0,075
		0.12	0.0019	0.0019	0.0022	0.0030
K2	MM08-08008-B90S-E03 F30M	3,0	0,044	0,042	0,050	0,065
		0.12	0.0017	0.0017	0.0020	0.0026
K3	MM08-08008-B90S-E03 F30M	3,0	0,044	0,042	0,050	0,065
		0.12	0.0017	0.0017	0.0020	0.0026
K4	MM08-08008-B90S-E03 F30M	3,0	0,044	0,042	0,050	0,065
		0.12	0.0017	0.0017	0.0020	0.0026
K5	MM08-08008-B90-MD03 F30M	3,0	0,040	0,038	0,046	0,060
		0.12	0.0016	0.0015	0.0018	0.0024
K6	MM08-08008-B90-MD03 F30M	3,0	0,044	0,042	0,050	0,065
		0.12	0.0017	0.0017	0.0020	0.0026
K7	MM08-08008-B90-MD03 F30M	3,0	0,040	0,038	0,046	0,060
		0.12	0.0016	0.0015	0.0018	0.0024
N1	MM08-08008-B90S-E03 F30M	3,0	0,060	0,060	0,070	0,095
		0.12	0.0024	0.0024	0.0028	0.0038
N2	MM08-08008-B90S-E03 F30M	3,0	0,060	0,060	0,070	0,095
		0.12	0.0024	0.0024	0.0028	0.0038
N3	MM08-08008-B90S-E03 F30M	3,0	0,060	0,060	0,070	0,095
		0.12	0.0024	0.0024	0.0028	0.0038
N11	MM08-08008-B90S-E03 F30M	3,0	0,060	0,060	0,070	0,095
		0.12	0.0024	0.0024	0.0028	0.0038
S1	MM08-08008-B90-MD03 F30M	1,9	0,034	0,034	0,036	0,046
		0.075	0.0013	0.0013	0.0014	0.0019
S2	MM08-08008-B90-MD03 F30M	1,9	0,034	0,034	0,036	0,046
		0.075	0.0013	0.0013	0.0014	0.0019
S3	MM08-08008-B90-MD03 F30M	1,9	0,032	0,030	0,034	0,042
		0.075	0.0013	0.0012	0.0013	0.0017
S11	MM08-08008-B90-MD03 F30M	2,5	0,036	0,036	0,042	0,055
		0.10	0.0014	0.0014	0.0017	0.0022
S12	MM08-08008-B90-MD03 F30M	2,5	0,036	0,036	0,042	0,055
		0.10	0.0014	0.0014	0.0017	0.0022
S13	MM08-08008-B90-MD03 F30M	1,9	0,034	0,034	0,036	0,046
		0.075	0.0013	0.0013	0.0014	0.0019
H5	MM08-08008-B90-MD03 F30M	2,5	0,030	0,030	0,034	0,044
		0.10	0.0012	0.0012	0.0013	0.0018
H8	MM08-08008-B90-MD03 F30M	2,5	0,024	0,024	0,026	0,034
		0.10	0.00095	0.00095	0.0010	0.0013
H11	MM08-08008-B90-MD03 F30M	2,5	0,030	0,030	0,034	0,044
		0.10	0.0012	0.0012	0.0013	0.0018
H12	MM08-08008-B90-MD03 F30M	2,5	0,024	0,024	0,026	0,034
		0.10	0.00095	0.00095	0.0010	0.0013
H21	MM08-08008-B90-MD03 F30M	2,5	0,024	0,024	0,026	0,034
		0.10	0.00095	0.00095	0.0010	0.0013

SMG = Seco material group
f_z = mm/tooth (in/tooth), v_c = m/min (sf/min), a_p/DC = %
All cutting data are start values

MM08 Z2 – Copy milling – Insert selection – Finishing – mm/Inch

SMG		a _p	f _z			
			15%	10%	5%	2%
P1	MM08-08008-B90PF-M01 F15M	3,0	0,020	0,024	0,032	0,050
		0.12	0.00080	0.00095	0.0013	0.0020
P2	MM08-08008-B90PF-M01 F15M	3,0	0,020	0,024	0,034	0,055
		0.12	0.00080	0.00095	0.0013	0.0022
P3	MM08-08008-B90PF-M01 F15M	3,0	0,019	0,022	0,032	0,050
		0.12	0.00075	0.00085	0.0013	0.0020
P4	MM08-08008-B90PF-M01 F15M	3,0	0,019	0,022	0,030	0,048
		0.12	0.00075	0.00085	0.0012	0.0019
P5	MM08-08008-B90PF-M01 F15M	3,0	0,019	0,022	0,030	0,048
		0.12	0.00075	0.00085	0.0012	0.0019
P6	MM08-08008-B90PF-M01 F15M	3,0	0,018	0,022	0,030	0,048
		0.12	0.00070	0.00085	0.0012	0.0019
P7	MM08-08008-B90PF-M01 F15M	3,0	0,018	0,022	0,030	0,048
		0.12	0.00070	0.00085	0.0012	0.0019
P8	MM08-08008-B90PF-M01 F15M	3,0	0,019	0,022	0,032	0,050
		0.12	0.00075	0.00085	0.0013	0.0020
P11	MM08-08008-B90PF-M01 F15M	3,0	0,018	0,022	0,030	0,048
		0.12	0.00070	0.00085	0.0012	0.0019
P12	MM08-08008-B90PF-M01 F15M	2,0	0,013	0,015	0,020	0,032
		0.080	0.00050	0.00060	0.00080	0.0013
M1	MM08-08008-B90PF-M01 F15M	3,0	0,020	0,024	0,034	0,055
		0.12	0.00080	0.00095	0.0013	0.0022
M2	MM08-08008-B90PF-M01 F15M	3,0	0,019	0,022	0,030	0,048
		0.12	0.00075	0.00085	0.0012	0.0019
M3	MM08-08008-B90PF-M01 F15M	2,0	0,015	0,018	0,024	0,038
		0.080	0.00060	0.00070	0.00095	0.0015
M4	MM08-08008-B90PF-M01 F15M	1,7	0,014	0,015	0,022	0,034
		0.065	0.00055	0.00065	0.00085	0.0013
M5	MM08-08008-B90PF-M01 F15M	1,7	0,014	0,015	0,022	0,034
		0.065	0.00055	0.00065	0.00085	0.0013
K1	MM08-08008-B90PF-M01 F15M	3,0	0,020	0,024	0,034	0,055
		0.12	0.00080	0.00095	0.0013	0.0022
K2	MM08-08008-B90PF-M01 F15M	3,0	0,019	0,022	0,030	0,048
		0.12	0.00075	0.00085	0.0012	0.0019
K3	MM08-08008-B90PF-M01 F15M	3,0	0,019	0,022	0,030	0,048
		0.12	0.00075	0.00085	0.0012	0.0019
K4	MM08-08008-B90PF-M01 F15M	3,0	0,019	0,022	0,030	0,048
		0.12	0.00075	0.00085	0.0012	0.0019
K5	MM08-08008-B90PF-M01 F15M	3,0	0,017	0,020	0,028	0,044
		0.12	0.00065	0.00080	0.0011	0.0017
K6	MM08-08008-B90PF-M01 F15M	3,0	0,019	0,022	0,030	0,048
		0.12	0.00075	0.00085	0.0012	0.0019
K7	MM08-08008-B90PF-M01 F15M	3,0	0,017	0,020	0,028	0,044
		0.12	0.00065	0.00080	0.0011	0.0017
N1	MM08-08008-B90PF-M01 F15M	3,0	0,026	0,030	0,042	0,070
		0.12	0.0010	0.0012	0.0017	0.0028
N2	MM08-08008-B90PF-M01 F15M	3,0	0,026	0,030	0,042	0,070
		0.12	0.0010	0.0012	0.0017	0.0028
N3	MM08-08008-B90PF-M01 F15M	3,0	0,026	0,030	0,042	0,070
		0.12	0.0010	0.0012	0.0017	0.0028
N11	MM08-08008-B90PF-M01 F15M	3,0	0,026	0,030	0,042	0,070
		0.12	0.0010	0.0012	0.0017	0.0028
S1	MM08-08008-B90PF-M01 F15M	1,7	0,014	0,015	0,022	0,034
		0.065	0.00055	0.00065	0.00085	0.0013
S2	MM08-08008-B90PF-M01 F15M	1,7	0,014	0,015	0,022	0,034
		0.065	0.00055	0.00065	0.00085	0.0013
S3	MM08-08008-B90PF-M01 F15M	1,7	0,013	0,014	0,020	0,030
		0.065	0.00050	0.00060	0.00080	0.0012
S11	MM08-08008-B90PF-M01 F15M	1,9	0,015	0,018	0,024	0,038
		0.075	0.00060	0.00070	0.00095	0.0015
S12	MM08-08008-B90PF-M01 F15M	1,9	0,015	0,018	0,024	0,038
		0.075	0.00060	0.00070	0.00095	0.0015
S13	MM08-08008-B90PF-M01 F15M	1,7	0,014	0,015	0,022	0,034
		0.065	0.00055	0.00065	0.00085	0.0013
H5	MM08-08008-B90PF-M01 F15M	2,0	0,013	0,015	0,020	0,032
		0.080	0.00050	0.00060	0.00080	0.0013
H8	MM08-08008-B90PF-M01 F15M	1,9	0,010	0,011	0,016	0,025
		0.075	0.00040	0.00048	0.00065	0.0010
H11	MM08-08008-B90PF-M01 F15M	2,0	0,013	0,015	0,020	0,032
		0.080	0.00050	0.00060	0.00080	0.0013
H12	MM08-08008-B90PF-M01 F15M	1,9	0,010	0,011	0,016	0,025
		0.075	0.00040	0.00048	0.00065	0.0010
H21	MM08-08008-B90PF-M01 F15M	1,9	0,010	0,011	0,016	0,025
		0.075	0.00040	0.00048	0.00065	0.0010

SMG = Seco material group
 f_z = mm/tooth (in/tooth), v_c = m/min (sf/min), a_p/DC = %
 All cutting data are start values

Universal
 Steel and cast iron
 Stainless steel and S-materials
 Stainless steel and S-materials
 Non ferrous
 Hard
 Graphite
 X-Heads
 Minimaster Plus
 Minimaster

MM08 Z2 – Copy milling – Cutting data $v_c = (m/min)/(sf/min)$

SMG	F15M					F30M					T60M				
	100%	20%	10%	5%	2%	100%	20%	10%	5%	2%	100%	20%	10%	5%	2%
P1	320	405	430	465	465	265	330	360	385	385	215	265	290	315	310
	1050	1325	1400	1525	1525	870	1075	1175	1275	1275	710	870	950	1025	1025
P2	315	395	420	450	450	260	320	345	375	370	210	260	280	305	300
	1025	1300	1375	1475	1475	850	1050	1125	1225	1225	690	850	920	1000	980
P3	270	340	360	390	390	225	280	300	325	325	180	225	245	265	260
	890	1125	1175	1275	1275	740	920	980	1075	1075	590	740	800	870	850
P4	240	300	320	345	345	200	245	265	285	285	160	200	215	230	230
	790	980	1050	1125	1125	660	800	870	940	940	520	660	710	750	750
P5	225	285	305	330	330	190	235	255	275	275	155	190	205	220	220
	740	940	1000	1075	1075	620	770	840	900	900	510	620	670	720	720
P6	255	320	340	370	370	210	265	285	310	305	170	215	230	250	250
	840	1050	1125	1225	1225	690	870	940	1025	1000	560	710	750	820	820
P7	240	300	320	350	350	200	250	270	295	290	160	200	220	235	235
	790	980	1050	1150	1150	660	820	890	970	950	520	660	720	770	770
P8	225	285	305	330	330	190	235	250	275	270	150	190	205	220	220
	740	940	1000	1075	1075	620	770	820	900	890	490	620	670	720	720
P11	235	295	315	340	340	195	240	260	285	280	160	195	210	230	230
	770	970	1025	1125	1125	640	790	850	940	920	520	640	690	750	750
P12	145	185	185	200	200	125	155	165	175	175	100	125	130	145	140
	475	610	620	660	660	410	510	540	570	570	330	410	445	475	460
M1	250	315	335	365	365	210	260	280	305	300	170	210	225	245	240
	820	1025	1100	1200	1200	690	850	920	1000	980	560	690	740	800	790
M2	205	255	275	295	295	170	210	230	245	245	140	170	185	200	200
	670	840	900	970	970	560	690	750	800	800	460	560	610	660	660
M3	165	205	210	225	225	135	175	180	195	195	110	140	145	155	155
	540	670	710	740	740	445	570	590	640	640	360	460	475	510	510
M4	125	160	160	170	170	110	140	135	150	150	85	110	110	120	120
	410	520	560	560	560	360	460	475	490	490	280	360	375	395	395
M5	105	135	130	140	140	90	115	115	125	125	75	95	90	100	100
	345	445	460	460	460	295	375	395	410	410	245	310	330	330	330
K1	250	310	330	360	355	205	255	275	300	295	165	205	220	240	240
	820	1025	1075	1175	1175	670	840	900	980	970	540	670	720	790	790
K2	215	270	290	310	310	180	225	240	260	260	145	180	195	210	210
	710	890	950	1025	1025	590	740	790	850	850	475	590	640	690	690
K3	180	230	245	265	265	150	190	205	220	220	125	155	165	180	180
	590	750	800	870	870	490	620	670	720	720	410	510	540	590	590
K4	175	220	235	250	250	145	180	195	210	210	115	145	160	170	170
	570	720	770	820	820	475	590	640	690	690	375	475	520	560	560
K5	105	130	140	150	150	90	110	120	125	125	70	90	95	105	105
	345	425	460	490	490	295	360	395	410	410	230	295	310	345	345
K6	155	190	205	220	220	130	160	170	185	185	105	130	140	150	150
	510	620	670	720	720	425	520	560	610	610	345	425	460	490	490
K7	135	165	180	195	195	110	140	150	165	165	90	110	120	130	130
	445	540	590	640	640	360	460	490	540	540	295	360	395	425	425
N1	1925	2425	2575	2800	2775	1550	1925	2075	2250	2225	1250	1550	1675	1825	1800
	6325	7950	8450	9175	9100	5075	6325	6800	7375	7300	4100	5075	5500	6000	5900
N2	780	980	1050	1125	1125	630	780	840	910	900	510	630	680	740	730
	2550	3225	3450	3700	3700	2075	2550	2750	2975	2950	1675	2075	2225	2425	2400
N3	520	650	700	750	750	420	520	560	610	600	340	420	455	490	485
	1700	2125	2300	2450	2450	1375	1700	1825	2000	1975	1125	1375	1500	1600	1600
N11	590	740	800	860	860	480	590	640	700	690	390	480	520	560	560
	1925	2425	2625	2825	2825	1575	1925	2100	2300	2275	1275	1575	1700	1825	1825
S1	60	75	75	80	80	50	65	65	70	70	41	50	50	55	55
	195	245	260	260	260	165	215	230	230	230	135	165	180	180	180
S2	47	60	60	65	65	40	50	50	55	55	33	42	42	45	45
	155	195	215	215	215	130	165	180	180	180	110	140	145	150	150
S3	40	50	50	55	55	35	45	45	48	48	28	36	36	39	39
	130	165	180	180	180	115	150	155	155	155	90	120	125	130	130
S11	85	105	105	115	115	70	90	90	100	100	55	75	75	80	80
	280	345	360	375	375	230	295	310	330	330	180	245	245	260	260
S12	60	75	75	80	80	48	60	65	70	70	39	50	50	55	55
	195	245	245	260	260	155	195	215	230	230	130	165	180	180	180
S13	33	42	42	45	45	28	36	36	39	39	23	29	29	31	32
	110	140	150	150	150	90	120	125	130	130	75	95	100	100	105
H5	48	60	60	65	65	41	50	55	60	60	33	42	44	47	47
	155	195	215	215	215	135	165	180	195	195	110	140	145	155	155
H8	49	60	60	65	65	42	55	55	60	60	34	44	45	48	48
	160	195	215	215	215	140	180	180	195	195	110	145	150	155	155
H11	60	80	80	85	85	55	65	70	75	75	43	55	55	60	60
	195	260	260	280	280	180	215	230	245	245	140	180	180	195	195
H12	85	110	110	120	120	75	100	100	105	105	60	80	80	85	85
	280	360	375	395	395	245	330	345	345	345	195	260	280	280	280
H21	49	60	60	65	65	42	55	55	60	60	34	44	45	48	48
	160	195	215	215	215	140	180	180	195	195	110	145	150	155	155

MM08 High-Feed – Insert selection – mm/Inch

SMG		a _p	f _z			
			100%	70%	30%	20%
P1	MM08-08.40-HF-MD06 F30M	0,26	0,32	0,32	0,42	0,50
		0.010	0.013	0.013	0.017	0.020
P2	MM08-08.40-HF-MD06 F30M	0,26	0,32	0,32	0,42	0,50
		0.010	0.013	0.013	0.017	0.020
P3	MM08-08.40-HF-MD06 F30M	0,26	0,30	0,30	0,40	0,48
		0.010	0.012	0.012	0.016	0.019
P4	MM08-08.40-HF-MD06 F30M	0,26	0,30	0,30	0,38	0,48
		0.010	0.012	0.012	0.015	0.019
P5	MM08-08.40-HF-MD06 F30M	0,26	0,28	0,30	0,38	0,46
		0.010	0.011	0.012	0.015	0.018
P6	MM08-08.40-HF-MD06 F30M	0,26	0,28	0,28	0,38	0,46
		0.010	0.011	0.011	0.015	0.018
P7	MM08-08.40-HF-MD06 F30M	0,26	0,28	0,28	0,38	0,46
		0.010	0.011	0.011	0.015	0.018
P8	MM08-08.40-HF-MD06 F30M	0,26	0,30	0,30	0,40	0,48
		0.010	0.012	0.012	0.016	0.019
P11	MM08-08.40-HF-MD06 F30M	0,26	0,28	0,28	0,38	0,46
		0.010	0.011	0.011	0.015	0.018
P12	MM08-08.40-HF-MD06 F30M	0,20	0,20	0,20	0,25	0,30
		0.0080	0.0080	0.0080	0.010	0.012
M1	MM08-08.40-HF-MD06 F30M	0,26	0,32	0,32	0,42	0,50
		0.010	0.013	0.013	0.017	0.020
M2	MM08-08.40-HF-MD06 F30M	0,26	0,28	0,30	0,38	0,46
		0.010	0.011	0.012	0.015	0.018
M3	MM08-08.40-HF-MD06 F30M	0,20	0,24	0,24	0,30	0,36
		0.0080	0.0095	0.0095	0.012	0.014
M4	MM08-08.40-HF-MD06 F30M	0,16	0,20	0,20	0,26	0,32
		0.0065	0.0080	0.0080	0.010	0.013
M5	MM08-08.40-HF-MD06 F30M	0,16	0,20	0,20	0,26	0,32
		0.0065	0.0080	0.0080	0.010	0.013
K1	MM08-08.40-HF-MD06 F30M	0,26	0,32	0,32	0,42	0,50
		0.010	0.013	0.013	0.017	0.020
K2	MM08-08.40-HF-MD06 F30M	0,26	0,28	0,30	0,38	0,46
		0.010	0.011	0.012	0.015	0.018
K3	MM08-08.40-HF-MD06 F30M	0,26	0,28	0,30	0,38	0,46
		0.010	0.011	0.012	0.015	0.018
K4	MM08-08.40-HF-MD06 F30M	0,26	0,28	0,30	0,38	0,46
		0.010	0.011	0.012	0.015	0.018
K5	MM08-08.40-HF-MD06 F30M	0,26	0,26	0,26	0,34	0,42
		0.010	0.010	0.010	0.013	0.017
K6	MM08-08.40-HF-MD06 F30M	0,26	0,28	0,30	0,38	0,46
		0.010	0.011	0.012	0.015	0.018
K7	MM08-08.40-HF-MD06 F30M	0,26	0,26	0,26	0,34	0,42
		0.010	0.010	0.010	0.013	0.017
N1	MM08-08.40-HF-MD06 F30M	0,26	0,40	0,40	0,55	0,70
		0.010	0.016	0.016	0.022	0.028
N2	MM08-08.40-HF-MD06 F30M	0,26	0,40	0,40	0,55	0,70
		0.010	0.016	0.016	0.022	0.028
N3	MM08-08.40-HF-MD06 F30M	0,26	0,40	0,40	0,55	0,70
		0.010	0.016	0.016	0.022	0.028
N11	MM08-08.40-HF-MD06 F30M	0,26	0,40	0,40	0,55	0,70
		0.010	0.016	0.016	0.022	0.028
S1	MM08-08.40-HF-MD06 F30M	0,16	0,20	0,20	0,26	0,32
		0.0065	0.0080	0.0080	0.010	0.013
S2	MM08-08.40-HF-MD06 F30M	0,16	0,20	0,20	0,26	0,32
		0.0065	0.0080	0.0080	0.010	0.013
S3	MM08-08.40-HF-MD06 F30M	0,16	0,19	0,19	0,24	0,30
		0.0065	0.0075	0.0075	0.0095	0.012
S11	MM08-08.40-HF-MD06 F30M	0,18	0,24	0,24	0,30	0,36
		0.0070	0.0095	0.0095	0.012	0.014
S12	MM08-08.40-HF-MD06 F30M	0,18	0,24	0,24	0,30	0,36
		0.0070	0.0095	0.0095	0.012	0.014
S13	MM08-08.40-HF-MD06 F30M	0,16	0,20	0,20	0,26	0,32
		0.0065	0.0080	0.0080	0.010	0.013
H5	MM08-08.40-HF-MD06 F30M	0,20	0,20	0,20	0,25	0,30
		0.0080	0.0080	0.0080	0.010	0.012
H8	MM08-08.40-HF-MD06 F30M	0,18	0,16	0,15	0,19	0,24
		0.0070	0.0065	0.0060	0.0075	0.0095
H11	MM08-08.40-HF-MD06 F30M	0,20	0,20	0,20	0,25	0,30
		0.0080	0.0080	0.0080	0.010	0.012
H12	MM08-08.40-HF-MD06 F30M	0,18	0,16	0,15	0,19	0,24
		0.0070	0.0065	0.0060	0.0075	0.0095
H21	MM08-08.40-HF-MD06 F30M	0,18	0,16	0,15	0,19	0,24
		0.0070	0.0065	0.0060	0.0075	0.0095



SMG = Seco material group
 f_z = mm/tooth (in/tooth), v_c = m/min (sf/min), a_p/DC = %
 All cutting data are start values

Universal
 Steel and cast iron
 Stainless steel and S-materials
 Stainless steel and S-materials
 Non ferrous
 Hard
 Graphite
 X-Heads
 Minimaster Plus
 Minimaster

MM08 High-Feed – Cutting data $v_c = (m/min)/(sf/min)$

	SMG	F30M			
		100%	70%	30%	20%
Universal	P1	250	305	350	375
		820	1000	1150	1225
Steel and cast iron	P2	245	300	345	365
		800	980	1125	1200
Stainless steel and S-materials	P3	215	260	300	315
		710	850	980	1025
	P4	190	230	265	275
		620	750	870	900
	P5	180	220	255	265
		590	720	840	870
	P6	205	250	285	300
		670	820	940	980
	P7	190	235	270	285
		620	770	890	940
	P8	180	220	250	265
		590	720	820	870
	P11	185	230	260	275
		610	750	850	900
	P12	120	145	165	175
		395	475	540	570
Non ferrous	M1	195	240	275	295
		640	790	900	970
	M2	165	195	230	240
		540	640	750	790
	M3	130	155	180	190
		425	510	590	620
	M4	100	120	140	145
		330	395	460	475
	M5	85	100	115	120
		280	330	375	395
Hard	K1	195	235	270	290
		640	770	890	950
	K2	170	210	240	255
		560	690	790	840
	K3	145	175	205	215
		475	570	670	710
	K4	140	170	195	205
		460	560	640	670
	K5	85	105	120	125
		280	345	395	410
	K6	125	150	170	180
		410	490	560	590
	K7	110	130	150	160
		360	425	490	520
Graphite	N1	1475	1800	2050	2125
		4850	5900	6725	6975
	N2	590	720	820	860
		1925	2350	2700	2825
	N3	395	480	550	570
		1300	1575	1800	1875
	N11	450	550	630	650
		1475	1800	2075	2125
X-Heads	S1	48	55	65	70
		155	180	215	230
	S2	39	46	50	55
		130	150	165	180
	S3	33	40	46	48
		110	130	150	155
	S11	65	80	90	95
		215	260	295	310
Minimaster Plus	S12	46	55	65	65
		150	180	215	215
	S13	27	32	36	38
		90	105	120	125
	H5	40	47	55	60
		130	155	180	195
	H8	41	50	55	60
		135	165	180	195
Minimaster	H11	50	60	70	75
		165	195	230	245
	H12	75	90	100	105
		245	295	330	345
	H21	41	50	55	60
		135	165	180	195

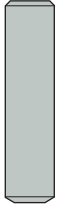
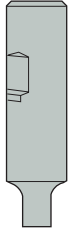
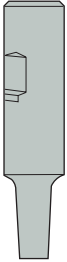
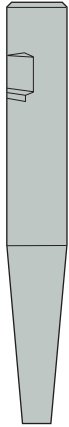
Shank design

Design 1, Keyway shank	Design 2, Cylindrical/Weldon back end and 90° front
	
Design 3, Cylindrical/Weldon back end tapered front 87°/89°	Design 4, Cylindrical/Weldon back end tapered front 80°/85°/87°
	
Design 5, Cylindrical back end double tapered front end 89°/85°	
	

Universal
Steel and cast iron
Stainless steel and S-materials
Stainless steel and S-materials
Non ferrous
Hard
Graphite
X-Heads
Minimaster Plus
Minimaster

MM10 Shank – Metric

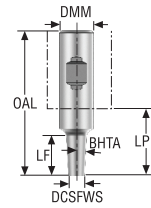

Designation	Item number	Type of mounting	DCSFWS	DMM	OAL	LFI	LPR	BHTA°	Design	RPMX	Weight	Spare part no.
MM10-20075.3-0010	75012787	Weldon	9,5	20,0	75,0	10,0	25,0	0,0	2	80000	0,2	4
MM10-20085.3-3023	75012788	Weldon	9,5	20,0	85,0	23,0	35,0	3,0	3	80000	0,2	4
MM10-20140.3-5060	75012789	Weldon	9,5	20,0	140,0	60,0	90,0	5,0	4	80000	0,3	5
MM10-10045.0-0007	00083979	Cylindrical	9,6	10,0	45,0	7,0	7,0	0,0	2	80000	0,1	2
MM10-16065.0-0000	75004925	Cylindrical	9,5	16,0	65,0	0,0	17,0	60,0	1	80000	0,1	1
MM10-16160.0-1035M	00094757	Cylindrical	9,5	16,0	160,0	35,0	112,0	1,0	3	80000	0,2	6
MM10-16160.0-1055M	00094758	Cylindrical	9,5	16,0	160,0	55,0	112,0	1,0	3	80000	0,2	7
MM10-16160.0-1075M	00094760	Cylindrical	9,5	16,0	160,0	75,0	112,0	1,0	3	80000	0,2	7
MM10-32250.0-10063	75069366	Cylindrical	9,5	32,0	250,0	63,8	190,0	10,0	4	80000	1,3	5
MM10-12060.0-0007DS	02580667	Cylindrical	9,6	12,0	60,0	7,0	15,0	0,0	2	76300	0,1	3
MM10-12085.0-3024DS	02580704	Cylindrical	9,5	12,0	85,0	23,8	40,0	3,0	4	76300	0,2	3
MM10-12100.0-1035DS	02580733	Cylindrical	9,5	12,0	100,0	35,0	55,0	1,0	3	76300	0,2	3
MM10-14120.0-1050DS	02580736	Cylindrical	9,5	14,0	120,0	50,0	75,0	1,0	3	76300	0,3	3
MM10-16085.0-0020DS	02580688	Cylindrical	9,5	16,0	85,0	20,0	37,0	0,0	2	76300	0,3	3
MM10-16105.0-0040DS	02580689	Cylindrical	9,5	16,0	105,0	40,0	57,0	0,0	2	76300	0,3	3
MM10-16160.0-1055DS	02580748	Cylindrical	9,5	16,0	160,0	55,0	112,0	1,0	3	76300	0,4	3
MM10-16160.0-1075DS	02580749	Cylindrical	9,5	16,0	160,0	75,0	112,0	1,0	3	76300	0,4	3
MM10-20250.0-1055DS	02580750	Cylindrical	9,5	20,0	250,0	55,0	200,0	1,0	5	76300	1,0	3

Spare Parts, included in delivery

Accessories

For cutter	Sleeve	Tension screw	Sleeve key
4	MM-06048	MM10-0627	H06-4
5	MM-06116	MM10-0627	H06-4
2	MM-06020	MM10-0627	H05-4
1	MM-06032	MM10-0627	H06-4
6	MM-06048	MM10-0651	H06-4
7	MM-06032	MM10-0688	H06-4
3	–	MM10-061027	–

MM10 Shank – Inch

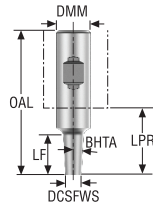

Designation	Item number	Type of mounting	DCSFWS	DMM	OAL	LF	LPR	BHTA°	Design		RPMX	Weight	Spare part no.
			inch	inch	inch	inch	inch					lbs	
MM10-0.75-3.0-3-0004	75015052	Weldon	0.360	0.750	2.953	0.394	0.984	0,0	2	✓	80000	0.440	3
MM10-0.75-3.3-3-3009	75015053	Weldon	0.374	0.750	3.346	0.906	1.378	3,0	3	✓	80000	0.440	3
MM10-0.75-5.5-3-5021	75015054	Weldon	0.374	0.750	5.512	2.150	3.543	5,0	4	✓	80000	0.660	5
MM10-0.38-1.8-0-0002	00096126	Cylindrical	0.360	0.375	1.772	0.276	0.276	0,0	2	✓	80000	0.220	2
MM10-0.62-2.6-0-0000	75005069	Cylindrical	0.374	0.625	2.559	0	0.669	60,0	1	✓	80000	0.220	1
MM10-0.62-6.3-0-1021	75054608	Cylindrical	0.360	0.625	6.299	2.165	4.409	1,0	3	✓	80000	0.440	7
MM10-1.25-10.0-0-10024	00096132	Cylindrical	0.374	1.250	9.843	2.484	7.480	10,0	4	✓	80000	2.870	5
MM10-0.75-10.0-0-1021DS	02593420	Cylindrical	0.360	0.750	9.843	2.165	7.874	1,0	5	✓	76300	1.980	4
MM10-0.75-4.1-0-0015DS	02593422	Cylindrical	0.360	0.750	4.134	1.575	2.165	0,0	2	✓	76300	0.880	4

Spare Parts, included in delivery

Accessories

For cutter	Sleeve	Tension screw	Sleeve key
3	MM-06048	MM10-0627	H06-4
5	MM-06116	MM10-0627	H06-4
2	MM-06020	MM10-0627	H05-4
1	MM-06032	MM10-0627	H06-4
7	MM-06032	MM10-0688	H06-4
4	-	MM10-061027	-

Universal

Steel and cast iron

Stainless steel and S-materials

Stainless steel and S-materials

Non ferrous

Hard

Graphite

X-Heads

Minimaster Plus

Minimaster

Slot milling/square shoulder milling

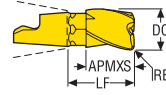

• For Torque keys and torque values, see page 720

Designation	DC	APMXS	RE	LF	RMPX°	C min	C max	FHA°	ZEPF	Wrench	Grades			
											T60M	F15M	F30M	F40M
	mm Inch	mm Inch	mm Inch	mm Inch							Coated			
MM10-09512-A30-E03	9,525 0.375	11,8 0.465	0,0 -	15,72 0.619	15,0	11,6	18,8	30	3				■	
MM10-09512-R03A30-M03	9,525 0.375	11,8 0.465	0,3 0.012	15,72 0.619	15,0	11,6	18,2	30	3					■
MM10-09512-R04A30-M03	9,525 0.375	11,8 0.465	0,4 0.016	15,72 0.619	15,0	11,6	18,0	30	3					■
MM10-09512-R08A30-M03	9,525 0.375	11,8 0.465	0,8 0.031	15,72 0.619	15,0	11,6	17,2	30	3					■
MM10-09512-R16A30-M03	9,525 0.375	11,8 0.465	1,6 0.063	15,72 0.619	15,0	11,6	15,6	30	3					■
MM10-10012-A30-E03	10,0 0.394	11,8 0.465	0,0 -	15,72 0.619	15,0	12,2	19,8	30	3				■	
MM10-10012-R05A30-M03	10,0 0.394	11,8 0.465	0,5 0.020	15,72 0.619	15,0	12,2	18,8	30	3					■
MM10-10012-R10A30-D03	10,0 0.394	11,8 0.465	1,0 0.039	15,72 0.619	15,0	12,2	17,8	30	3				■	
MM10-10012-R10A30-E03	10,0 0.394	11,8 0.465	1,0 0.039	15,72 0.619	15,0	12,2	17,8	30	3				■	
MM10-10012-R10A30-M03	10,0 0.394	11,8 0.465	1,0 0.039	15,72 0.619	15,0	12,2	17,8	30	3					■
MM10-10012-R20A30-M03	10,0 0.394	11,8 0.465	2,0 0.079	15,72 0.619	15,0	12,2	15,8	30	3					■
MM10-10012-R30A30-M03	10,0 0.394	11,8 0.465	3,0 0.118	15,72 0.619	15,0	12,2	13,8	30	3					■

Slot milling/square shoulder milling

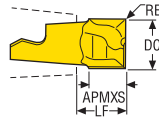

• For Torque keys and torque values, see page 720

Designation	DC	APMXS	RE	LF	RMPX°	C min	C max	FHA°	ZEFP	Wrench 	Grades			
											Coated			
											T60M	F15M	F30M	F40M
	mm Inch	mm Inch	mm Inch	mm Inch										
MM10-09510-M03	9,525 0.375	6,8 0.268	0,0 -	8,5 0.335	15,0	11,6	18,8	0	2		■			
MM10-09510-R04-MD04	9,525 0.375	6,8 0.268	0,4 0.016	8,49 0.334	15,0	11,6	18,0	0	2		■			
MM10-09510-R08A8-E03	9,525 0.375	6,6 0.260	0,8 0.031	8,37 0.330	15,0	11,6	17,2	8	2				■	
MM10-09807T-R03-D04	9,8 0.386	6,8 0.268	0,3 0.012	8,49 0.334	15,0	11,9	18,8	0	2		■			
MM10-10007-M03	10,0 0.394	6,9 0.272	0,0 -	8,5 0.335	15,0	12,2	19,8	0	2		■			
MM10-10007-R04A8-E03	10,0 0.394	6,6 0.260	0,4 0.016	8,44 0.332	15,0	12,2	19,0	8	2		■		■	
MM10-10007-R04-MD04	10,0 0.394	6,8 0.268	0,4 0.016	8,49 0.334	15,0	12,2	19,0	0	2		■		■	
MM10-10007-R04P-M03	10,0 0.394	6,7 0.264	0,4 0.016	8,38 0.330	15,0	12,2	19,0	0	2				■	
MM10-10007-R10-MD04	10,0 0.394	6,8 0.268	1,0 0.039	8,48 0.334	15,0	12,2	17,8	0	2		■		■	
MM10-10007-R20-MD04	10,0 0.394	6,8 0.268	2,0 0.079	8,46 0.333	15,0	12,2	15,8	0	2				■	
MM10-10007-R30-MD04	10,0 0.394	6,8 0.268	3,0 0.118	8,44 0.332	15,0	12,2	13,8	0	2				■	

Universal

Steel and cast iron

Stainless steel and S-materials

Stainless steel and S-materials

Non ferrous

Hard

Graphite

X-Heads

Minimaster Plus

Minimaster

Centre drilling

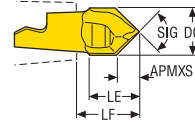

• For Torque keys and torque values, see page 720

Designation	DC	APMXS	LE	LF	SIG°	ZEFP	Wrench	Grades				
								T60M	F15M	F30M	F40M	
	mm <i>Inch</i>	mm <i>Inch</i>	mm <i>Inch</i>	mm <i>Inch</i>								
MM10-10005-C90-M03	10,0 0.394	4,69 0.185	10,0 0.394	11,8 0.465	90,0	2		■				
MM10-10007-C120-M03	10,0 0.394	2,7 0.106	10,4 0.409	11,8 0.465	120,0	2		■				

Chamfering

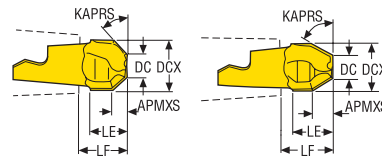

• For Torque keys and torque values, see page 720

Designation	DCX	DC	APMXS	LE	LF	KAPRS°	ZEFP	Wrench	Grades			
									T60M	F15M	F30M	F40M
	mm <i>Inch</i>	mm <i>Inch</i>	mm <i>Inch</i>	mm <i>Inch</i>	mm <i>Inch</i>							
MM10-10007-4525-E03	10,0 0.394	4,82 0.190	2,6 0.102	6,94 0.273	8,48 0.334	45,0	2		■			
MM10-10008-6040-E03	10,0 0.394	5,24 0.206	4,0 0.157	8,05 0.317	9,6 0.378	60,0	2		■			

Plunge milling

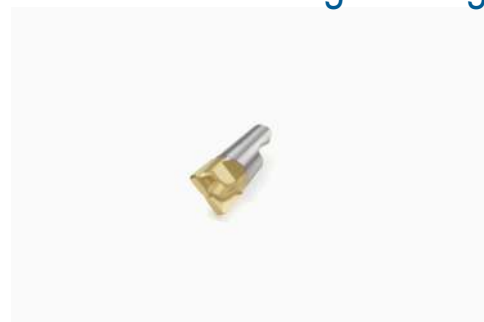
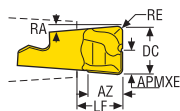

• For Torque keys and torque values, see page 720

Designation	DC	APMXE	RE	AZ	LF	RA°	ZEPF	Wrench	Grades			
									T60M	F15M	F30M	F40M
MM10-10007-R10-PL-MD04	10,0 0.394	5,0 0.197	1,0 0.039	7,1 0.280	8,48 0.334	5,0	2			■		

Universal

Steel and cast iron

Stainless steel and S-materials

Stainless steel and S-materials

Precision inserts for semi-finishing in all materials

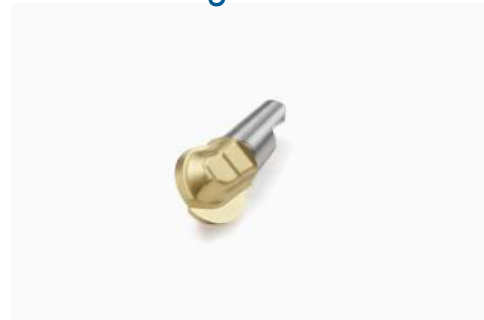
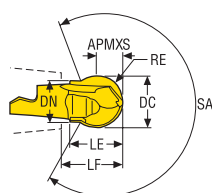

• For Torque keys and torque values, see page 720

Designation	DC	APMXS	RE	LE	LF	DN	SA°	ZEPF	Wrench	Grades			
										T60M	F15M	F30M	F40M
MM10-12012-B120P-M05	12,0 0.472	6,0 0.236	6,0 0.236	12,0 0.472	13,2 0.520	10,0 0.394	247,0	2			■		
MM10-12712-B120PF-M03	12,7 0.500	6,35 0.250	6,35 0.250	12,4 0.488	13,56 0.534	10,0 0.394	256,0	2		■			
MM10-12712-B120P-M05	12,7 0.500	6,35 0.250	6,35 0.250	12,4 0.488	13,56 0.534	10,0 0.394	256,0	2			■		

Non ferrous

Hard

Graphite

X-Heads

Minimaster Plus

Minimaster

Copy milling

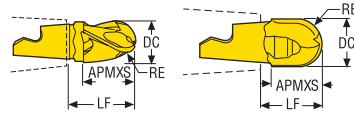

• For Torque keys and torque values, see page 720

Designation	DC	APMXS	RE	LF	FHA°	ZEFP	Wrench	Grades					
								T60M	F15M	F30M	F40M		
	mm Inch	mm Inch	mm Inch	mm Inch									
MM10-09510-B90P-M04	9,525 0.375	8,7 0.343	4,763 0.188	11,74 0.462	0,0	2		■		■			
MM10-10010-B90-MD04	10,0 0.394	10,2 0.402	5,0 0.197	11,77 0.463	0,0	2		■		■			
MM10-10010-B90PF-M02	10,0 0.394	8,73 0.344	5,0 0.197	11,74 0.462	0,0	2			■				
MM10-10010-B90P-M04	10,0 0.394	8,73 0.344	5,0 0.197	11,74 0.462	0,0	2				■			
MM10-10010-B90S-E04	10,0 0.394	10,2 0.402	5,0 0.197	11,77 0.463	0,0	2				■			
MM10-10012-B90A30-D03	10,0 0.394	11,8 0.465	5,0 0.197	15,72 0.619	30,0	3				■			
MM10-10012-B90A30-E03	10,0 0.394	11,8 0.465	5,0 0.197	15,72 0.619	30,0	3				■			
MM10-10012-B90A30-M03	10,0 0.394	11,8 0.465	5,0 0.197	15,72 0.619	30,0	3						■	

High feed

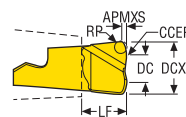

• For Torque keys and torque values, see page 720

Designation	DCX	DC	APMXS	RP	CCER	LF	RMPX°	C min	C max	ZEFP	Wrench	Grades			
												T60M	F15M	F30M	F40M
	mm Inch	mm Inch	mm Inch	mm Inch	mm Inch	mm Inch									
MM10-10.50-HF-MD08	10,0 0.394	5,0 0.197	0,44 0.017	1,13 0.044	5,0 0.197	8,5 0.335	5,0	12,2	18,2	2			■	■	

MM10 - Slot and Side milling – Insert selection – mm/Inch

SMG		a _p	f _z			
			100%	40%	20%	10%
P1	MM10-10012-R05A30-M03 F40M	2,0	0,044	0,044	0,055	0,070
		0.080	0.0017	0.0017	0.0022	0.0028
P2	MM10-10012-R05A30-M03 F40M	2,0	0,044	0,044	0,055	0,070
		0.080	0.0017	0.0017	0.0022	0.0028
P3	MM10-10012-R05A30-M03 F40M	2,0	0,042	0,042	0,050	0,070
		0.080	0.0017	0.0017	0.0020	0.0028
P4	MM10-10012-R05A30-M03 F40M	2,0	0,042	0,042	0,050	0,065
		0.080	0.0017	0.0017	0.0020	0.0026
P5	MM10-10012-R05A30-M03 F40M	2,0	0,040	0,040	0,050	0,065
		0.080	0.0016	0.0016	0.0020	0.0026
P6	MM10-10012-R05A30-M03 F40M	2,0	0,040	0,040	0,048	0,065
		0.080	0.0016	0.0016	0.0019	0.0026
P7	MM10-10012-R05A30-M03 F40M	2,0	0,040	0,040	0,048	0,065
		0.080	0.0016	0.0016	0.0019	0.0026
P8	MM10-10012-R05A30-M03 F40M	2,0	0,042	0,042	0,050	0,070
		0.080	0.0017	0.0017	0.0020	0.0028
P11	MM10-10012-R05A30-M03 F40M	2,0	0,040	0,040	0,048	0,065
		0.080	0.0016	0.0016	0.0019	0.0026
P12	MM10-10012-R05A30-M03 F40M	1,7	0,028	0,028	0,034	0,044
		0.065	0.0011	0.0011	0.0013	0.0017
M1	MM10-10012-R05A30-M03 F40M	2,0	0,044	0,044	0,055	0,070
		0.080	0.0017	0.0017	0.0022	0.0028
M2	MM10-10012-R05A30-M03 F40M	2,0	0,040	0,040	0,050	0,065
		0.080	0.0016	0.0016	0.0020	0.0026
M3	MM10-10012-R05A30-M03 F40M	1,7	0,032	0,032	0,040	0,050
		0.065	0.0013	0.0013	0.0016	0.0020
M4	MM10-10012-R05A30-M03 F40M	1,2	0,030	0,030	0,034	0,046
		0.048	0.0012	0.0012	0.0013	0.0018
M5	MM10-10012-R05A30-M03 F40M	1,2	0,030	0,030	0,034	0,046
		0.048	0.0012	0.0012	0.0013	0.0018
K1	MM10-10012-R10A30-E03 F30M	2,0	0,048	0,048	0,055	0,075
		0.080	0.0019	0.0019	0.0022	0.0030
K2	MM10-10012-R10A30-E03 F30M	2,0	0,044	0,042	0,050	0,065
		0.080	0.0017	0.0017	0.0020	0.0026
K3	MM10-10012-R10A30-E03 F30M	2,0	0,044	0,042	0,050	0,065
		0.080	0.0017	0.0017	0.0020	0.0026
K4	MM10-10012-R10A30-E03 F30M	2,0	0,044	0,042	0,050	0,065
		0.080	0.0017	0.0017	0.0020	0.0026
K5	MM10-10012-R10A30-D03 F30M	2,0	0,040	0,038	0,044	0,060
		0.080	0.0016	0.0015	0.0017	0.0024
K6	MM10-10012-R10A30-D03 F30M	2,0	0,044	0,042	0,050	0,065
		0.080	0.0017	0.0017	0.0020	0.0026
K7	MM10-10012-R10A30-D03 F30M	2,0	0,040	0,038	0,044	0,060
		0.080	0.0016	0.0015	0.0017	0.0024
N1	MM10-10012-R10A30-E03 F30M	2,0	0,060	0,060	0,070	0,095
		0.080	0.0024	0.0024	0.0028	0.0038
N2	MM10-10012-R10A30-E03 F30M	2,0	0,060	0,060	0,070	0,095
		0.080	0.0024	0.0024	0.0028	0.0038
N3	MM10-10012-R10A30-E03 F30M	2,0	0,060	0,060	0,070	0,095
		0.080	0.0024	0.0024	0.0028	0.0038
N11	MM10-10012-R10A30-E03 F30M	2,0	0,060	0,060	0,070	0,095
		0.080	0.0024	0.0024	0.0028	0.0038
S1	MM10-10012-R10A30-D03 F30M	1,2	0,036	0,034	0,036	0,046
		0.048	0.0014	0.0013	0.0014	0.0018
S2	MM10-10012-R10A30-D03 F30M	1,2	0,036	0,034	0,036	0,046
		0.048	0.0014	0.0013	0.0014	0.0018
S3	MM10-10012-R10A30-D03 F30M	1,2	0,032	0,032	0,034	0,042
		0.048	0.0013	0.0013	0.0013	0.0017
S11	MM10-10012-R05A30-M03 F40M	1,4	0,034	0,034	0,040	0,050
		0.055	0.0013	0.0013	0.0016	0.0020
S12	MM10-10012-R05A30-M03 F40M	1,4	0,034	0,034	0,040	0,050
		0.055	0.0013	0.0013	0.0016	0.0020
S13	MM10-10012-R05A30-M03 F40M	1,2	0,030	0,030	0,034	0,046
		0.048	0.0012	0.0012	0.0013	0.0018
H5	MM10-10012-R10A30-D03 F30M	1,7	0,030	0,030	0,034	0,044
		0.065	0.0012	0.0012	0.0013	0.0017
H8	MM10-10012-R10A30-D03 F30M	1,4	0,025	0,024	0,026	0,034
		0.055	0.0010	0.00095	0.0010	0.0013
H11	MM10-10012-R10A30-D03 F30M	1,7	0,030	0,030	0,034	0,044
		0.065	0.0012	0.0012	0.0013	0.0017
H12	MM10-10012-R10A30-D03 F30M	1,4	0,025	0,024	0,026	0,034
		0.055	0.0010	0.00095	0.0010	0.0013
H21	MM10-10012-R10A30-D03 F30M	1,4	0,025	0,024	0,026	0,034
		0.055	0.0010	0.00095	0.0010	0.0013

SMG = Seco material group
 f_z = mm/tooth (in/tooth), v_c = m/min (sf/min), a_p/DC = %
 All cutting data are start values

Universal
 Steel and cast iron
 Stainless steel and S-materials
 Stainless steel and S-materials
 Non ferrous
 Hard
 Graphite
 X-Heads
 Minimaster Plus
 Minimaster

MM10 - Slot and Side milling – Cutting data $v_c = (m/min)/(sf/min)$

SMG	F30M				F40M				T60M			
	100%	40%	20%	10%	100%	40%	20%	10%	100%	40%	20%	10%
P1	265	330	365	405	250	315	345	385	190	240	270	295
	870	1075	1200	1325	820	1025	1125	1275	620	790	890	970
P2	260	320	360	390	245	305	340	375	185	235	260	290
	850	1050	1175	1275	800	1000	1125	1225	610	770	850	950
P3	225	280	315	340	215	265	295	325	165	205	230	250
	740	920	1025	1125	710	870	970	1075	540	670	750	820
P4	200	245	275	305	190	235	260	290	145	180	200	225
	660	800	900	1000	620	770	850	950	475	590	660	740
P5	190	235	265	290	180	225	250	275	140	175	195	215
	620	770	870	950	590	740	820	900	460	570	640	710
P6	215	265	295	325	205	250	280	310	155	195	220	240
	710	870	970	1075	670	820	920	1025	510	640	720	790
P7	200	250	280	310	190	240	265	290	145	185	205	225
	660	820	920	1025	620	790	870	950	475	610	670	740
P8	190	235	265	285	180	225	250	270	140	175	190	210
	620	770	870	940	590	740	820	890	460	570	620	690
P11	195	245	270	300	185	230	260	285	140	180	200	220
	640	800	890	980	610	750	850	940	460	590	660	720
P12	125	150	170	185	115	145	160	175	90	115	125	140
	410	490	560	610	375	475	520	570	295	375	410	460
M1	—	—	—	—	200	245	275	305	150	190	210	235
	—	—	—	—	660	800	900	1000	490	620	690	770
M2	—	—	—	—	165	200	225	250	125	155	175	190
	—	—	—	—	540	660	740	820	410	510	570	620
M3	—	—	—	—	130	160	175	195	100	125	140	155
	—	—	—	—	425	520	570	640	330	410	460	510
M4	—	—	—	—	100	120	135	150	75	95	105	115
	—	—	—	—	330	395	445	490	245	310	345	375
M5	—	—	—	—	80	100	115	125	65	80	90	95
	—	—	—	—	260	330	375	410	215	260	295	310
K1	205	255	285	310	195	240	270	300	150	185	205	230
	670	840	940	1025	640	790	890	980	490	610	670	750
K2	180	225	250	275	170	215	235	260	130	165	185	200
	590	740	820	900	560	710	770	850	425	540	610	660
K3	150	190	210	235	145	180	200	220	110	140	155	170
	490	620	690	770	475	590	660	720	360	460	510	560
K4	145	180	200	225	140	170	190	210	105	130	150	165
	475	590	660	740	460	560	620	690	345	425	490	540
K5	90	110	125	135	85	105	115	125	65	80	90	100
	295	360	410	445	280	345	375	410	215	260	295	330
K6	130	160	180	195	120	150	170	185	95	115	130	145
	425	520	590	640	395	490	560	610	310	375	425	475
K7	110	140	155	170	105	135	150	165	85	105	115	125
	360	460	510	560	345	445	490	540	280	345	375	410
N1	1550	1925	2150	2350	1475	1825	2025	2250	1125	1400	1550	1725
	5075	6325	7050	7700	4850	6000	6650	7375	3700	4600	5075	5650
N2	630	780	870	950	600	740	820	910	450	570	630	690
	2075	2550	2850	3125	1975	2425	2700	2975	1475	1875	2075	2275
N3	415	520	580	630	395	495	550	610	300	380	420	460
	1350	1700	1900	2075	1300	1625	1800	2000	980	1250	1375	1500
N11	475	590	660	720	455	570	620	690	345	430	480	530
	1550	1925	2175	2350	1500	1875	2025	2275	1125	1400	1575	1750
S1	48	60	65	75	46	55	65	70	36	45	50	55
	155	195	215	245	150	180	215	230	120	150	165	180
S2	38	48	55	60	37	46	50	55	29	36	40	44
	125	155	180	195	120	150	165	180	95	120	130	145
S3	34	42	47	50	32	40	45	49	25	32	35	38
	110	140	155	165	105	130	150	160	80	105	115	125
S11	—	—	—	—	65	80	90	100	50	65	70	75
	—	—	—	—	215	260	295	330	165	215	230	245
S12	—	—	—	—	45	55	60	70	35	43	49	55
	—	—	—	—	150	180	195	230	115	140	160	180
S13	—	—	—	—	26	32	36	39	20	25	28	30
	—	—	—	—	85	105	120	130	65	80	90	100
H5	41	50	55	60	39	48	55	60	30	38	42	46
	135	165	180	195	130	155	180	195	100	125	140	150
H8	42	50	60	65	40	50	55	60	31	39	44	48
	140	165	195	215	130	165	180	195	100	130	145	155
H11	50	65	70	80	49	60	70	75	38	48	55	60
	165	215	230	260	160	195	230	245	125	155	180	195
H12	75	95	105	115	70	90	100	110	55	70	80	85
	245	310	345	375	230	295	330	360	180	230	260	280
H21	42	50	60	65	40	50	55	60	31	39	44	48
	140	165	195	215	130	165	180	195	100	130	145	155

MM10 Z3 – Copy milling – Insert selection – Roughing – mm/Inch

SMG		a _p	f _z			
			100%	40%	20%	10%
P1	MM10-10012-B90A30-M03 F40M	2,0	0,055	0,050	0,055	0,070
		0.080	0.0022	0.0020	0.0022	0.0028
P2	MM10-10012-B90A30-M03 F40M	2,0	0,055	0,050	0,055	0,075
		0.080	0.0022	0.0020	0.0022	0.0030
P3	MM10-10012-B90A30-M03 F40M	2,0	0,050	0,050	0,050	0,070
		0.080	0.0020	0.0020	0.0020	0.0028
P4	MM10-10012-B90A30-M03 F40M	2,0	0,050	0,048	0,050	0,065
		0.080	0.0020	0.0019	0.0020	0.0026
P5	MM10-10012-B90A30-M03 F40M	2,0	0,050	0,048	0,050	0,065
		0.080	0.0020	0.0019	0.0020	0.0026
P6	MM10-10012-B90A30-M03 F40M	2,0	0,050	0,048	0,050	0,065
		0.080	0.0020	0.0019	0.0020	0.0026
P7	MM10-10012-B90A30-M03 F40M	2,0	0,050	0,048	0,050	0,065
		0.080	0.0020	0.0019	0.0020	0.0026
P8	MM10-10012-B90A30-M03 F40M	2,0	0,050	0,050	0,050	0,070
		0.080	0.0020	0.0020	0.0020	0.0028
P11	MM10-10012-B90A30-M03 F40M	2,0	0,050	0,048	0,050	0,065
		0.080	0.0020	0.0019	0.0020	0.0026
P12	MM10-10012-B90A30-M03 F40M	1,7	0,034	0,034	0,034	0,044
		0.065	0.0013	0.0013	0.0013	0.0018
M1	MM10-10012-B90A30-M03 F40M	2,0	0,055	0,050	0,055	0,075
		0.080	0.0022	0.0020	0.0022	0.0030
M2	MM10-10012-B90A30-M03 F40M	2,0	0,050	0,048	0,050	0,065
		0.080	0.0020	0.0019	0.0020	0.0026
M3	MM10-10012-B90A30-M03 F40M	1,7	0,042	0,040	0,042	0,055
		0.065	0.0017	0.0016	0.0017	0.0022
M4	MM10-10012-B90A30-M03 F40M	1,2	0,038	0,036	0,036	0,046
		0.048	0.0015	0.0014	0.0014	0.0019
M5	MM10-10012-B90A30-M03 F40M	1,2	0,038	0,036	0,036	0,046
		0.048	0.0015	0.0014	0.0014	0.0019
K1	MM10-10012-B90A30-E03 F30M	2,0	0,055	0,050	0,055	0,075
		0.080	0.0022	0.0020	0.0022	0.0030
K2	MM10-10012-B90A30-E03 F30M	2,0	0,050	0,048	0,050	0,065
		0.080	0.0020	0.0019	0.0020	0.0026
K3	MM10-10012-B90A30-E03 F30M	2,0	0,050	0,048	0,050	0,065
		0.080	0.0020	0.0019	0.0020	0.0026
K4	MM10-10012-B90A30-E03 F30M	2,0	0,050	0,048	0,050	0,065
		0.080	0.0020	0.0019	0.0020	0.0026
K5	MM10-10012-B90A30-D03 F30M	2,0	0,044	0,042	0,046	0,060
		0.080	0.0017	0.0017	0.0018	0.0024
K6	MM10-10012-B90A30-D03 F30M	2,0	0,050	0,048	0,050	0,065
		0.080	0.0020	0.0019	0.0020	0.0026
K7	MM10-10012-B90A30-D03 F30M	2,0	0,044	0,042	0,046	0,060
		0.080	0.0017	0.0017	0.0018	0.0024
N1	MM10-10012-B90A30-E03 F30M	2,0	0,070	0,065	0,070	0,095
		0.080	0.0028	0.0026	0.0028	0.0038
N2	MM10-10012-B90A30-E03 F30M	2,0	0,070	0,065	0,070	0,095
		0.080	0.0028	0.0026	0.0028	0.0038
N3	MM10-10012-B90A30-E03 F30M	2,0	0,070	0,065	0,070	0,095
		0.080	0.0028	0.0026	0.0028	0.0038
N11	MM10-10012-B90A30-E03 F30M	2,0	0,070	0,065	0,070	0,095
		0.080	0.0028	0.0026	0.0028	0.0038
S1	MM10-10012-B90A30-D03 F30M	1,2	0,038	0,036	0,036	0,046
		0.048	0.0015	0.0014	0.0014	0.0019
S2	MM10-10012-B90A30-D03 F30M	1,2	0,038	0,036	0,036	0,046
		0.048	0.0015	0.0014	0.0014	0.0019
S3	MM10-10012-B90A30-D03 F30M	1,2	0,036	0,034	0,034	0,042
		0.048	0.0014	0.0013	0.0013	0.0017
S11	MM10-10012-B90A30-M03 F40M	1,4	0,042	0,042	0,042	0,055
		0.055	0.0017	0.0017	0.0017	0.0022
S12	MM10-10012-B90A30-M03 F40M	1,4	0,042	0,042	0,042	0,055
		0.055	0.0017	0.0017	0.0017	0.0022
S13	MM10-10012-B90A30-M03 F40M	1,2	0,038	0,036	0,036	0,046
		0.048	0.0015	0.0014	0.0014	0.0019
H5	MM10-10012-B90A30-D03 F30M	1,7	0,034	0,034	0,034	0,044
		0.065	0.0013	0.0013	0.0013	0.0018
H8	MM10-10012-B90A30-D03 F30M	1,4	0,028	0,026	0,026	0,034
		0.055	0.0011	0.0010	0.0010	0.0013
H11	MM10-10012-B90A30-D03 F30M	1,7	0,034	0,034	0,034	0,044
		0.065	0.0013	0.0013	0.0013	0.0018
H12	MM10-10012-B90A30-D03 F30M	1,4	0,028	0,026	0,026	0,034
		0.055	0.0011	0.0010	0.0010	0.0013
H21	MM10-10012-B90A30-D03 F30M	1,4	0,028	0,026	0,026	0,034
		0.055	0.0011	0.0010	0.0010	0.0013

SMG = Seco material group
 f_z = mm/tooth (in/tooth), v_c = m/min (sf/min), a_p/DC = %
 All cutting data are start values

Universal
 Steel and cast iron
 Stainless steel and S-materials
 Stainless steel and S-materials
 Non ferrous
 Hard
 Graphite
 X-Heads
 Minimaster Plus
 Minimaster

MM10 Z3 – Copy milling – Insert selection – Finishing – mm/Inch

SMG		a_p		f_z			
				15%	10%	5%	2%
P1	MM10-10012-B90A30-E03 F30M	2,0	0,060	0,070	0,10	0,16	
		0,080	0,0024	0,0028	0,0040	0,0065	
P2	MM10-10012-B90A30-E03 F30M	2,0	0,060	0,075	0,10	0,16	
		0,080	0,0024	0,0030	0,0040	0,0065	
P3	MM10-10012-B90A30-E03 F30M	2,0	0,060	0,070	0,095	0,15	
		0,080	0,0024	0,0028	0,0038	0,0060	
P4	MM10-10012-B90A30-E03 F30M	2,0	0,055	0,065	0,095	0,15	
		0,080	0,0022	0,0026	0,0038	0,0060	
P5	MM10-10012-B90A30-E03 F30M	2,0	0,055	0,065	0,090	0,15	
		0,080	0,0022	0,0026	0,0036	0,0060	
P6	MM10-10012-B90A30-E03 F30M	2,0	0,055	0,065	0,090	0,15	
		0,080	0,0022	0,0026	0,0036	0,0060	
P7	MM10-10012-B90A30-E03 F30M	2,0	0,055	0,065	0,090	0,15	
		0,080	0,0022	0,0026	0,0036	0,0060	
P8	MM10-10012-B90A30-E03 F30M	2,0	0,060	0,070	0,095	0,15	
		0,080	0,0024	0,0028	0,0038	0,0060	
P11	MM10-10012-B90A30-E03 F30M	2,0	0,055	0,065	0,090	0,15	
		0,080	0,0022	0,0026	0,0036	0,0060	
P12	MM10-10012-B90A30-E03 F30M	1,7	0,038	0,044	0,060	0,10	
		0,065	0,0015	0,0018	0,0024	0,0040	
M1	MM10-10012-B90A30-E03 F30M	2,0	0,060	0,075	0,10	0,16	
		0,080	0,0024	0,0030	0,0040	0,0065	
M2	MM10-10012-B90A30-E03 F30M	2,0	0,055	0,065	0,090	0,15	
		0,080	0,0022	0,0026	0,0036	0,0060	
M3	MM10-10012-B90A30-E03 F30M	1,7	0,046	0,055	0,075	0,12	
		0,065	0,0018	0,0022	0,0030	0,0048	
M4	MM10-10012-B90A30-E03 F30M	1,2	0,040	0,046	0,065	0,10	
		0,048	0,0016	0,0019	0,0026	0,0040	
M5	MM10-10012-B90A30-E03 F30M	1,2	0,040	0,046	0,065	0,10	
		0,048	0,0016	0,0019	0,0026	0,0040	
K1	MM10-10012-B90A30-E03 F30M	2,0	0,060	0,075	0,10	0,16	
		0,080	0,0024	0,0030	0,0040	0,0065	
K2	MM10-10012-B90A30-E03 F30M	2,0	0,055	0,065	0,090	0,15	
		0,080	0,0022	0,0026	0,0036	0,0060	
K3	MM10-10012-B90A30-E03 F30M	2,0	0,055	0,065	0,090	0,15	
		0,080	0,0022	0,0026	0,0036	0,0060	
K4	MM10-10012-B90A30-E03 F30M	2,0	0,055	0,065	0,090	0,15	
		0,080	0,0022	0,0026	0,0036	0,0060	
K5	MM10-10012-B90A30-E03 F30M	2,0	0,050	0,060	0,080	0,13	
		0,080	0,0020	0,0024	0,0032	0,0050	
K6	MM10-10012-B90A30-E03 F30M	2,0	0,055	0,065	0,090	0,15	
		0,080	0,0022	0,0026	0,0036	0,0060	
K7	MM10-10012-B90A30-E03 F30M	2,0	0,050	0,060	0,080	0,13	
		0,080	0,0020	0,0024	0,0032	0,0050	
N1	MM10-10012-B90A30-E03 F30M	2,0	0,080	0,095	0,13	0,22	
		0,080	0,0032	0,0038	0,0050	0,0085	
N2	MM10-10012-B90A30-E03 F30M	2,0	0,080	0,095	0,13	0,22	
		0,080	0,0032	0,0038	0,0050	0,0085	
N3	MM10-10012-B90A30-E03 F30M	2,0	0,080	0,095	0,13	0,22	
		0,080	0,0032	0,0038	0,0050	0,0085	
N11	MM10-10012-B90A30-E03 F30M	2,0	0,080	0,095	0,13	0,22	
		0,080	0,0032	0,0038	0,0050	0,0085	
S1	MM10-10012-B90A30-E03 F30M	1,2	0,040	0,046	0,065	0,10	
		0,048	0,0016	0,0019	0,0026	0,0040	
S2	MM10-10012-B90A30-E03 F30M	1,2	0,040	0,046	0,065	0,10	
		0,048	0,0016	0,0019	0,0026	0,0040	
S3	MM10-10012-B90A30-E03 F30M	1,2	0,038	0,042	0,060	0,095	
		0,048	0,0015	0,0017	0,0024	0,0038	
S11	MM10-10012-B90A30-E03 F30M	1,4	0,046	0,055	0,075	0,12	
		0,055	0,0018	0,0022	0,0030	0,0048	
S12	MM10-10012-B90A30-E03 F30M	1,4	0,046	0,055	0,075	0,12	
		0,055	0,0018	0,0022	0,0030	0,0048	
S13	MM10-10012-B90A30-E03 F30M	1,2	0,040	0,046	0,065	0,10	
		0,048	0,0016	0,0019	0,0026	0,0040	
H5	MM10-10012-B90A30-E03 F30M	1,7	0,038	0,044	0,060	0,10	
		0,065	0,0015	0,0018	0,0024	0,0040	
H8	MM10-10012-B90A30-E03 F30M	1,4	0,030	0,034	0,048	0,075	
		0,055	0,0012	0,0013	0,0019	0,0030	
H11	MM10-10012-B90A30-E03 F30M	1,7	0,038	0,044	0,060	0,10	
		0,065	0,0015	0,0018	0,0024	0,0040	
H12	MM10-10012-B90A30-E03 F30M	1,4	0,030	0,034	0,048	0,075	
		0,055	0,0012	0,0013	0,0019	0,0030	
H21	MM10-10012-B90A30-E03 F30M	1,4	0,030	0,034	0,048	0,075	
		0,055	0,0012	0,0013	0,0019	0,0030	

SMG = Seco material group
 f_z = mm/tooth (in/tooth), v_c = m/min (sf/min), a_p/DC = %
 All cutting data are start values

MM10 Z3 – Copy milling – Cutting data $v_c = (m/min)/(sf/min)$

SMG	F30M					F40M				
	100%	20%	10%	5%	2%	100%	20%	10%	5%	2%
P1	280	330	355	380	380	270	310	335	365	360
	920	1075	1175	1250	1250	890	1025	1100	1200	1175
P2	275	320	340	370	370	260	305	325	355	355
	900	1050	1125	1225	1225	850	1000	1075	1175	1175
P3	240	280	295	320	320	230	265	280	305	305
	790	920	970	1050	1050	750	870	920	1000	1000
P4	210	245	265	285	285	200	235	250	270	270
	690	800	870	940	940	660	770	820	890	890
P5	200	235	250	275	270	190	225	240	260	260
	660	770	820	900	890	620	740	790	850	850
P6	225	265	285	305	305	215	250	270	290	290
	740	870	940	1000	1000	710	820	890	950	950
P7	215	250	265	290	285	205	235	255	275	275
	710	820	870	950	940	670	770	840	900	900
P8	200	235	250	270	270	190	225	235	260	260
	660	770	820	890	890	620	740	770	850	850
P11	205	240	260	280	280	195	230	245	265	265
	670	790	850	920	920	640	750	800	870	870
P12	130	160	160	175	175	125	150	155	165	165
	425	520	520	570	570	410	490	510	540	540
M1	220	255	275	300	300	210	245	260	285	285
	720	840	900	980	980	690	800	850	940	940
M2	180	210	225	245	245	175	200	215	235	230
	590	690	740	800	800	570	660	710	770	750
M3	145	175	175	190	190	135	165	170	185	180
	475	570	590	620	620	445	540	560	610	590
M4	95	140	135	145	145	95	130	130	140	140
	310	460	475	475	475	310	425	445	460	460
M5	80	115	115	120	120	75	110	105	115	115
	260	375	395	395	395	245	360	375	375	375
K1	220	255	270	295	295	205	240	255	280	280
	720	840	890	970	970	670	790	840	920	920
K2	190	220	240	260	255	180	210	230	245	245
	620	720	790	850	840	590	690	750	800	800
K3	160	190	200	220	215	155	180	195	210	205
	520	620	660	720	710	510	590	640	690	670
K4	155	180	195	210	205	145	170	185	200	195
	510	590	640	690	670	475	560	610	660	640
K5	95	110	115	125	125	90	105	110	120	120
	310	360	375	410	410	295	345	360	395	395
K6	135	160	170	185	185	130	150	160	175	175
	445	520	560	610	610	425	490	520	570	570
K7	120	140	150	160	160	115	130	140	155	155
	395	460	490	520	520	375	425	460	510	510
N1	1650	1925	2050	2225	2200	1575	1825	1950	2125	2100
	5425	6325	6725	7300	7225	5175	6000	6400	6975	6900
N2	670	780	830	900	890	640	740	790	860	850
	2200	2550	2725	2950	2925	2100	2425	2600	2825	2800
N3	445	520	550	600	590	425	495	530	570	560
	1450	1700	1800	1975	1925	1400	1625	1750	1875	1825
N11	510	590	630	690	680	485	560	600	650	650
	1675	1925	2075	2275	2225	1600	1825	1975	2125	2125
S1	45	65	65	70	70	43	60	60	65	65
	150	215	215	230	230	140	195	215	215	215
S2	37	50	50	55	55	35	49	48	50	50
	120	165	180	180	180	115	160	165	165	165
S3	32	45	44	48	48	30	43	42	46	45
	105	150	155	155	155	100	140	150	150	150
S11	70	90	90	95	95	65	85	85	90	90
	230	295	295	310	310	215	280	280	295	295
S12	48	60	60	65	65	45	60	60	65	65
	155	195	215	215	215	150	195	195	215	215
S13	26	36	36	38	38	24	34	34	37	37
	85	120	125	125	125	80	110	120	120	120
H5	43	55	55	60	55	41	50	50	55	55
	140	180	180	195	180	135	165	165	180	180
H8	41	55	55	60	60	39	50	50	55	55
	135	180	180	195	195	130	165	180	180	180
H11	55	65	70	75	75	50	65	65	70	70
	180	215	230	245	245	165	215	215	230	230
H12	75	100	100	105	105	70	95	95	100	100
	245	330	330	345	345	230	310	310	330	330
H21	41	55	55	60	60	39	50	50	55	55
	135	180	180	195	195	130	165	180	180	180

Universal
Steel and cast iron
Stainless steel and S-materials
Stainless steel and S-materials
Non ferrous
Hard
Graphite
X-Heads
Minimaster Plus
Minimaster

MM10 Z2 – Copy milling – Insert selection – Roughing – mm/inch

SMG		a _p	f _z			
			100%	40%	20%	10%
P1	MM10-10010-B90S-E04 F30M	4,0	0,060	0,060	0,070	0,095
		0.16	0.0024	0.0024	0.0028	0.0038
P2	MM10-10010-B90S-E04 F30M	4,0	0,065	0,065	0,075	0,095
		0.16	0.0026	0.0026	0.0030	0.0038
P3	MM10-10010-B90S-E04 F30M	4,0	0,060	0,060	0,070	0,090
		0.16	0.0024	0.0024	0.0028	0.0036
P4	MM10-10010-B90-MD04 F30M	4,0	0,060	0,060	0,070	0,090
		0.16	0.0024	0.0024	0.0028	0.0036
P5	MM10-10010-B90-MD04 F30M	4,0	0,060	0,055	0,065	0,090
		0.16	0.0024	0.0022	0.0026	0.0036
P6	MM10-10010-B90-MD04 F30M	4,0	0,055	0,055	0,065	0,085
		0.16	0.0022	0.0022	0.0026	0.0034
P7	MM10-10010-B90-MD04 F30M	4,0	0,055	0,055	0,065	0,085
		0.16	0.0022	0.0022	0.0026	0.0034
P8	MM10-10010-B90-MD04 F30M	4,0	0,060	0,060	0,070	0,090
		0.16	0.0024	0.0024	0.0028	0.0036
P11	MM10-10010-B90-MD04 F30M	4,0	0,055	0,055	0,065	0,085
		0.16	0.0022	0.0022	0.0026	0.0034
P12	MM10-10010-B90-MD04 F30M	3,5	0,040	0,040	0,046	0,060
		0.14	0.0016	0.0016	0.0018	0.0024
M1	MM10-10010-B90S-E04 F30M	4,0	0,065	0,065	0,075	0,095
		0.16	0.0026	0.0026	0.0030	0.0038
M2	MM10-10010-B90S-E04 F30M	4,0	0,060	0,055	0,065	0,090
		0.16	0.0024	0.0022	0.0026	0.0036
M3	MM10-10010-B90S-E04 F30M	3,5	0,048	0,048	0,055	0,070
		0.14	0.0019	0.0019	0.0022	0.0028
M4	MM10-10010-B90-MD04 F30M	2,5	0,044	0,044	0,048	0,060
		0.10	0.0017	0.0017	0.0019	0.0026
M5	MM10-10010-B90-MD04 F30M	2,5	0,044	0,044	0,048	0,060
		0.10	0.0017	0.0017	0.0019	0.0026
K1	MM10-10010-B90S-E04 F30M	4,0	0,065	0,065	0,075	0,095
		0.16	0.0026	0.0026	0.0030	0.0038
K2	MM10-10010-B90S-E04 F30M	4,0	0,060	0,055	0,065	0,090
		0.16	0.0024	0.0022	0.0026	0.0036
K3	MM10-10010-B90S-E04 F30M	4,0	0,060	0,055	0,065	0,090
		0.16	0.0024	0.0022	0.0026	0.0036
K4	MM10-10010-B90S-E04 F30M	4,0	0,060	0,055	0,065	0,090
		0.16	0.0024	0.0022	0.0026	0.0036
K5	MM10-10010-B90-MD04 F30M	4,0	0,050	0,050	0,060	0,080
		0.16	0.0020	0.0020	0.0024	0.0032
K6	MM10-10010-B90-MD04 F30M	4,0	0,060	0,055	0,065	0,090
		0.16	0.0024	0.0022	0.0026	0.0036
K7	MM10-10010-B90-MD04 F30M	4,0	0,050	0,050	0,060	0,080
		0.16	0.0020	0.0020	0.0024	0.0032
N1	MM10-10010-B90S-E04 F30M	4,0	0,080	0,080	0,095	0,12
		0.16	0.0032	0.0032	0.0038	0.0048
N2	MM10-10010-B90S-E04 F30M	4,0	0,080	0,080	0,095	0,12
		0.16	0.0032	0.0032	0.0038	0.0048
N3	MM10-10010-B90S-E04 F30M	4,0	0,080	0,080	0,095	0,12
		0.16	0.0032	0.0032	0.0038	0.0048
N11	MM10-10010-B90S-E04 F30M	4,0	0,080	0,080	0,095	0,12
		0.16	0.0032	0.0032	0.0038	0.0048
S1	MM10-10010-B90S-E04 F30M	2,5	0,044	0,044	0,048	0,060
		0.10	0.0017	0.0017	0.0019	0.0026
S2	MM10-10010-B90S-E04 F30M	2,5	0,044	0,044	0,048	0,060
		0.10	0.0017	0.0017	0.0019	0.0026
S3	MM10-10010-B90S-E04 F30M	2,5	0,042	0,042	0,044	0,055
		0.10	0.0017	0.0017	0.0017	0.0024
S11	MM10-10010-B90S-E04 F30M	3,0	0,048	0,048	0,055	0,070
		0.12	0.0019	0.0019	0.0022	0.0028
S12	MM10-10010-B90S-E04 F30M	3,0	0,048	0,048	0,055	0,070
		0.12	0.0019	0.0019	0.0022	0.0028
S13	MM10-10010-B90S-E04 F30M	2,5	0,044	0,044	0,048	0,060
		0.10	0.0017	0.0017	0.0019	0.0026
H5	MM10-10010-B90-MD04 F30M	3,5	0,040	0,040	0,046	0,060
		0.14	0.0016	0.0016	0.0018	0.0024
H8	MM10-10010-B90-MD04 F30M	3,0	0,032	0,032	0,036	0,046
		0.12	0.0013	0.0013	0.0014	0.0018
H11	MM10-10010-B90-MD04 F30M	3,5	0,040	0,040	0,046	0,060
		0.14	0.0016	0.0016	0.0018	0.0024
H12	MM10-10010-B90-MD04 F30M	3,0	0,032	0,032	0,036	0,046
		0.12	0.0013	0.0013	0.0014	0.0018
H21	MM10-10010-B90-MD04 F30M	3,0	0,032	0,032	0,036	0,046
		0.12	0.0013	0.0013	0.0014	0.0018

SMG = Seco material group
f_z = mm/tooth (in/tooth), v_c = m/min (sf/min), a_p/DC = %
All cutting data are start values

MM10 Z2 – Copy milling – Insert selection – Finishing – mm/Inch

SMG		a _p	f _z			
			15%	10%	5%	2%
P1	MM10-10010-B90PF-M02 F15M	3,5 0.14	0,040 0.0016	0,048 0.0019	0,065 0.0026	0,11 0.0044
P2	MM10-10010-B90PF-M02 F15M	3,5 0.14	0,042 0.0017	0,048 0.0019	0,070 0.0028	0,11 0.0044
P3	MM10-10010-B90PF-M02 F15M	3,5 0.14	0,038 0.0015	0,046 0.0018	0,065 0.0026	0,10 0.0040
P4	MM10-10010-B90PF-M02 F15M	3,5 0.14	0,038 0.0015	0,046 0.0018	0,065 0.0026	0,10 0.0040
P5	MM10-10010-B90PF-M02 F15M	3,5 0.14	0,038 0.0015	0,044 0.0017	0,060 0.0024	0,10 0.0040
P6	MM10-10010-B90PF-M02 F15M	3,5 0.14	0,038 0.0015	0,044 0.0017	0,060 0.0024	0,095 0.0038
P7	MM10-10010-B90PF-M02 F15M	3,5 0.14	0,038 0.0015	0,044 0.0017	0,060 0.0024	0,095 0.0038
P8	MM10-10010-B90PF-M02 F15M	3,5 0.14	0,038 0.0015	0,046 0.0018	0,065 0.0026	0,10 0.0040
P11	MM10-10010-B90PF-M02 F15M	3,5 0.14	0,038 0.0015	0,044 0.0017	0,060 0.0024	0,095 0.0038
P12	MM10-10010-B90PF-M02 F15M	3,0 0.12	0,026 0.0010	0,030 0.0012	0,042 0.0017	0,065 0.0026
M1	MM10-10010-B90PF-M02 F15M	3,5 0.14	0,042 0.0017	0,048 0.0019	0,070 0.0028	0,11 0.0044
M2	MM10-10010-B90PF-M02 F15M	3,5 0.14	0,038 0.0015	0,044 0.0017	0,060 0.0024	0,10 0.0040
M3	MM10-10010-B90PF-M02 F15M	3,0 0.12	0,030 0.0012	0,036 0.0014	0,048 0.0019	0,075 0.0030
M4	MM10-10010-B90PF-M02 F15M	2,0 0.080	0,028 0.0011	0,030 0.0013	0,042 0.0017	0,070 0.0028
M5	MM10-10010-B90PF-M02 F15M	2,0 0.080	0,028 0.0011	0,030 0.0013	0,042 0.0017	0,070 0.0028
K1	MM10-10010-B90PF-M02 F15M	3,5 0.14	0,042 0.0017	0,048 0.0019	0,070 0.0028	0,11 0.0044
K2	MM10-10010-B90PF-M02 F15M	3,5 0.14	0,038 0.0015	0,044 0.0017	0,060 0.0024	0,10 0.0040
K3	MM10-10010-B90PF-M02 F15M	3,5 0.14	0,038 0.0015	0,044 0.0017	0,060 0.0024	0,10 0.0040
K4	MM10-10010-B90PF-M02 F15M	3,5 0.14	0,038 0.0015	0,044 0.0017	0,060 0.0024	0,10 0.0040
K5	MM10-10010-B90PF-M02 F15M	3,5 0.14	0,034 0.0013	0,040 0.0016	0,055 0.0022	0,085 0.0034
K6	MM10-10010-B90PF-M02 F15M	3,5 0.14	0,038 0.0015	0,044 0.0017	0,060 0.0024	0,10 0.0040
K7	MM10-10010-B90PF-M02 F15M	3,5 0.14	0,034 0.0013	0,040 0.0016	0,055 0.0022	0,085 0.0034
N1	MM10-10010-B90PF-M02 F15M	3,5 0.14	0,050 0.0020	0,060 0.0024	0,085 0.0034	0,14 0.0055
N2	MM10-10010-B90PF-M02 F15M	3,5 0.14	0,050 0.0020	0,060 0.0024	0,085 0.0034	0,14 0.0055
N3	MM10-10010-B90PF-M02 F15M	3,5 0.14	0,050 0.0020	0,060 0.0024	0,085 0.0034	0,14 0.0055
N11	MM10-10010-B90PF-M02 F15M	3,5 0.14	0,050 0.0020	0,060 0.0024	0,085 0.0034	0,14 0.0055
S1	MM10-10010-B90PF-M02 F15M	2,0 0.080	0,028 0.0011	0,030 0.0013	0,042 0.0017	0,070 0.0028
S2	MM10-10010-B90PF-M02 F15M	2,0 0.080	0,028 0.0011	0,030 0.0013	0,042 0.0017	0,070 0.0028
S3	MM10-10010-B90PF-M02 F15M	2,0 0.080	0,025 0.0010	0,028 0.0012	0,040 0.0016	0,065 0.0026
S11	MM10-10010-B90PF-M02 F15M	2,5 0.10	0,030 0.0012	0,036 0.0014	0,048 0.0019	0,075 0.0030
S12	MM10-10010-B90PF-M02 F15M	2,5 0.10	0,030 0.0012	0,036 0.0014	0,048 0.0019	0,075 0.0030
S13	MM10-10010-B90PF-M02 F15M	2,0 0.080	0,028 0.0011	0,030 0.0013	0,042 0.0017	0,070 0.0028
H5	MM10-10010-B90PF-M02 F15M	3,0 0.12	0,026 0.0010	0,030 0.0012	0,042 0.0017	0,065 0.0026
H8	MM10-10010-B90PF-M02 F15M	2,5 0.10	0,020 0.00080	0,022 0.00095	0,032 0.0013	0,050 0.0020
H11	MM10-10010-B90PF-M02 F15M	3,0 0.12	0,026 0.0010	0,030 0.0012	0,042 0.0017	0,065 0.0026
H12	MM10-10010-B90PF-M02 F15M	2,5 0.10	0,020 0.00080	0,022 0.00095	0,032 0.0013	0,050 0.0020
H21	MM10-10010-B90PF-M02 F15M	2,5 0.10	0,020 0.00080	0,022 0.00095	0,032 0.0013	0,050 0.0020

SMG = Seco material group
f_z = mm/tooth (in/tooth), v_c = m/min (sf/min), a_p/DC = %
All cutting data are start values

Universal
Steel and cast iron
Stainless steel and S-materials
Stainless steel and S-materials
Non ferrous
Hard
Graphite
X-Heads
Minimaster Plus
Minimaster

MM10 Z2 – Copy milling – Cutting data $v_c = (m/min)/(sf/min)$

SMG	F15M					F30M					T60M				
	100%	20%	10%	5%	2%	100%	20%	10%	5%	2%	100%	20%	10%	5%	2%
P1	305	390	405	440	440	250	320	340	370	365	205	260	275	300	295
	1000	1275	1325	1450	1450	820	1050	1125	1225	1200	670	850	900	980	970
P2	295	380	395	425	425	240	305	330	355	355	195	250	270	285	285
	970	1250	1300	1400	1400	790	1000	1075	1175	1175	640	820	890	940	940
P3	260	330	340	370	370	210	265	285	310	310	170	215	235	250	250
	850	1075	1125	1225	1225	690	870	940	1025	1025	560	710	770	820	820
P4	225	290	300	325	325	185	235	255	270	275	150	190	205	220	220
	740	950	980	1075	1075	610	770	840	890	900	490	620	670	720	720
P5	215	275	290	315	310	175	225	240	265	260	145	185	195	215	210
	710	900	950	1025	1025	570	740	790	870	850	475	610	640	710	690
P6	245	310	325	350	350	200	255	275	295	295	165	205	220	240	235
	800	1025	1075	1150	1150	660	840	900	970	970	540	670	720	790	770
P7	230	295	305	330	330	190	240	260	280	275	155	195	210	225	225
	750	970	1000	1075	1075	620	790	850	920	900	510	640	690	740	740
P8	215	275	290	310	310	175	225	240	260	260	145	180	195	210	210
	710	900	950	1025	1025	570	740	790	850	850	475	590	640	690	690
P11	225	285	295	325	320	185	235	250	270	270	150	190	205	220	215
	740	940	970	1075	1050	610	770	820	890	890	490	620	670	720	710
P12	140	175	180	195	195	120	150	155	170	170	95	120	125	135	135
	460	570	610	640	640	395	490	510	560	560	310	395	410	445	445
M1	240	305	320	345	345	195	245	265	285	285	160	200	215	230	230
	790	1000	1050	1125	1125	640	800	870	940	940	520	660	710	750	750
M2	195	250	260	280	280	160	205	215	235	235	130	165	175	190	190
	640	820	850	920	920	520	670	710	770	770	425	540	570	620	620
M3	155	200	200	220	220	130	165	175	185	185	105	135	140	150	150
	510	660	670	720	720	425	540	570	610	610	345	445	460	490	490
M4	120	155	155	165	165	105	135	130	145	140	85	105	105	115	115
	395	510	560	540	540	345	445	460	475	460	280	345	375	375	375
M5	100	130	130	140	140	85	110	110	120	120	70	90	90	95	95
	330	425	460	460	460	280	360	375	395	395	230	295	310	310	310
K1	235	300	315	335	335	190	245	260	280	280	155	195	210	225	225
	770	980	1025	1100	1100	620	800	850	920	920	510	640	690	740	740
K2	205	265	275	295	295	170	215	230	250	250	135	175	185	200	200
	670	870	900	970	970	560	710	750	820	820	445	570	610	660	660
K3	175	225	230	250	250	140	180	195	210	210	115	150	155	170	170
	570	740	750	820	820	460	590	640	690	690	375	490	510	560	560
K4	165	215	220	240	240	135	175	185	200	200	110	140	150	165	160
	540	710	720	790	790	445	570	610	660	660	360	460	490	540	520
K5	100	130	135	145	145	85	105	110	120	120	70	85	90	100	100
	330	425	445	475	475	280	345	360	395	395	230	280	295	330	330
K6	145	185	195	210	210	120	155	165	180	175	95	125	130	145	145
	475	610	640	690	690	395	510	540	590	570	310	410	425	475	475
K7	130	165	170	185	185	105	135	145	155	155	85	110	115	125	125
	425	540	560	610	610	345	445	475	510	510	280	360	375	410	410
N1	1800	2300	2425	2600	2600	1450	1825	1975	2150	2100	1175	1475	1600	1725	1700
	5900	7550	7950	8525	8525	4750	6000	6475	7050	6900	3850	4850	5250	5650	5575
N2	730	930	970	1050	1050	590	740	800	870	850	475	600	650	700	680
	2400	3050	3175	3450	3450	1925	2425	2625	2850	2800	1550	1975	2125	2300	2225
N3	485	620	650	700	700	390	495	530	580	560	315	400	435	465	455
	1600	2025	2125	2300	2300	1275	1625	1750	1900	1825	1025	1300	1425	1525	1500
N11	550	710	740	800	800	450	570	610	660	640	360	460	495	530	520
	1800	2325	2425	2625	2625	1475	1875	2000	2175	2100	1175	1500	1625	1750	1700
S1	55	70	70	80	75	48	60	60	65	65	39	50	50	55	55
	180	230	260	260	245	155	195	215	215	215	130	165	180	180	180
S2	46	60	60	65	60	39	50	50	55	55	32	40	40	43	43
	150	195	215	215	195	130	165	180	180	180	105	130	140	140	140
S3	40	50	50	55	55	34	43	43	47	46	27	35	35	38	38
	130	165	180	180	180	110	140	150	155	150	90	115	120	125	125
S11	80	100	100	110	110	65	85	85	95	95	55	70	70	75	75
	260	330	360	360	360	215	280	295	310	310	180	230	245	245	245
S12	55	70	70	75	75	47	60	60	65	65	38	48	49	55	55
	180	230	245	245	245	155	195	195	215	215	125	155	165	180	180
S13	32	41	40	44	43	27	35	35	37	37	22	28	28	30	30
	105	135	145	145	140	90	115	120	120	120	70	90	100	100	100
H5	46	60	60	65	65	39	50	50	55	55	32	41	42	45	45
	150	195	195	215	215	130	165	165	180	180	105	135	140	150	150
H8	48	60	60	65	65	41	55	55	60	60	33	43	43	47	47
	155	195	215	215	215	135	180	180	195	195	110	140	150	155	155
H11	60	75	75	85	85	50	65	65	70	70	40	50	55	60	60
	195	245	260	280	280	165	215	215	230	230	130	165	180	195	195
H12	85	110	110	120	120	75	95	95	105	105	60	75	80	85	85
	280	360	375	395	395	245	310	330	345	345	195	245	260	280	280
H21	48	60	60	65	65	41	55	55	60	60	33	43	43	47	47
	155	195	215	215	215	135	180	180	195	195	110	140	150	155	155

MM10 High-Feed – Insert selection – mm/Inch

SMG		a _p	f _z			
			100%	70%	30%	20%
P1	MM10-10.50-HF-MD08 F30M	0,30	0,48	0,48	0,65	0,80
		0.012	0.019	0.019	0.026	0.032
P2	MM10-10.50-HF-MD08 F30M	0,30	0,50	0,50	0,65	0,80
		0.012	0.020	0.020	0.026	0.032
P3	MM10-10.50-HF-MD08 F30M	0,30	0,46	0,46	0,60	0,75
		0.012	0.018	0.018	0.024	0.030
P4	MM10-10.50-HF-MD08 F30M	0,30	0,46	0,46	0,60	0,75
		0.012	0.018	0.018	0.024	0.030
P5	MM10-10.50-HF-MD08 F30M	0,30	0,44	0,46	0,60	0,75
		0.012	0.017	0.018	0.024	0.030
P6	MM10-10.50-HF-MD08 F30M	0,30	0,44	0,44	0,60	0,75
		0.012	0.017	0.017	0.024	0.030
P7	MM10-10.50-HF-MD08 F30M	0,30	0,44	0,44	0,60	0,75
		0.012	0.017	0.017	0.024	0.030
P8	MM10-10.50-HF-MD08 F30M	0,30	0,46	0,46	0,60	0,75
		0.012	0.018	0.018	0.024	0.030
P11	MM10-10.50-HF-MD08 F30M	0,30	0,44	0,44	0,60	0,75
		0.012	0.017	0.017	0.024	0.030
P12	MM10-10.50-HF-MD08 F30M	0,25	0,30	0,30	0,40	0,48
		0.010	0.012	0.012	0.016	0.019
M1	MM10-10.50-HF-MD08 F30M	0,30	0,50	0,50	0,65	0,80
		0.012	0.020	0.020	0.026	0.032
M2	MM10-10.50-HF-MD08 F30M	0,30	0,44	0,46	0,60	0,75
		0.012	0.017	0.018	0.024	0.030
M3	MM10-10.50-HF-MD08 F30M	0,25	0,36	0,36	0,46	0,55
		0.010	0.014	0.014	0.018	0.022
M4	MM10-10.50-HF-MD08 F30M	0,18	0,32	0,32	0,40	0,50
		0.0070	0.013	0.013	0.016	0.020
M5	MM10-10.50-HF-MD08 F30M	0,18	0,32	0,32	0,40	0,50
		0.0070	0.013	0.013	0.016	0.020
K1	MM10-10.50-HF-MD08 F30M	0,30	0,50	0,50	0,65	0,80
		0.012	0.020	0.020	0.026	0.032
K2	MM10-10.50-HF-MD08 F30M	0,30	0,44	0,46	0,60	0,75
		0.012	0.017	0.018	0.024	0.030
K3	MM10-10.50-HF-MD08 F30M	0,30	0,44	0,46	0,60	0,75
		0.012	0.017	0.018	0.024	0.030
K4	MM10-10.50-HF-MD08 F30M	0,30	0,44	0,46	0,60	0,75
		0.012	0.017	0.018	0.024	0.030
K5	MM10-10.50-HF-MD08 F30M	0,30	0,40	0,40	0,55	0,65
		0.012	0.016	0.016	0.022	0.026
K6	MM10-10.50-HF-MD08 F30M	0,30	0,44	0,46	0,60	0,75
		0.012	0.017	0.018	0.024	0.030
K7	MM10-10.50-HF-MD08 F30M	0,30	0,40	0,40	0,55	0,65
		0.012	0.016	0.016	0.022	0.026
N1	MM10-10.50-HF-MD08 F30M	0,30	0,65	0,65	0,85	1,1
		0.012	0.026	0.026	0.034	0.044
N2	MM10-10.50-HF-MD08 F30M	0,30	0,65	0,65	0,85	1,1
		0.012	0.026	0.026	0.034	0.044
N3	MM10-10.50-HF-MD08 F30M	0,30	0,65	0,65	0,85	1,1
		0.012	0.026	0.026	0.034	0.044
N11	MM10-10.50-HF-MD08 F30M	0,30	0,65	0,65	0,85	1,1
		0.012	0.026	0.026	0.034	0.044
S1	MM10-10.50-HF-MD08 F30M	0,18	0,32	0,32	0,40	0,50
		0.0070	0.013	0.013	0.016	0.020
S2	MM10-10.50-HF-MD08 F30M	0,18	0,32	0,32	0,40	0,50
		0.0070	0.013	0.013	0.016	0.020
S3	MM10-10.50-HF-MD08 F30M	0,18	0,30	0,30	0,38	0,46
		0.0070	0.012	0.012	0.015	0.018
S11	MM10-10.50-HF-MD08 F30M	0,22	0,36	0,36	0,46	0,55
		0.0085	0.014	0.014	0.018	0.022
S12	MM10-10.50-HF-MD08 F30M	0,22	0,36	0,36	0,46	0,55
		0.0085	0.014	0.014	0.018	0.022
S13	MM10-10.50-HF-MD08 F30M	0,18	0,32	0,32	0,40	0,50
		0.0070	0.013	0.013	0.016	0.020
H5	MM10-10.50-HF-MD08 F15M	0,25	0,30	0,30	0,40	0,48
		0.010	0.012	0.012	0.016	0.019
H8	MM10-10.50-HF-MD08 F15M	0,22	0,24	0,24	0,30	0,36
		0.0085	0.0095	0.0095	0.012	0.014
H11	MM10-10.50-HF-MD08 F15M	0,25	0,30	0,30	0,40	0,48
		0.010	0.012	0.012	0.016	0.019
H12	MM10-10.50-HF-MD08 F15M	0,22	0,24	0,24	0,30	0,36
		0.0085	0.0095	0.0095	0.012	0.014
H21	MM10-10.50-HF-MD08 F15M	0,22	0,24	0,24	0,30	0,36
		0.0085	0.0095	0.0095	0.012	0.014



SMG = Seco material group
 f_z = mm/tooth (in/tooth), v_c = m/min (sf/min), a_p/DC = %
 All cutting data are start values

Universal
 Steel and cast iron
 Stainless steel and S-materials
 Stainless steel and S-materials
 Non ferrous
 Hard
 Graphite
 X-Heads
 Minimaster Plus
 Minimaster

MM10 High-Feed – Cutting data $v_c = (m/min)/(sf/min)$

	SMG	F15M				F30M			
		100%	70%	30%	20%	100%	70%	30%	20%
Universal	P1	—	—	—	—	230	280	325	340
		—	—	—	—	750	920	1075	1125
Steel and cast iron	P2	—	—	—	—	225	270	315	330
		—	—	—	—	740	890	1025	1075
	P3	—	—	—	—	195	240	275	290
		—	—	—	—	640	790	900	950
	P4	—	—	—	—	170	210	240	255
		—	—	—	—	560	690	790	840
	P5	—	—	—	—	165	200	230	240
		—	—	—	—	540	660	750	790
	P6	—	—	—	—	185	225	260	270
		—	—	—	—	610	740	850	890
Stainless steel and S-materials	P7	—	—	—	—	175	215	245	255
		—	—	—	—	570	710	800	840
	P8	—	—	—	—	165	200	230	240
		—	—	—	—	540	660	750	790
	P11	—	—	—	—	170	210	240	250
		—	—	—	—	560	690	790	820
	P12	—	—	—	—	110	135	150	160
		—	—	—	—	360	445	490	520
Non ferrous	M1	—	—	—	—	180	220	255	265
		—	—	—	—	590	720	840	870
	M2	—	—	—	—	150	180	210	220
		—	—	—	—	490	590	690	720
	M3	—	—	—	—	120	145	165	175
		—	—	—	—	395	475	540	570
	M4	—	—	—	—	95	110	130	135
		—	—	—	—	310	360	425	445
	M5	—	—	—	—	80	95	110	115
		—	—	—	—	260	310	360	375
Hard	K1	190	230	270	280	175	215	250	260
		620	750	890	920	570	710	820	850
	K2	170	205	235	245	160	190	220	230
		560	670	770	800	520	620	720	750
	K3	145	175	200	210	135	160	185	195
		475	570	660	690	445	520	610	640
Plastic and cfrp	K4	135	165	190	200	125	155	175	185
		445	540	620	660	410	510	570	610
	K5	85	100	115	125	75	95	105	115
		280	330	375	410	245	310	345	375
	K6	120	145	170	175	110	135	155	165
		395	475	560	570	360	445	510	540
	K7	105	130	150	155	100	120	140	145
		345	425	490	510	330	395	460	475
Graphite	N1	—	—	—	—	1325	1600	1850	1925
		—	—	—	—	4350	5250	6075	6325
	N2	—	—	—	—	530	650	750	780
		—	—	—	—	1750	2125	2450	2550
	N3	—	—	—	—	355	430	500	520
		—	—	—	—	1175	1400	1650	1700
	N11	—	—	—	—	405	495	570	590
		—	—	—	—	1325	1625	1875	1925
X-Heads	S1	—	—	—	—	45	50	60	65
		—	—	—	—	150	165	195	215
	S2	—	—	—	—	36	42	49	50
		—	—	—	—	120	140	160	165
	S3	—	—	—	—	31	37	42	45
		—	—	—	—	100	120	140	150
	S11	—	—	—	—	60	75	85	90
		—	—	—	—	195	245	280	295
Minimaster Plus	S12	—	—	—	—	43	50	60	60
		—	—	—	—	140	165	195	195
	S13	—	—	—	—	25	29	34	36
		—	—	—	—	80	95	110	120
	H5	40	48	55	60	37	44	50	55
		130	155	180	195	120	145	165	180
	H8	42	50	55	60	39	46	55	55
		140	165	180	195	130	150	180	180
Minimaster	H11	50	60	70	75	47	55	65	70
		165	195	230	245	155	180	215	230
	H12	75	90	105	110	70	85	95	100
		245	295	345	360	230	280	310	330
	H21	42	50	55	60	39	46	55	55
		140	165	180	195	130	150	180	180

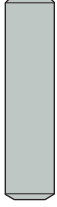
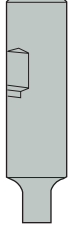
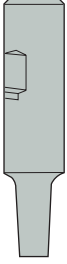
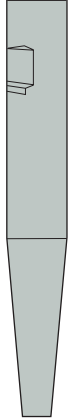
Shank design

Design 1, Keyway shank	Design 2, Cylindrical/Weldon back end and 90° front
	
Design 3, Cylindrical/Weldon back end tapered front 87°/89°	Design 4, Cylindrical/Weldon back end tapered front 80°/85°/87°
	
Design 5, Cylindrical back end double tapered front end 89°/85°	
	

Universal
Steel and cast iron
Stainless steel and S-materials
Stainless steel and S-materials
Non ferrous
Hard
Graphite
X-Heads
Minimaster Plus
Minimaster

MM12 Shank – Metric

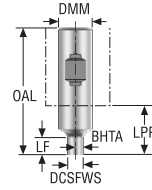

Designation	Item number	Type of mounting	DCSFWS	DMM	OAL	LF	LPR	BHTA°	Design		RPMX	Weight	Spare part no.
												mm	
MM12-20080.3-0012	75012864	Weldon	11,4	20,0	80,0	12,0	30,0	0,0	2	✓	80000	0,2	4
MM12-20095.3-3027	75012865	Weldon	11,4	20,0	95,0	27,0	45,0	3,0	3	✓	80000	0,2	4
MM12-20150.3-5049	75012866	Weldon	11,4	20,0	150,0	49,1	100,0	5,0	4	✓	80000	0,3	5
MM12-12055.0-0008	00083978	Cylindrical	11,5	12,0	55,0	8,5	10,0	0,0	2	✓	80000	0,1	2
MM12-16065.0-0000	75004926	Cylindrical	11,4	16,0	65,0	0,0	17,0	60,0	1	✓	80000	0,1	1
MM12-16170.0-1040	75034505	Cylindrical	11,4	16,0	170,0	40,0	122,0	1,0	3	✓	80000	0,2	5
MM12-16170.0-1060	75034506	Cylindrical	11,4	16,0	170,0	60,0	122,0	1,0	3	✓	80000	0,2	5
MM12-16170.0-1080	75034507	Cylindrical	11,4	16,0	170,0	80,0	122,0	1,0	3	✓	80000	0,2	5
MM12-12070.0-0008DS	02580668	Cylindrical	11,5	12,0	70,0	8,5	25,0	0,0	2	✓	63600	0,1	3
MM12-16095.0-0024DS	02580690	Cylindrical	11,4	16,0	95,0	24,0	47,0	0,0	2	✓	63600	0,3	3
MM12-16090.0-3044DS	02580705	Cylindrical	11,4	16,0	90,0	43,9	42,0	3,0	4	✓	63600	0,3	3
MM12-16120.0-1045DS	02580752	Cylindrical	11,4	16,0	120,0	45,0	72,0	1,0	3	✓	63600	0,3	3
MM12-16115.0-0048DS	02580691	Cylindrical	11,4	16,0	115,0	48,0	67,0	0,0	2	✓	63600	0,3	3
MM12-16170.0-1060DS	02580753	Cylindrical	11,4	16,0	170,0	60,0	122,0	1,0	3	✓	63600	0,5	3
MM12-16170.0-1080DS	02580755	Cylindrical	11,4	16,0	170,0	80,0	122,0	1,0	3	✓	63600	0,5	3
MM12-20250.0-1060DS	02580756	Cylindrical	11,4	20,0	250,0	60,0	200,0	1,0	5	✓	63600	1,0	3

Spare Parts, included in delivery

Accessories

	Spare Parts, included in delivery		Accessories	
	For cutter	Sleeve	Tension screw	Sleeve key
4		MM-06048	MM12-0637	H06-4
5		MM-06116	MM12-0637	H06-4
2		MM-06020	MM12-0637	H05-4
1		MM-06032	MM12-0637	H06-4
3		–	MM12-061037	–

MM12 Shank – Inch

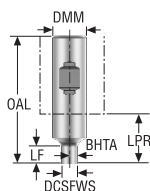

• For ISO attribute explanation, see page 25

Designation	Item number	Type of mounting	DCSFWS	DMM	OAL	LF	LPR	BHTA°	Design		RPMX	Weight	Spare part no.
			inch	inch	inch	inch	inch					lbs	
MM12-0.75-3.1-3-0004	75015055	Weldon	0.449	0.750	3.150	0.472	1.181	0,0	2	✓	80000	0.440	3
MM12-0.75-3.7-3-3010	75015056	Weldon	0.449	0.750	3.740	1.063	1.772	3,0	3	✓	80000	0.440	3
MM12-0.75-5.9-3-5017	75015057	Weldon	0.449	0.750	5.906	1.720	3.937	5,0	4	✓	80000	0.660	5
MM12-0.50-2.2-0-0003	00096133	Cylindrical	0.453	0.500	2.165	0.335	0.394	0,0	2	✓	80000	0.220	2
MM12-0.62-2.6-0-0000	75005070	Cylindrical	0.449	0.625	2.559	0	0.669	60,0	1	✓	80000	0.220	1
MM12-0.62-6.7-0-1015	75054728	Cylindrical	0.449	0.625	6.693	1.575	4.803	1,0	3	✓	80000	0.660	5
MM12-0.62-6.7-0-1023	75054729	Cylindrical	0.449	0.625	6.693	2.362	4.803	1,0	3	✓	80000	0.440	5
MM12-0.62-6.7-0-1023DS	02593423	Cylindrical	0.449	0.625	6.693	2.362	4.803	1,0	3	✓	63600	1.100	4
MM12-0.62-6.7-0-1031DS	02593426	Cylindrical	0.449	0.625	6.693	3.150	4.803	1,0	3	✓	63600	1.100	4
MM12-0.75-10.0-0-1023DS	02593427	Cylindrical	0.449	0.750	9.843	2.362	7.874	1,0	5	✓	63600	2.200	4
MM12-0.75-3.8-0-0009DS	02593428	Cylindrical	0.449	0.750	3.740	0.945	1.772	0,0	2	✓	63600	0.880	4
MM12-0.75-4.5-0-0018DS	02593430	Cylindrical	0.449	0.750	4.528	1.890	2.559	0,0	2	✓	63600	0.880	4

Spare Parts, included in delivery

Accessories

For cutter	Sleeve	Tension screw	Sleeve key
3	 MM-06048	 MM12-0637	 H06-4
5	MM-06116	MM12-0637	H06-4
2	MM-06020	MM12-0637	H05-4
1	MM-06032	MM12-0637	H06-4
4	–	MM12-061037	–

Universal

Steel and cast iron

Stainless steel and S-materials

Stainless steel and S-materials

Non ferrous

Hard

Graphite

X-Heads

Minimaster Plus

Minimaster

Slot milling/square shoulder milling

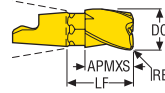

• For Torque keys and torque values, see page 720

Designation	DC	APMXS	RE	LF	RMPX°	C min	C max	FHA°	ZEPF	Wrench	Grades			
											Coated			
	mm Inch	mm Inch	mm Inch	mm Inch							T60M	F15M	F30M	F40M
MM12-11715-R03A30-M04	11,7 0.461	15,35 0.604	0,3 0.012	19,9 0.783	15,0	14,2	22,6	30	3					■
MM12-12015-A30-E04	12,0 0.472	15,35 0.604	0,0 –	19,9 0.783	15,0	14,6	23,8	30	3				■	
MM12-12015-R05A30-M04	12,0 0.472	15,35 0.604	0,5 0.020	19,9 0.783	15,0	14,6	22,8	30	3					■
MM12-12015-R10A30-E04	12,0 0.472	15,35 0.604	1,0 0.039	19,9 0.783	15,0	14,6	21,8	30	3				■	
MM12-12015-R10A30-M04	12,0 0.472	15,35 0.604	1,0 0.039	19,9 0.783	15,0	14,6	21,8	30	3					■
MM12-12015-R15A30-D04	12,0 0.472	15,35 0.604	1,5 0.059	19,9 0.783	15,0	14,6	20,8	30	3				■	
MM12-12015-R20A30-M04	12,0 0.472	15,35 0.604	2,0 0.079	19,9 0.783	15,0	14,6	19,8	30	3					■
MM12-12015-R30A30-E04	12,0 0.472	15,3 0.602	3,0 0.118	19,9 0.783	15,0	14,6	17,8	30	3				■	
MM12-12015-R30A30-M04	12,0 0.472	15,35 0.604	3,0 0.118	19,9 0.783	15,0	14,6	17,8	30	3					■
MM12-12015-R40A30-M04	12,0 0.472	15,35 0.604	4,0 0.157	19,9 0.783	15,0	14,6	15,8	30	3					■
MM12-12715-A30-E04	12,7 0.500	15,35 0.604	0,0 –	19,9 0.783	15,0	15,4	25,2	30	3				■	
MM12-12715-R08A30-M04	12,7 0.500	15,35 0.604	0,8 0.031	19,9 0.783	15,0	15,4	23,6	30	3					■
MM12-12715-R16A30-M04	12,7 0.500	15,35 0.604	1,6 0.063	19,9 0.783	15,0	15,4	22,0	30	3					■

Slot milling/square shoulder milling

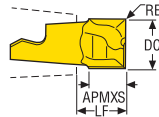

• For Torque keys and torque values, see page 720

Designation	DC	APMXS	RE	LF	RMPX°	C min	C max	FHA°	ZEFP	Wrench 	Grades			
											Coated			
											T60M	F15M	F30M	F40M
	mm Inch	mm Inch	mm Inch	mm Inch										
MM12-11708T-R03-D05	11,7 0.461	8,2 0.323	0,3 0.012	10,18 0.401	15,0	14,2	22,6	0	2		■			
MM12-12008-M04	12,0 0.472	8,2 0.323	0,0 -	10,2 0.402	15,0	14,6	23,8	0	2		■			
MM12-12008-R08A8-E04	12,0 0.472	8,1 0.319	0,8 0.031	10,15 0.400	15,0	14,6	22,2	8	2		■			
MM12-12008-R08-MD05	12,0 0.472	8,2 0.323	0,8 0.031	10,18 0.401	15,0	14,6	22,2	0	2		■		■	
MM12-12008-R08P-M04	12,0 0.472	8,1 0.319	0,8 0.031	10,05 0.396	15,0	14,6	22,2	0	2				■	
MM12-12008-R20-MD05	12,0 0.472	8,2 0.323	2,0 0.079	10,16 0.400	15,0	14,6	19,8	0	2				■	
MM12-12008-R30-MD05	12,0 0.472	8,2 0.323	3,0 0.118	10,14 0.399	15,0	14,6	17,8	0	2				■	
MM12-12708-M04	12,7 0.500	9,3 0.366	0,0 -	11,25 0.443	15,0	15,4	25,2	0	2		■			
MM12-12708-R08-MD05	12,7 0.500	9,3 0.366	0,8 0.031	11,23 0.442	15,0	15,4	23,6	0	2		■			
MM12-12708-R08P-M04	12,7 0.500	9,3 0.366	0,8 0.031	11,23 0.442	15,0	15,4	23,6	0	2				■	
MM12-13709T-R03-D05	13,7 0.539	9,3 0.366	0,3 0.012	11,25 0.443	15,0	16,6	26,6	0	2		■			
MM12-14009-M04	14,0 0.551	9,3 0.366	0,0 -	11,26 0.443	15,0	17,0	27,8	0	2		■			
MM12-14009-R08A8-E04	14,0 0.551	9,2 0.362	0,8 0.031	11,06 0.435	15,0	17,0	26,2	8	2		■		■	
MM12-14009-R08-MD05	14,0 0.551	9,3 0.366	0,8 0.031	11,26 0.443	15,0	17,0	26,2	0	2		■		■	

Universal

Steel and cast iron

Stainless steel and S-materials

Stainless steel and S-materials

Non ferrous

Hard

Graphite

X-Heads

Minimaster Plus

Minimaster

Centre drilling

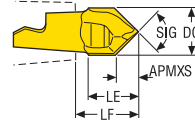

• For Torque keys and torque values, see page 720

Designation	DC	APMXS	LE	LF	SIG°	ZEPF	Wrench	Grades				
								T60M	F15M	F30M	F40M	
	mm <i>Inch</i>	mm <i>Inch</i>	mm <i>Inch</i>	mm <i>Inch</i>								
MM12-12006-C90-M04	12,0 0.472	5,65 0.222	12,65 0.498	14,64 0.576	90,0	2		■				

Plunge milling

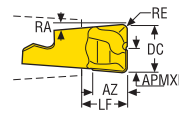

• For Torque keys and torque values, see page 720

Designation	DC	APMXE	RE	AZ	LF	RA°	ZEPF	Wrench	Grades			
									T60M	F15M	F30M	F40M
	mm <i>Inch</i>	mm <i>Inch</i>	mm <i>Inch</i>	mm <i>Inch</i>	mm <i>Inch</i>							
MM12-12008-R10-PL-MD05	12,0 0.472	6,0 0.236	1,0 0.039	8,5 0.335	10,2 0.402	5,0	2			■		

Concave radius

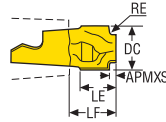

• For Torque keys and torque values, see page 720

Designation	DC	APMXS	RE	LF	ZEFP	Wrench 	Grades			
							T60M	F15M	F30M	F40M
MM12-12010-CR10-MD05	12,0 0.472	2,2 0.087	1,0 0.039	12,14 0.478	2		■			
MM12-12010-CR20-MD05	12,0 0.472	2,4 0.094	2,0 0.079	12,25 0.482	2		■			
MM12-12010-CR30-MD05	12,0 0.472	3,3 0.130	3,0 0.118	12,2 0.480	2		■			

Double chamfering

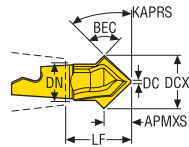

• For Torque keys and torque values, see page 720

Designation	DCX	DC	APMXS	LF	DN	BEC°	KAPRS°	ZEFP	Wrench 	Grades			
										T60M	F15M	F30M	F40M
MM12-16016-D3020P-M02	16,0 0.630	1,0 0.039	4,3 0.169	15,2 0.598	11,5 0.453	60,0	30,0	2			■		
MM12-16016-D4520P-M02	16,0 0.630	1,0 0.039	7,5 0.295	17,2 0.677	11,5 0.453	90,0	45,0	2			■		

Universal
Steel and cast iron
Stainless steel and S-materials
Stainless steel and S-materials
Non ferrous
Hard
Graphite
X-Heads
Minimaster Plus
Minimaster

Precision inserts for semi-finishing in all materials

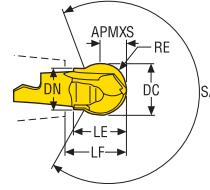

• For Torque keys and torque values, see page 720

Designation	DC	APMXS	RE	LE	LF	DN	SA°	ZEFP	Wrench 	Grades			
										T60M	F15M	F30M	F40M
MM12-14014-B120P-M05	14,0 <i>0.551</i> <i>Inch</i>	7,0 <i>0.276</i> <i>Inch</i>	7,0 <i>0.276</i> <i>Inch</i>	14,0 <i>0.551</i> <i>Inch</i>	15,45 <i>0.608</i> <i>Inch</i>	12,0 <i>0.472</i> <i>Inch</i>	242,0	2			■		
MM12-16016-B120PF-M03	16,0 <i>0.630</i> <i>Inch</i>	8,0 <i>0.315</i> <i>Inch</i>	8,0 <i>0.315</i> <i>Inch</i>	16,0 <i>0.630</i> <i>Inch</i>	17,46 <i>0.687</i> <i>Inch</i>	12,0 <i>0.472</i> <i>Inch</i>	263,0	2		■			
MM12-16016-B120P-M07	16,0 <i>0.630</i> <i>Inch</i>	8,0 <i>0.315</i> <i>Inch</i>	8,0 <i>0.315</i> <i>Inch</i>	16,0 <i>0.630</i> <i>Inch</i>	17,46 <i>0.687</i> <i>Inch</i>	12,0 <i>0.472</i> <i>Inch</i>	263,0	2			■		

Universal

Steel and cast iron

Stainless steel and S-materials

Non ferrous

Hard

Plastic and CFRP

Graphite

X-Heads

Minimaster Plus

Minimaster

Copy milling

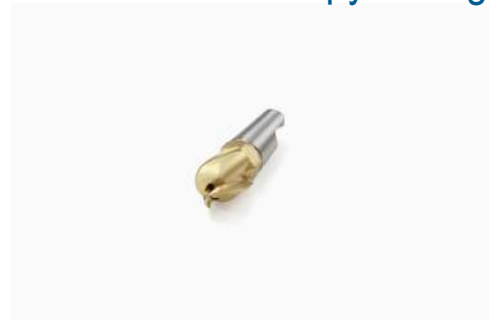
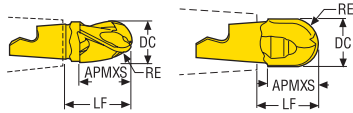

• For Torque keys and torque values, see page 720

Designation	DC	APMXS	RE	LF	FHA°	ZEFP	Wrench 	Grades			
								Coated			
								T60M	F15M	F30M	F40M
MM12-12012-B90-MD05	12,0 0.472	12,2 0.480	6,0 0.236	14,12 0.556	0,0	2		■		■	
MM12-12012-B90PF-M02	12,0 0.472	10,4 0.409	6,0 0.236	14,09 0.555	0,0	2			■		
MM12-12012-B90P-M05	12,0 0.472	10,4 0.409	6,0 0.236	14,09 0.555	0,0	2				■	
MM12-12012-B90S-E05	12,0 0.472	12,3 0.484	6,0 0.236	14,12 0.556	0,0	2				■	
MM12-12015-B90A30-E04	12,0 0.472	15,3 0.602	6,0 0.236	19,9 0.783	30,0	3				■	
MM12-12015-B90A30-M04	12,0 0.472	15,3 0.602	6,0 0.236	19,9 0.783	30,0	3					■
MM12-12713-B90P-M05	12,7 0.500	12,2 0.480	6,35 0.250	15,92 0.627	0,0	2		■		■	
MM12-12715-B90A30-M04	12,7 0.500	15,3 0.602	6,35 0.250	19,75 0.778	30,0	3					■
MM12-14014-B90S-E05	14,0 0.551	14,1 0.555	7,0 0.276	15,92 0.627	0,0	2				■	

High feed

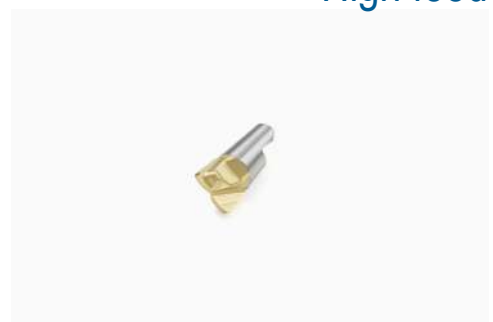
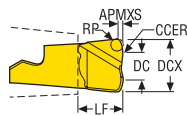

• For Torque keys and torque values, see page 720

Designation	DCX	DC	APMXS	RP	CCER	LF	RMPX°	C min	C max	ZEFP	Wrench 	Grades				
												Coated				
												T60M	F15M	F30M	F40M	
MM12-12.60-HF-MD10	12,0 0.472	6,0 0.236	0,51 0.020	1,21 0.048	6,5 0.256	10,25 0.404	5,0	14,6	22,2	2			■	■		

Universal
Steel and cast iron
Stainless steel and S-materials
Stainless steel and S-materials
Non ferrous
Hard
Graphite
X-Heads
Minimaster Plus
Minimaster

MM12 - Slot and Side milling – Insert selection – mm/Inch

SMG		a _p	f _z			
			100%	40%	20%	10%
P1	MM12-12015-R05A30-M04 F40M	2,5	0,055	0,060	0,070	0,095
		0,10	0,0022	0,0024	0,0028	0,0038
P2	MM12-12015-R05A30-M04 F40M	2,5	0,060	0,060	0,070	0,095
		0,10	0,0024	0,0024	0,0028	0,0038
P3	MM12-12015-R05A30-M04 F40M	2,5	0,055	0,055	0,070	0,090
		0,10	0,0022	0,0022	0,0028	0,0036
P4	MM12-12015-R05A30-M04 F40M	2,5	0,055	0,055	0,065	0,090
		0,10	0,0022	0,0022	0,0026	0,0036
P5	MM12-12015-R05A30-M04 F40M	2,5	0,055	0,055	0,065	0,085
		0,10	0,0022	0,0022	0,0026	0,0034
P6	MM12-12015-R05A30-M04 F40M	2,5	0,050	0,055	0,065	0,085
		0,10	0,0020	0,0022	0,0026	0,0034
P7	MM12-12015-R05A30-M04 F40M	2,5	0,050	0,055	0,065	0,085
		0,10	0,0020	0,0022	0,0026	0,0034
P8	MM12-12015-R05A30-M04 F40M	2,5	0,055	0,055	0,070	0,090
		0,10	0,0022	0,0022	0,0028	0,0036
P11	MM12-12015-R05A30-M04 F40M	2,5	0,050	0,055	0,065	0,085
		0,10	0,0020	0,0022	0,0026	0,0034
P12	MM12-12015-R05A30-M04 F40M	2,0	0,036	0,036	0,044	0,060
		0,080	0,0014	0,0014	0,0017	0,0024
M1	MM12-12015-R05A30-M04 F40M	2,5	0,060	0,060	0,070	0,095
		0,10	0,0024	0,0024	0,0028	0,0038
M2	MM12-12015-R05A30-M04 F40M	2,5	0,055	0,055	0,065	0,085
		0,10	0,0022	0,0022	0,0026	0,0034
M3	MM12-12015-R05A30-M04 F40M	2,0	0,042	0,044	0,050	0,070
		0,080	0,0017	0,0017	0,0020	0,0028
M4	MM12-12015-R05A30-M04 F40M	1,6	0,038	0,038	0,046	0,060
		0,065	0,0015	0,0015	0,0018	0,0024
M5	MM12-12015-R05A30-M04 F40M	1,6	0,038	0,038	0,046	0,060
		0,065	0,0015	0,0015	0,0018	0,0024
K1	MM12-12015-R10A30-E04 F30M	2,5	0,060	0,060	0,070	0,095
		0,10	0,0024	0,0024	0,0028	0,0038
K2	MM12-12015-R10A30-E04 F30M	2,5	0,055	0,055	0,065	0,090
		0,10	0,0022	0,0022	0,0026	0,0036
K3	MM12-12015-R10A30-E04 F30M	2,5	0,055	0,055	0,065	0,090
		0,10	0,0022	0,0022	0,0026	0,0036
K4	MM12-12015-R10A30-E04 F30M	2,5	0,055	0,055	0,065	0,090
		0,10	0,0022	0,0022	0,0026	0,0036
K5	MM12-12015-R15A30-D04 F30M	2,5	0,055	0,055	0,060	0,080
		0,10	0,0022	0,0022	0,0024	0,0032
K6	MM12-12015-R15A30-D04 F30M	2,5	0,060	0,060	0,065	0,090
		0,10	0,0024	0,0024	0,0026	0,0036
K7	MM12-12015-R15A30-D04 F30M	2,5	0,055	0,055	0,060	0,080
		0,10	0,0022	0,0022	0,0024	0,0032
N1	MM12-12015-R10A30-E04 F30M	2,5	0,080	0,080	0,090	0,12
		0,10	0,0032	0,0032	0,0036	0,0048
N2	MM12-12015-R10A30-E04 F30M	2,5	0,080	0,080	0,090	0,12
		0,10	0,0032	0,0032	0,0036	0,0048
N3	MM12-12015-R10A30-E04 F30M	2,5	0,080	0,080	0,090	0,12
		0,10	0,0032	0,0032	0,0036	0,0048
N11	MM12-12015-R10A30-E04 F30M	2,5	0,080	0,080	0,090	0,12
		0,10	0,0032	0,0032	0,0036	0,0048
S1	MM12-12015-R15A30-D04 F30M	1,6	0,050	0,048	0,048	0,060
		0,065	0,0020	0,0019	0,0019	0,0026
S2	MM12-12015-R15A30-D04 F30M	1,6	0,050	0,048	0,048	0,060
		0,065	0,0020	0,0019	0,0019	0,0026
S3	MM12-12015-R15A30-D04 F30M	1,6	0,046	0,044	0,044	0,055
		0,065	0,0018	0,0017	0,0017	0,0024
S11	MM12-12015-R05A30-M04 F40M	1,9	0,044	0,044	0,050	0,070
		0,075	0,0017	0,0017	0,0020	0,0028
S12	MM12-12015-R05A30-M04 F40M	1,9	0,044	0,044	0,050	0,070
		0,075	0,0017	0,0017	0,0020	0,0028
S13	MM12-12015-R05A30-M04 F40M	1,6	0,038	0,038	0,046	0,060
		0,065	0,0015	0,0015	0,0018	0,0024
H5	MM12-12015-R15A30-D04 F30M	2,0	0,044	0,042	0,046	0,060
		0,080	0,0017	0,0017	0,0018	0,0024
H8	MM12-12015-R15A30-D04 F30M	1,9	0,034	0,034	0,036	0,046
		0,075	0,0013	0,0013	0,0014	0,0018
H11	MM12-12015-R15A30-D04 F30M	2,0	0,044	0,042	0,046	0,060
		0,080	0,0017	0,0017	0,0018	0,0024
H12	MM12-12015-R15A30-D04 F30M	1,9	0,034	0,034	0,036	0,046
		0,075	0,0013	0,0013	0,0014	0,0018
H21	MM12-12015-R15A30-D04 F30M	1,9	0,034	0,034	0,036	0,046
		0,075	0,0013	0,0013	0,0014	0,0018

SMG = Seco material group
f_z = mm/tooth (in/tooth), v_c = m/min (sf/min), a_g/DC = %
All cutting data are start values

MM12 - Slot and Side milling – Cutting data $v_c = (m/min)/(sf/min)$

SMG	F30M				F40M				T60M			
	100%	40%	20%	10%	100%	40%	20%	10%	100%	40%	20%	10%
P1	250	315	350	385	240	300	335	365	185	225	255	280
	820	1025	1150	1275	790	980	1100	1200	610	740	840	920
P2	245	305	340	375	235	290	325	355	175	220	250	275
	800	1000	1125	1225	770	950	1075	1175	570	720	820	900
P3	210	265	295	325	200	250	280	310	155	195	215	235
	690	870	970	1075	660	820	920	1025	510	640	710	770
P4	190	235	260	285	180	225	250	270	135	170	190	210
	620	770	850	940	590	740	820	890	445	560	620	690
P5	180	225	250	275	170	215	240	260	130	160	180	200
	590	740	820	900	560	710	790	850	425	520	590	660
P6	205	250	280	310	195	240	270	295	150	185	205	225
	670	820	920	1025	640	790	890	970	490	610	670	740
P7	190	240	265	295	180	225	255	280	140	175	195	215
	620	790	870	970	590	740	840	920	460	570	640	710
P8	175	220	245	275	170	210	235	260	130	160	180	200
	570	720	800	900	560	690	770	850	425	520	590	660
P11	185	230	260	285	175	220	245	270	135	170	190	210
	610	750	850	940	570	720	800	890	445	560	620	690
P12	115	145	165	180	110	140	155	170	85	110	120	130
	375	475	540	590	360	460	510	560	280	360	395	425
M1	200	245	275	300	190	235	260	285	140	180	200	220
	660	800	900	980	620	770	850	940	460	590	660	720
M2	160	200	225	245	155	195	215	235	120	145	165	180
	520	660	740	800	510	640	710	770	395	475	540	590
M3	130	160	175	195	125	150	170	185	95	120	135	145
	425	520	570	640	410	490	560	610	310	395	445	475
M4	100	125	140	150	95	115	130	145	75	90	100	110
	330	410	460	490	310	375	425	475	245	295	330	360
M5	80	100	115	125	80	95	110	120	60	75	85	95
	260	330	375	410	260	310	360	395	195	245	280	310
K1	195	240	270	295	185	230	255	280	140	175	195	220
	640	790	890	970	610	750	840	920	460	570	640	720
K2	170	215	240	260	165	205	225	245	125	155	175	190
	560	710	790	850	540	670	740	800	410	510	570	620
K3	145	180	200	220	140	170	190	210	105	130	145	160
	475	590	660	720	460	560	620	690	345	425	475	520
K4	140	170	190	210	130	165	185	200	100	125	140	155
	460	560	620	690	425	540	610	660	330	410	460	510
K5	85	105	115	125	80	100	110	120	60	75	85	95
	280	345	375	410	260	330	360	395	195	245	280	310
K6	120	150	170	185	115	145	160	175	90	110	125	135
	395	490	560	610	375	475	520	570	295	360	410	445
K7	105	135	150	165	100	125	140	155	80	100	110	120
	345	445	490	540	330	410	460	510	260	330	360	395
N1	1450	1800	2025	2225	1375	1725	1925	2125	1050	1300	1450	1600
	4750	5900	6650	7300	4500	5650	6325	6975	3450	4275	4750	5250
N2	580	730	820	900	560	690	780	860	420	530	590	650
	1900	2400	2700	2950	1825	2275	2550	2825	1375	1750	1925	2125
N3	390	485	550	600	370	460	520	570	280	350	395	435
	1275	1600	1800	1975	1225	1500	1700	1875	920	1150	1300	1425
N11	445	550	620	690	425	530	590	650	320	405	450	495
	1450	1800	2025	2275	1400	1750	1925	2125	1050	1325	1475	1625
S1	46	55	65	70	44	55	60	65	34	43	47	50
	150	180	215	230	145	180	195	215	110	140	155	165
S2	37	46	50	55	35	44	49	55	28	34	38	42
	120	150	165	180	115	145	160	180	90	110	125	140
S3	32	40	45	50	31	38	43	47	24	30	33	37
	105	130	150	165	100	125	140	155	80	100	110	120
S11	65	80	90	100	60	75	85	95	48	60	65	75
	215	260	295	330	195	245	280	310	155	195	215	245
S12	45	55	60	70	43	55	60	65	33	41	47	50
	150	180	195	230	140	180	195	215	110	135	155	165
S13	26	32	36	40	25	31	34	38	19	24	27	29
	85	105	120	130	80	100	110	125	60	80	90	95
H5	39	49	55	60	37	46	50	55	29	36	40	44
	130	160	180	195	120	150	165	180	95	120	130	145
H8	41	50	55	60	39	48	55	60	30	37	42	46
	135	165	180	195	130	155	180	195	100	120	140	150
H11	49	60	70	75	47	60	65	70	37	46	50	55
	160	195	230	245	155	195	215	230	120	150	165	180
H12	75	90	100	110	70	85	95	105	55	65	75	85
	245	295	330	360	230	280	310	345	180	215	245	280
H21	41	50	55	60	39	48	55	60	30	37	42	46
	135	165	180	195	130	155	180	195	100	120	140	150

Universal
Steel and cast iron
Stainless steel and S-materials
Stainless steel and S-materials
Non ferrous
Hard
Graphite
X-Heads
Minimaster Plus
Minimaster

MM12 Z3 – Copy milling – Insert selection – Roughing – mm/Inch

SMG		a _p		f _z			
				100%	40%	20%	10%
P1	MM12-12015-B90A30-M04 F40M	2,5	0,070	0,070	0,070	0,070	0,095
		0,10	0,0028	0,0028	0,0028	0,0028	0,0038
P2	MM12-12015-B90A30-M04 F40M	2,5	0,070	0,070	0,070	0,075	0,095
		0,10	0,0028	0,0028	0,0028	0,0030	0,0038
P3	MM12-12015-B90A30-M04 F40M	2,5	0,070	0,065	0,065	0,070	0,090
		0,10	0,0028	0,0026	0,0026	0,0028	0,0036
P4	MM12-12015-B90A30-M04 F40M	2,5	0,065	0,065	0,065	0,070	0,090
		0,10	0,0026	0,0026	0,0026	0,0028	0,0036
P5	MM12-12015-B90A30-M04 F40M	2,5	0,065	0,065	0,065	0,065	0,090
		0,10	0,0026	0,0026	0,0026	0,0026	0,0036
P6	MM12-12015-B90A30-M04 F40M	2,5	0,065	0,065	0,065	0,065	0,085
		0,10	0,0026	0,0026	0,0026	0,0026	0,0034
P7	MM12-12015-B90A30-M04 F40M	2,5	0,065	0,065	0,065	0,065	0,085
		0,10	0,0026	0,0026	0,0026	0,0026	0,0034
P8	MM12-12015-B90A30-M04 F40M	2,5	0,070	0,065	0,065	0,070	0,090
		0,10	0,0028	0,0026	0,0026	0,0028	0,0036
P11	MM12-12015-B90A30-M04 F40M	2,5	0,065	0,065	0,065	0,065	0,085
		0,10	0,0026	0,0026	0,0026	0,0026	0,0034
P12	MM12-12015-B90A30-M04 F40M	2,0	0,046	0,044	0,044	0,046	0,060
		0,080	0,0018	0,0017	0,0017	0,0018	0,0024
M1	MM12-12015-B90A30-M04 F40M	2,5	0,070	0,070	0,075	0,075	0,095
		0,10	0,0028	0,0028	0,0030	0,0030	0,0038
M2	MM12-12015-B90A30-M04 F40M	2,5	0,065	0,065	0,065	0,065	0,090
		0,10	0,0026	0,0026	0,0026	0,0026	0,0036
M3	MM12-12015-B90A30-M04 F40M	2,0	0,055	0,055	0,055	0,055	0,070
		0,080	0,0022	0,0022	0,0022	0,0022	0,0028
M4	MM12-12015-B90A30-M04 F40M	1,6	0,050	0,048	0,048	0,048	0,060
		0,065	0,0020	0,0019	0,0019	0,0019	0,0026
M5	MM12-12015-B90A30-M04 F40M	1,6	0,050	0,048	0,048	0,048	0,060
		0,065	0,0020	0,0019	0,0019	0,0019	0,0026
K1	MM12-12015-B90A30-E04 F30M	2,5	0,070	0,070	0,075	0,075	0,095
		0,10	0,0028	0,0028	0,0030	0,0030	0,0038
K2	MM12-12015-B90A30-E04 F30M	2,5	0,065	0,065	0,065	0,065	0,090
		0,10	0,0026	0,0026	0,0026	0,0026	0,0036
K3	MM12-12015-B90A30-E04 F30M	2,5	0,065	0,065	0,065	0,065	0,090
		0,10	0,0026	0,0026	0,0026	0,0026	0,0036
K4	MM12-12015-B90A30-E04 F30M	2,5	0,065	0,065	0,065	0,065	0,090
		0,10	0,0026	0,0026	0,0026	0,0026	0,0036
K5	MM12-12015-B90A30-M04 F40M	2,5	0,060	0,055	0,060	0,060	0,080
		0,10	0,0024	0,0022	0,0022	0,0024	0,0032
K6	MM12-12015-B90A30-M04 F40M	2,5	0,065	0,065	0,065	0,065	0,090
		0,10	0,0026	0,0026	0,0026	0,0026	0,0036
K7	MM12-12015-B90A30-M04 F40M	2,5	0,060	0,055	0,060	0,060	0,080
		0,10	0,0024	0,0022	0,0022	0,0024	0,0032
N1	MM12-12015-B90A30-E04 F30M	2,5	0,090	0,090	0,095	0,095	0,12
		0,10	0,0036	0,0036	0,0038	0,0038	0,0048
N2	MM12-12015-B90A30-E04 F30M	2,5	0,090	0,090	0,095	0,095	0,12
		0,10	0,0036	0,0036	0,0038	0,0038	0,0048
N3	MM12-12015-B90A30-E04 F30M	2,5	0,090	0,090	0,095	0,095	0,12
		0,10	0,0036	0,0036	0,0038	0,0038	0,0048
N11	MM12-12015-B90A30-E04 F30M	2,5	0,090	0,090	0,095	0,095	0,12
		0,10	0,0036	0,0036	0,0038	0,0038	0,0048
S1	MM12-12015-B90A30-M04 F40M	1,6	0,050	0,048	0,048	0,048	0,060
		0,065	0,0020	0,0019	0,0019	0,0019	0,0026
S2	MM12-12015-B90A30-M04 F40M	1,6	0,050	0,048	0,048	0,048	0,060
		0,065	0,0020	0,0019	0,0019	0,0019	0,0026
S3	MM12-12015-B90A30-M04 F40M	1,6	0,046	0,046	0,046	0,046	0,055
		0,065	0,0018	0,0018	0,0018	0,0018	0,0024
S11	MM12-12015-B90A30-M04 F40M	1,9	0,055	0,055	0,055	0,055	0,070
		0,075	0,0022	0,0022	0,0022	0,0022	0,0028
S12	MM12-12015-B90A30-M04 F40M	1,9	0,055	0,055	0,055	0,055	0,070
		0,075	0,0022	0,0022	0,0022	0,0022	0,0028
S13	MM12-12015-B90A30-M04 F40M	1,6	0,050	0,048	0,048	0,048	0,060
		0,065	0,0020	0,0019	0,0019	0,0019	0,0026
H5	MM12-12015-B90A30-E04 F30M	2,0	0,046	0,044	0,046	0,046	0,060
		0,080	0,0018	0,0017	0,0018	0,0018	0,0024
H8	MM12-12015-B90A30-E04 F30M	1,9	0,036	0,036	0,036	0,036	0,046
		0,075	0,0014	0,0014	0,0014	0,0014	0,0018
H11	MM12-12015-B90A30-E04 F30M	2,0	0,046	0,044	0,046	0,046	0,060
		0,080	0,0018	0,0017	0,0018	0,0018	0,0024
H12	MM12-12015-B90A30-E04 F30M	1,9	0,036	0,036	0,036	0,036	0,046
		0,075	0,0014	0,0014	0,0014	0,0014	0,0018
H21	MM12-12015-B90A30-E04 F30M	1,9	0,036	0,036	0,036	0,036	0,046
		0,075	0,0014	0,0014	0,0014	0,0014	0,0018

SMG = Seco material group
f_z = mm/tooth (in/tooth), v_c = m/min (sf/min), a_p/DC = %
All cutting data are start values

MM12 Z3 – Copy milling – Insert selection – Finishing – mm/Inch

SMG		a _p	f _z			
			15%	10%	5%	2%
P1	MM12-12015-B90A30-E04 F30M	2,5	0,080	0,095	0,13	0,22
		0.10	0.0032	0.0038	0.0050	0.0085
P2	MM12-12015-B90A30-E04 F30M	2,5	0,080	0,095	0,13	0,22
		0.10	0.0032	0.0038	0.0050	0.0085
P3	MM12-12015-B90A30-E04 F30M	2,5	0,075	0,090	0,13	0,20
		0.10	0.0030	0.0036	0.0050	0.0080
P4	MM12-12015-B90A30-E04 F30M	2,5	0,075	0,090	0,12	0,20
		0.10	0.0030	0.0036	0.0048	0.0080
P5	MM12-12015-B90A30-E04 F30M	2,5	0,075	0,090	0,12	0,20
		0.10	0.0030	0.0036	0.0048	0.0080
P6	MM12-12015-B90A30-E04 F30M	2,5	0,075	0,085	0,12	0,19
		0.10	0.0030	0.0034	0.0048	0.0075
P7	MM12-12015-B90A30-E04 F30M	2,5	0,075	0,085	0,12	0,19
		0.10	0.0030	0.0034	0.0048	0.0075
P8	MM12-12015-B90A30-E04 F30M	2,5	0,075	0,090	0,13	0,20
		0.10	0.0030	0.0036	0.0050	0.0080
P11	MM12-12015-B90A30-E04 F30M	2,5	0,075	0,085	0,12	0,19
		0.10	0.0030	0.0034	0.0048	0.0075
P12	MM12-12015-B90A30-E04 F30M	2,0	0,050	0,060	0,080	0,13
		0.080	0.0020	0.0024	0.0032	0.0050
M1	MM12-12015-B90A30-E04 F30M	2,5	0,080	0,095	0,13	0,22
		0.10	0.0032	0.0038	0.0050	0.0085
M2	MM12-12015-B90A30-E04 F30M	2,5	0,075	0,090	0,12	0,20
		0.10	0.0030	0.0036	0.0048	0.0080
M3	MM12-12015-B90A30-E04 F30M	2,0	0,060	0,070	0,095	0,16
		0.080	0.0024	0.0028	0.0038	0.0065
M4	MM12-12015-B90A30-E04 F30M	1,6	0,055	0,060	0,085	0,14
		0.065	0.0022	0.0026	0.0034	0.0055
M5	MM12-12015-B90A30-E04 F30M	1,6	0,055	0,060	0,085	0,14
		0.065	0.0022	0.0026	0.0034	0.0055
K1	MM12-12015-B90A30-E04 F30M	2,5	0,080	0,095	0,13	0,22
		0.10	0.0032	0.0038	0.0050	0.0085
K2	MM12-12015-B90A30-E04 F30M	2,5	0,075	0,090	0,12	0,20
		0.10	0.0030	0.0036	0.0048	0.0080
K3	MM12-12015-B90A30-E04 F30M	2,5	0,075	0,090	0,12	0,20
		0.10	0.0030	0.0036	0.0048	0.0080
K4	MM12-12015-B90A30-E04 F30M	2,5	0,075	0,090	0,12	0,20
		0.10	0.0030	0.0036	0.0048	0.0080
K5	MM12-12015-B90A30-E04 F30M	2,5	0,065	0,080	0,11	0,18
		0.10	0.0026	0.0032	0.0044	0.0070
K6	MM12-12015-B90A30-E04 F30M	2,5	0,075	0,090	0,12	0,20
		0.10	0.0030	0.0036	0.0048	0.0080
K7	MM12-12015-B90A30-E04 F30M	2,5	0,065	0,080	0,11	0,18
		0.10	0.0026	0.0032	0.0044	0.0070
N1	MM12-12015-B90A30-E04 F30M	2,5	0,10	0,12	0,17	0,28
		0.10	0.0040	0.0048	0.0065	0.011
N2	MM12-12015-B90A30-E04 F30M	2,5	0,10	0,12	0,17	0,28
		0.10	0.0040	0.0048	0.0065	0.011
N3	MM12-12015-B90A30-E04 F30M	2,5	0,10	0,12	0,17	0,28
		0.10	0.0040	0.0048	0.0065	0.011
N11	MM12-12015-B90A30-E04 F30M	2,5	0,10	0,12	0,17	0,28
		0.10	0.0040	0.0048	0.0065	0.011
S1	MM12-12015-B90A30-E04 F30M	1,6	0,055	0,060	0,085	0,14
		0.065	0.0022	0.0026	0.0034	0.0055
S2	MM12-12015-B90A30-E04 F30M	1,6	0,055	0,060	0,085	0,14
		0.065	0.0022	0.0026	0.0034	0.0055
S3	MM12-12015-B90A30-E04 F30M	1,6	0,050	0,055	0,080	0,13
		0.065	0.0020	0.0024	0.0032	0.0050
S11	MM12-12015-B90A30-E04 F30M	1,9	0,060	0,070	0,095	0,16
		0.075	0.0024	0.0028	0.0038	0.0065
S12	MM12-12015-B90A30-E04 F30M	1,9	0,060	0,070	0,095	0,16
		0.075	0.0024	0.0028	0.0038	0.0065
S13	MM12-12015-B90A30-E04 F30M	1,6	0,055	0,060	0,085	0,14
		0.065	0.0022	0.0026	0.0034	0.0055
H5	MM12-12015-B90A30-E04 F30M	2,0	0,050	0,060	0,080	0,13
		0.080	0.0020	0.0024	0.0032	0.0050
H8	MM12-12015-B90A30-E04 F30M	1,9	0,040	0,046	0,065	0,10
		0.075	0.0016	0.0018	0.0026	0.0040
H11	MM12-12015-B90A30-E04 F30M	2,0	0,050	0,060	0,080	0,13
		0.080	0.0020	0.0024	0.0032	0.0050
H12	MM12-12015-B90A30-E04 F30M	1,9	0,040	0,046	0,065	0,10
		0.075	0.0016	0.0018	0.0026	0.0040
H21	MM12-12015-B90A30-E04 F30M	1,9	0,040	0,046	0,065	0,10
		0.075	0.0016	0.0018	0.0026	0.0040

SMG = Seco material group
 f_z = mm/tooth (in/tooth), v_c = m/min (sf/min), a_p/DC = %
 All cutting data are start values

Universal
 Steel and cast iron
 Stainless steel and S-materials
 Stainless steel and S-materials
 Non ferrous
 Hard
 Graphite
 X-Heads
 Minimaster Plus
 Minimaster

MM12 Z3 – Copy milling – Cutting data $v_c = (m/min)/(sf/min)$

SMG	F30M					F40M				
	100%	20%	10%	5%	2%	100%	20%	10%	5%	2%
P1	270	315	335	365	360	255	300	320	345	340
	890	1025	1100	1200	1175	840	980	1050	1125	1125
P2	265	305	325	355	350	250	290	310	335	330
	870	1000	1075	1175	1150	820	950	1025	1100	1075
P3	225	265	285	305	305	215	255	270	290	290
	740	870	940	1000	1000	710	840	890	950	950
P4	200	235	250	270	270	190	225	235	260	255
	660	770	820	890	890	620	740	770	850	840
P5	195	225	240	260	255	185	215	225	245	245
	640	740	790	850	840	610	710	740	800	800
P6	215	255	270	290	290	205	240	255	275	275
	710	840	890	950	950	670	790	840	900	900
P7	205	240	255	275	275	195	230	240	260	260
	670	790	840	900	900	640	750	790	850	850
P8	190	225	240	255	255	180	215	225	245	245
	620	740	790	840	840	590	710	740	800	800
P11	200	235	245	265	265	190	220	235	255	255
	660	770	800	870	870	620	720	770	840	840
P12	125	150	155	170	165	120	140	145	160	160
	410	490	510	560	540	395	460	490	520	520
M1	210	245	265	285	280	200	235	250	270	270
	690	800	870	940	920	660	770	820	890	890
M2	175	205	215	235	230	165	195	205	220	220
	570	670	710	770	750	540	640	670	720	720
M3	140	165	170	185	185	130	155	160	175	175
	460	540	560	610	610	425	510	540	570	570
M4	100	130	130	140	140	95	125	125	135	135
	330	425	460	460	460	310	410	425	445	445
M5	80	110	110	115	115	80	105	105	110	110
	260	360	375	375	375	260	345	360	360	360
K1	210	240	260	280	275	200	230	245	265	265
	690	790	850	920	900	660	750	800	870	870
K2	185	215	225	245	245	175	205	215	235	230
	610	710	740	800	800	570	670	710	770	750
K3	155	180	190	210	205	145	175	180	200	195
	510	590	620	690	670	475	570	590	660	640
K4	150	175	180	200	195	140	165	175	190	185
	490	570	590	660	640	460	540	570	620	610
K5	90	105	110	120	120	85	100	105	115	115
	295	345	360	395	395	280	330	345	375	375
K6	130	155	160	175	175	125	145	155	165	165
	425	510	520	570	570	410	475	510	540	540
K7	115	135	140	155	155	110	125	135	145	145
	375	445	460	510	510	360	410	445	475	475
N1	1575	1825	1950	2100	2100	1500	1750	1850	2000	2000
	5175	6000	6400	6900	6900	4925	5750	6075	6550	6550
N2	640	740	790	850	840	610	700	750	810	800
	2100	2425	2600	2800	2750	2000	2300	2450	2650	2625
N3	425	495	530	570	560	405	470	500	540	540
	1400	1625	1750	1875	1825	1325	1550	1650	1775	1775
N11	485	560	600	650	640	460	540	570	620	610
	1600	1825	1975	2125	2100	1500	1775	1875	2025	2000
S1	46	60	60	65	65	44	60	60	65	60
	150	195	215	215	215	145	195	195	215	195
S2	37	50	49	55	55	35	47	47	50	50
	120	165	165	180	180	115	155	165	165	165
S3	32	43	43	46	46	31	41	41	44	44
	105	140	150	150	150	100	135	140	145	145
S11	70	85	85	95	90	65	80	80	90	90
	230	280	295	310	295	215	260	280	295	295
S12	48	60	60	65	65	46	55	55	60	60
	155	195	195	215	215	150	180	195	195	195
S13	26	35	34	37	37	25	33	33	35	35
	85	115	120	120	120	80	110	115	115	115
H5	42	50	50	55	55	40	47	49	55	55
	140	165	165	180	180	130	155	160	180	180
H8	42	55	55	55	55	40	50	50	55	55
	140	180	180	180	180	130	165	165	180	180
H11	55	65	65	70	70	50	60	60	65	65
	180	215	215	230	230	165	195	195	215	215
H12	75	95	95	105	105	75	90	90	100	100
	245	310	330	345	345	245	295	310	330	330
H21	42	55	55	55	55	40	50	50	55	55
	140	180	180	180	180	130	165	165	180	180

MM12 Z2 – Copy milling – Insert selection – Roughing – mm/Inch

SMG		a _p	f _z			
			100%	40%	20%	10%
P1	MM12-12012-B90S-E05 F30M	5,0	0,075	0,080	0,090	0,12
		0.20	0.0030	0.0032	0.0036	0.0048
P2	MM12-12012-B90S-E05 F30M	5,0	0,080	0,080	0,090	0,12
		0.20	0.0032	0.0032	0.0036	0.0048
P3	MM12-12012-B90S-E05 F30M	5,0	0,075	0,075	0,085	0,11
		0.20	0.0030	0.0030	0.0034	0.0044
P4	MM12-12012-B90-MD05 F30M	5,0	0,075	0,075	0,085	0,11
		0.20	0.0030	0.0030	0.0034	0.0044
P5	MM12-12012-B90-MD05 F30M	5,0	0,070	0,070	0,085	0,11
		0.20	0.0028	0.0028	0.0034	0.0044
P6	MM12-12012-B90-MD05 F30M	5,0	0,070	0,070	0,080	0,11
		0.20	0.0028	0.0028	0.0032	0.0044
P7	MM12-12012-B90-MD05 F30M	5,0	0,070	0,070	0,080	0,11
		0.20	0.0028	0.0028	0.0032	0.0044
P8	MM12-12012-B90-MD05 F30M	5,0	0,075	0,075	0,085	0,11
		0.20	0.0030	0.0030	0.0034	0.0044
P11	MM12-12012-B90-MD05 F30M	5,0	0,070	0,070	0,080	0,11
		0.20	0.0028	0.0028	0.0032	0.0044
P12	MM12-12012-B90-MD05 F30M	4,0	0,050	0,050	0,060	0,075
		0.16	0.0020	0.0020	0.0024	0.0030
M1	MM12-12012-B90S-E05 F30M	5,0	0,080	0,080	0,090	0,12
		0.20	0.0032	0.0032	0.0036	0.0048
M2	MM12-12012-B90S-E05 F30M	5,0	0,070	0,070	0,085	0,11
		0.20	0.0028	0.0028	0.0034	0.0044
M3	MM12-12012-B90S-E05 F30M	4,0	0,060	0,060	0,070	0,090
		0.16	0.0024	0.0024	0.0028	0.0036
M4	MM12-12012-B90-MD05 F30M	3,0	0,055	0,055	0,060	0,075
		0.12	0.0022	0.0022	0.0024	0.0032
M5	MM12-12012-B90-MD05 F30M	3,0	0,055	0,055	0,060	0,075
		0.12	0.0022	0.0022	0.0024	0.0032
K1	MM12-12012-B90S-E05 F30M	5,0	0,080	0,080	0,090	0,12
		0.20	0.0032	0.0032	0.0036	0.0048
K2	MM12-12012-B90S-E05 F30M	5,0	0,070	0,070	0,085	0,11
		0.20	0.0028	0.0028	0.0034	0.0044
K3	MM12-12012-B90S-E05 F30M	5,0	0,070	0,070	0,085	0,11
		0.20	0.0028	0.0028	0.0034	0.0044
K4	MM12-12012-B90S-E05 F30M	5,0	0,070	0,070	0,085	0,11
		0.20	0.0028	0.0028	0.0034	0.0044
K5	MM12-12012-B90-MD05 F30M	5,0	0,065	0,065	0,075	0,10
		0.20	0.0026	0.0026	0.0030	0.0040
K6	MM12-12012-B90-MD05 F30M	5,0	0,070	0,070	0,085	0,11
		0.20	0.0028	0.0028	0.0034	0.0044
K7	MM12-12012-B90-MD05 F30M	5,0	0,065	0,065	0,075	0,10
		0.20	0.0026	0.0026	0.0030	0.0040
N1	MM12-12012-B90S-E05 F30M	5,0	0,10	0,10	0,12	0,15
		0.20	0.0040	0.0040	0.0048	0.0060
N2	MM12-12012-B90S-E05 F30M	5,0	0,10	0,10	0,12	0,15
		0.20	0.0040	0.0040	0.0048	0.0060
N3	MM12-12012-B90S-E05 F30M	5,0	0,10	0,10	0,12	0,15
		0.20	0.0040	0.0040	0.0048	0.0060
N11	MM12-12012-B90S-E05 F30M	5,0	0,10	0,10	0,12	0,15
		0.20	0.0040	0.0040	0.0048	0.0060
S1	MM12-12012-B90-MD05 F30M	3,0	0,055	0,055	0,060	0,075
		0.12	0.0022	0.0022	0.0024	0.0032
S2	MM12-12012-B90-MD05 F30M	3,0	0,055	0,055	0,060	0,075
		0.12	0.0022	0.0022	0.0024	0.0032
S3	MM12-12012-B90-MD05 F30M	3,0	0,050	0,050	0,055	0,070
		0.12	0.0020	0.0020	0.0022	0.0030
S11	MM12-12012-B90-MD05 F30M	3,5	0,060	0,060	0,070	0,090
		0.14	0.0024	0.0024	0.0028	0.0036
S12	MM12-12012-B90-MD05 F30M	3,5	0,060	0,060	0,070	0,090
		0.14	0.0024	0.0024	0.0028	0.0036
S13	MM12-12012-B90-MD05 F30M	3,0	0,055	0,055	0,060	0,075
		0.12	0.0022	0.0022	0.0024	0.0032
H5	MM12-12012-B90-MD05 F30M	4,0	0,050	0,050	0,060	0,075
		0.16	0.0020	0.0020	0.0024	0.0030
H8	MM12-12012-B90-MD05 F30M	3,5	0,040	0,040	0,044	0,055
		0.14	0.0016	0.0016	0.0017	0.0024
H11	MM12-12012-B90-MD05 F30M	4,0	0,050	0,050	0,060	0,075
		0.16	0.0020	0.0020	0.0024	0.0030
H12	MM12-12012-B90-MD05 F30M	3,5	0,040	0,040	0,044	0,055
		0.14	0.0016	0.0016	0.0017	0.0024
H21	MM12-12012-B90-MD05 F30M	3,5	0,040	0,040	0,044	0,055
		0.14	0.0016	0.0016	0.0017	0.0024

SMG = Seco material group
 f_z = mm/tooth (in/tooth), v_c = m/min (sf/min), a_p/DC = %
 All cutting data are start values

Universal
 Steel and cast iron
 Stainless steel and S-materials
 Stainless steel and S-materials
 Non ferrous
 Hard
 Graphite
 X-Heads
 Minimaster Plus
 Minimaster

MM12 Z2 – Copy milling – Insert selection – Finishing – mm/Inch

SMG		a_p		f_z			
				15%	10%	5%	2%
P1	MM12-12012-B90PF-M02 F15M	4,0	0,040	0,048	0,065	0,11	
		0,16	0,0016	0,0019	0,0026	0,0044	
P2	MM12-12012-B90PF-M02 F15M	4,0	0,042	0,048	0,070	0,11	
		0,16	0,0017	0,0019	0,0028	0,0044	
P3	MM12-12012-B90PF-M02 F15M	4,0	0,040	0,046	0,065	0,10	
		0,16	0,0016	0,0018	0,0026	0,0040	
P4	MM12-12012-B90PF-M02 F15M	4,0	0,038	0,046	0,065	0,10	
		0,16	0,0015	0,0018	0,0026	0,0040	
P5	MM12-12012-B90PF-M02 F15M	4,0	0,038	0,044	0,060	0,095	
		0,16	0,0015	0,0017	0,0024	0,0038	
P6	MM12-12012-B90PF-M02 F15M	4,0	0,038	0,044	0,060	0,095	
		0,16	0,0015	0,0017	0,0024	0,0038	
P7	MM12-12012-B90PF-M02 F15M	4,0	0,038	0,044	0,060	0,095	
		0,16	0,0015	0,0017	0,0024	0,0038	
P8	MM12-12012-B90PF-M02 F15M	4,0	0,040	0,046	0,065	0,10	
		0,16	0,0016	0,0018	0,0026	0,0040	
P11	MM12-12012-B90PF-M02 F15M	4,0	0,038	0,044	0,060	0,095	
		0,16	0,0015	0,0017	0,0024	0,0038	
P12	MM12-12012-B90PF-M02 F15M	3,5	0,026	0,030	0,042	0,065	
		0,14	0,0010	0,0012	0,0017	0,0026	
M1	MM12-12012-B90PF-M02 F15M	4,0	0,042	0,048	0,070	0,11	
		0,16	0,0017	0,0019	0,0028	0,0044	
M2	MM12-12012-B90PF-M02 F15M	4,0	0,038	0,044	0,060	0,095	
		0,16	0,0015	0,0017	0,0024	0,0038	
M3	MM12-12012-B90PF-M02 F15M	3,5	0,030	0,036	0,050	0,075	
		0,14	0,0012	0,0014	0,0020	0,0030	
M4	MM12-12012-B90PF-M02 F15M	2,5	0,028	0,032	0,042	0,065	
		0,10	0,0011	0,0013	0,0017	0,0026	
M5	MM12-12012-B90PF-M02 F15M	2,5	0,028	0,032	0,042	0,065	
		0,10	0,0011	0,0013	0,0017	0,0026	
K1	MM12-12012-B90PF-M02 F15M	4,0	0,042	0,048	0,070	0,11	
		0,16	0,0017	0,0019	0,0028	0,0044	
K2	MM12-12012-B90PF-M02 F15M	4,0	0,038	0,044	0,060	0,095	
		0,16	0,0015	0,0017	0,0024	0,0038	
K3	MM12-12012-B90PF-M02 F15M	4,0	0,038	0,044	0,060	0,095	
		0,16	0,0015	0,0017	0,0024	0,0038	
K4	MM12-12012-B90PF-M02 F15M	4,0	0,038	0,044	0,060	0,095	
		0,16	0,0015	0,0017	0,0024	0,0038	
K5	MM12-12012-B90PF-M02 F15M	4,0	0,034	0,040	0,055	0,085	
		0,16	0,0013	0,0016	0,0022	0,0034	
K6	MM12-12012-B90PF-M02 F15M	4,0	0,038	0,044	0,060	0,095	
		0,16	0,0015	0,0017	0,0024	0,0038	
K7	MM12-12012-B90PF-M02 F15M	4,0	0,034	0,040	0,055	0,085	
		0,16	0,0013	0,0016	0,0022	0,0034	
N1	MM12-12012-B90PF-M02 F15M	4,0	0,055	0,060	0,085	0,14	
		0,16	0,0022	0,0024	0,0034	0,0055	
N2	MM12-12012-B90PF-M02 F15M	4,0	0,055	0,060	0,085	0,14	
		0,16	0,0022	0,0024	0,0034	0,0055	
N3	MM12-12012-B90PF-M02 F15M	4,0	0,055	0,060	0,085	0,14	
		0,16	0,0022	0,0024	0,0034	0,0055	
N11	MM12-12012-B90PF-M02 F15M	4,0	0,055	0,060	0,085	0,14	
		0,16	0,0022	0,0024	0,0034	0,0055	
S1	MM12-12012-B90PF-M02 F15M	2,5	0,028	0,032	0,042	0,065	
		0,10	0,0011	0,0013	0,0017	0,0026	
S2	MM12-12012-B90PF-M02 F15M	2,5	0,028	0,032	0,042	0,065	
		0,10	0,0011	0,0013	0,0017	0,0026	
S3	MM12-12012-B90PF-M02 F15M	2,5	0,025	0,028	0,040	0,065	
		0,10	0,0010	0,0012	0,0016	0,0026	
S11	MM12-12012-B90PF-M02 F15M	3,0	0,030	0,036	0,050	0,075	
		0,12	0,0012	0,0014	0,0020	0,0030	
S12	MM12-12012-B90PF-M02 F15M	3,0	0,030	0,036	0,050	0,075	
		0,12	0,0012	0,0014	0,0020	0,0030	
S13	MM12-12012-B90PF-M02 F15M	2,5	0,028	0,032	0,042	0,065	
		0,10	0,0011	0,0013	0,0017	0,0026	
H5	MM12-12012-B90PF-M02 F15M	3,5	0,026	0,030	0,042	0,065	
		0,14	0,0010	0,0012	0,0017	0,0026	
H8	MM12-12012-B90PF-M02 F15M	3,0	0,020	0,024	0,032	0,050	
		0,12	0,00080	0,00095	0,0013	0,0020	
H11	MM12-12012-B90PF-M02 F15M	3,5	0,026	0,030	0,042	0,065	
		0,14	0,0010	0,0012	0,0017	0,0026	
H12	MM12-12012-B90PF-M02 F15M	3,0	0,020	0,024	0,032	0,050	
		0,12	0,00080	0,00095	0,0013	0,0020	
H21	MM12-12012-B90PF-M02 F15M	3,0	0,020	0,024	0,032	0,050	
		0,12	0,00080	0,00095	0,0013	0,0020	

SMG = Seco material group
 f_z = mm/tooth (in/tooth), v_c = m/min (sf/min), a_p/DC = %
 All cutting data are start values

MM12 Z2 – Copy milling – Cutting data $v_c = (m/min)/(sf/min)$

SMG	F15M					F30M					T60M				
	100%	20%	10%	5%	2%	100%	20%	10%	5%	2%	100%	20%	10%	5%	2%
P1	310	390	410	445	440	240	300	325	350	345	195	240	265	285	280
	1025	1275	1350	1450	1450	790	980	1075	1150	1125	640	790	870	940	920
P2	300	380	400	430	430	230	290	315	340	340	185	235	255	275	275
	980	1250	1300	1400	1400	750	950	1025	1125	1125	610	770	840	900	900
P3	260	330	345	370	370	200	255	275	295	295	160	205	225	240	240
	850	1075	1125	1225	1225	660	840	900	970	970	520	670	740	790	790
P4	230	290	305	325	330	175	225	245	260	260	145	180	195	210	210
	750	950	1000	1075	1075	570	740	800	850	850	475	590	640	690	690
P5	220	275	290	315	315	170	215	235	255	250	140	170	190	205	200
	720	900	950	1025	1025	560	710	770	840	820	460	560	620	670	660
P6	245	310	325	355	355	190	240	260	285	280	155	195	210	230	225
	800	1025	1075	1175	1175	620	790	850	940	920	510	640	690	750	740
P7	230	295	310	335	335	180	230	245	270	265	145	185	200	215	215
	750	970	1025	1100	1100	590	750	800	890	870	475	610	660	710	710
P8	215	275	290	310	315	170	215	235	250	250	135	170	190	200	200
	710	900	950	1025	1025	560	710	770	820	820	445	560	620	660	660
P11	225	285	300	325	325	175	220	240	260	255	140	180	195	210	210
	740	940	980	1075	1075	570	720	790	850	840	460	590	640	690	690
P12	140	180	180	195	200	115	145	150	165	160	95	120	120	135	130
	460	590	610	640	660	375	475	510	540	520	310	395	410	445	425
M1	240	305	320	345	345	185	235	255	275	270	150	190	205	225	220
	790	1000	1050	1125	1125	610	770	840	900	890	490	620	670	740	720
M2	195	250	260	285	285	155	190	210	225	225	125	155	170	185	180
	640	820	850	940	940	510	620	690	740	740	410	510	560	610	590
M3	155	200	205	220	220	125	160	165	180	180	100	130	135	145	145
	510	660	670	720	720	410	520	560	590	590	330	425	445	475	475
M4	120	155	155	165	165	100	130	130	135	140	80	105	105	110	110
	395	510	540	540	540	330	425	445	445	460	260	345	360	360	360
M5	100	130	130	140	140	85	110	105	115	115	70	85	85	95	95
	330	425	460	460	460	280	360	375	375	375	230	280	295	310	310
K1	235	300	315	340	340	180	230	250	270	270	145	185	205	220	215
	770	980	1025	1125	1125	590	750	820	890	890	475	610	670	720	710
K2	205	265	275	300	300	160	200	220	240	235	130	165	180	195	190
	670	870	900	980	980	520	660	720	790	770	425	540	590	640	620
K3	175	225	235	255	255	135	170	185	205	200	110	140	150	165	165
	570	740	770	840	840	445	560	610	670	660	360	460	490	540	540
K4	165	215	225	240	240	130	165	180	195	190	105	130	145	155	155
	540	710	740	790	790	425	540	590	640	620	345	425	475	510	510
K5	100	130	135	145	145	80	100	110	115	115	65	80	85	95	95
	330	425	445	475	475	260	330	360	375	375	215	260	280	310	310
K6	145	185	195	215	215	115	145	155	170	170	95	115	125	140	135
	475	610	640	710	710	375	475	510	560	560	310	375	410	460	445
K7	130	165	170	185	185	100	125	140	150	150	80	105	110	120	120
	425	540	560	610	610	330	410	460	490	490	260	345	360	395	395
N1	1825	2300	2425	2625	2600	1375	1725	1900	2025	2000	1100	1400	1525	1650	1625
	6000	7550	7950	8600	8525	4500	5650	6225	6650	6550	3600	4600	5000	5425	5325
N2	730	930	980	1050	1050	550	690	760	820	810	450	560	620	660	660
	2400	3050	3225	3450	3450	1800	2275	2500	2700	2650	1475	1825	2025	2175	2175
N3	490	620	650	710	700	370	465	510	550	540	300	375	410	440	440
	1600	2025	2125	2325	2300	1225	1525	1675	1800	1775	980	1225	1350	1450	1450
N11	560	710	750	810	800	425	530	580	620	620	340	430	470	500	500
	1825	2325	2450	2650	2625	1400	1750	1900	2025	2025	1125	1400	1550	1650	1650
S1	55	70	70	80	80	47	60	60	65	65	38	49	48	50	50
	180	230	260	260	260	155	195	215	215	215	125	160	165	165	165
S2	45	60	60	65	65	38	49	48	50	50	31	39	39	42	42
	150	195	215	215	215	125	160	165	165	165	100	130	135	140	140
S3	39	50	50	55	55	33	43	42	45	45	27	34	34	37	36
	130	165	180	180	180	110	140	145	150	150	90	110	120	120	120
S11	80	105	105	110	110	65	85	85	90	90	55	70	70	75	75
	260	345	360	360	360	215	280	280	295	295	180	230	230	245	245
S12	55	70	70	75	75	45	60	60	65	60	37	47	47	50	50
	180	230	245	245	245	150	195	195	215	195	120	155	160	165	165
S13	32	41	40	44	44	26	34	34	36	36	21	28	27	29	29
	105	135	145	145	145	85	110	120	120	120	70	90	95	95	95
H5	46	60	60	65	65	38	48	50	55	55	31	39	41	44	44
	150	195	195	215	215	125	155	165	180	180	100	130	135	145	145
H8	48	60	60	65	65	40	50	50	55	55	33	42	42	46	45
	155	195	215	215	215	130	165	180	180	180	110	140	140	150	150
H11	60	75	75	85	85	49	60	65	70	70	39	50	50	55	55
	195	245	260	280	280	160	195	215	230	230	130	165	165	180	180
H12	85	110	110	120	120	70	95	95	100	100	60	75	75	80	80
	280	360	375	395	395	230	310	310	330	330	195	245	260	260	260
H21	48	60	60	65	65	40	50	50	55	55	33	42	42	46	45
	155	195	215	215	215	130	165	180	180	180	110	140	140	150	150

Universal
Steel and cast iron
Stainless steel and S-materials
Stainless steel and S-materials
Non ferrous
Hard
Graphite
X-Heads
Minimaster Plus
Minimaster

MM12 High-Feed – Insert selection – mm/Inch

SMG		a _p		f _z			
				100%	70%	30%	20%
P1	MM12-12.60-HF-MD10 F30M	0,36	0,55	0,55	0,75	0,95	
		0,014	0,022	0,022	0,030	0,038	
P2	MM12-12.60-HF-MD10 F30M	0,36	0,55	0,60	0,75	0,95	
		0,014	0,022	0,024	0,030	0,038	
P3	MM12-12.60-HF-MD10 F30M	0,36	0,55	0,55	0,70	0,90	
		0,014	0,022	0,022	0,028	0,036	
P4	MM12-12.60-HF-MD10 F30M	0,36	0,55	0,55	0,70	0,90	
		0,014	0,022	0,022	0,028	0,036	
P5	MM12-12.60-HF-MD10 F30M	0,36	0,50	0,55	0,70	0,85	
		0,014	0,020	0,022	0,028	0,034	
P6	MM12-12.60-HF-MD10 F30M	0,36	0,50	0,50	0,70	0,85	
		0,014	0,020	0,020	0,028	0,034	
P7	MM12-12.60-HF-MD10 F30M	0,36	0,50	0,50	0,70	0,85	
		0,014	0,020	0,020	0,028	0,034	
P8	MM12-12.60-HF-MD10 F30M	0,36	0,55	0,55	0,70	0,90	
		0,014	0,022	0,022	0,028	0,036	
P11	MM12-12.60-HF-MD10 F30M	0,36	0,50	0,50	0,70	0,85	
		0,014	0,020	0,020	0,028	0,034	
P12	MM12-12.60-HF-MD10 F30M	0,28	0,36	0,36	0,46	0,55	
		0,011	0,014	0,014	0,018	0,022	
M1	MM12-12.60-HF-MD10 F30M	0,36	0,55	0,60	0,75	0,95	
		0,014	0,022	0,024	0,030	0,038	
M2	MM12-12.60-HF-MD10 F30M	0,36	0,50	0,55	0,70	0,85	
		0,014	0,020	0,022	0,028	0,034	
M3	MM12-12.60-HF-MD10 F30M	0,28	0,42	0,42	0,55	0,65	
		0,011	0,017	0,017	0,022	0,026	
M4	MM12-12.60-HF-MD10 F30M	0,22	0,36	0,36	0,48	0,60	
		0,0085	0,014	0,014	0,019	0,024	
M5	MM12-12.60-HF-MD10 F30M	0,22	0,36	0,36	0,48	0,60	
		0,0085	0,014	0,014	0,019	0,024	
K1	MM12-12.60-HF-MD10 F30M	0,36	0,55	0,60	0,75	0,95	
		0,014	0,022	0,024	0,030	0,038	
K2	MM12-12.60-HF-MD10 F30M	0,36	0,50	0,55	0,70	0,85	
		0,014	0,020	0,022	0,028	0,034	
K3	MM12-12.60-HF-MD10 F30M	0,36	0,50	0,55	0,70	0,85	
		0,014	0,020	0,022	0,028	0,034	
K4	MM12-12.60-HF-MD10 F30M	0,36	0,50	0,55	0,70	0,85	
		0,014	0,020	0,022	0,028	0,034	
K5	MM12-12.60-HF-MD10 F30M	0,36	0,48	0,48	0,60	0,75	
		0,014	0,019	0,019	0,024	0,030	
K6	MM12-12.60-HF-MD10 F30M	0,36	0,50	0,55	0,70	0,85	
		0,014	0,020	0,022	0,028	0,034	
K7	MM12-12.60-HF-MD10 F30M	0,36	0,48	0,48	0,60	0,75	
		0,014	0,019	0,019	0,024	0,030	
N1	MM12-12.60-HF-MD10 F30M	0,36	0,75	0,75	1,0	1,3	
		0,014	0,030	0,030	0,040	0,050	
N2	MM12-12.60-HF-MD10 F30M	0,36	0,75	0,75	1,0	1,3	
		0,014	0,030	0,030	0,040	0,050	
N3	MM12-12.60-HF-MD10 F30M	0,36	0,75	0,75	1,0	1,3	
		0,014	0,030	0,030	0,040	0,050	
N11	MM12-12.60-HF-MD10 F30M	0,36	0,75	0,75	1,0	1,3	
		0,014	0,030	0,030	0,040	0,050	
S1	MM12-12.60-HF-MD10 F30M	0,22	0,36	0,36	0,48	0,60	
		0,0085	0,014	0,014	0,019	0,024	
S2	MM12-12.60-HF-MD10 F30M	0,22	0,36	0,36	0,48	0,60	
		0,0085	0,014	0,014	0,019	0,024	
S3	MM12-12.60-HF-MD10 F30M	0,22	0,34	0,34	0,44	0,55	
		0,0085	0,013	0,013	0,017	0,022	
S11	MM12-12.60-HF-MD10 F30M	0,25	0,42	0,42	0,55	0,65	
		0,010	0,017	0,017	0,022	0,026	
S12	MM12-12.60-HF-MD10 F30M	0,25	0,42	0,42	0,55	0,65	
		0,010	0,017	0,017	0,022	0,026	
S13	MM12-12.60-HF-MD10 F30M	0,22	0,36	0,36	0,48	0,60	
		0,0085	0,014	0,014	0,019	0,024	
H5	MM12-12.60-HF-MD10 F15M	0,28	0,36	0,36	0,46	0,55	
		0,011	0,014	0,014	0,018	0,022	
H8	MM12-12.60-HF-MD10 F15M	0,25	0,28	0,28	0,36	0,42	
		0,010	0,011	0,011	0,014	0,017	
H11	MM12-12.60-HF-MD10 F15M	0,28	0,36	0,36	0,46	0,55	
		0,011	0,014	0,014	0,018	0,022	
H12	MM12-12.60-HF-MD10 F15M	0,25	0,28	0,28	0,36	0,42	
		0,010	0,011	0,011	0,014	0,017	
H21	MM12-12.60-HF-MD10 F15M	0,25	0,28	0,28	0,36	0,42	
		0,010	0,011	0,011	0,014	0,017	



SMG = Seco material group
f_z = mm/tooth (in/tooth), v_c = m/min (sf/min), a_p/DC = %
All cutting data are start values

MM12 High-Feed – Cutting data $v_c = (m/min)/(sf/min)$

SMG	F15M				F30M									
	100%	70%	30%	20%	100%	70%	30%	20%						
P1	—	—	—	—	225	275	315	330	Universal					
	—	—	—	—	740	900	1025	1075						
P2	—	—	—	—	220	265	310	320		Steel and cast iron				
	—	—	—	—	720	870	1025	1050						
P3	—	—	—	—	190	230	270	280			Stainless steel and S-materials			
	—	—	—	—	620	750	890	920						
P4	—	—	—	—	165	205	235	245				Stainless steel and S-materials		
	—	—	—	—	540	670	770	800						
P5	—	—	—	—	165	195	225	240					Stainless steel and S-materials	
	—	—	—	—	540	640	740	790						
P6	—	—	—	—	185	225	255	270						Stainless steel and S-materials
	—	—	—	—	610	740	840	890						
P7	—	—	—	—	170	210	240	255	Stainless steel and S-materials					
	—	—	—	—	560	690	790	840						
P8	—	—	—	—	160	195	225	235		Stainless steel and S-materials				
	—	—	—	—	520	640	740	770						
P11	—	—	—	—	165	205	235	245			Stainless steel and S-materials			
	—	—	—	—	540	670	770	800						
P12	—	—	—	—	110	130	150	160				Stainless steel and S-materials		
	—	—	—	—	360	425	490	520						
M1	—	—	—	—	175	215	250	260					Stainless steel and S-materials	
	—	—	—	—	570	710	820	850						
M2	—	—	—	—	145	175	205	215						Stainless steel and S-materials
	—	—	—	—	475	570	670	710						
M3	—	—	—	—	120	140	165	175	Stainless steel and S-materials					
	—	—	—	—	395	460	540	570						
M4	—	—	—	—	95	110	125	130		Stainless steel and S-materials				
	—	—	—	—	310	360	410	425						
M5	—	—	—	—	80	90	105	110			Stainless steel and S-materials			
	—	—	—	—	260	295	345	360						
K1	185	225	260	275	175	210	245	255				Non ferrous		
	610	740	850	900	570	690	800	840						
K2	165	200	230	245	155	185	215	225					Non ferrous	
	540	660	750	800	510	610	710	740						
K3	140	170	195	205	130	155	180	190						Non ferrous
	460	560	640	670	425	510	590	620						
K4	135	160	185	195	125	150	175	185	Non ferrous					
	445	520	610	640	410	490	570	610						
K5	80	100	115	120	75	90	105	110		Non ferrous				
	260	330	375	395	245	295	345	360						
K6	120	140	165	175	110	130	155	160			Non ferrous			
	395	460	540	570	360	425	510	520						
K7	105	125	145	155	95	115	135	145				Non ferrous		
	345	410	475	510	310	375	445	475						
N1	—	—	—	—	1275	1575	1800	1875					Graphite	
	—	—	—	—	4175	5175	5900	6150						
N2	—	—	—	—	520	630	730	750						Graphite
	—	—	—	—	1700	2075	2400	2450						
N3	—	—	—	—	345	420	485	500	Graphite					
	—	—	—	—	1125	1375	1600	1650						
N11	—	—	—	—	395	480	550	570		Graphite				
	—	—	—	—	1300	1575	1800	1875						
S1	—	—	—	—	44	50	60	60			X-Heads			
	—	—	—	—	145	165	195	195						
S2	—	—	—	—	35	41	47	50				X-Heads		
	—	—	—	—	115	135	155	165						
S3	—	—	—	—	31	36	42	44					X-Heads	
	—	—	—	—	100	120	140	145						
S11	—	—	—	—	60	70	85	90						X-Heads
	—	—	—	—	195	230	280	295						
S12	—	—	—	—	42	50	55	60	X-Heads					
	—	—	—	—	140	165	180	195						
S13	—	—	—	—	25	29	33	35		X-Heads				
	—	—	—	—	80	95	110	115						
H5	39	46	55	55	36	43	50	55			Minimaster Plus			
	130	150	180	180	120	140	165	180						
H8	41	49	55	60	38	45	50	55				Minimaster Plus		
	135	160	180	195	125	150	165	180						
H11	49	60	70	70	46	55	65	65					Minimaster Plus	
	160	195	230	230	150	180	215	215						
H12	75	90	100	105	70	80	95	100						Minimaster Plus
	245	295	330	345	230	260	310	330						
H21	41	49	55	60	38	45	50	55	Minimaster Plus					
	135	160	180	195	125	150	165	180						

Universal
Steel and cast iron
Stainless steel and S-materials
Stainless steel and S-materials
Non ferrous
Hard
Graphite
X-Heads
Minimaster Plus
Minimaster

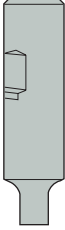
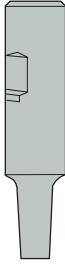
Shank design

Universal	Design 1, Keyway shank	Design 2, Cylindrical/Weldon back end and 90° front
Steel and cast iron		
Stainless steel and S-materials		
Non ferrous	Design 3, Cylindrical/Weldon back end tapered front 87°/89°	Design 4, Cylindrical/Weldon back end tapered front 80°/85°/87°
Hard		
Plastic and cfrp		
Graphite	Design 5, Cylindrical back end double tapered front end 89°/85°	
X-Heads		
Minimaster Plus		

MM16 Shank – Metric

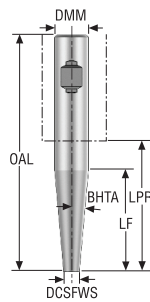

Designation	Item number	Type of mounting	DCSFWS	DMM	OAL	LF	LPR	BHTA°	Design		RPMX	Weight	Spare part no.
			mm	mm	mm	mm	mm				kg		
MM16-20115.3-3045	75014109	Weldon	15,2	20,0	115,0	45,8	65,0	3,0	4	✓	63600	0,2	3
MM16-25100.3-0019	75012790	Weldon	15,2	25,0	100,0	19,0	40,0	0,0	2	✓	63600	0,3	3
MM16-25115.3-3035	75012791	Weldon	15,2	25,0	115,0	35,0	59,0	3,0	3	✓	63600	0,3	3
MM16-25170.3-5056	75012792	Weldon	15,2	25,0	170,0	56,0	114,0	5,0	4	✓	63600	0,6	4
MM16-16070.0-0011M	00023547	Cylindrical	15,2	16,0	70,0	11,3	22,0	0,0	2	✓	63600	0,1	1
MM16-20070.0-0000	00023548	Cylindrical	15,2	20,0	70,0	0,0	20,0	60,0	1	✓	63600	0,2	1
MM16-20190.0-1055M	00094766	Cylindrical	15,2	20,0	190,0	55,0	140,0	1,0	3	✓	63600	0,4	5
MM16-20190.0-1075M	00094768	Cylindrical	15,2	20,0	190,0	75,0	140,0	1,0	3	✓	63600	0,4	5
MM16-20190.0-1095M	00094770	Cylindrical	15,2	20,0	190,0	95,0	140,0	1,0	3	✓	63600	0,4	6
MM16-25170.0-1060	00094767	Cylindrical	19,0	25,0	170,0	60,0	114,0	1,0	3	✓	63600	0,5	5
MM16-32250.0-10047	75069368	Cylindrical	15,2	32,0	250,0	47,6	190,0	10,0	4	✓	63600	1,3	4
MM16-16150.0-0080DS	02580692	Cylindrical	15,2	16,0	150,0	80,0	102,0	0,0	2	✓	47600	0,4	2
MM16-20080.0-0011DS	02580669	Cylindrical	15,2	20,0	80,0	11,3	30,0	0,0	2	✓	47600	0,4	2
MM16-20150.0-0038DS	02580695	Cylindrical	15,2	20,0	150,0	38,0	100,0	0,0	2	✓	47600	0,6	2
MM16-20160.0-0076DS	02580699	Cylindrical	15,2	20,0	160,0	76,0	110,0	0,0	2	✓	47600	0,6	2
MM16-20130.0-1045DS	02580757	Cylindrical	15,2	20,0	130,0	45,0	80,0	1,0	3	✓	47600	0,5	2
MM16-20190.0-1075DS	02580758	Cylindrical	15,2	20,0	190,0	75,0	140,0	1,0	3	✓	47600	0,8	2
MM16-20190.0-1095DS	02580760	Cylindrical	15,2	20,0	190,0	95,0	140,0	1,0	3	✓	47600	0,8	2
MM16-25250.0-1075DS	02580761	Cylindrical	15,2	25,0	250,0	75,0	194,0	1,0	5	✓	47600	1,5	2

Spare Parts, included in delivery

For cutter	Sleeve	Tension screw
3	 MM-10062	 MM16-1045
4	MM-10132	MM16-1045
1	MM-10030	MM16-1045
5	MM-10062	MM16-1093
6	MM-10062	MM16-10113
2	-	MM16-1045

Universal

Steel and cast iron

Stainless steel and S-materials

Stainless steel and S-materials

Non ferrous

Hard

Graphite

X-Heads

Minimaster Plus

Minimaster

MM16 Shank – Inch

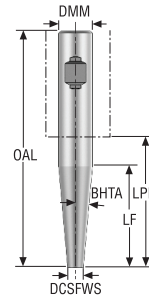

Designation	Item number	Type of mounting	DCSFWS	DMM	OAL	LF	LPR	BHTA°	Design		RPMX	Weight	Spare part no.
			inch	inch	inch	inch	inch					lbs	
MM16-0.75-4.5-3-3018	75054603	Weldon	0.598	0.750	4.528	1.445	2.559	3,0	3	✓	63600	0.440	4
MM16-1.00-3.9-3-0007	75015058	Weldon	0.598	1.000	3.937	0.748	1.732	0,0	2	✓	63600	0.880	4
MM16-1.00-4.5-3-3013	75015059	Weldon	0.598	1.000	4.528	1.378	2.323	3,0	3	✓	63600	0.880	4
MM16-1.00-6.7-3-5022	75015060	Weldon	0.598	1.000	6.693	2.295	4.488	5,0	4	✓	63600	1.320	5
MM16-0.62-2.8-0M-0004	00037209	Cylindrical	0.598	0.625	2.756	0.445	0.866	0,0	2	✓	63600	0.220	1
MM16-0.75-2.8-0-0000	00037175	Cylindrical	0.598	0.750	2.756	0	0.787	60,0	1	✓	63600	0.440	1
MM16-0.75-7.5-0-1021	75054731	Cylindrical	0.598	0.750	7.480	2.165	5.512	1,0	3	✓	63600	0.880	6
MM16-0.75-7.5-0-1037	75054733	Cylindrical	0.598	0.750	7.480	3.740	5.512	1,0	3	✓	63600	0.880	7
MM16-0.75-7.5-0-1029DS	02567719	Cylindrical	0.598	0.750	7.480	2.953	5.512	1,0	3	✓	47600	1.760	3
MM16-0.75-7.5-0-1037DS	02593431	Cylindrical	0.598	0.750	7.480	3.740	5.512	1,0	3	✓	47600	1.540	3
MM16-1.00-5.9-0-0015DS	02593433	Cylindrical	0.598	1.000	5.906	1.496	3.701	0,0	2	✓	47600	2.200	3
MM16-1.00-6.3-0-0030DS	02593434	Cylindrical	0.598	1.000	6.299	2.992	4.094	0,0	2	✓	47600	1.980	3

Spare Parts, included in delivery

For cutter	Sleeve	Tension screw
4	MM-10062	MM16-1045
5	MM-10132	MM16-1045
1	MM-10030	MM16-1045
6	MM-10062	MM16-1093
7	MM-10062	MM16-10113
3	-	MM16-1045

Slot milling/square shoulder milling

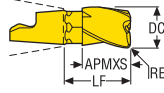

• For Torque keys and torque values, see page 720

Designation	DC	APMXS	RE	LF	RMPX°	C min	C max	FHA°	ZEFP	Wrench 	Grades					
											Coated					
											T60M	F15M	F30M	F40M		
	mm Inch	mm Inch	mm Inch	mm Inch												
MM16-15719-R03A30-M06	15,7 0.618	19,05 0.750	0,3 0.012	24,5 0.965	15,0	19,0	30,6	30	3							
MM16-15919-R08A30-M06	15,875 0.625	19,05 0.750	0,8 0.031	24,5 0.965	15,0	19,2	29,9	30	3							
MM16-16019-A30-E06	16,0 0.630	19,05 0.750	0,0 -	24,5 0.965	15,0	19,4	31,8	30	3							
MM16-16019-R05A30-M06	16,0 0.630	19,05 0.750	0,5 0.020	24,5 0.965	15,0	19,4	30,8	30	3							
MM16-16019-R10A30-E06	16,0 0.630	19,05 0.750	1,0 0.039	24,5 0.965	15,0	19,4	29,8	30	3							
MM16-16019-R10A30-M06	16,0 0.630	19,05 0.750	1,0 0.039	24,5 0.965	15,0	19,4	29,8	30	3							
MM16-16019-R20A30-M06	16,0 0.630	19,05 0.750	2,0 0.079	24,5 0.965	15,0	19,4	27,8	30	3							
MM16-16019-R30A30-E06	16,0 0.630	19,05 0.750	3,0 0.118	24,5 0.965	15,0	19,4	25,8	30	3							
MM16-16019-R30A30-M06	16,0 0.630	19,05 0.750	3,0 0.118	24,5 0.965	15,0	19,4	25,8	30	3							
MM16-16019-R40A30-M06	16,0 0.630	19,05 0.750	4,0 0.157	24,5 0.965	15,0	19,4	23,8	30	3							
MM16-16019-R50A30-M06	16,0 0.630	19,05 0.750	5,0 0.197	24,5 0.965	15,0	19,4	21,8	30	3							
MM16-16019-R60A30-M06	16,0 0.630	19,05 0.750	6,0 0.236	24,5 0.965	15,0	19,4	19,8	30	3							
MM16-20015-A30-E06	20,0 0.787	15,0 0.591	0,0 -	20,15 0.793	15,0	24,2	39,8	30	3							
MM16-20015-R05A30-M06	20,0 0.787	15,0 0.591	0,5 0.020	20,15 0.793	15,0	24,2	38,8	30	3							
MM16-20015-R10A30-M06	20,0 0.787	15,0 0.591	1,0 0.039	20,15 0.793	15,0	24,2	37,8	30	3							
MM16-20015-R20A30-D06	20,0 0.787	15,0 0.591	2,0 0.079	20,15 0.793	15,0	24,2	35,8	30	3							
MM16-20015-R30A30-M06	20,0 0.787	15,0 0.591	3,0 0.118	20,15 0.793	15,0	24,2	33,8	30	3							
MM16-20015-R50A30-M06	20,0 0.787	15,0 0.591	5,0 0.197	20,15 0.793	15,0	24,2	29,8	30	3							

Universal

Steel and cast iron

Stainless steel and S-materials

Stainless steel and S-materials

Non ferrous

Hard

Graphite

X-Heads

Minimaster Plus

Minimaster

Slot milling/square shoulder milling

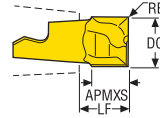

• For Torque keys and torque values, see page 720

Designation	DC	APMXS	RE	LF	RMPX°	C min	C max	FHA°	ZEPF	Wrench	Grades			
											Coated			
	mm Inch	mm Inch	mm Inch	mm Inch							T60M	F15M	F30M	F40M
MM16-15711T-R03-D07	15,7 0.618	11,0 0.433	0,3 0.012	13,6 0.535	15,0	19,0	30,6	0	2		■			
MM16-16011-M06	16,0 0.630	11,0 0.433	0,0 –	13,6 0.535	15,0	19,4	31,8	0	2		■			
MM16-16011-R08A8-E06	16,0 0.630	10,5 0.413	0,8 0.031	13,62 0.536	15,0	19,4	30,2	8	2		■		■	
MM16-16011-R08-MD07	16,0 0.630	11,0 0.433	0,8 0.031	13,58 0.535	15,0	19,4	30,2	0	2		■		■	
MM16-16011-R08P-M05	16,0 0.630	10,8 0.425	0,8 0.031	13,41 0.528	15,0	19,4	30,2	0	2				■	
MM16-16011-R20-MD07	16,0 0.630	10,9 0.429	2,0 0.079	13,55 0.533	15,0	19,4	27,8	0	2				■	
MM16-16011-R30-MD07	16,0 0.630	10,9 0.429	3,0 0.118	13,54 0.533	15,0	19,4	25,8	0	2				■	
MM16-16011-R40-MD07	16,0 0.630	10,9 0.429	4,0 0.157	13,52 0.532	15,0	19,4	23,8	0	2		■			
MM16-16011-R50-MD07	16,0 0.630	10,9 0.429	5,0 0.197	13,5 0.531	15,0	19,4	21,8	0	2		■			
MM16-19013-R08A8-E06	19,05 0.750	12,7 0.500	0,8 0.031	15,39 0.606	15,0	23,1	36,3	8	2				■	
MM16-20013-R08A8-E06	20,0 0.787	12,7 0.500	0,8 0.031	15,42 0.607	15,0	24,2	38,2	8	2		■		■	

Universal

Steel and cast iron

Stainless steel
and S-materials

Non ferrous

Hard

Plastic and cfrp

Graphite

X-Heads



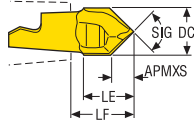

Minimaster Plus

Minimaster

Centre drilling





• For Torque keys and torque values, see page 720

Designation	DC	APMXS	LE	LF	SIG°	ZEFP	Wrench 	Grades			
								T60M	F15M	F30M	F40M
MM16-16008-C90-M06	16,0 0.630	7,53 0.296	16,7 0.657	19,2 0.756	90,0	2		■			
MM16-16011-C120-M06	16,0 0.630	4,3 0.169	16,64 0.655	18,9 0.744	120,0	2		■			
MM16-19019-C90	19,05 0.750	9,6 0.378	20,3 0.799	22,15 0.872	90,0	2		■			

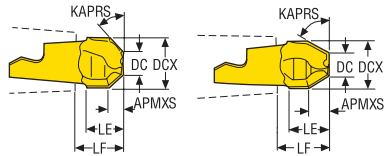
Chamfering



• For Torque keys and torque values, see page 720

Designation	DCX	DC	APMXS	LE	LF	KAPRS°	ZEFP	Wrench 	Grades			
									T60M	F15M	F30M	F40M
MM16-16011-4540-E06	16,0 0.630	7,69 0.303	3,9 0.154	10,9 0.429	13,25 0.522	45,0	2		■			
MM16-16012-6060-E06	16,0 0.630	8,38 0.330	6,7 0.264	12,9 0.508	15,3 0.602	60,0	2		■			

Universal

Steel and cast iron

Stainless steel and S-materials

Stainless steel and S-materials

Non ferrous

Hard

Graphite

X-Heads

Minimaster Plus

Minimaster

Plunge milling

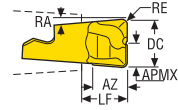

• For Torque keys and torque values, see page 720

Designation	DC	APMXE	RE	AZ	LF	RA°	ZEFP	Wrench	Grades			
									Coated			
	mm <i>Inch</i>	mm <i>Inch</i>	mm <i>Inch</i>	mm <i>Inch</i>	mm <i>Inch</i>				T60M	F15M	F30M	F40M
MM16-16011-R10-PL-MD07	16,0 0.630	8,0 0.315	1,0 0.039	11,3 0.445	11,3 0.445	5,0	2				■	
MM16-16011-R20-PL-MD07	16,0 0.630	8,0 0.315	2,0 0.079	11,3 0.445	11,3 0.445	5,0	2				■	

Precision inserts for semi-finishing in all materials

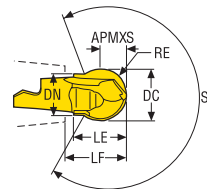

• For Torque keys and torque values, see page 720

Designation	DC	APMXS	RE	LE	LF	DN	SA°	ZEFP	Wrench	Grades			
										Coated			
	mm <i>Inch</i>	mm <i>Inch</i>	mm <i>Inch</i>	mm <i>Inch</i>	mm <i>Inch</i>	mm <i>Inch</i>				T60M	F15M	F30M	F40M
MM16-20020-B120PF-M04	20,0 0.787	10,0 0.394	10,0 0.394	20,0 0.787	21,94 0.864	15,9 0.626	254,0	2			■		
MM16-20020-B120P-M07	20,0 0.787	10,0 0.394	10,0 0.394	20,0 0.787	21,94 0.864	15,9 0.626	254,0	2				■	

Copy milling

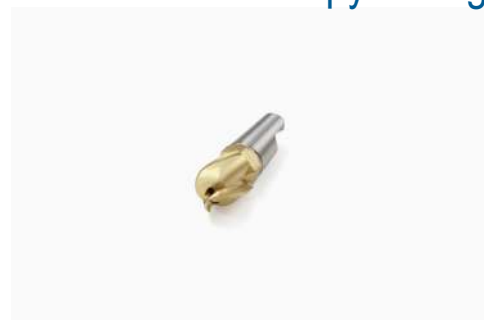
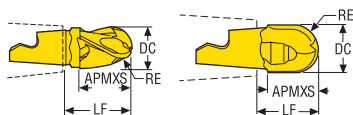

• For Torque keys and torque values, see page 720

Designation	DC	APMXS	RE	LF	FHA°	ZEFP	Wrench 	Grades			
								Coated			
								T60M	F15M	F30M	F40M
MM16-15916-B90P-M07	15,875 0.625	13,8 0.543	7,938 0.313	18,4 0.724	0,0	2			■		
MM16-16016-B90-MD07	16,0 0.630	16,2 0.638	8,0 0.315	18,4 0.724	0,0	2	■		■		
MM16-16016-B90PF-M03	16,0 0.630	13,8 0.543	8,0 0.315	18,4 0.724	0,0	2		■			
MM16-16016-B90P-M07	16,0 0.630	13,8 0.543	8,0 0.315	18,4 0.724	0,0	2			■		
MM16-16019-B90A30-E06	16,0 0.630	19,0 0.748	8,0 0.315	24,5 0.965	30,0	3			■		
MM16-16019-B90A30-M06	16,0 0.630	19,0 0.748	8,0 0.315	24,5 0.965	30,0	3				■	
MM16-19020-B90P-M07	19,05 0.750	7,4 0.291	9,525 0.375	22,12 0.871	0,0	2	■				
MM16-20015-B90A30-E06	20,0 0.787	15,0 0.591	10,0 0.394	20,15 0.793	30,0	3			■		
MM16-20015-B90A30-M06	20,0 0.787	15,0 0.591	10,0 0.394	20,15 0.793	30,0	3				■	
MM16-20020-B90-MD07	20,0 0.787	20,3 0.799	10,0 0.394	22,15 0.872	0,0	2	■		■		
MM16-20020-B90P-M07	20,0 0.787	17,4 0.685	10,0 0.394	22,12 0.871	0,0	2			■		

Universal

Steel and cast iron

Stainless steel and S-materials

Stainless steel and S-materials

Non ferrous

Hard

Graphite

X-Heads

Minimaster Plus

Minimaster

MM16 - Slot and Side milling – Insert selection – mm/Inch

SMG		a _p	f _z			
			100%	40%	20%	10%
P1	MM16-16019-R05A30-M06 F40M	3,5	0,085	0,085	0,11	0,14
		0,14	0,0034	0,0034	0,0044	0,0055
P2	MM16-16019-R05A30-M06 F40M	3,5	0,085	0,090	0,11	0,14
		0,14	0,0034	0,0036	0,0044	0,0055
P3	MM16-16019-R05A30-M06 F40M	3,5	0,080	0,085	0,10	0,14
		0,14	0,0032	0,0034	0,0040	0,0055
P4	MM16-16019-R05A30-M06 F40M	3,5	0,080	0,080	0,10	0,13
		0,14	0,0032	0,0032	0,0040	0,0050
P5	MM16-16019-R05A30-M06 F40M	3,5	0,080	0,080	0,10	0,13
		0,14	0,0032	0,0032	0,0040	0,0050
P6	MM16-16019-R05A30-M06 F40M	3,5	0,080	0,080	0,095	0,13
		0,14	0,0032	0,0032	0,0038	0,0050
P7	MM16-16019-R05A30-M06 F40M	3,5	0,080	0,080	0,095	0,13
		0,14	0,0032	0,0032	0,0038	0,0050
P8	MM16-16019-R05A30-M06 F40M	3,5	0,080	0,085	0,10	0,14
		0,14	0,0032	0,0034	0,0040	0,0055
P11	MM16-16019-R05A30-M06 F40M	3,5	0,080	0,080	0,095	0,13
		0,14	0,0032	0,0032	0,0038	0,0050
P12	MM16-16019-R05A30-M06 F40M	2,5	0,055	0,055	0,065	0,090
		0,10	0,0022	0,0022	0,0026	0,0036
M1	MM16-16019-R05A30-M06 F40M	3,5	0,085	0,090	0,11	0,14
		0,14	0,0034	0,0036	0,0044	0,0055
M2	MM16-16019-R05A30-M06 F40M	3,5	0,080	0,080	0,10	0,13
		0,14	0,0032	0,0032	0,0040	0,0050
M3	MM16-16019-R05A30-M06 F40M	2,5	0,065	0,065	0,080	0,10
		0,10	0,0026	0,0026	0,0032	0,0040
M4	MM16-16019-R05A30-M06 F40M	2,0	0,055	0,055	0,070	0,090
		0,080	0,0022	0,0022	0,0028	0,0036
M5	MM16-16019-R05A30-M06 F40M	2,0	0,055	0,055	0,070	0,090
		0,080	0,0022	0,0022	0,0028	0,0036
K1	MM16-16019-R10A30-E06 F30M	3,5	0,090	0,090	0,11	0,14
		0,14	0,0036	0,0036	0,0044	0,0055
K2	MM16-16019-R10A30-E06 F30M	3,5	0,080	0,080	0,10	0,13
		0,14	0,0032	0,0032	0,0040	0,0050
K3	MM16-16019-R10A30-E06 F30M	3,5	0,080	0,080	0,10	0,13
		0,14	0,0032	0,0032	0,0040	0,0050
K4	MM16-16019-R10A30-E06 F30M	3,5	0,080	0,080	0,10	0,13
		0,14	0,0032	0,0032	0,0040	0,0050
K5	MM16-16019-R10A30-M06 F40M	3,5	0,075	0,075	0,090	0,12
		0,14	0,0030	0,0030	0,0036	0,0048
K6	MM16-16019-R10A30-M06 F40M	3,5	0,080	0,080	0,10	0,13
		0,14	0,0032	0,0032	0,0040	0,0050
K7	MM16-16019-R10A30-M06 F40M	3,5	0,075	0,075	0,090	0,12
		0,14	0,0030	0,0030	0,0036	0,0048
N1	MM16-16019-R10A30-E06 F30M	3,5	0,11	0,11	0,14	0,18
		0,14	0,0044	0,0044	0,0055	0,0070
N2	MM16-16019-R10A30-E06 F30M	3,5	0,11	0,11	0,14	0,18
		0,14	0,0044	0,0044	0,0055	0,0070
N3	MM16-16019-R10A30-E06 F30M	3,5	0,11	0,11	0,14	0,18
		0,14	0,0044	0,0044	0,0055	0,0070
N11	MM16-16019-R10A30-E06 F30M	3,5	0,11	0,11	0,14	0,18
		0,14	0,0044	0,0044	0,0055	0,0070
S1	MM16-16019-R05A30-M06 F40M	2,0	0,055	0,055	0,070	0,090
		0,080	0,0022	0,0022	0,0028	0,0036
S2	MM16-16019-R05A30-M06 F40M	2,0	0,055	0,055	0,070	0,090
		0,080	0,0022	0,0022	0,0028	0,0036
S3	MM16-16019-R05A30-M06 F40M	2,0	0,050	0,055	0,065	0,085
		0,080	0,0020	0,0022	0,0026	0,0034
S11	MM16-16019-R05A30-M06 F40M	2,5	0,065	0,065	0,080	0,10
		0,10	0,0026	0,0026	0,0032	0,0040
S12	MM16-16019-R05A30-M06 F40M	2,5	0,065	0,065	0,080	0,10
		0,10	0,0026	0,0026	0,0032	0,0040
S13	MM16-16019-R05A30-M06 F40M	2,0	0,055	0,055	0,070	0,090
		0,080	0,0022	0,0022	0,0028	0,0036
H5	MM16-16019-R10A30-E06 F30M	2,5	0,055	0,055	0,065	0,090
		0,10	0,0022	0,0022	0,0026	0,0036
H8	MM16-16019-R10A30-E06 F30M	2,5	0,044	0,044	0,050	0,070
		0,10	0,0017	0,0017	0,0020	0,0028
H11	MM16-16019-R10A30-E06 F30M	2,5	0,055	0,055	0,065	0,090
		0,10	0,0022	0,0022	0,0026	0,0036
H12	MM16-16019-R10A30-E06 F30M	2,5	0,044	0,044	0,050	0,070
		0,10	0,0017	0,0017	0,0020	0,0028
H21	MM16-16019-R10A30-E06 F30M	2,5	0,044	0,044	0,050	0,070
		0,10	0,0017	0,0017	0,0020	0,0028

SMG = Seco material group
f_z = mm/tooth (in/tooth), v_c = m/min (sf/min), a_g/DC = %
All cutting data are start values

MM16 - Slot and Side milling – Cutting data $v_c = (m/min)/(sf/min)$

SMG	F30M				F40M				T60M			
	100%	40%	20%	10%	100%	40%	20%	10%	100%	40%	20%	10%
P1	230	285	315	350	215	270	300	335	200	250	275	310
	750	940	1025	1150	710	890	980	1100	660	820	900	1025
P2	220	275	310	345	210	260	290	325	195	240	270	295
	720	900	1025	1125	690	850	950	1075	640	790	890	970
P3	195	240	270	295	185	225	255	280	170	210	235	260
	640	790	890	970	610	740	840	920	560	690	770	850
P4	170	215	240	265	160	205	225	250	150	185	205	225
	560	710	790	870	520	670	740	820	490	610	670	740
P5	165	205	230	250	155	195	215	240	140	175	200	220
	540	670	750	820	510	640	710	790	460	570	660	720
P6	185	230	260	285	175	215	245	270	160	200	220	245
	610	750	850	940	570	710	800	890	520	660	720	800
P7	175	220	245	265	165	205	230	255	150	190	210	235
	570	720	800	870	540	670	750	840	490	620	690	770
P8	160	205	230	250	155	190	215	235	140	175	200	215
	520	670	750	820	510	620	710	770	460	570	660	710
P11	170	210	235	260	160	200	225	245	145	185	205	225
	560	690	770	850	520	660	740	800	475	610	670	740
P12	110	135	150	165	105	130	145	155	95	120	130	145
	360	445	490	540	345	425	475	510	310	395	425	475
M1	180	225	250	275	170	210	235	260	155	190	215	240
	590	740	820	900	560	690	770	850	510	620	710	790
M2	150	185	205	225	140	175	195	215	125	160	180	200
	490	610	670	740	460	570	640	710	410	520	590	660
M3	120	150	165	180	110	140	155	175	105	130	145	155
	395	490	540	590	360	460	510	570	345	425	475	510
M4	90	115	130	140	85	110	120	135	80	100	110	120
	295	375	425	460	280	360	395	445	260	330	360	395
M5	75	95	105	115	75	90	100	110	65	85	95	100
	245	310	345	375	245	295	330	360	215	280	310	330
K1	175	220	245	270	165	205	230	260	150	190	210	235
	570	720	800	890	540	670	750	850	490	620	690	770
K2	155	195	215	240	145	185	205	225	135	170	190	210
	510	640	710	790	475	610	670	740	445	560	620	690
K3	130	165	185	205	125	155	175	190	115	145	160	175
	425	540	610	670	410	510	570	620	375	475	520	570
K4	125	160	175	195	120	150	165	185	110	135	150	170
	410	520	570	640	395	490	540	610	360	445	490	560
K5	75	95	105	115	75	90	100	110	65	80	95	100
	245	310	345	375	245	295	330	360	215	260	310	330
K6	110	140	155	170	105	130	145	160	95	120	135	150
	360	460	510	560	345	425	475	520	310	395	445	490
K7	100	120	135	150	95	115	130	140	85	105	120	130
	330	395	445	490	310	375	425	460	280	345	395	425
N1	1325	1650	1825	2025	1225	1550	1725	1925	1125	1425	1575	1750
	4350	5425	6000	6650	4025	5075	5650	6325	3700	4675	5175	5750
N2	530	670	730	820	500	630	690	770	455	570	640	700
	1750	2200	2400	2700	1650	2075	2275	2525	1500	1875	2100	2300
N3	355	445	490	540	335	420	465	520	305	385	425	470
	1175	1450	1600	1775	1100	1375	1525	1700	1000	1275	1400	1550
N11	405	510	560	620	380	475	530	590	345	435	485	540
	1325	1675	1825	2025	1250	1550	1750	1925	1125	1425	1600	1775
S1	43	55	60	65	41	50	55	60	38	46	50	55
	140	180	195	215	135	165	180	195	125	150	165	180
S2	35	43	48	55	33	41	45	50	30	37	42	46
	115	140	155	180	110	135	150	165	100	120	140	150
S3	30	38	42	46	29	35	40	44	27	33	37	40
	100	125	140	150	95	115	130	145	90	110	120	130
S11	60	75	85	90	55	70	80	90	50	65	75	80
	195	245	280	295	180	230	260	295	165	215	245	260
S12	42	50	60	65	39	49	55	60	36	45	50	55
	140	165	195	215	130	160	180	195	120	150	165	180
S13	24	30	34	37	23	29	32	35	21	26	29	32
	80	100	110	120	75	95	105	115	70	85	95	105
H5	36	45	50	55	34	43	48	50	31	39	44	48
	120	150	165	180	110	140	155	165	100	130	145	155
H8	38	47	55	60	36	45	50	55	33	41	46	50
	125	155	180	195	120	150	165	180	110	135	150	165
H11	46	60	65	70	43	55	60	65	40	50	55	60
	150	195	215	230	140	180	195	215	130	165	180	195
H12	70	85	95	105	65	80	90	100	60	75	85	90
	230	280	310	345	215	260	295	330	195	245	280	295
H21	38	47	55	60	36	45	50	55	33	41	46	50
	125	155	180	195	120	150	165	180	110	135	150	165

Universal
Steel and cast iron
Stainless steel and S-materials
Stainless steel and S-materials
Non ferrous
Hard
Graphite
X-Heads
Minimaster Plus
Minimaster

MM16 Z3 – Copy milling – Insert selection – Roughing – mm/Inch

SMG		a _p	f _z			
			100%	40%	20%	10%
P1	MM16-16019-B90A30-M06 F40M	3,5	0,11	0,10	0,11	0,14
		0,14	0,0044	0,0040	0,0044	0,0055
P2	MM16-16019-B90A30-M06 F40M	3,5	0,11	0,10	0,11	0,15
		0,14	0,0044	0,0040	0,0044	0,0060
P3	MM16-16019-B90A30-M06 F40M	3,5	0,10	0,10	0,10	0,14
		0,14	0,0040	0,0040	0,0040	0,0055
P4	MM16-16019-B90A30-M06 F40M	3,5	0,10	0,095	0,10	0,13
		0,14	0,0040	0,0038	0,0040	0,0050
P5	MM16-16019-B90A30-M06 F40M	3,5	0,10	0,095	0,10	0,13
		0,14	0,0040	0,0038	0,0040	0,0050
P6	MM16-16019-B90A30-M06 F40M	3,5	0,095	0,095	0,10	0,13
		0,14	0,0038	0,0038	0,0040	0,0050
P7	MM16-16019-B90A30-M06 F40M	3,5	0,095	0,095	0,10	0,13
		0,14	0,0038	0,0038	0,0040	0,0050
P8	MM16-16019-B90A30-M06 F40M	3,5	0,10	0,10	0,10	0,14
		0,14	0,0040	0,0040	0,0040	0,0055
P11	MM16-16019-B90A30-M06 F40M	3,5	0,095	0,095	0,10	0,13
		0,14	0,0038	0,0038	0,0040	0,0050
P12	MM16-16019-B90A30-M06 F40M	2,5	0,070	0,070	0,070	0,090
		0,10	0,0028	0,0028	0,0028	0,0036
M1	MM16-16019-B90A30-M06 F40M	3,5	0,11	0,10	0,11	0,15
		0,14	0,0044	0,0040	0,0044	0,0060
M2	MM16-16019-B90A30-M06 F40M	3,5	0,10	0,095	0,10	0,13
		0,14	0,0040	0,0038	0,0040	0,0050
M3	MM16-16019-B90A30-M06 F40M	2,5	0,085	0,080	0,080	0,11
		0,10	0,0034	0,0032	0,0032	0,0044
M4	MM16-16019-B90A30-M06 F40M	2,0	0,075	0,075	0,075	0,090
		0,080	0,0030	0,0030	0,0030	0,0038
M5	MM16-16019-B90A30-M06 F40M	2,0	0,075	0,075	0,075	0,090
		0,080	0,0030	0,0030	0,0030	0,0038
K1	MM16-16019-B90A30-E06 F30M	3,5	0,11	0,10	0,11	0,15
		0,14	0,0044	0,0040	0,0044	0,0060
K2	MM16-16019-B90A30-E06 F30M	3,5	0,10	0,095	0,10	0,13
		0,14	0,0040	0,0038	0,0040	0,0050
K3	MM16-16019-B90A30-E06 F30M	3,5	0,10	0,095	0,10	0,13
		0,14	0,0040	0,0038	0,0040	0,0050
K4	MM16-16019-B90A30-E06 F30M	3,5	0,10	0,095	0,10	0,13
		0,14	0,0040	0,0038	0,0040	0,0050
K5	MM16-16019-B90A30-E06 F30M	3,5	0,090	0,085	0,090	0,12
		0,14	0,0036	0,0034	0,0036	0,0048
K6	MM16-16019-B90A30-E06 F30M	3,5	0,10	0,095	0,10	0,13
		0,14	0,0040	0,0038	0,0040	0,0050
K7	MM16-16019-B90A30-E06 F30M	3,5	0,090	0,085	0,090	0,12
		0,14	0,0036	0,0034	0,0036	0,0048
N1	MM16-16019-B90A30-E06 F30M	3,5	0,14	0,13	0,14	0,19
		0,14	0,0055	0,0050	0,0055	0,0075
N2	MM16-16019-B90A30-E06 F30M	3,5	0,14	0,13	0,14	0,19
		0,14	0,0055	0,0050	0,0055	0,0075
N3	MM16-16019-B90A30-E06 F30M	3,5	0,14	0,13	0,14	0,19
		0,14	0,0055	0,0050	0,0055	0,0075
N11	MM16-16019-B90A30-E06 F30M	3,5	0,14	0,13	0,14	0,19
		0,14	0,0055	0,0050	0,0055	0,0075
S1	MM16-16019-B90A30-M06 F40M	2,0	0,075	0,075	0,075	0,090
		0,080	0,0030	0,0030	0,0030	0,0038
S2	MM16-16019-B90A30-M06 F40M	2,0	0,075	0,075	0,075	0,090
		0,080	0,0030	0,0030	0,0030	0,0038
S3	MM16-16019-B90A30-M06 F40M	2,0	0,070	0,070	0,070	0,085
		0,080	0,0028	0,0028	0,0028	0,0036
S11	MM16-16019-B90A30-M06 F40M	2,5	0,085	0,080	0,085	0,11
		0,10	0,0034	0,0032	0,0034	0,0044
S12	MM16-16019-B90A30-M06 F40M	2,5	0,085	0,080	0,085	0,11
		0,10	0,0034	0,0032	0,0034	0,0044
S13	MM16-16019-B90A30-M06 F40M	2,0	0,075	0,075	0,075	0,090
		0,080	0,0030	0,0030	0,0030	0,0038
H5	MM16-16019-B90A30-E06 F30M	2,5	0,070	0,070	0,070	0,090
		0,10	0,0028	0,0028	0,0028	0,0036
H8	MM16-16019-B90A30-E06 F30M	2,5	0,055	0,050	0,055	0,070
		0,10	0,0022	0,0020	0,0022	0,0028
H11	MM16-16019-B90A30-E06 F30M	2,5	0,070	0,070	0,070	0,090
		0,10	0,0028	0,0028	0,0028	0,0036
H12	MM16-16019-B90A30-E06 F30M	2,5	0,055	0,050	0,055	0,070
		0,10	0,0022	0,0020	0,0022	0,0028
H21	MM16-16019-B90A30-E06 F30M	2,5	0,055	0,050	0,055	0,070
		0,10	0,0022	0,0020	0,0022	0,0028

SMG = Seco material group
f_z = mm/tooth (in/tooth), v_c = m/min (sf/min), a_p/DC = %
All cutting data are start values

MM16 Z3 – Copy milling – Insert selection – Finishing – mm/Inch

SMG		a _p	f _z			
			15%	10%	5%	2%
P1	MM16-16019-B90A30-E06 F30M	3,5	0,12	0,14	0,20	0,32
		0,14	0,0048	0,0055	0,0080	0,013
P2	MM16-16019-B90A30-E06 F30M	3,5	0,12	0,15	0,20	0,34
		0,14	0,0048	0,0060	0,0080	0,013
P3	MM16-16019-B90A30-E06 F30M	3,5	0,12	0,14	0,19	0,32
		0,14	0,0048	0,0055	0,0075	0,013
P4	MM16-16019-B90A30-E06 F30M	3,5	0,11	0,13	0,19	0,30
		0,14	0,0044	0,0050	0,0075	0,012
P5	MM16-16019-B90A30-E06 F30M	3,5	0,11	0,13	0,18	0,30
		0,14	0,0044	0,0050	0,0070	0,012
P6	MM16-16019-B90A30-E06 F30M	3,5	0,11	0,13	0,18	0,30
		0,14	0,0044	0,0050	0,0070	0,012
P7	MM16-16019-B90A30-E06 F30M	3,5	0,11	0,13	0,18	0,30
		0,14	0,0044	0,0050	0,0070	0,012
P8	MM16-16019-B90A30-E06 F30M	3,5	0,12	0,14	0,19	0,32
		0,14	0,0048	0,0055	0,0075	0,013
P11	MM16-16019-B90A30-E06 F30M	3,5	0,11	0,13	0,18	0,30
		0,14	0,0044	0,0050	0,0070	0,012
P12	MM16-16019-B90A30-E06 F30M	2,5	0,075	0,090	0,12	0,20
		0,10	0,0030	0,0036	0,0048	0,0080
M1	MM16-16019-B90A30-E06 F30M	3,5	0,12	0,15	0,20	0,34
		0,14	0,0048	0,0060	0,0080	0,013
M2	MM16-16019-B90A30-E06 F30M	3,5	0,11	0,13	0,18	0,30
		0,14	0,0044	0,0050	0,0070	0,012
M3	MM16-16019-B90A30-E06 F30M	2,5	0,090	0,11	0,15	0,24
		0,10	0,0036	0,0044	0,0060	0,0095
M4	MM16-16019-B90A30-E06 F30M	2,0	0,080	0,090	0,13	0,20
		0,080	0,0032	0,0038	0,0050	0,0080
M5	MM16-16019-B90A30-E06 F30M	2,0	0,080	0,090	0,13	0,20
		0,080	0,0032	0,0038	0,0050	0,0080
K1	MM16-16019-B90A30-E06 F30M	3,5	0,12	0,15	0,20	0,34
		0,14	0,0048	0,0060	0,0080	0,013
K2	MM16-16019-B90A30-E06 F30M	3,5	0,11	0,13	0,18	0,30
		0,14	0,0044	0,0050	0,0070	0,012
K3	MM16-16019-B90A30-E06 F30M	3,5	0,11	0,13	0,18	0,30
		0,14	0,0044	0,0050	0,0070	0,012
K4	MM16-16019-B90A30-E06 F30M	3,5	0,11	0,13	0,18	0,30
		0,14	0,0044	0,0050	0,0070	0,012
K5	MM16-16019-B90A30-E06 F30M	3,5	0,10	0,12	0,17	0,26
		0,14	0,0040	0,0048	0,0065	0,010
K6	MM16-16019-B90A30-E06 F30M	3,5	0,11	0,13	0,18	0,30
		0,14	0,0044	0,0050	0,0070	0,012
K7	MM16-16019-B90A30-E06 F30M	3,5	0,10	0,12	0,17	0,26
		0,14	0,0040	0,0048	0,0065	0,010
N1	MM16-16019-B90A30-E06 F30M	3,5	0,16	0,19	0,26	0,44
		0,14	0,0065	0,0075	0,010	0,017
N2	MM16-16019-B90A30-E06 F30M	3,5	0,16	0,19	0,26	0,44
		0,14	0,0065	0,0075	0,010	0,017
N3	MM16-16019-B90A30-E06 F30M	3,5	0,16	0,19	0,26	0,44
		0,14	0,0065	0,0075	0,010	0,017
N11	MM16-16019-B90A30-E06 F30M	3,5	0,16	0,19	0,26	0,44
		0,14	0,0065	0,0075	0,010	0,017
S1	MM16-16019-B90A30-E06 F30M	2,0	0,080	0,090	0,13	0,20
		0,080	0,0032	0,0038	0,0050	0,0080
S2	MM16-16019-B90A30-E06 F30M	2,0	0,080	0,090	0,13	0,20
		0,080	0,0032	0,0038	0,0050	0,0080
S3	MM16-16019-B90A30-E06 F30M	2,0	0,075	0,085	0,12	0,19
		0,080	0,0030	0,0036	0,0048	0,0075
S11	MM16-16019-B90A30-E06 F30M	2,5	0,090	0,11	0,15	0,24
		0,10	0,0036	0,0044	0,0060	0,0095
S12	MM16-16019-B90A30-E06 F30M	2,5	0,090	0,11	0,15	0,24
		0,10	0,0036	0,0044	0,0060	0,0095
S13	MM16-16019-B90A30-E06 F30M	2,0	0,080	0,090	0,13	0,20
		0,080	0,0032	0,0038	0,0050	0,0080
H5	MM16-16019-B90A30-E06 F30M	2,5	0,075	0,090	0,12	0,20
		0,10	0,0030	0,0036	0,0048	0,0080
H8	MM16-16019-B90A30-E06 F30M	2,5	0,060	0,070	0,095	0,15
		0,10	0,0024	0,0028	0,0038	0,0060
H11	MM16-16019-B90A30-E06 F30M	2,5	0,075	0,090	0,12	0,20
		0,10	0,0030	0,0036	0,0048	0,0080
H12	MM16-16019-B90A30-E06 F30M	2,5	0,060	0,070	0,095	0,15
		0,10	0,0024	0,0028	0,0038	0,0060
H21	MM16-16019-B90A30-E06 F30M	2,5	0,060	0,070	0,095	0,15
		0,10	0,0024	0,0028	0,0038	0,0060

SMG = Seco material group
 f_z = mm/tooth (in/tooth), v_c = m/min (sf/min), a_p/DC = %
 All cutting data are start values

Universal
 Steel and cast iron
 Stainless steel and S-materials
 Stainless steel and S-materials
 Non ferrous
 Hard
 Graphite
 X-Heads
 Minimaster Plus
 Minimaster

MM16 Z3 – Copy milling – Cutting data $v_c = (m/min)/(sf/min)$

SMG	F30M					F40M				
	100%	20%	10%	5%	2%	100%	20%	10%	5%	2%
P1	245	295	310	335	335	235	280	295	320	320
	800	970	1025	1100	1100	770	920	970	1050	1050
P2	240	285	300	325	320	230	270	285	310	305
	790	940	980	1075	1050	750	890	940	1025	1000
P3	210	250	260	285	280	200	240	250	270	265
	690	820	850	940	920	660	790	820	890	870
P4	185	220	235	250	250	175	210	225	240	240
	610	720	770	820	820	570	690	740	790	790
P5	175	210	225	240	240	170	200	215	230	230
	570	690	740	790	790	560	660	710	750	750
P6	200	235	250	270	270	190	225	240	260	255
	660	770	820	890	890	620	740	790	850	840
P7	190	225	235	255	255	180	210	225	245	240
	620	740	770	840	840	590	690	740	800	790
P8	175	210	220	240	235	170	200	210	230	225
	570	690	720	790	770	560	660	690	750	740
P11	185	215	230	250	245	175	205	220	235	235
	610	710	750	820	800	570	670	720	770	770
P12	115	145	145	160	155	110	140	140	150	150
	375	475	475	520	510	360	460	460	490	490
M1	195	230	240	265	260	185	220	230	250	245
	640	750	790	870	850	610	720	750	820	800
M2	160	190	200	220	215	150	180	190	205	205
	520	620	660	720	710	490	590	620	670	670
M3	130	160	160	170	170	120	150	150	165	165
	425	520	520	560	560	395	490	490	540	540
M4	90	125	125	130	135	85	120	115	125	125
	295	410	425	425	445	280	395	410	410	410
M5	75	105	100	110	110	70	100	100	105	105
	245	345	360	360	360	230	330	345	345	345
K1	190	225	235	260	255	180	215	225	245	245
	620	740	770	850	840	590	710	740	800	800
K2	170	200	210	230	225	160	190	200	220	215
	560	660	690	750	740	520	620	660	720	710
K3	140	170	180	195	190	135	160	170	185	185
	460	560	590	640	620	445	520	560	610	610
K4	135	160	170	185	185	130	155	165	175	175
	445	520	560	610	610	425	510	540	570	570
K5	85	100	105	110	110	80	95	100	105	105
	280	330	345	360	360	260	310	330	345	345
K6	120	140	150	165	160	115	135	145	155	155
	395	460	490	540	520	375	445	475	510	510
K7	105	125	130	145	145	100	120	125	135	135
	345	410	425	475	475	330	395	410	445	445
N1	1425	1700	1775	1925	1900	1350	1625	1700	1850	1800
	4675	5575	5825	6325	6225	4425	5325	5575	6075	5900
N2	580	690	720	780	770	550	650	680	740	730
	1900	2275	2350	2550	2525	1800	2125	2225	2425	2400
N3	385	455	480	520	510	365	435	455	495	485
	1275	1500	1575	1700	1675	1200	1425	1500	1625	1600
N11	440	520	550	600	580	420	495	520	570	560
	1450	1700	1800	1975	1900	1375	1625	1700	1875	1825
S1	42	60	55	60	60	40	55	55	60	60
	140	195	195	195	195	130	180	195	195	195
S2	34	48	46	50	50	33	45	44	47	48
	110	155	160	165	165	110	150	155	155	155
S3	30	41	40	43	43	28	39	38	41	41
	100	135	140	140	140	90	130	135	135	135
S11	65	80	80	85	85	60	80	75	85	80
	215	260	280	280	280	195	260	260	280	260
S12	45	55	55	60	60	43	55	55	55	55
	150	180	195	195	195	140	180	180	180	180
S13	24	33	32	35	35	23	32	31	33	33
	80	110	110	115	115	75	105	110	110	110
H5	39	48	48	55	50	37	46	46	50	50
	130	155	160	180	165	120	150	150	165	165
H8	40	50	50	55	55	38	49	48	50	50
	130	165	165	180	180	125	160	165	165	165
H11	50	60	60	65	65	47	60	60	65	65
	165	195	195	215	215	155	195	195	215	215
H12	70	90	90	100	100	70	85	85	95	95
	230	295	310	330	330	230	280	295	310	310
H21	40	50	50	55	55	38	49	48	50	50
	130	165	165	180	180	125	160	165	165	165

MM16 Z2 – Copy milling – Insert selection – Roughing – mm/Inch

SMG		a _p	f _z			
			100%	40%	20%	10%
P1	MM16-16016-B90-MD07 F30M	6,0	0,11	0,11	0,13	0,17
		0.24	0.0044	0.0044	0.0050	0.0065
P2	MM16-16016-B90-MD07 F30M	6,0	0,11	0,11	0,13	0,17
		0.24	0.0044	0.0044	0.0050	0.0065
P3	MM16-16016-B90-MD07 F30M	6,0	0,11	0,10	0,12	0,16
		0.24	0.0044	0.0040	0.0048	0.0065
P4	MM16-16016-B90-MD07 F30M	6,0	0,10	0,10	0,12	0,16
		0.24	0.0040	0.0040	0.0048	0.0065
P5	MM16-16016-B90-MD07 F30M	6,0	0,10	0,10	0,12	0,15
		0.24	0.0040	0.0040	0.0048	0.0060
P6	MM16-16016-B90-MD07 F30M	6,0	0,10	0,10	0,12	0,15
		0.24	0.0040	0.0040	0.0048	0.0060
P7	MM16-16016-B90-MD07 F30M	6,0	0,10	0,10	0,12	0,15
		0.24	0.0040	0.0040	0.0048	0.0060
P8	MM16-16016-B90-MD07 F30M	6,0	0,11	0,10	0,12	0,16
		0.24	0.0044	0.0040	0.0048	0.0065
P11	MM16-16016-B90-MD07 F30M	6,0	0,10	0,10	0,12	0,15
		0.24	0.0040	0.0040	0.0048	0.0060
P12	MM16-16016-B90-MD07 F30M	5,0	0,070	0,070	0,080	0,10
		0.20	0.0028	0.0028	0.0032	0.0044
M1	MM16-16016-B90-MD07 F30M	6,0	0,11	0,11	0,13	0,17
		0.24	0.0044	0.0044	0.0050	0.0065
M2	MM16-16016-B90-MD07 F30M	6,0	0,10	0,10	0,12	0,15
		0.24	0.0040	0.0040	0.0048	0.0060
M3	MM16-16016-B90-MD07 F30M	5,0	0,085	0,080	0,095	0,12
		0.20	0.0034	0.0032	0.0038	0.0050
M4	MM16-16016-B90-MD07 F30M	4,0	0,080	0,080	0,085	0,11
		0.16	0.0032	0.0032	0.0034	0.0044
M5	MM16-16016-B90-MD07 F30M	4,0	0,080	0,080	0,085	0,11
		0.16	0.0032	0.0032	0.0034	0.0044
K1	MM16-16016-B90-MD07 F30M	6,0	0,11	0,11	0,13	0,17
		0.24	0.0044	0.0044	0.0050	0.0065
K2	MM16-16016-B90-MD07 F30M	6,0	0,10	0,10	0,12	0,15
		0.24	0.0040	0.0040	0.0048	0.0060
K3	MM16-16016-B90-MD07 F30M	6,0	0,10	0,10	0,12	0,15
		0.24	0.0040	0.0040	0.0048	0.0060
K4	MM16-16016-B90-MD07 F30M	6,0	0,10	0,10	0,12	0,15
		0.24	0.0040	0.0040	0.0048	0.0060
K5	MM16-16016-B90-MD07 F30M	6,0	0,090	0,090	0,11	0,14
		0.24	0.0036	0.0036	0.0044	0.0055
K6	MM16-16016-B90-MD07 F30M	6,0	0,10	0,10	0,12	0,15
		0.24	0.0040	0.0040	0.0048	0.0060
K7	MM16-16016-B90-MD07 F30M	6,0	0,090	0,090	0,11	0,14
		0.24	0.0036	0.0036	0.0044	0.0055
N1	MM16-16016-B90PF-M03 F15M	6,0	0,060	0,060	0,070	0,095
		0.24	0.0024	0.0024	0.0028	0.0038
N2	MM16-16016-B90PF-M03 F15M	6,0	0,060	0,060	0,070	0,095
		0.24	0.0024	0.0024	0.0028	0.0038
N3	MM16-16016-B90PF-M03 F15M	6,0	0,060	0,060	0,070	0,095
		0.24	0.0024	0.0024	0.0028	0.0038
N11	MM16-16016-B90PF-M03 F15M	6,0	0,060	0,060	0,070	0,095
		0.24	0.0024	0.0024	0.0028	0.0038
S1	MM16-16016-B90-MD07 F30M	4,0	0,080	0,080	0,085	0,11
		0.16	0.0032	0.0032	0.0034	0.0044
S2	MM16-16016-B90-MD07 F30M	4,0	0,080	0,080	0,085	0,11
		0.16	0.0032	0.0032	0.0034	0.0044
S3	MM16-16016-B90-MD07 F30M	4,0	0,070	0,070	0,080	0,10
		0.16	0.0028	0.0028	0.0032	0.0040
S11	MM16-16016-B90-MD07 F30M	4,5	0,085	0,085	0,095	0,12
		0.18	0.0034	0.0034	0.0038	0.0050
S12	MM16-16016-B90-MD07 F30M	4,5	0,085	0,085	0,095	0,12
		0.18	0.0034	0.0034	0.0038	0.0050
S13	MM16-16016-B90-MD07 F30M	4,0	0,080	0,080	0,085	0,11
		0.16	0.0032	0.0032	0.0034	0.0044
H5	MM16-16016-B90-MD07 F30M	5,0	0,070	0,070	0,080	0,10
		0.20	0.0028	0.0028	0.0032	0.0044
H8	MM16-16016-B90-MD07 F30M	4,5	0,055	0,055	0,060	0,080
		0.18	0.0022	0.0022	0.0024	0.0032
H11	MM16-16016-B90-MD07 F30M	5,0	0,070	0,070	0,080	0,10
		0.20	0.0028	0.0028	0.0032	0.0044
H12	MM16-16016-B90-MD07 F30M	4,5	0,055	0,055	0,060	0,080
		0.18	0.0022	0.0022	0.0024	0.0032
H21	MM16-16016-B90-MD07 F30M	4,5	0,055	0,055	0,060	0,080
		0.18	0.0022	0.0022	0.0024	0.0032

SMG = Seco material group
 f_z = mm/tooth (in/tooth), v_c = m/min (sf/min), a_p/DC = %
 All cutting data are start values

Universal
 Steel and cast iron
 Stainless steel and S-materials
 Stainless steel and S-materials
 Non ferrous
 Hard
 Graphite
 X-Heads
 Minimaster Plus
 Minimaster

MM16 Z2 – Copy milling – Insert selection – Finishing – mm/Inch

SMG		a _p	f _z			
			15%	10%	5%	2%
P1	MM16-16016-B90PF-M03 F15M	6,0	0,060	0,070	0,10	0,16
		0.24	0.0024	0.0028	0.0040	0.0065
P2	MM16-16016-B90PF-M03 F15M	6,0	0,060	0,075	0,10	0,16
		0.24	0.0024	0.0030	0.0040	0.0065
P3	MM16-16016-B90PF-M03 F15M	6,0	0,060	0,070	0,095	0,15
		0.24	0.0024	0.0028	0.0038	0.0060
P4	MM16-16016-B90PF-M03 F15M	6,0	0,055	0,070	0,095	0,15
		0.24	0.0022	0.0028	0.0038	0.0060
P5	MM16-16016-B90PF-M03 F15M	6,0	0,055	0,065	0,090	0,15
		0.24	0.0022	0.0026	0.0036	0.0060
P6	MM16-16016-B90PF-M03 F15M	6,0	0,055	0,065	0,090	0,14
		0.24	0.0022	0.0026	0.0036	0.0055
P7	MM16-16016-B90PF-M03 F15M	6,0	0,055	0,065	0,090	0,14
		0.24	0.0022	0.0026	0.0036	0.0055
P8	MM16-16016-B90PF-M03 F15M	6,0	0,060	0,070	0,095	0,15
		0.24	0.0024	0.0028	0.0038	0.0060
P11	MM16-16016-B90PF-M03 F15M	6,0	0,055	0,065	0,090	0,14
		0.24	0.0022	0.0026	0.0036	0.0055
P12	MM16-16016-B90PF-M03 F15M	4,5	0,038	0,046	0,060	0,10
		0.18	0.0015	0.0018	0.0024	0.0040
M1	MM16-16016-B90PF-M03 F15M	6,0	0,060	0,075	0,10	0,16
		0.24	0.0024	0.0030	0.0040	0.0065
M2	MM16-16016-B90PF-M03 F15M	6,0	0,055	0,065	0,090	0,15
		0.24	0.0022	0.0026	0.0036	0.0060
M3	MM16-16016-B90PF-M03 F15M	4,5	0,046	0,055	0,075	0,12
		0.18	0.0018	0.0022	0.0030	0.0048
M4	MM16-16016-B90PF-M03 F15M	3,5	0,040	0,046	0,065	0,10
		0.14	0.0016	0.0019	0.0026	0.0040
M5	MM16-16016-B90PF-M03 F15M	3,5	0,040	0,046	0,065	0,10
		0.14	0.0016	0.0019	0.0026	0.0040
K1	MM16-16016-B90PF-M03 F15M	6,0	0,060	0,075	0,10	0,16
		0.24	0.0024	0.0030	0.0040	0.0065
K2	MM16-16016-B90PF-M03 F15M	6,0	0,055	0,065	0,090	0,15
		0.24	0.0022	0.0026	0.0036	0.0060
K3	MM16-16016-B90PF-M03 F15M	6,0	0,055	0,065	0,090	0,15
		0.24	0.0022	0.0026	0.0036	0.0060
K4	MM16-16016-B90PF-M03 F15M	6,0	0,055	0,065	0,090	0,15
		0.24	0.0022	0.0026	0.0036	0.0060
K5	MM16-16016-B90PF-M03 F15M	6,0	0,050	0,060	0,085	0,13
		0.24	0.0020	0.0024	0.0034	0.0050
K6	MM16-16016-B90PF-M03 F15M	6,0	0,055	0,065	0,090	0,15
		0.24	0.0022	0.0026	0.0036	0.0060
K7	MM16-16016-B90PF-M03 F15M	6,0	0,050	0,060	0,085	0,13
		0.24	0.0020	0.0024	0.0034	0.0050
N1	MM16-16016-B90PF-M03 F15M	6,0	0,080	0,095	0,13	0,20
		0.24	0.0032	0.0038	0.0050	0.0080
N2	MM16-16016-B90PF-M03 F15M	6,0	0,080	0,095	0,13	0,20
		0.24	0.0032	0.0038	0.0050	0.0080
N3	MM16-16016-B90PF-M03 F15M	6,0	0,080	0,095	0,13	0,20
		0.24	0.0032	0.0038	0.0050	0.0080
N11	MM16-16016-B90PF-M03 F15M	6,0	0,080	0,095	0,13	0,20
		0.24	0.0032	0.0038	0.0050	0.0080
S1	MM16-16016-B90PF-M03 F15M	3,5	0,040	0,046	0,065	0,10
		0.14	0.0016	0.0019	0.0026	0.0040
S2	MM16-16016-B90PF-M03 F15M	3,5	0,040	0,046	0,065	0,10
		0.14	0.0016	0.0019	0.0026	0.0040
S3	MM16-16016-B90PF-M03 F15M	3,5	0,038	0,044	0,060	0,095
		0.14	0.0015	0.0017	0.0024	0.0038
S11	MM16-16016-B90PF-M03 F15M	4,0	0,046	0,055	0,075	0,12
		0.16	0.0018	0.0022	0.0030	0.0048
S12	MM16-16016-B90PF-M03 F15M	4,0	0,046	0,055	0,075	0,12
		0.16	0.0018	0.0022	0.0030	0.0048
S13	MM16-16016-B90PF-M03 F15M	3,5	0,040	0,046	0,065	0,10
		0.14	0.0016	0.0019	0.0026	0.0040
H5	MM16-16016-B90PF-M03 F15M	4,5	0,038	0,046	0,060	0,10
		0.18	0.0015	0.0018	0.0024	0.0040
H8	MM16-16016-B90PF-M03 F15M	4,0	0,030	0,034	0,048	0,075
		0.16	0.0012	0.0014	0.0019	0.0030
H11	MM16-16016-B90PF-M03 F15M	4,5	0,038	0,046	0,060	0,10
		0.18	0.0015	0.0018	0.0024	0.0040
H12	MM16-16016-B90PF-M03 F15M	4,0	0,030	0,034	0,048	0,075
		0.16	0.0012	0.0014	0.0019	0.0030
H21	MM16-16016-B90PF-M03 F15M	4,0	0,030	0,034	0,048	0,075
		0.16	0.0012	0.0014	0.0019	0.0030

SMG = Seco material group
 f_z = mm/tooth (in/tooth), v_c = m/min (sf/min), a_p/DC = %
 All cutting data are start values

MM16 Z2 – Copy milling – Cutting data $v_c = (m/min)/(sf/min)$

SMG	F15M					F30M					T60M				
	100%	20%	10%	5%	2%	100%	20%	10%	5%	2%	100%	20%	10%	5%	2%
P1	285	360	390	420	415	225	280	300	325	325	185	225	245	265	265
	940	1175	1275	1375	1350	740	920	980	1075	1075	610	740	800	870	870
P2	275	350	375	405	405	220	270	295	315	315	180	220	240	255	255
	900	1150	1225	1325	1325	720	890	970	1025	1025	590	720	790	840	840
P3	240	305	325	355	355	190	240	255	280	275	155	195	210	225	225
	790	1000	1075	1175	1175	620	790	840	920	900	510	640	690	740	740
P4	215	270	285	310	310	170	210	225	245	245	140	170	185	200	195
	710	890	940	1025	1025	560	690	740	800	800	460	560	610	660	640
P5	205	255	275	300	295	165	200	220	235	230	130	160	175	190	190
	670	840	900	980	970	540	660	720	770	750	425	520	570	620	620
P6	230	290	310	335	335	180	225	245	265	265	150	180	200	215	215
	750	950	1025	1100	1100	590	740	800	870	870	490	590	660	710	710
P7	215	275	290	315	315	170	210	230	250	250	140	170	190	200	200
	710	900	950	1025	1025	560	690	750	820	820	460	560	620	660	660
P8	200	255	275	295	295	160	200	215	235	230	130	160	175	190	190
	660	840	900	970	970	520	660	710	770	750	425	520	570	620	620
P11	210	265	285	310	310	165	205	225	240	240	135	165	180	195	195
	690	870	940	1025	1025	540	670	740	790	790	445	540	590	640	640
P12	135	175	175	190	190	110	140	145	155	155	90	110	115	125	125
	445	570	590	620	620	360	460	475	510	510	295	360	375	410	410
M1	225	285	300	330	325	175	220	235	255	250	145	180	190	205	205
	740	940	980	1075	1075	570	720	770	840	820	475	590	620	670	670
M2	185	230	250	270	265	145	180	195	210	210	120	145	160	170	170
	610	750	820	890	870	475	590	640	690	690	395	475	520	560	560
M3	150	190	195	210	210	120	150	155	170	170	95	125	125	135	135
	490	620	660	690	690	395	490	520	560	560	310	410	425	445	445
M4	115	150	150	160	160	95	125	120	130	130	75	100	95	105	105
	375	490	520	520	520	310	410	425	425	425	245	330	345	345	345
M5	95	125	125	135	135	80	100	100	110	110	65	85	80	90	85
	310	410	445	445	445	260	330	345	360	360	215	280	280	295	280
K1	220	280	295	320	320	175	215	235	250	250	140	175	190	205	200
	720	920	970	1050	1050	570	710	770	820	820	460	570	620	670	660
K2	195	245	260	285	280	155	190	210	220	220	125	155	170	180	180
	640	800	850	940	920	510	620	690	720	720	410	510	560	590	590
K3	165	205	220	240	240	130	160	175	190	185	105	130	140	150	150
	540	670	720	790	790	425	520	570	620	610	345	425	460	490	490
K4	155	195	210	230	225	125	155	170	180	180	100	125	135	145	145
	510	640	690	750	740	410	510	560	590	590	330	410	445	475	475
K5	95	120	125	135	140	75	95	100	110	110	60	75	80	90	90
	310	395	410	445	460	245	310	330	360	360	195	245	260	295	295
K6	135	175	185	200	200	110	135	150	160	155	90	110	120	130	125
	445	570	610	660	660	360	445	490	520	510	295	360	395	425	410
K7	120	150	165	175	175	95	120	130	140	140	80	95	105	115	115
	395	490	540	570	570	310	395	425	460	460	260	310	345	375	375
N1	1675	2125	2250	2450	2450	1300	1625	1725	1875	1850	1050	1325	1400	1525	1500
	5500	6975	7375	8050	8050	4275	5325	5650	6150	6075	3450	4350	4600	5000	4925
N2	680	860	910	990	990	530	660	700	760	750	425	530	570	620	610
	2225	2825	2975	3250	3250	1750	2175	2300	2500	2450	1400	1750	1875	2025	2000
N3	450	570	610	660	660	350	435	465	510	500	285	355	380	410	405
	1475	1875	2000	2175	2175	1150	1425	1525	1675	1650	940	1175	1250	1350	1325
N11	520	650	690	750	760	400	500	530	580	570	325	405	430	470	465
	1700	2125	2275	2450	2500	1300	1650	1750	1900	1875	1075	1325	1400	1550	1525
S1	55	70	70	75	75	44	55	55	60	60	36	46	45	49	49
	180	230	245	245	245	145	180	195	195	195	120	150	160	160	160
S2	44	55	55	60	60	35	46	45	49	49	29	37	36	40	39
	145	180	195	195	195	115	150	155	160	160	95	120	130	130	130
S3	38	49	48	50	50	31	40	39	43	43	25	32	32	35	35
	125	160	165	165	165	100	130	140	140	140	80	105	110	115	115
S11	75	100	100	105	105	60	80	80	85	85	50	65	65	70	70
	245	330	345	345	345	195	260	260	280	280	165	215	215	230	230
S12	55	70	70	75	75	43	55	55	60	60	35	44	44	48	48
	180	230	230	245	245	140	180	180	195	195	115	145	150	155	155
S13	31	39	39	42	42	25	32	31	34	34	20	26	25	28	28
	100	130	140	140	140	80	105	110	110	110	65	85	90	90	90
H5	45	55	60	65	65	36	46	48	50	50	30	37	39	41	41
	150	180	195	215	215	120	150	155	165	165	100	120	130	135	135
H8	46	60	60	65	65	39	50	50	55	55	31	40	40	44	43
	150	195	215	215	215	130	165	165	180	180	100	130	140	145	140
H11	55	75	75	80	80	46	60	60	65	65	38	47	49	55	50
	180	245	245	260	260	150	195	195	215	215	125	155	165	180	165
H12	85	105	105	115	115	70	90	90	95	95	55	70	70	80	80
	280	345	375	375	375	230	295	310	310	310	180	230	245	260	260
H21	46	60	60	65	65	39	50	50	55	55	31	40	40	44	43
	150	195	215	215	215	130	165	165	180	180	100	130	140	145	140

Universal
Steel and cast iron
Stainless steel and S-materials
Stainless steel and S-materials
Non ferrous
Hard
Graphite
X-Heads
Minimaster Plus
Minimaster

Torque wrench and Max RPM information

Torque wrench



Recommended RPM for all Seco cutters are shown on each catalogue page.
 Normally there is no need for balancing tools for RPM up to 10 000.
 However in some cases balancing is necessary, for instance when using heavy tools and tool holders in small machines



Torque wrench with fixed torque values to ensure the correct tightening force when mounting the Minimaster insert into its holder.
 Dynamometric keys are calibrated according to ISO 6789.
 Code key: MM02-4006
 MM02 = 2-flute (MM03 = 3-flute)
 40 = Torque value 4 Nm
 06 = Insert size

Over 10 000 RPM:
 We recommend balancing of tool and tool holders at least separately.
 Over 20 000 RPM:
 Both tool and tool holders must be balanced at least separately.
 Over 30 000 RPM:
 Tool and tool holders must be balanced as a unit.
 The max RPM in the tables should never be exceeded.)

2 flute inserts

Insert size	Torque wrench (including key end)	Replaceable key end	Torque value
			
MM06	MM02-4006	MM02-06	4 Nm
MM08	MM02-8008	MM02-08	8 Nm
MM10	MM02-1201012	MM02-1012	12 Nm
MM12	MM02-1201012	MM02-1012	12 Nm
MM12 DC= Ø 14,0	MM02-16014	MM02-14	16 Nm
MM12 DCX= Ø 16,0	MM02-1601620	MM02-1620	16 Nm
MM16	MM02-1601620	MM02-1620	16 Nm

3 flute inserts

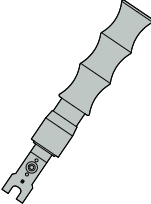
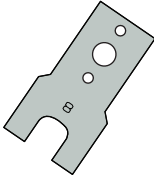
Insert size	Torque wrench (including key end)	Replaceable key end	Torque value
			
MM06	MM03-4006	MM03-06	4 Nm
MM08	MM03-8008	MM03-08	8 Nm
MM10	MM03-1201012	MM03-1012	12 Nm
MM12	MM03-1201012	MM03-1012	12 Nm
MM16	MM03-16016	MM03-16	16 Nm

SMG – Introduction



The foundation for SMG is a classification of workpiece materials based on their type rather than their relative machinability and consequently it contains workpiece materials like composites. It is comprehensive enough, but still easy to identify which SMG a particular material belongs.

Each SMG has a specific material standard in a specific condition assigned as reference to allow easy adjustment of cutting data for any actual material compared to any Seco reference material see page(s) 722-725.

As example the reference materials EN C45E for SMG P4 and EN 42 CrMo 4 for both SMG P5 and SMG H5 see further details in the following tables.

SMG	Description	Properties	Reference	SMG	Description	Properties	Reference
-----	-------------	------------	-----------	-----	-------------	------------	-----------

Focusing specifically on EN 42 CrMo 4 in annealed condition, the ultimate tensile strength R_m may typically vary between $R_m = 630 \text{ N/mm}^2$ and $R_m = 780 \text{ N/mm}^2$, which provide a reference level for SMG P5. In Quenched & Tempered condition, the ultimate tensile strength R_m may typically be between $R_m = 900 \text{ N/mm}^2$ and $R_m = 1100 \text{ N/mm}^2$ thus still belongs to SMG P5. However, if hardened above $R_m = 1200 \text{ N/mm}^2$ it instead belongs to SMG H5.

SMG	EN	W.-Nr	AFNOR	BS	UNI	JIS	AISI / ASTM	GOST	Condition	R_{m_nom}	HRC _{nom}
P5	42 CrMo 4	1.1201	42 CD 4	708 M 40	42 CrMo 4	SCM 440 (H)	4142, 4140	38HM	Annealed	700	
	42 CrMo 4	1.1201	42 CD 4	708 M 40	42 CrMo 4	SCM 440 (H)	4142, 4140	38HM	Quenched & Tempered	1000	
H5	42 CrMo 4	1.1201	42 CD 4	708 M 40	42 CrMo 4	SCM 440 (H)	4142, 4140	38HM	Quenched & Tempered		45
	42 CrMo 4	1.1201	42 CD 4	708 M 40	42 CrMo 4	SCM 440 (H)	4142, 4140	38HM	Quenched & Tempered		50

The EN 42CrMo4 quench & tempered steel could be used to illustrate the machinability dependence of materials' condition.

The graphs below indicate how speed recommendations for a nominal material conditions may be adjusted for relative R_m (left diagram valid for ISO-P) and for relative HRC (valid for ISO-H).

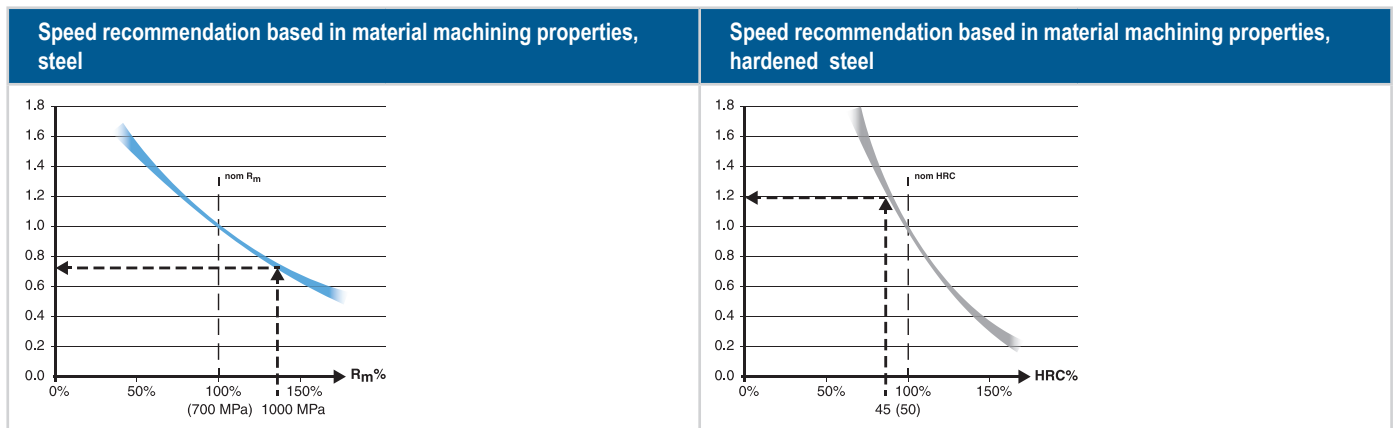

To further illustrate how the SMG P5 nominal v_c can be adjusted to a more accurate recommended v_c we need ultimate tensile strength R_m data and in this case we use the EN 42 CrMo 4 quenched & tempered to $R_m = 1000 \text{ N/mm}^2$ according to above table (bold blue arrows).

Assume that we find that the SMG P5 nominal $v_c = 280 \text{ m/min} / 918.64 \text{ sfm}$ for a certain product and machining.

Then, actual recommended $v_c = 280 \text{ m/min} \times 0.75 = 210 \text{ m/min} / v_c = 918.64 \text{ sfm} \times 0.75 = 688.98 \text{ sfm}$.

Consequently in the SMG H5 the nominal v_c can be adjusted using the hardened EN 42 CrMo 4 at HRC 45 (smaller grey arrows).

Assume that the SMG H5 nominal $v_c = 50 \text{ m/min} / 164.04 \text{ sfm}$ for a certain product and machining using a coated cemented carbide tools then, actual recommended $v_c = 50 \text{ m/min} \times 1.2 = 60 \text{ m/min} / v_c = 164.04 \text{ sfm} \times 1.2 = 196.85 \text{ sfm}$.

For further workpiece material details please see page(s) 726 - 733 and suggested cutting data at applicable pages.

For more convenient cutting data handling we recommend applicable tools in My Pages – on www.secotools.com

These cutting data compensations for steels are fully implemented at www.secotools.com in MyPages (see QR-code in the upper right corner).

Steels, ferritic and martensitic stainless steels

SMG	Description	Properties	Reference	$k_{c1.1}$	m_c
P1	Free-cutting steels	$360 < R_m < 880$	11 SMn30 $R_m = 385 \text{ N/mm}^2$	1500	0,14
P2	Low-alloy ferritic steels, $C < 0.25\% \text{wt}$ Low-alloy weldable general structural steels	$320 < R_m < 600$	S235JRG2 $R_m = 420 \text{ N/mm}^2$	1600	0,23
P3	Ferritic & ferritic/pearlitic steels, $C < 0.25\% \text{wt}$ Weldable general structural steels Case-hardening steels	$430 < R_m < 610$	16 MnCr 5 $R_m = 550 \text{ N/mm}^2$	1800	0,14
P4	Low-alloy general structural steels, $0.25\% < C < 0.67\% \text{wt}$ Low-alloy Quench & Temper steels	$520 < R_m < 1200$	C 45E $R_m = 660 \text{ N/mm}^2$	2000	0,15
P5	Structural steels, $0.25\% < C < 0.67\% \text{wt}$ Quench & Temper steels	$550 < R_m < 1200$	42 CrMo 4 $R_m = 700 \text{ N/mm}^2$	2020	0,18
P6	Low-alloy through-hardening steels, $C > 0.67\% \text{wt}$ Low-alloy spring and bearing steels	$520 < R_m < 1200$	C 100S $R_m = 600 \text{ N/mm}^2$	2100	0,17
P7	Through-hardening steels, $C > 0.67\% \text{wt}$ Spring and bearing steels	$600 < R_m < 1200$	100 Cr 6 $R_m = 650 \text{ N/mm}^2$	2160	0,17
P8	Tool steels High Speed Steels (HSS)	$600 < R_m < 1200$	X 40 CrMoV 5 1 $R_m = 700 \text{ N/mm}^2$	2400	0,20
P11	Ferritic & martensitic stainless steels	$415 < R_m < 1200$	X 20 Cr 13 $R_m = 675 \text{ N/mm}^2$	2000	0,15
P12	Maraging and precipitation-hardening stainless steels	$500 < R_m < 1200$	X 5 CrNiCuNb 16 4 $R_m = 1100 \text{ N/mm}^2$	2100	0,17

Free-cutting, austenitic and duplex stainless steels

SMG	Description	Properties	Reference	$k_{c1.1}$	m_c
M1	Free-cutting austenitic stainless steels		X 10 CrNiS 18 9	1700	0,14
M2	Low-alloy austenitic stainless steels		X 5 CrNi 18 10	1920	0,18
M3	Medium-alloy austenitic stainless steels		X 2 CrNiMo 18 14 3	2070	0,17
M4	High-alloy austenitic and duplex stainless steels		X 2 CrNiMoN 22 5 3	2230	0,16
M5	Difficult high-alloy austenitic and duplex stainless steels		X 2 CrNiMoN 25 7 4	2510	0,13

Cast irons

SMG	Description	Properties	Reference	$k_{c1.1}$	m_c
K1	Grey cast irons (GCI)		EN-GJL-250	930	0,32
K2	Compacted graphite irons (CGI)		EN-GJV-400	1000	0,35
K3	Malleable cast irons (MCI)		EN-GJMB-550-4	1050	0,37
K4	Nodular cast irons (SGI)		EN-GJS-500-7	1160	0,37
K5	Austempered ductile irons (ADI)		EN-GJS-1000-5		
K6	Austenitic lamellar cast irons		EN-GJLA-XNiCuCr15-6-2		
K7	Austenitic nodular cast irons		EN-GJSA-XNiMn23-4		

Non-ferrous metals

SMG	Description	Properties	Reference	$k_{c1.1}$	m_c
N1	Aluminium alloys, Si < 9%		AW-7075		
N2	Aluminium alloys, 9% < Si < 16%		AC-44200 Si = 12%		
N3	Aluminium alloys, Si > 16%		AlSi17Cu5		
N11	Copper alloys		CW614N	740	0,26

Superalloys and titanium

SMG	Description	Properties	Reference	$k_{c1.1}$	m_c
S1	Iron-based superalloys		Discolloy		
S2	Cobalt-based superalloys		Stellite 21		
S3	Nickel-based superalloys		Inconel 718	2530	0,21
S11	Titanium, low alloyed, (α)		Ti		
S12	Titanium, medium alloyed, (α + β)		TiAl6V4	1500	0,24
S13	Titanium, high alloyed, (near β and β)		Ti10V2Fe3Al		

Hard materials

SMG	Description	Properties	Reference	$k_{c1.1}$	m_c
H3	Case-hardened steels	58 < HRC < 62	16 MnCr 5 60 HRC	2070	0,14
H5	Quenched & Tempered steels	38 < HRC < 56	42 CrMo 4 50 HRC	2320	0,18
H7	Quenched & Tempered steels Bearing steels	56 < HRC < 64	100 Cr 6 60 HRC	2480	0,17
H8	Tool steels High Speed Steels (HSS)	38 < HRC < 64	X 40 CrMoV 5 1 50 HRC	2750	0,20
H11	Martensitic stainless steels	38 < HRC < 50	X 20 Cr 13 45 HRC	2300	0,15
H12	Maraged and precipitation- hardened stainless steels	1200 < R_m < 1650	X 5 CrNiCuNb 16 4 $R_m = 1450 \text{ N/mm}^2$	2410	0,17
H21	Manganese steels	23 < HRC < 64	X 120 Mn 12 50 HRC		
H31	White cast irons	50 < HRC < 64	EN-GJN-HV600(XCr11) 55 HRC		

Other difficult materials

SMG	Description	Properties	Reference	$k_{c1.1}$	m_c
PM1	Low-alloy PM-materials		F-0008 Fe-0.7C		
PM2	Medium-alloy PM-materials		FLC-4608 Fe2Cu1.8Ni 0.5Mo0.2Mn0.8C		
PM3	High-alloy PM-materials Exhaust valve seat materials, etc.				
HF1	Hardfacing alloys Welded or plasma-deposited iron-based alloys				
HF2	Hardfacing alloys Welded or plasma-deposited cobalt- and nickel-based alloys				
CC1	Sintered tungsten carbide		G50		

Plastics and Composites

SMG	Description	Properties	Reference	$k_{c1.1}$	m_c
TS1	Thermosetting polymers		Urea formaldehyde (UF)		
TS2	Thermosetting carbon-fibre composites		T300 T700 T800 HTA-S IMA - Epoxy (M21)...		
TS3	Thermosetting glass-fibre composites		Epoxy - HX..(42..)E glass (7781...)...		
TS4	Thermosetting aramide-fibre composites		Kevlar 49		
TP1	Thermoplastic polymers		Polycarbonate (PC)		
TP2	Thermoplastic carbon-fibre composites		PPS/PEEK - T300..		
TP3	Thermoplastic glass-fibre composites		PPS/PEEK - E-glass or A-glass...		
TP4	Thermoplastic aramide-fibre composites				

Graphite

SMG	Description	Properties	Reference	$k_{c1.1}$	m_c
GR1	Graphite		R 8500		

SMG

SMG	EN	EN-Nr	W-Nr	DIN	AFNOR	BS	UNI	JIS	SS	UNS	
P1	11 SMn 30	1.0715	1.0715	9 SMn 28	S 250	230 M 07	CF 9 SMn 28	SUM 22	1912	G12130	
	11 SMnPb 30	1.0718	1.0718	9 SMnPb 28	S 250 Pb		CF 9 SMnPb 28	SUM 22 L	1914	G12134	
	10 S 20	1.0721	1.0721	10 S 20	10 F 1	210 M 15	CF 10 S 20				
			1.0722	10 SPb 20	10 PbF 2		CF 10 SPb 20				
	15 SMn 13	1.0725	1.0723	15 S 20		210 A 15		SUM 32	1922		
	35 S20	1.0726	1.0726	35 S 20	35 MF 4	212 M 36			1957	G11400	
	46 S20	1.0727	1.0727	46 S 20	46 S 20	212 M 44			1973	G11460	
	11 SMn 37	1.0736	1.0736	9 SMn 36	S 300	240 M 07	CF 9 SMn 36			G12150	
11 SMn 37	1.0736	1.0736	9 SMn 36	S 300	240 M 07	CF 9 SMn 36			G12150		
S235JR	1.0037	1.0037	St 37-2	E 24-2		Fe 360 B	STKM 12 C	1311			
S235JRG2	1.0038	1.0116	St 37-3	E 24-3, E 24-4	4360-40 C	Fe 360 D FF		1312, 1313			
S275J2G3	1.0144	1.0144	St 44-3 N	E 28-3, E 28-4	4360-43 C	Fe 430 D FF	SM 41 C	1412, 1414			
C 10	1.0301	1.0301	C 10	34 C 10, XC 10	045 M 10	C 10	S 10 C			G10100	
		1.0401	C 15	37 C 12, XC 18	080 M 15	C 15, C 16		1350		G10170	
C22	1.0402	1.0402	C 22	C 20	050 A 20	C 20, C 21		1450		G10200	
S355JR	1.0570	1.0570	St 52-3	E 36-3, E 36-4	4360-50 C	Fe 510 B	SM 50 YA	2172, 2132			
C 15R	1.1141	1.1141	Ck 15	XC 15, XC 18	080 M 15	C 15, C 16		1370		G10170	
		1.1158	Ck 25	XC 25	060 A 25	C 25	S 25 C			G10250	
		1.2162	21 MnCr 5	20 NC 5			SCR 420 H				
P3	16 Mo 3	1.5415	1.5415	15 Mo 3	15 D 3	1501-240	16 Mo 3		2912		
			1.5423	16 Mo 5		1503-245-420	16 Mo 5	SB 450 M		G45200	
	14 NiCr 14	1.5752	1.5752	14 NiCr 14	12 NC 15	655 M 13		SNC 815 (H)		G33106	
			1.5919	15 CrNi 6	16 NC 6	S 107	16 CrNi 4				
	18 NiCrMo 7 6	1.6587	1.6587	18 CrNiMo 7 6	18 NCD 6	820 A 16	18 NiCrMo 7				
	16 MnCr 5	1.7131	1.7131	16 MnCr 5	16 MC 5	527 M 17	16 MnCr 5	SCR 415	2511		G51170
	16 MnCrS 5	1.7139	1.7139	16 MnCrS 5							
	20 MnCr 5	1.7147	1.7147	20 MnCr 5	20 MC 5		20 MnCr 5	SMnC 420 (H)			G51200
	20 MnCrS 5	1.7149	1.7149	20 MnCrS 5	20 MnCrS 5			SMnC 21 H			
	13 CrMo 4 5	1.7335	1.7335	13 CrMo 4 4	15 CD 3.5	1501-620 Gr. 27	14 CrMo 4 5		2216		
		1.7337	16 CrMo 4 4	15 CD 4.5	1501-620 Gr. 27	14 CrMo 4 5		2216			
10 CrMo 9 10	1.7380	1.7380	10 CrMo 9 10	10 CD 9.10	1501-622 Gr. 31	12 CrMo 9 10		2218		J21890	
P4	C35		1.0501	C 35	55 C 35	060 A 35	C 35		1550	G10350	
	E 335	1.0503	1.0503	C 45	65 C 45	80 M 46	C 45	S 45 C	1650	G10430	
	C40		1.0511	C 40	60 C 40	080 M 40	C 40	S 40 C			
	E 360	1.0070	1.0535	St 70-2	A 70-2		Fe 690		1655		
	C60	1.0601	1.0601	C 60	CC 55	080 A 62	C 60			G10600	
			1.1157	40 Mn 4	35 M 5	150 M 36				G10390	
	G 28 Mn6	1.1165	1.1165	30 Mn 5		120 M 36		SMn 1 H, SCMn 2		G13300	
	C 35E	1.1181	1.1181	Ck 35	XC 38 H1	080 M 36	C 35	S 35 C	1572	G10340	
	C 45E	1.1191	1.1191	Ck 45	XC 42	080 M 46	C 45	S 45 C	1672	G10420	
	C 60E	1.1221	1.1221	Ck 60	XC 60	080 A 62	C 60	S 58 C	1665, 1678	G10640	
			1.1740	C 60 W	Y3 55			SK 7			
	P5	55 SiCr7	1.7100	1.0904	55 Si 7	55 S 7	250 A 53	55 Si 8		2085, 2090	
			1.2330	35 CrMo 4	34 CD 4	708 A 37	35 CrMo 4			T51620	
			1.2542	45 WCrV 7		BS 1	45 WCrV 8 KU		2710	T41901	
		1.2714	1.2714	56 NiCrMoV 7		BH 224-5	56 NiCrMoV7-KU	SKT 4		T61206	
			1.5121	46 MnSi 4							
			1.5710	36 NiCr 6	35 NC 6	640 A 35			SNC 236		
			1.5736	36 NiCr 10	35 NC 11		35 NiCr 9	SNC 631 (H)			
36 CrNiMo 4			1.6511	36 CrNiMo 4	40 NCD 3	816 M 40	38 NiCrMo 4 (KB)			G98400	
34 CrNiMo 6		1.6582	1.6582	34 CrNiMo 6	35 NCD 6	817 M 40	35 NiCrMo 6 (KW)	SNCM 447	2541	G43400	
34 Cr 4		1.7033	1.7033	34 Cr 4	32 C 4	530 A 32	34 Cr 4 (KB)	SCR 430 (H)		G51320	
41 Cr 4		1.7035	1.7035	41 Cr 4	42 C 4	530 M 40	41 Cr 4	SCR 440 (H)		G51400	
25 CrMo 4		1.7218	1.7218	25 CrMo 4	25 CD 4 S	708 M 25	25 CrMo 4 (KB)	SCM 425	2225	G41300	
42 CrMo 4		1.7225	1.7225	42 CrMo 4	42 CD 4	708 M 40	42 CrMo 4	SCM 440 (H)	2244	G41400	
42 CrMo 4		1.7225	1.7225	42 CrMo 4	42 CD 4	708 M 40	42 CrMo 4	SCM 440 (H)	2244	G41400	
			1.7361	32 CrMo 12	30 CD 12	722 M 24	32 CrMo 12		2240		
50 CrV 4	1.8159	1.8159	50 CrV 4	50 CV 4	735 A 50	51 CrV 4	SUP 10	2230		H61500	
41 CrAlMo 7 10	1.8509	1.8509	41 CrAlMo 7	40 CAD 6.12	905 M 39	41 CrAlMo 7	SACM 645	2940		K24065	
C 67S	1.1231	1.1231	Ck 67	XC 68	060 A 67	C 70		1770		G10700	
C 100S	1.1274	1.1274	Ck 101		060 A 96		SUP 4	1870		G10950	
C 105U	1.1545	1.1545	C 105 W1	Y1 105		C 100 KU		1880			
		1.1645	C 105 W2	Y1 105		C 100 KU	SK 3				
		1.1663	C 125 W	Y2 120		C 120 KU	SK 2				

SMG

U.N.E./ I.H.A.	AISI / ASTM	GOST	ČSN	Misc. Brands	Condition	Structure
	1213				Annealed	
	12 L 13				Annealed	
	1108				Annealed	
	11 L 08				Annealed	
					Annealed	
	1140	40			Annealed	
	1146				Annealed	
	1215				Annealed	
	12 L 14				Annealed	
		16D			Annealed	
	A573 Grade 58	18kp	11 378		Annealed	
	A573 Grade 70	St14kP	11 448		Annealed	
	1010	10			Annealed	
F.1110	1015	15			Annealed	
	1020, 1023	20	12 024		Annealed	
		17G1S	11 523		Annealed	
F.1511	1015	15			Annealed	
F.1120	1025	25			Annealed	
					Annealed	
	A204 Grade A		15 020		Annealed	
	4520				Annealed	
	3310, 9314	20X2H4A	16 420		Annealed	
	4320		16 220		Annealed	
					Annealed	
F.1516	5115	12KHN2	14 220		Annealed	
		18HG			Annealed	
	5120	20KH	14 221		Annealed	
	5120 H	20KH			Annealed	
	A182-F11, A182-F12	12KHM	15 121		Annealed	
	A387 Grade 12 Cl. 2				Annealed	
F.155	A182-F22	12KH8	15 313		Annealed	
F.1130	1035	35	12 040		Annealed	
F.5110	1045	45	12 050		Annealed	
	1040	40	12 041		Annealed	
F.1150	1055	55			Annealed	
	1060	60	12 061		Annealed	
	1039	40G			Annealed	
	1330	30G2			Annealed	
F.1135	1035	35			Annealed	
F.1140	1045	45	12 050		Annealed	
F.1150	1064	60			Annealed	
	1060	60			Annealed	
F.144	9255	55S2			Annealed	
F.1250	4135	35KHM			Annealed	
F.5241	S1	5KHV2S			Annealed	
	L6	5KHNV			Annealed	
	5045				Annealed	
	3135				Quenched & Tempered	
	3435				Annealed	
	9840				Quenched & Tempered	
F.1280	4340	38H2N2MA	16 343		Annealed	
	5132	35KH			Quenched & Tempered	
	5140	40H	14 140		Quenched & Tempered	
F.1251	4130	20KHM	15 130		Quenched & Tempered	
F.1252	4142, 4140	38HM	15 142		Annealed	
F.1252	4142, 4140	38HM	15 142		Quenched & Tempered	
					Quenched & Tempered	
F.143	6150	50KHFA	15 260		Quenched & Tempered	
F.1740	A355 Cl. A				Annealed	
F.5103	1070	70			Annealed	
F.5117	1095				Annealed	
F.5118	W1	U10A			Annealed	
		U10			Annealed	
	W1	U13			Annealed	

SMG

SMG	EN	EN-Nr	W.-Nr	DIN	AFNOR	BS	UNI	JIS	SS	UNS	
P7	107 CrV 3	1.2210	1.2210	115 CrV 3	100 C 3		107 CrV 3 KU			T61202	
			1.2510	100 MnCrW 4	90 MWCV 5	BO 1	95 MnWCr 5 KU	SKS 3	2140	T31501	
	90 MnCrV 8	1.2842	1.2842	90 MnCrV 8	90 MV 8	BO 2	90 MnVCr 8 KU			T31502	
	100 Cr 6	1.3505	1.3505	100 Cr 6	100 C 6	534 A 99	100 Cr 6	SUJ 2	2258	G51986	
P8	X 210 Cr 12	1.2080	1.2080	X 210 Cr 12	Z 200 C 12	BD 3	X 210 Cr 13 KU	SKD 1		T30403	
			1.2343	X 38 CrMoV 5 1	Z 38 CDV 5	BH 11	X 37 CrMoV 5 1 KU	SKD 6		T20811	
	X 40 CrMoV 5 1	1.2344	1.2344	X 40 CrMoV 5 1	Z 40 CDV 5	BH 13	X 40 CrMo 5 1 1 KU	SKD 61	2242	T20813	
	X 100 CrMoV 5	1.2363	1.2363	X 100 CrMoV 5 1	Z 100 CDV 5	BA 2	X 100 CrMoV 5 1 KU	SKD 12	2260	T30102	
			1.2365	X 32 CrMoV 3 3	32 DCV 28	BH 10	30 CrMoV 12 27 KU	SKD 7		T20810	
			1.2436	X 210 CrW 12			X 215 CrW 12 1 KU	SKD 2		2312	
			1.2601	X 165 CrMoV 12			X 165 CrMoW 12 KU			2310	
			1.2713	55 NiCrMoV 6	55 NCDV 7			SKT 4			T61206
	HS 6-5-2-5	1.3243	1.3243	S 6-5-2-5	Z 85 WDKCV 06-05-05-04-02		HS 6-5-2-5	SKH 55		2723	
	HS 2-10-1-8	1.3247	1.3247	S 2-10-1-8	Z 110 DKCWW 09-08-04	BM 42	HS 2-9-1-8	SKH 51			T11342
	HS 18-1-2-5	1.3255	1.3255	S 18-1-2-5	Z 80 WKCW 18-05-04-01	BT 4	HS 18-1-1-5	SKH 3			T12004
HS 6-5-2	1.3343	1.3343	S 6-5-2	Z 85 WDCV 06-05-04-02	BM 2	HS 6-5-2	SKH 9, SKH 51		2722	T11302	
HS 2-9-2	1.3348	1.3348	S 2-9-2	Z 100 DCWW 09-04-02-02		HS 2-9-2	SKH 58		2782	T11307	
HS 18-0-1	1.3355	1.3355	S 18-0-1	Z 80 WCV 18-04-01	BT 1	HS 18-0-1	SKH 2			T12001	
P11	X 6 Cr 13	1.4000	1.4000	X 6 Cr 13	Z 6 C 12	403 S 17	X 6 Cr 13	SUS 403	2301	S41008	
	X 12 Cr 13	1.4006	1.4006	X 10 Cr 13	Z 10 C 13	410 S 21	X 12 Cr 13	SUS 410	2302	S41000	
	X 6 Cr 17	1.4016	1.4016	X 6 Cr 17	Z 8 C 17	430 S 15	X 8 Cr 17	SUS 430	2320	S43000	
	X 20 Cr 13	1.4021	1.4021	X 20 Cr 13	Z 20 C 13	420 S 37	X 20 Cr 13	SUS 420 J 1	2303	S42000	
	X 39 Cr 13	1.4031	1.4031	X 40 Cr 13	Z 40 C 14	420 S 45	X 40 Cr 14	SUS 420	2304	S40280	
	X 70 CrMo 15	1.4109	1.4109	X 65 CrMo 14	Z 70 D 14			SUS 440 A			S44002
	X 90 CrMoV 18	1.4112	1.4112	X 90 CrMoV 18	Z 2 CND 18 05	409 S 19	X CrTi 12	SUS 440 B	2327	S44003	
	X 105 CrMo 17	1.4125	1.4125	X 105 CrMo 17	Z 100 CD 17		X 105 CrMo 17	SUS 440 C			S44004
	X 3 CrNiMo 13 3	1.4313	1.4313	X 5 CrNi 13 4	Z 5 CN 13 4	425 C 11	X 6 CrNi 13 04	SCS 5		2385	S41500
	X 18 CrNi 28	1.4749	1.4749	X 18 CrNi 28	Z 18 C 25					2322	S44600
P12	X 6 NiCrTiMoV 25 15	1.4534	1.4534	X 3 CrNiMoAl 13 8 2						S13800	
	X 4 CrNiCuNb 16 4	1.4540	1.4540	X 4 CrNiCuNb 16 4						S15500	
		1.4540	1.4540	X 4 CrNiCuNb 16 4	Z 4 CNU Nb 16.4 M						S15500
	X 4 CrNiCuNb 16 4	1.4540	1.4540	X 4 CrNiCuNb 16 4							S15500
	X 5 CrNiCuNb 16 4	1.4542	1.4542	X 5 CrNiCuNb 16 4				SUS 630			S17400
	X 5 CrNiCuNb 17 4	1.4548	1.4548	X 5 CrNiCuNb 17 4	Z 6 CNU 17.4			SCS 24, SUS 630			S17400
	X 7 CrNiAl 17 7	1.4564	1.4564	X 7 CrNiAl 17 7	Z 9 CAN 17.7	301 S 81	X 7 CrNiAl 17 7	SUS 631	2388		S17700
	X 2 NiCoMoTi 18 12 4	1.6356	1.6356	X 2 NiCoMoTi 18 12 4							K93160
	X 2 NiCoMoTi 18 9 5	1.6358	1.6358	X 2 NiCoMoTi 18 9 5	Z 2 NKD 19-09						K93120
	X 2 NiCoMo 18 9 5	1.6358	1.6358	X 2 NiCoMoTi 18 9 5	Z 2 NKD 19-09						K93120
	X 2 NiCoMo 18 8 5	1.6359	1.6359	X 2 NiCoMo 18 8 5		S 162					K92890
	X 2 NiCoMo 18 8 5	1.6359	1.6359	X 2 NiCoMo 18 8 5		S 162					K92890
M1	X 10 CrNiS 18 9	1.4305	1.4305	X 10 CrNiS 18 9	Z 10 CNF 18.09	303 S 31	X 10 CrNi 18 09	SUS 303	2346	S30300	
	X 2 CrNi 19 11	1.4306	1.4306	X 2 CrNi 19 11	Z 2 CN 18.10	304 S 12	X 3 Cr Ni 18 11	SUS 304 L	2352	S30403	
M2	X 5 CrNi 18 10	1.4301	1.4301	X 5 CrNi 18 10	Z 6 CN 18.09	304 S 31	X 5 CrNi 18 11	SUS 304	2333	S30400	
	X 5 CrNiMo 17 12 2	1.4401	1.4401	X 5 CrNiMo 17 12 2	Z 3 CND 17.11.1	316 S 31	X 5 CrNiMo 17 12	SUS 316	2347	S31600	
	X 6 CrNiNb 18 10	1.4550	1.4550	X 6 CrNiNb 18 10	Z 6 CNNb 18.10	347 S 31	X 6 CrNiNb 18 11	SUS 347		2338	S34700
	X 9 CrNi 18 8	1.4310	1.4310	X 12 CrNi 17 7	Z 12 CN 17.07	301 S 21	X 12 CrNi 17 07	SUS 301		(2331)	S30100
	X 12 CrNi 18 8	1.4300	1.4300	X 12 CrNi 18 8	Z 12 CN 18	302 S 25		SUS 302			S30200
	X 2 CrNiMo 18 14 3	1.4435	1.4435	X 2 CrNiMo 18 14 3	Z 2 CND 17.13	316 S 12	X 2 CrNiMo 17 13 2	SCS 16, SUS 316 L	2353		S31603
M3	X 2 CrNiMoN 17 13 3	1.4429	1.4429	X 2 CrNiMoN 17 13 3	Z 2 CND 17.13 Az	316 S 62	X 2 CrNiMoN 17 13 3	SUS 316 LN		2375	S31653
	X 2 CrNiN 18 10	1.4311	1.4311	X 2 CrNiN 19 11	Z 2 CN 18 .10 Az	304 S 62	X 2 CrNiN 18 11	SUS 304 LN		2371	S30453
	X 3 CrNiMo 18 12 3	1.4466	1.4466	X 5 CrNi 18 15		317 S 16	X 5 CrNi 18 15	SUS 317		2366	S31700
	X 9 CrNiSiN 21 11 2	1.4835	1.4893	X 9 CrNiSiN 21 11 2		310 S 31				2368	S30815
	X 12 CrNi 25 21	1.4335	1.4335	X 12 CrNi 25 21	Z 12 CN 25.20	310 S 24	X 6 CrNi 26 20	SUH 310, SUS 310 S		2361	S31008
M4	X 2 CrNiMoN 22 5 3	1.4462	1.4462	X 2 CrNiMoN 22 5	Z 2 CND 22.05 Az	332 S 15	X 2 CrNiMoN 22 5			2377	S31803
	X 2 CrNiMoSi 19 5	1.4424	1.4417	X 2 CrNiMoSi 19 5	Z 2 CND 18.05.03					2376	S31500
	X 2 NiCrMoCu 25 20 5	1.4539	1.4539	X 2 NiCrMoCu 25 20 5	Z 2 NCDU 25 20	904 S 13				2562	N08904
	X 3 CrNiMo 27 5 2	1.4460	1.4460	X 4 CrNiMo 27 5 2	Z 3 CND 25.7 Az		X 3 CrNiMo 27 5 2	SUS 329 J 1		2324	S32900
	X 5 CrNiCuNb 16 4	1.4980	1.4943	X 4 NiCrTi 25 15	Z 6 NCTDV 25.15	HR 51		SUH 660		2570	S66286
M5	X 1 CrNiMoN 20 18 7	1.4547	1.4529	X 1 CrNiMoN 20 18 7	Z 1 CNDU 20.18.05 Az		X 1 CrNiMoN 20 18 7			2778	S31254
	X 1 CrNiMoN 25 22 8	1.4652	1.4652	X 2 CrNiMoN 25 22 7							S32654
	X 10 NiCrAlTi 32 20	1.4876	1.4876	X 10 NiCrAlTi 32 20	Z 10 NC 32.21			NCF 800			N08800
	X 2 CrNiMoN 25 7 4	1.4410	1.4410	X 2 CrNiMoN 25 7 4	Z 3 CND 25.07 Az		X 2 CrNiMoN 25 7 4			2328	S32750

SMG

U.N.E./I.H.A.	AIISI / ASTM	GOST	ČSN	Misc. Brands	Condition	Structure
F.520L	L2	11KHF			Annealed	
F.5220	O1	9KHVG			Annealed	
	O2	9G2F			Annealed	
F.5230	52100	SHKH15	14 109		Annealed	
F.5212	D3	KH12			Annealed	
	H11	4KH5MFS			Annealed	
F.5318	H13	4KH5MF1S			Annealed	
F.5227	A2	9KH5VF			Annealed	
	H10	3KH3M3F			Annealed	
F.5213		KH12			Annealed	
		KH12MF			Annealed	
F.520.S	L6	5KHNM			Annealed	
F.5613	M35	R6M5K5			Annealed	
	M42	R2AM9K5			Annealed	
	T4	R18K5F2			Annealed	
F.5603	M2	R6M5			Annealed	
	M7				Annealed	
	T1	R18			Annealed	
	403	08KH13			Annealed	Ferritic
F.3401	410, CA-15	12KH13, 08KH13			Annealed	Martensitic
F.3113	430	12KH17			Annealed	Ferritic
F.5261	420	20KH13	17 022		Annealed	Martensitic
F.3404	420	40KH13			Annealed	Martensitic
	440 A				Annealed	Martensitic
	440 B	95KH18			Annealed	Martensitic
	440 C	95KH18			Annealed	Martensitic
	A182 F6NM			F6NM	Annealed	Martensitic
	446	15KH28			Annealed	Ferritic
	XM-13			PH 13-8 Mo	Solution annealed	Austenitic
	XM-12			15-5 PH	H1150	Martensitic
	XM-12			15-5 PH	Solution annealed	Martensitic
	XM-12			15-5 PH	H1025	Martensitic
	SAE 630			17-4 PH	H1150	Martensitic
	630			17-4 PH	Solution annealed	Martensitic
	631	09KH17N7YU1		17-7 PH	Solution annealed	Austenitic/Ferritic
	AMS 6515			Marage 350	Solution annealed	Martensitic
	AMS 6521			Marage 300	Solution annealed	Martensitic
	AMS 6514			Marage 300, Vascomax C300	Solution annealed	Martensitic
	AMS 6512			Marage 250	Solution annealed	Martensitic
	AMS 6512			Marage 250, Vascomax C250	Solution annealed	Martensitic
F.3508	303	12KH19N9			Annealed	Austenitic
F.3504	304 L	03KH18N11			Annealed	Austenitic
F.3504	304	08KH18N10	17 240		Annealed	Austenitic
F.3534	316	08KH17H13M2T	17 346		Annealed	Austenitic
F.3524	347	08KH18N12B			Annealed	Austenitic
F.3517	301	07KH16N6			Annealed	Austenitic
	302	12KH18N9			Annealed	Austenitic
F.3533	(316 L)	03KH17N14M3	17 349		Annealed	Austenitic
	316 LN	03KH16N15M3			Annealed	Austenitic
F.3541	304 LN	03KH18N11			Annealed	Austenitic
	317	08KH17H15M3T			Annealed	Austenitic
				253 MA	Annealed	Austenitic
	310 S	12KH25N20			Annealed	Austenitic
	329 LN			SAF 2205	Annealed	Duplex
				3RE60	Annealed	Duplex
	904L				Annealed	Super austenitic
	329				Annealed	Duplex
	660			A286	Solution annealed	Austenitic
				254 SMO	Annealed	Super austenitic
				654 SMO	Annealed	Super austenitic
				Alloy 800	Annealed	Austenitic
	F 53			SAF 2507	Annealed	Super duplex

SMG

SMG	EN	EN-Nr	W.-Nr	DIN	AFNOR	BS	UNI	JIS	SS	UNS	
K1	EN-GJL-150	0.6150	0.6150	GG-15	Fl 15 D	Grade 150	G15	FC 150	01 15-00	F11601	
	EN-GJL-200	0.6200	0.6200	GG-20	Fl 20 D	Grade 220	G20	FC 200	01 20-00	F12101	
	EN-GJL-250	0.6250	0.6250	GG-25	Fl 25 D	Grade 260	G25	FC 250	01 25-00	F12401	
	EN-GJL-350	0.6350	0.6350	GG-35	Fl 35 D	Grade 350	G35	FC 350	01 35-00	F13502	
	EN-GJL-215			GG-220 HB					02 19		
K2	EN-GJV-300			GJV-300							
	EN-GJV-350			GJV-350							
	EN-GJV-400			GJV-400							
	EN-GJV-450			GJV-450							
	EN-GJV-500			GJV-500							
K3	EN-GJMB-550-4	0.8155		GTS-55-04	P 540/5	P 540/5	P 55-04	PCMP55-04	08 54-00	F24130	
K4	EN-GJS-350-22	0.7033	0.7033	GGG-35.3	FGS 370-17	Grade 350/22		FCD 350-22L	07 17-15		
	EN-GJS-400-15	0.7040	0.7040	GGG-40	FGS 400-12	Grade 420/12	GS 400-12	FCD 400-18L	07 17-02	F32800	
	EN-GJS-400-18	0.7043	0.7043	GGG-40.3	FGS 370-17	Grade 370/17	GSO 42/17		07 17-12	F32800	
	EN-GJS-500-7	0.7050	0.7050	GGG-50	FGS 500-7	Grade 500/7	GS 500-7	FCD 500-7	07 27-02	F33800	
	EN-GJS-600-3	0.7060	0.7060	GGG-60	FGS 600-3	Grade 600/3	GS 600-3	FCD 600-3	07 32-03	F34100	
	EN-GJS-700-2	0.7070	0.7070	GGG-70	FGS 700-2	Grade 700/2	GS 700-2	FCD 700-2	07 37-01	F34800	
K5	EN-GJS-1000-5			GJS-1000-5						ADI grade 5	
	EN-GJS-1200-2			GJS-1200-2						ADI grade 2	
	EN-GJS-1400-1			GJS-1400-1						ADI grade 3	
	EN-GJS-800-8			GJS-800-8						ADI grade 4	
K6	EN-GJLA-XNiCr 20-2	0.6660	0.6660	GGL-NiCr 20 2	FGL Ni20 Cr2	Grade F2			05 23-00	F41002	
	EN-GJLA-XNiCr 30-3	0.6676	0.6676	GGL-NiCr 30 3	FGL Ni30 Cr3	Grade F3				F41004	
	EN-GJLA-XNiCuCr 15-6-2	0.6655	0.6655	GGL-NiCuCr 15 6 2	FGL Ni15 Cu6 Cr2	Grade F1				F41000	
K7	EN-GJSA-XNiMn 13-7	0.7652	0.7652	GGG-NiMn 13 7	FGS Ni13 Mn7	Grade S6			07 72-00		
	EN-GJSA-XNiCr 20-2	0.7660	0.7660	GGG-NiCr 20 2	FGS Ni20 Cr2	Grade S2				F43000	
	EN-GJSA-XNiMn 23-4	0.7673	0.7673	GGG-NiMn 23 4	FGS Ni23 Mn4	Grade S2M				F43010	
	EN-GJSA-XNiCr 30-3	0.7676	0.7676	GGG-NiCr 30 3	FGS Ni30 Cr3	Grade S3				F43003	
	EN-GJSA-XNi 35	0.7683	0.7683	GGG-Ni 35	FGS Ni35					F43006	
N1	AW-1050A	Al99.5	3.0255	Al99.5	A-5/1050A	1B		(A1050)	4007	AA1050A	
	AW-2011	AlCuBiPb	3.1655	AlCuBiPb	A-U5PbBi/2011	FC1		A2011	4355	AA2011	
	AW-2014	AlCuSiMn	3.1255	AlCuSiMn	A-U4SG/2014	H15			4338	AA2014	
	AW-5005	AlMg1	3.3315	AlMg1	A-G0.6	N41			4106	AA5005	
	AW-6060	AlMgSi0.5	3.3206	AlMgSi0.5	A-GS/6060	(H9)			4103	AA6060	
	AW-6063	AlMgSi0.7	3.3210	AlMgSi0.7	A-GSUC/6061	(H10)		(A6063)	4104, 4107	AA6005	
	AW-3103	AlMn1	3.0515	AlMn1		N3			4054	AA3103	
	AW-3003	AlMn1Cu	3.0517	AlMn1Cu	A-M1/3003			A3003		AA3003	
	AW-7020	AlZn4.5Mg1	3.4335	AlZn4.5Mg1	A-Z5G/7020	H17			4425	AA7020	
	AW-7075		3.4365	AlZnMgCu1.5	A-Z5GU/7075	2L95/2L96			A7075	AA7075	
	AC-42000		3.2341	G-AlSi5Mg	A-S7G	LM25	3599		AC 4C	4244	
	AC-46200	AlSi8Cu3(Si)	3.2161	G-AlSi8Cu3						4251	A13800
	MG-P-63	MgAl6Zn	3.5612	G-MgAl6Zn	G-A6-Z1	MAG-E-121					M11600
	MG-P-61	MgAl8Zn	3.5812	G-MgAl8Zn	(G-A7-Z1)						
	MN65120	MgSe3Zn2Zr1	3.5103	G-MgSe3Zn2Zr1	ZRE1	MAG6-TE					M12330
	N2	AC-43400	AlSi10Mg(Fe)	3.2381	G-AlSi10Mg	A-S10G	LM9			4253	A13600
		AC-44200	AlSi12	3.2382	GD-AlSi12						
AW-6082		AlMgSi1	3.2315	AlMgSi1	A-SGM0.7/6082	H30			4212	AA6082	
N3			AlSi17Cu5					ADC14			
N11	CC331G		2.0940.01	CuAl10Fe	CuAl10Fe	AB1			5710	C95200	
	CC333G		2.0975.01	CuAl10Ni	CuAl10Ni5Fe5	AB2			5716	C95500	
		CuNi10Fe1Mn	2.0872	CuNi10Fe1Mn	CuNi10Fe1Mn	CN102			5667	C70600	
				CuNi10Zn45							
		CW408J	2.0790	CuNi18Zn19Pb	CuNi18Zn19Pb1						C76300
	CW352H		2.1176	CuPb10Sn	CuSn10Pb10	LB2			5640	C93700	
	CC480K		2.1050.01	CuSn10	CuSn10	CT1			5443	C90700	
			2.1087	CuSn10Zn					5458	C90500	
	CW452K	CuSn6	2.1020	CuSn6	CuSn6	PB103		C5191	5428	C51900	
	CW502L	CuZn15	2.0240	CuZn15	CuZn15	CZ102		C2300	5112	C23000	
	CW706R	CuZn28Sn1	2.0470	CuZn28Sn1	CuZn29Sn1				5220	C44300	
	CW508L	CuZn37	2.0321	CuZn37	CuZn37	CZ108			5150	C27200	
	CW717R	CuZn38Sn1	2.0530	CuZn38Sn1						C46400	
	CW614N	CuZn39Pb3	2.0401	CuZn39Pb3	CuZn39Pb3	CZ121			5170	C38500	
	CW612N	CuZn40Pb2	2.0402	CuZn40Pb2	CuZn39Pb2	CZ120			5168	C37800	
	CW622N	CuZn44Pb2	2.0410	CuZn44Pb2		CZ104			5272	C68700	

SMG

SMG	EN	EN-Nr	W.-Nr	DIN	AFNOR	BS	UNI	JIS	SS	UNS
S1										
S2										
S3	NiMo30		2.4810							N10002
	NiMo16Cr15W		2.4819							N10276
	NiCr19Fe19Nb5Mo3		2.4668							N07718
			2.4669							N07750
	NiCr20TiAl		2.4631							N07080
	NiCr19Co18Mo4Ti3Al3									N07500
	NiCr20Co13Mo4Ti3Al		2.4654							N07001
S11			3.7024							R54620
S12										R56320
	TiAl6V4		3.7164							R56400
S13				TiV10Fe2Al3						
H3	16 MnCr 5	1.7131	1.7131	16 MnCr 5	16 MC 5	527 M 17	16 MnCr 5	SCR 415	2511	G51170
H5	C 67S	1.1231	1.1231	Ck 67	XC 68	060 A 67	C 70		1770	G10700
	C 75S	1.1248	1.1248	Ck 75	XC 75	060 A 78	C 75		1774, 1778	G10780
	C 100S	1.1274	1.1274	Ck 101		060 A 96		SUP 4	1870	G10950
	C 105U	1.1545	1.1545	C 105 W1	Y1 105		C 100 KU		1880	
			1.2550	60 WCrV 7	55 WC 20		55 WCrV 8 KU			
	55 Cr 3	1.7176	1.7176	55 Cr 3	55 C 3	527 A 60	55 Cr 3	SUP 9 (A)	2253	G51550
	42 CrMo 4	1.7225	1.7225	42 CrMo 4	42 CD 4	708 M 40	42 CrMo 4	SCM 440 (H)	2244	G41400
	107 CrV 3	1.2210	1.2210	115 CrV 3	100 C 3		107 CrV 3 KU			T61202
H7			1.2510	100 MnCrW 4	90 MWCV 5	BO 1	95 MnWCr 5 KU	SKS 3	2140	T31501
		1.2842	1.2842	90 MnCrV 8	90 MV 8	BO 2	90 MnVCr 8 KU			T31502
		1.3505	1.3505	100 Cr 6	100 C 6	534 A 99	100 Cr 6	SUJ 2	2258	G51986
H8	X 40 CrMoV 5 1	1.2344	1.2344	X 40 CrMoV 5 1	Z 40 CDV 5	BH 13	X 40 CrMo 5 1 1 KU	SKD 61	2242	T20813
	X 100 CrMoV 5	1.2363	1.2363	X 100 CrMoV 5 1	Z 100 CDV 5	BA 2	X 100 CrMoV 5 1 KU	SKD 12	2260	T30102
	X 155 CrVMo 12 1		1.2379	X 155 CrVMo 12 1	Z 160 CDV 12	BD 2	X 155 CrVMo 12 1 KU	SKD 11		T30402
			1.2436	X 210 CrW 12			X 215 CrW 12 1 KU	SKD 2	2312	
			1.2601	X 165 CrMoV 12			X 165 CrMoV 12 KU		2310	
			1.2713	55 NiCrMoV 6	55 NCDV 7			SKT 4		T61206
	HS 6-5-2-5	1.3243	1.3243	S 6-5-2-5	Z 85 WDKCV 06-05-05-04-02		HS 6-5-2-5	SKH 55	2723	
	HS 2-10-1-8	1.3247	1.3247	S 2-10-1-8	Z 110 DKCWV 09-08-	BM 42	HS 2-9-1-8	SKH 51		T11342
	HS 18-0-1	1.3355	1.3355	S 18-0-1	Z 80 WCV 18-04-01	BT 1	HS 18-0-1	SKH 2		T12001
H11	X 20 Cr 13	1.4021	1.4021	X 20 Cr 13	Z 20 C 13	420 S 37	X 20 Cr 13	SUS 420 J 1	2303	S42000
	X 70 CrMo 15	1.4109	1.4109	X 65 CrMo 14	Z 70 D 14			SUS 440 A		S44002
	X 90 CrMoV 18	1.4112	1.4112	X 90 CrMoV 18	Z 2 CND 18 05	409 S 19	X CrTi 12	SUS 440 B	2327	S44003
	X 105 CrMo 17	1.4125	1.4125	X 105 CrMo 17	Z 100 CD 17		X 105 CrMo 17	SUS 440 C		S44004
H12	X 4 CrNiCuNb 16 4	1.4540	1.4540	X 4 CrNiCuNb 16 4						S15500
	X 5 CrNiCuNb 16 4	1.4542	1.4542	X 5 CrNiCuNb 16 4				SUS 630		S17400
	X 5 CrNiCuNb 16 4	1.4542	1.4542	X 5 CrNiCuNb 16 4				SUS 630		S17400
	X 7 CrNiAl 17 7	1.4568	1.4568	X 7 CrNiAl 17 7	Z 9 CAN 17.7	301 S 81	X 7 CrNiAl 17 7	SUS 631	2388	S17700
	X 8 CrNiMoAl 15 7 5	1.4574	1.4574	X 8 CrNiMoAl 15 7 5						S15700
	X 6 NiCrTiMoV 25 15	1.4980	1.4943	X 4 NiCrTi 25 15	Z 6 NCTDV 25.15	HR 51		SUH 660	2570	S66286
	X 2 NiCoMo 18 8 5	1.6359	1.6359	X 2 NiCoMo 18 8 5		S 162				K92890
	X 2 NiCoMoTi 18 9 5	1.6358	1.6358	X 2 NiCoMoTi 18 9 5	Z 2 NKD 19-09					K93120
	X 2 NiCoMoTi 18 9 5	1.6358	1.6358	X 2 NiCoMoTi 18 9 5	Z 2 NKD 19-09					K93120
	1.6356	1.6356	X 2 NiCoMoTi 18 12 4						K93160	
H21	X 120 Mn 12	1.3401	1.3401	X 120 Mn 12	Z 120 M 12	BW 10		SC MnH 1	2183	
H31	EN-GJN-HV520	0.9620	0.9620	G-X330 NiCr 4 2	FB Ni4 Cr2 BC	Grade 2 A			05 12-00	F45001
	EN-GJN-HV550	0.9625	0.9625	G-X260 NiCr 4 2	FB Ni4 Cr2 HC	Grade 2 B			05 13-00	F45000
	EN-GJN-HV600(XCr11)	0.9630	0.9630	G-X300 CrNiSi 9 5 2	FB Cr9 Ni5	Grade 2 C, D, E			04 57-00	F45003

SMG

U.N.E. / I.H.A.	AISI / ASTM	GOST	ČSN	Misc. Brands	Condition	Structure
				Discalloy	Precipitation hardened	
				Haynes 25		
				Stellite 21		
				Hastelloy C		
		KHN65MV		Hastelloy C-276		
				IN 100		
				Inconel 718		
				Inconel X-750	Solution annealed	
				Nimonic 80A		
				René 41		
				Udimet 500		
				Waspalloy		
				Ti	Commercially pure	Ti (α)
	AMS 4919			Ti 6-2-4-2	Annealed	Ti (α)
	AMS 4943			Ti 3Al-2.5V (grd 9)	Annealed	Ti (α+β)
	AMS 4920, Grade 5	VT6		Ti 6Al-4V	Annealed	Ti (α+β)
	AMS 4986			Ti 10V-2Fe-3Al	Annealed	Ti (β)
F.1516	5115	12KH2	14 220		Case hardened	
F.5103	1070	70			Quenched & Tempered	
F.5107	1078, 1080	75			Quenched & Tempered	
F.5117	1095				Quenched & Tempered	
F.5118	W1	U10A			Quenched & Tempered	
	S1	5KHV2SF			Quenched & Tempered	
	5155				Quenched & Tempered	
F.1252	4142, 4140	38HM	15 142		Quenched & Tempered	
F.520L	L2	11KHF			Quenched & Tempered	
F.5220	O1	9KHVG			Quenched & Tempered	
	O2	9G2F			Quenched & Tempered	
F.5230	52100	SHKH15	14 109		Quenched & Tempered	
F.5318	H13	4KH5MF1S			Quenched & Tempered	
F.5227	A2	9KH5VF			Quenched & Tempered	
F.5211	D2	KH12MF			Quenched & Tempered	
F.5213		KH12			Quenched & Tempered	
		KH12MF			Quenched & Tempered	
F.520.S	L6	5KHNM			Quenched & Tempered	
F.5613	M35	R6M5K5			Quenched & Tempered	
	M42	R2AM9K5			Quenched & Tempered	
	T1	R18			Quenched & Tempered	
F.5261	420	20KH13	17 022		Quenched & Tempered	Martensitic
	440 A				Quenched & Tempered	Martensitic
	440 B	95KH18			Quenched & Tempered	Martensitic
	440 C	95KH18			Quenched & Tempered	Martensitic
	XM-12			15-5 PH	H900	Martensitic
	SAE 630			17-4 PH	H1025	Martensitic
	SAE 630			17-4 PH	H900	Martensitic
	AMS 5528	09KH17N7YU1		17-7 PH	TH1050	Martensitic
	632			PH 15-7 Mo	TH1050	Martensitic
	660			A286	Precipitation hardened	Austenitic
	AMS 6512			Marage 250	Precipitation hardened	Martensitic
	AMS 6521			Marage 300	Precipitation hardened	Martensitic
	AMS 6521			Marage 300	Precipitation hardened	Martensitic
	AMS 6515			Marage 350	Precipitation hardened	Martensitic
	A128 Grade A			Hadfield		
	A532 IB (NiCr-LC)			Ni-Hard 2		White cast iron
	A532 IA (NiCr-HC)			Ni-Hard 1		White cast iron
	A532 ID (Ni-HiCr)			Ni-Hard 4		White cast iron

This work is published with the understanding that Seco Tools and its editors are supplying information aimed to present a general orientation and direction of metal cutting and related sciences. If professional services are required for specific applications, the assistance of an appropriate professional should be acquired.

The information is provided “as is”;
Seco Tools and its editors disclaim all representations and warranties, express or implied, of any kind, including, without limitations, any warranties of merchantability, fitness for a particular purpose, title, or non-infringement. In no event will Seco Tools or its editors be liable to any party for any direct, indirect, special or other consequential damages for any use of the information, even if Seco Tools or its editors are advised of the possibility of such damage.

The information provided herein is for reference purposes only. Actual prices, specifications, and product descriptions are finalised at the time of sale and may vary by location.
The information provided herein is subject to change without prior notice.

WWW.SECOTOOLS.COM

70024906, ST20236775 GB,
© SECO TOOLS AB, 2023. All rights reserved.
Technical specifications are subject to
change without notice.