

CATALOG & TECHNICAL GUIDE 2023.1



MILLING

>30,000

STANDARD PRODUCTS



>75

COUNTRIES



>4,100

DEDICATED EMPLOYEES



Headquartered in Fagersta, Sweden and present in more than 75 countries, Seco Tools is a leading global provider of metal cutting solutions for milling, stationary tools, holmaking and tooling systems.

For more than 80 years, the company has provided the technologies, processes and support that manufacturers depend on for maximum productivity and profitability. For more information on how Seco's innovative products and expert services bring success to manufacturers across all industry segments, please visit www.secotools.com.



General information milling cutters

Mounting type and insert clamping system 7-8

General information inserts

Code keys, grades, insert geometries 9-15

Iso attribute information

..... 16

Square shoulder and slot milling cutters

Technical information	17-21
Double turbo	22-29
Turbo	30-75
ABEX	76-80
Square T4	81-97
Square 6	98-115
Mini and Midi square	116-121

Helical milling cutters

Technical information	123-130
Helical Turbo	131-167
Helical SN8-13	168-180
Helical Square T4	181-193
R215/220.59 Helical	194-202
R215/220.69-15XH Helical	203-207
R235.15 Helical	208-212

Face milling cutters

Technical information	213-221
Double Quattromill	222-250
Double Octomill	251-270
Quattromill	271-295
R220.88 SNMU	296-308
Octomill	309-327
R220.60	328-331
R220.30	332-337
R230.19	338-341

Disc milling cutters

Technical information 335.14	342-350
Exchangeable heads 335.14	351-369
Technical information	370-377
335.15	378-382
335.10	383-394
335.19	395-410
335.18	411-435
335.25	436-457
335.29	458-461
Technical data and spare parts 335.18/335.25/335.29	462-468
Cutting data 335.18/335.25/335.29	469-499
335.16	500-508

High feed milling cutters

Technical information	509-517	Square shoulders and slot milling cutters
R217/220.21-SP	518-535	
R217/220.21-LP	536-557	
R217/220.21-LO	558-565	
R217/220.21-218.21	566-572	
R220.21-ON	573-577	
R217/220.21-218.19	578-595	
R220.21-SCET	596-601	Helical milling cutters

Copy milling cutters

Technical information	603-612	Face milling cutters
R217/220.29	613-665	
R218.28	666-671	Disc milling cutters
R218.20/R218.19/R218.24	672-734	
R217/218.97 VP/XP	735-750	

Plunge milling cutters

Technical information	751-755	High feed milling cutters
Square 6 Plunge	756-760	
Turbo Plunge	761-777	
SCET	778-785	

Chamfer milling cutters

Chamfer Turbo 12	786-791	Copy milling cutters
R215/220.49	792-795	

Spot facing cutters

R417.19	796-801	Plunge milling cutters
---------------	---------	------------------------

Advanced material

PCBN	802-816	Chamfer milling cutters
Ceramic	817-821	
PCD	822-826	

Inserts

Milling inserts	827-883	Spot facing cutters
-----------------------	---------	---------------------

Technical data

Cutting data calculation	884-890	Inserts
Trouble shooting	891-893	
Torque information	894-895	

SMG

Workpiece Materials – SMG	896-907
Declaration of conformity	908-910



2

215.49	792
215.59	195-200
217.21	567-568, 579-584
217.21-LO06	559-562
217.21-LP05	537-540
217.21-LP06	544-547
217.21-LP09	551-554
217.21-SP10	519
217.21-SP14	524-525
217.26	819-820
217.28	667-668
217.29-025	614-615
217.29-03	618-620
217.29-035	623
217.29-04	626-627
217.29-05	632
217.29-10	658-661
217.29I-05	631, 633-635
217.29I-06	639-644
217.29I-08	649-650
217.43-05	310-311
217.48-05	252-253
217.48-09	261-262
217.49	787
217.53-09	272-273
217.64-ZO16	23-27
217.69-12-HSK-Helical	145-146
217.69-15	205
217.69-XO06	31-35
217.69-XO06-Helical	132-134
217.69-XO10	38-42
217.69-XO10-Helical	137-139
217.69-XO12	46-51
217.69-XO12-Helical	143-146, 148-149
217.69-XO16	56-61
217.69-XO16-Helical	153-155
217.69-XO18	66-71
217.69-XO18-Helical	160-161
217.79-06	762
217.79-08	757
217.79-10	765-768
217.79-12	779-780
217.79-XO12	772-774
217.81-SNAC15	175
217.82-SNAC15	177
217.82-SNXO16	169-170
217.94-08	82-85
217.94-08-Helical	182-184, 188
217.94-12	90-94
217.94-12-Helical	187
217.94-HSK100A	190
217.96-04	99-102
217.96-08	106-111
217.97-V22	744-747
217.97-X08	736-739
217.97-X12	740-743
218.19	713-715
218.19-HFA	715
218.20	673-680
218.24	732
220.21	567-569, 581-582
220.21-12	583-584
220.21-LO06	561
220.21-LP06	546
220.21-LP09	552-553
220.21-ON09	574-575
220.21-SC12	597-599
220.21-SP10	519-520
220.21-SP14	524-526
220.21-SP18	530-531
220.21-SP18CA	532
220.26	819-820
220.28	668-669
220.29-03	619
220.29-04	627
220.29-10	660-662
220.29B-06	645
220.29I-05	635
220.29I-06	641-644
220.29I-08	651
220.29I-38	655
220.30-12CT	333
220.30-12ST	334-335
220.43-05	310-314
220.43-07	318-321, 325
220.48-05	254-255
220.48-05CS	256-257
220.48-09	261-267
220.49	788
220.49-XO12	787
220.53-09	274-276
220.53-09C	276
220.53-12	280-284
220.53-12C	285-286
220.53-15	290-291
220.53-15C	292
220.54-14	223-226
220.54-14CA	231-232
220.54-22	239-240
220.54-22C	244
220.54-22CA	243
220.54-22CS	243
220.56-14	227-230
220.56-14CA	231-232
220.56-22	241-242
220.56-22C	244
220.56-22CS	243
220.59-12	196-197, 200
220.60-19CM	329
220.64-ZO16	25-27
220.68-T11C	810-811
220.68-T16C	810
220.69-15.X	204
220.69-XO06	34-35
220.69-XO10	40-42
220.69-XO10-Helical	139
220.69-XO12	48-52
220.69-XO12-Helical	145-147
220.69-XO16	58-62
220.69-XO16-Helical	155-156
220.69-XO18	68-72
220.69-XO18-Helical	162-164
220.70	806
220.70-09	807
220.74	808
220.74-09	809
220.79-08	757-758
220.79-12	781-782
220.79-20	783
220.79-40	783
220.79-XO12	774
220.81-SNAC15	176
220.82-SNAC15	178
220.82-SNXO16	171-172
220.88-12	297-300
220.88-16	304-305
220.90	77-78
220.94-08	84-86
220.94-08-Helical	184, 188
220.94-12	92-94
220.94-12-Helical	188-189
220.96-04	101-102
220.96-08	108-112
220.97-V22	746-747

220.97-X12	742-743
220.99-09	117
220.99-12	117
230.19	339
235.15	209-210
3	
335.10	384-388
335.14	360-361
335.14-ER	362
335.15	379-380
335.16	501-502
335.18	412-435
335.19	396-404
335.25	437-457
335.29	459-461
335.29I	459-461
4	
417.19	797-798
C	
Cx-217.53-09	274
Cx-217.53-12	280-281
Cx-217.69-XO10	40
Cx-217.69-XO12	48-49
Cx-217.69-XO12-Helical	148-149
Cx-217.69-XO16-Helical	155-156
Cx-217.69-XO18	68
Cx-217.69-XO18-Helical	162-164
Cx-217.82-SNXO16	171-172
Cx-217.94-08	92
Cx-217.94-08-Helical	184
Cx-217.94-12-Helical	190
Cx-217.96-08	108
L	
L220.48-09	265
R	
R215.39	792
R220.49	792

1		
150.10	877
2		
218.19	878
218.19-CBN	816
218.20	879
218.21	880
3		
335.14	351-356
335.18	881
335.19	882
A		
ABER	828
ABEX	828
ACET	829
ACMT	829
H		
HPMN	830
L		
LNHQ14	832
LNKT05	833
LNKT06	833
LNKT08	834
LNKW06	833
LNKW08	834
LOEX	831-832
LOHT	830
LOHW	830
LPHT	835
LPHW	835
LPKT	835
LPKW	835
O		
OFEN07	836
OFER07	836
OFET07	837
OFEX05	837
OFEX05-PCD	825
OFMR07	836
OFMT05	837
OFMT07	837
ONEU09	838
ONEW05-CBN	812
ONMU05	838
ONMU09	838
R		
R235.15	880
R335.14...MNP	358
R335.14...UNNF	359
R335.14...WXF	357
R335.15	883
RDHT	839
RDHW	839
RDHW-CBN	812
RDKW	839
REHR	840
RNGN	813, 821
RNGN-LF	813
RNMN	813
RNMU	840
ROHT	841
RPGN	821
RPHT	841-842
RPHW	841
RPKT	841-842
RPKW	841-842
S		
SCET	843
SCEX	843
SCMT	843
SEAN	843-844
SEEN-CBN	813
SEEX09	844
SEEX09-CBN	814
SEEX09-PCD	825
SEEX12	845-846
SEEX12-CBN	814
SEEX15	845
SEHN-PCD	826
SEKN	846
SEKR	846
SEM09	844
SEM12	845
SEM15	845
SENN	847
SNEN-CBN	814
SNEX-CBN	815
SNGN-CBN	815
SNGU	847
SNHQ1102	848
SNHQ1103	848-849
SNHQ1203	850
SNHQ1204	850-852
SNHQ1205	853-854
SNHQ1207	855
SNHX	856-857
SNMN-CBN	815
SNMU	856
SNMX	857
SNXU	847
SONX	858
SPEN	859
SPKT10	860
SPKT14	860
SPKT18	860
SPMT	860
SPMX	861
T		
TNGN-CBN	816
V		
VPGX	862
X		
XNEX	863
XNHQ	864-865
XOEX06	866
XOEX06-PCD	826
XOEX10	867
XOEX10-PCD	826
XOEX12	869
XOEX12-PCD	826
XOEX16	871
XOEX16-PCD	826
XOEX18	873
XOMX06	866
XOMX10	867-868
XOMX12	869-870
XOMX16	871-872
XOMX18	873-874
XPKX	875
Z		
ZOMX16	876

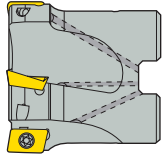
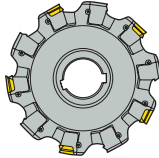
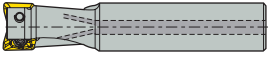
Mounting type

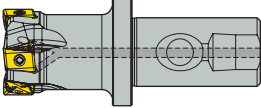
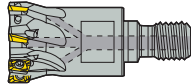
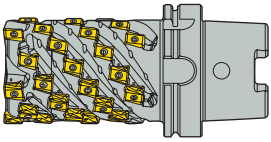
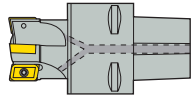
Type – Arbor (Shell end)	Type – Arbor hole
 <p>Ex.: R220.69-0050-12-5AN</p>	 <p>Ex.: 335.25-160.15.40-7N</p>
Type 0 – Cylindrical	Type 3 – Weldon Tool chucks acc. to ISO 5414 DIN 1835
 <p>Ex.: R217.69-1616.0-10-2A</p>	 <p>Ex.: R217.69-2525.3-12-3AN</p>
Type 3S – Seco/Weldon® Tool chucks acc. to ISO 5414 DIN 1835	Type RE – Combimaster
 <p>Ex.: R217.69-2532.3S-12-4AN</p>	 <p>Ex.: R217.69-1225.RE-12-3AN</p>
Type HSK	Type Cx – Seco-Capto™
 <p>Ex.: R217.94-HSK100A-080-104-12.5SA</p>	 <p>Ex.: C5-R217.69-054-10-5A</p>

Insert clamping system

Clamping by umbrella screw-S	Clamping by wedge -W or -M
 <p>The inserts are clamped by an inclined screw which holds the insert in position in its seat.</p>	 <p>The inserts are held in position by a wedge and a screw which clamps the insert onto the seat. (Example shows milling cutter with cassettes).</p>
Clamping by center lock screw -S	Clamping by spring action
 <p>The inserts are secured through a centre hole by means of a screw which clamps the insert firmly against the bottom and side of its seat.</p>	 <p>The inserts are retained by a clamping/spring action into a fixed insert seat</p>
Square T4	
 <p>The inserts are secured through a centre hole by means of a screw which clamps the insert firmly against the bottom and side of its seat.</p>	

Code key inserts

S	E	M	X	12	04	AF	T	N	-	ME12
1	2	3	4	5	6	7	8	9		10

1. Insert shape

A 	B 	C 	D 	E 	H 	K 	L
M 	O 	P 	R 	S 	T 	V 	W

X=Special shapes Z=Special shapes

2. Insert side clearance angle

A 	B 	C 	D 	E 	F
G 	N 	P 	O = Special		

Code key inserts

3. Tolerances

Tolerance class	Tolerances: +/- mm/in				For IC, dimension in mm/in														
					0,125	3,175*	3,969	4,064	4,760	6,350	9,525	12,700	15,875	19,050	20,000	25,400	31,750	38,100	
	S mm	IC mm	S inch	IC inch					0,187	0,250	0,375	0,500	0,625	0,750		1,000	1,250	1,500	
A	0,025	0,025	0,0010	0,0010	•				•	•	•	•	•	•	•	•	•	•	•
C	0,025	0,025	0,0010	0,0010	•	•	•		•	•	•	•	•	•	•	•	•	•	•
E	0,025	0,025	0,0010	0,0010	•				•	•	•	•	•	•	•	•	•	•	•
F	0,025	0,013	0,0010	0,0005	•				•	•	•	•	•	•	•	•	•	•	•
G	0,050*	0,025	0,0020	0,0010	•				•	•									
	0,130	0,025	0,0051	0,0010							•	•	•	•	•	•	•	•	•
H	0,025	0,013	0,0010	0,0005	•				•	•	•	•	•	•	•	•	•	•	•
J	0,025	0,050	0,0010	0,0020	•				•	•	•								
	0,025	0,080	0,0010	0,0031								•							
	0,025	0,100	0,0010	0,0039									•	•	•				
	0,025	0,130	0,0010	0,0051													•		
	0,025	0,150	0,0010	0,0059														•	•
K	0,025	0,050	0,0010	0,0020	•				•	•	•								
	0,025	0,080	0,0010	0,0031								•							
	0,025	0,100	0,0010	0,0039									•	•	•				
	0,025	0,130	0,0010	0,0051													•		
	0,025	0,150	0,0010	0,0059														•	•
M	0,050*	0,050	0,0020	0,0020	•				•	•									
	0,130	0,050	0,0051	0,0020							•								
	0,130	0,080	0,0051	0,0031								•							
	0,130	0,100	0,0051	0,0039									•	•	•				
	0,130	0,130	0,0051	0,0051													•		
	0,130	0,150	0,0051	0,0059														•	•
U	0,050*	0,080	0,0020	0,0031	•				•	•									
	0,130	0,080	0,0051	0,0031							•								
	0,130	0,130	0,0051	0,0051								•							
	0,130	0,180	0,0051	0,0071									•	•	•				
	0,130	0,250	0,0051	0,0098													•	•	•

* Not ISO

4. Fixing and/or chipbreaker

A	B	G	M	N	R
T	U	W	X=Special shapes		Z=Special shapes

5. Cutting edge length

A, B, K	C, D, E, M, V	H, O, P	L	R	S	T	W

Code key inserts



6. Thickness									
			01 = 1,59 mm T1 = 1,98 mm 02 = 2,38 mm 03 = 3,18 mm	01 = 0.0626 Inch T1 = 0.0780 Inch 02 = 0.0937 Inch 03 = 0.1252 Inch	T3 = 3,97 mm 04 = 4,76 mm 05 = 5,56 mm 06 = 6,35 mm	T3 = 0.1563 Inch 04 = 0.1874 Inch 05 = 0.2189 Inch 06 = 0.2500 Inch	07 = 7,94 mm 08 = 8,00 mm 09 = 9,52 mm	07 = 0.3126 Inch 08 = 0.3150 Inch 09 = 0.3748 Inch	







7. Corner configuration						
1st letter	A = 45° D = 60° E = 75° F = 85° P = 90° Z = Special	2nd letter	A = 45° B = 5° C = 7° D = 15° E = 20° F = 25° G = 30° N = 0° P = 11° Z = Special	nose radius	M0 = round inserts 005 = 0,05 mm 01 = 0,1 mm 02 = 0,2 mm 04 = 0,4 mm 08 = 0,8 mm 12 = 1,2 mm etc.	M0 = round inserts 005 = 0.0020 Inch 01 = 0.0039 Inch 02 = 0.0079 Inch 04 = 0.0157 Inch 08 = 0.0315 Inch 12 = 0.0472 Inch etc.





8. Cutting edge condition				
F	E	T	S	

9. Direction of cutting			10. Internal designations	
R	L	N	Machining conditions E=Easy ME=Medium Easy M=Medium MD=Medium Difficult D=Difficult	
		Neutral (R- and L- rotated)		

Insert grades

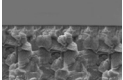
Uncoated Grades		
	H15	Hard, wear resistant grade for milling in aluminium.
	H25	Tough micro-grain carbide grade for milling in superalloys and aluminium.

CVD Coated Grades		
	MP2501	CVD-coated grade based on Duratomic™ coating, First choice in steel for maximizing manufacturing output under most varying productivity. Alternative choice stainless steel applications under stable condition. Ti(C, N)-Al ₂ O ₃
	MK1500	CVD-coated grade based on Duratomic™ coating. Basic grade for milling cast iron and nodular cast iron, with or without coolant. Ti (C, N) – Al ₂ O ₃
	MP1501	CVD-coated grade based on Duratomic™ coating. Grade for high performance and productivity in steel material under stable conditions and for milling hardened steel. Excellent grade for grey and nodular cast iron. Ti (C, N) – Al ₂ O ₃
	MS2500	Optimization grade for superalloy materials, also suitable for rough milling in tool steel. Ti (C, N) – Al ₂ O ₃
	MM4500	Extremely tough grade for duplex stainless steel. Can also be used for a wide range of materials when cutting conditions are unstable. Ti(C, N)-Al ₂ O ₃
	T350M	CVD-coated grade as basic choice for difficult stainless steel and an alternative in difficult operations in steel. Ti (C, N) – Al ₂ O ₃

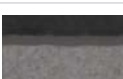
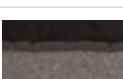
PVD Coated Grades		
	F40M	PVD-coated grade for fine to medium rough milling. First choice for milling with small feeds and/or low cutting speeds. Excellent for milling when there is a risk of vibrations and when coolant is used. Recommended for machining superalloys. (Ti, Al) N – TiN
	MK2050	PVD-coated grade for cast iron, Improved edge integrity. First choice in all cast iron materials. Excellent for milling with and without coolant. (Ti,Si)N(Ti,Al)N
	MH1000	Extremely hard grade for milling hard steel but also favourable in finishing operations in cast iron. (Ti;Al)N
	MS2050	PVD-coated grade first choice for machining titanium alloys. Can also be used as a complementary grade for milling stainless steels when increased toughness is needed. (Ti;Al) N – NbN
	MP3000	Highly wear resistant optimized grade for milling in steel. (Ti;Al)N
	F15M	Hard and wear resistant grade for milling in aluminium and non-ferrous alloys. Excellent grade, in combination with protected cutting edges, for high speed machining in hardened steel. (Ti, Al) N – TiN
	F30M	Basic grade for Minimaster inserts and thread milling inserts. Also suitable for milling stainless steel, hardened steel and superalloys. (Ti, Al) N – TiN

PVD Coated Grades



MP2050

PVD-coated grade for tough machining conditions and high temperatures in martensitic and austenitic stainless steels, dry and wet machining possible. Alternative in super alloys in unstable conditions. (Ti,Si)N/(Ti,Al)N



F32M

Universal grade for R335.14 replaceable head offering an excellent combination of strength and toughness. The F32M shows an exceptionally broad application range and is applicable in all type of material with this type of tool. (Ti, Al) N – TiN

Insert grades

Cemented carbide is an alloy of tungsten carbide (WC) and cobalt (Co). Cubic carbides like tantalum carbide (TaC), titanium carbide (TiC) and niobium carbide (NbC) can also be added. Tungsten carbide is the main component and gives the hardness. Cobalt is the binder phase and gives the toughness. Cubic carbides are added in order to affect properties like hot hardness, deformation resistance and chemical wear resistance.

Most modern grades are coated with either CVD (Chemical Vapour Deposition) or PVD (Physical Vapour Deposition) technique.

The coating improves the wear resistance of the grade.

CVD-coated grades are suitable for wear resistance in demanding applications with high feed rates and intermediate to high cutting speed.

PVD-coated grades are recommended for applications with low feed rate where high edge toughness is required. PVD-coated grades are suitable for applications with low to intermediate cutting speed.

		P					M					K					N				S				H				
		P01	P10	P20	P30	P40	P50	M01	M10	M20	M30	M40	K01	K10	K20	K30	K40	N01	N10	N20	N30	S01	S10	S20	S30	H01	H10	H20	H30
PVD	F40M	●					●					○					○				●								
	F15M	○					○					○					○				○								
	F25M	○					○					○					○				○								
	F30M	○					○					○					○				○								
	F32M	○					○					○					○				○								
	MK2050	○					○					○					○				○								
	MP3000	○					○					○					○				○								
	MP2050	○					○					○					○				○								
	MS2050	○					○					○					○				○								
	MH1000	○					○					○					○				○								
CVD	MK1500	○					○					○					○				○								
	MP1501	●					○					○					○				○								
	MP2501	●					○					○					○				○								
	T25M	○					○					○					○				○								
	T350M	○					○					○					○				○								
	MS2500	○					○					○					○				○								
	MM4500	○					○					○					○				○								
CBN	H15	○					○					○					○				○								
	H25	○					○					○					○				○								
	HX	○					○					○					○				○								
CBN PVD	CBN150	○					○					○					○				○								
	CBN200	○					○					○					○				○								
	CBN300	○					○					○					○				○								
	CBN500	○					○					○					○				○								
	CBN160C	○					○					○					○				○								
PCD	PCD05	○					○					○					○				○								
	PCD20	○					○					○					○				○								
	PCD30	○					○					○					○				○								
	PCD30M	○					○					○					○				○								
	CW100	○					○					○					○				○								

HX, H15 and H25 = uncoated

CBN300P = PVD coating

CS100/CS300/CW100 = ceramic

The black oval circle areas in the chart indicate an inserts main ISO application groups.

The white oval circle area in the chart indicate an inserts other complementary ISO application groups.

For TGP45 use ISO application area for MP2501

For CP500 and CP600 use ISO application area respectively for F30M and F40M

Insert geometries - Designation system

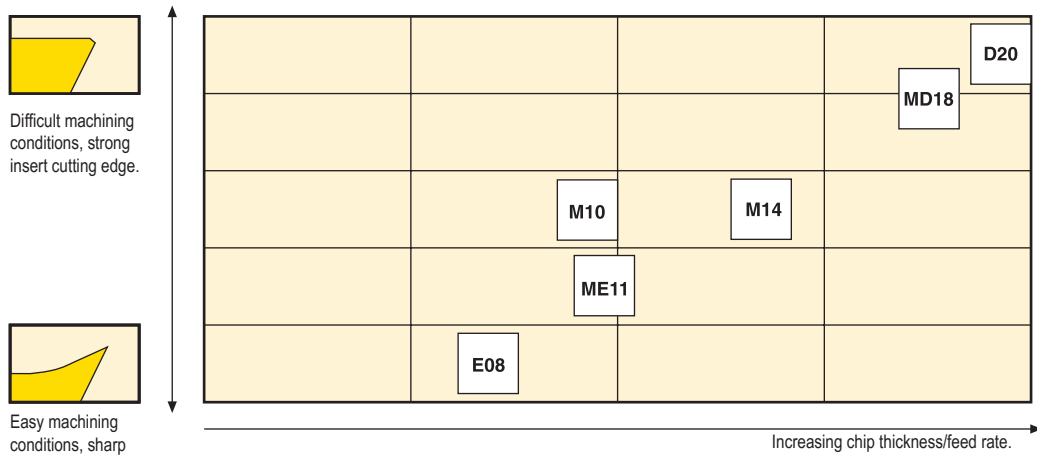

- 
..AFTN-D20 Negative and very protected cutting edge
- 
..AFTN-MD18 Negative and protected cutting edge
- 
..AFTN-M14 Positive and protected cutting edge
- 
..AFTN-ME11 Very positive and protected cutting edge
- 
..AFN-M10 Positive and sharp cutting edge
- 
..AFN-E08 Very positive and very sharp cutting edge

ISO attribute

ISO attribute	Explanation
APMXE	Depth of cut maximum in feed direction end
APMXS	Depth of cut maximum in feed direction side
AZ	Plunge depth maximum
BD	Body diameter
BHTA	Body half taper angle
BS	Wiper edge length
C	Keyway depth
CBTHN	Connection body thickness
CCER	Curved cutting edge radius
CDX	Cutting depth maximum
CF	Spot chamfer
CHW	Corner chamfer width
Cmax	Helical interpolation hole diameter maximum
Cmin	Helical interpolation hole diameter minimum
CPNDIA	Connection pin diameter
CTMS	Connection text machine side
CW	Cutting width
CWN	Cutting width minimum
CWX	Cutting width maximum
DC	Cutting diameter
DCB	Connection bore diameter
DCB1	Connection bore diameter 1
DCSFMS	Contact surface diameter machine side
DCSFWS	Contact surface diameter work piece side
DCX	Cutting diameter maximum
DMM	Shank diameter
FDESU	Feed direction suitability end
FDP	Feed direction primary
FDSSU	Feed direction suitability side
GAMF	Rake angle radial
GAMO	Rake angle orthogonal
GAMP	Rake angle axial
HC	Thread height actual
IC	Inscribed circle diameter
INSD	Insert diameter
INSL	Insert length
KAPRE	Tool cutting edge angle in feed direction end
KAPRS	Tool cutting edge angle in feed direction side
KCH	Corner chamfer angle
KWW	Keyway width
L	Cutting edge length
LB	Body length
LE	Cutting edge effective length
LF	Functional length
LS	Shank length
LUX	Usable length maximum
OAL	Overall length
PDX	Profile distance ex
PNA	Profile included angle
RE	Corner radius
RP	Programming radius
RMPX	Ramping angle maximum
RPMX	Rotational speed maximum
S	Insert thickness
S1	Insert thickness alt 1
UTCN	Uncut thickness
TDZ	Thread diameter size
THUB	Hub thickness
TTL	True tip length
W1	Insert width
ZEFP	Peripheral effective cutting edge count
ZNP	Peripheral mounted insert count
SA	sphere angle
TACH	Cutting half taper angle
DC1	Cutting diameter 1
LPR	Protruding length
FHA	Flute helix angle
PL	Point length
SIG	Point angle
BEC	Back end chamfer angle
DN	Neck diameter
RA	Relief angle

Code keys metric and inch

R	217	69	25	32	3S	12	4	AN
1	2	3	4	5	6	7	8	9

R	217	69	01.25	3S	12	4	AN
1	2	3	5	6	7	8	9

1.	2.	3.
Right hand rotation Cx = For Seco-Capto	217 = With shank 220 = For arbor	Cutter system
4. (Not applicable for inch designation)	5.	6.
Shank diameter	Cutter diameter	Shank type 0 = Cylindrical 3 = Weldon 3S = Seco Weldon RE = Combimaster
7.	8.	9.
Insert size	Effective No. of teeth (ZEFP)	A = With through coolant supply AD = Anti vibration material with through coolant supply T = Close pitch version for contouring operations C = With adjustable cassettes N = Coated

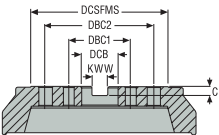

Dimensions in mm					
DCB	DCSFMS	DBC1	DBC2	KWW	C
16	30-35	-	-	8,4	5,6
22	42-47	-	-	10,4	6,3
27	48-62	-	-	12,4	7
32	60-90	-	-	14,4	8
40	90-130	66,7	-	16,4	9
60	130-270	101,6	177,8	25,7	14

Dimensions in inch					
DCB	DCSFMS	DBC1	DBC2	KWW	C
0.500	1.181 - 1.378	-	-	0.258	0.165
0.750	1.378 - 1.850	-	-	0.321	0.193
1.000	1.803 - 2.441	-	-	0.382	0.224
1.250	2.250 - 3.031	-	-	0.508	0.287
1.500	2.750 - 3.543	-	-	0.630	0.382
2.000	4.331	-	-	0.756	0.445
2.500	5.118 - 6.299 (8.858)	4.000	(7.000)	1.000	0.551

For a more exact DCSFMS and DCB measurement, see each product table.

Square shoulder and slot milling cutters
Helical milling cutters
Face milling cutters
Disc milling cutters
High feed milling cutters
Copy milling cutters
Plunge milling cutters
Chamfer milling cutters
Spot facing cutters
Inserts

Selection – Metric

Cutter	Insert	Recommended a_p		Material suitability					Corner radius (mm)					
				P	M	K	N	S						
Double Turbo	ZOMX16	6	15	■	▣	■	□	▣	0,8/1,6	□	■	-	-	▣
	XO..06	3	5	■	■	■	■	■	0,2/0,4/0,8/1,6	■	□	■	■	▣
Turbo	XO..10	5	9	■	■	■	■	■	0,2/0,4/0,8/1,2/1,6/2,0/2,4/3,1	■	▣	■	■	▣
	XO..12	6	11	■	■	■	■	■	0,2/0,4/0,8/1,2/1,6/2,0/2,4/3,1/4,0/5,0/6,3	▣	■	■	■	▣
	XOMX16	8	15	■	■	■	■	■	0,2/0,4/0,8/1,2/1,6/2,0/2,4/3,1/4,0/5,0/6,3	□	■	■	■	▣
	XO..18	9	17	■	▣	■	■	▣	0,4/0,8/1,2/1,6/2,0/2,4/3,1/4,0/5,0/6,3	□	■	■	■	▣
ABEX26	ABEX26	13	20	■	▣	■	-	-	1,6	□	■	■	□	□
Square T4	LO..08	3	7	■	▣	■	□	□	0,4/0,8/1,2/1,6	■	▣	▣	-	□
	LO..12	6	10	■	■	■	■	■	0,4/0,8/1,2/1,6/2,0/2,4/3,1/4,0/5,0/6,3	■	▣	▣	-	□
Square 6	XN..04..R	2	3	■	▣	■	-	□	0,4/0,8	■	□	▣	-	▣
	XN..08..R	4	7	■	▣	■	-	□	0,4/0,8/1,2/1,6	□	■	□	-	▣
SONX	SONX09	4	6	■	■	■	□	-	0,4/0,8	■	▣	□	-	-
	SONX12	6	10	■	■	■	□	-	0,8	▣	■	□	-	-

1st choice	■
Alternative choice	▣
Possible choice	□

High speed machine with low power/torque

Strong stable machine with rigid connection

Not recommended

Unstable condition suitability

Ramping ability

Plunging ability

Selection – Metric

Cutter	No. of cutting edges	Application	Cutter diameter (mm) available with effective number of teeth																				See page				
			10	12	14	16	18	20	22	25	32	40	44	50	52 54	63	66	80	84	100	125	160		200	250	315	
Double Turbo	4											2	3		4		5		6		8	10	12	14		23	
													3	4		5		6		8		10	12	14	16		
Turbo 06	2		2	2	3	3	4	4																		31, 32	
				3		4		5		7	8	10															
Turbo 10	2					2	2	2		3	3	4	4	5	5	5	5	8								38	
								3		4	5	6		7		8		10		12							
Turbo 12	2							2		2	3	4	4	5	5	6	6	7	7	8	8	10	10	12	16	46	
										3	4	5		7		8		10		12	14						
Turbo 16	2									2	2	3		4	5	5	6	6		8	8	10	10	11	12	16	56
											3	4		5/6		6/7		8/9	8	10	12	13					
Turbo 18	2										2	3		4	4	4/5	5	5/6	6	7	8	7/8	7/9	10	12	16	66
											3	4		5		6		8		9	11	12					
ABEX	2																5	5				7	8	10	12	14	82
																	6										
Square T4 08	4					2	2	2	3	3	3	4		5	5	6										90	
								3		4	5	6		7		9											
Square T4 12	4									2	3	3/4	4	5	5	6	6	7		9	12					99	
												5		6		8		10		12							
Square 6 04	6									4	5	5		6		7										99-105	
								3		5	6	7		8/9		9											
Square 6 08	6										3	3	4	4	6	7	5/7	7	6/8	7/11	12	8	10			106-115	
											4	4	5	5	7		9		11	14	16	12	10				
SONX09	4											4		4		7										117	
														6													
SONX12	4													4		4		6		8						117	
														5		6											

Fixed pocket (x indicates number of teeth)

With cassette (x indicates number of teeth)

Slotting and contouring

Optimized for contouring

Square shoulder and slot milling cutters

Helical milling cutters

Face milling cutters

Disc milling cutters

High feed milling cutters

Copy milling cutters

Plunge milling cutters

Chamfer milling cutters

Spot facing cutters

Inserts

Selection – Inch

Cutter	Insert	Recommended a_p		Material suitability					Corner radius (inch)					
				P	M	K	N	S						
Double Turbo	ZOMX16 	6	15	■	▣	■	□	▣	.031/.063	□	■	-	-	▣
	XO..06 	0.118	0.197	■	■	■	■	■	.008/.016 .031/.063	■	□	■	■	▣
Turbo	XO..10 	0.197	0.354	■	■	■	■	■	.016/.031 .047/.063 .079/.094 .122	■	▣	■	■	▣
	XO..12 	0.236	0.433	■	■	■	■	■	.016/.031 .047/.063 .079/.094 .122/.157 .197/.248	▣	■	■	■	▣
	XOMX16 	0.315	0.590	■	■	■	■	■	.016/.031 .047/.063 .079/.095 .122/.157 .197/.248	▣	■	■	■	▣
	XO..18 	0.354	0.669	■	▣	■	■	▣	.016/.031 .047/.063 .079/.094 .122/.157 .197/.248	□	■	■	■	▣
	LO..08 	0.118	0.276	■	▣	■	□	□	.016/.031 .047/.063	■	▣	▣	-	□
Square T4	LO..12 	0.276	0.393	■	■	■	■	■	0.079/.031/.047 .063/.094	■	▣	▣	-	□
Square 6	XN..04..R 	0.079	0.118	■	▣	■	-	□	.016/.031	■	□	▣	-	▣
	XN..08..R 	0.157	0.276	■	▣	■	-	□	.016/.031 .047/.063	□	■	□	-	▣

1st choice	■
Alternative choice	▣
Possible choice	□

High speed machine with low power/torque	
Strong stable machine with rigid connection	
Not recommended	

Unstable condition suitability	
Ramping ability	
Plunging ability	

Selection – Inch

Cutter	No. of cutting edges	Applica-tion	Cutter diameter available (inch)/number of teeth																See page	
			0.375	0.50	0.625	0.75	0.875	1.00	1.25	1.50	2.00	2.50	3.00	4.00	5.00	6.00	8.00	10.00		
Double Turbo	4									2	3	4	5	6	8	10				23
										3	4	5	6	8	10	12				
Turbo 06	2		2	2	3	4	5	6											31, 32	
				3	4	5		7	8	10										
Turbo 10	2			1	2	2	3	3		4	5								38	
						3		4	5	6	7		10							
Turbo 12	2					2	2	2	3/4	4	4/5	4	4/7	5/8	8		12		48, 49	
								3	4	5	7	6	10	12						
Turbo 16	2							2	2	3	4	5	6	8	9	12			48, 49	
									3	4	5/6	6	8	10						
Turbo 18	2							2	2	3	3/4	5	4/6	5	8	9	12		66	
									3	4	5	6	8	7/9	11	12				
Square T4 08	4				2			3	4	4	5								82	
						3		4												
Square T4 12	4							2	3	4	5	6	8	10	12	14			90	
												8								
Square 6 04	6								5	6									99	
						3		5			9									
Square 6 08	6									3	4/5	4	5	6	7	12	8/12	10	99	
											5	6/7	7/9	8/11	11					

Fixed pocket (x indicates number of teeth)

With cassette (x indicates number of teeth)

Slotting and contouring

Optimized for contouring

Square shoulder and slot milling cutters

Helical milling cutters

Face milling cutters

Disc milling cutters

High feed milling cutters

Copy milling cutters

Plunge milling cutters

Chamfer milling cutters

Spot facing cutters

Inserts

Square shoulder and slot milling cutters

Helical milling cutters

Face milling cutters

Disc milling cutters

High feed milling cutters

Copy milling cutters

Plunge milling cutters

Chamfer milling cutters

Spot facing cutters

Inserts



DOUBLE TURBO 16

Using the most positive helix cutting angle geometry on the market today means less power consumption, smoother cutting and longer tool life. Together with the impressive 90-degree angle accuracy and the double-sided inserts, this generates a good surface finish and reduces costs.

- Reduced downtime boosts your material removal rate with a depth of cut capability up to 15 mm (0.59")
- Cutter range metric, \varnothing 32-200 mm (Imperial \varnothing 1.250-5.000 inch)
- Reduced cost because of double-sided inserts with 4 cutting edges
- Insert type ZOMX16

Double Turbo 16 – R217.64-ZO16 – Metric

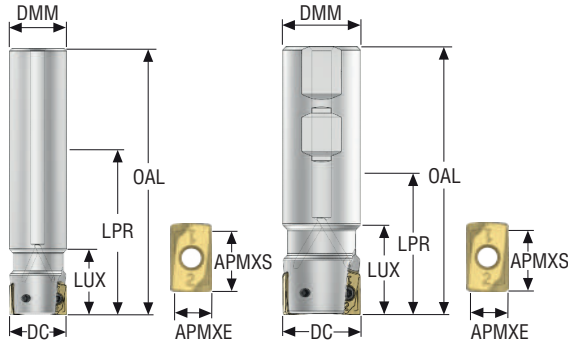

- For insert selection and cutting data recommendations, see page(s) 28-29
- For complete insert programme, see page(s) 876
- For ISO attribute explanation, see page 16
- KAPRS 90°

Designation	Item number	Type of mounting	DC	ZEFP	APMXS	APMXE	DMM	LUX	LPR	OAL	RMPX°	Cmin	Cmax	RPMX	Weight	Insert
			mm		mm	mm	mm	mm	mm	mm		mm	mm		kg	
R217.64-3232.0-ZO16-2A	03290227	Cylindrical	32,0	2	15,0	5,0	32,0	37,0	94,0	150,0	0,35	49,0	62,0	11400	0,8	ZOMX16..
R217.64-3232.0-ZO16-3A	10107618	Cylindrical	32,0	3	15,0	5,0	32,0	37,0	94,0	150,0	0,35	49,0	62,0	11400	0,8	ZOMX16..
R217.64-3240.0-ZO16-3A	03290228	Cylindrical	40,0	3	15,0	5,0	32,0	94,0	94,0	150,0	0,25	65,0	78,0	11400	0,9	ZOMX16..
R217.64-3240.0-ZO16-4A	03290229	Cylindrical	40,0	4	15,0	5,0	32,0	94,0	94,0	150,0	0,25	65,0	78,0	11400	0,9	ZOMX16..
R217.64-3232.3-ZO16-2A	03290222	Weldon	32,0	2	15,0	5,0	32,0	37,0	50,0	110,0	0,35	49,0	62,0	11400	0,6	ZOMX16..
R217.64-3232.3-ZO16-3A	10107617	Weldon	32,0	3	15,0	5,0	32,0	37,0	50,0	110,0	0,35	49,0	62,0	11400	0,6	ZOMX16..
R217.64-3240.3-ZO16-3A	03290223	Weldon	40,0	3	15,0	5,0	32,0	50,0	50,0	110,0	0,25	65,0	78,0	10000	0,7	ZOMX16..
R217.64-3240.3-ZO16-4A	03290224	Weldon	40,0	4	15,0	5,0	32,0	50,0	50,0	110,0	0,25	65,0	78,0	10000	0,7	ZOMX16..

Spare Parts, included in delivery

For cutter	Insert key	Insert screw
R217.64-3232-3240	T15P-2	C04011B-T15P

Accessories

For cutter	Insert clamping torque	Torque key
R217.64-..	3.5NM	T00-15P35

Torque and fixed keys, see page 894

Square shoulder and slot milling cutters

Helical milling cutters

Face milling cutters

Disc milling cutters

High feed milling cutters

Copy milling cutters

Plunge milling cutters

Chamfer milling cutters

Spot facing cutters

Inserts

Double Turbo 16 – R217.64-ZO16 – Inch

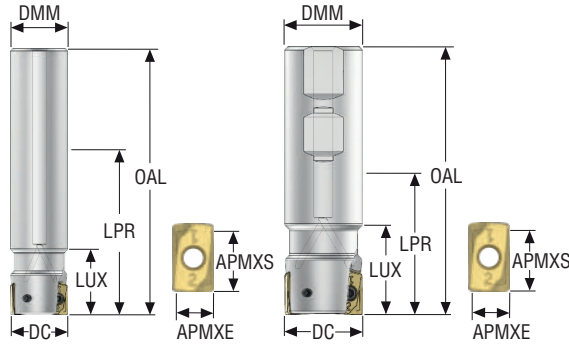

- For insert selection and cutting data recommendations, see page(s) 28-29
- For complete insert programme, see page(s) 876
- For ISO attribute explanation, see page 16
- KAPRS 90°

Designation	Item number	Type of mounting	DC	ZEFP	APMXS	APMXE	DMM	LUX	LPR	OAL	RMPX°	C min	C max	RPMX	Weight	Insert
			inch		inch	inch	inch	inch	inch	inch		inch	inch		lbs	
R217.64-01.25-0-ZO16-2A	03290230	Cylindrical	1.250	2	0.591	0.197	1.250	1.378	3.701	7.677	0,35	1.890	2.402	11400	2.430	ZOMX16..
R217.64-01.50-0-ZO16-3A	03290231	Cylindrical	1.500	3	0.591	0.197	1.250	3.701	3.701	7.677	0,25	2.402	2.913	10000	2.430	ZOMX16..
R217.64-01.25-3-ZO16-2A	03290225	Weldon	1.250	2	0.591	0.197	1.250	1.457	1.969	4.331	0,25	1.890	2.402	11400	1.320	ZOMX16..
R217.64-01.25-3-ZO16-3A	10107620	Weldon	1.250	3	0.591	0.197	1.250	1.457	1.969	4.331	0,25	1.890	2.402	11400	1.320	ZOMX16..
R217.64-01.50-3-ZO16-3A	03290226	Weldon	1.500	3	0.591	0.197	1.250	1.969	1.969	4.331	0,25	2.402	2.913	10000	1.320	ZOMX16..
R217.64-01.50-3-ZO16-4A	10107621	Weldon	1.500	4	0.591	0.197	1.250	1.969	1.969	4.331	0,25	2.402	2.913	10000	1.320	ZOMX16..

Spare Parts, included in delivery

For cutter	Insert key	Insert screw
R217.64-..	T15P-2	C04011B-T15P

Accessories

For cutter	Insert clamping torque	Torque key
R217.64-..	31.0IN.LBS	T00-15P35

Torque and fixed keys, see page 894

Square shoulder and slot milling cutters
Helical milling cutters
Face milling cutters
Disc milling cutters
High feed milling cutters
Copy milling cutters
Plunge milling cutters
Chamfer milling cutters
Spot facing cutters
Inserts

Double Turbo 16 – R217/220.64-ZO16 – Metric

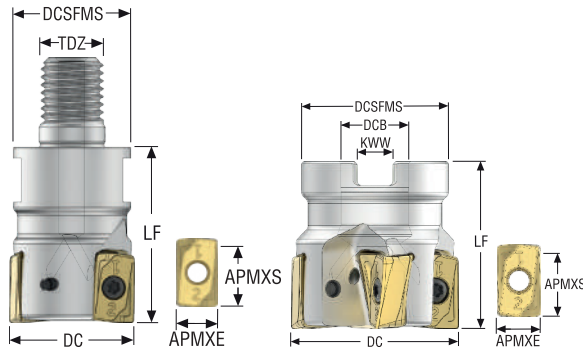

- For insert selection and cutting data recommendations, see page(s) 28-29
- For complete insert programme, see page(s) 876
- For ISO attribute explanation, see page 16
- KAPRS 90°

Designation	Item number	Type of mounting	DC	ZEFP	APMXS	APMXE	DCB	TDZ	DCSFMS	LF	RMPX°	Cmin	Cmax	RPMX	Weight	Insert
			mm		mm	mm	mm		mm	mm		mm	mm		kg	
R217.64-1632.RE-ZO16-3A	10107619	Combimaster	32,0	3	15,0	5,0	–	M16	30,0	45,0	0,35	49,0	62,0	11400	0,3	ZOMX16..
R217.64-2040.RE-ZO16-3A	03290233	Combimaster	40,0	3	15,0	5,0	–	M20	36,5	45,0	0,25	65,0	78,0	10000	0,4	ZOMX16..
R217.64-2040.RE-ZO16-4A	03290234	Combimaster	40,0	4	15,0	5,0	–	M20	36,5	45,0	0,25	65,0	78,0	10000	0,4	ZOMX16..
R220.64-0040-ZO16-3A	03290237	Arbor	40,0	3	15,0	5,0	16,0	–	35,0	40,0	0,25	65,0	78,0	10000	0,3	ZOMX16..
R220.64-0040-ZO16-4A	03290238	Arbor	40,0	4	15,0	5,0	16,0	–	35,0	40,0	0,25	65,0	78,0	10000	0,3	ZOMX16..
R220.64-0050-ZO16-4A	03290239	Arbor	50,0	4	15,0	5,0	22,0	–	47,0	40,0	0,2	85,0	98,0	9000	0,3	ZOMX16..
R220.64-0050-ZO16-5A	03290240	Arbor	50,0	5	15,0	5,0	22,0	–	47,0	40,0	0,2	85,0	98,0	9000	0,4	ZOMX16..
R220.64-0063-ZO16-5A	03290241	Arbor	63,0	5	15,0	5,0	22,0	–	47,0	40,0	0,15	111,0	124,0	8200	0,5	ZOMX16..
R220.64-0063-ZO16-5A-27	10000039	Arbor	63,0	5	15,0	5,0	27,0	–	56,0	40,0	0,15	111,0	124,0	8200	0,5	ZOMX16..
R220.64-0063-ZO16-6A	03290242	Arbor	63,0	6	15,0	5,0	22,0	–	47,0	40,0	0,15	111,0	124,0	8200	0,5	ZOMX16..
R220.64-0063-ZO16-6A-27	10000040	Arbor	63,0	6	15,0	5,0	27,0	–	56,0	40,0	0,15	111,0	124,0	8200	0,5	ZOMX16..
R220.64-0080-ZO16-6A	03290243	Arbor	80,0	6	15,0	5,0	27,0	–	62,0	50,0	0,1	145,0	158,0	7200	0,9	ZOMX16..
R220.64-0080-ZO16-8A	03290244	Arbor	80,0	8	15,0	5,0	27,0	–	62,0	50,0	0,1	145,0	158,0	7200	0,9	ZOMX16..
R220.64-0100-ZO16-8A	03290245	Arbor	100,0	8	15,0	5,0	32,0	–	77,0	50,0	0,0	–	–	6500	1,5	ZOMX16..
R220.64-0100-ZO16-10A	03290246	Arbor	100,0	10	15,0	5,0	32,0	–	77,0	50,0	0,0	–	–	6500	1,5	ZOMX16..
R220.64-0125-ZO16-10A	03290247	Arbor	125,0	10	15,0	5,0	40,0	–	90,0	63,0	0,0	–	–	5800	2,9	ZOMX16..
R220.64-0125-ZO16-12A	03290248	Arbor	125,0	12	15,0	5,0	40,0	–	90,0	63,0	0,0	–	–	5800	2,9	ZOMX16..
R220.64-8160-ZO16-12A	03307754	Arbor	160,0	12	15,0	5,0	40,0	–	90,0	63,0	0,0	–	–	5100	5,1	ZOMX16..
R220.64-8160-ZO16-14A	03307755	Arbor	160,0	14	15,0	5,0	40,0	–	90,0	63,0	0,0	–	–	5100	9,6	ZOMX16..
R220.64-8200-ZO16-14A	03307756	Arbor	200,0	14	15,0	5,0	60,0	–	130,0	63,0	0,0	–	–	4500	6,7	ZOMX16..
R220.64-8200-ZO16-16A	03307757	Arbor	200,0	16	15,0	5,0	60,0	–	130,0	63,0	0,0	–	–	4500	6,8	ZOMX16..

For Combimaster Shanks, see Machining Navigator Tooling System

Spare Parts, included in delivery

For cutter	Arbor screw	Insert key	Insert screw	Lid	Lid screw
R217.64-1632-2040	-	T15P-2	C04011B-T15P	-	-
R220.64-0040	220.17-690	T15P-2	C04011B-T15P	-	-
R220.64-0050-0063	220.17-692	T15P-2	C04011B-T15P	-	-
R220.64-0063-27	MLC6S12X30	T15P-2	C04011B-T15P	-	-
R220.64-0080-0125	-	T15P-2	C04011B-T15P	-	-
R220.64-8160	-	T15P-2	C04011B-T15P	SC-160-90	MF6S4X8
R220.64-8200	-	T15P-2	C04011B-T15P	SC-200-90	MF6S4X8

Accessories

For cutter	Arbor screw	Insert clamping torque	Torque key
R217/220.64-1632-0125	-	3.5NM	T00-15P35
R220.64-8160	MC6S12X40	3.5NM	T00-15P35
R220.64-8200	MC6S16X50	3.5NM	T00-15P35

Torque and fixed keys, see page 894

Square shoulder and slot milling cutters
Helical milling cutters
Face milling cutters
Disc milling cutters
High feed milling cutters
Copy milling cutters
Plunge milling cutters
Chamfer milling cutters
Spot facing cutters
Inserts

Double Turbo 16 – R217/220.64-ZO16 – inch

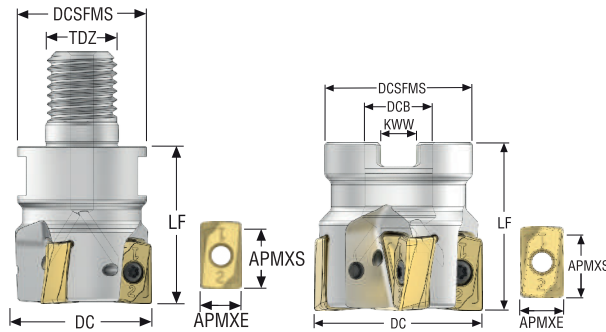

- For insert selection and cutting data recommendations, see page(s) 28-29
- For complete insert programme, see page(s) 876
- For ISO attribute explanation, see page 16
- KAPRS 90°

Designation	Item number	Type of mounting	DC	ZEP	APMXS	APMXE	DCB	TDZ	DCSFMS	LF	RMPX°	C min	C max	RPMX	Weight	Insert
			inch		inch	inch	inch		inch	inch		inch	inch		lbs	
R217.64-01.25-16RE-ZO16-2A	03290235	Combimaster	1.250	2	0.591	0.197	–	M16	1.181	1.772	0.35	1.890	2.402	11400	0.660	ZOMX16..
R217.64-01.50-20RE-ZO16-3A	03290236	Combimaster	1.500	3	0.591	0.197	–	M20	1.437	1.772	0.25	2.402	2.913	10000	0.880	ZOMX16..
R220.64-02.00-ZO16-4A	03290250	Arbor	2.000	4	0.591	0.197	0.750	–	1.850	1.575	0.2	3.386	3.898	9000	0.880	ZOMX16..
R220.64-02.00-ZO16-5A	03290251	Arbor	2.000	5	0.591	0.197	0.750	–	1.850	1.575	0.2	3.386	3.898	9000	0.880	ZOMX16..
R220.64-02.50-ZO16-5A	03290252	Arbor	2.500	5	0.591	0.197	0.750	–	1.850	1.575	0.15	4.409	4.921	8200	1.100	ZOMX16..
R220.64-02.50-ZO16-6A	03290253	Arbor	2.500	6	0.591	0.197	0.750	–	1.850	1.575	0.15	4.409	4.921	8200	1.100	ZOMX16..
R220.64-03.00-ZO16-6A	03290254	Arbor	3.000	6	0.591	0.197	1.000	–	2.441	1.969	0.1	5.394	5.906	7200	2.200	ZOMX16..
R220.64-03.00-ZO16-8A	03290255	Arbor	3.000	8	0.591	0.197	1.000	–	2.441	1.969	0.1	5.394	5.906	7200	2.200	ZOMX16..
R220.64-04.00-ZO16-8A	03290256	Arbor	4.000	8	0.591	0.197	1.500	–	3.031	1.969	0.0	–	–	6500	3.530	ZOMX16..
R220.64-04.00-ZO16-10A	03290257	Arbor	4.000	10	0.591	0.197	1.500	–	3.031	1.969	0.0	–	–	6500	3.530	ZOMX16..
R220.64-05.00-ZO16-10A	03290258	Arbor	5.000	10	0.591	0.197	1.500	–	3.543	2.480	0.0	–	–	5800	5.730	ZOMX16..
R220.64-05.00-ZO16-12A	03290259	Arbor	5.000	12	0.591	0.197	1.500	–	3.543	2.480	0.0	–	–	5800	7.280	ZOMX16..

For Combimaster Shanks, see Machining Navigator Tooling System

Spare Parts, included in delivery

For cutter	Arbor screw	Insert key	Insert screw
R217.64-..	–	T15P-2	C04011B-T15P
R220.64-02.00-02.50	UC6S3/8UNFX1	T15P-2	C04011B-T15P
R220.64-03.00	UC6S1/2UNFX1-1/4	T15P-2	C04011B-T15P
R220.64-04.00-05.00	UC6S3/4UNFX1-1/4	T15P-2	C04011B-T15P

Accessories

For cutter	Insert clamping torque	Torque key
R217/220.64-..	31.0IN.LBS	T00-15P35

Torque and fixed keys, see page 894

R217/220.64-16 – Insert selection – Metric / Inch

SMG		a_p	f_z		
			100%	30%	10%
P1	ZOMX160708TR-ME10 F40M	7,0	0,14	0,15	0,24
		0,28	0,0055	0,0060	0,0095
P2	ZOMX160708TR-ME10 F40M	7,0	0,14	0,16	0,24
		0,28	0,0055	0,0065	0,0095
P3	ZOMX160708TR-M12 MP2501	7,0	0,16	0,18	0,28
		0,28	0,0065	0,0070	0,011
P4	ZOMX160708TR-M12 MP2501	7,0	0,16	0,17	0,26
		0,28	0,0065	0,0065	0,010
P5	ZOMX160708TR-M12 MP2501	7,0	0,16	0,17	0,26
		0,28	0,0065	0,0065	0,010
P6	ZOMX160708TR-M12 MP2501	7,0	0,16	0,17	0,26
		0,28	0,0065	0,0065	0,010
P7	ZOMX160708TR-M12 MP2501	7,0	0,16	0,17	0,26
		0,28	0,0065	0,0065	0,010
P8	ZOMX160708TR-M12 MP2501	7,0	0,16	0,18	0,28
		0,28	0,0065	0,0070	0,011
P11	ZOMX160708TR-M12 MS2500	7,0	0,16	0,17	0,26
		0,28	0,0065	0,0065	0,010
P12	ZOMX160708TR-M12 MS2500	6,0	0,11	0,12	0,18
		0,24	0,0044	0,0048	0,0070
M1	ZOMX160708TR-ME10 F40M	7,0	0,14	0,16	0,24
		0,28	0,0055	0,0065	0,0095
M2	ZOMX160708TR-ME10 F40M	7,0	0,13	0,14	0,22
		0,28	0,0050	0,0055	0,0085
M3	ZOMX160708TR-ME10 F40M	6,0	0,10	0,11	0,17
		0,24	0,0040	0,0044	0,0065
M4	ZOMX160708TR-ME10 MS2050	4,5	0,090	0,10	0,15
		0,18	0,0036	0,0040	0,0060
M5	ZOMX160708TR-ME10 MS2050	4,5	0,090	0,10	0,15
		0,18	0,0036	0,0040	0,0060
K1	ZOMX160708TR-M12 MK2050	7,0	0,17	0,19	0,28
		0,28	0,0065	0,0075	0,011
K2	ZOMX160708TR-M12 MK2050	7,0	0,16	0,17	0,26
		0,28	0,0065	0,0065	0,010
K3	ZOMX160708TR-M12 MK2050	7,0	0,16	0,17	0,26
		0,28	0,0065	0,0065	0,010
K4	ZOMX160708TR-M12 MK2050	7,0	0,16	0,17	0,26
		0,28	0,0065	0,0065	0,010
K5	ZOMX160708TR-M12 MK2050	7,0	0,14	0,15	0,24
		0,28	0,0055	0,0060	0,0095
K6	ZOMX160708TR-M12 MK2050	7,0	0,16	0,17	0,26
		0,28	0,0065	0,0065	0,010
K7	ZOMX160708TR-M12 MP3000	7,0	0,14	0,15	0,24
		0,28	0,0055	0,0060	0,0095
S1	ZOMX160708TR-ME10 MS2050	4,5	0,090	0,10	0,15
		0,18	0,0036	0,0040	0,0060
S2	ZOMX160708TR-ME10 MS2050	4,5	0,090	0,10	0,15
		0,18	0,0036	0,0040	0,0060
S3	ZOMX160708TR-ME10 MS2050	4,5	0,085	0,095	0,14
		0,18	0,0034	0,0038	0,0055
S11	ZOMX160708TR-ME10 MS2050	5,0	0,11	0,11	0,17
		0,20	0,0044	0,0044	0,0065
S12	ZOMX160708TR-ME10 MS2050	5,0	0,11	0,11	0,17
		0,20	0,0044	0,0044	0,0065
S13	ZOMX160708TR-ME10 MS2050	4,5	0,090	0,10	0,15
		0,18	0,0036	0,0040	0,0060
H5	ZOMX160708TR-M12 MP3000	6,0	0,11	0,12	0,18
		0,24	0,0044	0,0048	0,0070
H8	ZOMX160708TR-M12 MP3000	5,0	0,080	0,090	0,14
		0,20	0,0032	0,0036	0,0055
H11	ZOMX160708TR-M12 MP3000	6,0	0,11	0,12	0,18
		0,24	0,0044	0,0048	0,0070
H12	ZOMX160708TR-M12 MP3000	5,0	0,080	0,090	0,14
		0,20	0,0032	0,0036	0,0055

SMG = Seco material group
 f_z = mm/tooth (in/tooth), v_c = m/min (sf/min), a_p/DC = %
 All cutting data are start values

R217/220.64-16 – Cutting data $v_c = (m/min)/(sf/min)$

SMG	MP1501			MP2501			MP3000			MK2050			MS2050			MS2500			F40M		
	100%	30%	10%	100%	30%	10%	100%	30%	10%	100%	30%	10%	100%	30%	10%	100%	30%	10%	100%	30%	10%
P1	305	410	480	270	365	425	255	345	405	265	355	420	255	340	400	295	395	465	205	275	325
	1000	1350	1575	890	1200	1400	840	1125	1325	870	1175	1375	840	1125	1300	970	1300	1525	670	900	1075
P2	300	390	470	265	350	415	250	330	395	260	340	410	250	325	390	290	380	455	200	265	315
	980	1275	1550	870	1150	1350	820	1075	1300	850	1125	1350	820	1075	1275	950	1250	1500	660	870	1025
P3	260	345	405	230	305	360	220	290	340	230	300	355	215	285	340	250	330	390	175	230	270
	850	1125	1325	750	1000	1175	720	950	1125	750	980	1175	710	940	1125	820	1075	1275	570	750	890
P4	230	305	365	205	270	320	195	260	305	200	270	315	195	250	300	220	295	350	155	205	245
	750	1000	1200	670	890	1050	640	850	1000	660	890	1025	640	820	980	720	970	1150	510	670	800
P5	220	295	345	195	260	305	185	245	290	190	255	305	185	245	290	210	285	335	145	195	235
	720	970	1125	640	850	1000	610	800	950	620	840	1000	610	800	950	690	940	1100	475	640	770
P6	245	330	390	220	290	345	205	275	325	215	285	340	205	275	325	240	320	375	165	220	260
	800	1075	1275	720	950	1125	670	900	1075	710	940	1125	670	900	1075	790	1050	1225	540	720	850
P7	235	310	370	205	275	325	195	260	310	205	270	320	195	260	305	225	300	355	155	210	245
	770	1025	1225	670	900	1075	640	850	1025	670	890	1050	640	850	1000	740	980	1175	510	690	800
P8	220	290	340	195	255	300	185	240	285	190	250	295	180	240	290	210	280	330	145	195	230
	720	950	1125	640	840	980	610	790	940	620	820	970	590	790	950	690	920	1075	475	640	750
P11	225	300	355	200	265	315	190	255	300	195	265	310	190	255	295	220	290	345	150	205	240
	740	980	1175	660	870	1025	620	840	980	640	870	1025	620	840	970	720	950	1125	490	670	790
P12	150	195	235	130	175	205	125	165	195	130	170	205	125	165	195	145	190	225	100	130	155
	490	640	770	425	570	670	410	540	640	425	560	670	410	540	640	475	620	740	330	425	510
M1	—	—	—	190	250	300	185	245	295	—	—	—	200	265	315	205	270	325	160	210	255
	—	—	—	620	820	980	610	800	970	—	—	—	660	870	1025	670	890	1075	520	690	840
M2	—	—	—	155	210	245	155	205	245	—	—	—	165	220	260	170	225	270	135	175	210
	—	—	—	510	690	800	510	670	800	—	—	—	540	720	850	560	740	890	445	570	690
M3	—	—	—	125	170	205	125	165	200	—	—	—	135	180	210	140	185	220	110	145	170
	—	—	—	410	560	670	410	540	660	—	—	—	445	590	690	460	610	720	360	475	560
M4	—	—	—	100	135	155	100	130	155	—	—	—	105	140	165	110	145	170	85	110	130
	—	—	—	330	445	510	330	425	510	—	—	—	345	460	540	360	475	560	280	360	425
M5	—	—	—	85	110	130	80	110	130	—	—	—	90	115	135	90	120	140	70	95	110
	—	—	—	280	360	425	260	360	425	—	—	—	295	375	445	295	395	460	230	310	360
K1	235	310	370	210	275	330	200	260	310	280	370	440	—	—	—	—	—	—	160	210	250
	770	1025	1225	690	900	1075	660	850	1025	920	1225	1450	—	—	—	—	—	—	520	690	820
K2	210	280	330	185	245	290	175	235	275	250	330	390	—	—	—	—	—	—	140	185	220
	690	920	1075	610	800	950	570	770	900	820	1075	1275	—	—	—	—	—	—	460	610	720
K3	175	235	280	155	210	245	150	200	235	210	280	330	—	—	—	—	—	—	120	160	185
	570	770	920	510	690	800	490	660	770	690	920	1075	—	—	—	—	—	—	395	520	610
K4	170	225	265	150	200	235	140	190	225	200	265	315	—	—	—	—	—	—	115	150	180
	560	740	870	490	660	770	460	620	740	660	870	1025	—	—	—	—	—	—	375	490	590
K5	105	140	160	90	125	145	85	115	135	125	165	190	—	—	—	—	—	—	70	95	110
	345	460	520	295	410	475	280	375	445	410	540	620	—	—	—	—	—	—	230	310	360
K6	150	200	235	130	175	210	125	165	195	175	235	280	—	—	—	—	—	—	100	135	155
	490	660	770	425	570	690	410	540	640	570	770	920	—	—	—	—	—	—	330	445	510
K7	135	180	205	120	155	185	110	150	175	160	210	245	—	—	—	—	—	—	90	120	140
	445	590	670	395	510	610	360	490	570	520	690	800	—	—	—	—	—	—	295	395	460
S1	—	—	—	49	65	75	46	60	70	—	—	—	49	65	75	55	70	85	40	50	60
	—	—	—	160	215	245	150	195	230	—	—	—	160	215	245	180	230	280	130	165	195
S2	—	—	—	39	50	60	37	49	60	—	—	—	40	50	60	43	55	65	32	42	50
	—	—	—	130	165	195	120	160	195	—	—	—	130	165	195	140	180	215	105	140	165
S3	—	—	—	35	46	55	33	43	50	—	—	—	35	46	55	38	50	60	28	37	43
	—	—	—	115	150	180	110	140	165	—	—	—	115	150	180	125	165	195	90	120	140
S11	—	—	—	65	90	105	65	85	100	—	—	—	70	90	105	75	95	115	55	70	85
	—	—	—	215	295	345	215	280	330	—	—	—	230	295	345	245	310	375	180	230	280
S12	—	—	—	47	60	75	44	60	70	—	—	—	47	65	75	50	65	80	38	50	60
	—	—	—	155	195	245	145	195	230	—	—	—	155	215	245	165	215	260	125	165	195
S13	—	—	—	28	36	43	26	34	40	—	—	—	28	36	43	30	40	47	22	30	35
	—	—	—	90	120	140	85	110	130	—	—	—	90	120	140	100	130	155	70	100	115
H5	49	65	75	40	55	60	39	50	60	—	—	—	—	—	—	—	—	—	33	44	50
	160	215	245	130	180	195	130	165	195	—	—	—	—	—	—	—	—	—	110	145	165
H8	55	70	80	43	55	65	42	55	65	—	—	—	—	—	—	—	—	—	36	47	55
	180	230	260	140	180	215	140	180	215	—	—	—	—	—	—	—	—	—	120	155	180
H11	65	85	100	50	65	80	49	65	75	—	—	—	—	—	—	—	—	—	42	55	65
	215	280	330	165	215	260	160	215	245	—	—	—	—	—	—	—	—	—	140	180	215
H12	95	125	145	85	110	130	80	105	125	—	—	—	—	—	—	95	120	145	65	85	100
	310	410	475	280	360	425	260	345	410	—	—	—	—	—	—	310	395	475	215	280	330

Square shoulder and slot milling cutters
Helical milling cutters
Face milling cutters
Disc milling cutters
High feed milling cutters
Copy milling cutters
Plunge milling cutters
Chamfer milling cutters
Spot facing cutters
Inserts

Square shoulder and slot milling cutters

Helical milling cutters

Face milling cutters

Disc milling cutters

High feed milling cutters

Copy milling cutters

Plunge milling cutters

Chamfer milling cutters

Spot facing cutters

Inserts



TURBO CUTTERS

The Turbo family takes square shoulder milling to the max. Suitable for most roughing, semi-finishing and finishing operations, these highly versatile cutters offer long tool life and high precision via optimized properties that reduce heat generation and cutting forces.

- Turbo 06 Insert size 06, cutter range metric, Ø 10-40 mm (Imperial Ø 0.375-1.500 inch)
- Turbo 10 Insert size 10, cutter range metric, Ø 16-100mm (Imperial Ø 0.500-3.000 inch)
- Turbo 12 Insert size 12, cutter range metric, Ø 20-250 mm (Imperial Ø 0.750-4.000 inch)
- Turbo 16 Insert size 16, cutter range metric, Ø 25-250 mm (Imperial Ø 1.000-6.000 inch)
- Turbo 18 Insert size 18, cutter range metric, Ø 32-250 mm (Imperial Ø 1.000-6.000 inch)

Turbo 06 – R217.69-06 – Metric

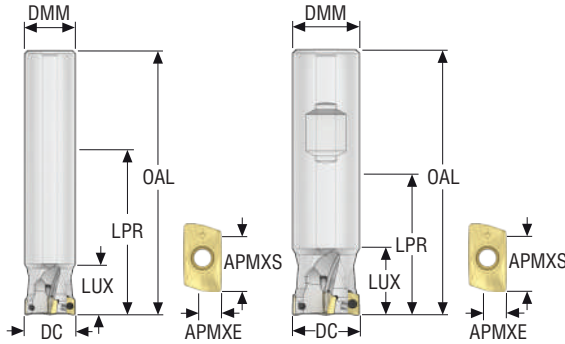

- For insert selection and cutting data recommendations, see page(s) 36-37
- For complete insert programme, see page(s) 866
- For ISO attribute explanation, see page 16
- KAPRS 90°

Designation	Item number	Type of mounting	DC	ZEFP	APMXS	APMXE	DMM	LUX	LPR	OAL	RMPX°	Cmin	Cmax	RPMX	Weight	Insert
			mm		mm	mm	mm	mm	mm	mm		mm	mm		kg	
R217.69-0810.0-06-2AN	02690707	Cylindrical	10,0	2	5,0	3,0	8,0	64,0	64,0	100,0	10,0	14,5	19,0	60000	0,1	XO.X06..
R217.69-0810.0-06-2N	02690736	Cylindrical	10,0	2	5,0	3,0	8,0	64,0	64,0	100,0	10,0	14,5	19,0	60000	0,1	XO.X06..
R217.69-1010.0-06-2AD	00035456	Cylindrical	10,0	2	5,0	3,0	10,0	17,0	17,0	55,0	10,0	14,5	19,0	60000	0,1	XO.X06..
R217.69-1010.0-06-2AN	02690714	Cylindrical	10,0	2	5,0	3,0	10,0	17,0	17,0	55,0	10,0	14,5	19,0	60000	0,1	XO.X06..
R217.69-1010.0-06-2N	02690737	Cylindrical	10,0	2	5,0	3,0	10,0	18,0	62,0	100,0	10,0	14,5	19,0	60000	0,1	XO.X06..
R217.69-1012.0-06-2AN	02690712	Cylindrical	12,0	2	5,0	3,0	10,0	80,0	80,0	120,0	6,5	18,5	23,0	54400	0,1	XO.X06..
R217.69-1012.0-06-2N	02690738	Cylindrical	12,0	2	5,0	3,0	10,0	80,0	80,0	120,0	6,5	18,5	23,0	54400	0,1	XO.X06..
R217.69-1212.0-06-2AN	02690715	Cylindrical	12,0	2	5,0	3,0	12,0	18,0	35,0	80,0	6,5	18,5	23,0	54400	0,1	XO.X06..
R217.69-1212.0-06-2N	02690739	Cylindrical	12,0	2	5,0	3,0	12,0	18,0	75,0	120,0	6,5	18,5	23,0	54400	0,2	XO.X06..
R217.69-1212.0-06-3AD	00035457	Cylindrical	12,0	3	5,0	3,0	12,0	18,0	35,0	80,0	6,5	18,5	23,0	54400	0,2	XO.X06..
R217.69-1212.0-06-3AN	02690724	Cylindrical	12,0	3	5,0	3,0	12,0	18,0	18,0	60,0	6,5	18,5	23,0	54400	0,1	XO.X06..
R217.69-1214.0-06-3AN	02690708	Cylindrical	14,0	3	5,0	3,0	12,0	95,0	95,0	140,0	5,0	22,5	27,0	51200	0,2	XO.X06..
R217.69-1416.0-06-3AN	02690713	Cylindrical	16,0	3	5,0	3,0	14,0	115,0	115,0	160,0	4,0	26,5	31,0	48000	0,2	XO.X06..
R217.69-1616.0-06-3AN	02690717	Cylindrical	16,0	3	5,0	3,0	16,0	20,0	42,0	90,0	4,0	26,5	31,0	48000	0,2	XO.X06..
R217.69-1616.0-06-4AD	00035458	Cylindrical	16,0	4	5,0	3,0	16,0	20,0	42,0	90,0	4,0	26,5	31,0	48000	0,3	XO.X06..
R217.69-1616.0-06-4AN	02690718	Cylindrical	16,0	4	5,0	3,0	16,0	20,0	42,0	90,0	4,0	26,5	31,0	48000	0,2	XO.X06..
R217.69-1618.0-06-4AN	02690710	Cylindrical	18,0	4	5,0	3,0	16,0	132,0	132,0	180,0	3,0	30,5	35,0	45600	0,3	XO.X06..
R217.69-1820.0-06-4AN	02690711	Cylindrical	20,0	4	5,0	3,0	18,0	150,0	150,0	200,0	2,5	34,5	39,0	44000	0,4	XO.X06..
R217.69-2020.0-06-4AN	02690703	Cylindrical	20,0	4	5,0	3,0	20,0	20,0	55,0	105,0	2,5	34,5	39,0	44000	0,3	XO.X06..
R217.69-2020.0-06-5AD	00035459	Cylindrical	20,0	5	5,0	3,0	20,0	20,0	55,0	105,0	2,5	34,5	39,0	44000	0,5	XO.X06..
R217.69-2020.0-06-5AN	02690720	Cylindrical	20,0	5	5,0	3,0	20,0	20,0	55,0	105,0	2,5	34,5	39,0	44000	0,3	XO.X06..
R217.69-2025.0-06-7AN	02690721	Cylindrical	25,0	7	5,0	3,0	20,0	65,0	65,0	115,0	2,5	44,5	49,0	37600	0,3	XO.X06..
R217.69-2532.0-06-8AN	02690723	Cylindrical	32,0	8	5,0	3,0	25,0	74,0	74,0	130,0	1,5	58,5	63,0	33600	0,5	XO.X06..
R217.69-3240.0-06-10AN	02690725	Cylindrical	40,0	10	5,0	3,0	32,0	80,0	80,0	140,0	1,0	74,5	79,0	28000	0,9	XO.X06..
R217.69-1616.3-06-3AN	02690646	Weldon	16,0	3	5,0	3,0	16,0	20,0	22,0	70,0	4,0	26,5	31,0	48000	0,1	XO.X06..
R217.69-1616.3-06-4AN	02690647	Weldon	16,0	4	5,0	3,0	16,0	20,0	42,0	70,0	4,0	26,5	31,0	48000	0,2	XO.X06..
R217.69-2020.3-06-4AN	02690648	Weldon	20,0	4	5,0	3,0	20,0	20,0	30,0	80,0	2,5	34,5	39,0	44000	0,2	XO.X06..
R217.69-2020.3-06-5AN	02690649	Weldon	20,0	5	5,0	3,0	20,0	20,0	35,0	85,0	2,5	34,5	39,0	44000	0,3	XO.X06..
R217.69-2025.3-06-7AN	02690650	Weldon	25,0	7	5,0	3,0	20,0	40,0	40,0	90,0	2,5	44,5	49,0	37600	0,2	XO.X06..

Modification of the cutter body needed for radii > 0,8 mm

Square shoulder and slot milling cutters

Helical milling cutters

Face milling cutters

Disc milling cutters

High feed milling cutters

Copy milling cutters

Plunge milling cutters

Chamfer milling cutters



Spot facing cutters

Inserts

Spare Parts, included in delivery

For cutter	Insert key	Insert screw
R217.69-..	H4B-T06P 	C01804-T06P 

Accessories

For cutter	Insert clamping torque	Torque key
R217.69-..	0.5NM 	T00-06P05 

Torque and fixed keys, see page 894

Square shoulder and slot milling cutters

Helical milling cutters

Face milling cutters

Disc milling cutters

High feed milling cutters

Copy milling cutters

Plunge milling cutters

Chamfer milling cutters

Spot facing cutters

Inserts

Turbo 06 – R217.69-06 – Inch

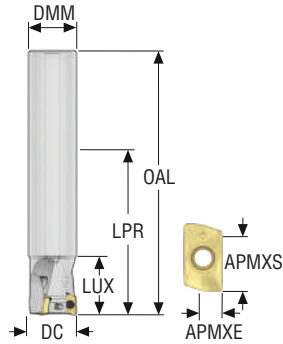

- For insert selection and cutting data recommendations, see page(s) 36-37
- For complete insert programme, see page(s) 866
- For ISO attribute explanation, see page 16
- KAPRS 90°

Designation	Item number	Type of mounting	DC	ZFEP	APMXS	APMXE	DMM	LUX	LPR	OAL	RMPX°	C min	C max	RPMX	Weight	Insert
			inch		inch	inch	inch	inch	inch	inch		inch	inch		lbs	
R217.69-00.375-0-06-2AN	02694880	Cylindrical	0.375	2	0.197	0.118	0.375	0.669	0.669	2.165	10,0	0.531	0.709	60000	0.220	XO.X06..
R217.69-00.375-0-06-2LAN	02694883	Cylindrical	0.375	2	0.197	0.118	0.313	2.362	2.362	3.937	10,0	0.531	0.709	60000	0.440	XO.X06..
R217.69-00.50-0-06-2AN	02694884	Cylindrical	0.500	2	0.197	0.118	0.500	0.709	1.378	3.150	6,5	0.768	0.945	54000	0.440	XO.X06..
R217.69-00.50-0-06-2LAN	02694886	Cylindrical	0.500	2	0.197	0.118	0.375	2.362	2.362	3.937	6,5	0.768	0.945	54000	0.440	XO.X06..
R217.69-00.50-0-06-3AN	02694887	Cylindrical	0.500	3	0.197	0.118	0.500	0.709	0.709	2.362	6,0	0.768	0.945	54000	0.220	XO.X06..
R217.69-00.625-0-06-3AN	02694889	Cylindrical	0.625	3	0.197	0.118	0.625	0.787	1.654	3.543	4,0	1.024	1.201	48000	0.440	XO.X06..
R217.69-00.625-0-06-3LAN	02694890	Cylindrical	0.625	3	0.197	0.118	0.500	3.150	3.150	4.921	4,0	1.024	1.201	48000	0.440	XO.X06..
R217.69-00.625-0-06-4AN	02694891	Cylindrical	0.625	4	0.197	0.118	0.625	0.787	1.654	3.543	4,0	1.024	1.201	48000	0.440	XO.X06..
R217.69-00.75-0-06-4AN	02694892	Cylindrical	0.750	4	0.197	0.118	0.750	0.787	1.969	3.937	2,0	1.280	1.457	44000	0.660	XO.X06..
R217.69-00.75-0-06-4LAN	02694898	Cylindrical	0.750	4	0.197	0.118	0.625	4.016	4.016	5.906	2,0	1.280	1.457	44000	0.660	XO.X06..
R217.69-00.75-0-06-5AN	02694896	Cylindrical	0.750	5	0.197	0.118	0.750	0.787	1.969	3.937	2,5	1.280	1.457	44000	0.660	XO.X06..
R217.69-00.875-0-06-5LAN	02694899	Cylindrical	0.875	5	0.197	0.118	0.750	3.937	3.937	5.906	2,0	1.535	1.713	44000	0.660	XO.X06..
R217.69-01.00-0-06-6LAN	02694903	Cylindrical	1.000	6	0.197	0.118	0.750	5.906	5.906	7.874	1,0	1.772	1.949	37600	1.100	XO.X06..
R217.69-01.00-0-06-7AN	02694904	Cylindrical	1.000	7	0.197	0.118	1.000	0.787	2.559	4.528	1,5	1.772	1.949	37600	0.880	XO.X06..
R217.69-01.25-0-06-8AN	02694907	Cylindrical	1.250	8	0.197	0.118	1.000	2.913	2.913	5.118	1,0	2.283	2.461	33600	1.320	XO.X06..

Modification of the cutter body needed for radii > 0.031 in

Spare Parts, included in delivery

For cutter	Insert key	Insert screw
R217.69-..	H4B-T06P	C01804-T06P

Accessories

For cutter	Insert clamping torque	Torque key
R217.69-..	4.4IN.LBS	T00-06P05

Torque and fixed keys, see page 894

Turbo 06 – R217/220.69-06 – Metric

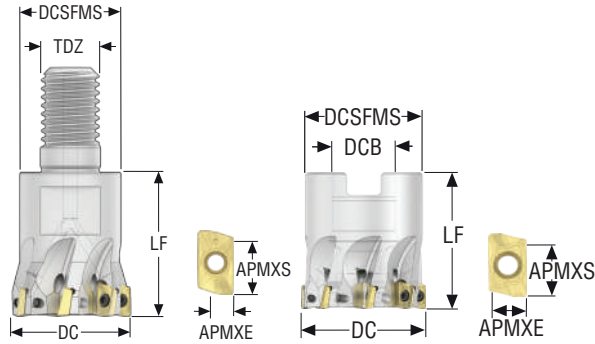

- For insert selection and cutting data recommendations, see page(s) 36-37
- For complete insert programme, see page(s) 866
- For ISO attribute explanation, see page 16
- KAPRS 90°

Designation	Item number	Type of mounting	DC	ZEFP	APMXS	APMXE	DCB	TDZ	DCSFMS	LF	RMPX°	Cmin	Cmax	RPMX	Weight	Insert
			mm		mm	mm	mm		mm	mm		mm	mm		kg	
R217.69-0816.RE-06-4AN	02690643	Combimaster	16,0	4	5,0	3,0	–	M8	13,5	23,0	7,5	26,5	31,0	48000	0,1	XO.X06..
R217.69-1020.RE-06-5AN	02690641	Combimaster	20,0	5	5,0	3,0	–	M10	18,0	28,0	4,5	34,5	39,0	44000	0,1	XO.X06..
R217.69-1225.RE-06-7AN	02690642	Combimaster	25,0	7	5,0	3,0	–	M12	21,0	30,0	2,5	44,5	49,0	37600	0,1	XO.X06..
R217.69-1632.RE-06-8AN	02690638	Combimaster	32,0	8	5,0	3,0	–	M16	28,0	35,0	1,5	58,5	63,0	33600	0,3	XO.X06..
R217.69-1640.RE-06-10AN	02690639	Combimaster	40,0	10	5,0	3,0	–	M16	28,0	40,0	1,0	74,5	79,0	28000	0,3	XO.X06..
R220.69-0032-06-8AN	02690741	Arbor	32,0	8	5,0	3,0	16,0	–	30,0	35,0	1,5	58,5	63,0	33600	0,2	XO.X06..
R220.69-0040-06-10AN	02690742	Arbor	40,0	10	5,0	3,0	16,0	–	35,0	35,0	1,0	74,5	79,0	18600	0,2	XO.X06..

Modification of the cutter body needed for radii > 0,8 mm
For Combimaster Shanks, see Machining Navigator Tooling System

Spare Parts, included in delivery

For cutter	Arbor screw	Insert key	Insert screw
R217.69-..	–	H4B-T06P	C01804-T06P
R220.69-..	TCEI0825	H4B-T06P	C01804-T06P

Accessories

For cutter	Insert clamping torque	Torque key
R217/220.69-..	0.5NM	T00-06P05

Torque and fixed keys, see page 894

Turbo 06 – R217/220.69-06 – Inch

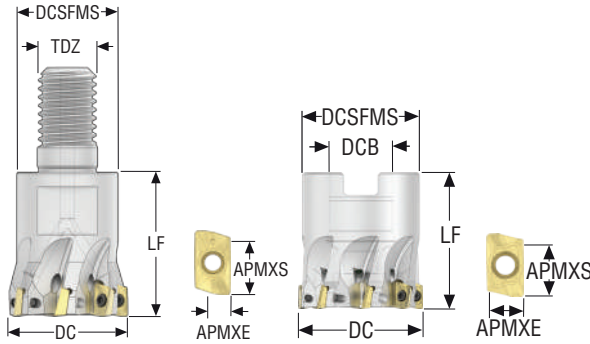

- For insert selection and cutting data recommendations, see page(s) 36-37
- For complete insert programme, see page(s) 866
- For ISO attribute explanation, see page 16
- KAPRS 90°

Designation	Item number	Type of mounting	DC	ZEP	APMXS	APMXE	DCB	TDZ	DCSFMS	LF	RMPX°	C min	C max	RPMX	Weight	Insert
			inch		inch	inch	inch		inch	inch		inch	inch		lbs	
R217.69-01.00-12RE-06-7AN	02695013	Combimaster	1.000	7	0.197	0.118	–	M12	0.906	1.378	1.5	1.772	1.949	37600	0.440	XO.X06..
R220.69-01.50-06-10AN	02694915	Arbor	1.500	10	0.197	0.118	0.500	–	1.378	1.378	1.0	2.776	2.953	28000	0.660	XO.X06..

Modification of the cutter body needed for radii > 0.031 in
For Combimaster Shanks, see Machining Navigator Tooling System

Spare Parts, included in delivery

For cutter	Arbor screw	Insert key	Insert screw
R217.69-..	–	H4B-T06P	C01804-T06P
R220.69-..	UC6S1/4UNFX1	H4B-T06P	C01804-T06P

Accessories

For cutter	Insert clamping torque	Torque key
R217/220.69-..	4.4IN.LBS	T00-06P05

Torque and fixed keys, see page 894

Square shoulder and slot milling cutters

Helical milling cutters

Face milling cutters

Disc milling cutters

High feed milling cutters

Copy milling cutters

Plunge milling cutters

Chamfer milling cutters

Spot facing cutters

Inserts

R217/220.69-06 – Insert selection – mm/Inch

SMG		a_p	f_z		
			100%	30%	10%
P1	XOMX060204R-M05 F40M	2,5	0,070	0,075	0,12
		0.10	0.0028	0.0030	0.0048
P2	XOMX060204R-M05 F40M	2,5	0,070	0,080	0,12
		0.10	0.0028	0.0032	0.0048
P3	XOMX060204R-M05 F40M	2,5	0,070	0,075	0,11
		0.10	0.0028	0.0030	0.0044
P4	XOMX060204R-M05 F40M	2,5	0,065	0,075	0,11
		0.10	0.0026	0.0030	0.0044
P5	XOMX060204R-M05 F40M	2,5	0,065	0,070	0,11
		0.10	0.0026	0.0028	0.0044
P6	XOMX060204R-M05 F40M	2,5	0,065	0,070	0,11
		0.10	0.0026	0.0028	0.0044
P7	XOMX060204R-M05 F40M	2,5	0,065	0,070	0,11
		0.10	0.0026	0.0028	0.0044
P8	XOMX060204R-M05 F40M	2,5	0,070	0,075	0,11
		0.10	0.0028	0.0030	0.0044
P11	XOMX060204R-M05 MP3000	2,5	0,065	0,070	0,11
		0.10	0.0026	0.0028	0.0044
P12	XOMX060204R-M05 MP3000	2,0	0,046	0,050	0,075
		0.080	0.0018	0.0020	0.0030
M1	XOMX060204R-M05 F40M	2,5	0,070	0,080	0,12
		0.10	0.0028	0.0032	0.0048
M2	XOMX060204R-M05 F40M	2,5	0,065	0,070	0,11
		0.10	0.0026	0.0028	0.0044
M3	XOMX060204R-M05 F40M	2,0	0,055	0,060	0,090
		0.080	0.0022	0.0024	0.0036
M4	XOMX060204R-M05 MP3000	1,5	0,048	0,050	0,075
		0.060	0.0019	0.0020	0.0030
M5	XOMX060204R-M05 MM4500	1,5	0,048	0,050	0,075
		0.060	0.0019	0.0020	0.0030
K1	XOMX060204R-M05 MP3000	2,5	0,070	0,080	0,12
		0.10	0.0028	0.0032	0.0048
K2	XOMX060204R-M05 MP3000	2,5	0,065	0,070	0,11
		0.10	0.0026	0.0028	0.0044
K3	XOMX060204R-M05 MP3000	2,5	0,065	0,070	0,11
		0.10	0.0026	0.0028	0.0044
K4	XOMX060204R-M05 MP3000	2,5	0,065	0,070	0,11
		0.10	0.0026	0.0028	0.0044
K5	XOMX060204R-M05 MP3000	2,5	0,060	0,065	0,10
		0.10	0.0024	0.0026	0.0040
K6	XOMX060204R-M05 MP3000	2,5	0,065	0,070	0,11
		0.10	0.0026	0.0028	0.0044
K7	XOMX060204R-M05 MP3000	2,5	0,060	0,065	0,10
		0.10	0.0024	0.0026	0.0040
N1	XOEX060204FR-E03 H15	2,5	0,075	0,080	0,12
		0.10	0.0030	0.0032	0.0048
N2	XOEX060204FR-E03 H15	2,5	0,075	0,080	0,12
		0.10	0.0030	0.0032	0.0048
N3	XOEX060204FR-E03 H15	2,5	0,075	0,080	0,12
		0.10	0.0030	0.0032	0.0048
N11	XOEX060204FR-E03 H15	2,5	0,075	0,080	0,12
		0.10	0.0030	0.0032	0.0048
S1	XOMX060204R-M05 F40M	1,5	0,048	0,050	0,075
		0.060	0.0019	0.0020	0.0030
S2	XOMX060204R-M05 F40M	1,5	0,048	0,050	0,075
		0.060	0.0019	0.0020	0.0030
S3	XOMX060204R-M05 F40M	1,5	0,044	0,048	0,070
		0.060	0.0017	0.0019	0.0028
S11	XOMX060204R-M05 MS2050	1,7	0,055	0,060	0,090
		0.065	0.0022	0.0024	0.0036
S12	XOMX060204R-M05 MS2050	1,7	0,055	0,060	0,090
		0.065	0.0022	0.0024	0.0036
S13	XOMX060208R-M05 MS2050	1,5	0,050	0,055	0,080
		0.060	0.0020	0.0022	0.0032
H5	XOMX060204R-M05 MP3000	2,0	0,046	0,050	0,075
		0.080	0.0018	0.0020	0.0030
H8	XOMX060204R-M05 MP3000	1,7	0,034	0,038	0,055
		0.065	0.0013	0.0015	0.0022
H11	XOMX060204R-M05 MP3000	2,0	0,046	0,050	0,075
		0.080	0.0018	0.0020	0.0030
H12	XOMX060204R-M05 MP3000	1,7	0,034	0,038	0,055
		0.065	0.0013	0.0015	0.0022

SMG = Seco material group
 f_z = mm/tooth (in/tooth), v_c = m/min (sf/min), a_p/DC = %
 All cutting data are start values

R217/220.69-06 – Cutting data $v_c = (m/min)/(sf/min)$

SMG	MP3000			MM4500			MS2050			F30M			F40M			H15		
	100%	30%	10%	100%	30%	10%	100%	30%	10%	100%	30%	10%	100%	30%	10%	100%	30%	10%
P1	340	450	520	220	290	340	300	395	460	285	375	440	275	360	420	—	—	—
	1125	1475	1700	720	950	1125	980	1300	1500	940	1225	1450	900	1175	1375	—	—	—
P2	330	430	510	215	280	330	290	380	450	280	360	425	265	345	405	—	—	—
	1075	1400	1675	710	920	1075	950	1250	1475	920	1175	1400	870	1125	1325	—	—	—
P3	285	375	445	185	245	290	250	330	390	240	315	375	230	300	355	—	—	—
	940	1225	1450	610	800	950	820	1075	1275	790	1025	1225	750	980	1175	—	—	—
P4	255	330	395	165	215	255	225	290	345	215	280	330	205	265	315	—	—	—
	840	1075	1300	540	710	840	740	950	1125	710	920	1075	670	870	1025	—	—	—
P5	245	320	375	160	210	245	215	280	330	205	270	315	195	255	300	—	—	—
	800	1050	1225	520	690	800	710	920	1075	670	890	1025	640	840	980	—	—	—
P6	275	360	420	180	235	275	240	315	370	230	305	355	220	290	335	—	—	—
	900	1175	1375	590	770	900	790	1025	1225	750	1000	1175	720	950	1100	—	—	—
P7	260	340	395	170	220	260	230	300	350	215	285	335	205	270	320	—	—	—
	850	1125	1300	560	720	850	750	980	1150	710	940	1100	670	890	1050	—	—	—
P8	240	315	375	155	205	245	210	280	330	200	265	315	190	255	300	—	—	—
	790	1025	1225	510	670	800	690	920	1075	660	870	1025	620	840	980	—	—	—
P11	250	330	385	165	215	250	220	290	340	210	275	325	200	265	310	—	—	—
	820	1075	1275	540	710	820	720	950	1125	690	900	1075	660	870	1025	—	—	—
P12	160	210	245	105	135	160	140	185	215	135	175	205	130	170	195	—	—	—
	520	690	800	345	445	520	460	610	710	445	570	670	425	560	640	—	—	—
M1	250	320	380	185	240	285	235	305	360	225	290	345	215	280	330	—	—	—
	820	1050	1250	610	790	940	770	1000	1175	740	950	1125	710	920	1075	—	—	—
M2	205	270	315	150	200	235	195	255	295	185	245	285	175	230	270	—	—	—
	670	890	1025	490	660	770	640	840	970	810	1000	1125	750	980	1125	—	—	—
M3	160	215	250	120	160	185	155	200	235	145	195	225	140	185	215	—	—	—
	520	710	820	395	520	610	510	660	770	475	640	740	460	610	710	—	—	—
M4	125	165	195	95	125	145	120	160	185	115	150	175	110	145	165	—	—	—
	410	540	640	310	410	475	395	520	610	375	490	570	360	475	540	—	—	—
M5	105	140	160	80	105	120	100	130	150	95	125	145	90	120	140	—	—	—
	345	460	520	260	345	395	330	425	490	310	410	475	295	395	460	—	—	—
K1	265	340	405	—	—	—	—	—	—	220	285	340	210	275	325	—	—	—
	870	1125	1325	—	—	—	—	—	—	720	940	1125	690	900	1075	—	—	—
K2	230	305	355	—	—	—	—	—	—	195	255	300	185	245	285	—	—	—
	750	1000	1175	—	—	—	—	—	—	640	840	980	610	800	940	—	—	—
K3	195	260	300	—	—	—	—	—	—	165	215	255	155	205	240	—	—	—
	640	850	980	—	—	—	—	—	—	540	710	840	510	670	790	—	—	—
K4	185	245	285	—	—	—	—	—	—	155	205	240	150	195	230	—	—	—
	610	800	940	—	—	—	—	—	—	510	670	790	490	640	750	—	—	—
K5	115	150	175	—	—	—	—	—	—	95	125	145	90	120	140	—	—	—
	375	490	570	—	—	—	—	—	—	310	410	475	295	395	460	—	—	—
K6	165	215	255	—	—	—	—	—	—	140	180	215	130	175	205	—	—	—
	540	710	840	—	—	—	—	—	—	460	590	710	425	570	670	—	—	—
K7	145	190	225	—	—	—	—	—	—	120	160	190	115	150	180	—	—	—
	475	620	740	—	—	—	—	—	—	395	520	620	375	490	590	—	—	—
N1	1950	2575	3025	—	—	—	—	—	—	1650	2150	2550	1575	2050	2425	1650	2175	2575
	6400	8450	9925	—	—	—	—	—	—	5425	7050	8375	5175	6725	7950	5425	7125	8450
N2	790	1025	1225	—	—	—	—	—	—	660	870	1025	630	830	980	670	880	1050
	2600	3375	4025	—	—	—	—	—	—	2175	2850	3375	2075	2725	3225	2200	2875	3450
N3	530	690	820	—	—	—	—	—	—	445	580	690	420	550	650	445	590	690
	1750	2275	2700	—	—	—	—	—	—	1450	1900	2275	1375	1800	2125	1450	1925	2275
N11	600	790	930	—	—	—	—	—	—	510	660	780	480	630	750	510	670	790
	1975	2600	3050	—	—	—	—	—	—	1675	2175	2550	1575	2075	2450	1675	2200	2600
S1	60	80	90	29	38	44	55	75	85	55	70	80	50	65	80	—	—	—
	195	260	295	95	125	145	180	245	280	180	230	260	165	215	260	—	—	—
S2	48	65	70	23	30	35	45	60	70	43	55	65	41	55	60	—	—	—
	155	215	230	75	100	115	150	195	230	140	180	215	135	180	195	—	—	—
S3	42	55	65	20	26	31	39	50	60	38	49	55	36	47	55	—	—	—
	140	180	215	65	85	100	130	165	195	125	160	180	120	155	180	—	—	—
S11	80	110	125	40	55	60	80	100	120	75	100	115	70	95	110	—	—	—
	260	360	410	130	180	195	260	330	395	245	330	375	230	310	360	—	—	—
S12	55	75	85	37	48	55	70	80	90	75	85	95	65	85	95	—	—	—
	180	245	280	120	155	180	180	230	260	140	180	215	160	215	245	—	—	—
S13	33	44	50	22	28	33	31	41	48	25	33	38	29	38	44	—	—	—
	110	145	165	70	90	110	100	135	155	80	110	125	95	125	145	—	—	—
H5	50	65	75	—	—	—	—	—	—	45	60	70	43	55	65	—	—	—
	165	215	245	—	—	—	—	—	—	150	195	230	140	180	215	—	—	—
H8	55	70	80	—	—	—	—	—	—	47	60	70	45	60	70	—	—	—
	180	230	260	—	—	—	—	—	—	155	195	230	150	195	230	—	—	—
H11	65	85	95	—	—	—	—	—	—	55	75	85	55	70	85	—	—	—
	215	280	310	—	—	—	—	—	—	180	245	280	180	230	280	—	—	—
H12	100	130	155	—	—	—	—	—	—	85	110	130	80	105	125	—	—	—
	330	425	510	—	—	—	—	—	—	280	360	425	260	345	410	—	—	—

Square shoulder and slot milling cutters
Helical milling cutters
Face milling cutters
Disc milling cutters
High feed milling cutters
Copy milling cutters
Plunge milling cutters
Chamfer milling cutters
Spot facing cutters
Inserts

Turbo 10 – R217.69-10 – Metric

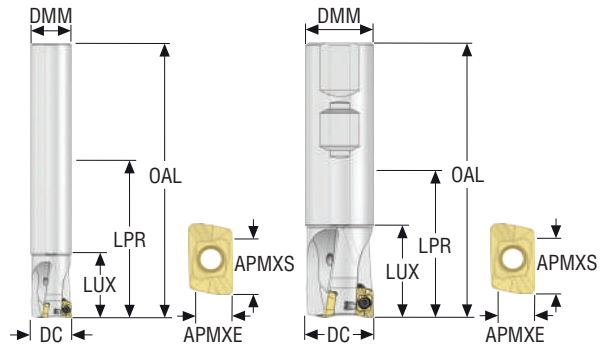

- For insert selection and cutting data recommendations, see page(s) 43-45
- For complete insert programme, see page(s) 867, 868
- For ISO attribute explanation, see page 16
- KAPRS 90°

Designation	Item number	Type of mounting	DC	ZEPF	APMXS	APMXE	DMM	LUX	LPR	OAL	RMPX°	Cmin	Cmax	RPMX	Weight	Insert
			mm		mm	mm	mm	mm	mm	mm		mm	mm		kg	
R217.69-1416.0-10-2A	02772250	Cylindrical	16,0	2	9,0	6,0	14,0	112,0	112,0	160,0	7,5	21,0	30,5	29400	0,2	XO.X10..
R217.69-1616.0-10-2A	02769179	Cylindrical	16,0	2	9,0	6,0	16,0	30,0	87,0	135,0	7,5	21,0	30,5	29400	0,3	XO.X10..
R217.69-1618.0-10-2A	02772252	Cylindrical	18,0	2	9,0	6,0	16,0	112,0	112,0	160,0	6,0	25,0	34,5	27800	0,3	XO.X10..
R217.69-1820.0-10-2A	02769205	Cylindrical	20,0	2	9,0	6,0	18,0	150,0	150,0	200,0	4,5	29,0	38,5	26300	0,4	XO.X10..
R217.69-2020.0-10-2A	02769206	Cylindrical	20,0	2	9,0	6,0	20,0	35,0	100,0	150,0	4,5	29,0	38,5	26300	0,4	XO.X10..
R217.69-2020.0-10-3A	02769209	Cylindrical	20,0	3	9,0	6,0	20,0	35,0	100,0	150,0	4,5	29,0	38,5	26300	0,4	XO.X10..
R217.69-2225.0-10-3A	02772253	Cylindrical	25,0	3	9,0	6,0	22,0	150,0	150,0	200,0	3,0	39,0	48,5	23500	0,6	XO.X10..
R217.69-2525.0-10-3A	02769218	Cylindrical	25,0	3	9,0	6,0	25,0	40,0	114,0	170,0	3,0	39,0	48,5	23500	0,6	XO.X10..
R217.69-2525.0-10-4A	02769224	Cylindrical	25,0	4	9,0	6,0	25,0	40,0	114,0	170,0	3,0	39,0	48,5	23500	0,6	XO.X10..
R217.69-3232.0-10-3A	02769230	Cylindrical	32,0	3	9,0	6,0	32,0	40,0	135,0	195,0	2,0	53,0	62,5	20800	1,1	XO.X10..
R217.69-3232.0-10-5A	02769231	Cylindrical	32,0	5	9,0	6,0	32,0	40,0	135,0	195,0	2,0	53,0	62,5	20800	1,1	XO.X10..
R217.69-1616.3-10-2A	02769180	Weldon	16,0	2	9,0	6,0	16,0	24,0	30,0	78,0	7,5	21,0	30,5	29400	0,1	XO.X10..
R217.69-2018.3-10-2A	02772254	Weldon	18,0	2	9,0	6,0	20,0	29,0	30,0	85,0	6,0	25,0	34,5	27800	0,2	XO.X10..
R217.69-2020.3-10-2A	02769210	Weldon	20,0	2	9,0	6,0	20,0	29,0	40,0	90,0	4,5	29,0	38,5	26300	0,2	XO.X10..
R217.69-2020.3-10-3A	02769212	Weldon	20,0	3	9,0	6,0	20,0	29,0	40,0	90,0	4,5	29,0	38,5	26300	0,3	XO.X10..
R217.69-2525.3-10-3A	02769225	Weldon	25,0	3	9,0	6,0	25,0	34,0	45,0	101,0	3,0	39,0	48,5	23500	0,4	XO.X10..
R217.69-2525.3-10-4A	02769227	Weldon	25,0	4	9,0	6,0	25,0	34,0	45,0	101,0	3,0	39,0	48,5	23500	0,3	XO.X10..
R217.69-3232.3-10-3A	02769232	Weldon	32,0	3	9,0	6,0	32,0	35,0	45,0	110,0	2,0	53,0	62,5	20800	0,6	XO.X10..
R217.69-3232.3-10-5A	02769233	Weldon	32,0	5	9,0	6,0	32,0	35,0	45,0	110,0	2,0	53,0	62,5	20800	0,6	XO.X10..

Modification of the cutter body needed for radii > 2,4 mm

Spare Parts, included in delivery

For cutter	Insert key	Insert screw
R217.69-..	H4B-T07P	C02506-T07P

Accessories

For cutter	Insert clamping torque	Torque key
R217.69-..	0.9NM	T00-07P09

Torque and fixed keys, see page 894

Turbo 10 – R217.69-10 – inch

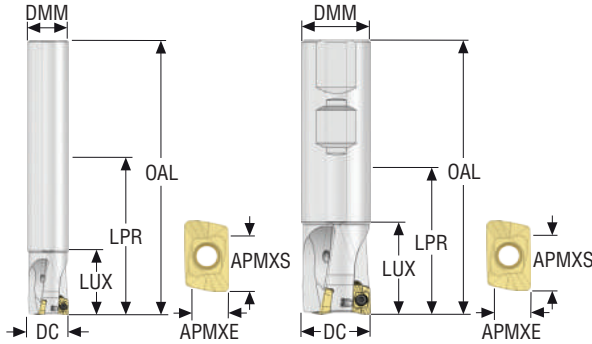

- For insert selection and cutting data recommendations, see page(s) 43-45
- For complete insert programme, see page(s) 867, 868
- For ISO attribute explanation, see page 16
- KAPRS 90°

Designation	Item number	Type of mounting	DC	ZEFP	APMXS	APMXE	DMM	LUX	LPR	OAL	RMPX°	C min	C max	RPMX	Weight	Insert
			inch		inch	inch	inch	inch	inch	inch		inch	inch		lbs	
R217.69-00.62-0-10-2A	02772633	Cylindrical	0.625	2	0.354	0.236	0.625	1.083	3.425	5.315	7,5	0.807	1.181	29400	0.440	XO.X10..
R217.69-00.75-0-10-2A	02772636	Cylindrical	0.750	2	0.354	0.236	0.750	1.181	3.937	5.906	5,0	1.063	1.437	26300	0.660	XO.X10..
R217.69-00.87-0-10-3A	02772719	Cylindrical	0.875	3	0.354	0.236	0.750	3.937	3.937	5.906	5,0	1.299	1.673	26300	0.660	XO.X10..
R217.69-01.00-0-10-3A	02772707	Cylindrical	1.000	3	0.354	0.236	1.000	1.280	4.488	6.693	3,0	1.555	1.929	23500	1.320	XO.X10..
R217.69-01.00-0-10-4A	02772710	Cylindrical	1.000	4	0.354	0.236	1.000	1.280	4.488	6.693	3,0	1.555	1.929	23500	1.320	XO.X10..
R217.69-01.25-0-10-5A	02772728	Cylindrical	1.250	5	0.354	0.236	1.250	1.240	5.315	7.677	2,0	2.067	2.441	20800	2.430	XO.X10..
R217.69-01.50-0-10-4A	02773425	Cylindrical	1.500	4	0.354	0.236	1.250	5.315	5.315	7.677	1,5	2.559	2.933	18600	2.650	XO.X10..
R217.69-00.50-3-10-1A	03058730	Weldon	0.500	1	0.354	0.236	0.625	1.083	1.378	3.252	3,0	1.516	1.890	33100	0.220	XO.X10..
R217.69-00.62-3-10-2A	02772634	Weldon	0.625	2	0.354	0.236	0.625	1.083	1.362	3.252	7,5	0.827	1.201	29400	0.220	XO.X10..
R217.69-00.75-3-10-2A	02772637	Weldon	0.750	2	0.354	0.236	0.750	1.189	1.374	3.390	5,0	1.063	1.437	26300	0.440	XO.X10..
R217.69-00.750-3-10-3A	02903111	Weldon	0.750	3	0.354	0.236	0.750	1.189	1.575	3.390	4,5	1.083	1.457	26300	0.440	XO.X10..
R217.69-00.87-3-10-3A	02772720	Weldon	0.875	3	0.354	0.236	0.750	1.421	1.421	3.390	5,0	1.319	1.693	25000	0.440	XO.X10..
R217.69-01.00-3-10-3A	02772711	Weldon	1.000	3	0.354	0.236	1.000	1.280	1.575	3.780	3,0	1.575	1.949	23500	0.660	XO.X10..
R217.69-01.00-3-10-4A	02772713	Weldon	1.000	4	0.354	0.236	1.000	1.280	1.575	3.780	3,0	1.575	1.949	23500	0.660	XO.X10..
R217.69-01.25-3-10-5A	02772731	Weldon	1.250	5	0.354	0.236	1.250	1.240	1.736	4.000	2,0	2.067	2.441	20800	1.320	XO.X10..
R217.69-01.50-3-10-4A	02773428	Weldon	1.500	4	0.354	0.236	1.250	1.736	1.736	4.000	1,5	2.579	2.953	18600	1.320	XO.X10..

Modification of the cutter body needed for radii > 0.094 in

Spare Parts, included in delivery

For cutter	Insert key	Insert screw
R217.69-..	H4B-T07P	C02506-T07P

Accessories

For cutter	Insert clamping torque	Torque key
R217.69-..	8.0IN.LBS	T00-07P09

Torque and fixed keys, see page 894

Turbo 10 – R217/220.69-10 – Metric

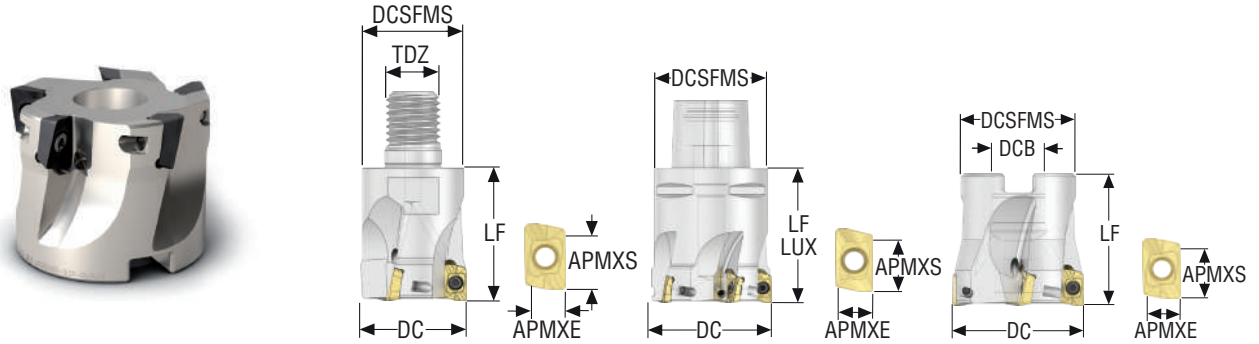



- For insert selection and cutting data recommendations, see page(s) 43-45
- For complete insert programme, see page(s) 867, 868
- For ISO attribute explanation, see page 16
- KAPRS 90°



Designation	Item number	Type of mounting	DC	ZEFP	APMXS		DCB	TDZ	DCSFMS	LUX	LF	RMPX°	Cmin	Cmax	RPMX	Weight	Insert
					mm	mm											
R217.69-0816.RE-10-2A	02769181	Combimaster	16,0	2	9,0	6,0	–	M8	14,0	–	23,0	7,5	21,0	30,5	29400	0,1	XO.X10..
R217.69-1020.RE-10-2A	02769213	Combimaster	20,0	2	9,0	6,0	–	M10	19,0	–	28,0	4,5	29,0	38,5	26300	0,1	XO.X10..
R217.69-1020.RE-10-3A	02769214	Combimaster	20,0	3	9,0	6,0	–	M10	19,0	–	28,0	4,5	29,0	38,5	26300	0,1	XO.X10..
R217.69-1225.RE-10-3A	02769228	Combimaster	25,0	3	9,0	6,0	–	M12	23,0	–	30,0	3,0	39,0	48,5	23500	0,2	XO.X10..
R217.69-1225.RE-10-4A	02769229	Combimaster	25,0	4	9,0	6,0	–	M12	23,0	–	30,0	3,0	39,0	48,5	23500	0,1	XO.X10..
R217.69-1632.RE-10-3A	02769234	Combimaster	32,0	3	9,0	6,0	–	M16	30,0	–	40,0	2,0	53,0	62,5	20800	0,2	XO.X10..
R217.69-1632.RE-10-5A	02769235	Combimaster	32,0	5	9,0	6,0	–	M16	30,0	–	40,0	2,0	53,0	62,5	20800	0,2	XO.X10..
R217.69-2040.RE-10-4A	02769295	Combimaster	40,0	4	9,0	6,0	–	M20	36,5	–	40,0	1,5	69,0	78,5	18600	0,4	XO.X10..
R217.69-2040.RE-10-6A	02769296	Combimaster	40,0	6	9,0	6,0	–	M20	36,5	–	40,0	1,5	69,0	78,5	18600	0,4	XO.X10..
C4-R217.69-044-10-4A	02824179	Seco-Capto	44,0	4	9,0	6,0	–	–	40,0	60,0	60,0	1,3	77,0	86,5	28000	0,6	XO.X10..
C5-R217.69-054-10-5A	02824181	Seco-Capto	54,0	5	9,0	6,0	–	–	50,0	60,0	60,0	1,2	97,0	106,5	14200	0,9	XO.X10..
R220.69-0032-10-4A	02840940	Arbor	32,0	4	9,0	6,0	16,0	–	30,0	–	35,0	2,0	53,0	62,5	20800	0,2	XO.X10..
R220.69-0032-10-5A	02841295	Arbor	32,0	5	9,0	6,0	16,0	–	30,0	–	35,0	2,0	53,0	62,5	20800	0,2	XO.X10..
R220.69-0040-10-4A	02769302	Arbor	40,0	4	9,0	6,0	16,0	–	35,0	–	40,0	1,5	69,0	78,5	18600	0,3	XO.X10..
R220.69-0040-10-6A	02769304	Arbor	40,0	6	9,0	6,0	16,0	–	35,0	–	40,0	1,5	69,0	78,5	18600	0,3	XO.X10..
R220.69-0044-10-4A	02969079	Arbor	44,0	4	9,0	6,0	16,0	–	35,0	–	40,0	1,3	77,0	86,5	18600	0,3	XO.X10..
R220.69-0050-10-5A	02769710	Arbor	50,0	5	9,0	6,0	22,0	–	47,0	–	40,0	1,2	89,0	98,5	16600	0,5	XO.X10..
R220.69-0050-10-7A	02769713	Arbor	50,0	7	9,0	6,0	22,0	–	47,0	–	40,0	1,2	89,0	98,5	16600	0,4	XO.X10..
R220.69-0052-10-5A	02969080	Arbor	52,0	5	9,0	6,0	22,0	–	47,0	–	40,0	1,2	93,0	102,5	16400	0,4	XO.X10..
R220.69-0063-10-5A	02770205	Arbor	63,0	5	9,0	6,0	27,0	–	52,0	–	40,0	0,9	115,0	124,5	14800	0,6	XO.X10..
R220.69-0063-10-8A	02770206	Arbor	63,0	8	9,0	6,0	27,0	–	52,0	–	40,0	0,9	115,0	124,5	14800	0,6	XO.X10..
R220.69-0066-10-5A	02969081	Arbor	66,0	5	9,0	6,0	27,0	–	52,0	–	40,0	0,9	121,0	130,5	14800	0,7	XO.X10..
R220.69-0080-10-8A	02770207	Arbor	80,0	8	9,0	6,0	27,0	–	62,0	–	50,0	0,5	149,0	158,5	13200	1,1	XO.X10..
R220.69-0080-10-10A	02770208	Arbor	80,0	10	9,0	6,0	27,0	–	62,0	–	50,0	0,5	149,0	158,5	13200	1,1	XO.X10..
R220.69-0100-10-12A	02770209	Arbor	100,0	12	9,0	6,0	32,0	–	77,0	–	50,0	0,5	189,0	198,5	11800	1,8	XO.X10..

Modification of the cutter body needed for radii > 2,4 mm
For Combimaster Shanks, see Machining Navigator Tooling System

Spare Parts, included in delivery

For cutter	Arbor screw	Insert key	Insert screw
Cx/R217.69/R220.69-0080-0100			
R220.69-0032	220.17-690	H4B-T07P	C02506-T07P
R220.69-0040-0044	MC6S8X30	H4B-T07P	C02506-T07P
R220.69-0050-0052	220.17-692	H4B-T07P	C02506-T07P
R220.69-0063-0066	220.17-693	H4B-T07P	C02506-T07P

Accessories

For cutter	Insert clamping torque	Torque key
Cx-R217/220.69-...		
	0.9NM	T00-07P09

Torque and fixed keys, see page 894

- Square shoulder and slot milling cutters
- Helical milling cutters
- Face milling cutters
- Disc milling cutters
- High feed milling cutters
- Copy milling cutters
- Plunge milling cutters
- Chamfer milling cutters
- Spot facing cutters
- Inserts

Turbo 10 – R217/220.69-10 – Inch

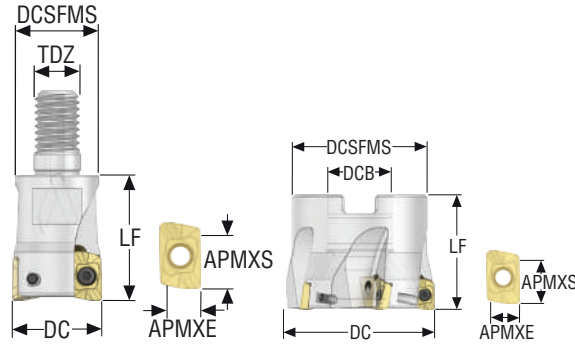



- For insert selection and cutting data recommendations, see page(s) 43-45
- For complete insert programme, see page(s) 867, 868
- For ISO attribute explanation, see page 16
- KAPRS 90°

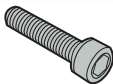

Designation	Item number	Type of mounting	DC	ZEFP	APMXS	APMXE	DCB	TDZ	DCSFMS	LF	RMPX°	C min	C max	RPMX	Weight	Insert
			inch		inch	inch	inch		inch	inch		inch	inch		lbs	
R217.69-00.62-08RE-10-2A	02772627	Combimaster	0.625	2	0.354	0.236	–	M8	0.531	0.906	7.5	0.807	1.181	29400	0.220	XO.X10
R217.69-00.75-10RE-10-2A	02772635	Combimaster	0.750	2	0.354	0.236	–	M10	0.728	1.378	5.0	1.063	1.437	26300	0.220	XO.X10
R217.69-01.00-12RE-10-3A	02772703	Combimaster	1.000	3	0.354	0.236	–	M12	0.906	1.575	2.5	1.555	1.929	23500	0.440	XO.X10
R217.69-01.00-12RE-10-4A	02772705	Combimaster	1.000	4	0.354	0.236	–	M12	0.906	1.575	2.5	1.555	1.929	23500	0.440	XO.X10
R217.69-01.25-16RE-10-5A	02772725	Combimaster	1.250	5	0.354	0.236	–	M16	1.181	1.575	1.5	2.067	2.441	20800	0.440	XO.X10
R217.69-01.50-20RE-10-6A	03170244	Combimaster	1.500	6	0.354	0.236	–	M20	1.457	1.575	1.5	2.559	2.933	18600	0.880	XO.X10
R220.69-01.50-10-4A	02773432	Arbor	1.500	4	0.354	0.236	0.750	–	1.378	1.575	1.5	2.559	2.933	18600	0.440	XO.X10
R220.69-01.50-10-6A	02773433	Arbor	1.500	6	0.354	0.236	0.750	–	1.378	1.575	1.5	2.559	2.933	18600	0.440	XO.X10
R220.69-02.00-10-5A	02773434	Arbor	2.000	5	0.354	0.236	0.750	–	1.850	1.575	1.0	3.563	3.937	16600	0.880	XO.X10
R220.69-02.00-10-7A	02773435	Arbor	2.000	7	0.354	0.236	0.750	–	1.850	1.575	1.0	3.563	3.937	16600	0.880	XO.X10
R220.69-03.00-10-10A	02773438	Arbor	3.000	10	0.354	0.236	1.000	–	2.441	1.969	0.5	5.551	5.925	13200	2.430	XO.X10

Modification of the cutter body needed for radii > 0.094 in
For Combimaster Shanks, see Machining Navigator Tooling System

Spare Parts, included in delivery

For cutter	Arbor screw	Insert key	Insert screw
R217.69-..			
R217.69-..	–	H4B-T07P	C02506-T07P
R220.69-01.50 - 02.50	UC6S3/8UNFX1	H4B-T07P	C02506-T07P
R220.69-03.00	UC6S1/2UNFX1-1/4	H4B-T07P	C02506-T07P

Accessories

For cutter	Insert clamping torque	Torque key
R217/220.69-..		
R217/220.69-..	8.0IN.LBS	T00-07P09

Torque and fixed keys, see page 894

R217/220.69-10 – Insert selection – mm/Inch

SMG		a _p	f _z		
			100%	30%	10%
P1	XOMX10T308TR-ME07 F40M	4,5	0,10	0,11	0,17
		0.18	0.0040	0.0044	0.0065
P2	XOMX10T308TR-ME07 F40M	4,5	0,10	0,11	0,17
		0.18	0.0040	0.0044	0.0065
P3	XOMX10T308TR-ME07 MP2501	4,5	0,095	0,10	0,16
		0.18	0.0038	0.0040	0.0065
P4	XOMX10T308TR-ME07 MP2501	4,5	0,095	0,10	0,16
		0.18	0.0038	0.0040	0.0065
P5	XOMX10T308TR-M09 MP2501	4,5	0,12	0,13	0,20
		0.18	0.0048	0.0050	0.0080
P6	XOMX10T308TR-M09 MP2501	4,5	0,12	0,13	0,20
		0.18	0.0048	0.0050	0.0080
P7	XOMX10T308TR-M09 MP2501	4,5	0,12	0,13	0,20
		0.18	0.0048	0.0050	0.0080
P8	XOMX10T308TR-M09 MP2501	4,5	0,12	0,13	0,20
		0.18	0.0048	0.0050	0.0080
P11	XOMX10T308TR-M09 T350M	4,5	0,12	0,13	0,20
		0.18	0.0048	0.0050	0.0080
P12	XOMX10T308TR-M09 MS2500	3,5	0,080	0,090	0,13
		0.14	0.0032	0.0036	0.0050
M1	XOEX10T308R-M06 F40M	4,5	0,085	0,095	0,14
		0.18	0.0034	0.0038	0.0055
M2	XOEX10T308R-M06 F40M	4,5	0,080	0,085	0,13
		0.18	0.0032	0.0034	0.0050
M3	XOEX10T308R-M06 F40M	3,5	0,065	0,070	0,11
		0.14	0.0026	0.0028	0.0044
M4	XOEX10T308R-M06 T350M	2,5	0,055	0,060	0,090
		0.10	0.0022	0.0024	0.0036
M5	XOEX10T308R-M06 T350M	2,5	0,055	0,060	0,090
		0.10	0.0022	0.0024	0.0036
K1	XOMX10T308TR-M09 MK2050	4,5	0,13	0,14	0,22
		0.18	0.0050	0.0055	0.0085
K2	XOMX10T308TR-M09 MK2050	4,5	0,12	0,13	0,20
		0.18	0.0048	0.0050	0.0080
K3	XOMX10T308TR-M09 MK2050	4,5	0,12	0,13	0,20
		0.18	0.0048	0.0050	0.0080
K4	XOMX10T308TR-M09 MK2050	4,5	0,12	0,13	0,20
		0.18	0.0048	0.0050	0.0080
K5	XOMX10T308TR-M09 MK2050	4,5	0,11	0,12	0,18
		0.18	0.0044	0.0048	0.0070
K6	XOMX10T308TR-M09 MK2050	4,5	0,12	0,13	0,20
		0.18	0.0048	0.0050	0.0080
K7	XOMX10T308TR-M09 MK2050	4,5	0,11	0,12	0,18
		0.18	0.0044	0.0048	0.0070
N1	XOEX10T308FR-E05 H15	4,5	0,090	0,10	0,15
		0.18	0.0036	0.0040	0.0060
N2	XOEX10T308FR-E05 H15	4,5	0,090	0,10	0,15
		0.18	0.0036	0.0040	0.0060
N3	XOEX10T308FR-E05 H15	4,5	0,090	0,10	0,15
		0.18	0.0036	0.0040	0.0060
N11	XOEX10T308FR-E05 H15	4,5	0,090	0,10	0,15
		0.18	0.0036	0.0040	0.0060
S1	XOEX10T308R-M06 T350M	2,5	0,055	0,060	0,090
		0.10	0.0022	0.0024	0.0036
S2	XOEX10T308R-M06 T350M	2,5	0,055	0,060	0,090
		0.10	0.0022	0.0024	0.0036
S3	XOEX10T308R-M06 T350M	2,5	0,055	0,055	0,085
		0.10	0.0022	0.0022	0.0034
S11	XOEX10T308R-M06 MS2050	3,0	0,065	0,070	0,11
		0.12	0.0026	0.0028	0.0044
S12	XOEX10T308R-M06 MS2050	3,0	0,065	0,070	0,11
		0.12	0.0026	0.0028	0.0044
S13	XOEX10T308R-M06 MS2050	2,5	0,055	0,060	0,090
		0.10	0.0022	0.0024	0.0036
H5	XOMX10T308TR-M09 MP3000	3,5	0,080	0,090	0,13
		0.14	0.0032	0.0036	0.0050
H8	XOMX10T308TR-M09 MP3000	3,0	0,065	0,070	0,10
		0.12	0.0026	0.0028	0.0040
H11	XOMX10T308TR-M09 MP1501	3,5	0,080	0,090	0,13
		0.14	0.0032	0.0036	0.0050
H12	XOMX10T308TR-M09 MP1501	3,0	0,065	0,070	0,10
		0.12	0.0026	0.0028	0.0040

SMG = Seco material group
f_z = mm/tooth (in/tooth), v_c = m/min (sf/min), a_p/DC = %
All cutting data are start values

Square shoulder and slot milling cutters
Helical milling cutters
Face milling cutters
Disc milling cutters
High feed milling cutters
Copy milling cutters
Plunge milling cutters
Chamfer milling cutters
Spot facing cutters
Inserts

R217/220.69-10 – Cutting data $v_c = (m/min)/(sf/min)$

SMG	MP1501			MP2050			MP2501			MP3000			MM4500			MK1500		
	100%	30%	10%	100%	30%	10%	100%	30%	10%	100%	30%	10%	100%	30%	10%	100%	30%	10%
P1	330	435	510	330	430	510	290	385	450	275	365	425	180	235	275	—	—	—
	1075	1425	1675	1075	1400	1675	950	1275	1475	900	1200	1400	590	770	900	—	—	—
P2	320	425	495	320	420	500	285	375	440	270	355	415	175	230	270	—	—	—
	1050	1400	1625	1050	1375	1650	940	1225	1450	890	1175	1350	570	750	890	—	—	—
P3	280	370	435	280	365	430	250	330	385	235	310	365	155	200	240	—	—	—
	920	1225	1425	920	1200	1400	820	1075	1275	770	1025	1200	510	660	790	—	—	—
P4	245	325	385	245	320	385	220	290	340	210	275	325	135	180	210	—	—	—
	800	1075	1275	800	1050	1275	720	950	1125	690	900	1075	445	590	690	—	—	—
P5	235	315	370	235	310	365	210	275	325	200	260	310	130	170	200	—	—	—
	770	1025	1225	770	1025	1200	690	900	1075	660	850	1025	425	560	660	—	—	—
P6	265	350	415	265	350	410	235	310	365	225	295	345	145	190	225	—	—	—
	870	1150	1350	870	1150	1350	770	1025	1200	740	970	1125	475	620	740	—	—	—
P7	250	330	390	250	330	390	220	295	345	210	280	325	135	180	210	—	—	—
	820	1075	1275	820	1075	1275	720	970	1125	690	920	1075	445	590	690	—	—	—
P8	235	315	370	235	310	360	210	275	325	200	260	310	130	170	200	—	—	—
	770	1025	1225	770	1025	1175	690	900	1075	660	850	1025	425	560	660	—	—	—
P11	245	320	380	240	320	375	215	285	335	205	270	315	130	175	205	—	—	—
	800	1050	1250	790	1050	1225	710	940	1100	670	890	1025	425	570	670	—	—	—
P12	160	210	250	155	205	240	140	185	220	135	175	210	85	115	135	—	—	—
	520	690	820	510	670	790	460	610	720	445	570	690	280	375	445	—	—	—
M1	—	—	—	230	300	355	205	270	315	200	265	310	150	200	230	—	—	—
	—	—	—	750	980	1175	670	890	1025	660	870	1025	490	660	750	—	—	—
M2	—	—	—	190	250	295	170	225	260	165	220	260	125	165	190	—	—	—
	—	—	—	620	820	970	560	740	850	540	720	850	410	540	620	—	—	—
M3	—	—	—	150	200	230	140	185	210	135	180	210	100	135	155	—	—	—
	—	—	—	490	660	750	460	610	690	445	590	690	330	445	510	—	—	—
M4	—	—	—	120	155	180	110	140	165	105	140	160	80	105	120	—	—	—
	—	—	—	395	510	590	360	460	540	345	460	520	260	345	395	—	—	—
M5	—	—	—	100	130	150	90	115	135	90	115	135	65	85	100	—	—	—
	—	—	—	330	425	490	295	375	445	295	375	445	215	280	330	—	—	—
K1	255	335	395	255	335	395	225	295	350	210	280	330	—	—	—	320	420	495
	840	1100	1300	840	1100	1300	740	970	1150	690	920	1075	—	—	—	1050	1375	1625
K2	225	295	350	225	295	350	200	265	310	190	250	295	—	—	—	280	370	440
	740	970	1150	740	970	1150	660	870	1025	620	820	970	—	—	—	920	1225	1450
K3	190	250	295	190	250	295	170	220	260	160	210	250	—	—	—	240	315	370
	620	820	970	620	820	970	560	720	850	520	690	820	—	—	—	790	1025	1225
K4	180	240	280	180	240	280	160	210	250	150	200	235	—	—	—	225	300	355
	590	790	920	590	790	920	520	690	820	490	660	770	—	—	—	740	980	1175
K5	110	145	170	110	145	170	100	130	155	95	120	145	—	—	—	140	185	215
	360	475	560	360	475	560	330	425	510	310	395	475	—	—	—	460	610	710
K6	160	210	250	160	210	245	140	185	220	135	175	210	—	—	—	200	265	310
	520	690	820	520	690	800	460	610	720	445	570	690	—	—	—	660	870	1025
K7	140	185	220	140	185	220	125	165	195	120	155	185	—	—	—	175	235	275
	460	610	720	460	610	720	410	540	640	395	510	610	—	—	—	570	770	900
N1	—	—	—	—	—	—	—	—	—	1550	2075	2450	—	—	—	—	—	—
	—	—	—	—	—	—	—	—	—	5075	6800	8050	—	—	—	—	—	—
N2	—	—	—	—	—	—	—	—	—	630	840	980	—	—	—	—	—	—
	—	—	—	—	—	—	—	—	—	2075	2750	3225	—	—	—	—	—	—
N3	—	—	—	—	—	—	—	—	—	420	560	660	—	—	—	—	—	—
	—	—	—	—	—	—	—	—	—	1375	1825	2175	—	—	—	—	—	—
N11	—	—	—	—	—	—	—	—	—	480	640	750	—	—	—	—	—	—
	—	—	—	—	—	—	—	—	—	1575	2100	2450	—	—	—	—	—	—
S1	—	—	—	60	75	90	55	70	80	50	65	75	24	31	37	—	—	—
	—	—	—	195	245	295	180	230	260	165	215	245	80	100	120	—	—	—
S2	—	—	—	47	60	70	42	55	65	40	50	60	19	25	29	—	—	—
	—	—	—	155	195	230	140	180	215	130	165	195	60	80	95	—	—	—
S3	—	—	—	41	55	60	37	49	55	35	46	55	17	22	26	—	—	—
	—	—	—	135	180	195	120	160	180	115	150	180	55	70	85	—	—	—
S11	—	—	—	80	105	125	75	95	110	70	90	105	34	45	50	—	—	—
	—	—	—	260	345	410	245	310	360	230	295	345	110	150	165	—	—	—
S12	—	—	—	55	75	85	50	65	75	48	65	75	31	41	47	—	—	—
	—	—	—	180	245	280	165	215	245	155	215	245	100	135	155	—	—	—
S13	—	—	—	33	43	50	30	38	45	28	36	42	18	24	27	—	—	—
	—	—	—	110	140	165	100	125	150	90	120	140	60	80	90	—	—	—
H5	55	70	80	47	60	70	43	55	65	42	55	65	—	—	—	—	—	—
	180	230	260	155	195	230	140	180	215	140	180	215	—	—	—	—	—	—
H8	55	75	85	50	65	75	45	60	70	44	60	70	—	—	—	—	—	—
	180	245	280	165	215	245	150	195	230	145	195	230	—	—	—	—	—	—
H11	70	90	105	60	80	90	55	70	85	55	70	80	—	—	—	—	—	—
	230	295	345	195	260	295	180	230	280	180	230	260	—	—	—	—	—	—
H12	100	135	155	100	130	150	90	120	140	85	110	130	—	—	—	—	—	—
	330	445	510	330	425	490	295	395	460	280	360	425	—	—	—	—	—	—

R217/220.69-10 – Cutting data $v_c = (m/min)/(sf/min)$

SMG	MK2050			MS2050			MS2500			T350M			F40M			H15		
	100%	30%	10%	100%	30%	10%	100%	30%	10%	100%	30%	10%	100%	30%	10%	100%	30%	10%
P1	285	380	445	280	365	435	365	480	570	255	335	395	220	290	340	—	—	—
	940	1250	1450	920	1200	1425	1200	1575	1875	840	1100	1300	720	950	1125	—	—	—
P2	280	370	435	270	355	425	355	465	550	245	325	385	215	285	335	—	—	—
	920	1225	1425	890	1175	1400	1175	1525	1800	800	1075	1275	710	940	1100	—	—	—
P3	245	325	380	240	310	365	310	405	475	215	285	340	190	250	295	—	—	—
	800	1075	1250	790	1025	1200	1025	1325	1550	710	940	1125	620	820	970	—	—	—
P4	215	285	335	210	275	325	275	360	425	190	255	295	165	220	260	—	—	—
	710	940	1100	690	900	1075	900	1175	1400	620	840	970	540	720	850	—	—	—
P5	205	275	320	200	265	310	260	345	405	180	240	285	160	210	245	—	—	—
	670	900	1050	660	870	1025	850	1125	1325	590	790	940	520	690	800	—	—	—
P6	230	305	360	225	295	350	295	390	455	205	270	320	180	235	275	—	—	—
	750	1000	1175	740	970	1150	970	1275	1500	670	890	1050	590	770	900	—	—	—
P7	220	290	340	210	280	330	275	365	430	195	255	300	170	220	260	—	—	—
	720	950	1125	690	920	1075	900	1200	1400	640	840	980	560	720	850	—	—	—
P8	205	275	320	200	260	305	260	340	400	180	240	285	160	210	245	—	—	—
	670	900	1050	660	850	1000	850	1125	1300	590	790	940	520	690	800	—	—	—
P11	210	280	330	205	270	320	270	355	420	190	250	290	165	215	255	—	—	—
	690	920	1075	670	890	1050	890	1175	1375	620	820	950	540	710	840	—	—	—
P12	140	180	215	135	175	205	175	225	265	125	160	190	110	140	165	—	—	—
	460	590	710	445	570	670	570	740	870	410	520	620	360	460	540	—	—	—
M1	—	—	—	220	285	340	255	335	395	190	250	295	175	230	270	—	—	—
	—	—	—	720	940	1125	840	1100	1300	620	820	970	570	750	890	—	—	—
M2	—	—	—	180	240	280	210	275	325	155	210	245	145	190	220	—	—	—
	—	—	—	590	790	920	690	900	1075	510	690	800	475	620	720	—	—	—
M3	—	—	—	145	190	220	170	220	255	130	170	195	115	155	180	—	—	—
	—	—	—	475	620	720	560	720	840	425	560	640	375	510	590	—	—	—
M4	—	—	—	115	150	175	135	175	200	100	130	150	90	120	140	—	—	—
	—	—	—	375	490	570	445	570	660	330	425	490	295	395	460	—	—	—
M5	—	—	—	95	125	145	110	145	165	85	110	125	75	100	115	—	—	—
	—	—	—	310	410	475	360	475	540	280	360	410	245	330	375	—	—	—
K1	300	400	465	—	—	—	—	—	—	195	260	305	—	—	—	—	—	—
	980	1300	1525	—	—	—	—	—	—	640	850	1000	—	—	—	—	—	—
K2	265	355	415	—	—	—	—	—	—	175	230	270	—	—	—	—	—	—
	870	1175	1350	—	—	—	—	—	—	570	750	890	—	—	—	—	—	—
K3	225	300	350	—	—	—	—	—	—	145	195	230	—	—	—	—	—	—
	740	980	1150	—	—	—	—	—	—	475	640	750	—	—	—	—	—	—
K4	215	285	335	—	—	—	—	—	—	140	185	220	—	—	—	—	—	—
	710	940	1100	—	—	—	—	—	—	460	610	720	—	—	—	—	—	—
K5	130	175	205	—	—	—	—	—	—	85	110	135	—	—	—	—	—	—
	425	570	670	—	—	—	—	—	—	280	360	445	—	—	—	—	—	—
K6	190	250	295	—	—	—	—	—	—	125	165	190	—	—	—	—	—	—
	620	820	970	—	—	—	—	—	—	410	540	620	—	—	—	—	—	—
K7	170	220	260	—	—	—	—	—	—	110	145	170	—	—	—	—	—	—
	560	720	850	—	—	—	—	—	—	360	475	560	—	—	—	—	—	—
N1	—	—	—	—	—	—	—	—	—	—	—	—	1250	1650	1950	1525	2000	2350
	—	—	—	—	—	—	—	—	—	—	—	—	4100	5425	6400	5000	6550	7700
N2	—	—	—	—	—	—	—	—	—	—	—	—	500	670	790	610	800	950
	—	—	—	—	—	—	—	—	—	—	—	—	1650	2200	2600	2000	2625	3125
N3	—	—	—	—	—	—	—	—	—	—	—	—	335	445	530	410	540	630
	—	—	—	—	—	—	—	—	—	—	—	—	1100	1450	1750	1350	1775	2075
N11	—	—	—	—	—	—	—	—	—	—	—	—	380	510	600	470	610	720
	—	—	—	—	—	—	—	—	—	—	—	—	1250	1675	1975	1550	2000	2350
S1	—	—	—	55	70	80	65	85	100	47	60	70	43	55	65	—	—	—
	—	—	—	180	230	260	215	280	330	155	195	230	140	180	215	—	—	—
S2	—	—	—	43	55	65	50	70	80	38	50	55	34	45	50	—	—	—
	—	—	—	140	180	215	165	230	260	125	165	180	110	150	165	—	—	—
S3	—	—	—	37	49	55	45	60	70	33	43	50	30	39	46	—	—	—
	—	—	—	120	160	180	150	195	230	110	140	165	100	130	150	—	—	—
S11	—	—	—	75	95	110	90	115	135	65	85	100	60	80	90	—	—	—
	—	—	—	245	310	360	295	375	445	215	280	330	195	260	295	—	—	—
S12	—	—	—	50	65	75	60	80	95	45	60	70	41	55	65	—	—	—
	—	—	—	165	215	245	195	260	310	150	195	230	135	180	215	—	—	—
S13	—	—	—	30	39	45	37	47	55	26	35	40	24	31	36	—	—	—
	—	—	—	100	130	150	120	155	180	85	115	130	80	100	120	—	—	—
H5	—	—	—	—	—	—	—	—	—	41	55	65	36	47	55	—	—	—
	—	—	—	—	—	—	—	—	—	135	180	215	120	155	180	—	—	—
H8	—	—	—	—	—	—	—	—	—	44	55	65	—	—	—	—	—	—
	—	—	—	—	—	—	—	—	—	145	180	215	—	—	—	—	—	—
H11	—	—	—	—	—	—	—	—	—	50	70	80	—	—	—	—	—	—
	—	—	—	—	—	—	—	—	—	165	230	260	—	—	—	—	—	—
H12	—	—	—	—	—	—	110	145	165	80	100	120	70	90	105	—	—	—
	—	—	—	—	—	—	360	475	540	260	330	395	230	295	345	—	—	—

Square shoulder and slot milling cutters
Helical milling cutters
Face milling cutters
Disc milling cutters
High feed milling cutters
Copy milling cutters
Plunge milling cutters
Chamfer milling cutters
Spot facing cutters
Inserts

Turbo 12 – R217.69-12 – Metric

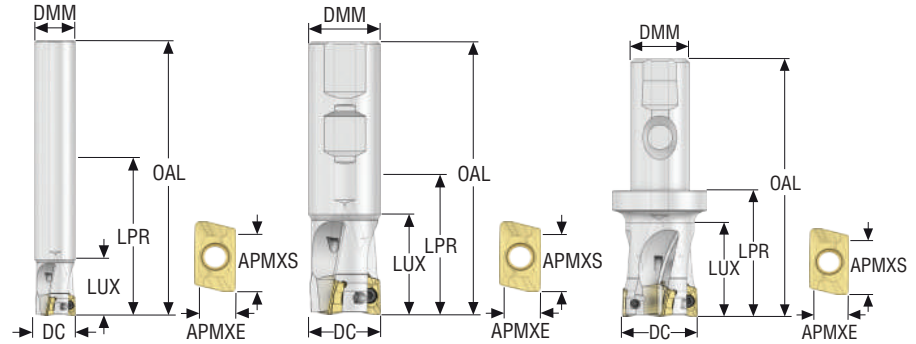

- For insert selection and cutting data recommendations, see page(s) 53-55
- For complete insert programme, see page(s) 869, 870
- For ISO attribute explanation, see page 16
- KAPRS 90°

Designation	Item number	Type of mounting	DC	ZEFP	APMXS	APMXE	DMM	LUX	LPR	OAL	RMPX°	Cmin	Cmax	RPMX	Weight	Insert
			mm		mm	mm	mm	mm	mm	mm		mm	mm		kg	
R217.69-1820.0-12-2AN	02676791	Cylindrical	20,0	2	11,0	7,0	18,0	100,0	100,0	150,0	8,0	27,5	38,0	23200	0,3	XO.X12..
R217.69-2020.0-12-2AN	02676793	Cylindrical	20,0	2	11,0	7,0	20,0	30,0	100,0	150,0	8,0	27,5	38,0	23200	0,4	XO.X12..
R217.69-2225.0-12-2AN	02676794	Cylindrical	25,0	2	11,0	7,0	22,0	114,0	114,0	170,0	5,0	37,5	48,0	20800	0,5	XO.X12..
R217.69-2525.0-12-2AN	02676795	Cylindrical	25,0	2	11,0	7,0	25,0	35,0	114,0	170,0	5,0	37,5	48,0	20800	0,6	XO.X12..
R217.69-2525.0-12-3AN	02676800	Cylindrical	25,0	3	11,0	7,0	25,0	35,0	114,0	170,0	5,0	37,5	48,0	20800	0,6	XO.X12..
R217.69-3032.0-12-3AN	02676801	Cylindrical	32,0	3	11,0	7,0	30,0	135,0	135,0	195,0	3,0	51,5	62,0	18400	1,0	XO.X12..
R217.69-3232.0-12-3AN	02676802	Cylindrical	32,0	3	11,0	7,0	32,0	40,0	135,0	195,0	3,0	51,5	62,0	18400	1,1	XO.X12..
R217.69-3232.0-12-4AN	02676803	Cylindrical	32,0	4	11,0	7,0	32,0	40,0	135,0	195,0	3,0	51,5	62,0	18400	1,1	XO.X12..
R217.69-2020.3-12-2AN	02676817	Weldon	20,0	2	11,0	7,0	20,0	30,0	35,0	85,0	8,0	27,5	38,0	23200	0,2	XO.X12..
R217.69-2525.3-12-3AN	02676819	Weldon	25,0	3	11,0	7,0	25,0	32,0	39,0	95,0	5,0	37,5	48,0	20800	0,4	XO.X12..
R217.69-3232.3-12-3AN	02676820	Weldon	32,0	3	11,0	7,0	32,0	37,0	45,0	105,0	3,0	51,5	62,0	18400	0,6	XO.X12..
R217.69-3232.3-12-4AN	02676823	Weldon	32,0	4	11,0	7,0	32,0	37,0	45,0	105,0	3,0	51,5	62,0	18400	0,6	XO.X12..
R217.69-2025.3S-12-3AN	02676812	Seco-Weldon	25,0	3	11,0	7,0	20,0	36,0	50,0	100,0	5,0	37,5	48,0	20800	0,3	XO.X12..
R217.69-2532.3S-12-4AN	02676814	Seco-Weldon	32,0	4	11,0	7,0	25,0	40,0	54,0	110,0	3,0	51,5	62,0	18400	0,5	XO.X12..
R217.69-3240.3S-12-5AN	02676815	Seco-Weldon	40,0	5	11,0	7,0	32,0	46,0	60,0	120,0	2,5	67,5	78,0	16400	0,8	XO.X12..

Modification of the cutter body needed for radii > 2,4 mm

Spare Parts, included in delivery

For cutter	Insert key	Insert screw
R217.69-.. Ø20-25	H4B-T10P	C03507-T10P
R217.69-.. Ø32	H4B-T10P	C03508-T10P
R217.69-.. Ø40	H4B-T10P	C03509-T10P

Accessories

For cutter	Insert clamping torque	Torque key
R217.69-..	3.0NM	T00-10P30

Torque and fixed keys, see page 894

Turbo 12 – R217.69-12 – inch

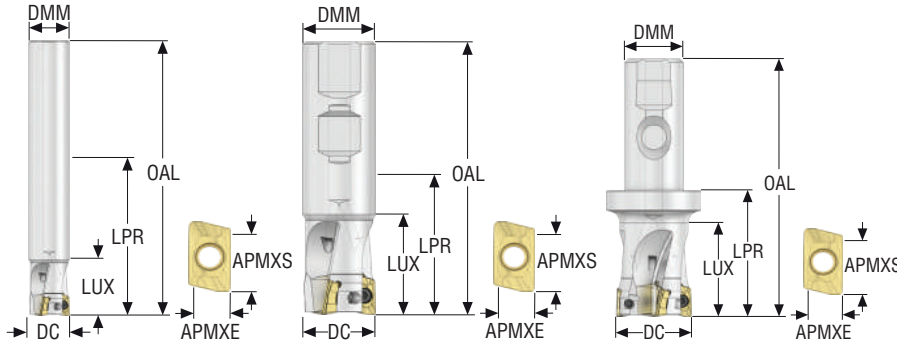

- For insert selection and cutting data recommendations, see page(s) 53-55
- For complete insert programme, see page(s) 869, 870
- For ISO attribute explanation, see page 16
- KAPRS 90°

Designation	Item number	Type of mounting	DC	ZEFP	APMXS	APMXE	DMM	LUX	LPR	OAL	RMPX°	C min	C max	RPMX	Weight	Insert
			inch		inch	inch	inch	inch	inch	inch	inch	inch	inch	inch	lbs	
R217.69-00.75-0-12-2AN	02688842	Cylindrical	0.750	2	0.433	0.276	0.750	1.181	3.937	5.906	8,0	1.004	1.417	23200	0.880	XO.X12
R217.69-00.87-0-12-2AN	02688849	Cylindrical	0.875	2	0.433	0.276	0.750	3.937	3.937	5.906	6,0	1.240	1.654	22000	0.880	XO.X12
R217.69-01.00-0-12-2AN	02688853	Cylindrical	1.000	2	0.433	0.276	1.000	1.378	4.488	6.693	5,0	1.476	1.890	20800	1.540	XO.X12
R217.69-01.00-0-12-3AN	02688854	Cylindrical	1.000	3	0.433	0.276	1.000	1.378	4.488	6.693	5,0	1.476	1.890	20800	1.540	XO.X12
R217.69-01.25-0-12-3AN	02688855	Cylindrical	1.250	3	0.433	0.276	1.250	1.575	5.315	7.677	3,0	1.988	2.421	18400	2.650	XO.X12
R217.69-00.75-3-12-2AN	02688950	Weldon	0.750	2	0.433	0.276	0.750	1.170	1.417	3.378	8,0	1.004	1.417	23200	0.660	XO.X12
R217.69-00.87-3-12-2AN	02688951	Weldon	0.875	2	0.433	0.276	0.750	1.409	1.409	3.378	6,0	1.240	1.654	22000	0.660	XO.X12
R217.69-01.00-3-12-3AN	02688954	Weldon	1.000	3	0.433	0.276	1.000	1.575	1.795	4.000	5,0	1.496	1.909	20800	0.880	XO.X12
R217.69-01.25-3-12-3AN	02688957	Weldon	1.250	3	0.433	0.276	1.250	1.339	1.890	4.252	3,0	2.008	2.421	18400	1.320	XO.X12
R217.69-01.25-3-12-4AN	02688960	Weldon	1.250	4	0.433	0.276	1.250	1.339	1.890	4.252	3,0	2.008	2.421	18400	1.540	XO.X12
R217.69-01.00-3S-12-3AN	02688974	Seco-Weldon	1.000	3	0.433	0.276	0.750	1.480	2.031	4.000	5,0	1.496	1.909	20800	0.880	XO.X12
R217.69-01.25-3S-12-4AN	02688976	Seco-Weldon	1.250	4	0.433	0.276	1.000	1.260	1.811	4.252	3,0	2.008	2.421	18400	1.320	XO.X12
R217.69-01.50-3S-12-5AN	02688996	Seco-Weldon	1.500	5	0.433	0.276	1.250	1.787	2.339	4.780	2,5	2.500	2.913	16400	1.980	XO.X12

Modification of the cutter body needed for radii > 0.094 in

Spare Parts, included in delivery

For cutter	Insert key	Insert screw
R217.69-..	H4B-T10P	C03507-T10P

Accessories

For cutter	Insert clamping torque	Torque key
R217.69-..	26.6IN.LBS	T00-10P30

Torque and fixed keys, see page 894

Square shoulder and slot milling cutters
Helical milling cutters
Face milling cutters
Disc milling cutters
High feed milling cutters
Copy milling cutters
Plunge milling cutters
Chamfer milling cutters
Spot facing cutters
Inserts

Turbo 12 – R217/220.69-12 – Metric

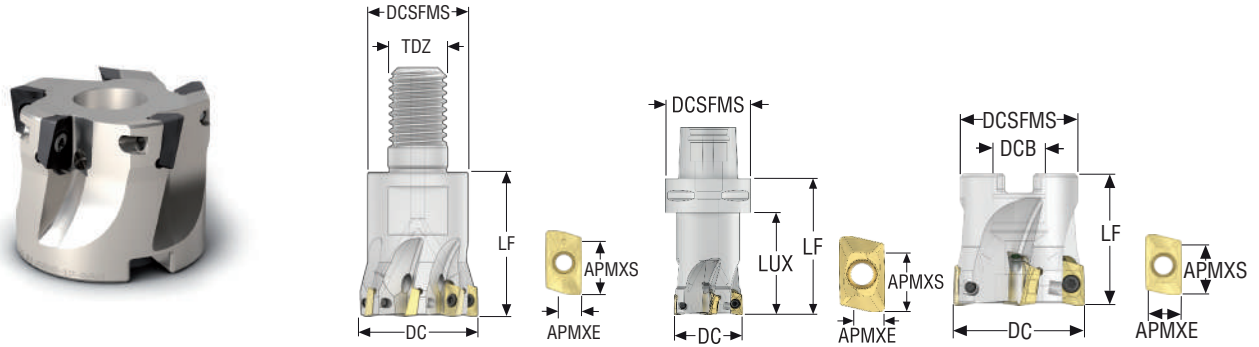



- For insert selection and cutting data recommendations, see page(s) 53-55
- For complete insert programme, see page(s) 869, 870
- For ISO attribute explanation, see page 16
- KAPRS 90°



Designation	Item number	Type of mounting	DC	ZEPF	APMXS	APMXE	DCB	TDZ	DCSFMS	LUX	LF	RMPX°	Cmin	Cmax	RPMX	Weight	Insert
			mm		mm	mm	mm		mm	mm	mm		mm	mm		kg	
R217.69-1020.RE-12-2AN	02676828	Combimaster	20,0	2	11,0	7,0	–	M10	18,0	–	28,0	8,0	27,5	38,0	23200	0,1	XO.X12..
R217.69-1225.RE-12-3AN	02676833	Combimaster	25,0	3	11,0	7,0	–	M12	23,0	–	30,0	5,0	37,5	48,0	20800	0,2	XO.X12..
R217.69-1632.RE-12-3AN	02676838	Combimaster	32,0	3	11,0	7,0	–	M16	30,0	–	40,0	3,0	51,5	62,0	18400	0,3	XO.X12..
R217.69-1632.RE-12-4AN	02676839	Combimaster	32,0	4	11,0	7,0	–	M16	30,0	–	40,0	3,0	51,5	62,0	18400	0,3	XO.X12..
R217.69-1640.RE-12-4AN	02676840	Combimaster	40,0	4	11,0	7,0	–	M16	30,0	–	40,0	2,5	67,5	78,0	16400	0,3	XO.X12..
R217.69-1640.RE-12-5AN	02676845	Combimaster	40,0	5	11,0	7,0	–	M16	30,0	–	40,0	2,5	67,5	78,0	16400	0,3	XO.X12..
R217.69-2040.RE-12-4AN	02972700	Combimaster	40,0	4	11,0	7,0	–	M20	36,5	–	40,0	2,5	67,5	78,0	16400	0,4	XO.X12..
R217.69-2040.RE-12-5AN	02972704	Combimaster	40,0	5	11,0	7,0	–	M20	36,5	–	40,0	2,5	67,5	78,0	16400	0,4	XO.X12..
C5-R217.69-040-12-4AN	02677616	Seco-Capto	40,0	4	11,0	7,0	–	–	50,0	57,0	80,0	2,5	67,5	78,0	16400	0,9	XO.X12..
C5-R217.69-054-12-5AN	02677619	Seco-Capto	54,0	5	11,0	7,0	–	–	50,0	60,0	60,0	1,7	95,5	106,0	14200	1,0	XO.X12..
R220.69-0032-12-3AN	02841296	Arbor	32,0	3	11,0	7,0	16,0	–	30,0	–	35,0	3,0	51,5	62,0	18400	0,3	XO.X12..
R220.69-0032-12-4AN	02841297	Arbor	32,0	4	11,0	7,0	16,0	–	30,0	–	35,0	3,0	51,5	62,0	18400	0,3	XO.X12..
R220.69-0040-12-4AN	02677566	Arbor	40,0	4	11,0	7,0	16,0	–	35,0	–	40,0	2,5	67,5	78,0	16400	0,2	XO.X12..
R220.69-0040-12-5AN	02677570	Arbor	40,0	5	11,0	7,0	16,0	–	35,0	–	40,0	2,5	67,5	78,0	16400	0,2	XO.X12..
R220.69-0044-12-4AN	02969083	Arbor	44,0	4	11,0	7,0	16,0	–	36,0	–	40,0	2,2	75,5	86,0	15600	0,1	XO.X12..
R220.69-0050-12-5AN	02677572	Arbor	50,0	5	11,0	7,0	22,0	–	47,0	–	40,0	2,0	87,5	98,0	14800	0,4	XO.X12..
R220.69-0050-12-7AN	02677573	Arbor	50,0	7	11,0	7,0	22,0	–	47,0	–	40,0	2,0	87,5	98,0	14800	0,4	XO.X12..
R220.69-0052-12-5AN	02497527	Arbor	52,0	5	11,0	7,0	22,0	–	47,0	–	40,0	1,7	91,5	102,0	14200	0,6	XO.X12..
R220.69-0063-12-6AN	02677576	Arbor	63,0	6	11,0	7,0	27,0	–	52,0	–	40,0	1,5	113,5	124,0	13200	0,6	XO.X12..
R220.69-0063-12-8AN	02677578	Arbor	63,0	8	11,0	7,0	27,0	–	52,0	–	40,0	1,5	113,5	124,0	13200	0,6	XO.X12..
R220.69-0066-12-6AN	02969085	Arbor	66,0	6	11,0	7,0	27,0	–	52,0	–	40,0	1,5	119,5	130,0	13200	0,9	XO.X12..
R220.69-0080-12-7AN	02677608	Arbor	80,0	7	11,0	7,0	27,0	–	62,0	–	50,0	1,0	147,5	158,0	11600	1,1	XO.X12..
R220.69-0080-12-10AN	02677581	Arbor	80,0	10	11,0	7,0	27,0	–	62,0	–	50,0	1,0	147,5	158,0	11600	1,0	XO.X12..
R220.69-0084-12-7AN	02969086	Arbor	84,0	7	11,0	7,0	27,0	–	62,0	–	50,0	1,0	155,5	166,0	11300	1,4	XO.X12..
R220.69-0100-12-8AN	02677610	Arbor	100,0	8	11,0	7,0	32,0	–	77,0	–	50,0	0,5	187,5	198,0	10400	1,7	XO.X12..
R220.69-0100-12-12AN	02677609	Arbor	100,0	12	11,0	7,0	32,0	–	77,0	–	50,0	0,5	187,5	198,0	10400	1,7	XO.X12..
R220.69-0125-12-10AN	02677611	Arbor	125,0	10	11,0	7,0	40,0	–	90,0	–	63,0	0,5	237,5	248,0	9200	3,2	XO.X12..
R220.69-0125-12-14AN	02677613	Arbor	125,0	14	11,0	7,0	40,0	–	90,0	–	63,0	0,5	237,5	248,0	9200	3,2	XO.X12..

Modification of the cutter body needed for radii > 2,4 mm
For Combimaster Shanks, see Machining Navigator Tooling System

Spare Parts, included in delivery

For cutter	Arbor screw	Insert key	Insert screw
			
R217.69-.. Ø20-25	-	H4B-T10P	C03507-T10P
R217.69- Ø32	-	H4B-T10P	C03508-T10P
R217.69- Ø40	-	H4B-T10P	C03509-T10P
C5-R217.69-..	-	H4B-T10P	C03509-T10P
R220.69-0032	220.17-690	H4B-T10P	C03507-T10P
R220.69-0040-0044	MC6S8X30	H4B-T10P	C03509-T10P
R220.69-0050-0052	220.17-692	H4B-T10P	C03509-T10P
R220.69-0063-0066	220.17-693	H4B-T10P	C03509-T10P
R220.69-0080-0125	-	H4B-T10P	C03509-T10P
R220.69-0080-0125	-	H4B-T10PL	C03509-T10P

Accessories

For cutter	Insert clamping torque	Torque key
		
R217/220.69-..	3.0NM	T00-10P30

Torque and fixed keys, see page 894

Square shoulder and slot milling cutters
Helical milling cutters
Face milling cutters
Disc milling cutters
High feed milling cutters
Copy milling cutters
Plunge milling cutters
Chamfer milling cutters
Spot facing cutters
Inserts

Turbo 12 – R217/220.69-12 – inch

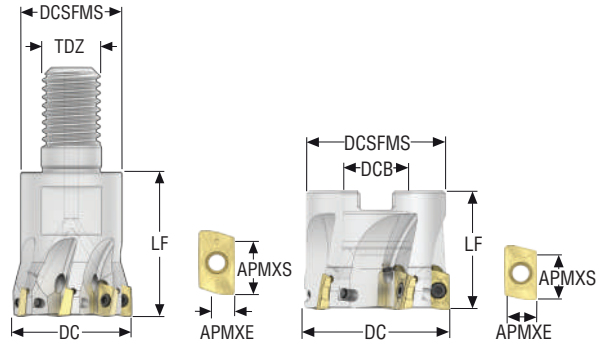



- For insert selection and cutting data recommendations, see page(s) 53-55
- For complete insert programme, see page(s) 869, 870
- For ISO attribute explanation, see page 16
- KAPRS 90°

Designation	Item number	Type of mounting	DC	ZEFP	APMXS	APMXE	DCB	TDZ	DCSFMS	LF	RMPX°	C min	C max	RPMX	Weight	Insert
			inch		inch	inch	inch		inch	inch		inch	inch		lbs	
R217.69-00.75-10RE-12-2AN	02689794	Combimaster	0.750	2	0.433	0.276	–	M10	0.709	1.378	8.0	1.004	1.417	23200	0.440	XO.X12
R217.69-01.00-12RE-12-3AN	02689797	Combimaster	1.000	3	0.433	0.276	–	M12	0.906	1.575	5.0	1.496	1.909	20800	0.440	XO.X12
R217.69-01.25-16RE-12-3AN	02689799	Combimaster	1.250	3	0.433	0.276	–	M16	1.181	1.575	3.0	2.008	2.421	18400	0.660	XO.X12
R217.69-01.25-16RE-12-4AN	02689801	Combimaster	1.250	4	0.433	0.276	–	M16	1.181	1.575	3.0	2.008	2.421	18400	0.660	XO.X12
R217.69-01.50-16RE-12-4AN	02689802	Combimaster	1.500	4	0.433	0.276	–	M16	1.181	1.575	2.5	2.500	2.913	16400	0.880	XO.X12
R217.69-01.50-16RE-12-5AN	02689805	Combimaster	1.500	5	0.433	0.276	–	M16	1.181	1.575	2.5	2.500	2.913	16400	0.880	XO.X12
R220.69-01.50-12-4AN	02689808	Arbor	1.500	4	0.433	0.276	0.750	–	1.378	1.575	2.5	2.500	2.913	16400	0.660	XO.X12
R220.69-01.50-12-5AN	02689809	Arbor	1.500	5	0.433	0.276	0.750	–	1.378	1.575	2.5	2.500	2.913	16400	0.880	XO.X12
R220.69-02.00-12-4AN	02689812	Arbor	2.000	4	0.433	0.276	0.750	–	1.850	1.575	2.0	3.504	3.917	14800	0.880	XO.X12
R220.69-02.00-12-5AN	02689813	Arbor	2.000	5	0.433	0.276	0.750	–	1.850	1.575	2.0	3.504	3.917	14800	0.880	XO.X12
R220.69-02.00-12-7AN	02689815	Arbor	2.000	7	0.433	0.276	0.750	–	1.850	1.575	2.0	3.504	3.917	14800	0.880	XO.X12
R220.69-02.50-12-4AN	02689816	Arbor	2.500	4	0.433	0.276	0.750	–	1.850	1.575	1.5	4.508	4.921	13200	1.100	XO.X12
R220.69-02.50-12-6AN	02689817	Arbor	2.500	6	0.433	0.276	0.750	–	1.850	1.575	1.5	4.508	4.921	13200	1.320	XO.X12
R220.69-03.00-12-4AN	02689820	Arbor	3.000	4	0.433	0.276	1.000	–	2.441	2.000	1.0	5.492	5.906	11600	2.200	XO.X12
R220.69-03.00-12-7AN	02689822	Arbor	3.000	7	0.433	0.276	1.000	–	2.441	2.000	1.0	5.492	5.906	11600	2.430	XO.X12
R220.69-03.00-12-10AN	02689821	Arbor	3.000	10	0.433	0.276	1.000	–	2.441	2.000	1.0	5.492	5.906	11600	2.200	XO.X12
R220.69-04.00-12-5AN	02689824	Arbor	4.000	5	0.433	0.276	1.500	–	3.543	2.000	0.5	7.500	7.913	10400	5.070	XO.X12
R220.69-04.00-12-8AN	02689826	Arbor	4.000	8	0.433	0.276	1.500	–	3.543	2.000	0.5	7.500	7.913	10400	4.410	XO.X12
R220.69-04.00-12-12AN	02689825	Arbor	4.000	12	0.433	0.276	1.500	–	3.543	2.000	0.5	7.500	7.913	10400	3.750	XO.X12



Modification of the cutter body needed for radii > 0.094 in
For Combimaster Shanks, see Machining Navigator Tooling System

Square shoulder and slot milling cutters
Helical milling cutters
Face milling cutters
Disc milling cutters
High feed milling cutters
Copy milling cutters
Plunge milling cutters
Chamfer milling cutters
Spot facing cutters
Inserts

Spare Parts, included in delivery

For cutter	Arbor screw	Insert key	Insert screw
			
R217.69-00.75 - 01.25	-	H4B-T10P	C03507-T10P
R217.69- 01.50	-	H4B-T10P	C03509-T10P
R220.69-01.50	220.17-698	H4B-T10P	C03509-T10P
R220.69-02.00-02.50	UC6S3/8UNFX1	H4B-T10P	C03509-T10P
R220.69-03.00	UC6S1/2UNFX1-1/4	H4B-T10P	C03509-T10P
R220.69-04.00	UC6S3/4UNFX1-1/4	H4B-T10PL	C03509-T10P

Accessories

For cutter	Insert clamping torque	Torque key
		
R217/220.69-..	26.6IN.LBS	T00-10P30

Torque and fixed keys, see page 894

- Square shoulder and slot milling cutters
- Helical milling cutters
- Face milling cutters
- Disc milling cutters
- High feed milling cutters
- Copy milling cutters
- Plunge milling cutters
- Chamfer milling cutters
- Spot facing cutters
- Inserts

Turbo 12 – R217/220.69-12 – Metric

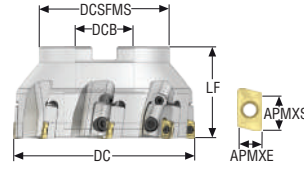

- For insert selection and cutting data recommendations, see page(s) 53-55
- For complete insert programme, see page(s) 869, 870
- For ISO attribute explanation, see page 16
- KAPRS 90°

Designation	Item number	Type of mounting	DC	ZEFP	APMXS	APMXE	DCB	DCSFMS	LF	RMPX°	Cmin	Cmax	RPMX	Weight	Insert
			mm		mm	mm	mm	mm	mm		mm	mm		kg	
R220.69-0125-12-8CN	02706936	Arbor	125,0	8	11,0	7,0	40,0	90,0	63,0	0,5	237,5	248,0	9200	3,1	XO.X12..
R220.69-8160-12-10CN	02706940	Arbor	160,0	10	11,0	7,0	40,0	90,0	63,0	0,3	307,5	318,0	8200	5,3	XO.X12..
R220.69-8200-12-12CN	02706943	Arbor	200,0	12	11,0	7,0	60,0	130,0	63,0	0,3	387,5	398,0	7300	7,4	XO.X12..
R220.69-8250-12-16CN	02706945	Arbor	250,0	16	11,0	7,0	60,0	130,0	63,0	0,2	487,5	498,0	6500	14,8	XO.X12..

Modification of the cutter body needed for radii > 2,4 mm

Spare Parts, included in delivery

For cutter	Adjustment unit	Cassette	Cassette screw	Insert key	Insert screw
R220.69-0125	AU1114T-T15P	XO12PRN	FS96018	H4B-T10PL	C03509-T10P
R220.69-8160	AU1114T-T15P	XO12PRN	FS96018	H4B-T10PL	C03509-T10P
R220.69-8200-8250	AU1114T-T15P	XO12PRN	FS96018	H4B-T10PL	C03509-T10P

Accessories

For cutter	Allen key	Arbor screw	Insert clamping torque	Torque key
R220.69-0125	H05-4	-	3.0NM	T00-10P30
R220.69-8160	H05-4	MC6S12X40	3.0NM	T00-10P30
R220.69-8200-8250	H05-4	MC6S16X50	3.0NM	T00-10P30

Torque and fixed keys, see page 894

R217/220.69-12 – Insert selection – mm/Inch

SMG		a _p	f _z		
			100%	30%	10%
P1	XOMX120408TR-ME08 F40M	5,0	0,14	0,15	0,24
		0,20	0,0055	0,0060	0,0095
P2	XOMX120408TR-ME08 F40M	5,0	0,14	0,16	0,24
		0,20	0,0055	0,0065	0,0095
P3	XOMX120408TR-M12 MP2501	5,0	0,16	0,18	0,28
		0,20	0,0065	0,0070	0,011
P4	XOMX120408TR-M12 MP2501	5,0	0,16	0,18	0,26
		0,20	0,0065	0,0070	0,010
P5	XOMX120408TR-M12 MP2501	5,0	0,16	0,17	0,26
		0,20	0,0065	0,0065	0,010
P6	XOMX120408TR-M12 MP2501	5,0	0,16	0,17	0,26
		0,20	0,0065	0,0065	0,010
P7	XOMX120408TR-M12 MP2501	5,0	0,16	0,17	0,26
		0,20	0,0065	0,0065	0,010
P8	XOMX120408TR-M12 MP2501	5,0	0,16	0,18	0,28
		0,20	0,0065	0,0070	0,011
P11	XOMX120408TR-M12 T350M	5,0	0,16	0,17	0,26
		0,20	0,0065	0,0065	0,010
P12	XOEX120431R-M07 MS2500	4,5	0,085	0,090	0,13
		0,18	0,0034	0,0036	0,0050
M1	XOEX120408R-M07 F40M	5,0	0,12	0,13	0,19
		0,20	0,0048	0,0050	0,0075
M2	XOEX120408R-M07 F40M	5,0	0,11	0,11	0,17
		0,20	0,0044	0,0044	0,0065
M3	XOEX120408R-M07 F40M	4,5	0,085	0,090	0,14
		0,18	0,0034	0,0036	0,0055
M4	XOEX120408R-M07 T350M	3,0	0,075	0,080	0,12
		0,12	0,0030	0,0032	0,0048
M5	XOEX120408R-M07 T350M	3,0	0,075	0,080	0,12
		0,12	0,0030	0,0032	0,0048
K1	XOMX120408TR-M12 MK2050	5,0	0,17	0,19	0,28
		0,20	0,0065	0,0075	0,011
K2	XOMX120408TR-M12 MK2050	5,0	0,16	0,17	0,26
		0,20	0,0065	0,0065	0,010
K3	XOMX120408TR-M12 MK2050	5,0	0,16	0,17	0,26
		0,20	0,0065	0,0065	0,010
K4	XOMX120408TR-M12 MK2050	5,0	0,16	0,17	0,26
		0,20	0,0065	0,0065	0,010
K5	XOMX120408TR-MD13 MK2050	5,0	0,15	0,17	0,26
		0,20	0,0060	0,0065	0,010
K6	XOMX120408TR-MD13 MK2050	5,0	0,17	0,19	0,28
		0,20	0,0065	0,0075	0,011
K7	XOMX120408TR-MD13 MK2050	5,0	0,15	0,17	0,26
		0,20	0,0060	0,0065	0,010
N1	XOEX120408FR-E06 H15	5,0	0,13	0,14	0,22
		0,20	0,0050	0,0055	0,0085
N2	XOEX120408FR-E06 H15	5,0	0,13	0,14	0,22
		0,20	0,0050	0,0055	0,0085
N3	XOEX120408FR-E06 H15	5,0	0,13	0,14	0,22
		0,20	0,0050	0,0055	0,0085
N11	XOEX120408FR-E06 H15	5,0	0,13	0,14	0,22
		0,20	0,0050	0,0055	0,0085
S1	XOEX120408R-M07 T350M	3,0	0,075	0,080	0,12
		0,12	0,0030	0,0032	0,0048
S2	XOEX120408R-M07 T350M	3,0	0,075	0,080	0,12
		0,12	0,0030	0,0032	0,0048
S3	XOEX120408R-M07 T350M	3,0	0,070	0,075	0,11
		0,12	0,0028	0,0030	0,0044
S11	XOEX120408R-M07 MS2050	4,0	0,085	0,090	0,14
		0,16	0,0034	0,0036	0,0055
S12	XOEX120408R-M07 MS2050	4,0	0,085	0,090	0,14
		0,16	0,0034	0,0036	0,0055
S13	XOEX120408R-M07 MS2050	3,0	0,075	0,080	0,12
		0,12	0,0030	0,0032	0,0048
H5	XOMX120408TR-MD13 MP3000	4,5	0,12	0,13	0,19
		0,18	0,0048	0,0050	0,0075
H8	XOMX120408TR-MD13 MP3000	4,0	0,090	0,095	0,15
		0,16	0,0036	0,0038	0,0060
H11	XOMX120408TR-MD13 MP1501	4,5	0,12	0,13	0,19
		0,18	0,0048	0,0050	0,0075
H12	XOMX120408TR-M12 MP1501	4,0	0,085	0,090	0,14
		0,16	0,0034	0,0036	0,0055

SMG = Seco material group
f_z = mm/tooth (in/tooth), v_c = m/min (sf/min), a_p/DC = %
All cutting data are start values

Square shoulder and slot milling cutters
Helical milling cutters
Face milling cutters
Disc milling cutters
High feed milling cutters
Copy milling cutters
Plunge milling cutters
Chamfer milling cutters
Spot facing cutters
Inserts

R217/220.69-12 – Cutting data $v_c = (m/min)/(sf/min)$

SMG	MP1501			MP2050			MP2501			MP3000			MM4500			MK1500		
	100%	30%	10%	100%	30%	10%	100%	30%	10%	100%	30%	10%	100%	30%	10%	100%	30%	10%
P1	295	390	465	315	415	480	265	345	410	250	325	390	195	260	300	—	—	—
	970	1275	1525	1025	1350	1575	870	1125	1350	820	1075	1275	640	850	980	—	—	—
P2	290	380	450	300	395	470	255	335	400	245	320	380	185	245	295	—	—	—
	950	1250	1475	980	1300	1550	840	1100	1300	800	1050	1250	610	800	970	—	—	—
P3	255	330	390	265	345	410	225	295	345	215	280	325	165	215	255	—	—	—
	840	1075	1275	870	1125	1350	740	970	1125	710	920	1075	540	710	840	—	—	—
P4	225	290	350	230	305	360	200	260	310	185	245	295	145	190	225	—	—	—
	740	950	1150	750	1000	1175	660	850	1025	610	800	970	475	620	740	—	—	—
P5	215	285	335	220	295	350	190	250	295	180	240	280	140	185	220	—	—	—
	710	940	1100	720	970	1150	620	820	970	590	790	920	460	610	720	—	—	—
P6	240	320	375	255	335	390	210	280	330	200	265	315	160	210	245	—	—	—
	790	1050	1225	840	1100	1275	690	920	1075	660	870	1025	520	690	800	—	—	—
P7	225	300	355	240	315	370	200	265	315	190	250	295	150	195	230	—	—	—
	740	980	1175	790	1025	1225	660	870	1025	620	820	970	490	640	750	—	—	—
P8	215	280	325	220	290	345	190	245	290	180	235	275	140	180	215	—	—	—
	710	920	1075	720	950	1125	620	800	950	590	770	900	460	590	710	—	—	—
P11	220	290	345	235	305	360	195	260	305	185	245	290	145	190	225	—	—	—
	720	950	1125	770	1000	1175	640	850	1000	610	800	950	475	620	740	—	—	—
P12	145	190	225	150	195	230	130	170	200	120	160	190	95	120	145	—	—	—
	475	620	740	490	640	750	425	560	660	395	520	620	310	395	475	—	—	—
M1	—	—	—	215	280	335	185	240	290	180	240	285	160	210	250	—	—	—
	—	—	—	710	920	1100	610	790	950	590	790	940	520	690	820	—	—	—
M2	—	—	—	175	240	280	150	200	240	150	200	235	130	180	210	—	—	—
	—	—	—	570	790	920	490	660	790	490	660	770	425	590	690	—	—	—
M3	—	—	—	145	190	220	125	165	195	120	160	190	110	145	165	—	—	—
	—	—	—	475	620	720	410	540	640	395	520	620	360	475	540	—	—	—
M4	—	—	—	115	150	175	100	130	150	95	130	150	85	110	130	—	—	—
	—	—	—	375	490	570	330	425	490	310	425	490	280	360	425	—	—	—
M5	—	—	—	95	125	145	80	110	125	80	105	125	70	95	110	—	—	—
	—	—	—	310	410	475	260	360	410	260	345	410	230	310	360	—	—	—
K1	230	300	360	235	310	370	205	265	320	190	250	300	—	—	—	290	380	450
	750	980	1175	770	1025	1225	670	870	1050	620	820	980	—	—	—	950	1250	1475
K2	200	270	315	210	280	330	180	240	280	170	225	265	—	—	—	255	340	400
	660	890	1025	690	920	1075	590	790	920	560	740	870	—	—	—	840	1125	1300
K3	170	230	270	175	240	280	150	200	240	145	190	225	—	—	—	215	285	335
	560	750	890	570	790	920	490	660	790	475	620	740	—	—	—	710	940	1100
K4	165	220	255	170	230	265	145	195	225	135	185	215	—	—	—	205	275	320
	540	720	840	560	750	870	475	640	740	445	610	710	—	—	—	670	900	1050
K5	100	135	155	105	140	160	90	120	140	85	115	130	—	—	—	125	170	195
	330	445	510	345	460	520	295	395	460	280	375	425	—	—	—	410	560	640
K6	145	190	225	150	200	235	130	170	200	120	160	190	—	—	—	180	240	285
	475	620	740	490	660	770	425	560	660	395	520	620	—	—	—	590	790	940
K7	130	170	200	135	180	205	115	150	175	110	145	170	—	—	—	165	215	250
	425	560	660	445	590	670	375	490	570	360	475	560	—	—	—	540	710	820
N1	—	—	—	—	—	—	—	—	—	1400	1850	2200	—	—	—	—	—	—
	—	—	—	—	—	—	—	—	—	4600	6075	7225	—	—	—	—	—	—
N2	—	—	—	—	—	—	—	—	—	570	750	890	—	—	—	—	—	—
	—	—	—	—	—	—	—	—	—	1875	2450	2925	—	—	—	—	—	—
N3	—	—	—	—	—	—	—	—	—	380	500	590	—	—	—	—	—	—
	—	—	—	—	—	—	—	—	—	1250	1650	1925	—	—	—	—	—	—
N11	—	—	—	—	—	—	—	—	—	430	570	680	—	—	—	—	—	—
	—	—	—	—	—	—	—	—	—	1400	1875	2225	—	—	—	—	—	—
S1	—	—	—	55	75	85	48	65	75	45	60	70	26	34	40	—	—	—
	—	—	—	180	245	280	155	215	245	150	195	230	85	110	130	—	—	—
S2	—	—	—	45	60	70	39	50	60	37	48	55	21	28	32	—	—	—
	—	—	—	150	195	230	130	165	195	120	155	180	70	90	105	—	—	—
S3	—	—	—	39	50	60	34	45	50	32	42	49	18	24	28	—	—	—
	—	—	—	130	165	195	110	150	165	105	140	160	60	80	90	—	—	—
S11	—	—	—	75	100	120	65	85	105	60	80	95	36	48	55	—	—	—
	—	—	—	245	330	395	215	280	345	195	260	310	120	155	180	—	—	—
S12	—	—	—	55	70	80	45	60	70	43	55	65	33	44	50	—	—	—
	—	—	—	180	230	260	150	195	230	140	180	215	110	145	165	—	—	—
S13	—	—	—	31	41	47	27	36	41	26	33	39	19	26	30	—	—	—
	—	—	—	100	135	155	90	120	135	85	110	130	60	85	100	—	—	—
H5	48	65	75	45	60	70	39	50	60	38	50	60	—	—	—	—	—	—
	155	215	245	150	195	230	130	165	195	125	165	195	—	—	—	—	—	—
H8	50	70	80	48	65	75	41	55	65	40	55	60	—	—	—	—	—	—
	165	230	260	155	215	245	135	180	215	130	180	195	—	—	—	—	—	—
H11	60	80	95	55	75	90	49	65	75	48	65	75	—	—	—	—	—	—
	195	260	310	180	245	295	160	215	245	155	215	245	—	—	—	—	—	—
H12	95	120	140	95	125	145	80	110	125	80	105	120	—	—	—	—	—	—
	310	395	460	310	410	475	260	360	410	260	345	395	—	—	—	—	—	—

R217/220.69-12 – Cutting data $v_c = (m/min)/(sf/min)$

SMG	MK2050			MS2050			MS2500			T350M			F40M			H15		
	100%	30%	10%	100%	30%	10%	100%	30%	10%	100%	30%	10%	100%	30%	10%	100%	30%	10%
P1	260	340	405	265	350	410	350	460	530	230	300	360	225	300	350	—	—	—
	850	1125	1325	870	1150	1350	1150	1500	1750	750	980	1175	740	980	1150	—	—	—
P2	255	330	395	255	335	395	330	435	520	225	295	350	220	285	340	—	—	—
	840	1075	1300	840	1100	1300	1075	1425	1700	740	970	1150	720	940	1125	—	—	—
P3	220	290	340	225	295	345	290	385	455	195	255	300	190	250	300	—	—	—
	720	950	1125	740	970	1125	950	1275	1500	640	840	980	620	820	980	—	—	—
P4	195	255	305	195	260	305	255	340	400	170	225	270	170	220	265	—	—	—
	640	840	1000	640	850	1000	840	1125	1300	560	740	890	560	720	870	—	—	—
P5	185	250	290	185	250	295	245	330	385	165	220	260	165	215	250	—	—	—
	610	820	950	610	820	970	800	1075	1275	540	720	850	540	710	820	—	—	—
P6	210	280	325	215	285	330	280	370	435	185	245	290	185	240	280	—	—	—
	690	920	1075	710	940	1075	920	1225	1425	610	800	950	610	790	920	—	—	—
P7	195	260	310	205	265	315	265	350	410	175	230	275	170	230	265	—	—	—
	640	850	1025	670	870	1025	870	1150	1350	570	750	900	560	750	870	—	—	—
P8	185	245	285	185	245	290	245	325	380	165	215	255	160	210	250	—	—	—
	610	800	940	610	800	950	800	1075	1250	540	710	840	520	690	820	—	—	—
P11	190	255	300	200	260	305	260	340	400	170	225	265	170	220	260	—	—	—
	620	840	980	660	860	1000	850	1125	1300	560	740	870	560	720	850	—	—	—
P12	125	165	195	130	165	195	165	215	255	110	145	175	110	145	170	—	—	—
	410	540	640	425	540	640	540	710	840	360	475	570	360	475	560	—	—	—
M1	—	—	—	205	270	320	235	315	375	170	225	270	180	230	275	—	—	—
	—	—	—	670	890	1050	770	1025	1225	560	740	890	590	750	900	—	—	—
M2	—	—	—	170	225	265	195	265	310	140	190	220	145	195	225	—	—	—
	—	—	—	560	740	870	640	870	1025	460	620	720	475	640	740	—	—	—
M3	—	—	—	140	185	210	160	210	245	115	155	180	115	160	185	—	—	—
	—	—	—	460	610	690	520	690	800	375	510	590	375	520	610	—	—	—
M4	—	—	—	110	140	165	125	165	190	90	120	140	95	120	145	—	—	—
	—	—	—	360	460	540	410	540	620	295	395	460	310	395	475	—	—	—
M5	—	—	—	90	120	140	105	135	160	75	100	115	80	100	120	—	—	—
	—	—	—	295	395	460	345	445	520	245	330	375	260	330	395	—	—	—
K1	270	355	425	—	—	—	—	—	—	175	230	275	—	—	—	—	—	—
	890	1175	1400	—	—	—	—	—	—	570	750	900	—	—	—	—	—	—
K2	240	320	375	—	—	—	—	—	—	155	210	245	—	—	—	—	—	—
	790	1050	1225	—	—	—	—	—	—	510	690	800	—	—	—	—	—	—
K3	205	270	320	—	—	—	—	—	—	130	175	205	—	—	—	—	—	—
	670	890	1050	—	—	—	—	—	—	425	570	670	—	—	—	—	—	—
K4	195	260	305	—	—	—	—	—	—	125	170	200	—	—	—	—	—	—
	640	850	1000	—	—	—	—	—	—	410	560	660	—	—	—	—	—	—
K5	120	160	185	—	—	—	—	—	—	80	105	120	—	—	—	—	—	—
	395	520	610	—	—	—	—	—	—	260	345	395	—	—	—	—	—	—
K6	170	230	270	—	—	—	—	—	—	110	150	175	—	—	—	—	—	—
	560	750	890	—	—	—	—	—	—	360	490	570	—	—	—	—	—	—
K7	155	205	235	—	—	—	—	—	—	100	135	155	—	—	—	—	—	—
	510	670	770	—	—	—	—	—	—	330	445	510	—	—	—	—	—	—
N1	—	—	—	—	—	—	—	—	—	—	—	—	1275	1675	2000	1400	1850	2175
	—	—	—	—	—	—	—	—	—	—	—	—	4175	5500	6550	4600	6075	7125
N2	—	—	—	—	—	—	—	—	—	—	—	—	520	680	810	570	750	880
	—	—	—	—	—	—	—	—	—	—	—	—	1700	2225	2650	1875	2450	2875
N3	—	—	—	—	—	—	—	—	—	—	—	—	345	455	540	380	500	580
	—	—	—	—	—	—	—	—	—	—	—	—	1125	1500	1775	1250	1650	1900
N11	—	—	—	—	—	—	—	—	—	—	—	—	395	520	610	430	570	670
	—	—	—	—	—	—	—	—	—	—	—	—	1300	1700	2000	1400	1875	2200
S1	—	—	—	50	65	75	60	80	95	43	55	65	43	55	65	—	—	—
	—	—	—	165	215	245	195	260	310	140	180	215	140	180	215	—	—	—
S2	—	—	—	41	55	60	50	65	75	35	45	55	35	46	55	—	—	—
	—	—	—	135	180	195	165	215	245	115	150	180	115	150	180	—	—	—
S3	—	—	—	36	46	55	43	55	65	31	40	46	31	40	47	—	—	—
	—	—	—	120	150	180	140	180	215	100	130	150	100	130	155	—	—	—
S11	—	—	—	70	90	105	85	110	130	60	75	90	60	80	95	—	—	—
	—	—	—	230	295	345	280	360	425	195	245	295	195	260	310	—	—	—
S12	—	—	—	48	65	75	60	80	90	41	55	65	41	55	65	—	—	—
	—	—	—	155	215	245	195	260	295	135	180	215	135	180	215	—	—	—
S13	—	—	—	28	37	43	35	45	55	24	31	37	24	32	38	—	—	—
	—	—	—	90	120	140	115	150	180	80	100	120	80	105	125	—	—	—
H5	—	—	—	—	—	—	—	—	—	37	49	55	—	—	—	—	—	—
	—	—	—	—	—	—	—	—	—	120	160	180	—	—	—	—	—	—
H8	—	—	—	—	—	—	—	—	—	40	50	60	—	—	—	—	—	—
	—	—	—	—	—	—	—	—	—	130	165	195	—	—	—	—	—	—
H11	—	—	—	—	—	—	—	—	—	47	60	75	—	—	—	—	—	—
	—	—	—	—	—	—	—	—	—	155	195	245	—	—	—	—	—	—
H12	—	—	—	—	—	—	105	140	160	70	95	110	—	—	—	—	—	—
	—	—	—	—	—	—	345	460	520	230	310	360	—	—	—	—	—	—

Square shoulder and slot milling cutters
Helical milling cutters
Face milling cutters
Disc milling cutters
High feed milling cutters
Copy milling cutters
Plunge milling cutters
Chamfer milling cutters
Spot facing cutters
Inserts

Turbo 16 – R217.69-XO16 – Metric

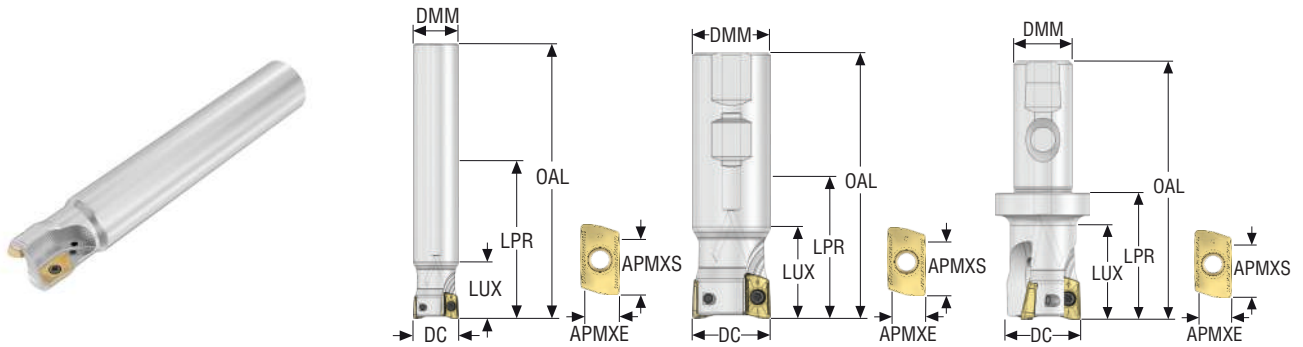

- For insert selection and cutting data recommendations, see page(s) 63-65
- For complete insert programme, see page(s) 871, 872
- For ISO attribute explanation, see page 16
- KAPRS 90°

Designation	Item number	Type of mounting	DC	ZEFP	APMXS	APMXE	DMM	LUX	LPR	OAL	RMPX°	Cmin	Cmax	RPMX	Weight	Insert
			mm		mm	mm	mm	mm	mm	mm		mm	mm		kg	
R217.69-2525.0-XO16-2A	03336100	Cylindrical	25,0	2	15,0	9,0	25,0	35,0	114,0	170,0	11,0	33,5	47,7	16700	0,6	XO.X16
R217.69-3232.0-XO16-2A	03336101	Cylindrical	32,0	2	15,0	9,0	32,0	40,0	135,0	195,0	6,0	47,5	61,7	14800	1,1	XO.X16
R217.69-3232.0-XO16-3A	03336102	Cylindrical	32,0	3	15,0	9,0	32,0	40,0	135,0	195,0	6,0	47,5	61,7	14800	1,1	XO.X16
R217.69-2525.3-XO16-2A	03336092	Weldon	25,0	2	15,0	9,0	25,0	38,0	44,0	100,0	11,0	33,5	47,7	16700	0,3	XO.X16
R217.69-3232.3-XO16-2A	03336093	Weldon	32,0	2	15,0	9,0	32,0	38,0	50,0	110,0	6,0	47,5	61,7	14800	0,6	XO.X16
R217.69-3232.3-XO16-3A	03336094	Weldon	32,0	3	15,0	9,0	32,0	38,0	50,0	110,0	6,0	47,5	61,7	14800	0,6	XO.X16
R217.69-2025.3S-XO16-2A	03336095	Seco-Weldon	25,0	2	15,0	9,0	20,0	40,0	50,0	100,0	11,0	33,5	47,7	16700	0,3	XO.X16
R217.69-2532.3S-XO16-2A	03336096	Seco-Weldon	32,0	2	15,0	9,0	25,0	40,0	54,0	110,0	6,0	47,5	61,7	14800	0,5	XO.X16
R217.69-2532.3S-XO16-3A	03336097	Seco-Weldon	32,0	3	15,0	9,0	25,0	40,0	54,0	110,0	6,0	47,5	61,7	14800	0,5	XO.X16
R217.69-3240.3S-XO16-3A	03336098	Seco-Weldon	40,0	3	15,0	9,0	32,0	46,0	60,0	120,0	3,5	63,5	77,7	13200	0,8	XO.X16
R217.69-3240.3S-XO16-4A	03336099	Seco-Weldon	40,0	4	15,0	9,0	32,0	46,0	60,0	120,0	3,5	63,5	77,7	13200	0,8	XO.X16

Modification of the cutter body needed for radii > 4,0 mm

Spare Parts, included in delivery

For cutter	Insert key	Insert screw
R217.69-2525-2532	T15P-2	C04008-T15P
R217.69-3240	T15P-2	C04009-T15P

Accessories

For cutter	Insert clamping torque	Torque key
R217.69-..	3.5NM	T00-15P35

Torque and fixed keys, see page 894

Turbo 16 – R217.69-XO16 – inch

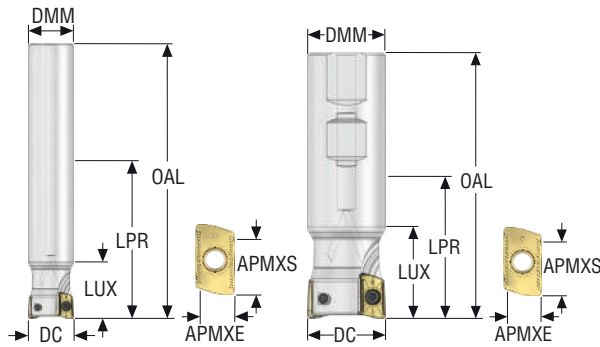

- For insert selection and cutting data recommendations, see page(s) 63-65
- For complete insert programme, see page(s) 871, 872
- For ISO attribute explanation, see page 16
- KAPRS 90°

Designation	Item number	Type of mounting	DC	ZEFP	APMXS	APMXE	DMM	LUX	LPR	OAL	RMPX°	C min	C max	RPMX	Weight	Insert
			inch		inch	inch	inch	inch	inch	inch		inch	inch		lbs	
R217.69-01.00-0-XO16-2A	03336134	Cylindrical	1.000	2	0.591	0.354	1.000	1.378	4.488	6.693	9,0	1.350	1.909	16600	1.320	XO.X16
R217.69-01.25-0-XO16-2A	03336135	Cylindrical	1.250	2	0.591	0.354	1.250	1.575	5.472	7.677	5,5	1.850	2.409	14800	2.430	XO.X16
R217.69-01.50-0-XO16-3A	03336136	Cylindrical	1.500	3	0.591	0.354	1.250	5.906	5.906	8.268	4,0	2.350	2.909	13500	2.650	XO.X16
R217.69-01.50-0-XO16-4A	03336137	Cylindrical	1.500	4	0.591	0.354	1.250	5.906	5.906	8.268	4,0	2.350	2.906	13500	2.650	XO.X16
R217.69-01.00-3-XO16-2A	03336130	Weldon	1.000	2	0.591	0.354	1.000	1.575	1.732	3.937	10,0	1.350	1.909	16600	0.660	XO.X16
R217.69-01.25-3-XO16-3A	03336131	Weldon	1.250	3	0.591	0.354	1.250	1.575	1.969	4.331	6,0	1.850	2.409	14800	1.320	XO.X16
R217.69-01.50-3-XO16-3A	03336132	Weldon	1.500	3	0.591	0.354	1.250	2.362	2.362	4.724	4,0	2.350	2.909	13500	1.540	XO.X16
R217.69-01.50-3-XO16-4A	03336133	Weldon	1.500	4	0.591	0.354	1.250	2.362	2.362	4.724	4,0	2.350	2.909	13500	1.540	XO.X16

Modification of the cutter body needed for radii > 0.158 in

Spare Parts, included in delivery

For cutter	Insert key	Insert screw
R217.69-01.00-01.25	T15P-2	C04008-T15P
R217.69-01.50	T15P-2	C04009-T15P

Accessories

For cutter	Insert clamping torque	Torque key
R217.69-..	31.0IN.LBS	T00-15P35

Torque and fixed keys, see page 894

Turbo 16 – R217/220.69-XO16 – Metric

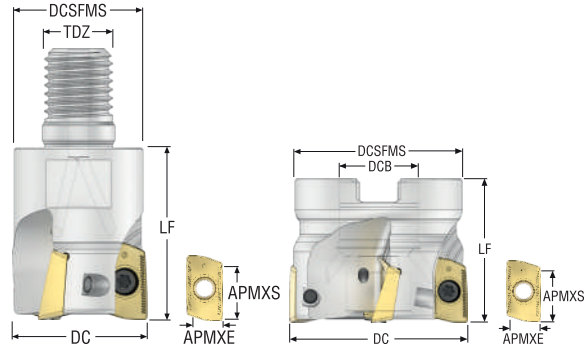

- For insert selection and cutting data recommendations, see page(s) 63-65
- For complete insert programme, see page(s) 871, 872
- For ISO attribute explanation, see page 16
- KAPRS 90°

Designation	Item number	Type of mounting	DC	ZEFP	APMXS	APMXE	DCB	TDZ	DCSFMS	LF	RMPX°	Cmin	Cmax	RPMX	Weight	Insert
			mm		mm	mm	mm		mm	mm		mm	mm		kg	
R217.69-1225.RE-XO16-2A	03336103	Combimaster	25,0	2	15,0	9,0	–	M12	23,0	40,0	11,0	33,5	47,7	16700	0,2	XO.X16
R217.69-1632.RE-XO16-2A	03336104	Combimaster	32,0	2	15,0	9,0	–	M16	30,0	40,0	6,0	47,5	61,7	14800	0,2	XO.X16
R217.69-1632.RE-XO16-3A	03336105	Combimaster	32,0	3	15,0	9,0	–	M16	30,0	40,0	6,0	47,5	61,7	14800	0,2	XO.X16
R217.69-2040.RE-XO16-3A	03336106	Combimaster	40,0	3	15,0	9,0	–	M20	36,5	45,0	3,5	63,5	77,7	13200	0,4	XO.X16
R217.69-2040.RE-XO16-4A	03336107	Combimaster	40,0	4	15,0	9,0	–	M20	36,5	45,0	3,5	63,5	77,7	13200	0,4	XO.X16
R220.69-0040-XO16-3A	03336108	Arbor	40,0	3	15,0	9,0	16,0	–	35,0	40,0	3,5	63,5	77,7	13200	0,2	XO.X16
R220.69-0040-XO16-4A	03336109	Arbor	40,0	4	15,0	9,0	16,0	–	35,0	40,0	3,5	63,5	77,7	13200	0,2	XO.X16
R220.69-0050-XO16-4A	03336110	Arbor	50,0	4	15,0	9,0	22,0	–	47,0	40,0	2,6	83,5	97,7	11800	0,3	XO.X16
R220.69-0050-XO16-5A	03336111	Arbor	50,0	5	15,0	9,0	22,0	–	47,0	40,0	2,6	83,5	97,7	11800	0,3	XO.X16
R220.69-0050-XO16-6A	10010246	Arbor	50,0	6	15,0	9,0	22,0	–	47,0	40,0	2,6	83,5	97,7	11800	0,3	XO.X16
R220.69-0052-XO16-5A	03336112	Arbor	52,0	5	15,0	9,0	22,0	–	47,0	40,0	2,5	87,5	101,7	11600	0,4	XO.X16
R220.69-0063-XO16-5A	03336113	Arbor	63,0	5	15,0	9,0	27,0	–	56,0	40,0	2,0	109,5	123,7	10500	0,5	XO.X16
R220.69-0063-XO16-6A	03336115	Arbor	63,0	6	15,0	9,0	27,0	–	56,0	40,0	2,0	109,5	123,7	10500	0,5	XO.X16
R220.69-0063-XO16-7A	10010247	Arbor	63,0	7	15,0	9,0	27,0	–	56,0	40,0	2,0	109,5	123,7	10549	0,5	XO.X16
R220.69-0066-XO16-6A	03336117	Arbor	66,0	6	15,0	9,0	27,0	–	56,0	40,0	1,8	115,5	129,7	10300	0,5	XO.X16
R220.69-0080-XO16-6A	03336118	Arbor	80,0	6	15,0	9,0	27,0	–	62,0	50,0	1,5	143,5	157,7	9300	1,0	XO.X16
R220.69-0080-XO16-8A	03336119	Arbor	80,0	8	15,0	9,0	27,0	–	62,0	50,0	1,5	143,5	157,7	9300	1,0	XO.X16
R220.69-0080-XO16-9A	10010248	Arbor	80,0	9	15,0	9,0	27,0	–	62,0	50,0	1,5	143,5	157,7	9300	1,0	XO.X16
R220.69-0084-XO16-8A	03336120	Arbor	84,0	8	15,0	9,0	27,0	–	62,0	50,0	1,3	151,5	165,7	9100	1,0	XO.X16
R220.69-0100-XO16-8A	03336121	Arbor	100,0	8	15,0	9,0	32,0	–	77,0	50,0	1,1	183,5	197,7	8300	1,6	XO.X16
R220.69-0100-XO16-10A	03336122	Arbor	100,0	10	15,0	9,0	32,0	–	77,0	50,0	1,1	183,5	197,7	8300	1,6	XO.X16
R220.69-0125-XO16-10A	03336123	Arbor	125,0	10	15,0	9,0	40,0	–	90,0	63,0	0,85	233,5	247,7	7400	3,0	XO.X16
R220.69-0125-XO16-12A	03336124	Arbor	125,0	12	15,0	9,0	40,0	–	90,0	63,0	0,85	234,0	247,0	7400	3,0	XO.X16
R220.69-8160-XO16-11A	03336125	Arbor	160,0	11	15,0	9,0	40,0	–	90,0	63,0	0,65	303,5	317,7	6600	5,0	XO.X16
R220.69-8160-XO16-13A	03336126	Arbor	160,0	13	15,0	9,0	40,0	–	90,0	63,0	0,65	303,5	317,7	6600	5,0	XO.X16

Modification of the cutter body needed for radii > 4,0 mm
For Combimaster Shanks, see Machining Navigator Tooling System

Spare Parts, included in delivery

For cutter	Arbor screw	Insert key	Insert screw	Lid	Lid screw
R217.69-1225-1632	-	T15P-2	C04008-T15P	-	-
R217.69-2040/R220.69-0080-0125	-	T15P-2	C04009-T15P	-	-
R220.69-0040	TCEI0825	T15P-2	C04009-T15P	-	-
R220.69-0050-0052	220.17-692	T15P-2	C04009-T15P	-	-
R220.69-0063-0066	MLC6S12X30	T15P-2	C04009-T15P	-	-
R220.69-8160	-	T15P-2	C04009-T15P	SC-160-90	MF6S4X10

Accessories

For cutter	Arbor screw	Insert clamping torque	Torque key
R217/220.69-1225-0125	-	3.5NM	T00-15P35
R220.69-8160	MC6S12X40	3.5NM	T00-15P35

Torque and fixed keys, see page 894

- Square shoulder and slot milling cutters
- Helical milling cutters
- Face milling cutters
- Disc milling cutters
- High feed milling cutters
- Copy milling cutters
- Plunge milling cutters
- Chamfer milling cutters
- Spot facing cutters
- Inserts

Turbo 16 – R217/220.69-XO16 – inch

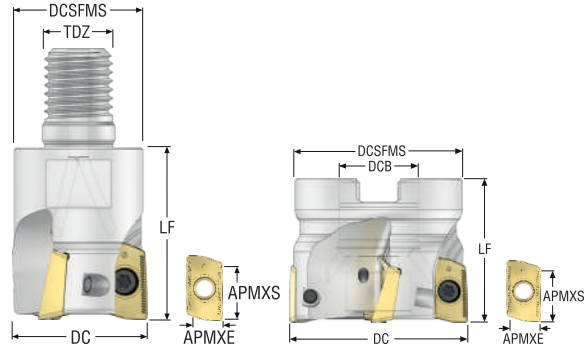

- For insert selection and cutting data recommendations, see page(s) 63-65
- For complete insert programme, see page(s) 871, 872
- For ISO attribute explanation, see page 16
- KAPRS 90°

Designation	Item number	Type of mounting	DC	ZEFP	APMXS	APMXE	DCB	TDZ	DCSFMS	LF	RMPX°	C min	C max	RPMX	Weight	Insert
			inch		inch	inch	inch		inch	inch		inch	inch		lbs	
R217.69-01.00-12RE-XO16-2A	03336138	Combimaster	1.000	2	0.591	0.354	–	M12	0.906	1.575	11.0	1.350	1.909	16600	0.440	XO.X16
R217.69-01.25-16RE-XO16-3A	03336139	Combimaster	1.250	3	0.591	0.354	–	M16	1.181	1.575	6.0	1.850	2.409	14800	0.440	XO.X16
R217.69-01.50-20RE-XO16-4A	03336140	Combimaster	1.500	4	0.591	0.354	–	M20	1.437	1.772	4.0	2.350	2.909	13500	0.880	XO.X16
R220.69-01.50-XO16-4A	03336141	Arbor	1.500	4	0.591	0.354	0.500	–	1.378	1.575	4.0	2.350	2.909	13500	0.440	XO.X16
R220.69-02.00-XO16-4A	03336142	Arbor	2.000	4	0.591	0.354	0.750	–	1.850	1.575	2.5	3.350	3.909	11700	0.880	XO.X16
R220.69-02.00-XO16-5A	03336143	Arbor	2.000	5	0.591	0.354	0.750	–	1.850	1.575	2.5	3.350	3.909	11700	0.880	XO.X16
R220.69-02.00-XO16-6A	03336144	Arbor	2.000	6	0.591	0.354	0.750	–	1.850	1.575	2.5	3.350	3.909	11700	0.880	XO.X16
R220.69-02.50-XO16-5A	03336145	Arbor	2.500	5	0.591	0.354	0.750	–	1.850	1.575	2.0	4.350	4.909	10500	1.100	XO.X16
R220.69-02.50-XO16-6A	03336146	Arbor	2.500	6	0.591	0.354	0.750	–	1.850	1.575	2.0	4.370	4.882	10500	1.320	XO.X16
R220.69-03.00-XO16-6A	03336147	Arbor	3.000	6	0.591	0.354	1.000	–	2.441	1.969	1.5	5.354	5.906	9500	2.200	XO.X16
R220.69-03.00-XO16-8A	03336148	Arbor	3.000	8	0.591	0.354	1.000	–	2.441	1.969	1.5	5.354	5.906	9500	2.200	XO.X16
R220.69-04.00-XO16-8A	03336149	Arbor	4.000	8	0.591	0.354	1.500	–	3.543	1.969	1.1	7.362	7.874	8300	4.410	XO.X16
R220.69-04.00-XO16-10A	03336150	Arbor	4.000	10	0.591	0.354	1.500	–	3.543	1.969	1.1	7.362	7.874	8300	4.410	XO.X16
R220.69-05.00-XO16-9A	03336151	Arbor	5.000	9	0.591	0.354	1.500	–	3.543	2.480	0.85	9.370	9.882	7400	7.500	XO.X16
R220.69-06.00-XO16-12A	10000967	Arbor	6.000	12	0.591	0.354	2.000	–	4.331	2.480	0.7	11.378	11.890	6700	10.360	XO.X16

Modification of the cutter body needed for radii > 0.158 in
For Combimaster Shanks, see Machining Navigator Tooling System

Spare Parts, included in delivery

For cutter	Arbor screw	Insert key	Insert screw	Lid	Lid screw
R217.69-01.00-01.25	-	T15P-2	C04008-T15P	-	-
R217.69-01.50	-	T15P-2	C04009-T15P	-	-
R220.69-01.50	UC6S1/4UNFX1	T15P-2	C04009-T15P	-	-
R220.69-02.00-02.50	UC6S3/8UNFX1	T15P-2	C04009-T15P	-	-
R220.69-03.00	UC6S1/2UNFX1-1/4	T15P-2	C04009-T15P	-	-
R220.69-04.00	UF6S3/4UNFX2	T15P-2	C04009-T15P	-	-
R220.69-05.00	UC6S3/4UNFX1-1/4	T15P-2	C04009-T15P	-	-
R220.69-06.00	-	T15P-2	C04009-T15P	SC-160-90	MF6S4X10

Accessories

For cutter	Arbor screw	Insert clamping torque	Torque key
R217/220.69-01.00-05.00	-	31.0IN.LBS	T00-15P35
R220.69-06.00	58215080	31.0IN.LBS	T00-15P35

Torque and fixed keys, see page 894

- Square shoulder and slot milling cutters
- Helical milling cutters
- Face milling cutters
- Disc milling cutters
- High feed milling cutters
- Copy milling cutters
- Plunge milling cutters
- Chamfer milling cutters
- Spot facing cutters
- Inserts

Turbo 16 – R220.69-XO16 – Metric

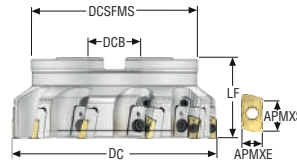

- For insert selection and cutting data recommendations, see page(s) 63-65
- For complete insert programme, see page(s) 871, 872
- For ISO attribute explanation, see page 16
- KAPRS 90°

Designation	Item number	Type of mounting	DC	ZEFP	APMXS	APMXE	DCB	DCSFMS	LF	RMPX°	Cmin	Cmax	RPMX	Weight	Insert
			mm		mm	mm	mm	mm	mm		mm	mm		kg	
R220.69-0125-XO16-8CA	03336127	Arbor	125,0	8	15,0	9,0	40,0	90,0	63,0	0,85	233,5	247,7	7400	2,8	XO.X16
R220.69-8160-XO16-10CA	10000966	Arbor	160,0	10	15,0	9,0	40,0	90,0	63,0	0,65	303,5	317,7	6600	4,7	XO.X16
R220.69-8200-XO16-12CA	03336128	Arbor	200,0	12	15,0	9,0	60,0	130,0	63,0	0,5	383,5	397,7	5900	6,6	XO.X16
R220.69-8250-XO16-16CA	03336129	Arbor	250,0	16	15,0	9,0	60,0	130,0	63,0	0,4	483,5	497,7	5200	13,3	XO.X16

Modification of the cutter body needed for radii > 4,0 mm

Spare Parts, included in delivery

For cutter	Adjustment unit	Cassette	Cassette screw	Insert key	Insert screw	Lid	Lid screw
R220.69-0125	AU1114T-T15P	XO16PRA	FS96018	T15P-2	C04009-T15P	-	-
R220.69-8160	AU1114T-T15P	XO16PRA	FS96018	T15P-2	C04009-T15P	SC-160-90	MF6S4X10
R220.69-8200	AU1114T-T15P	XO16PRA	FS96018	T15P-2	C04009-T15P	SC-200-90	MF6S4X8
R220.69-8250	AU1114T-T15P	XO16PRA	FS96018	T15P-2	C04009-T15P	SC-250-90	MF6S4X10

Accessories

For cutter	Allen key	Arbor screw	Insert clamping torque	Torque key
R220.69-0125	H05-4	-	3.5NM	T00-15P35
R220.69-8160-8200	H05-4	MC6S12X40	3.5NM	T00-15P35
R220.69-8200-8250	H05-4	MC6S16X50	3.5NM	T00-15P35

Torque and fixed keys, see page 894

R217/220.69-16 – Insert selection – mm/Inch

SMG		a _p	f _z		
			100%	30%	10%
P1	XOMX160508TR-ME11 F40M	7,0	0,16	0,17	0,26
		0,28	0,0065	0,0065	0,010
P2	XOMX160508TR-ME11 F40M	7,0	0,16	0,17	0,26
		0,28	0,0065	0,0065	0,010
P3	XOMX160508TR-M13 MP2501	7,0	0,18	0,19	0,30
		0,28	0,0070	0,0075	0,012
P4	XOMX160508TR-M13 MP2501	7,0	0,17	0,19	0,28
		0,28	0,0065	0,0075	0,011
P5	XOMX160508TR-M13 MP2501	7,0	0,17	0,19	0,28
		0,28	0,0065	0,0075	0,011
P6	XOMX160508TR-M13 MP2501	7,0	0,17	0,18	0,28
		0,28	0,0065	0,0070	0,011
P7	XOMX160508TR-M13 MP2501	7,0	0,17	0,18	0,28
		0,28	0,0065	0,0070	0,011
P8	XOMX160508TR-M13 MP2501	7,0	0,18	0,19	0,30
		0,28	0,0070	0,0075	0,012
P11	XOMX160508TR-M13 T350M	7,0	0,17	0,18	0,28
		0,28	0,0065	0,0070	0,011
P12	XOMX160508TR-M13 MP3000	6,0	0,12	0,13	0,19
		0,24	0,0048	0,0050	0,0075
M1	XOEX160508R-M09 F40M	7,0	0,13	0,14	0,22
		0,28	0,0050	0,0055	0,0085
M2	XOEX160508R-M09 F40M	7,0	0,12	0,13	0,20
		0,28	0,0048	0,0050	0,0080
M3	XOEX160508R-M09 F40M	6,0	0,095	0,10	0,16
		0,24	0,0038	0,0040	0,0065
M4	XOEX160508R-M09 T350M	4,5	0,085	0,090	0,14
		0,18	0,0034	0,0036	0,0055
M5	XOEX160508R-M09 T350M	4,5	0,085	0,090	0,14
		0,18	0,0034	0,0036	0,0055
K1	XOMX160508TR-M13 MK2050	7,0	0,19	0,20	0,32
		0,28	0,0075	0,0080	0,013
K2	XOMX160508TR-M13 MK2050	7,0	0,17	0,19	0,28
		0,28	0,0065	0,0075	0,011
K3	XOMX160508TR-M13 MK2050	7,0	0,17	0,19	0,28
		0,28	0,0065	0,0075	0,011
K4	XOMX160508TR-M13 MK2050	7,0	0,17	0,19	0,28
		0,28	0,0065	0,0075	0,011
K5	XOMX160508TR-MD14 MK2050	7,0	0,16	0,18	0,28
		0,28	0,0065	0,0070	0,011
K6	XOMX160508TR-MD14 MK2050	7,0	0,18	0,20	0,30
		0,28	0,0070	0,0080	0,012
K7	XOMX160508TR-MD14 MK2050	7,0	0,16	0,18	0,28
		0,28	0,0065	0,0070	0,011
N1	XOEX160508FR-E07 H25	7,0	0,13	0,14	0,22
		0,28	0,0050	0,0055	0,0085
N2	XOEX160508FR-E07 H25	7,0	0,13	0,14	0,22
		0,28	0,0050	0,0055	0,0085
N3	XOEX160508FR-E07 H25	7,0	0,13	0,14	0,22
		0,28	0,0050	0,0055	0,0085
N11	XOEX160508FR-E07 H25	7,0	0,13	0,14	0,22
		0,28	0,0050	0,0055	0,0085
S1	XOEX160508R-M09 T350M	4,5	0,085	0,090	0,14
		0,18	0,0034	0,0036	0,0055
S2	XOEX160508R-M09 T350M	4,5	0,085	0,090	0,14
		0,18	0,0034	0,0036	0,0055
S3	XOEX160508R-M09 T350M	4,5	0,075	0,085	0,13
		0,18	0,0030	0,0034	0,0050
S11	XOEX160508R-M09 MS2050	5,0	0,095	0,10	0,16
		0,20	0,0038	0,0040	0,0065
S12	XOEX160508R-M09 MS2050	5,0	0,095	0,10	0,16
		0,20	0,0038	0,0040	0,0065
S13	XOEX160508R-M09 MS2050	4,5	0,085	0,090	0,14
		0,18	0,0034	0,0036	0,0055
H5	XOMX160508TR-MD14 MP3000	6,0	0,12	0,14	0,20
		0,24	0,0048	0,0055	0,0080
H8	XOMX160508TR-MD14 MP3000	5,0	0,095	0,10	0,16
		0,20	0,0038	0,0040	0,0065
H11	XOMX160508TR-MD14 MP1501	6,0	0,12	0,14	0,20
		0,24	0,0048	0,0055	0,0080
H12	XOMX160508TR-M13 MP1501	5,0	0,090	0,095	0,15
		0,20	0,0036	0,0038	0,0060

SMG = Seco material group
f_z = mm/tooth (in/tooth), v_c = m/min (sf/min), a_p/DC = %
All cutting data are start values

Square shoulder and slot milling cutters
Helical milling cutters
Face milling cutters
Disc milling cutters
High feed milling cutters
Copy milling cutters
Plunge milling cutters
Chamfer milling cutters
Spot facing cutters
Inserts

R217/220.69-16 – Cutting data $v_c = (m/min)/(sf/min)$

SMG	MP1501			MP2050			MP2501			MP3000			MK1500			MK2050			
	100%	30%	10%	100%	30%	10%	100%	30%	10%	100%	30%	10%	100%	30%	10%	100%	30%	10%	
P1	285	375	450	285	380	445	255	335	395	240	315	375	—	—	—	250	330	390	
	940	1225	1475	940	1250	1450	840	1100	1300	790	1025	1225	—	—	—	820	1075	1275	
P2	275	365	430	280	370	435	240	325	380	230	310	360	—	—	—	240	320	375	
	900	1200	1400	920	1225	1425	790	1075	1250	750	1025	1175	—	—	—	790	1050	1225	
P3	240	320	375	245	325	380	210	285	335	200	270	315	—	—	—	210	280	330	
	790	1050	1225	800	1075	1250	690	940	1100	660	890	1025	—	—	—	690	920	1075	
P4	215	280	335	215	285	335	190	250	300	180	235	285	—	—	—	185	245	295	
	710	920	1100	710	940	1100	620	820	980	590	770	940	—	—	—	610	800	970	
P5	205	270	320	205	275	320	180	240	285	170	225	270	—	—	—	180	235	280	
	670	890	1050	670	900	1050	590	790	940	560	740	890	—	—	—	590	770	920	
P6	230	305	360	230	305	365	205	270	320	195	260	305	—	—	—	200	270	315	
	750	1000	1175	750	1000	1200	670	890	1050	640	850	1000	—	—	—	660	890	1025	
P7	215	290	340	220	290	345	190	255	300	180	245	285	—	—	—	190	255	300	
	710	950	1125	720	950	1125	620	840	980	590	800	940	—	—	—	620	840	980	
P8	200	270	315	205	275	320	180	240	280	170	225	265	—	—	—	175	235	275	
	660	890	1025	670	900	1050	590	790	920	560	740	870	—	—	—	570	770	900	
P11	210	280	330	210	280	335	185	250	295	175	235	280	—	—	—	185	245	290	
	690	920	1075	690	920	1100	610	820	970	570	770	920	—	—	—	610	800	950	
P12	140	185	220	140	185	215	120	160	195	115	155	185	—	—	—	120	160	190	
	460	610	720	460	610	710	395	520	640	375	510	610	—	—	—	395	520	620	
M1	—	—	—	200	265	310	175	235	275	170	230	270	—	—	—	—	—	—	
	—	—	—	660	870	1025	570	770	900	560	750	890	—	—	—	—	—	—	
M2	—	—	—	165	220	255	145	190	230	145	190	225	—	—	—	—	—	—	
	—	—	—	540	720	840	475	620	750	475	620	740	—	—	—	—	—	—	
M3	—	—	—	135	180	205	120	155	185	115	155	185	—	—	—	—	—	—	
	—	—	—	445	590	670	395	510	610	375	510	610	—	—	—	—	—	—	
M4	—	—	—	105	140	160	95	125	145	90	120	140	—	—	—	—	—	—	
	—	—	—	345	460	520	310	410	475	295	395	460	—	—	—	—	—	—	
M5	—	—	—	85	115	135	80	105	120	75	100	120	—	—	—	—	—	—	
	—	—	—	280	375	445	260	345	395	245	330	395	—	—	—	—	—	—	
K1	215	290	340	220	295	345	190	255	300	180	245	285	270	365	425	255	345	405	
	710	950	1125	720	970	1125	620	840	980	590	800	940	890	1200	1400	840	1125	1325	
K2	195	255	305	195	260	305	170	225	270	165	215	255	245	320	385	230	305	365	
	640	840	1000	640	850	1000	560	740	890	540	710	840	800	1050	1275	750	1000	1200	
K3	165	215	260	165	220	260	145	190	230	140	180	215	205	270	325	195	255	305	
	540	710	850	540	720	850	475	620	750	460	590	710	670	890	1075	640	840	1000	
K4	155	205	245	160	210	245	140	185	220	130	175	205	195	260	310	185	245	295	
	510	670	800	520	690	800	460	610	720	425	570	670	640	850	1025	610	800	970	
K5	95	125	150	95	125	150	85	115	135	80	105	125	120	160	190	115	150	180	
	310	410	490	310	410	490	280	375	445	260	345	410	395	520	620	375	490	590	
K6	140	180	220	140	185	215	120	160	195	115	155	180	175	230	275	165	215	260	
	460	590	720	460	610	710	395	520	640	375	510	590	570	750	900	540	710	850	
K7	125	165	190	125	165	195	110	145	170	105	135	160	155	205	240	150	195	230	
	410	540	620	410	540	640	360	475	560	345	445	520	510	670	790	490	640	750	
N1	—	—	—	—	—	—	—	—	—	1325	1775	2100	—	—	—	—	—	—	
	—	—	—	—	—	—	—	—	—	4350	5825	6900	—	—	—	—	—	—	
N2	—	—	—	—	—	—	—	—	—	—	540	720	850	—	—	—	—	—	—
	—	—	—	—	—	—	—	—	—	1775	2350	2800	—	—	—	—	—	—	
N3	—	—	—	—	—	—	—	—	—	—	360	480	570	—	—	—	—	—	—
	—	—	—	—	—	—	—	—	—	1175	1575	1875	—	—	—	—	—	—	
N11	—	—	—	—	—	—	—	—	—	—	410	550	650	—	—	—	—	—	—
	—	—	—	—	—	—	—	—	—	1350	1800	2125	—	—	—	—	—	—	
S1	—	—	—	50	70	80	46	60	70	43	55	65	—	—	—	—	—	—	
	—	—	—	165	230	260	150	195	230	140	180	215	—	—	—	—	—	—	
S2	—	—	—	41	55	65	37	49	55	35	46	55	—	—	—	—	—	—	
	—	—	—	135	180	215	120	160	180	115	150	180	—	—	—	—	—	—	
S3	—	—	—	37	48	55	32	43	50	31	40	47	—	—	—	—	—	—	
	—	—	—	120	155	180	105	140	165	100	130	155	—	—	—	—	—	—	
S11	—	—	—	70	95	110	65	85	100	60	80	95	—	—	—	—	—	—	
	—	—	—	230	310	360	215	280	330	195	260	310	—	—	—	—	—	—	
S12	—	—	—	49	65	75	43	60	70	41	55	65	—	—	—	—	—	—	
	—	—	—	160	215	245	140	195	230	135	180	215	—	—	—	—	—	—	
S13	—	—	—	29	38	44	26	34	39	24	32	37	—	—	—	—	—	—	
	—	—	—	95	125	145	85	110	130	80	105	120	—	—	—	—	—	—	
H5	46	60	70	42	55	65	37	49	60	36	48	55	—	—	—	—	—	—	
	150	195	230	140	180	215	120	160	195	120	155	180	—	—	—	—	—	—	
H8	50	65	75	45	60	70	40	55	60	39	50	60	—	—	—	—	—	—	
	165	215	245	150	195	230	130	180	195	130	165	195	—	—	—	—	—	—	
H11	60	75	90	55	70	85	47	60	75	46	60	70	—	—	—	—	—	—	
	195	245	295	180	230	280	155	195	245	150	195	230	—	—	—	—	—	—	
H12	90	120	140	90	115	135	80	105	120	75	100	115	—	—	—	—	—	—	
	295	395	460	295	375	445	260	345	395	245	330	375	—	—	—	—	—	—	

R217/220.69-16 – Cutting data $v_c = (m/min)/(sf/min)$

SMG	MS2050			MS2500			T350M			F40M			H25		
	100%	30%	10%	100%	30%	10%	100%	30%	10%	100%	30%	10%	100%	30%	10%
P1	245	320	375	320	420	495	220	290	345	220	295	345	—	—	—
	800	1050	1225	1050	1375	1625	720	950	1125	720	970	1125	—	—	—
P2	235	315	365	310	410	480	210	285	330	215	285	335	—	—	—
	770	1025	1200	1025	1350	1575	690	940	1075	710	940	1100	—	—	—
P3	210	275	325	270	360	425	185	245	290	190	250	295	—	—	—
	690	900	1075	890	1175	1400	610	800	950	620	820	970	—	—	—
P4	185	240	285	240	315	375	165	220	260	165	220	260	—	—	—
	610	790	940	790	1025	1225	540	720	850	540	720	850	—	—	—
P5	175	230	275	230	305	355	160	210	250	160	210	250	—	—	—
	570	750	900	750	1000	1175	520	690	820	520	690	820	—	—	—
P6	195	260	310	255	340	405	175	235	280	180	235	280	—	—	—
	640	850	1025	840	1125	1325	570	770	920	590	770	920	—	—	—
P7	185	245	295	240	320	385	165	225	265	170	225	265	—	—	—
	610	800	970	790	1050	1275	540	740	870	560	740	870	—	—	—
P8	175	230	275	230	305	355	155	210	245	160	210	250	—	—	—
	570	750	900	750	1000	1175	510	690	800	520	690	820	—	—	—
P11	180	240	285	235	310	370	165	220	255	165	215	260	—	—	—
	590	790	940	770	1025	1225	540	720	840	540	710	850	—	—	—
P12	120	155	185	155	205	240	105	140	170	110	140	165	—	—	—
	395	510	610	510	670	790	345	460	560	360	460	540	—	—	—
M1	190	255	295	220	295	345	165	220	255	175	230	270	—	—	—
	620	840	970	720	970	1125	540	720	840	570	750	890	—	—	—
M2	155	210	245	185	240	285	135	180	215	145	190	225	—	—	—
	510	690	800	610	790	940	445	590	710	475	620	740	—	—	—
M3	130	170	200	150	200	230	110	145	175	115	155	180	—	—	—
	425	560	660	490	660	750	360	475	570	375	510	590	—	—	—
M4	100	130	155	115	155	180	85	115	135	90	120	140	—	—	—
	330	425	510	375	510	590	280	375	445	295	395	460	—	—	—
M5	85	110	130	95	125	150	75	95	110	75	100	115	—	—	—
	280	360	425	310	410	490	245	310	360	245	330	375	—	—	—
K1	—	—	—	—	—	—	165	225	260	—	—	—	—	—	—
	—	—	—	—	—	—	540	740	850	—	—	—	—	—	—
K2	—	—	—	—	—	—	150	195	235	—	—	—	—	—	—
	—	—	—	—	—	—	490	640	770	—	—	—	—	—	—
K3	—	—	—	—	—	—	125	165	200	—	—	—	—	—	—
	—	—	—	—	—	—	410	540	660	—	—	—	—	—	—
K4	—	—	—	—	—	—	120	160	190	—	—	—	—	—	—
	—	—	—	—	—	—	395	520	620	—	—	—	—	—	—
K5	—	—	—	—	—	—	75	100	115	—	—	—	—	—	—
	—	—	—	—	—	—	245	330	375	—	—	—	—	—	—
K6	—	—	—	—	—	—	105	140	170	—	—	—	—	—	—
	—	—	—	—	—	—	345	460	560	—	—	—	—	—	—
K7	—	—	—	—	—	—	95	125	150	—	—	—	—	—	—
	—	—	—	—	—	—	310	410	490	—	—	—	—	—	—
N1	—	—	—	—	—	—	—	—	—	1275	1675	1950	1350	1800	2125
	—	—	—	—	—	—	—	—	—	4175	5500	6400	4425	5900	6975
N2	—	—	—	—	—	—	—	—	—	510	670	790	550	730	850
	—	—	—	—	—	—	—	—	—	1675	2200	2600	1800	2400	2800
N3	—	—	—	—	—	—	—	—	—	340	450	530	365	485	570
	—	—	—	—	—	—	—	—	—	1125	1475	1750	1200	1600	1875
N11	—	—	—	—	—	—	—	—	—	390	510	600	420	560	650
	—	—	—	—	—	—	—	—	—	1275	1675	1975	1375	1825	2125
S1	47	60	70	55	75	85	41	55	65	42	55	65	—	—	—
	155	195	230	180	245	280	135	180	215	140	180	215	—	—	—
S2	37	49	60	46	60	70	33	43	50	34	45	50	—	—	—
	120	160	195	150	195	230	110	140	165	110	150	165	—	—	—
S3	33	43	50	41	55	60	29	38	45	30	39	46	—	—	—
	110	140	165	135	180	195	95	125	150	100	130	150	—	—	—
S11	65	85	100	80	105	120	55	75	90	60	80	90	—	—	—
	215	280	330	260	345	395	180	245	295	195	260	295	—	—	—
S12	45	60	70	55	75	85	39	50	60	41	55	65	—	—	—
	150	195	230	180	245	280	130	165	195	135	180	215	—	—	—
S13	26	35	40	32	42	49	23	30	35	24	31	37	—	—	—
	85	115	130	105	140	160	75	100	115	80	100	120	—	—	—
H5	—	—	—	—	—	—	35	47	55	36	47	55	—	—	—
	—	—	—	—	—	—	115	155	180	120	155	180	—	—	—
H8	—	—	—	—	—	—	38	50	60	—	—	—	—	—	—
	—	—	—	—	—	—	125	165	195	—	—	—	—	—	—
H11	—	—	—	—	—	—	45	60	70	—	—	—	—	—	—
	—	—	—	—	—	—	150	195	230	—	—	—	—	—	—
H12	—	—	—	100	130	150	70	90	105	70	90	105	—	—	—
	—	—	—	330	425	490	230	295	345	230	295	345	—	—	—

Square shoulder and slot milling cutters
Helical milling cutters
Face milling cutters
Disc milling cutters
High feed milling cutters
Copy milling cutters
Plunge milling cutters
Chamfer milling cutters
Spot facing cutters
Inserts

Turbo 18 – R217.69-18 – Metric

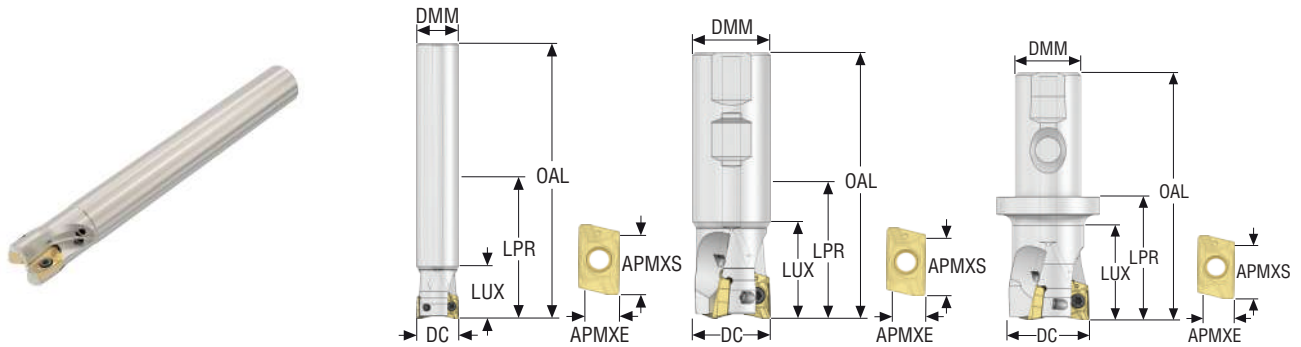

- For insert selection and cutting data recommendations, see page(s) 73-75
- For complete insert programme, see page(s) 873, 874
- For ISO attribute explanation, see page 16
- KAPRS 90°

Designation	Item number	Type of mounting	DC	ZEFP	APMXS	APMXE	DMM	LUX	LPR	OAL	RMPX°	Cmin	Cmax	RPMX	Weight	Insert
			mm		mm	mm	mm	mm	mm	mm		mm	mm		kg	
R217.69-3032.0-18-2AN	02691799	Cylindrical	32,0	2	17,0	10,0	30,0	150,0	150,0	210,0	7,0	46,0	61,5	11100	1,1	XO.X18..
R217.69-3232.0-18-2AN	02691795	Cylindrical	32,0	2	17,0	10,0	32,0	40,0	150,0	210,0	7,0	46,0	61,5	11100	1,2	XO.X18..
R217.69-3232.0-18-3AN	02691796	Cylindrical	32,0	3	17,0	10,0	32,0	40,0	150,0	210,0	7,0	46,0	61,5	11100	1,3	XO.X18..
R217.69-3240.0-18-3AN	02691797	Cylindrical	40,0	3	17,0	10,0	32,0	150,0	150,0	210,0	4,5	62,0	77,5	9900	1,2	XO.X18..
R217.69-3240.0-18-4AN	02691798	Cylindrical	40,0	4	17,0	10,0	32,0	150,0	150,0	210,0	4,5	62,0	77,5	9900	1,2	XO.X18..
R217.69-3232.3-18-2AN	02691792	Weldon	32,0	2	17,0	10,0	32,0	38,0	50,0	110,0	7,0	46,0	61,5	11100	0,6	XO.X18..
R217.69-3232.3-18-3AN	02691793	Weldon	32,0	3	17,0	10,0	32,0	38,0	50,0	110,0	7,0	46,0	61,5	11100	0,6	XO.X18..
R217.69-2532.3S-18-2AN	02691790	Seco-Weldon	32,0	2	17,0	10,0	25,0	40,0	54,0	109,5	7,0	46,0	61,5	11100	0,5	XO.X18..
R217.69-3240.3S-18-3AN	02691791	Seco-Weldon	40,0	3	17,0	10,0	32,0	46,0	60,0	119,5	4,5	62,0	77,5	9900	0,8	XO.X18..

Modification of the cutter body needed for radii > 4,0 mm

Spare Parts, included in delivery

For cutter	Insert key	Insert screw
R217.69-..	H6B-T20P	C04510-T20P

Accessories

For cutter	Insert clamping torque	Torque key
R217.69-..	5.0NM	T00-20P50

Torque and fixed keys, see page 894

Turbo 18 – R217.69-18 – inch

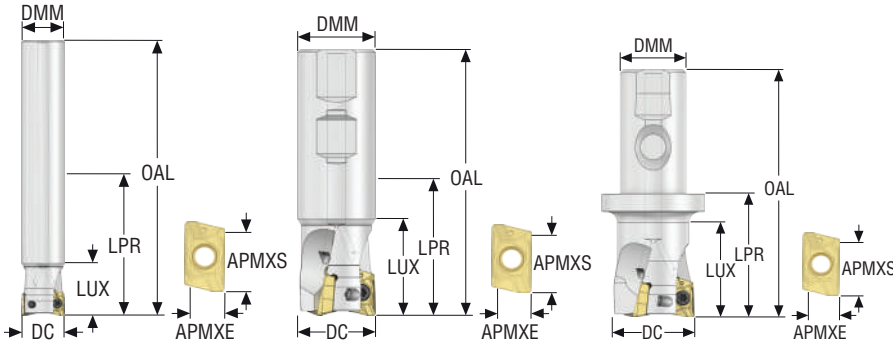

- For insert selection and cutting data recommendations, see page(s) 73-75
- For complete insert programme, see page(s) 873, 874
- For ISO attribute explanation, see page 16
- KAPRS 90°

Designation	Item number	Type of mounting	DC	ZEFP	APMXS	APMXE	DMM	LUX	LPR	OAL	RMPX°	C min	C max	RPMX	Weight	Insert
			inch		inch	inch	inch	inch	inch	inch		inch	inch		lbs	
R217.69-01.00-0-18-2LAN	02699117	Cylindrical	1.000	2	0.669	0.394	1.000	1.575	4.488	6.693	5,0	1.280	1.890	13800	1.540	XO.X18
R217.69-01.25-0-18-2LAN	02694932	Cylindrical	1.250	2	0.669	0.394	1.000	5.315	5.315	7.677	2,0	1.791	2.402	11100	1.980	XO.X18
R217.69-01.25-0-18-3LAN	02694936	Cylindrical	1.250	3	0.669	0.394	1.000	5.472	5.472	7.677	7,0	1.791	2.402	11100	1.980	XO.X18
R217.69-01.50-0-18-3LAN	02694937	Cylindrical	1.500	3	0.669	0.394	1.250	5.906	5.906	8.268	4,5	2.283	2.894	9900	3.090	XO.X18
R217.69-01.50-0-18-4LAN	02694938	Cylindrical	1.500	4	0.669	0.394	1.250	5.906	5.906	8.268	4,5	2.283	2.894	9900	2.870	XO.X18
R217.69-01.00-3-18-2AN	02699130	Weldon	1.000	2	0.669	0.394	1.000	1.575	1.732	3.937	6,0	1.280	1.890	13800	1.100	XO.X18
R217.69-01.25-3-18-3AN	02694949	Weldon	1.250	3	0.669	0.394	1.250	1.575	1.969	4.331	7,0	1.791	2.402	11100	1.320	XO.X18
R217.69-01.50-3-18-3AN	02694951	Weldon	1.500	3	0.669	0.394	1.250	2.362	2.362	4.724	4,5	2.283	2.894	9900	1.540	XO.X18
R217.69-01.50-3-18-4AN	02694954	Weldon	1.500	4	0.669	0.394	1.250	2.362	2.362	4.724	4,5	2.283	2.894	9900	1.540	XO.X18

Modification of the cutter body needed for radii > 0.158 in

Spare Parts, included in delivery

For cutter	Insert key	Insert screw
R217.69-..	H6B-T20P	C04510-T20P

Accessories

For cutter	Insert clamping torque	Torque key
R217.69-..	44.3IN.LBS	T00-20P50

Torque and fixed keys, see page 894

Turbo 18 – R217/220.69-18 – Metric

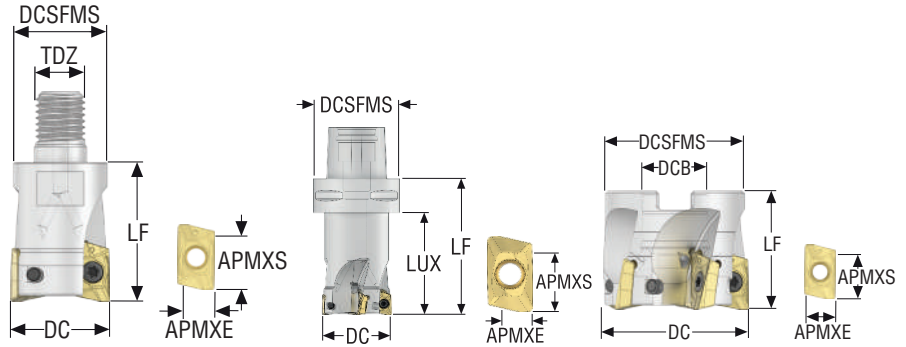

- For insert selection and cutting data recommendations, see page(s) 73-75
- For complete insert programme, see page(s) 873, 874
- For ISO attribute explanation, see page 16
- KAPRS 90°





Designation	Item number	Type of mounting	DC	ZEPF	APMXS	APMXE	DCB	TDZ	DCSFMS	LUX	LF	RMPX°	Cmin	Cmax	RPMX	Weight	Insert
			mm	mm	mm	mm	mm	mm	mm	mm	mm	mm	mm	mm	mm	mm	kg
R217.69-1632.RE-18-2AN	02691807	Combimaster	32,0	2	17,0	10,0	–	M16	30,0	–	45,0	7,0	46,0	61,5	11100	0,2	XO.X18..
R217.69-1632.RE-18-3AN	02691805	Combimaster	32,0	3	17,0	10,0	–	M16	30,0	–	45,0	7,0	46,0	61,5	11100	0,3	XO.X18..
R217.69-1640.RE-18-3AN	02691808	Combimaster	40,0	3	17,0	10,0	–	M16	30,0	–	45,0	4,5	62,0	77,5	9900	0,3	XO.X18..
R217.69-1640.RE-18-4AN	02691806	Combimaster	40,0	4	17,0	10,0	–	M16	30,0	–	45,0	4,5	62,0	77,5	9900	0,3	XO.X18..
R217.69-2040.RE-18-3AN	02972711	Combimaster	40,0	3	17,0	10,0	–	M20	36,5	–	45,0	4,5	62,0	77,5	9900	0,4	XO.X18..
R217.69-2040.RE-18-4AN	02753402	Combimaster	40,0	4	17,0	10,0	–	M20	36,5	–	45,0	4,5	62,0	77,5	9900	0,4	XO.X18..
C6-R217.69-040-18-3AN	02707507	Seco-Capto	40,0	3	17,0	10,0	–	–	63,0	55,0	80,0	4,5	62,0	77,5	9900	1,1	XO.X18..
C6-R217.69-066-18-5AN	02707509	Seco-Capto	66,0	5	17,0	10,0	–	–	63,0	60,0	60,0	2,0	114,0	129,5	7700	1,4	XO.X18..
C6-R217.69-080-18-6AN	02707511	Seco-Capto	80,0	6	17,0	10,0	–	–	63,0	60,0	60,0	1,5	142,0	157,5	7000	1,7	XO.X18..
R220.69-0040-18-4AN	03004031	Arbor	40,0	4	17,0	10,0	16,0	–	35,0	–	40,0	4,5	62,0	77,5	9900	0,2	XO.X18..
R220.69-0050-18-4AN	02701130	Arbor	50,0	4	17,0	10,0	22,0	–	47,0	–	40,0	3,0	82,0	97,5	8900	0,3	XO.X18..
R220.69-0050-18-5AN	02691824	Arbor	50,0	5	17,0	10,0	22,0	–	47,0	–	40,0	3,0	82,0	97,5	8900	0,3	XO.X18..
R220.69-0052-18-4AN	02969087	Arbor	52,0	4	17,0	10,0	22,0	–	47,0	–	40,0	3,15	86,0	101,5	8900	0,5	XO.X18..
R220.69-0063-18-4AN	02691810	Arbor	63,0	4	17,0	10,0	27,0	–	52,0	–	40,0	2,4	108,0	123,5	7900	0,5	XO.X18..
R220.69-0063-18-5AN	02691825	Arbor	63,0	5	17,0	10,0	27,0	–	52,0	–	40,0	2,4	108,0	123,5	7900	0,5	XO.X18..
R220.69-0063-18-6AN	02691826	Arbor	63,0	6	17,0	10,0	27,0	–	52,0	–	40,0	2,4	108,0	123,5	7900	0,5	XO.X18..
R220.69-0066-18-5AN	02969088	Arbor	66,0	5	17,0	10,0	27,0	–	52,0	–	40,0	2,0	114,0	129,5	7900	0,6	XO.X18..
R220.69-0080-18-5AN	02691811	Arbor	80,0	5	17,0	10,0	27,0	–	62,0	–	50,0	1,5	142,0	157,5	7000	1,0	XO.X18..
R220.69-0080-18-6AN	02691827	Arbor	80,0	6	17,0	10,0	27,0	–	62,0	–	50,0	1,5	142,0	157,5	7000	1,0	XO.X18..
R220.69-0080-18-8AN	02691828	Arbor	80,0	8	17,0	10,0	27,0	–	62,0	–	50,0	1,5	142,0	157,5	7000	1,0	XO.X18..
R220.69-0084-18-6AN	02440816	Arbor	84,0	6	17,0	10,0	27,0	–	62,0	–	50,0	1,5	150,0	165,5	7000	1,3	XO.X18..
R220.69-0100-18-6AN	02691817	Arbor	100,0	6	17,0	10,0	32,0	–	77,0	–	50,0	1,0	182,0	197,5	6300	1,6	XO.X18..
R220.69-0100-18-7AN	02691820	Arbor	100,0	7	17,0	10,0	32,0	–	77,0	–	50,0	1,0	182,0	197,5	6300	1,6	XO.X18..
R220.69-0100-18-9AN	02691822	Arbor	100,0	9	17,0	10,0	32,0	–	77,0	–	50,0	1,0	182,0	197,5	6300	1,6	XO.X18..
R220.69-0125-18-7AN	02691818	Arbor	125,0	7	17,0	10,0	40,0	–	90,0	–	63,0	1,0	232,0	247,5	5600	3,1	XO.X18..
R220.69-0125-18-8AN	02691823	Arbor	125,0	8	17,0	10,0	40,0	–	90,0	–	63,0	1,0	232,0	247,5	5600	3,0	XO.X18..
R220.69-0125-18-11AN	02691815	Arbor	125,0	11	17,0	10,0	40,0	–	90,0	–	63,0	1,0	232,0	247,5	5600	3,0	XO.X18..
R220.69-8160-18-7N	02691814	Arbor	160,0	7	17,0	10,0	40,0	–	90,0	–	63,0	0,5	302,0	317,5	5000	4,5	XO.X18..
R220.69-8160-18-9N	02691813	Arbor	160,0	9	17,0	10,0	40,0	–	90,0	–	63,0	0,5	302,0	317,5	5000	4,6	XO.X18..
R220.69-8160-18-12N	02691809	Arbor	160,0	12	17,0	10,0	40,0	–	90,0	–	63,0	0,5	302,0	317,5	5000	4,6	XO.X18..

Modification of the cutter body needed for radii > 4,0 mm
For Combimaster Shanks, see Machining Navigator Tooling System

Spare Parts, included in delivery

For cutter	Arbor screw	Insert key	Insert screw
			
Cx/R217.69-..	-	H6B-T20P	C04510-T20P
R220.69-0040	TCEI0825	H6B-T20P	C04510-T20P
R220.69-0050-0052	220.17-692	H6B-T20P	C04510-T20P
R220.69-0063-0066	220.17-693	H6B-T20P	C04510-T20P
R220.69-0080-0100	-	H6B-T20P	C04510-T20P
R220.69-0080-0100	-	H6B-T20PL	C04510-T20P
R220.69-0125	-	1/4HEX-T20PX90	C04510-T20P
R220.69-0125	-	H6B-T20PL	C04510-T20P
R220.69-8160	-	1/4HEX-T20PX90	C04510-T20P

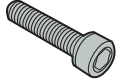
Accessories

For cutter	Adjustable Torque key	Adjustable Torque key 2	Arbor screw	Insert clamping torque	Torque key
					
Cx/R217/220.69-1632-0100	-	-	-	5.0NM	T00-20P50
R220.69-0125	1/4HEX-S-HANDLE-0.8-5.0NM	1/4HEX-T-HANDLE-5.0-14.0NM	-	5.0NM	T00-20P50
R220.69-0125-11AN	-	-	-	5.0NM	T00-20P50
R220.69-8160	1/4HEX-S-HANDLE-0.8-5.0NM	1/4HEX-T-HANDLE-5.0-14.0NM	MC6S12X40	5.0NM	T00-20P50

Torque and fixed keys, see page 894

Square shoulder and slot milling cutters
Helical milling cutters
Face milling cutters
Disc milling cutters
High feed milling cutters
Copy milling cutters
Plunge milling cutters
Chamfer milling cutters
Spot facing cutters
Inserts

Turbo 18 – R217/220.69-18 – inch

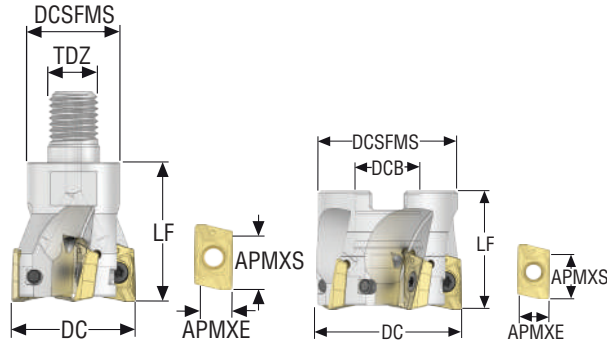

- For insert selection and cutting data recommendations, see page(s) 73-75
- For complete insert programme, see page(s) 873, 874
- For ISO attribute explanation, see page 16
- KAPRS 90°

Designation	Item number	Type of mounting	DC	ZFEP	APMXS	APMXE	DCB	TDZ	DCSFMS	LF	RMPX°	C min	C max	RPMX	Weight	Insert
			inch		inch	inch	inch		inch	inch		inch	inch		lbs	
R217.69-01.00-12RE-18-2AN	02699134	Combimaster	1.000	2	0.669	0.394	–	M12	0.906	1.575	6.0	1.280	1.890	13800	0.660	XO.X18
R217.69-01.25-16RE-18-3AN	02699137	Combimaster	1.250	3	0.669	0.394	–	M16	1.181	1.772	7.0	1.791	2.402	11100	0.660	XO.X18
R217.69-01.50-16RE-18-3AN	02699141	Combimaster	1.500	3	0.669	0.394	–	M16	1.181	1.772	4.5	2.283	2.894	9900	0.880	XO.X18
R217.69-01.50-16RE-18-4AN	02699143	Combimaster	1.500	4	0.669	0.394	–	M16	1.181	1.772	4.5	2.283	2.894	9900	0.880	XO.X18
R220.69-02.00-18-3AN	02694974	Arbor	2.000	3	0.669	0.394	0.750	–	1.850	1.575	3.0	3.287	3.898	8900	0.880	XO.X18
R220.69-02.00-18-4AN	02694975	Arbor	2.000	4	0.669	0.394	0.750	–	1.850	1.575	3.0	3.287	3.898	8900	0.880	XO.X18
R220.69-02.00-18-5AN	02694976	Arbor	2.000	5	0.669	0.394	0.750	–	1.850	1.575	3.0	3.287	3.898	8900	0.660	XO.X18
R220.69-02.50-18-5AN	02694979	Arbor	2.500	5	0.669	0.394	0.750	–	1.850	1.575	2.0	4.291	4.902	7900	1.100	XO.X18
R220.69-02.50-18-6AN	02694981	Arbor	2.500	6	0.669	0.394	0.750	–	1.850	1.575	2.0	4.291	4.902	7900	1.100	XO.X18
R220.69-03.00-18-6AN	02694985	Arbor	3.000	6	0.669	0.394	1.000	–	2.441	1.969	1.5	5.276	5.886	7000	2.200	XO.X18
R220.69-03.00-18-8AN	02694987	Arbor	3.000	8	0.669	0.394	1.000	–	2.441	1.969	1.5	5.276	5.886	7000	1.980	XO.X18
R220.69-04.00-18-5AN	02694990	Arbor	4.000	5	0.669	0.394	1.500	–	3.543	1.969	1.0	7.283	7.894	6300	4.410	XO.X18
R220.69-04.00-18-7AN	02694992	Arbor	4.000	7	0.669	0.394	1.500	–	3.543	1.969	1.0	7.283	7.894	6300	4.410	XO.X18
R220.69-04.00-18-9AN	02694993	Arbor	4.000	9	0.669	0.394	1.500	–	3.543	1.969	1.0	7.283	7.894	6300	4.190	XO.X18
R220.69-05.00-18-8AN	02694995	Arbor	5.000	8	0.669	0.394	1.500	–	3.543	2.480	1.0	9.291	9.902	5600	7.720	XO.X18
R220.69-05.00-18-11AN	02694994	Arbor	5.000	11	0.669	0.394	1.500	–	3.543	2.480	1.0	9.291	9.902	5600	7.720	XO.X18
R220.69-06.00-18-9N	02694997	Arbor	6.000	9	0.669	0.394	2.000	–	4.331	2.480	0.5	11.280	11.890	5000	9.480	XO.X18
R220.69-06.00-18-12N	02694996	Arbor	6.000	12	0.669	0.394	2.000	–	4.331	2.480	0.5	11.280	11.890	5000	9.260	XO.X18

Modification of the cutter body needed for radii > 0.158 in
For Combimaster Shanks, see Machining Navigator Tooling System

Square shoulder and slot milling cutters
Helical milling cutters
Face milling cutters
Disc milling cutters
High feed milling cutters
Copy milling cutters
Plunge milling cutters
Chamfer milling cutters
Spot facing cutters
Inserts

Spare Parts, included in delivery

For cutter	Arbor screw	Insert key	Insert screw
R217.69-..	-	H6B-T20P	C04510-T20P
R220.69-02.00-02.50	220.17-695	H6B-T20P	C04510-T20P
R220.69-03.00	UC6S1/2UNFX1-1/4	H6B-T20P	C04510-T20P
R220.69-04.00	UF6S3/4UNFX2	H6B-T20PL	C04510-T20P
R220.69-05.00	UC6S3/4UNFX1-1/4	1/4HEX-T20PX90	C04510-T20P
R220.69-06.00	-	1/4HEX-T20PX90	C04510-T20P

Accessories

For cutter	Adjustable Torque key	Adjustable Torque key 2	Arbor screw	Insert clamping torque	Torque key
R217/220.69-01.00-04.00	-	-	-	44.3IN.LBS	T00-20P50
R220.69-05.00	1/4HEX-S-HANDLE-0.8-5.0NM	1/4HEX-T-HANDLE-5.0-14.0NM	-	44.3IN.LBS	T00-20P50
R220.69-06.00	1/4HEX-S-HANDLE-0.8-5.0NM	1/4HEX-T-HANDLE-5.0-14.0NM	58215080	44.3IN.LBS	T00-20P50

Torque and fixed keys, see page 894

- Square shoulder and slot milling cutters
- Helical milling cutters
- Face milling cutters
- Disc milling cutters
- High feed milling cutters
- Copy milling cutters
- Plunge milling cutters
- Chamfer milling cutters
- Spot facing cutters
- Inserts

Turbo 18 – R220.69-18 – Metric

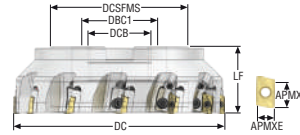

- For insert selection and cutting data recommendations, see page(s) 73-75
- For complete insert programme, see page(s) 873, 874
- For ISO attribute explanation, see page 16
- KAPRS 90°

Designation	Item number	Type of mounting	DC	ZEFP	APMXS	APMXE	DCB	DCSFMS	LF	RMPX°	Cmin	Cmax	RPMX	Weight	Insert
			mm		mm	mm	mm	mm	mm		mm	mm		kg	
R220.69-0125-18-8CN	02706947	Arbor	125,0	8	17,0	10,0	40,0	90,0	63,0	1,0	232,0	247,5	5600	3,3	XO.X18..
R220.69-8160-18-10CN	02706948	Arbor	160,0	10	17,0	10,0	40,0	90,0	63,0	0,7	302,0	317,5	5000	5,2	XO.X18..
R220.69-8200-18-12CN	02706950	Arbor	200,0	12	17,0	10,0	60,0	130,0	63,0	0,5	382,0	397,5	4400	7,4	XO.X18..
R220.69-8250-18-16CN	02706951	Arbor	250,0	16	17,0	10,0	60,0	130,0	63,0	0,4	482,0	497,5	3900	14,7	XO.X18..

Modification of the cutter body needed for radii > 4,0 mm

Spare Parts, included in delivery

For cutter	Adjustment unit	Cassette	Cassette screw	Insert key	Insert screw
R220.69-0125-8250	AU1114T-T15P	XO18PRN	FS96018	H6B-T20PL	C04510-T20P
R220.69-8160	AU1114T-T15P	XO18PRN	FS96018	H6B-T20PL	C04510-T20P
R220.69-8200-8250	AU1114T-T15P	XO18PRN	FS96018	H6B-T20PL	C04510-T20P

Accessories

For cutter	Allen key	Arbor screw	Insert clamping torque	Torque key
R220.69-0125-8250	H05-4	-	5.0NM	T00-20P50
R220.69-8160	H05-4	MC6S12X40	5.0NM	T00-20P50
R220.69-8200-8250	H05-4	MC6S16X50	5.0NM	T00-20P50

Torque and fixed keys, see page 894

R217/220.69-18 – Insert selection – mm/Inch

SMG		a _p	f _z		
			100%	30%	10%
P1	XOMX180608TR-ME13 F40M	8,0	0,18	0,20	0,30
		0,32	0,0070	0,0080	0,012
P2	XOMX180608TR-ME13 F40M	8,0	0,19	0,20	0,32
		0,32	0,0075	0,0080	0,013
P3	XOMX180608TR-M14 MP2501	8,0	0,19	0,20	0,32
		0,32	0,0075	0,0080	0,013
P4	XOMX180608TR-M14 MP2501	8,0	0,19	0,20	0,32
		0,32	0,0075	0,0080	0,013
P5	XOMX180608TR-M14 MP2501	8,0	0,18	0,20	0,30
		0,32	0,0070	0,0080	0,012
P6	XOMX180608TR-M14 MP2501	8,0	0,18	0,20	0,30
		0,32	0,0070	0,0080	0,012
P7	XOMX180608TR-M14 MP2501	8,0	0,18	0,20	0,30
		0,32	0,0070	0,0080	0,012
P8	XOMX180612TR-M14 MP2501	8,0	0,19	0,20	0,32
		0,32	0,0075	0,0080	0,013
P11	XOMX180608TR-M14 T350M	8,0	0,18	0,20	0,30
		0,32	0,0070	0,0080	0,012
P12	XOMX180608TR-M14 MP3000	7,0	0,12	0,14	0,20
		0,28	0,0048	0,0055	0,0080
M1	XOMX180608TR-M14 F40M	8,0	0,20	0,22	0,34
		0,32	0,0080	0,0085	0,013
M2	XOMX180608TR-M14 F40M	8,0	0,18	0,20	0,30
		0,32	0,0070	0,0080	0,012
M3	XOMX180608TR-M14 F40M	7,0	0,15	0,16	0,24
		0,28	0,0060	0,0065	0,0095
M4	XOMX180608R-M10 T350M	5,0	0,090	0,10	0,15
		0,20	0,0036	0,0040	0,0060
M5	XOMX180608R-M10 T350M	5,0	0,090	0,10	0,15
		0,20	0,0036	0,0040	0,0060
K1	XOMX180608TR-M14 MK2050	8,0	0,20	0,22	0,34
		0,32	0,0080	0,0085	0,013
K2	XOMX180608TR-M14 MK2050	8,0	0,18	0,20	0,30
		0,32	0,0070	0,0080	0,012
K3	XOMX180608TR-M14 MK2050	8,0	0,18	0,20	0,30
		0,32	0,0070	0,0080	0,012
K4	XOMX180608TR-M14 MK2050	8,0	0,18	0,20	0,30
		0,32	0,0070	0,0080	0,012
K5	XOMX180608TR-M14 MK2050	8,0	0,16	0,18	0,28
		0,32	0,0065	0,0070	0,011
K6	XOMX180608TR-M14 MK2050	8,0	0,18	0,20	0,30
		0,32	0,0070	0,0080	0,012
K7	XOMX180608TR-M14 MK2050	8,0	0,16	0,18	0,28
		0,32	0,0065	0,0070	0,011
N1	XOEX180608FR-E10 H25	8,0	0,18	0,20	0,30
		0,32	0,0070	0,0080	0,012
N2	XOEX180608FR-E10 H25	8,0	0,18	0,20	0,30
		0,32	0,0070	0,0080	0,012
N3	XOEX180608FR-E10 H25	8,0	0,18	0,20	0,30
		0,32	0,0070	0,0080	0,012
N11	XOEX180608FR-E10 H25	8,0	0,18	0,20	0,30
		0,32	0,0070	0,0080	0,012
S1	XOMX180608R-M10 T350M	5,0	0,090	0,10	0,15
		0,20	0,0036	0,0040	0,0060
S2	XOMX180608R-M10 T350M	5,0	0,090	0,10	0,15
		0,20	0,0036	0,0040	0,0060
S3	XOMX180608R-M10 T350M	5,0	0,085	0,095	0,14
		0,20	0,0034	0,0038	0,0055
S11	XOMX180608R-M10 MS2050	6,0	0,10	0,11	0,17
		0,24	0,0040	0,0044	0,0065
S12	XOMX180608R-M10 MS2050	6,0	0,10	0,11	0,17
		0,24	0,0040	0,0044	0,0065
S13	XOMX180608R-M10 MS2050	5,0	0,090	0,10	0,15
		0,20	0,0036	0,0040	0,0060
H5	XOMX180608TR-MD15 MP3000	7,0	0,13	0,15	0,22
		0,28	0,0050	0,0060	0,0085
H8	XOMX180608TR-MD15 MP3000	6,0	0,10	0,11	0,17
		0,24	0,0040	0,0044	0,0065
H11	XOMX180608TR-MD15 MP1501	7,0	0,13	0,15	0,22
		0,28	0,0050	0,0060	0,0085
H12	XOMX180608TR-M14 MP1501	6,0	0,095	0,10	0,16
		0,24	0,0038	0,0040	0,0065

SMG = Seco material group
f_z = mm/tooth (in/tooth), v_c = m/min (sf/min), a_p/DC = %
All cutting data are start values

Square shoulder and slot milling cutters
Helical milling cutters
Face milling cutters
Disc milling cutters
High feed milling cutters
Copy milling cutters
Plunge milling cutters
Chamfer milling cutters
Spot facing cutters
Inserts

R217/220.69-18 – Cutting data $v_c = (m/min)/(sf/min)$

SMG	MP1501			MP2501			MP3000			MM4500			MK1500		
	100%	30%	10%	100%	30%	10%	100%	30%	10%	100%	30%	10%	100%	30%	10%
P1	290	385	460	255	340	410	245	325	385	175	230	275	—	—	—
	950	1275	1500	840	1125	1350	800	1075	1275	570	750	900	—	—	—
P2	280	375	440	250	330	390	240	315	375	165	225	260	—	—	—
	920	1225	1450	820	1075	1275	790	1025	1225	540	740	850	—	—	—
P3	245	330	385	220	295	340	210	280	325	145	195	230	—	—	—
	800	1075	1275	720	970	1125	690	920	1075	475	640	750	—	—	—
P4	215	290	340	190	260	300	185	245	290	130	170	205	—	—	—
	710	950	1125	620	850	980	610	800	950	425	560	670	—	—	—
P5	210	280	330	185	245	295	180	235	280	125	165	195	—	—	—
	690	920	1075	610	800	970	590	770	920	410	540	640	—	—	—
P6	235	315	370	210	275	330	200	265	315	140	185	220	—	—	—
	770	1025	1225	690	900	1075	660	870	1025	460	610	720	—	—	—
P7	225	295	350	200	260	310	190	250	295	130	175	210	—	—	—
	740	970	1150	660	850	1025	620	820	970	425	570	690	—	—	—
P8	205	280	325	185	245	290	175	235	275	120	165	190	—	—	—
	670	920	1075	610	800	950	570	770	900	395	540	620	—	—	—
P11	215	285	340	190	255	300	185	245	290	130	170	200	—	—	—
	710	940	1125	620	840	980	610	800	950	425	560	660	—	—	—
P12	145	190	225	130	165	200	120	160	190	85	110	135	—	—	—
	475	620	740	425	540	660	395	520	620	280	360	445	—	—	—
M1	—	—	—	180	240	280	180	235	280	145	190	225	—	—	—
	—	—	—	590	790	920	590	770	920	475	620	740	—	—	—
M2	—	—	—	150	200	235	150	195	235	120	155	190	—	—	—
	—	—	—	490	660	770	490	640	770	395	510	620	—	—	—
M3	—	—	—	120	160	190	120	160	190	95	130	155	—	—	—
	—	—	—	395	520	620	395	520	620	310	425	510	—	—	—
M4	—	—	—	95	125	145	95	125	145	75	100	120	—	—	—
	—	—	—	310	410	475	310	410	475	245	330	395	—	—	—
M5	—	—	—	80	105	125	80	105	120	65	85	100	—	—	—
	—	—	—	260	345	410	260	345	395	215	280	330	—	—	—
K1	225	295	350	200	260	310	190	250	295	—	—	—	280	370	440
	740	970	1150	660	850	1025	620	820	970	—	—	—	920	1225	1450
K2	200	265	315	175	235	280	170	225	265	—	—	—	250	330	395
	660	870	1025	570	770	920	560	740	870	—	—	—	820	1075	1300
K3	170	225	265	150	200	235	145	190	225	—	—	—	215	280	335
	560	740	870	490	660	770	475	620	740	—	—	—	710	920	1100
K4	160	215	255	145	190	225	135	180	215	—	—	—	205	270	320
	520	710	840	475	620	740	445	590	710	—	—	—	670	890	1050
K5	100	130	155	90	115	135	85	110	130	—	—	—	125	165	195
	330	425	510	295	375	445	280	360	425	—	—	—	410	540	640
K6	140	190	225	125	165	200	120	160	190	—	—	—	180	235	280
	460	620	740	410	540	660	395	520	620	—	—	—	590	770	920
K7	130	170	195	115	150	175	105	140	165	—	—	—	160	210	250
	425	560	640	375	490	570	345	460	540	—	—	—	520	690	820
N1	—	—	—	—	—	—	1375	1825	2175	—	—	—	—	—	—
	—	—	—	—	—	—	4500	6000	7125	—	—	—	—	—	—
N2	—	—	—	—	—	—	560	740	880	—	—	—	—	—	—
	—	—	—	—	—	—	1825	2425	2875	—	—	—	—	—	—
N3	—	—	—	—	—	—	370	495	590	—	—	—	—	—	—
	—	—	—	—	—	—	1225	1625	1925	—	—	—	—	—	—
N11	—	—	—	—	—	—	425	570	670	—	—	—	—	—	—
	—	—	—	—	—	—	1400	1875	2200	—	—	—	—	—	—
S1	—	—	—	47	60	70	45	60	70	23	31	36	—	—	—
	—	—	—	155	195	230	150	195	230	75	100	120	—	—	—
S2	—	—	—	38	50	60	36	48	55	19	25	29	—	—	—
	—	—	—	125	165	195	120	155	180	60	80	95	—	—	—
S3	—	—	—	33	44	50	32	42	48	17	22	26	—	—	—
	—	—	—	110	145	165	105	140	155	55	70	85	—	—	—
S11	—	—	—	65	85	100	60	80	95	32	43	50	—	—	—
	—	—	—	215	280	330	195	260	310	105	140	165	—	—	—
S12	—	—	—	45	60	70	43	55	65	30	39	47	—	—	—
	—	—	—	150	195	230	140	180	215	100	130	155	—	—	—
S13	—	—	—	26	35	40	25	33	38	18	23	27	—	—	—
	—	—	—	85	115	130	80	110	125	60	75	90	—	—	—
H5	48	60	75	39	50	60	37	50	60	—	—	—	—	—	—
	155	195	245	130	165	195	120	165	195	—	—	—	—	—	—
H8	50	70	80	41	55	65	41	55	65	—	—	—	—	—	—
	165	230	260	135	180	215	135	180	215	—	—	—	—	—	—
H11	60	80	95	49	65	75	48	65	75	—	—	—	—	—	—
	195	260	310	160	215	245	155	215	245	—	—	—	—	—	—
H12	90	125	140	80	110	125	80	105	120	—	—	—	—	—	—
	295	410	460	260	360	410	260	345	395	—	—	—	—	—	—

R217/220.69-18 – Cutting data $v_c = (m/min)/(sf/min)$

SMG	MK2050			MS2050			T350M			F40M			H25		
	100%	30%	10%	100%	30%	10%	100%	30%	10%	100%	30%	10%	100%	30%	10%
P1	255	335	400	245	330	380	225	295	355	195	260	310	—	—	—
	840	1100	1300	800	1075	1250	740	970	1175	640	850	1025	—	—	—
P2	245	325	385	240	315	370	220	290	340	190	250	295	—	—	—
	800	1075	1275	790	1025	1225	720	950	1125	620	820	970	—	—	—
P3	215	290	335	205	275	330	190	255	300	165	220	260	—	—	—
	710	950	1100	670	900	1075	620	840	980	540	720	850	—	—	—
P4	190	255	295	185	240	290	170	225	265	145	195	230	—	—	—
	620	840	970	610	790	950	560	740	870	475	640	750	—	—	—
P5	185	245	290	175	235	275	165	215	255	140	185	220	—	—	—
	610	800	950	570	770	900	540	710	840	460	610	720	—	—	—
P6	205	275	325	200	265	310	185	240	285	160	210	250	—	—	—
	670	900	1075	660	870	1025	610	790	940	520	690	820	—	—	—
P7	195	255	305	190	250	290	170	230	270	150	200	235	—	—	—
	640	840	1000	620	820	950	560	750	890	490	660	770	—	—	—
P8	180	245	285	175	230	275	160	215	250	140	185	220	—	—	—
	590	800	940	570	750	900	520	710	820	460	610	720	—	—	—
P11	190	250	295	180	240	285	170	220	265	145	190	230	—	—	—
	620	820	970	590	790	940	560	720	870	475	620	750	—	—	—
P12	125	165	195	120	160	185	110	145	175	95	125	150	—	—	—
	410	540	640	395	520	610	360	475	570	310	410	490	—	—	—
M1	—	—	—	195	250	300	170	220	260	155	200	240	—	—	—
	—	—	—	640	820	980	560	720	850	510	660	790	—	—	—
M2	—	—	—	160	210	250	140	185	220	125	170	200	—	—	—
	—	—	—	520	690	820	460	610	720	410	560	660	—	—	—
M3	—	—	—	130	170	200	115	150	180	105	135	165	—	—	—
	—	—	—	425	560	660	375	490	590	345	445	540	—	—	—
M4	—	—	—	100	135	155	90	120	135	80	105	125	—	—	—
	—	—	—	330	445	510	295	395	445	260	345	410	—	—	—
M5	—	—	—	85	110	130	75	100	115	70	90	105	—	—	—
	—	—	—	280	360	425	245	330	375	230	295	345	—	—	—
K1	265	350	415	—	—	—	170	230	270	—	—	—	—	—	—
	870	1150	1350	—	—	—	560	750	890	—	—	—	—	—	—
K2	240	315	375	—	—	—	155	205	245	—	—	—	—	—	—
	790	1025	1225	—	—	—	510	670	800	—	—	—	—	—	—
K3	200	265	315	—	—	—	130	175	205	—	—	—	—	—	—
	660	870	1025	—	—	—	425	570	670	—	—	—	—	—	—
K4	190	255	300	—	—	—	125	165	195	—	—	—	—	—	—
	620	840	980	—	—	—	410	540	640	—	—	—	—	—	—
K5	120	155	185	—	—	—	75	100	120	—	—	—	—	—	—
	395	510	610	—	—	—	245	330	395	—	—	—	—	—	—
K6	170	225	265	—	—	—	110	145	175	—	—	—	—	—	—
	560	740	870	—	—	—	360	475	570	—	—	—	—	—	—
K7	150	200	235	—	—	—	100	130	150	—	—	—	—	—	—
	490	660	770	—	—	—	330	425	490	—	—	—	—	—	—
N1	—	—	—	—	—	—	—	—	—	1075	1450	1725	1275	1675	2000
	—	—	—	—	—	—	—	—	—	3525	4750	5650	4175	5500	6550
N2	—	—	—	—	—	—	—	—	—	440	590	700	520	680	810
	—	—	—	—	—	—	—	—	—	1450	1925	2300	1700	2225	2650
N3	—	—	—	—	—	—	—	—	—	295	390	465	345	455	540
	—	—	—	—	—	—	—	—	—	970	1275	1525	1125	1500	1775
N11	—	—	—	—	—	—	—	—	—	335	450	530	395	520	620
	—	—	—	—	—	—	—	—	—	1100	1475	1750	1300	1700	2025
S1	—	—	—	48	60	75	42	55	65	38	50	60	—	—	—
	—	—	—	155	195	245	140	180	215	125	165	195	—	—	—
S2	—	—	—	38	50	60	34	44	50	31	40	47	—	—	—
	—	—	—	125	165	195	110	145	165	100	130	155	—	—	—
S3	—	—	—	33	44	50	30	39	46	27	35	42	—	—	—
	—	—	—	110	145	165	100	130	150	90	115	140	—	—	—
S11	—	—	—	65	85	100	60	75	90	50	70	80	—	—	—
	—	—	—	215	280	330	195	245	295	165	230	260	—	—	—
S12	—	—	—	46	60	70	40	55	65	36	48	55	—	—	—
	—	—	—	150	195	230	130	180	215	120	155	180	—	—	—
S13	—	—	—	27	35	41	23	31	36	21	28	33	—	—	—
	—	—	—	90	115	135	75	100	120	70	90	110	—	—	—
H5	—	—	—	—	—	—	37	48	60	32	42	50	—	—	—
	—	—	—	—	—	—	120	155	195	105	140	165	—	—	—
H8	—	—	—	—	—	—	40	55	60	—	—	—	—	—	—
	—	—	—	—	—	—	130	180	195	—	—	—	—	—	—
H11	—	—	—	—	—	—	47	60	75	—	—	—	—	—	—
	—	—	—	—	—	—	155	195	245	—	—	—	—	—	—
H12	—	—	—	—	—	—	70	95	110	60	80	95	—	—	—
	—	—	—	—	—	—	230	310	360	195	260	310	—	—	—

Square shoulder and slot milling cutters
Helical milling cutters
Face milling cutters
Disc milling cutters
High feed milling cutters
Copy milling cutters
Plunge milling cutters
Chamfer milling cutters
Spot facing cutters
Inserts

- Square shoulder and slot milling cutters
- Helical milling cutters
- Face milling cutters
- Disc milling cutters
- High feed milling cutters
- Copy milling cutters
- Plunge milling cutters
- Chamfer milling cutters
- Spot facing cutters
- Inserts



R220.90 ABEX

These multipurpose 90° square-shoulder milling cutters are for heavy roughing applications, delivering large depth-of-cut capability and high feed rates for consistent performance and excellent metal-removal rates.

- Cutter range 63-315 mm (2.5-12 inch)
- Max depth of cut 24 mm (0.94 inch)
- Recommended slotting depth of cut 13 mm (0.51 inch)
- Insert corner radii range 1.6 mm (0.063 inch)

R220.90-26 ABEX – Metric

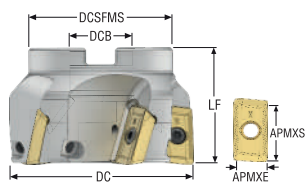

- For insert selection and cutting data recommendations, see page(s) 79-80
- For complete insert programme, see page(s) 828
- For ISO attribute explanation, see page 16
- KAPRS 90°

Designation	Item number	Type of mounting	DC	ZEFP	APMXS	APMXE	DCB	DCSFMS	LF	RMPX°	Cmin	Cmax	RPMX	Weight	Insert
			mm		mm	mm	mm	mm	mm		mm	mm		kg	
R220.90-0063-26-5AM	02789823	Arbor	63,0	5	20,0	10,0	27,0	55,0	50,0	1,5	107,6	123,5	6700	0,7	ABEX26..
R220.90-0063-26-6AM	02789825	Arbor	63,0	6	20,0	10,0	27,0	55,0	50,0	1,5	107,6	123,5	6700	1,9	ABEX26..
R220.90-0080-26-5AM	02789826	Arbor	80,0	5	20,0	10,0	27,0	62,0	50,0	1,0	141,6	157,5	5900	1,9	ABEX26..
R220.90-0125-26-7AM	02789831	Arbor	125,0	7	20,0	10,0	40,0	90,0	63,0	0,5	231,6	247,5	4700	1,9	ABEX26..

Spare Parts, included in delivery

For cutter	Arbor screw	Insert key	Insert screw
R220.90-0063-0080	MC6S12X35	H6B-T20P	C05013-T20P
R220.90-0100-0125	-	H6B-T20PL	C05013-T20P

Accessories

For cutter	Insert clamping torque	Torque key
R220.90-..	5.0NM	T00-20P50

Torque and fixed keys, see page 894

Square shoulder and slot milling cutters
Helical milling cutters
Face milling cutters
Disc milling cutters
High feed milling cutters
Copy milling cutters
Plunge milling cutters
Chamfer milling cutters
Spot facing cutters
Inserts

R220.90 ABEX – Metric

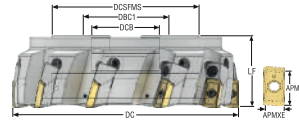

- For insert selection and cutting data recommendations, see page(s) 79-80
- For complete insert programme, see page(s) 828
- For ISO attribute explanation, see page 16
- KAPRS 90°

Designation	Item number	Type of mounting	DC	ZEFP	APMXS	APMXE	DCB	DCSFMS	DBC1	LF	RMPX°	Cmin	Cmax	RPMX	Weight	Insert
			mm		mm	mm	mm	mm	mm	mm		mm	mm		kg	
R220.90-8160-26-8CAN	02830886	Arbor	160,0	8	20,0	10,0	40,0	90,0	66,7	63,0	0,4	296,5	316,8	4200	5,3	ABEX26..
R220.90-8200-26-10CAN	02830887	Arbor	200,0	10	20,0	10,0	60,0	130,0	101,6	63,0	0,35	376,5	396,8	3800	8,1	ABEX26..
R220.90-8250-26-12CAN	02830888	Arbor	250,0	12	20,0	10,0	60,0	130,0	101,6	63,0	0,3	476,5	496,8	3400	13,4	ABEX26..
R220.90-8315-26-14CAN	02830889	Arbor	315,0	14	20,0	10,0	60,0	225,0	101,6	80,0	0,3	606,5	626,8	3000	28,1	ABEX26..

Spare Parts, included in delivery

For cutter	Adjustment unit	Cassette	Cassette screw	Cassette screw 2	Insert key	Insert screw	Lid	Lid screw
R220.90-8160	AU1114T-T15P	AB26PRN	FS96018	C05018-T20P	H6B-T20PL	C05013-T20P	SC-160-90	MF6S4X10
R220.90-8200	AU1114T-T15P	AB26PRN	FS96018	C05018-T20P	H6B-T20PL	C05013-T20P	SC-200-90	MF6S4X10
R220.90-8250	AU1114T-T15P	AB26PRN	FS96018	C05018-T20P	H6B-T20PL	C05013-T20P	SC-250-90	MF6S4X10
R220.90-8315	AU1114T-T15P	AB26PRN	FS96018	C05018-T20P	H6B-T20PL	C05013-T20P	SC-315-90	MF6S4X10

Accessories

For cutter	Allen key	Arbor screw	Insert clamping torque	Setting key	Torque key
R220.90-8160	H05-4	MC6S12X40	5.0NM	T15P-4	T00-20P50
R220.90-8200-8250	H05-4	MC6S16X50	5.0NM	T15P-4	T00-20P50
R220.90-8315	H05-4	-	5.0NM	T15P-4	T00-20P50

Torque and fixed keys, see page 894

R220.90-26 – Insert selection – mm/Inch

SMG		a _p	f _z		
			100%	30%	10%
P1	ABEX2606ZFFR-M15 F40M	10,0	0,22	0,24	0,36
		0,40	0,0085	0,0095	0,014
P2	ABEX2606ZFFR-M15 F40M	10,0	0,22	0,24	0,36
		0,40	0,0085	0,0095	0,014
P3	ABEX2606ZFFR-M15 MP2501	10,0	0,20	0,22	0,34
		0,40	0,0080	0,0085	0,013
P4	ABEX2606ZFFR-M15 MP2501	10,0	0,20	0,22	0,34
		0,40	0,0080	0,0085	0,013
P5	ABEX2606ZFFR-M15 MP2501	10,0	0,20	0,22	0,32
		0,40	0,0080	0,0085	0,013
P6	ABEX2606ZFFR-M15 MP2501	10,0	0,20	0,22	0,32
		0,40	0,0080	0,0085	0,013
P7	ABEX2606ZFFR-M15 MP2501	10,0	0,20	0,22	0,32
		0,40	0,0080	0,0085	0,013
P8	ABEX2606ZFFR-M15 MP2501	10,0	0,20	0,22	0,34
		0,40	0,0080	0,0085	0,013
P11	ABEX2606ZFFR-M15 T350M	10,0	0,20	0,22	0,32
		0,40	0,0080	0,0085	0,013
P12	ABEX2606ZFFR-M15 T350M	8,0	0,14	0,15	0,22
		0,32	0,0055	0,0060	0,0085
M1	ABEX2606ZFFR-M15 F40M	10,0	0,22	0,24	0,36
		0,40	0,0085	0,0095	0,014
M2	ABEX2606ZFFR-M15 F40M	10,0	0,20	0,22	0,32
		0,40	0,0080	0,0085	0,013
M3	ABEX2606ZFFR-M15 F40M	8,0	0,16	0,17	0,26
		0,32	0,0065	0,0065	0,010
M4	ABEX2606ZFFR-M15 T350M	6,0	0,14	0,15	0,22
		0,24	0,0055	0,0060	0,0085
M5	ABEX2606ZFFR-M15 T350M	6,0	0,14	0,15	0,22
		0,24	0,0055	0,0060	0,0085
K1	ABEX2606ZFFR-M15 MK1500	10,0	0,22	0,24	0,36
		0,40	0,0085	0,0095	0,014
K2	ABEX2606ZFFR-M15 MK1500	10,0	0,20	0,22	0,32
		0,40	0,0080	0,0085	0,013
K3	ABEX2606ZFFR-M15 MK1500	10,0	0,20	0,22	0,32
		0,40	0,0080	0,0085	0,013
K4	ABEX2606ZFFR-M15 MK1500	10,0	0,20	0,22	0,32
		0,40	0,0080	0,0085	0,013
K5	ABEX2606ZFFR-M15 T350M	10,0	0,18	0,19	0,30
		0,40	0,0070	0,0075	0,012
K6	ABEX2606ZFFR-M15 T350M	10,0	0,20	0,22	0,32
		0,40	0,0080	0,0085	0,013
K7	ABEX2606ZFFR-M15 T350M	10,0	0,18	0,19	0,30
		0,40	0,0070	0,0075	0,012

SMG = Seco material group
f_z = mm/tooth (in/tooth), v_c = m/min (sf/min), a_p/DC = %
All cutting data are start values

Square shoulder and slot milling cutters
Helical milling cutters
Face milling cutters
Disc milling cutters
High feed milling cutters
Copy milling cutters
Plunge milling cutters
Chamfer milling cutters
Spot facing cutters
Inserts

R220.90-26 – Cutting data $v_c = (m/min)/(sf/min)$

SMG	MP1501			MP2501			MK1500			T350M			F40M		
	100%	30%	10%	100%	30%	10%	100%	30%	10%	100%	30%	10%	100%	30%	10%
P1	280	370	440	245	330	390	—	—	—	215	285	340	185	250	295
	920	1225	1450	800	1075	1275	—	—	—	710	940	1125	610	820	970
P2	270	360	430	240	320	380	—	—	—	210	280	330	180	240	285
	890	1175	1400	790	1050	1250	—	—	—	690	920	1075	590	790	940
P3	240	320	375	215	285	330	—	—	—	185	245	290	160	215	250
	790	1050	1225	710	940	1075	—	—	—	610	800	950	520	710	820
P4	210	280	330	190	250	290	—	—	—	165	215	255	145	190	220
	690	920	1075	620	820	950	—	—	—	540	710	840	475	620	720
P5	205	270	320	180	240	285	—	—	—	155	205	250	135	180	215
	670	890	1050	590	790	940	—	—	—	510	670	820	445	590	710
P6	230	300	360	200	265	320	—	—	—	175	230	280	155	200	240
	750	980	1175	660	870	1050	—	—	—	570	750	920	510	660	790
P7	215	285	340	190	250	300	—	—	—	165	220	260	145	190	230
	710	940	1125	620	820	980	—	—	—	540	720	850	475	620	750
P8	205	270	315	180	240	280	—	—	—	155	205	245	135	180	210
	670	890	1025	590	790	920	—	—	—	510	670	800	445	590	690
P11	210	275	330	185	245	295	—	—	—	160	215	255	140	185	220
	690	900	1075	610	800	970	—	—	—	520	710	840	460	610	720
P12	140	185	215	125	160	190	—	—	—	105	140	165	95	125	145
	460	610	710	410	520	620	—	—	—	345	460	540	310	410	475
M1	—	—	—	175	230	275	—	—	—	160	215	255	145	195	230
	—	—	—	570	750	900	—	—	—	520	710	840	475	640	750
M2	—	—	—	145	190	230	—	—	—	135	180	215	120	160	195
	—	—	—	475	620	750	—	—	—	445	590	710	395	520	640
M3	—	—	—	120	160	185	—	—	—	110	145	175	100	135	155
	—	—	—	395	520	610	—	—	—	360	475	570	330	445	510
M4	—	—	—	95	125	145	—	—	—	90	115	135	80	105	125
	—	—	—	310	410	475	—	—	—	295	375	445	260	345	410
M5	—	—	—	80	105	120	—	—	—	75	95	115	65	90	105
	—	—	—	260	345	395	—	—	—	245	310	375	215	295	345
K1	215	285	340	190	255	300	270	360	425	165	220	260	145	190	225
	710	940	1125	620	840	980	890	1175	1400	540	720	850	475	620	740
K2	190	255	305	170	225	270	240	320	380	150	195	235	130	170	205
	620	840	1000	560	740	890	790	1050	1250	490	640	770	425	560	670
K3	165	215	260	145	190	230	205	270	325	125	165	200	110	145	175
	540	710	850	475	620	750	670	890	1075	410	540	660	360	475	570
K4	155	205	245	140	180	220	195	260	310	120	160	190	105	140	165
	510	670	800	460	590	720	640	850	1025	395	520	620	345	460	540
K5	95	130	150	85	115	130	120	160	185	75	100	115	65	85	100
	310	425	490	280	375	425	395	520	610	245	330	375	215	280	330
K6	135	180	215	120	160	190	170	225	270	105	140	165	90	120	145
	445	590	710	395	520	620	560	740	890	345	460	540	295	395	475
K7	120	165	190	110	145	170	155	205	240	95	125	145	80	110	130
	395	540	620	360	475	560	510	670	790	310	410	475	260	360	425



SQUARE T4

Made for roughing and semi-finishing operations, the Square T4 features four cutting edges and an innovative tangential cutter design that increases the surface area of contact between the insert and the cutter body resulting in good surface finish during slotting, contouring and plunging applications.

- Multi-edge inserts optimize cutting stability
- Available in two inserts size, 08 and 12
- Allow for clean 90-degree walls

Square T4 – R217.94-08 – Metric

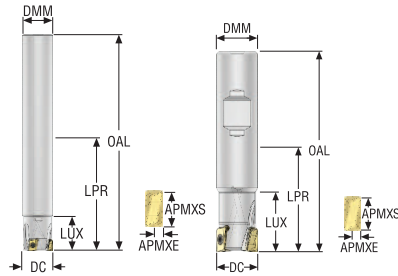

- For insert selection and cutting data recommendations, see page(s) 87-89
- For complete insert programme, see page(s) 831, 832
- For ISO attribute explanation, see page 16
- KAPRS 90°

Designation	Item number	Type of mounting	DC	ZEFP	APMXS	APMXE	DMM	LUX	LPR	OAL	RPMX	Weight	Insert
			mm		mm	mm	mm	mm	mm	mm		kg	
R217.94-1616.0-08-2A	02827519	Cylindrical	16,0	2	8,0	2,0	16,0	29,0	42,0	90,0	20600	0,2	LOEX08..
R217.94-1820.0-08-2A	02827520	Cylindrical	20,0	2	8,0	2,0	18,0	110,0	110,0	160,0	18400	0,3	LOEX08..
R217.94-2020.0-08-2A	02827522	Cylindrical	20,0	2	8,0	2,0	20,0	29,0	110,0	160,0	18400	0,4	LOEX08..
R217.94-2020.0-08-3A	02827523	Cylindrical	20,0	3	8,0	2,0	20,0	29,0	60,0	110,0	18400	0,3	LOEX08..
R217.94-2225.0-08-3A	02827524	Cylindrical	25,0	3	8,0	2,0	22,0	124,0	124,0	180,0	17600	0,5	LOEX08..
R217.94-2525.0-08-3A	02827525	Cylindrical	25,0	3	8,0	2,0	25,0	29,0	124,0	180,0	16500	0,7	LOEX08..
R217.94-2525.0-08-4A	02827526	Cylindrical	25,0	4	8,0	2,0	25,0	29,0	64,0	120,0	16500	0,4	LOEX08..
R217.94-3232.0-08-3A	02827528	Cylindrical	32,0	3	8,0	2,0	32,0	29,0	140,0	200,0	14600	1,2	LOEX08..
R217.94-3232.0-08-5A	02827529	Cylindrical	32,0	5	8,0	2,0	32,0	29,0	70,0	130,0	14600	0,8	LOEX08..
R217.94-1616.3-08-2A	02827530	Weldon	16,0	2	8,0	2,0	16,0	23,4	30,0	78,0	20600	0,1	LOEX08..
R217.94-2018.3-08-2A	02829812	Weldon	18,0	2	8,0	2,0	20,0	26,7	40,0	90,0	19400	0,2	LOEX08..
R217.94-2020.3-08-2A	02827531	Weldon	20,0	2	8,0	2,0	20,0	28,8	40,0	90,0	18400	0,2	LOEX08..
R217.94-2020.3-08-3A	02827533	Weldon	20,0	3	8,0	2,0	20,0	28,9	40,0	90,0	18400	0,3	LOEX08..
R217.94-2522.3-08-3A	02829813	Weldon	22,0	3	8,0	2,0	25,0	26,5	45,0	101,0	17600	0,3	LOEX08..
R217.94-2525.3-08-3A	02827534	Weldon	25,0	3	8,0	2,0	25,0	28,9	45,0	101,0	16500	0,4	LOEX08..
R217.94-2525.3-08-4A	02827535	Weldon	25,0	4	8,0	2,0	25,0	28,9	45,0	101,0	16500	0,4	LOEX08..
R217.94-3232.3-08-5A	02827537	Weldon	32,0	5	8,0	2,0	32,0	28,2	45,0	105,0	14600	0,6	LOEX08..

Spare Parts, included in delivery

For cutter	Insert key	Insert screw
R217.94-.. Ø16-18	H4B-T08P	C02707B-T08P
R217.94-.. Ø20-32	H4B-T08P	C02708B-T08P

Accessories

For cutter	Insert clamping torque	Torque key
R217.94-..	1.2NM	T00-08P12

Torque and fixed keys, see page 894

Square T4 – R217.94-08 – inch

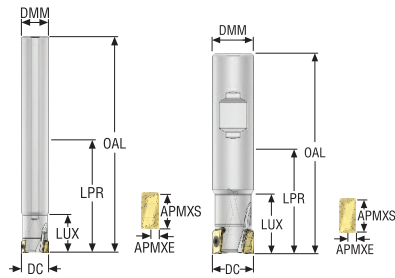

- For insert selection and cutting data recommendations, see page(s) 87-89
- For complete insert programme, see page(s) 831, 832
- For ISO attribute explanation, see page 16
- KAPRS 90°

Designation	Item number	Type of mounting	DC	ZEFP	APMXS	APMXE	DMM	LUX	LPR	OAL	RPMX	Weight	Insert
			inch		inch	inch	inch	inch	inch	inch		lbs	
R217.94-00.62-0-08-2A	02887518	Cylindrical	0.625	2	0.315	0.079	0.625	1.122	3.630	5.520	20600	0.440	LOEX08..
R217.94-01.00-0-08-3A	02887523	Cylindrical	1.000	3	0.315	0.079	1.000	1.138	5.665	7.870	16500	1.540	LOEX08..
R217.94-00.75-3-08-3A	02887522	Weldon	0.750	3	0.315	0.079	0.750	1.138	1.531	3.500	18400	0.440	LOEX08..
R217.94-01.00-3-08-3A	02887524	Weldon	1.000	3	0.315	0.079	1.000	1.138	2.031	4.000	16500	0.880	LOEX08..
R217.94-01.00-3-08-4A	02887525	Weldon	1.000	4	0.315	0.079	1.000	1.138	2.031	4.000	16500	0.880	LOEX08..
R217.94-01.25-3-08-4A	02887527	Weldon	1.250	4	0.315	0.079	1.250	1.110	2.138	4.500	14600	1.540	LOEX08..

Spare Parts, included in delivery

For cutter	Insert key	Insert screw
R217.94-00.62-00.75	H4B-T08P	C02707B-T08P
R217.94-01.00-01.25	H4B-T08P	C02708B-T08P

Accessories

For cutter	Insert clamping torque	Torque key
R217.94-..	10.6IN.LBS	T00-08P12

Torque and fixed keys, see page 894

Square shoulder and slot milling cutters
Helical milling cutters
Face milling cutters
Disc milling cutters
High feed milling cutters
Copy milling cutters
Plunge milling cutters
Chamfer milling cutters
Spot facing cutters
Inserts

Square T4 – R217/220.94-08 – Metric

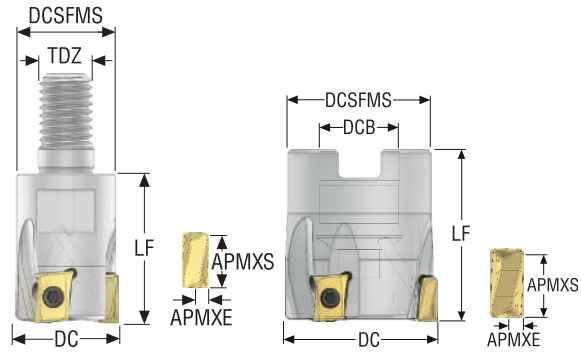



- For insert selection and cutting data recommendations, see page(s) 87-89
- For complete insert programme, see page(s) 831, 832
- For ISO attribute explanation, see page 16
- KAPRS 90°

Designation	Item number	Type of mounting	DC	ZEFP	APMXS	APMXE	DCB	TDZ	DCSFMS	LF	RPMX	Weight	Insert
			mm		mm	mm	mm		mm	mm		kg	
R217.94-0816.RE-08-2A	02827538	Combimaster	16,0	2	8,0	2,0	–	M8	13,5	23,0	20600	0,1	LOEX08..
R217.94-1020.RE-08-3A	02827540	Combimaster	20,0	3	8,0	2,0	–	M10	18,5	28,0	18400	0,1	LOEX08..
R217.94-1225.RE-08-3A	02827541	Combimaster	25,0	3	8,0	2,0	–	M12	23,0	30,0	16500	0,1	LOEX08..
R217.94-1225.RE-08-4A	02827542	Combimaster	25,0	4	8,0	2,0	–	M12	23,0	30,0	16500	0,1	LOEX08..
R217.94-1632.RE-08-3A	02827543	Combimaster	32,0	3	8,0	2,0	–	M16	30,0	35,0	14600	0,2	LOEX08..
R217.94-1632.RE-08-5A	02827544	Combimaster	32,0	5	8,0	2,0	–	M16	30,0	35,0	14600	0,2	LOEX08..
R217.94-2040.RE-08-6A	02972755	Combimaster	40,0	6	8,0	2,0	–	M20	36,5	40,0	13000	0,4	LOEX08..
R220.94-0032-08-3A	02845460	Arbor	32,0	3	8,0	2,0	16,0	–	29,3	35,0	13000	0,2	LOEX08..
R220.94-0032-08-5A	02845461	Arbor	32,0	5	8,0	2,0	16,0	–	29,3	35,0	13000	0,2	LOEX08..
R220.94-0040-08-4A	02827545	Arbor	40,0	4	8,0	2,0	16,0	–	35,0	40,0	13000	0,3	LOEX08..
R220.94-0040-08-6A	02827546	Arbor	40,0	6	8,0	2,0	16,0	–	35,0	40,0	13000	0,3	LOEX08..
R220.94-0050-08-5A	02827547	Arbor	50,0	5	8,0	2,0	22,0	–	45,0	40,0	11700	0,4	LOEX08..
R220.94-0050-08-7A	02827548	Arbor	50,0	7	8,0	2,0	22,0	–	45,0	40,0	11700	0,4	LOEX08..
R220.94-0063-08-6A	02827549	Arbor	63,0	6	8,0	2,0	27,0	–	56,0	40,0	10400	0,6	LOEX08..
R220.94-0063-08-9A	02827550	Arbor	63,0	9	8,0	2,0	27,0	–	56,0	40,0	10400	0,6	LOEX08..

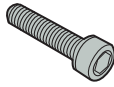

For Combimaster Shanks, see Machining Navigator Tooling System

Square shoulder and slot milling cutters
Helical milling cutters
Face milling cutters
Disc milling cutters
High feed milling cutters
Copy milling cutters
Plunge milling cutters
Chamfer milling cutters
Spot facing cutters
Inserts

Spare Parts, included in delivery

For cutter	Arbor screw	Insert key	Insert screw
			
R217.94-.. Ø16	-	H4B-T08P	C02707B-T08P
R217.94-.. Ø20-40	-	H4B-T08P	C02708B-T08P
R220.94-0032	TCEI0825	H4B-T08P	C02707B-T08P
R220.94-0040	TCEI0825	H4B-T08P	C02708B-T08P
R220.94-0050	220.17-692	H4B-T08P	C02708B-T08P
R220.94-0063	MLC6S12X30	H4B-T08P	C02708B-T08P

Accessories

For cutter	Insert clamping torque	Torque key
		
R217/220.94-..	1.2NM	T00-08P12

Torque and fixed keys, see page 894

- Square shoulder and slot milling cutters
- Helical milling cutters
- Face milling cutters
- Disc milling cutters
- High feed milling cutters
- Copy milling cutters
- Plunge milling cutters
- Chamfer milling cutters
- Spot facing cutters
- Inserts

Square T4 – R217/220.94-08 – inch

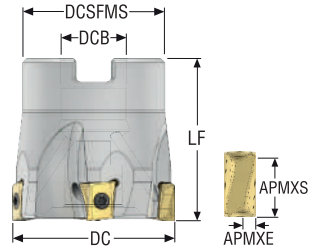

- For insert selection and cutting data recommendations, see page(s) 87-89
- For complete insert programme, see page(s) 831, 832
- For ISO attribute explanation, see page 16
- KAPRS 90°

Designation	Item number	Type of mounting	DC	ZEFP	APMXS	APMXE	DCB	DCSFMS	LF	RPMX	Weight	Insert
			inch		inch	inch	inch	inch	inch		lbs	
R220.94-01.50-08-4A	02887529	Arbor	1.500	4	0.315	0.138	0.750	1.378	1.575	13000	0.440	LOEX08..
R220.94-02.00-08-5A	02887530	Arbor	2.000	5	0.315	0.138	0.750	1.772	1.575	11700	0.880	LOEX08..

For Combimaster Shanks, see Machining Navigator Tooling System

Spare Parts, included in delivery

For cutter	Arbor screw	Insert key	Insert screw
R220.94-..	UC6S3/8UNFX1	H4B-T08P	C02708B-T08P

Accessories

For cutter	Insert clamping torque	Torque key
R220.94-..	10.6IN.LBS	T00-08P12

Torque and fixed keys, see page 894

R217/220.94-08 – Insert selection – mm/Inch

SMG		a _p	f _z		
			100%	30%	10%
P1	LOEX080408TR-M08 F40M	4,0	0,11	0,12	0,19
		0.16	0.0044	0.0048	0.0075
P2	LOEX080408TR-M08 F40M	4,0	0,12	0,13	0,19
		0.16	0.0048	0.0050	0.0075
P3	LOEX080408TR-M08 MP2501	4,0	0,11	0,12	0,18
		0.16	0.0044	0.0048	0.0070
P4	LOEX080408TR-M08 MP2501	4,0	0,11	0,12	0,18
		0.16	0.0044	0.0048	0.0070
P5	LOEX080408TR-M08 MP2501	4,0	0,11	0,12	0,18
		0.16	0.0044	0.0048	0.0070
P6	LOEX080408TR-M08 MP2501	4,0	0,10	0,11	0,17
		0.16	0.0040	0.0044	0.0065
P7	LOEX080408TR-M08 MP2501	4,0	0,10	0,11	0,17
		0.16	0.0040	0.0044	0.0065
P8	LOEX080408TR-M08 MP2501	4,0	0,11	0,12	0,18
		0.16	0.0044	0.0048	0.0070
P11	LOEX080408TR-M08 MP3000	4,0	0,10	0,11	0,17
		0.16	0.0040	0.0044	0.0065
P12	LOEX080408TR-M08 MP3000	3,0	0,075	0,080	0,12
		0.12	0.0030	0.0032	0.0048
M1	LOEX080408TR-M08 F40M	4,0	0,12	0,13	0,19
		0.16	0.0048	0.0050	0.0075
M2	LOEX080408TR-M08 F40M	4,0	0,11	0,12	0,18
		0.16	0.0044	0.0048	0.0070
M3	LOEX080408TR-M08 F40M	3,0	0,085	0,095	0,14
		0.12	0.0034	0.0038	0.0055
M4	LOEX080404TR-M08 F40M	2,5	0,075	0,080	0,12
		0.10	0.0030	0.0032	0.0048
M5	LOEX080404TR-M08 F40M	2,5	0,075	0,080	0,12
		0.10	0.0030	0.0032	0.0048
K1	LOEX080408TR-MD08 MK2050	4,0	0,12	0,13	0,19
		0.16	0.0048	0.0050	0.0075
K2	LOEX080408TR-MD08 MK2050	4,0	0,11	0,12	0,18
		0.16	0.0044	0.0048	0.0070
K3	LOEX080408TR-MD08 MK2050	4,0	0,11	0,12	0,18
		0.16	0.0044	0.0048	0.0070
K4	LOEX080408TR-MD08 MK2050	4,0	0,11	0,12	0,18
		0.16	0.0044	0.0048	0.0070
K5	LOEX080408TR-MD08 MK2050	4,0	0,095	0,10	0,16
		0.16	0.0038	0.0040	0.0065
K6	LOEX080408TR-MD08 MK2050	4,0	0,11	0,12	0,18
		0.16	0.0044	0.0048	0.0070
K7	LOEX080408TR-MD08 MK2050	4,0	0,095	0,10	0,16
		0.16	0.0038	0.0040	0.0065
N1	LOEX080408TR-M08 F40M	4,0	0,15	0,16	0,25
		0.16	0.0060	0.0065	0.010
N2	LOEX080408TR-M08 F40M	4,0	0,15	0,16	0,25
		0.16	0.0060	0.0065	0.010
N3	LOEX080408TR-M08 F40M	4,0	0,15	0,16	0,25
		0.16	0.0060	0.0065	0.010
N11	LOEX080408TR-M08 F40M	4,0	0,15	0,16	0,25
		0.16	0.0060	0.0065	0.010
S1	LOEX080408TR-M08 F40M	2,5	0,075	0,085	0,12
		0.10	0.0030	0.0034	0.0048
S2	LOEX080408TR-M08 F40M	2,5	0,075	0,085	0,12
		0.10	0.0030	0.0034	0.0048
S3	LOEX080408TR-M08 F40M	2,5	0,070	0,075	0,11
		0.10	0.0028	0.0030	0.0044
S11	LOEX080408TR-M08 MS2050	2,5	0,085	0,095	0,14
		0.10	0.0034	0.0038	0.0055
S12	LOEX080408TR-M08 MS2050	2,5	0,085	0,095	0,14
		0.10	0.0034	0.0038	0.0055
S13	LOEX080408TR-M08 MS2050	2,5	0,075	0,085	0,12
		0.10	0.0030	0.0034	0.0048
H5	LOEX080408TR-M08 MP3000	3,0	0,075	0,080	0,12
		0.12	0.0030	0.0032	0.0048
H8	LOEX080408TR-M08 MP3000	2,5	0,055	0,060	0,090
		0.10	0.0022	0.0024	0.0036
H11	LOEX080408TR-M08 MP3000	3,0	0,075	0,080	0,12
		0.12	0.0030	0.0032	0.0048
H12	LOEX080408TR-M08 MP1501	2,5	0,055	0,060	0,090
		0.10	0.0022	0.0024	0.0036

SMG = Seco material group
f_z = mm/tooth (in/tooth), v_c = m/min (sf/min), a_p/DC = %
All cutting data are start values

Square shoulder and slot milling cutters
Helical milling cutters
Face milling cutters
Disc milling cutters
High feed milling cutters
Copy milling cutters
Plunge milling cutters
Chamfer milling cutters
Spot facing cutters
Inserts

R217/220.94-08 – Cutting data $v_c = (m/min)/(sf/min)$

SMG	MP1501			MP2050			MP2501			MP3000			MM4500			MK1500		
	100%	30%	10%	100%	30%	10%	100%	30%	10%	100%	30%	10%	100%	30%	10%	100%	30%	10%
P1	355	470	550	295	390	460	315	415	485	300	395	460	195	255	300	—	—	—
	1175	1550	1800	970	1275	1500	1025	1350	1600	980	1300	1500	640	840	980	—	—	—
P2	340	445	530	290	380	445	300	395	470	285	375	445	185	245	290	—	—	—
	1125	1450	1750	950	1250	1450	980	1300	1550	940	1225	1450	610	800	950	—	—	—
P3	300	395	465	255	330	395	265	350	410	250	330	390	160	215	255	—	—	—
	980	1300	1525	840	1075	1300	870	1150	1350	820	1075	1275	520	710	840	—	—	—
P4	260	345	410	225	295	345	230	305	360	220	290	345	145	190	225	—	—	—
	850	1125	1350	740	970	1125	750	1000	1175	720	950	1125	475	620	740	—	—	—
P5	250	330	390	215	280	330	220	295	345	210	275	330	135	180	210	—	—	—
	820	1075	1275	710	920	1075	720	970	1125	690	900	1075	445	590	690	—	—	—
P6	290	380	445	240	315	370	255	335	395	240	320	375	155	205	240	—	—	—
	950	1250	1450	790	1025	1225	840	1100	1300	790	1050	1225	510	670	790	—	—	—
P7	270	360	420	225	300	350	240	315	370	230	300	350	150	195	230	—	—	—
	890	1175	1375	740	980	1150	790	1025	1225	750	980	1150	490	640	750	—	—	—
P8	250	330	390	215	275	330	220	295	345	210	275	330	135	180	210	—	—	—
	820	1075	1275	710	900	1075	720	970	1125	690	900	1075	445	590	690	—	—	—
P11	265	350	410	220	290	340	235	310	360	220	290	340	145	190	220	—	—	—
	870	1150	1350	720	950	1125	770	1025	1175	720	950	1125	475	620	720	—	—	—
P12	170	220	260	145	190	225	150	195	230	140	185	220	90	120	140	—	—	—
	560	720	850	475	620	740	490	640	750	460	610	720	295	395	460	—	—	—
M1	—	—	—	205	275	320	215	285	340	210	280	335	160	210	250	—	—	—
	—	—	—	670	900	1050	710	940	1125	690	920	1100	520	690	820	—	—	—
M2	—	—	—	170	225	265	180	235	280	175	230	275	130	170	205	—	—	—
	—	—	—	560	740	870	590	770	920	570	750	900	425	560	670	—	—	—
M3	—	—	—	140	185	215	145	190	225	145	190	220	105	140	165	—	—	—
	—	—	—	460	610	710	475	620	740	475	620	720	345	460	540	—	—	—
M4	—	—	—	110	140	165	115	150	175	110	145	170	85	110	130	—	—	—
	—	—	—	360	460	540	375	490	570	360	475	560	280	360	425	—	—	—
M5	—	—	—	90	120	135	95	125	145	95	120	145	70	90	105	—	—	—
	—	—	—	295	395	445	310	410	475	310	395	475	230	295	345	—	—	—
K1	270	355	420	230	300	355	235	315	375	225	295	355	—	—	—	335	445	530
	890	1175	1375	750	980	1175	770	1025	1225	740	970	1175	—	—	—	1100	1450	1750
K2	240	315	370	200	265	315	210	280	330	200	265	310	—	—	—	300	395	465
	790	1025	1225	660	870	1025	690	920	1075	660	870	1025	—	—	—	980	1300	1525
K3	200	265	315	170	225	265	180	235	280	170	225	265	—	—	—	250	335	395
	660	870	1025	560	740	870	590	770	920	560	740	870	—	—	—	820	1100	1300
K4	190	255	300	165	215	255	170	225	265	160	210	250	—	—	—	240	320	375
	620	840	980	540	710	840	560	740	870	520	690	820	—	—	—	790	1050	1225
K5	120	160	185	100	130	155	105	140	165	100	130	155	—	—	—	150	200	230
	395	520	610	330	425	510	345	460	540	330	425	510	—	—	—	490	660	750
K6	170	225	265	145	190	225	150	200	235	140	185	220	—	—	—	210	280	330
	560	740	870	475	620	740	490	660	770	460	610	720	—	—	—	690	920	1075
K7	150	200	235	125	170	200	135	180	210	125	170	195	—	—	—	190	255	295
	490	660	770	410	560	660	445	590	690	410	560	640	—	—	—	620	840	970
N1	—	—	—	—	—	—	—	—	—	—	—	—	—	—	—	—	—	—
	—	—	—	—	—	—	—	—	—	—	—	—	—	—	—	—	—	—
N2	—	—	—	—	—	—	—	—	—	—	—	—	—	—	—	—	—	—
	—	—	—	—	—	—	—	—	—	—	—	—	—	—	—	—	—	—
N3	—	—	—	—	—	—	—	—	—	—	—	—	—	—	—	—	—	—
	—	—	—	—	—	—	—	—	—	—	—	—	—	—	—	—	—	—
N11	—	—	—	—	—	—	—	—	—	—	—	—	—	—	—	—	—	—
	—	—	—	—	—	—	—	—	—	—	—	—	—	—	—	—	—	—
S1	—	—	—	55	70	80	55	70	85	50	70	80	25	33	39	—	—	—
	—	—	—	180	230	260	180	230	280	165	230	260	80	110	130	—	—	—
S2	—	—	—	43	55	65	45	60	70	42	55	65	21	27	31	—	—	—
	—	—	—	140	180	215	150	195	230	140	180	215	70	90	100	—	—	—
S3	—	—	—	37	49	55	39	50	60	37	49	55	18	24	28	—	—	—
	—	—	—	120	160	180	130	165	195	120	160	180	60	80	90	—	—	—
S11	—	—	—	75	95	115	80	100	120	75	95	110	36	47	55	—	—	—
	—	—	—	245	310	375	260	330	395	245	310	360	120	155	180	—	—	—
S12	—	—	—	50	65	80	55	70	80	50	65	80	33	43	50	—	—	—
	—	—	—	165	215	260	180	230	260	165	215	260	110	140	165	—	—	—
S13	—	—	—	30	39	45	31	41	48	29	38	45	19	25	29	—	—	—
	—	—	—	100	130	150	100	135	155	95	125	150	60	80	95	—	—	—
H5	55	75	85	43	55	65	45	60	70	44	60	70	—	—	—	—	—	—
	180	245	280	140	180	215	150	195	230	145	195	230	—	—	—	—	—	—
H8	60	80	90	46	60	70	49	65	75	47	60	70	—	—	—	—	—	—
	195	260	295	150	195	230	160	215	245	155	195	230	—	—	—	—	—	—
H11	70	95	110	55	70	85	55	75	90	55	75	85	—	—	—	—	—	—
	230	310	360	180	230	280	180	245	295	180	245	280	—	—	—	—	—	—
H12	110	140	165	90	120	140	95	125	145	90	120	140	—	—	—	—	—	—
	360	460	540	295	395	460	310	410	475	295	395	460	—	—	—	—	—	—

R217/220.94-08 – Cutting data $v_c = (m/min)/(sf/min)$

SMG	MK2050			MS2050			MS2500			T350M			F40M		
	100%	30%	10%	100%	30%	10%	100%	30%	10%	100%	30%	10%	100%	30%	10%
P1	310	410	475	260	345	405	330	435	520	275	360	420	240	315	365
	1025	1350	1550	850	1125	1325	1075	1425	1700	900	1175	1375	790	1025	1200
P2	295	390	465	250	330	395	320	425	500	260	345	410	225	300	355
	970	1275	1525	820	1075	1300	1050	1400	1650	850	1125	1350	740	980	1175
P3	260	345	405	220	290	345	280	370	430	230	305	360	200	265	310
	850	1125	1325	720	950	1125	920	1225	1400	750	1000	1175	660	870	1025
P4	230	300	355	195	255	300	250	325	390	200	265	315	175	230	275
	750	980	1175	640	840	980	820	1075	1275	660	870	1025	570	750	900
P5	220	290	340	185	245	290	235	315	370	195	255	300	170	220	260
	720	950	1125	610	800	950	770	1025	1225	640	840	980	560	720	850
P6	250	330	390	215	280	330	270	360	420	220	295	345	195	255	300
	820	1075	1275	710	920	1075	890	1175	1375	720	970	1125	640	840	980
P7	235	310	365	200	265	310	255	340	395	210	275	325	180	240	280
	770	1025	1200	660	870	1025	840	1125	1300	690	900	1075	590	790	920
P8	220	290	340	185	245	290	235	315	365	195	255	300	170	220	260
	720	950	1125	610	800	950	770	1025	1200	640	840	980	560	720	850
P11	230	305	355	195	255	300	250	330	385	205	270	315	175	235	275
	750	1000	1175	640	840	980	820	1075	1275	670	890	1025	570	770	900
P12	145	195	230	125	165	190	160	210	245	130	170	200	115	150	175
	475	640	750	410	540	620	520	690	800	425	560	660	375	490	570
M1	—	—	—	200	265	315	230	305	360	200	265	315	185	240	290
	—	—	—	660	870	1025	750	1000	1175	660	870	1025	610	790	950
M2	—	—	—	165	220	260	190	250	300	165	220	260	150	200	235
	—	—	—	540	720	850	620	820	980	540	720	850	490	660	770
M3	—	—	—	135	180	210	155	205	240	135	180	210	125	160	190
	—	—	—	445	590	690	510	670	790	445	590	690	410	520	620
M4	—	—	—	105	140	165	120	160	185	105	140	165	95	125	150
	—	—	—	345	460	540	395	520	610	345	460	540	310	410	490
M5	—	—	—	90	115	135	100	135	155	90	115	135	80	105	125
	—	—	—	295	375	445	330	445	510	295	375	445	260	345	410
K1	320	420	500	—	—	—	—	—	—	205	275	325	180	240	285
	1050	1375	1650	—	—	—	—	—	—	670	900	1075	590	790	940
K2	280	370	440	—	—	—	—	—	—	185	240	285	160	210	250
	920	1225	1450	—	—	—	—	—	—	610	790	940	520	690	820
K3	240	315	375	—	—	—	—	—	—	155	205	240	135	180	210
	790	1025	1225	—	—	—	—	—	—	510	670	790	445	590	690
K4	230	300	355	—	—	—	—	—	—	150	195	230	130	170	200
	750	980	1175	—	—	—	—	—	—	490	640	750	425	560	660
K5	140	185	220	—	—	—	—	—	—	90	120	140	80	105	125
	460	610	720	—	—	—	—	—	—	295	395	460	260	345	410
K6	200	265	315	—	—	—	—	—	—	130	170	205	115	150	175
	660	870	1025	—	—	—	—	—	—	425	560	670	375	490	570
K7	180	240	280	—	—	—	—	—	—	115	155	180	100	135	160
	590	790	920	—	—	—	—	—	—	375	510	590	330	445	520
N1	—	—	—	—	—	—	—	—	—	—	—	—	1325	1775	2075
	—	—	—	—	—	—	—	—	—	—	—	—	4350	5825	6800
N2	—	—	—	—	—	—	—	—	—	—	—	—	540	720	840
	—	—	—	—	—	—	—	—	—	—	—	—	1775	2350	2750
N3	—	—	—	—	—	—	—	—	—	—	—	—	360	480	560
	—	—	—	—	—	—	—	—	—	—	—	—	1175	1575	1825
N11	—	—	—	—	—	—	—	—	—	—	—	—	410	550	640
	—	—	—	—	—	—	—	—	—	—	—	—	1350	1800	2100
S1	—	—	—	50	65	75	60	80	90	50	65	75	45	60	70
	—	—	—	165	215	245	195	260	295	165	215	245	150	195	230
S2	—	—	—	40	55	60	48	65	75	40	55	60	36	48	55
	—	—	—	130	180	195	155	215	245	130	180	195	120	155	180
S3	—	—	—	35	46	55	42	55	65	35	46	55	32	42	49
	—	—	—	115	150	180	140	180	215	115	150	180	105	140	160
S11	—	—	—	70	90	105	85	110	125	70	90	105	65	80	95
	—	—	—	230	295	345	280	360	410	230	295	345	215	260	310
S12	—	—	—	48	60	75	55	75	90	48	60	75	44	55	65
	—	—	—	155	195	245	180	245	295	155	195	245	145	180	215
S13	—	—	—	28	37	43	33	44	50	28	37	43	25	33	39
	—	—	—	90	120	140	110	145	165	90	120	140	80	110	130
H5	—	—	—	—	—	—	—	—	—	43	55	65	38	49	60
	—	—	—	—	—	—	—	—	—	140	180	215	125	160	195
H8	—	—	—	—	—	—	—	—	—	47	60	70	40	55	60
	—	—	—	—	—	—	—	—	—	155	195	230	130	180	195
H11	—	—	—	—	—	—	—	—	—	55	70	85	48	65	75
	—	—	—	—	—	—	—	—	—	180	230	280	155	215	245
H12	—	—	—	—	—	—	105	135	155	85	110	125	75	95	110
	—	—	—	—	—	—	345	445	510	280	360	410	245	310	360

Square shoulder and slot milling cutters
Helical milling cutters
Face milling cutters
Disc milling cutters
High feed milling cutters
Copy milling cutters
Plunge milling cutters
Chamfer milling cutters
Spot facing cutters
Inserts

Square T4 – R217.94-12 – Metric

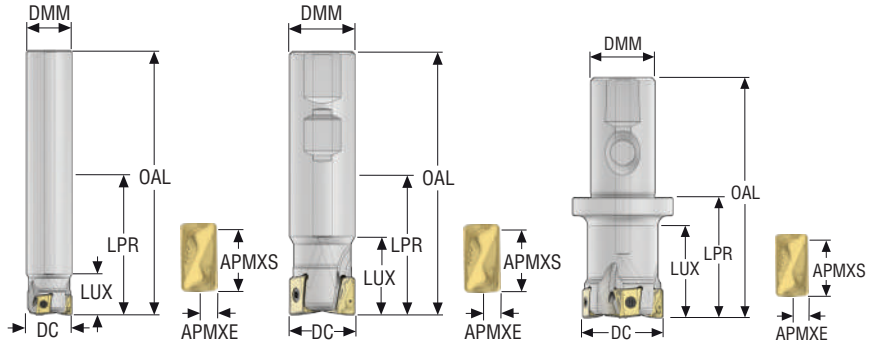

- For insert selection and cutting data recommendations, see page(s) 95-97
- For complete insert programme, see page(s) 831, 832
- For ISO attribute explanation, see page 16
- KAPRS 90°

Designation	Item number	Type of mounting	DC	ZEFP	APMXS	APMXE	DMM	LUX	LPR	OAL	RPMX	Weight	Insert
			mm		mm	mm	mm	mm	mm	mm		kg	
R217.94-2525.0-12-2A	02998333	Cylindrical	25,0	2	12,0	3,5	25,0	35,0	114,0	170,0	14000	0,5	LOEX12..
R217.94-3232.0-12-3A	02998334	Cylindrical	32,0	3	12,0	3,5	32,0	30,0	135,0	195,0	12400	1,2	LOEX12..
R217.94-3240.0-12-4A	02998335	Cylindrical	40,0	4	12,0	3,5	32,0	150,0	150,0	210,0	11100	1,4	LOEX12..
R217.94-2525.3-12-2A	02998328	Weldon	25,0	2	12,0	3,5	25,0	30,0	45,0	101,0	14000	0,4	LOEX12..
R217.94-3232.3-12-3A	02998329	Weldon	32,0	3	12,0	3,5	32,0	30,0	50,0	110,0	12400	0,7	LOEX12..
R217.94-2532.3S-12-3A	02998330	Seco-Weldon	32,0	3	12,0	3,5	25,0	40,0	54,0	110,0	12400	0,7	LOEX12..
R217.94-3240.3S-12-4A	02998331	Seco-Weldon	40,0	4	12,0	3,5	32,0	46,0	60,0	120,0	11100	1,3	LOEX12..

Spare Parts, included in delivery

For cutter	Insert key	Insert screw
R217.94-2525	H4B-T15P	C040105B-T15P
R217.94-3232-3240	H4B-T15P	C04012B-T15P

Accessories

For cutter	Insert clamping torque	Torque key
R217.94-..	3.5NM	T00-15P35

Torque and fixed keys, see page 894

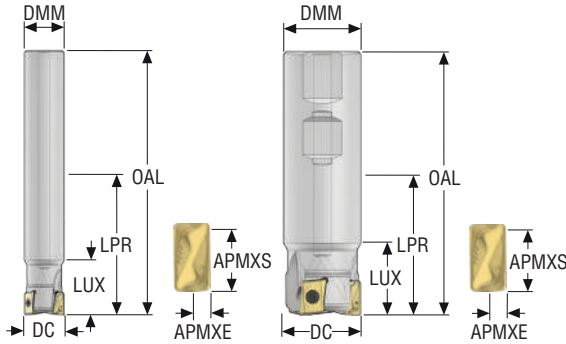

Square T4 – R217.94-12 – inch





- For insert selection and cutting data recommendations, see page(s) 95-97
- For complete insert programme, see page(s) 831, 832
- For ISO attribute explanation, see page 16
- KAPRS 90°

Designation	Item number	Type of mounting	DC	ZEFP	APMXS	APMXE	DMM	LUX	LPR	OAL	RPMX	Weight	Insert
			inch		inch	inch	inch	inch	inch	inch		lbs	
R217.94-01.00-0-12-2A	02998412	Cylindrical	1.000	2	0.472	0.138	1.000	1.181	3.740	6.693	13900	1.540	LOEX12
R217.94-01.50-0-12-4A	02998414	Cylindrical	1.500	4	0.472	0.138	1.500	1.181	5.906	8.268	11300	3.970	LOEX12
R217.94-01.00-3-12-2A	02998408	Weldon	1.000	2	0.472	0.138	1.000	1.181	1.795	4.000	14000	0.880	LOEX12
R217.94-01.25-3-12-3A	02998409	Weldon	1.250	3	0.472	0.138	1.250	1.181	1.888	4.250	12400	1.540	LOEX12
R217.94-01.50-3-12-4A	02998410	Weldon	1.500	4	0.472	0.138	1.500	1.181	1.969	4.724	11300	2.430	LOEX12

Spare Parts, included in delivery

For cutter	Insert key	Insert screw
		
R217.94-01.00	H4B-T15P	C040105B-T15P
R217.94-01.25-01.50	H4B-T15P	C04012B-T15P

Accessories

For cutter	Insert clamping torque	Torque key
		
R217.94-..	31.0IN.LBS	T00-15P35

Torque and fixed keys, see page 894

Square shoulder and slot milling cutters

Helical milling cutters

Face milling cutters

Disc milling cutters

High feed milling cutters

Copy milling cutters

Plunge milling cutters

Chamfer milling cutters

Spot facing cutters

Inserts

Square T4 – R217/220.94-12 – Metric

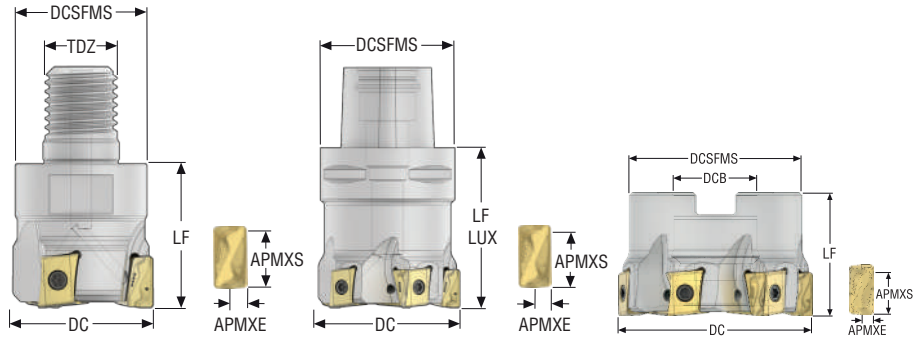



- For insert selection and cutting data recommendations, see page(s) 95-97
- For complete insert programme, see page(s) 831, 832
- For ISO attribute explanation, see page 16
- KAPRS 90°

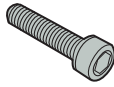

Designation	Item number	Type of mounting	DC	ZEFP	APMXS	APMXE	DCB	TDZ	DCSFMS	LUX	LF	RMPX°	RPMX	Weight	Insert
			mm		mm	mm	mm		mm	mm	mm			kg	
R217.94-1632.RE-12-3A	02998337	Combimaster	32,0	3	12,0	3,5	–	M16	30,0	–	40,0	0,0	12400	0,3	LOEX12
R217.94-2040.RE-12-3A	02998338	Combimaster	40,0	3	12,0	3,5	–	M20	36,5	–	40,0	0,0	11100	0,4	LOEX12
R217.94-2040.RE-12-5A	02998339	Combimaster	40,0	5	12,0	3,5	–	M20	36,5	–	40,0	0,0	11100	0,5	LOEX12
C4-R217.94-044-12-4A	02998340	Seco-Capto	44,0	4	12,0	3,5	–	–	40,0	60,0	60,0	0,0	10600	0,6	LOEX12
C5-R217.94-054-12-5A	02998342	Seco-Capto	54,0	5	12,0	3,5	–	–	50,0	60,0	60,0	0,0	9500	1,0	LOEX12
C6-R217.94-066-12-6A	02998344	Seco-Capto	66,0	6	12,0	3,5	–	–	63,0	60,0	60,0	0,0	8600	1,6	LOEX12
R220.94-0040-12-4A	02998603	Arbor	40,0	4	12,0	3,5	16,0	–	35,0	–	40,0	0,0	11100	0,3	LOEX12
R220.94-0040-12-5A	02998347	Arbor	40,0	5	12,0	3,5	16,0	–	35,0	–	40,0	0,0	11100	0,4	LOEX12
R220.94-0050-12-5A	02998348	Arbor	50,0	5	12,0	3,5	22,0	–	45,0	–	40,0	0,0	9900	0,5	LOEX12
R220.94-0050-12-6A	02998349	Arbor	50,0	6	12,0	3,5	22,0	–	45,0	–	40,0	0,0	9900	0,5	LOEX12
R220.94-0063-12-6A	02998350	Arbor	63,0	6	12,0	3,5	27,0	–	56,0	–	40,0	0,0	8800	0,7	LOEX12
R220.94-0063-12-8A	02998351	Arbor	63,0	8	12,0	3,5	27,0	–	56,0	–	40,0	0,0	8800	0,7	LOEX12
R220.94-0063-12-8A-22	03239181	Arbor	63,0	8	12,0	3,5	22,0	–	56,0	–	40,0	0,0	8800	0,6	LOEX12
R220.94-0080-12-7A	02998352	Arbor	80,0	7	12,0	3,5	27,0	–	62,0	–	50,0	0,0	7800	1,3	LOEX12
R220.94-0080-12-10A	02998353	Arbor	80,0	10	12,0	3,5	27,0	–	62,0	–	50,0	0,0	7800	1,3	LOEX12
R220.94-0100-12-9A	02998354	Arbor	100,0	9	12,0	3,5	32,0	–	77,0	–	50,0	0,0	7000	1,8	LOEX12
R220.94-0100-12-12A	02998355	Arbor	100,0	12	12,0	3,5	32,0	–	77,0	–	50,0	0,0	7000	1,9	LOEX12
R220.94-0125-12-12A	02998356	Arbor	125,0	12	12,0	3,5	40,0	–	90,0	–	63,0	0,0	6300	3,3	LOEX12

For Combimaster Shanks, see Machining Navigator Tooling System

Spare Parts, included in delivery

For cutter	Arbor screw	Insert key	Insert screw
			
Cx/R217.94-..	-	H4B-T15P	C04012B-T15P
R220.94-0040	TCEI0825	H4B-T15P	C04012B-T15P
R220.94-0050	220.17-692	H4B-T15P	C04012B-T15P
R220.94-0063	MLC6S12X30	H4B-T15P	C04012B-T15P
R220.94-0063-22	220.17-692	H4B-T15P	C04012B-T15P
R220.94-0080	MC6S12X35	H4B-T15P	C04012B-T15P
R220.94-0100-0125	-	H4B-T15P	C04012B-T15P

Accessories

For cutter	Insert clamping torque	Torque key
		
R217/220.94-..	3.5NM	T00-15P35

Torque and fixed keys, see page 894

- Square shoulder and slot milling cutters
- Helical milling cutters
- Face milling cutters
- Disc milling cutters
- High feed milling cutters
- Copy milling cutters
- Plunge milling cutters
- Chamfer milling cutters
- Spot facing cutters
- Inserts

Square T4 – R217/220.94-12 – inch

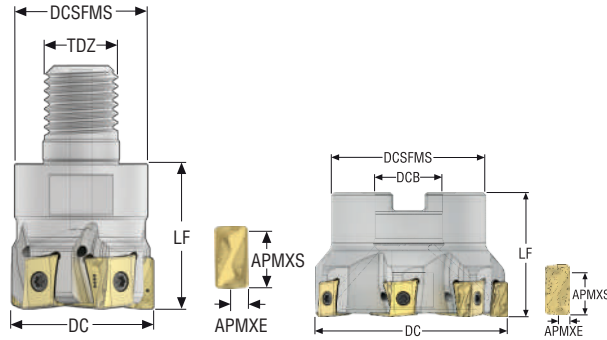

- For insert selection and cutting data recommendations, see page(s) 95-97
- For complete insert programme, see page(s) 831, 832
- For ISO attribute explanation, see page 16
- KAPRS 90°

Designation	Item number	Type of mounting	DC	ZEFP	APMXS	APMXE	DCB	TDZ	DCSFMS	LF	RPM	Weight	Insert
			inch		inch	inch	inch		inch	inch		lbs	
R217.94-01.25-16RE-12-3A	02998415	Combimaster	1.250	3	0.472	0.138	–	M16	1.181	1.575	12400	0.660	LOEX12..
R220.94-02.00-12-5A	02998421	Arbor	2.000	5	0.472	0.138	0.750	–	1.850	1.575	9800	1.100	LOEX12..
R220.94-02.00-12-6A	02998422	Arbor	2.000	6	0.472	0.138	0.750	–	1.850	1.575	9800	1.100	LOEX12..
R220.94-02.50-12-6A	02998423	Arbor	2.500	6	0.472	0.138	0.750	–	1.850	1.575	8800	1.540	LOEX12..
R220.94-02.50-12-8A	02998424	Arbor	2.500	8	0.472	0.138	0.750	–	1.850	1.575	8800	1.540	LOEX12..
R220.94-03.00-12-8A	02998425	Arbor	3.000	8	0.472	0.138	1.000	–	2.441	1.969	8000	2.650	LOEX12..
R220.94-04.00-12-10A	02998426	Arbor	4.000	10	0.472	0.138	1.500	–	3.543	1.969	7000	4.850	LOEX12..
R220.94-05.00-12-12A	02998427	Arbor	5.000	12	0.472	0.138	1.500	–	3.543	2.480	6200	8.160	LOEX12..
R220.94-06.00-12-14	03137209	Arbor	6.000	14	0.472	0.138	2.000	–	4.331	2.480	6200	9.260	LOEX12..

For Combimaster Shanks, see Machining Navigator Tooling System

Spare Parts, included in delivery

For cutter	Arbor screw	Insert key	Insert screw
R217.94-01.25-01.50	–	H4B-T15P	C04012B-T15P
R220.94-02.00-02.50	UC6S3/8UNFX1	H4B-T15P	C04012B-T15P
R220.94-03.00	UC6S1/2UNFX1-1/4	H4B-T15P	C04012B-T15P
R220.94-04.00	ULC6S3/4UNFX11/2	H4B-T15P	C04012B-T15P
R220.94-05.00	UC6S3/4UNFX1-1/4	H4B-T15P	C04012B-T15P
R220.94-06.00	–	H4B-T15P	C04012B-T15P

Accessories

For cutter	Arbor screw	Insert clamping torque	Torque key
R217/220.94-01.25-05.00	–	31.0IN.LBS	T00-15P35
R220.94-06.00	58215080	31.0IN.LBS	T00-15P35

Torque and fixed keys, see page 894

R217/220.94-12 – Insert selection – mm/Inch

SMG		a _p	f _z		
			100%	30%	10%
P1	LOEX120708TR-M12 F40M	6,0	0,18	0,20	0,30
		0.24	0.0070	0.0080	0.012
P2	LOEX120708TR-M12 F40M	6,0	0,19	0,20	0,32
		0.24	0.0075	0.0080	0.013
P3	LOEX120708TR-M12 MP2501	6,0	0,16	0,18	0,28
		0.24	0.0065	0.0070	0.011
P4	LOEX120708TR-M12 MP2501	6,0	0,16	0,17	0,26
		0.24	0.0065	0.0065	0.010
P5	LOEX120708TR-M12 MP2501	6,0	0,16	0,17	0,26
		0.24	0.0065	0.0065	0.010
P6	LOEX120708TR-M12 MP2501	6,0	0,16	0,17	0,26
		0.24	0.0065	0.0065	0.010
P7	LOEX120708TR-M12 MP2501	6,0	0,16	0,17	0,26
		0.24	0.0065	0.0065	0.010
P8	LOEX120708TR-M12 MP2501	6,0	0,16	0,18	0,28
		0.24	0.0065	0.0070	0.011
P11	LOEX120708TR-M12 T350M	6,0	0,17	0,18	0,28
		0.24	0.0065	0.0070	0.011
P12	LOEX120708TR-M12 MS2500	4,5	0,11	0,12	0,18
		0.18	0.0044	0.0048	0.0070
M1	LOEX120708R-M09 MS2050	6,0	0,14	0,16	0,24
		0.24	0.0055	0.0065	0.0095
M2	LOEX120708R-M09 MS2050	6,0	0,13	0,14	0,22
		0.24	0.0050	0.0055	0.0085
M3	LOEX120708R-M09 F40M	4,5	0,11	0,11	0,17
		0.18	0.0044	0.0044	0.0065
M4	LOEX120708R-M09 F40M	3,5	0,095	0,10	0,15
		0.14	0.0038	0.0040	0.0060
M5	LOEX120708R-M09 F40M	3,5	0,095	0,10	0,15
		0.14	0.0038	0.0040	0.0060
K1	LOEX120708TR-MD13 MK2050	6,0	0,20	0,22	0,34
		0.24	0.0080	0.0085	0.013
K2	LOEX120708TR-MD13 MK2050	6,0	0,18	0,20	0,30
		0.24	0.0070	0.0080	0.012
K3	LOEX120708TR-MD13 MK2050	6,0	0,18	0,20	0,30
		0.24	0.0070	0.0080	0.012
K4	LOEX120708TR-MD13 MK2050	6,0	0,18	0,20	0,30
		0.24	0.0070	0.0080	0.012
K5	LOEX120708TR-MD13 MK2050	6,0	0,17	0,18	0,28
		0.24	0.0065	0.0070	0.011
K6	LOEX120708TR-MD13 MK2050	6,0	0,18	0,20	0,30
		0.24	0.0070	0.0080	0.012
K7	LOEX120708TR-MD13 MK2050	6,0	0,17	0,18	0,28
		0.24	0.0065	0.0070	0.011
N1	LOEX120708R-M09 F40M	6,0	0,18	0,20	0,30
		0.24	0.0070	0.0080	0.012
N2	LOEX120708R-M09 F40M	6,0	0,18	0,20	0,30
		0.24	0.0070	0.0080	0.012
N3	LOEX120708R-M09 F40M	6,0	0,18	0,20	0,30
		0.24	0.0070	0.0080	0.012
N11	LOEX120708R-M09 F40M	6,0	0,18	0,20	0,30
		0.24	0.0070	0.0080	0.012
S1	LOEX120708R-M09 MS2050	3,5	0,095	0,10	0,15
		0.14	0.0038	0.0040	0.0060
S2	LOEX120708R-M09 MS2050	3,5	0,095	0,10	0,15
		0.14	0.0038	0.0040	0.0060
S3	LOEX120708TR-M12 MS2050	3,5	0,11	0,12	0,18
		0.14	0.0044	0.0048	0.0070
S11	LOEX120708R-M09 MS2050	4,0	0,11	0,12	0,17
		0.16	0.0044	0.0048	0.0065
S12	LOEX120708R-M09 MS2050	4,0	0,11	0,12	0,17
		0.16	0.0044	0.0048	0.0065
S13	LOEX120708TR-M12 MS2050	3,5	0,12	0,13	0,20
		0.14	0.0048	0.0050	0.0080
H5	LOEX120708TR-M12 MP3000	4,5	0,12	0,13	0,19
		0.18	0.0048	0.0050	0.0075
H8	LOEX120708TR-M12 MP3000	4,0	0,090	0,095	0,15
		0.16	0.0036	0.0038	0.0060
H11	LOEX120708TR-MD13 MP1501	4,5	0,12	0,13	0,19
		0.18	0.0048	0.0050	0.0075
H12	LOEX120708TR-MD13 MP1501	4,0	0,090	0,095	0,15
		0.16	0.0036	0.0038	0.0060

SMG = Seco material group
f_z = mm/tooth (in/tooth), v_c = m/min (sf/min), a_p/DC = %
All cutting data are start values

Square shoulder and slot milling cutters
Helical milling cutters
Face milling cutters
Disc milling cutters
High feed milling cutters
Copy milling cutters
Plunge milling cutters
Chamfer milling cutters
Spot facing cutters
Inserts

Square shoulder and slot milling cutters

Square T4 cutters



R217/220.94-12 – Cutting data $v_c = (m/min)/(sf/min)$

SMG	MP1501			MP2050			MP2501			MP3000			MM4500			MK1500		
	100%	30%	10%	100%	30%	10%	100%	30%	10%	100%	30%	10%	100%	30%	10%	100%	30%	10%
P1	295	390	465	265	350	420	275	365	435	255	340	405	165	220	260	—	—	—
	970	1275	1525	870	1150	1375	900	1200	1425	840	1125	1325	540	720	850	—	—	—
P2	285	380	445	255	340	400	270	355	425	245	330	385	160	215	250	—	—	—
	940	1250	1450	840	1125	1300	890	1175	1400	800	1075	1275	520	710	820	—	—	—
P3	250	330	390	225	300	350	235	310	365	215	290	340	140	185	220	—	—	—
	820	1075	1275	740	980	1150	770	1025	1200	710	950	1125	460	610	720	—	—	—
P4	220	290	345	200	265	310	205	275	330	195	255	300	125	165	195	—	—	—
	720	950	1125	660	870	1025	670	900	1075	640	840	980	410	540	640	—	—	—
P5	210	280	335	190	250	300	200	265	315	185	240	290	120	155	190	—	—	—
	690	920	1100	620	820	980	660	870	1025	615	790	950	395	510	620	—	—	—
P6	240	320	375	215	285	340	220	295	350	205	275	325	135	180	210	—	—	—
	790	1050	1225	710	940	1125	720	970	1150	670	900	1075	445	590	690	—	—	—
P7	225	300	355	200	270	320	210	280	330	195	260	310	125	170	200	—	—	—
	740	980	1175	660	890	1050	690	920	1075	640	850	1025	410	560	660	—	—	—
P8	210	280	330	190	250	295	200	260	305	180	240	285	115	155	185	—	—	—
	690	920	1075	620	820	970	660	850	1000	590	790	940	375	510	610	—	—	—
P11	220	290	345	195	265	310	205	270	325	190	255	300	125	165	195	—	—	—
	720	950	1125	640	870	1025	670	890	1075	620	840	980	410	540	640	—	—	—
P12	145	190	225	130	170	205	135	180	210	125	165	195	80	105	125	—	—	—
	475	620	740	425	560	670	445	590	690	410	540	640	260	345	410	—	—	—
M1	—	—	—	185	245	285	195	255	305	185	245	290	135	185	215	—	—	—
	—	—	—	610	800	940	640	840	1000	610	800	950	445	610	710	—	—	—
M2	—	—	—	155	200	240	160	215	250	155	205	245	115	150	180	—	—	—
	—	—	—	510	660	790	520	710	820	510	670	800	375	490	590	—	—	—
M3	—	—	—	125	165	195	130	170	205	125	165	200	95	125	145	—	—	—
	—	—	—	410	540	640	425	560	670	410	540	660	310	410	475	—	—	—
M4	—	—	—	100	130	150	105	135	160	100	130	150	75	95	115	—	—	—
	—	—	—	330	425	490	345	445	520	330	425	490	245	310	375	—	—	—
M5	—	—	—	80	110	125	85	115	135	80	110	125	60	80	95	—	—	—
	—	—	—	260	360	410	280	375	445	260	360	410	195	260	310	—	—	—
K1	225	300	350	200	270	315	215	280	335	195	260	305	—	—	—	275	365	435
	740	980	1150	660	890	1025	710	920	1100	640	850	1000	—	—	—	900	1200	1425
K2	200	265	315	180	240	285	190	250	300	175	230	275	—	—	—	250	325	390
	660	870	1025	590	790	940	620	820	980	570	750	900	—	—	—	820	1075	1275
K3	170	225	270	155	200	240	160	215	250	150	195	235	—	—	—	210	275	330
	560	740	890	510	660	790	520	710	820	490	640	770	—	—	—	690	900	1075
K4	160	215	255	145	195	230	150	205	240	140	185	225	—	—	—	200	265	315
	520	710	840	475	640	750	490	670	790	460	610	740	—	—	—	660	870	1025
K5	100	130	155	90	120	140	95	125	145	85	115	135	—	—	—	120	160	190
	330	425	510	295	395	460	310	410	475	280	375	445	—	—	—	395	520	620
K6	145	190	225	130	170	205	135	180	210	125	165	195	—	—	—	175	235	280
	475	620	740	425	560	670	445	590	690	410	540	640	—	—	—	570	770	920
K7	130	170	200	115	150	180	120	160	185	110	145	175	—	—	—	155	210	245
	425	560	660	375	490	590	395	520	610	360	475	570	—	—	—	510	690	800
N1	—	—	—	—	—	—	—	—	—	—	—	—	—	—	—	—	—	—
	—	—	—	—	—	—	—	—	—	—	—	—	—	—	—	—	—	—
N2	—	—	—	—	—	—	—	—	—	—	—	—	—	—	—	—	—	—
	—	—	—	—	—	—	—	—	—	—	—	—	—	—	—	—	—	—
N3	—	—	—	—	—	—	—	—	—	—	—	—	—	—	—	—	—	—
	—	—	—	—	—	—	—	—	—	—	—	—	—	—	—	—	—	—
N11	—	—	—	—	—	—	—	—	—	—	—	—	—	—	—	—	—	—
	—	—	—	—	—	—	—	—	—	—	—	—	—	—	—	—	—	—
S1	—	—	—	48	65	75	50	65	75	46	60	70	22	30	35	—	—	—
	—	—	—	155	215	245	165	215	245	150	195	230	70	100	115	—	—	—
S2	—	—	—	39	50	60	40	55	60	37	49	55	18	24	28	—	—	—
	—	—	—	130	165	195	130	180	195	120	160	180	60	80	90	—	—	—
S3	—	—	—	34	45	55	36	47	55	33	43	50	16	21	25	—	—	—
	—	—	—	110	150	180	120	155	180	110	140	165	50	70	80	—	—	—
S11	—	—	—	65	90	105	70	90	110	65	85	100	31	41	49	—	—	—
	—	—	—	215	295	345	230	295	360	215	280	330	100	135	160	—	—	—
S12	—	—	—	46	60	70	48	65	75	44	60	70	29	38	45	—	—	—
	—	—	—	150	195	230	155	215	245	145	195	230	95	125	150	—	—	—
S13	—	—	—	27	36	42	28	37	44	26	34	40	17	22	26	—	—	—
	—	—	—	90	120	140	90	120	145	85	110	130	55	70	85	—	—	—
H5	48	65	75	39	50	60	41	55	65	39	50	60	—	—	—	—	—	—
	155	215	245	130	165	195	135	180	215	130	165	195	—	—	—	—	—	—
H8	50	70	80	42	55	65	44	60	65	42	55	65	—	—	—	—	—	—
	165	230	260	140	180	215	145	195	215	140	180	215	—	—	—	—	—	—
H11	60	80	95	49	65	80	50	70	80	49	65	80	—	—	—	—	—	—
	195	260	310	160	215	260	165	230	260	160	215	260	—	—	—	—	—	—
H12	90	125	145	85	110	130	85	115	135	80	105	125	—	—	—	—	—	—
	295	410	475	280	360	425	280	375	445	260	345	410	—	—	—	—	—	—

R217/220.94-12 – Cutting data $v_c = (m/min)/(sf/min)$

SMG	MK2050			MS2050			MS2500			T350M			F40M		
	100%	30%	10%	100%	30%	10%	100%	30%	10%	100%	30%	10%	100%	30%	10%
P1	250	330	390	245	325	380	300	395	475	235	310	370	205	270	325
	820	1075	1275	800	1075	1250	980	1300	1550	770	1025	1225	670	890	1075
P2	245	320	380	240	310	370	295	385	465	225	305	355	195	265	310
	800	1050	1250	790	1025	1225	970	1275	1525	740	1000	1175	640	870	1025
P3	210	285	335	205	275	330	255	340	400	200	265	310	170	230	270
	690	940	1100	670	900	1075	840	1125	1300	660	870	1025	560	750	890
P4	185	250	295	185	240	290	225	300	360	175	235	275	155	205	240
	610	820	970	610	790	950	740	980	1175	570	770	900	510	670	790
P5	180	240	285	175	235	275	215	290	340	170	225	265	145	195	230
	590	790	940	570	770	900	710	950	1125	560	740	870	475	640	750
P6	205	270	320	200	265	310	245	325	385	190	255	300	165	220	260
	670	890	1050	660	870	1025	800	1075	1275	620	840	980	540	720	850
P7	190	255	305	185	250	290	230	305	360	180	240	285	155	210	245
	620	840	1000	610	820	950	750	1000	1175	590	790	940	510	690	800
P8	180	240	280	175	230	275	215	285	335	165	225	260	145	195	230
	590	790	920	570	750	900	710	940	1100	540	740	850	475	640	750
P11	185	245	295	180	240	285	220	295	350	175	235	275	150	205	240
	610	800	970	590	790	940	720	970	1150	570	770	900	490	670	790
P12	120	160	195	120	160	185	145	195	230	115	150	180	100	130	155
	395	520	640	395	520	610	475	640	750	375	490	590	330	425	510
M1	—	—	—	195	250	300	210	275	330	175	235	275	160	215	250
	—	—	—	640	820	980	690	900	1075	570	770	900	520	710	820
M2	—	—	—	160	210	250	175	230	275	145	190	230	135	175	210
	—	—	—	520	690	820	570	750	900	475	620	750	445	570	690
M3	—	—	—	130	170	200	140	185	225	120	155	190	110	145	170
	—	—	—	425	560	660	460	610	740	395	510	620	360	475	560
M4	—	—	—	100	135	155	110	145	175	95	125	145	85	110	130
	—	—	—	330	445	510	360	475	570	310	410	475	280	360	425
M5	—	—	—	85	110	130	95	120	145	80	105	120	70	95	110
	—	—	—	280	360	425	310	395	475	260	345	395	230	310	360
K1	260	345	410	—	—	—	—	—	—	180	240	280	155	210	245
	850	1125	1350	—	—	—	—	—	—	590	790	920	510	690	800
K2	235	310	370	—	—	—	—	—	—	160	210	255	140	185	220
	770	1025	1225	—	—	—	—	—	—	520	690	840	460	610	720
K3	200	260	315	—	—	—	—	—	—	135	180	215	120	155	185
	660	850	1025	—	—	—	—	—	—	445	590	710	395	510	610
K4	190	250	300	—	—	—	—	—	—	130	170	205	115	150	180
	620	820	980	—	—	—	—	—	—	425	560	670	375	490	590
K5	115	155	180	—	—	—	—	—	—	80	105	125	70	90	110
	375	510	590	—	—	—	—	—	—	260	345	410	230	295	360
K6	165	220	265	—	—	—	—	—	—	115	150	180	100	130	155
	540	720	870	—	—	—	—	—	—	375	490	590	330	425	510
K7	145	195	230	—	—	—	—	—	—	105	135	160	90	115	140
	475	640	750	—	—	—	—	—	—	345	445	520	295	375	460
N1	—	—	—	—	—	—	—	—	—	—	—	—	1150	1525	1800
	—	—	—	—	—	—	—	—	—	—	—	—	3775	5000	5900
N2	—	—	—	—	—	—	—	—	—	—	—	—	460	620	730
	—	—	—	—	—	—	—	—	—	—	—	—	1500	2025	2400
N3	—	—	—	—	—	—	—	—	—	—	—	—	310	410	485
	—	—	—	—	—	—	—	—	—	—	—	—	1025	1350	1600
N11	—	—	—	—	—	—	—	—	—	—	—	—	350	470	560
	—	—	—	—	—	—	—	—	—	—	—	—	1150	1550	1825
S1	—	—	—	47	60	75	55	70	85	44	60	65	40	50	60
	—	—	—	155	195	245	180	230	280	145	195	215	130	165	195
S2	—	—	—	38	50	60	44	60	70	35	46	55	32	42	49
	—	—	—	125	165	195	145	195	230	115	150	180	105	140	160
S3	—	—	—	33	44	50	39	50	60	31	41	48	28	37	44
	—	—	—	110	145	165	130	165	195	100	135	155	90	120	145
S11	—	—	—	65	85	100	75	100	120	60	80	95	55	70	85
	—	—	—	215	280	330	245	330	395	195	260	310	180	230	280
S12	—	—	—	45	60	70	50	70	80	42	55	65	38	50	60
	—	—	—	150	195	230	165	230	260	140	180	215	125	165	195
S13	—	—	—	26	35	41	31	40	47	25	32	38	22	29	34
	—	—	—	85	115	135	100	130	155	80	105	125	70	95	110
H5	—	—	—	—	—	—	—	—	—	38	50	60	33	44	50
	—	—	—	—	—	—	—	—	—	125	165	195	110	145	165
H8	—	—	—	—	—	—	—	—	—	41	55	65	36	47	55
	—	—	—	—	—	—	—	—	—	135	180	215	120	155	180
H11	—	—	—	—	—	—	—	—	—	48	65	75	42	55	65
	—	—	—	—	—	—	—	—	—	155	215	245	140	180	215
H12	—	—	—	—	—	—	95	125	145	75	100	115	65	85	100
	—	—	—	—	—	—	310	410	475	245	330	375	215	280	330

Square shoulder and slot milling cutters
Helical milling cutters
Face milling cutters
Disc milling cutters
High feed milling cutters
Copy milling cutters
Plunge milling cutters
Chamfer milling cutters
Spot facing cutters
Inserts



SQUARE 6

Seco's line of Square 6 shoulder milling cutters answers the need for added economy in square shoulder milling. This unique square shoulder milling cutter uses trigonal inserts with three cutting edges on each side – six total cutting edges – to lower the cost per cutting edge.

- With two different cutter family sizes - Insert size 04 and 08
- Wiper flats optimize surface finishes
- Multiple grades and geometries are available

Square shoulder and slot milling cutters

Helical milling cutters

Face milling cutters

Disc milling cutters

High feed milling cutters

Copy milling cutters

Plunge milling cutters

Chamfer milling cutters

Spot facing cutters

Inserts

Square 6™ – R217.96-04 – Metric

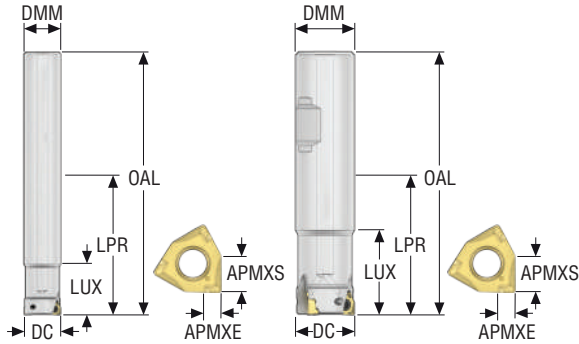

- For insert selection and cutting data recommendations, see page(s) 103-105
- For complete insert programme, see page(s) 863
- For ISO attribute explanation, see page 16
- KAPRS 90°

Designation	Item number	Type of mounting	DC	ZEFP	APMXS	APMXE	DMM	LUX	LPR	OAL	RPMX	Weight	Insert
			mm		mm	mm	mm	mm	mm	mm		kg	
R217.96-1820.0-04-3A	02833459	Cylindrical	20,0	3	4,0	2,0	18,0	100,0	100,0	150,0	29400	0,3	XNEX04..
R217.96-2020.0-04-3A	02768343	Cylindrical	20,0	3	4,0	2,0	20,0	29,0	100,0	150,0	29400	0,3	XNEX04..
R217.96-2525.0-04-4A	02768359	Cylindrical	25,0	4	4,0	2,0	25,0	29,0	114,0	170,0	26300	0,7	XNEX04..
R217.96-2525.0-04-5A	02768361	Cylindrical	25,0	5	4,0	2,0	25,0	29,0	114,0	170,0	26300	0,6	XNEX04..
R217.96-3232.0-04-5A	02768370	Cylindrical	32,0	5	4,0	2,0	32,0	31,0	135,0	195,0	23200	1,2	XNEX04..
R217.96-3232.0-04-6A	02768371	Cylindrical	32,0	6	4,0	2,0	32,0	31,0	135,0	195,0	23200	1,2	XNEX04..
R217.96-2020.3-04-3A	02768349	Weldon	20,0	3	4,0	2,0	20,0	29,0	40,0	90,0	29400	0,2	XNEX04..
R217.96-2525.3-04-4A	02768362	Weldon	25,0	4	4,0	2,0	25,0	34,0	45,0	101,0	26300	0,4	XNEX04..
R217.96-2525.3-04-5A	02768364	Weldon	25,0	5	4,0	2,0	25,0	34,0	45,0	101,0	26300	0,4	XNEX04..
R217.96-3232.3-04-5A	02768372	Weldon	32,0	5	4,0	2,0	32,0	37,0	45,0	105,0	23200	0,5	XNEX04..

Spare Parts, included in delivery

For cutter	Insert key	Insert screw
R217.96-..	H4B-T08P	C02506-T08P

Accessories

For cutter	Insert clamping torque	Torque key
R217.96-..	1.2NM	T00-08P12

Torque and fixed keys, see page 894

Square shoulder and slot milling cutters

Helical milling cutters

Face milling cutters

Disc milling cutters

High feed milling cutters

Copy milling cutters

Plunge milling cutters

Chamfer milling cutters

Spot facing cutters

Inserts

Square 6™ – R217.96-04 – inch

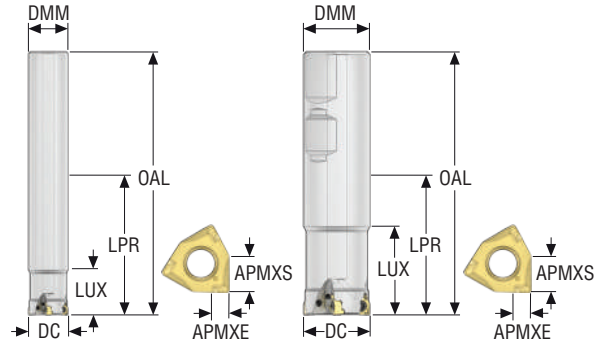

- For insert selection and cutting data recommendations, see page(s) 103-105
- For complete insert programme, see page(s) 863
- For ISO attribute explanation, see page 16
- KAPRS 90°

Designation	Item number	Type of mounting	DC	ZEFP	APMXS	APMXE	DMM	LUX	LPR	OAL	RPMX	Weight	Insert
			inch		inch	inch	inch	inch	inch	inch		lbs	
R217.96-00.75-0-04-3A	02770505	Cylindrical	0.750	3	0.157	0.079	0.750	1.394	3.941	5.910	29400	0.660	XNEX04..
R217.96-00.75-3-04-3A	02770536	Weldon	0.750	3	0.157	0.079	0.750	1.193	1.422	3.390	29400	0.440	XNEX04..
R217.96-01.00-3-04-5A	02770596	Weldon	1.000	5	0.157	0.079	1.000	1.178	1.575	3.780	26300	0.880	XNEX04..
R217.96-01.25-3-04-5A	02770602	Weldon	1.250	5	0.157	0.079	1.250	1.240	1.638	4.000	23200	1.320	XNEX04..

Spare Parts, included in delivery

For cutter	Insert key	Insert screw
R217.96..	H4B-T08P	C02506-T08P

Accessories

For cutter	Insert clamping torque	Torque key
R217.96-..	10.6IN.LBS	T00-08P12

Torque and fixed keys, see page 894

Square 6™ – R217/220.96-04 – Metric

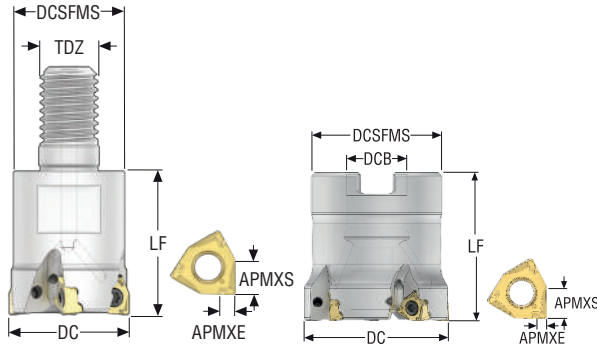



- For insert selection and cutting data recommendations, see page(s) 103-105
- For complete insert programme, see page(s) 863
- For ISO attribute explanation, see page 16
- KAPRS 90°

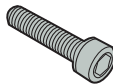

Designation	Item number	Type of mounting	DC	ZEFP	APMXS	APMXE	DCB	TDZ	DCSFMS	LF	Weight	RPMX	Insert
			mm		mm	mm	mm		mm	mm	kg		
R217.96-1020.RE-04-3A	02768351	Combimaster	20,0	3	4,0	2,0	–	M10	18,3	28,0	0,1	29400	XNEX04..
R217.96-1225.RE-04-4A	02768365	Combimaster	25,0	4	4,0	2,0	–	M12	23,0	30,0	0,1	26300	XNEX04..
R217.96-1225.RE-04-5A	02768367	Combimaster	25,0	5	4,0	2,0	–	M12	23,0	30,0	0,1	26300	XNEX04..
R217.96-1632.RE-04-5A	02768375	Combimaster	32,0	5	4,0	2,0	–	M16	30,0	40,0	0,3	23200	XNEX04..
R217.96-1632.RE-04-6A	02768376	Combimaster	32,0	6	4,0	2,0	–	M16	30,0	40,0	0,3	23200	XNEX04..
R220.96-0032-04-4A	02841298	Arbor	32,0	4	4,0	2,0	16,0	–	35,0	40,0	0,2	23200	XNEX04..
R220.96-0032-04-6A	02841306	Arbor	32,0	6	4,0	2,0	16,0	–	35,0	40,0	0,2	23200	XNEX04..
R220.96-0040-04-5A	02841154	Arbor	40,0	5	4,0	2,0	16,0	–	35,0	40,0	0,3	20700	XNEX04..
R220.96-0040-04-7A	02768377	Arbor	40,0	7	4,0	2,0	16,0	–	35,0	40,0	0,3	20700	XNEX04..
R220.96-0050-04-6A	02841155	Arbor	50,0	6	4,0	2,0	22,0	–	47,0	40,0	0,4	18600	XNEX04..
R220.96-0050-04-8A	02768413	Arbor	50,0	8	4,0	2,0	22,0	–	47,0	40,0	0,4	18600	XNEX04..
R220.96-0050-04-9A	02768412	Arbor	50,0	9	4,0	2,0	22,0	–	47,0	40,0	0,4	18600	XNEX04..
R220.96-0063-04-7A	02841156	Arbor	63,0	7	4,0	2,0	27,0	–	62,0	40,0	0,7	16500	XNEX04..
R220.96-0063-04-9A	02768433	Arbor	63,0	9	4,0	2,0	27,0	–	62,0	40,0	0,7	16500	XNEX04..

For Combimaster Shanks, see Machining Navigator Tooling System

Spare Parts, included in delivery

For cutter	Arbor screw	Insert key	Insert screw
			
R217.96-..	–	H4B-T08P	C02506-T08P
R220.96-0032-0040	TCEI0825	H4B-T08P	C02506-T08P
R220.96-0050	220.17-692	H4B-T08P	C02506-T08P
R220.96-0063	–	H4B-T08P	C02506-T08P

Accessories

For cutter	Insert clamping torque	Torque key
		
R217/220.96-..	1.2NM	T00-08P12

Torque and fixed keys, see page 894

Square 6™ – R217/220.96-04 – inch

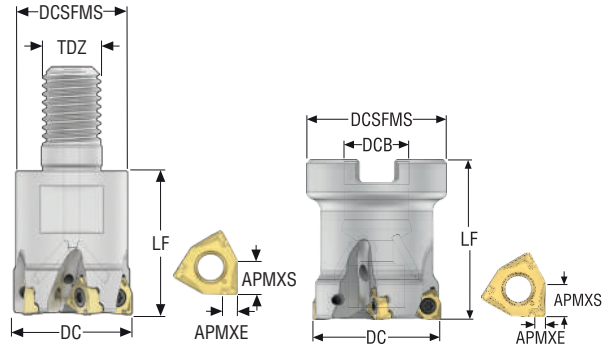

- For insert selection and cutting data recommendations, see page(s) 103-105
- For complete insert programme, see page(s) 863
- For ISO attribute explanation, see page 16
- KAPRS 90°

Designation	Item number	Type of mounting	DC	ZEFP	APMXS	APMXE	DCB	TDZ	DCSFMS	LF	Weight	RPMX	Insert
			inch		inch	inch	inch		inch	inch	lbs		
R217.96-00.75-10RE-04-3A	02770501	Combimaster	0.750	3	0.157	0.079	–	M10	0.689	1.070	0.220	29400	XNEX04..
R217.96-01.00-12RE-04-5A	02770543	Combimaster	1.000	5	0.157	0.079	–	M12	0.906	1.570	0.440	26300	XNEX04..
R217.96-01.25-16RE-04-5A	02770599	Combimaster	1.250	5	0.157	0.079	–	M16	1.181	1.570	0.660	23200	XNEX04..
R220.96-01.50-04-6A	02770608	Arbor	1.500	6	0.157	0.079	0.750	–	1.378	1.570	0.440	20700	XNEX04..
R220.96-02.00-04-9A	02770613	Arbor	2.000	9	0.157	0.079	0.750	–	1.850	1.570	0.880	18600	XNEX04..

For Combimaster Shanks, see Machining Navigator Tooling System

Spare Parts, included in delivery

For cutter	Arbor screw	Insert key	Insert screw
R217.96-..	–	H4B-T08P	C02506-T08P
R220.96-..	UC6S3/8UNFX1	H4B-T08P	C02506-T08P

Accessories

For cutter	Insert clamping torque	Torque key
R217/220.96-..	10.6IN.LBS	T00-08P12

Torque and fixed keys, see page 894

R217/220.96-04 – Insert selection – mm/Inch

SMG		a _p	f _z		
			100%	30%	10%
P1	XNEX040304TR-M08 F40M	2,0	0,11	0,13	0,19
		0,080	0,0044	0,0050	0,0075
P2	XNEX040304TR-M08 F40M	2,0	0,12	0,13	0,19
		0,080	0,0048	0,0050	0,0075
P3	XNEX040304TR-M08 MP2501	2,0	0,11	0,12	0,18
		0,080	0,0044	0,0048	0,0070
P4	XNEX040304TR-M08 MP2501	2,0	0,11	0,12	0,18
		0,080	0,0044	0,0048	0,0070
P5	XNEX040304TR-M08 MP2501	2,0	0,11	0,12	0,18
		0,080	0,0044	0,0048	0,0070
P6	XNEX040304TR-M08 MP2501	2,0	0,10	0,11	0,17
		0,080	0,0040	0,0044	0,0065
P7	XNEX040304TR-M08 MP2501	2,0	0,10	0,11	0,17
		0,080	0,0040	0,0044	0,0065
P8	XNEX040304TR-M08 MP2501	2,0	0,11	0,12	0,18
		0,080	0,0044	0,0048	0,0070
P11	XNEX040304TR-M08 MP3000	2,0	0,10	0,11	0,17
		0,080	0,0040	0,0044	0,0065
P12	XNEX040304TR-M08 MP3000	1,6	0,075	0,080	0,12
		0,065	0,0030	0,0032	0,0048
M1	XNEX040304R-M06 F40M	2,0	0,085	0,095	0,15
		0,080	0,0034	0,0038	0,0060
M2	XNEX040304R-M06 F40M	2,0	0,080	0,085	0,13
		0,080	0,0032	0,0034	0,0050
M3	XNEX040304R-M06 F40M	1,6	0,065	0,070	0,11
		0,065	0,0026	0,0028	0,0044
M4	XNEX040304R-M06 F40M	1,2	0,060	0,060	0,090
		0,048	0,0024	0,0024	0,0036
M5	XNEX040304R-M06 F40M	1,2	0,060	0,060	0,090
		0,048	0,0024	0,0024	0,0036
K1	XNEX040304TR-M08 MK2050	2,0	0,12	0,13	0,19
		0,080	0,0048	0,0050	0,0075
K2	XNEX040304TR-M08 MK2050	2,0	0,11	0,12	0,18
		0,080	0,0044	0,0048	0,0070
K3	XNEX040304TR-M08 MK2050	2,0	0,11	0,12	0,18
		0,080	0,0044	0,0048	0,0070
K4	XNEX040304TR-M08 MK2050	2,0	0,11	0,12	0,18
		0,080	0,0044	0,0048	0,0070
K5	XNEX040304TR-M08 MK2050	2,0	0,095	0,10	0,16
		0,080	0,0038	0,0040	0,0065
K6	XNEX040304TR-M08 MK2050	2,0	0,11	0,12	0,18
		0,080	0,0044	0,0048	0,0070
K7	XNEX040304TR-M08 MK2050	2,0	0,095	0,10	0,16
		0,080	0,0038	0,0040	0,0065
N1	XNEX040304R-M06 F40M	2,0	0,11	0,12	0,19
		0,080	0,0044	0,0048	0,0075
N2	XNEX040304R-M06 F40M	2,0	0,11	0,12	0,19
		0,080	0,0044	0,0048	0,0075
N3	XNEX040304R-M06 F40M	2,0	0,11	0,12	0,19
		0,080	0,0044	0,0048	0,0075
N11	XNEX040304R-M06 F40M	2,0	0,11	0,12	0,19
		0,080	0,0044	0,0048	0,0075
S1	XNEX040304R-M06 F40M	1,2	0,060	0,060	0,090
		0,048	0,0024	0,0024	0,0036
S2	XNEX040304R-M06 F40M	1,2	0,060	0,060	0,090
		0,048	0,0024	0,0024	0,0036
S3	XNEX040304R-M06 F40M	1,2	0,055	0,060	0,085
		0,048	0,0022	0,0024	0,0034
S11	XNEX040304R-M06 MS2050	1,4	0,065	0,070	0,11
		0,055	0,0026	0,0028	0,0044
S12	XNEX040304R-M06 MS2050	1,4	0,065	0,070	0,11
		0,055	0,0026	0,0028	0,0044
S13	XNEX040304R-M06 MS2050	1,2	0,060	0,060	0,090
		0,048	0,0024	0,0024	0,0036
H5	XNEX040304TR-M08 MP3000	1,6	0,075	0,080	0,12
		0,065	0,0030	0,0032	0,0048
H8	XNEX040304TR-M08 MP3000	1,4	0,055	0,060	0,090
		0,055	0,0022	0,0024	0,0036
H11	XNEX040304TR-M08 MP3000	1,6	0,075	0,080	0,12
		0,065	0,0030	0,0032	0,0048
H12	XNEX040304TR-M08 MP1501	1,4	0,055	0,060	0,090
		0,055	0,0022	0,0024	0,0036

SMG = Seco material group
f_z = mm/tooth (in/tooth), v_c = m/min (sf/min), a_p/DC = %
All cutting data are start values

Square shoulder and slot milling cutters
Helical milling cutters
Face milling cutters
Disc milling cutters
High feed milling cutters
Copy milling cutters
Plunge milling cutters
Chamfer milling cutters
Spot facing cutters
Inserts

R217/220.96-04 – Cutting data $v_c = (m/min)/(sf/min)$

SMG	MP1501			MP2501			MP3000			MM4500		
	100%	30%	10%	100%	30%	10%	100%	30%	10%	100%	30%	10%
P1	350	465	540	310	410	480	295	390	455	190	255	295
	1150	1525	1775	1025	1350	1575	970	1275	1500	620	840	970
P2	340	455	530	300	400	465	285	380	440	185	245	285
	1125	1500	1750	980	1300	1525	940	1250	1450	610	800	940
P3	295	390	460	260	345	405	245	325	385	160	210	250
	970	1275	1500	850	1125	1325	800	1075	1275	520	690	820
P4	265	350	410	235	310	360	220	295	345	145	190	220
	870	1150	1350	770	1025	1175	720	970	1125	475	620	720
P5	255	335	390	225	295	345	210	280	325	135	180	210
	840	1100	1275	740	970	1125	690	920	1075	445	590	690
P6	285	375	440	250	330	390	240	315	365	155	205	240
	940	1225	1450	820	1075	1275	790	1025	1200	510	670	790
P7	270	355	415	235	315	365	225	295	345	145	190	225
	890	1175	1350	770	1025	1200	740	970	1125	475	620	740
P8	245	325	385	220	290	340	205	275	325	135	180	210
	800	1075	1275	720	950	1125	670	900	1075	445	590	690
P11	260	345	400	230	305	355	220	290	335	140	185	220
	850	1125	1300	750	1000	1175	720	950	1100	460	610	720
P12	170	220	260	150	195	230	140	185	220	90	120	140
	560	720	850	490	640	750	460	610	720	295	395	460
M1	—	—	—	220	290	335	215	285	330	160	210	245
	—	—	—	720	950	1100	710	940	1075	520	690	800
M2	—	—	—	180	240	280	175	235	275	130	175	205
	—	—	—	590	790	920	570	770	900	425	570	670
M3	—	—	—	145	190	225	140	185	220	105	140	165
	—	—	—	475	620	740	460	610	720	345	460	540
M4	—	—	—	115	150	170	110	145	170	85	110	125
	—	—	—	375	490	560	360	475	560	280	360	410
M5	—	—	—	95	125	145	95	120	140	70	90	105
	—	—	—	310	410	475	310	395	460	230	295	345
K1	270	360	415	240	320	370	225	300	350	—	—	—
	890	1175	1350	790	1050	1225	740	980	1150	—	—	—
K2	240	315	370	210	280	330	200	265	310	—	—	—
	790	1025	1225	690	920	1075	660	870	1025	—	—	—
K3	205	270	315	180	240	280	170	225	265	—	—	—
	670	890	1025	590	790	920	560	740	870	—	—	—
K4	195	255	300	170	225	265	160	215	250	—	—	—
	640	840	980	560	740	870	520	710	820	—	—	—
K5	120	155	185	105	140	160	100	130	155	—	—	—
	395	510	610	345	460	520	330	425	510	—	—	—
K6	170	225	265	150	200	235	145	190	220	—	—	—
	560	740	870	490	660	770	475	620	720	—	—	—
K7	150	200	235	135	175	210	125	165	195	—	—	—
	490	660	770	445	570	690	410	540	640	—	—	—
N1	—	—	—	—	—	—	—	—	—	—	—	—
	—	—	—	—	—	—	—	—	—	—	—	—
N2	—	—	—	—	—	—	—	—	—	—	—	—
	—	—	—	—	—	—	—	—	—	—	—	—
N3	—	—	—	—	—	—	—	—	—	—	—	—
	—	—	—	—	—	—	—	—	—	—	—	—
N11	—	—	—	—	—	—	—	—	—	—	—	—
	—	—	—	—	—	—	—	—	—	—	—	—
S1	—	—	—	55	70	85	50	70	80	25	33	38
	—	—	—	180	230	280	165	230	260	80	110	125
S2	—	—	—	44	60	65	42	55	65	20	27	31
	—	—	—	145	195	215	140	180	215	65	90	100
S3	—	—	—	39	50	60	37	48	55	18	23	27
	—	—	—	130	165	195	120	155	180	60	75	90
S11	—	—	—	75	100	120	70	95	110	35	46	55
	—	—	—	245	330	395	230	310	360	115	150	180
S12	—	—	—	55	70	80	50	65	75	33	43	50
	—	—	—	180	230	260	165	215	245	110	140	165
S13	—	—	—	31	40	47	29	38	44	19	25	29
	—	—	—	100	130	155	95	125	145	60	80	95
H5	55	75	85	45	60	70	44	60	70	—	—	—
	180	245	280	150	195	230	145	195	230	—	—	—
H8	60	80	90	48	65	75	47	60	70	—	—	—
	195	260	295	155	215	245	155	195	230	—	—	—
H11	70	95	110	55	75	90	55	75	85	—	—	—
	230	310	360	180	245	295	180	245	280	—	—	—
H12	105	140	160	95	125	145	90	115	135	—	—	—
	345	460	520	310	410	475	295	375	445	—	—	—

R217/220.96-04 – Cutting data $v_c = (m/min)/(sf/min)$

SMG	MK1500			MK2050			MS2050			F40M		
	100%	30%	10%	100%	30%	10%	100%	30%	10%	100%	30%	10%
P1	—	—	—	305	405	470	290	380	445	235	310	360
	—	—	—	1000	1325	1550	950	1250	1450	770	1025	1175
P2	—	—	—	300	395	460	280	370	430	230	305	355
	—	—	—	980	1300	1500	920	1225	1400	750	1000	1175
P3	—	—	—	255	340	400	245	320	380	195	260	305
	—	—	—	840	1125	1300	800	1050	1250	640	850	1000
P4	—	—	—	230	305	355	215	285	335	180	235	275
	—	—	—	750	1000	1175	710	940	1100	590	770	900
P5	—	—	—	220	290	340	205	275	320	170	225	260
	—	—	—	720	950	1125	670	900	1050	560	740	850
P6	—	—	—	245	325	380	230	310	360	190	250	295
	—	—	—	800	1075	1250	750	1025	1175	620	820	970
P7	—	—	—	235	310	360	220	290	340	180	235	275
	—	—	—	770	1025	1175	720	950	1125	590	770	900
P8	—	—	—	215	285	335	205	270	320	165	220	260
	—	—	—	710	940	1100	670	890	1050	540	720	850
P11	—	—	—	225	300	350	215	280	330	175	230	270
	—	—	—	740	980	1150	710	920	1075	570	750	890
P12	—	—	—	145	195	225	135	180	210	115	150	175
	—	—	—	475	640	740	445	590	690	375	490	570
M1	—	—	—	—	—	—	225	300	350	185	245	285
	—	—	—	—	—	—	740	980	1150	610	800	940
M2	—	—	—	—	—	—	185	245	285	155	200	235
	—	—	—	—	—	—	610	800	940	510	660	770
M3	—	—	—	—	—	—	150	195	230	120	160	190
	—	—	—	—	—	—	490	640	750	395	520	620
M4	—	—	—	—	—	—	115	150	175	95	125	145
	—	—	—	—	—	—	375	490	570	310	410	475
M5	—	—	—	—	—	—	95	125	145	80	105	120
	—	—	—	—	—	—	310	410	475	260	345	395
K1	340	450	520	320	425	495	—	—	—	180	240	280
	1125	1475	1700	1050	1400	1625	—	—	—	590	790	920
K2	300	400	465	285	375	440	—	—	—	160	215	250
	980	1300	1525	940	1225	1450	—	—	—	520	710	820
K3	255	335	395	240	320	370	—	—	—	135	180	210
	840	1100	1300	790	1050	1225	—	—	—	445	590	690
K4	245	320	375	230	305	355	—	—	—	130	170	200
	800	1050	1225	750	1000	1175	—	—	—	425	560	660
K5	150	195	230	140	185	220	—	—	—	80	105	125
	490	640	750	460	610	720	—	—	—	260	345	410
K6	215	285	330	205	270	315	—	—	—	115	150	175
	710	940	1075	670	890	1025	—	—	—	375	490	570
K7	190	250	295	180	235	280	—	—	—	100	135	155
	620	820	970	590	770	920	—	—	—	330	445	510
N1	—	—	—	—	—	—	—	—	—	1325	1775	2075
	—	—	—	—	—	—	—	—	—	4350	5825	6800
N2	—	—	—	—	—	—	—	—	—	540	720	840
	—	—	—	—	—	—	—	—	—	1775	2350	2750
N3	—	—	—	—	—	—	—	—	—	355	480	560
	—	—	—	—	—	—	—	—	—	1175	1575	1825
N11	—	—	—	—	—	—	—	—	—	410	550	640
	—	—	—	—	—	—	—	—	—	1350	1800	2100
S1	—	—	—	—	—	—	55	70	85	45	60	70
	—	—	—	—	—	—	180	230	280	150	195	230
S2	—	—	—	—	—	—	44	55	65	36	47	55
	—	—	—	—	—	—	145	180	215	120	155	180
S3	—	—	—	—	—	—	38	50	60	32	41	48
	—	—	—	—	—	—	125	165	195	105	135	155
S11	—	—	—	—	—	—	75	100	115	60	80	95
	—	—	—	—	—	—	245	330	375	195	260	310
S12	—	—	—	—	—	—	55	70	80	43	55	65
	—	—	—	—	—	—	180	230	260	140	180	215
S13	—	—	—	—	—	—	31	40	46	25	33	38
	—	—	—	—	—	—	100	130	150	80	110	125
H5	—	—	—	—	—	—	—	—	—	37	49	60
	—	—	—	—	—	—	—	—	—	120	160	195
H8	—	—	—	—	—	—	—	—	—	40	50	60
	—	—	—	—	—	—	—	—	—	130	165	195
H11	—	—	—	—	—	—	—	—	—	48	65	75
	—	—	—	—	—	—	—	—	—	155	215	245
H12	—	—	—	—	—	—	—	—	—	70	95	110
	—	—	—	—	—	—	—	—	—	230	310	360

Square shoulder and slot milling cutters
Helical milling cutters
Face milling cutters
Disc milling cutters
High feed milling cutters
Copy milling cutters
Plunge milling cutters
Chamfer milling cutters
Spot facing cutters
Inserts

Square 6™ – R217.96-08 – Metric

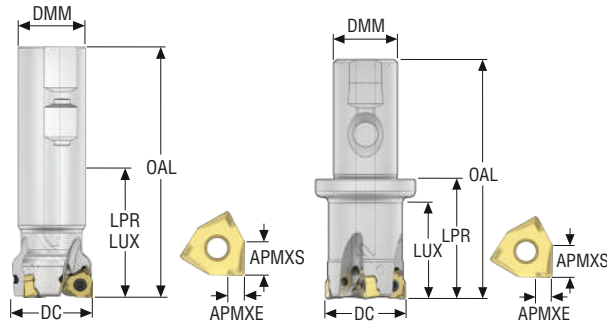

- For insert selection and cutting data recommendations, see page(s) 113-115
- For complete insert programme, see page(s) 863
- For ISO attribute explanation, see page 16
- KAPRS 90°

Designation	Item number	Type of mounting	DC	ZEFP	APMXS	APMXE	DMM	LUX	LPR	OAL	RPMX	Weight	Insert
			mm		mm	mm	mm	mm	mm	mm		kg	
R217.96-3240.3-08-3A	02622987	Weldon	40,0	3	7,5	3,0	32,0	60,0	60,0	120,0	11800	0,7	XNEX08..
R217.96-3240.3-08-4A	02622989	Weldon	40,0	4	7,5	3,0	32,0	60,0	60,0	120,0	11800	0,7	XNEX08..
R217.96-3240.3S-08-3A	02622914	Seco-Weldon	40,0	3	7,5	3,0	32,0	50,0	60,0	120,0	11800	0,8	XNEX08..
R217.96-3240.3S-08-4A	02622915	Seco-Weldon	40,0	4	7,5	3,0	32,0	50,0	60,0	120,0	11800	0,8	XNEX08..

Spare Parts, included in delivery

For cutter	Insert key	Insert screw
R217.96-..	H4B-T15P	C04011-T15P

Accessories

For cutter	Insert clamping torque	Torque key
R217.96-..	3.5NM	T00-15P35

Torque and fixed keys, see page 894

Square 6™ – R217.96-08 – inch

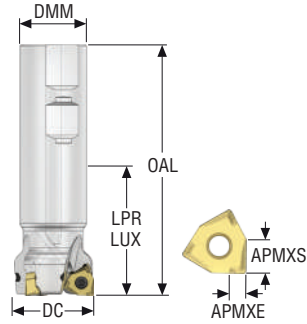

- For insert selection and cutting data recommendations, see page(s) 113-115
- For complete insert programme, see page(s) 863
- For ISO attribute explanation, see page 16
- KAPRS 90°

Designation	Item number	Type of mounting	DC	ZEFP	APMXS	APMXE	DMM	LUX	LPR	OAL	RPMX	Weight	Insert
			inch		inch	inch	inch	inch	inch	inch		lbs	
R217.96-01.50-3-08-3A	02642818	Weldon	1.500	3	0.295	0.118	1.250	2.138	2.138	4.500	20700	1.760	XNEX08..

Spare Parts, included in delivery

For cutter	Insert key	Insert screw
R217.96-..	H4B-T15P	C04011-T15P

Accessories

For cutter	Insert clamping torque	Torque key
R217.96-..	31.0IN.LBS	T00-15P35

Torque and fixed keys, see page 894

Square shoulder and slot milling cutters

Helical milling cutters

Face milling cutters

Disc milling cutters

High feed milling cutters

Copy milling cutters

Plunge milling cutters

Chamfer milling cutters

Spot facing cutters

Inserts

Square 6™ – R217/220.96-08 – Metric

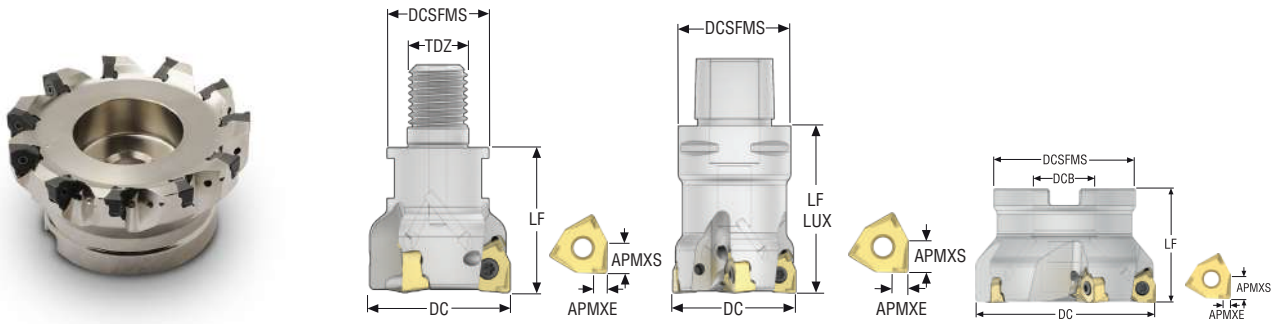

- For insert selection and cutting data recommendations, see page(s) 113-115
- For complete insert programme, see page(s) 863
- For ISO attribute explanation, see page 16
- KAPRS 90°

Designation	Item number	Type of mounting	DC	ZEFP	APMXS	APMXE	DCB	TDZ	DCSFMS	LUX	LF	RPMX	Weight	Insert
			mm		mm	mm	mm		mm	mm	mm		kg	
R217.96-1640.RE-08-3A	02678953	Combimaster	40,0	3	7,5	3,0	–	M16	28,0	–	40,0	11800	0,3	XNEX08..
R217.96-1640.RE-08-4A	02678957	Combimaster	40,0	4	7,5	3,0	–	M16	28,0	–	40,0	11800	0,3	XNEX08..
R217.96-2040.RE-08-4A	02972745	Combimaster	40,0	4	7,5	3,0	–	M20	36,5	–	40,0	11800	0,4	XNEX08..
C4-R217.96-044-08-3A	02690109	Seco-Capto	44,0	3	7,5	3,0	–	–	40,0	60,0	60,0	11300	0,6	XNEX08..
C4-R217.96-044-08-4A	02690177	Seco-Capto	44,0	4	7,5	3,0	–	–	40,0	60,0	60,0	11300	0,5	XNEX08..
C5-R217.96-054-08-4A	02690178	Seco-Capto	54,0	4	7,5	3,0	–	–	50,0	60,0	60,0	10200	0,9	XNEX08..
C5-R217.96-054-08-5A	02690179	Seco-Capto	54,0	5	7,5	3,0	–	–	50,0	60,0	60,0	10200	0,9	XNEX08..
C5-R217.96-063-08-6A	02690180	Seco-Capto	63,0	6	7,5	3,0	–	–	50,0	60,0	60,0	9400	1,0	XNEX08..
C5-R217.96-063-08-7A	02690181	Seco-Capto	63,0	7	7,5	3,0	–	–	50,0	60,0	60,0	9400	1,0	XNEX08..
C6-R217.96-066-08-7A	02780514	Seco-Capto	66,0	7	7,5	3,0	–	–	63,0	60,0	60,0	9400	1,4	XNEX08..
C6-R217.96-080-08-7A	02690182	Seco-Capto	80,0	7	7,5	3,0	–	–	63,0	60,0	60,0	8400	1,7	XNEX08..
C6-R217.96-080-08-9A	02690183	Seco-Capto	80,0	9	7,5	3,0	–	–	63,0	60,0	60,0	8400	1,2	XNEX08..
R220.96-0050-08-4A	02623180	Arbor	50,0	4	7,5	3,0	22,0	–	47,0	–	40,0	10600	0,3	XNEX08..
R220.96-0050-08-5A	02623182	Arbor	50,0	5	7,5	3,0	22,0	–	47,0	–	40,0	10600	0,3	XNEX08..
R220.96-0052-08-5A	02969090	Arbor	52,0	5	7,5	3,0	22,0	–	47,0	–	40,0	10600	0,4	XNEX08..
R220.96-0063-08-4A	02623183	Arbor	63,0	4	7,5	3,0	22,0	–	47,0	–	40,0	9400	0,5	XNEX08..
R220.96-0063-08-5A-27	02768079	Arbor	63,0	5	7,5	3,0	27,0	–	62,0	–	40,0	9400	0,6	XNEX08..
R220.96-0063-08-6A	02623194	Arbor	63,0	6	7,5	3,0	22,0	–	47,0	–	40,0	9400	0,5	XNEX08..
R220.96-0063-08-6A-27	02679623	Arbor	63,0	6	7,5	3,0	27,0	–	62,0	–	40,0	9400	0,6	XNEX08..
R220.96-0063-08-7A	02623196	Arbor	63,0	7	7,5	3,0	22,0	–	47,0	–	40,0	9400	0,7	XNEX08..
R220.96-0063-08-7A-27	02679624	Arbor	63,0	7	7,5	3,0	27,0	–	62,0	–	40,0	9400	0,6	XNEX08..
R220.96-0066-08-6A	02711515	Arbor	66,0	6	7,5	3,0	22,0	–	47,0	–	40,0	9400	0,6	XNEX08..
R220.96-0080-08-5A	02623197	Arbor	80,0	5	7,5	3,0	27,0	–	62,0	–	50,0	8400	1,1	XNEX08..
R220.96-0080-08-7A	02623198	Arbor	80,0	7	7,5	3,0	27,0	–	62,0	–	50,0	8400	1,0	XNEX08..
R220.96-0080-08-9A	02623200	Arbor	80,0	9	7,5	3,0	27,0	–	62,0	–	50,0	8400	1,0	XNEX08..
R220.96-0084-08-7A	02969094	Arbor	84,0	7	7,5	3,0	27,0	–	62,0	–	50,0	8400	1,2	XNEX08..
R220.96-0100-08-6A	02623201	Arbor	100,0	6	7,5	3,0	32,0	–	77,0	–	50,0	7500	1,6	XNEX08..
R220.96-0100-08-8A	02623203	Arbor	100,0	8	7,5	3,0	32,0	–	77,0	–	50,0	7500	1,5	XNEX08..
R220.96-0100-08-11A	02623204	Arbor	100,0	11	7,5	3,0	32,0	–	77,0	–	50,0	7500	1,5	XNEX08..
R220.96-0125-08-7A	02640708	Arbor	125,0	7	7,5	3,0	40,0	–	90,0	–	63,0	6700	2,9	XNEX08..
R220.96-0125-08-11A	02640709	Arbor	125,0	11	7,5	3,0	40,0	–	90,0	–	63,0	6700	2,8	XNEX08..
R220.96-0125-08-14A	02640710	Arbor	125,0	14	7,5	3,0	40,0	–	90,0	–	63,0	6700	2,7	XNEX08..
R220.96-8160-08-12	02640711	Arbor	160,0	12	7,5	3,0	40,0	–	90,0	–	63,0	5900	4,8	XNEX08..
R220.96-8160-08-16	02640712	Arbor	160,0	16	7,5	3,0	40,0	–	90,0	–	63,0	5900	4,8	XNEX08..

For Combimaster Shanks, see Machining Navigator Tooling System

Spare Parts, included in delivery

For cutter	Arbor screw	Insert key	Insert screw
Cx/R217.96-..	-	H4B-T15P	C04011-T15P
R220.96-0050-0052	220.17-696	H4B-T15P	C04011-T15P
R220.96-0063-0066	220.17-692	H4B-T15P	C04011-T15P
R220.96-0063-27	220.17-693	H4B-T15P	C04011-T15P
R220.96-0080	MC6S12X35	H4B-T15P	C04011-T15P
R220.96-0084	MC6S12X35	H4B-T15P	C04011-T15P
R220.96-0100-0125	-	H4B-T15PL	C04011-T15P
R220.96-8160	-	H4B-T15PL	C04011-T15P

Accessories

For cutter	Arbor screw	Insert clamping torque	Torque key
Cx-R217/220.96-1640-0125	-	3.5NM	T00-15P35
R220.96-8160	MC6S12X40	3.5NM	T00-15P35

Torque and fixed keys, see page 894

Square shoulder and slot milling cutters
Helical milling cutters
Face milling cutters
Disc milling cutters
High feed milling cutters
Copy milling cutters
Plunge milling cutters
Chamfer milling cutters
Spot facing cutters
Inserts

Square 6™ – R217/220.96-08 – inch

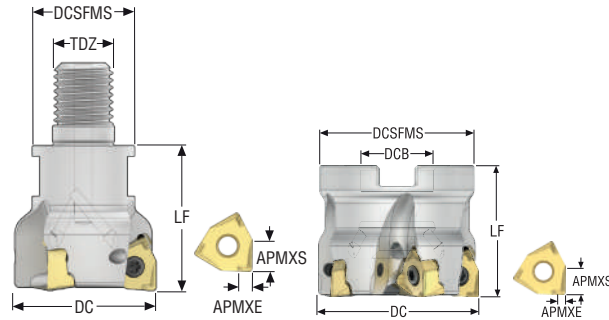



- For insert selection and cutting data recommendations, see page(s) 113-115
- For complete insert programme, see page(s) 863
- For ISO attribute explanation, see page 16
- KAPRS 90°

Designation	Item number	Type of mounting	DC	ZEFP	APMXS	APMXE	DCB	TDZ	DCSFMS	LF	RPMX	Weight	Insert
			inch		inch	inch	inch		inch	inch		lbs	
R217.96-01.50-20RE-08-3A	03212088	Combimaster	1.500	3	0.295	0.118	–	M20	1.398	1.575	20700	0.660	XNEX08..
R220.96-02.00-08-4A	02642870	Arbor	2.000	4	0.295	0.118	0.750	–	1.850	1.575	10600	1.100	XNEX08..
R220.96-02.00-08-5A	02642872	Arbor	2.000	5	0.295	0.118	0.750	–	1.850	1.575	10600	1.100	XNEX08..
R220.96-02.50-08-4A	02642873	Arbor	2.500	4	0.295	0.118	0.750	–	1.850	1.575	9400	1.540	XNEX08..
R220.96-02.50-08-6A	02642874	Arbor	2.500	6	0.295	0.118	0.750	–	1.850	1.575	9400	1.320	XNEX08..
R220.96-02.50-08-7A	02642878	Arbor	2.500	7	0.295	0.118	0.750	–	1.850	1.575	9400	1.320	XNEX08..
R220.96-03.00-08-5A	02642879	Arbor	3.000	5	0.295	0.118	1.000	–	2.441	1.969	8400	2.870	XNEX08..
R220.96-03.00-08-7A	02642881	Arbor	3.000	7	0.295	0.118	1.000	–	2.441	1.969	8400	2.200	XNEX08..
R220.96-03.00-08-9A	02642882	Arbor	3.000	9	0.295	0.118	1.000	–	2.441	1.969	8400	1.980	XNEX08..
R220.96-04.00-08-6A	02642884	Arbor	4.000	6	0.295	0.118	1.500	–	3.543	1.969	7500	3.530	XNEX08..
R220.96-04.00-08-8A	02642886	Arbor	4.000	8	0.295	0.118	1.500	–	3.543	1.969	7500	3.970	XNEX08..
R220.96-04.00-08-11A	02642887	Arbor	4.000	11	0.295	0.118	1.500	–	3.543	1.969	7500	4.190	XNEX08..
R220.96-05.00-08-7A	02642888	Arbor	5.000	7	0.295	0.118	1.500	–	3.543	2.480	6700	7.280	XNEX08..
R220.96-05.00-08-11A	02642889	Arbor	5.000	11	0.295	0.118	1.500	–	3.543	2.480	6700	7.050	XNEX08..
R220.96-06.00-08-12	02642891	Arbor	6.000	12	0.295	0.118	2.000	–	4.331	2.480	5900	9.480	XNEX08..

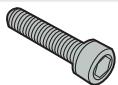

For Combimaster Shanks, see Machining Navigator Tooling System

Square shoulder and slot milling cutters
Helical milling cutters
Face milling cutters
Disc milling cutters
High feed milling cutters
Copy milling cutters
Plunge milling cutters
Chamfer milling cutters
Spot facing cutters
Inserts

Spare Parts, included in delivery

For cutter	Arbor screw	Insert key	Insert screw
			
R217.96-..	-	H4B-T15P	C04011-T15P
R220.96-02.00-02.50	UC6S3/8UNFX1	H4B-T15P	C04011-T15P
R220.96-03.00	UC6S1/2UNFX1-1/4	H4B-T15P	C04011-T15P
R220.96-04.00	UF6S3/4UNFX1-3/4	H4B-T15PL	C04011-T15P
R220.96-05.00	UC6S3/4UNFX1-1/4	H4B-T15PL	C04011-T15P
R220.96-06.00	-	H4B-T15PL	C04011-T15P

Accessories

For cutter	Arbor screw	Insert clamping torque	Torque key
			
R217/220.96-01.50-05.00	-	31.0IN.LBS	T00-15P35
R220.96-06.00	58215080	31.0IN.LBS	T00-15P35

Torque and fixed keys, see page 894

- Square shoulder and slot milling cutters
- Helical milling cutters
- Face milling cutters
- Disc milling cutters
- High feed milling cutters
- Copy milling cutters
- Plunge milling cutters
- Chamfer milling cutters
- Spot facing cutters
- Inserts

Square 6™ – R220.96-08 – Metric

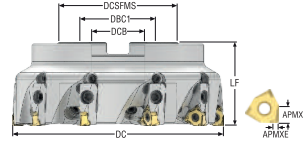

- For insert selection and cutting data recommendations, see page(s) 113-115
- For complete insert programme, see page(s) 863
- For ISO attribute explanation, see page 16
- KAPRS 90°

Designation	Item number	Type of mounting	DC	ZEFP	APMXS	APMXE	DCB	DCSFMS	LF	RPMX	Weight	Insert
			mm		mm	mm	mm	mm	mm		kg	
R220.96-8160-08-7C	02827066	Arbor	160,0	7	7,5	3,0	40,0	130,0	63,0	5900	5,6	XNEX08..
R220.96-8160-08-10C	02827062	Arbor	160,0	10	7,5	3,0	40,0	90,0	63,0	5900	5,5	XNEX08..
R220.96-8200-08-8C	02827067	Arbor	200,0	8	7,5	3,0	60,0	160,0	63,0	5300	8,0	XNEX08..
R220.96-8200-08-12C	02827063	Arbor	200,0	12	7,5	3,0	60,0	160,0	63,0	5300	7,8	XNEX08..
R220.96-8250-08-10C	02827068	Arbor	250,0	10	7,5	3,0	60,0	210,0	63,0	4200	15,2	XNEX08..

Spare Parts, included in delivery

For cutter	Adjustment unit	Cassette	Cassette screw	Insert key	Insert screw	Wedge clamp radial adj.	Wedge screw
R220.96-8160	AU1114T-T15P	XN08PRN	FS96018	H4B-T15PL	C04011-T15P	CW0810	LD8020-T25P
R220.96-8200-8250	AU1114T-T15P	XN08PRN	FS96018	H4B-T15PL	C04011-T15P	CW0810	LD8020-T25P

Accessories

For cutter	Allen key	Arbor screw	Insert clamping torque	Torque key	Wedge key
R220.96-8160	H05-4	MC6S12X40	3.5NM	T00-15P35	H6B-T25PL
R220.96-8200-8250	H05-4	MC6S16X50	3.5NM	T00-15P35	H6B-T25PL

Torque and fixed keys, see page 894

R217/220.96-08 – Insert selection – mm/Inch

SMG		a _p	f _z		
			100%	30%	10%
P1	XNEX080608TR-ME09 F40M	3,5	0,13	0,14	0,22
		0.14	0.0050	0.0055	0.0085
P2	XNEX080608TR-ME09 F40M	3,5	0,13	0,14	0,22
		0.14	0.0050	0.0055	0.0085
P3	XNEX080608TR-M13 MP2501	3,5	0,18	0,20	0,30
		0.14	0.0070	0.0080	0.012
P4	XNEX080608TR-M13 MP2501	3,5	0,18	0,19	0,30
		0.14	0.0070	0.0075	0.012
P5	XNEX080608TR-M13 MP2501	3,5	0,17	0,19	0,28
		0.14	0.0065	0.0075	0.011
P6	XNEX080608TR-M13 MP2501	3,5	0,17	0,19	0,28
		0.14	0.0065	0.0075	0.011
P7	XNEX080608TR-M13 MP2501	3,5	0,17	0,19	0,28
		0.14	0.0065	0.0075	0.011
P8	XNEX080608TR-M13 MP2501	3,5	0,18	0,20	0,30
		0.14	0.0070	0.0080	0.012
P11	XNEX080608TR-M13 T350M	3,5	0,17	0,19	0,28
		0.14	0.0065	0.0075	0.011
P12	XNEX080608TR-M13 MP2501	3,0	0,12	0,13	0,19
		0.12	0.0048	0.0050	0.0075
M1	XNEX080608R-M08 F40M	3,5	0,12	0,13	0,19
		0.14	0.0048	0.0050	0.0075
M2	XNEX080608R-M08 F40M	3,5	0,11	0,12	0,18
		0.14	0.0044	0.0048	0.0070
M3	XNEX080608R-M08 F40M	3,0	0,085	0,095	0,14
		0.12	0.0034	0.0038	0.0055
M4	XNEX080608R-M08 T350M	2,0	0,080	0,085	0,12
		0.080	0.0032	0.0034	0.0048
M5	XNEX080608R-M08 T350M	2,0	0,080	0,085	0,12
		0.080	0.0032	0.0034	0.0048
K1	XNEX080608TR-M13 MK2050	3,5	0,19	0,20	0,32
		0.14	0.0075	0.0080	0.013
K2	XNEX080608TR-M13 MK2050	3,5	0,17	0,19	0,28
		0.14	0.0065	0.0075	0.011
K3	XNEX080608TR-M13 MK2050	3,5	0,17	0,19	0,28
		0.14	0.0065	0.0075	0.011
K4	XNEX080608TR-M13 MK2050	3,5	0,17	0,19	0,28
		0.14	0.0065	0.0075	0.011
K5	XNEX080608TR-M13 MK2050	3,5	0,16	0,17	0,26
		0.14	0.0065	0.0065	0.010
K6	XNEX080608TR-M13 MK2050	3,5	0,17	0,19	0,28
		0.14	0.0065	0.0075	0.011
K7	XNEX080608TR-M13 MK2050	3,5	0,16	0,17	0,26
		0.14	0.0065	0.0065	0.010
N1	XNEX080608R-M08 H25	3,5	0,15	0,16	0,25
		0.14	0.0060	0.0065	0.010
N2	XNEX080608R-M08 H25	3,5	0,15	0,16	0,25
		0.14	0.0060	0.0065	0.010
N3	XNEX080608R-M08 H25	3,5	0,15	0,16	0,25
		0.14	0.0060	0.0065	0.010
N11	XNEX080608R-M08 H25	3,5	0,15	0,16	0,25
		0.14	0.0060	0.0065	0.010
S1	XNEX080608R-M08 T350M	2,0	0,080	0,085	0,12
		0.080	0.0032	0.0034	0.0048
S2	XNEX080608R-M08 T350M	2,0	0,080	0,085	0,12
		0.080	0.0032	0.0034	0.0048
S3	XNEX080608R-M08 T350M	2,0	0,075	0,075	0,11
		0.080	0.0030	0.0030	0.0044
S11	XNEX080608R-M08 MS2050	2,5	0,085	0,095	0,14
		0.10	0.0034	0.0038	0.0055
S12	XNEX080608R-M08 MS2050	2,5	0,085	0,095	0,14
		0.10	0.0034	0.0038	0.0055
S13	XNEX080608R-M08 MS2050	2,0	0,080	0,085	0,12
		0.080	0.0032	0.0034	0.0048
H5	XNEX080608TR-MD15 MP3000	3,0	0,14	0,15	0,22
		0.12	0.0055	0.0060	0.0085
H8	XNEX080608TR-MD15 MP3000	2,5	0,11	0,11	0,17
		0.10	0.0044	0.0044	0.0065
H11	XNEX080608TR-MD15 MP1501	3,0	0,14	0,15	0,22
		0.12	0.0055	0.0060	0.0085
H12	XNEX080608TR-M13 MP1501	2,5	0,090	0,10	0,15
		0.10	0.0036	0.0040	0.0060

SMG = Seco material group
f_z = mm/tooth (in/tooth), v_c = m/min (sf/min), a_e/DC = %
All cutting data are start values

Square shoulder and slot milling cutters
Helical milling cutters
Face milling cutters
Disc milling cutters
High feed milling cutters
Copy milling cutters
Plunge milling cutters
Chamfer milling cutters
Spot facing cutters
Inserts

R217/220.96-08 – Cutting data $v_c = (m/min)/(sf/min)$

SMG	MP1501			MP2050			MP2501			MP3000			MM4500			MK1500		
	100%	30%	10%	100%	30%	10%	100%	30%	10%	100%	30%	10%	100%	30%	10%	100%	30%	10%
P1	345	455	530	300	395	475	305	405	475	290	385	450	185	250	290	—	—	—
	1125	1500	1750	980	1300	1550	1000	1325	1550	950	1275	1475	610	820	950	—	—	—
P2	335	445	520	290	385	460	295	395	460	280	375	435	180	240	285	—	—	—
	1100	1450	1700	950	1275	1500	970	1300	1500	920	1225	1425	590	790	940	—	—	—
P3	295	380	460	255	340	400	260	340	405	245	320	385	160	210	250	—	—	—
	970	1250	1500	840	1125	1300	850	1125	1325	800	1050	1275	520	690	820	—	—	—
P4	260	345	405	225	300	355	230	305	360	220	290	340	140	185	220	—	—	—
	850	1125	1325	740	980	1175	750	1000	1175	720	950	1125	460	610	720	—	—	—
P5	250	330	385	215	285	340	220	290	340	210	275	325	135	180	210	—	—	—
	820	1075	1275	710	940	1125	720	950	1125	690	900	1075	445	590	690	—	—	—
P6	280	370	435	245	325	385	245	325	385	235	310	365	150	200	235	—	—	—
	920	1225	1425	800	1075	1275	800	1075	1275	770	1025	1200	490	660	770	—	—	—
P7	265	345	410	230	310	365	235	310	360	220	290	345	145	190	220	—	—	—
	870	1125	1350	750	1025	1200	770	1025	1175	720	950	1125	475	620	720	—	—	—
P8	250	320	385	215	285	340	220	285	340	210	270	325	135	175	210	—	—	—
	820	1050	1275	710	940	1125	720	940	1125	690	890	1075	445	570	690	—	—	—
P11	255	340	395	220	300	355	225	300	350	215	285	335	140	185	215	—	—	—
	840	1125	1300	720	980	1175	740	980	1150	710	940	1100	460	610	710	—	—	—
P12	170	220	260	145	190	225	150	195	230	140	185	220	90	120	140	—	—	—
	560	720	850	475	620	740	490	640	750	460	610	720	295	395	460	—	—	—
M1	—	—	—	210	275	330	215	285	330	210	280	325	155	205	245	—	—	—
	—	—	—	690	900	1075	710	940	1075	690	920	1075	510	670	800	—	—	—
M2	—	—	—	175	230	270	175	235	275	175	230	270	130	170	200	—	—	—
	—	—	—	570	750	890	570	770	900	570	750	890	425	560	660	—	—	—
M3	—	—	—	140	185	220	145	190	220	140	190	220	105	140	160	—	—	—
	—	—	—	460	610	720	475	620	720	460	620	720	345	460	520	—	—	—
M4	—	—	—	110	145	170	110	145	170	110	145	170	80	105	125	—	—	—
	—	—	—	360	475	560	360	475	560	360	475	560	260	345	410	—	—	—
M5	—	—	—	90	120	140	90	120	145	90	120	140	70	90	105	—	—	—
	—	—	—	295	395	460	295	395	475	295	395	460	230	295	345	—	—	—
K1	265	350	410	230	305	365	235	310	365	—	—	—	—	—	—	290	385	450
	870	1150	1350	750	1000	1200	770	1025	1200	—	—	—	—	—	—	950	1275	1475
K2	235	310	365	205	270	320	210	275	325	—	—	—	—	—	—	260	340	405
	770	1025	1200	670	890	1050	690	900	1075	—	—	—	—	—	—	850	1125	1325
K3	200	265	310	175	230	270	175	235	275	—	—	—	—	—	—	220	285	345
	660	870	1025	570	750	890	570	770	900	—	—	—	—	—	—	720	940	1125
K4	190	250	295	165	220	260	170	225	260	—	—	—	—	—	—	210	275	325
	620	820	970	540	720	850	560	740	850	—	—	—	—	—	—	690	900	1075
K5	115	155	180	100	135	160	105	135	160	—	—	—	—	—	—	125	170	200
	375	510	590	330	445	520	345	445	520	—	—	—	—	—	—	410	560	660
K6	165	220	260	145	195	230	150	195	230	—	—	—	—	—	—	185	240	290
	540	720	850	475	640	750	490	640	750	—	—	—	—	—	—	610	790	950
K7	150	195	230	130	175	205	130	175	205	—	—	—	—	—	—	160	215	255
	490	640	750	425	570	670	425	570	670	—	—	—	—	—	—	520	710	840
N1	—	—	—	—	—	—	—	—	—	—	—	—	—	—	—	—	—	—
	—	—	—	—	—	—	—	—	—	—	—	—	—	—	—	—	—	—
N2	—	—	—	—	—	—	—	—	—	—	—	—	—	—	—	—	—	—
	—	—	—	—	—	—	—	—	—	—	—	—	—	—	—	—	—	—
N3	—	—	—	—	—	—	—	—	—	—	—	—	—	—	—	—	—	—
	—	—	—	—	—	—	—	—	—	—	—	—	—	—	—	—	—	—
N11	—	—	—	—	—	—	—	—	—	—	—	—	—	—	—	—	—	—
	—	—	—	—	—	—	—	—	—	—	—	—	—	—	—	—	—	—
S1	—	—	—	55	70	85	—	—	—	50	65	80	25	33	38	—	—	—
	—	—	—	180	230	280	—	—	—	165	215	260	80	110	125	—	—	—
S2	—	—	—	43	55	65	—	—	—	41	55	65	20	26	31	—	—	—
	—	—	—	140	180	215	—	—	—	135	180	215	65	85	100	—	—	—
S3	—	—	—	38	50	60	—	—	—	36	48	55	18	23	27	—	—	—
	—	—	—	125	165	195	—	—	—	120	155	180	60	75	90	—	—	—
S11	—	—	—	75	100	115	—	—	—	70	95	110	35	45	55	—	—	—
	—	—	—	245	330	375	—	—	—	230	310	360	115	150	180	—	—	—
S12	—	—	—	50	70	80	—	—	—	49	65	75	32	42	50	—	—	—
	—	—	—	165	230	260	—	—	—	160	215	245	105	140	165	—	—	—
S13	—	—	—	30	39	47	—	—	—	29	38	44	19	25	29	—	—	—
	—	—	—	100	130	155	—	—	—	95	125	145	60	80	95	—	—	—
H5	55	75	85	43	55	70	—	—	—	44	55	70	—	—	—	—	—	—
	180	245	280	140	180	230	—	—	—	145	180	230	—	—	—	—	—	—
H8	60	75	90	47	60	70	—	—	—	—	—	—	—	—	—	—	—	—
	195	245	295	155	195	230	—	—	—	—	—	—	—	—	—	—	—	—
H11	70	90	110	55	75	85	—	—	—	—	—	—	—	—	—	—	—	—
	230	295	360	180	245	280	—	—	—	—	—	—	—	—	—	—	—	—
H12	105	140	165	95	120	140	—	—	—	—	—	—	—	—	—	—	—	—
	345	460	540	310	395	460	—	—	—	—	—	—	—	—	—	—	—	—

R217/220.96-08 – Cutting data $v_c = (m/min)/(sf/min)$

SMG	MK2050			MS2050			MS2500			T350M			F40M			H25		
	100%	30%	10%	100%	30%	10%	100%	30%	10%	100%	30%	10%	100%	30%	10%	100%	30%	10%
P1	260	350	415	255	335	400	335	440	530	265	350	415	230	305	360	—	—	—
	850	1150	1350	840	1100	1300	1100	1450	1750	870	1150	1350	750	1000	1175	—	—	—
P2	255	340	395	250	330	390	325	430	510	260	345	400	225	300	350	—	—	—
	840	1125	1300	820	1075	1275	1075	1400	1675	850	1125	1300	740	980	1150	—	—	—
P3	220	290	345	220	290	340	285	375	445	230	295	355	200	255	310	—	—	—
	720	950	1125	720	950	1125	940	1225	1450	750	970	1175	660	840	1025	—	—	—
P4	195	260	305	190	255	300	250	330	395	200	265	310	175	230	270	—	—	—
	640	850	1000	620	840	980	820	1075	1300	660	870	1025	570	750	890	—	—	—
P5	190	250	295	185	240	285	240	315	375	190	255	300	165	220	260	—	—	—
	620	820	970	610	790	940	790	1025	1225	620	840	980	540	720	850	—	—	—
P6	210	280	335	205	280	325	270	365	425	215	285	335	185	245	290	—	—	—
	690	920	1100	670	920	1075	890	1200	1400	710	940	1100	610	800	950	—	—	—
P7	200	265	315	195	260	310	255	345	405	205	270	315	175	235	275	—	—	—
	660	870	1025	640	850	1025	840	1125	1325	670	890	1025	570	770	900	—	—	—
P8	185	245	290	185	240	285	240	315	375	190	250	300	165	215	260	—	—	—
	610	800	950	610	790	940	790	1025	1225	620	820	980	540	710	850	—	—	—
P11	195	255	305	190	255	300	245	335	390	195	260	305	170	225	265	—	—	—
	640	840	1000	620	840	980	800	1100	1275	640	850	1000	560	740	870	—	—	—
P12	125	170	200	125	160	190	160	215	250	130	170	200	110	145	175	—	—	—
	410	560	660	410	520	620	520	710	820	425	560	660	360	475	570	—	—	—
M1	—	—	—	200	265	315	230	305	365	200	265	310	180	240	280	—	—	—
	—	—	—	660	870	1025	750	1000	1200	660	870	1025	590	790	920	—	—	—
M2	—	—	—	165	220	260	190	255	300	165	220	255	150	200	235	—	—	—
	—	—	—	540	720	850	620	840	980	540	720	840	490	660	770	—	—	—
M3	—	—	—	135	175	210	155	205	245	135	180	205	120	160	190	—	—	—
	—	—	—	445	570	690	510	670	800	445	590	670	395	520	620	—	—	—
M4	—	—	—	105	140	160	120	160	190	105	135	160	95	125	145	—	—	—
	—	—	—	345	460	520	395	520	620	345	445	520	310	410	475	—	—	—
M5	—	—	—	85	115	135	100	135	155	85	115	135	80	105	120	—	—	—
	—	—	—	280	375	445	330	445	510	280	375	445	260	345	395	—	—	—
K1	275	365	425	—	—	—	—	—	—	—	—	—	180	235	275	—	—	—
	900	1200	1400	—	—	—	—	—	—	—	—	—	590	770	900	—	—	—
K2	245	320	385	—	—	—	—	—	—	—	—	—	160	210	245	—	—	—
	800	1050	1275	—	—	—	—	—	—	—	—	—	520	690	800	—	—	—
K3	205	270	325	—	—	—	—	—	—	—	—	—	135	175	210	—	—	—
	670	890	1075	—	—	—	—	—	—	—	—	—	445	570	690	—	—	—
K4	195	260	310	—	—	—	—	—	—	—	—	—	130	170	200	—	—	—
	640	850	1025	—	—	—	—	—	—	—	—	—	425	560	660	—	—	—
K5	120	160	190	—	—	—	—	—	—	—	—	—	80	105	120	—	—	—
	395	520	620	—	—	—	—	—	—	—	—	—	260	345	395	—	—	—
K6	175	230	275	—	—	—	—	—	—	—	—	—	110	150	175	—	—	—
	570	750	900	—	—	—	—	—	—	—	—	—	360	490	570	—	—	—
K7	155	205	240	—	—	—	—	—	—	—	—	—	100	130	155	—	—	—
	510	670	790	—	—	—	—	—	—	—	—	—	330	425	510	—	—	—
N1	—	—	—	—	—	—	—	—	—	—	—	—	1300	1750	2050	1250	1675	1975
	—	—	—	—	—	—	—	—	—	—	—	—	4275	5750	6725	4100	5500	6475
N2	—	—	—	—	—	—	—	—	—	—	—	—	530	700	830	510	680	790
	—	—	—	—	—	—	—	—	—	—	—	—	1750	2300	2725	1675	2225	2600
N3	—	—	—	—	—	—	—	—	—	—	—	—	350	470	550	340	450	530
	—	—	—	—	—	—	—	—	—	—	—	—	1150	1550	1800	1125	1475	1750
N11	—	—	—	—	—	—	—	—	—	—	—	—	400	540	630	390	520	610
	—	—	—	—	—	—	—	—	—	—	—	—	1300	1775	2075	1275	1700	2000
S1	—	—	—	49	65	75	60	80	90	48	65	75	44	60	70	—	—	—
	—	—	—	160	215	245	195	260	295	155	215	245	145	195	230	—	—	—
S2	—	—	—	39	50	60	48	65	75	39	50	60	35	46	55	—	—	—
	—	—	—	130	165	195	155	215	245	130	165	195	115	150	180	—	—	—
S3	—	—	—	34	45	55	42	55	65	34	45	55	31	41	48	—	—	—
	—	—	—	110	150	180	140	180	215	110	150	180	100	135	155	—	—	—
S11	—	—	—	70	90	105	85	110	130	65	90	105	60	80	95	—	—	—
	—	—	—	230	295	345	280	360	425	215	295	345	195	260	310	—	—	—
S12	—	—	—	47	60	75	60	75	90	47	60	70	42	55	65	—	—	—
	—	—	—	155	195	245	195	245	295	155	195	230	140	180	215	—	—	—
S13	—	—	—	27	36	43	33	44	50	27	36	42	25	32	38	—	—	—
	—	—	—	90	120	140	110	145	165	90	120	140	80	105	125	—	—	—
H5	—	—	—	—	—	—	—	—	—	43	55	65	37	49	60	—	—	—
	—	—	—	—	—	—	—	—	—	140	180	215	120	160	195	—	—	—
H8	—	—	—	—	—	—	—	—	—	45	60	70	39	50	60	—	—	—
	—	—	—	—	—	—	—	—	—	150	195	230	130	165	195	—	—	—
H11	—	—	—	—	—	—	—	—	—	55	70	85	48	60	75	—	—	—
	—	—	—	—	—	—	—	—	—	180	230	280	155	195	245	—	—	—
H12	—	—	—	—	—	—	105	135	160	80	105	125	70	90	110	—	—	—
	—	—	—	—	—	—	345	445	520	260	345	410	230	295	360	—	—	—

Square shoulder and slot milling cutters
Helical milling cutters
Face milling cutters
Disc milling cutters
High feed milling cutters
Copy milling cutters
Plunge milling cutters
Chamfer milling cutters
Spot facing cutters
Inserts

Square shoulder and slot milling cutters

Helical milling cutters

Face milling cutters

Disc milling cutters

High feed milling cutters

Copy milling cutters

Plunge milling cutters

Chamfer milling cutters

Spot facing cutters

Inserts



MINI AND MIDI SQUARE

The Mini and Midi Square family includes universal cutters for slotting, contouring and face milling operations in ordinary steel, easier stainless steels and cast iron.

- Square inserts that provide four usable edges, available in 09 and 12 insert size
- A special design on the square inserts enables a 90-degree setting angle
- Fixed pockets and include normal and close pitch versions

R220.99-09/12 – Metric

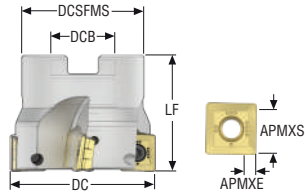

- For insert selection and cutting data recommendations, see page(s) 118-119
- For complete insert programme, see page(s) 858
- For ISO attribute explanation, see page 16
- KAPRS 90°

Designation	Item number	Type of mounting	DC	ZEPF	APMXS	APMXE	DCB	DCSFMS	LF	RPMX	Weight	Insert
			mm		mm	mm	mm	mm	mm		kg	
R220.99-0040-09-4T	75069190	Arbor	40,0	4	8,0	1,7	16,0	35,0	40,0	16600	0,2	SONX09
R220.99-0050-09-6T	00023549	Arbor	50,0	6	8,0	1,7	22,0	47,0	40,0	14800	0,3	SONX09
R220.99-0063-09-7T	00023550	Arbor	63,0	7	8,0	1,7	22,0	47,0	40,0	13200	0,5	SONX09
R220.99-0050-12-4	00005593	Arbor	50,0	4	11,0	2,4	22,0	42,0	40,0	10800	0,3	SONX12
R220.99-0050-12-5T	00005594	Arbor	50,0	5	11,0	2,4	22,0	42,0	40,0	10800	0,3	SONX12
R220.99-0063-12-6T	00005598	Arbor	63,0	6	11,0	2,4	22,0	47,0	40,0	9600	0,5	SONX12
R220.99-0080-12-6	00005602	Arbor	80,0	6	11,0	2,4	27,0	62,0	50,0	8400	1,1	SONX12
R220.99-0100-12-8	00005604	Arbor	100,0	8	11,0	2,4	32,0	77,0	50,0	7600	1,5	SONX12

Spare Parts, included in delivery

For cutter	Arbor screw	Insert key	Insert screw
R220.99-0040	MC6S8X30	H4B-T09P	C03006-T09P
R220.99-0050-0063-09	220.17-692	H4B-T09P	C03006-T09P
R220.99-0050-0063-12	220.17-692	H4B-T15P	C04011-T15P
R220.99-0080	MC6S12X40	H4B-T15P	C04011-T15P
R220.99-0100	-	H4B-T15PL	C04011-T15P

Accessories

For cutter	Insert clamping torque	Torque key
R220.99-0040-0063-09	2.0NM	T00-09P20
R220.99-0050-0100-12	3.5NM	T00-15P35

Torque and fixed keys, see page 894

R217/220.99-09 – Insert selection – mm/Inch

SMG		a_p	f_z		
			100%	30%	10%
P1	SONX09T308TR-M10 F40M	4,0	0,14	0,16	0,24
		0.16	0.0055	0.0065	0.0095
P2	SONX09T308TR-M10 F40M	4,0	0,15	0,16	0,24
		0.16	0.0060	0.0065	0.0095
P3	SONX09T308TR-M10 MP2501	4,0	0,14	0,15	0,22
		0.16	0.0055	0.0060	0.0085
P4	SONX09T308TR-M10 MP2501	4,0	0,14	0,15	0,22
		0.16	0.0055	0.0060	0.0085
P5	SONX09T308TR-M10 MP2501	4,0	0,13	0,14	0,22
		0.16	0.0050	0.0055	0.0085
P6	SONX09T308TR-M10 MP2501	4,0	0,13	0,14	0,22
		0.16	0.0050	0.0055	0.0085
P7	SONX09T308TR-M10 MP2501	4,0	0,13	0,14	0,22
		0.16	0.0050	0.0055	0.0085
P8	SONX09T308TR-M10 MP2501	4,0	0,14	0,15	0,22
		0.16	0.0055	0.0060	0.0085
P11	SONX09T304TR-M10 T350M	4,0	0,13	0,14	0,22
		0.16	0.0050	0.0055	0.0085
P12	SONX09T308TR-M10 MP2501	3,0	0,090	0,10	0,15
		0.12	0.0036	0.0040	0.0060
M1	SONX09T304TR-ME06 F40M	4,0	0,085	0,095	0,14
		0.16	0.0034	0.0038	0.0055
M2	SONX09T304TR-ME06 F40M	4,0	0,080	0,085	0,13
		0.16	0.0032	0.0034	0.0050
M3	SONX09T304TR-ME06 F40M	3,0	0,065	0,070	0,10
		0.12	0.0026	0.0028	0.0040
M4	SONX09T304TR-M10 F40M	2,5	0,090	0,10	0,15
		0.10	0.0036	0.0040	0.0060
M5	SONX09T304TR-M10 F40M	2,5	0,090	0,10	0,15
		0.10	0.0036	0.0040	0.0060
K1	SONX09T308TR-M10 MK2050	4,0	0,15	0,16	0,24
		0.16	0.0060	0.0065	0.0095
K2	SONX09T308TR-M10 MK2050	4,0	0,13	0,14	0,22
		0.16	0.0050	0.0055	0.0085
K3	SONX09T308TR-M10 MK2050	4,0	0,13	0,14	0,22
		0.16	0.0050	0.0055	0.0085
K4	SONX09T308TR-M10 MK2050	4,0	0,13	0,14	0,22
		0.16	0.0050	0.0055	0.0085
K5	SONX09T308TR-M10 MK2050	4,0	0,12	0,13	0,20
		0.16	0.0048	0.0050	0.0080
K6	SONX09T308TR-M10 MK2050	4,0	0,13	0,14	0,22
		0.16	0.0050	0.0055	0.0085
K7	SONX09T308TR-M10 MK2050	4,0	0,12	0,13	0,20
		0.16	0.0048	0.0050	0.0080
N1	SONX09T304TR-ME06 F40M	4,0	0,11	0,12	0,18
		0.16	0.0044	0.0048	0.0070
N2	SONX09T304TR-ME06 F40M	4,0	0,11	0,12	0,18
		0.16	0.0044	0.0048	0.0070
N3	SONX09T304TR-ME06 F40M	4,0	0,11	0,12	0,18
		0.16	0.0044	0.0048	0.0070
N11	SONX09T304TR-ME06 F40M	4,0	0,11	0,12	0,18
		0.16	0.0044	0.0048	0.0070
S1	SONX09T304TR-M10 T350M	2,5	0,090	0,10	0,15
		0.10	0.0036	0.0040	0.0060
S2	SONX09T304TR-M10 T350M	2,5	0,090	0,10	0,15
		0.10	0.0036	0.0040	0.0060
S3	SONX09T304TR-M10 T350M	2,5	0,085	0,095	0,14
		0.10	0.0034	0.0038	0.0055
S11	SONX09T304TR-M10 T350M	2,5	0,11	0,11	0,17
		0.10	0.0044	0.0044	0.0065
S12	SONX09T304TR-ME06 F40M	2,5	0,065	0,070	0,10
		0.10	0.0026	0.0028	0.0040

SMG = Seco material group
 f_z = mm/tooth (in/tooth), v_c = m/min (sf/min), a_p/DC = %
 All cutting data are start values

R217/220.99-09 – Cutting data $v_c = (m/min)/(sf/min)$

SMG	MP2501			MK1500			MK2050			T350M			F40M		
	100%	30%	10%	100%	30%	10%	100%	30%	10%	100%	30%	10%	100%	30%	10%
P1	290	380	450	—	—	—	290	375	445	250	330	385	220	290	340
	950	1250	1475	—	—	—	950	1225	1450	820	1075	1275	720	950	1125
P2	280	370	435	—	—	—	275	365	430	240	315	375	210	280	330
	920	1225	1425	—	—	—	900	1200	1400	790	1025	1225	690	920	1075
P3	245	325	385	—	—	—	240	320	380	210	275	330	185	245	290
	800	1075	1275	—	—	—	790	1050	1250	690	900	1075	610	800	950
P4	215	285	340	—	—	—	210	280	335	185	245	290	165	215	255
	710	940	1125	—	—	—	690	920	1100	610	800	950	540	710	840
P5	210	280	325	—	—	—	205	275	320	180	240	280	160	210	245
	690	920	1075	—	—	—	670	900	1050	590	790	920	520	690	800
P6	235	310	365	—	—	—	230	310	360	200	265	310	180	235	275
	770	1025	1200	—	—	—	750	1025	1175	660	870	1025	590	770	900
P7	225	295	345	—	—	—	220	290	340	190	250	295	170	225	260
	740	970	1125	—	—	—	720	950	1125	620	820	970	560	740	850
P8	205	275	325	—	—	—	205	270	320	175	235	280	155	205	245
	670	900	1075	—	—	—	670	890	1050	570	770	920	510	670	800
P11	215	285	335	—	—	—	215	280	330	185	245	285	165	215	255
	710	940	1100	—	—	—	710	920	1075	610	800	940	540	710	840
P12	145	185	215	—	—	—	140	180	215	120	160	185	110	140	165
	475	610	710	—	—	—	460	590	710	395	520	610	360	460	540
M1	200	265	315	—	—	—	—	—	—	185	245	290	170	225	265
	660	870	1025	—	—	—	—	—	—	610	800	950	560	740	870
M2	170	225	260	—	—	—	—	—	—	155	205	240	145	190	220
	560	740	850	—	—	—	—	—	—	510	670	790	475	620	720
M3	135	180	210	—	—	—	—	—	—	125	165	195	115	150	175
	445	590	690	—	—	—	—	—	—	410	540	640	375	490	570
M4	110	140	165	—	—	—	—	—	—	100	130	150	90	120	140
	360	460	540	—	—	—	—	—	—	330	425	490	295	395	460
M5	90	120	135	—	—	—	—	—	—	80	105	125	75	100	115
	295	395	445	—	—	—	—	—	—	260	345	410	245	330	375
K1	220	295	345	315	415	490	295	395	465	190	250	295	165	220	265
	720	970	1125	1025	1350	1600	970	1300	1525	620	820	970	540	720	870
K2	200	265	310	280	375	435	265	355	410	170	225	265	150	200	235
	660	870	1025	920	1225	1425	870	1175	1350	560	740	870	490	660	770
K3	170	225	260	240	315	370	225	300	350	145	190	225	130	170	195
	560	740	850	790	1025	1225	740	980	1150	475	620	740	425	560	640
K4	160	215	250	230	300	350	215	285	335	135	180	215	120	160	190
	520	710	820	750	980	1150	710	940	1100	445	590	710	395	520	620
K5	100	130	150	140	185	215	130	175	205	85	110	130	75	100	115
	330	425	490	460	610	710	425	570	670	280	360	425	245	330	375
K6	140	190	220	200	265	310	190	250	295	120	160	190	105	140	165
	460	620	720	660	870	1025	620	820	970	395	520	620	345	460	540
K7	125	165	195	180	235	275	170	220	260	105	140	165	95	125	145
	410	540	640	590	770	900	560	720	850	345	460	540	310	410	475
N1	—	—	—	—	—	—	—	—	—	—	—	—	1225	1650	1950
	—	—	—	—	—	—	—	—	—	—	—	—	4025	5425	6400
N2	—	—	—	—	—	—	—	—	—	—	—	—	500	670	790
	—	—	—	—	—	—	—	—	—	—	—	—	1650	2200	2600
N3	—	—	—	—	—	—	—	—	—	—	—	—	330	445	520
	—	—	—	—	—	—	—	—	—	—	—	—	1075	1450	1700
N11	—	—	—	—	—	—	—	—	—	—	—	—	380	510	600
	—	—	—	—	—	—	—	—	—	—	—	—	1250	1675	1975
S1	50	70	80	—	—	—	—	—	—	46	60	70	43	55	65
	165	230	260	—	—	—	—	—	—	150	195	230	140	180	215
S2	42	55	65	—	—	—	—	—	—	37	48	55	34	45	55
	140	180	215	—	—	—	—	—	—	120	155	180	110	150	180
S3	37	49	55	—	—	—	—	—	—	32	42	50	30	39	46
	120	160	180	—	—	—	—	—	—	105	140	165	100	130	150
S11	75	95	110	—	—	—	—	—	—	65	85	100	60	75	90
	245	310	360	—	—	—	—	—	—	215	280	330	195	245	295
S12	50	65	75	—	—	—	—	—	—	44	60	70	41	55	60
	165	215	245	—	—	—	—	—	—	145	195	230	135	180	195

Square shoulder and slot milling cutters
Helical milling cutters
Face milling cutters
Disc milling cutters
High feed milling cutters
Copy milling cutters
Plunge milling cutters
Chamfer milling cutters
Spot facing cutters
Inserts

R217/220.99-12 – Insert selection – mm/Inch

SMG		a_p	f_z		
			100%	30%	10%
P1	SONX120508TR-ME08 F40M	5,0	0,11	0,12	0,19
		0.20	0.0044	0.0048	0.0075
P2	SONX120508TR-ME08 F40M	5,0	0,12	0,13	0,19
		0.20	0.0048	0.0050	0.0075
P3	SONX120508TR-M12 MP2501	5,0	0,16	0,18	0,28
		0.20	0.0065	0.0070	0.011
P4	SONX120508TR-M12 MP2501	5,0	0,16	0,18	0,26
		0.20	0.0065	0.0070	0.010
P5	SONX120508TR-M12 MP2501	5,0	0,16	0,17	0,26
		0.20	0.0065	0.0065	0.010
P6	SONX120508TR-M12 MP2501	5,0	0,16	0,17	0,26
		0.20	0.0065	0.0065	0.010
P7	SONX120508TR-M12 MP2501	5,0	0,16	0,17	0,26
		0.20	0.0065	0.0065	0.010
P8	SONX120508TR-M12 MP2501	5,0	0,16	0,18	0,28
		0.20	0.0065	0.0070	0.011
P11	SONX120508TR-M12 T350M	5,0	0,16	0,17	0,26
		0.20	0.0065	0.0065	0.010
P12	SONX120508TR-M12 T350M	4,5	0,11	0,12	0,18
		0.18	0.0044	0.0048	0.0070
M1	SONX120508TR-ME08 F40M	5,0	0,12	0,13	0,19
		0.20	0.0048	0.0050	0.0075
M2	SONX120508TR-ME08 F40M	5,0	0,11	0,11	0,17
		0.20	0.0044	0.0044	0.0065
M3	SONX120508TR-M12 F40M	4,5	0,13	0,14	0,20
		0.18	0.0050	0.0055	0.0080
M4	SONX120508TR-M12 F40M	3,0	0,11	0,12	0,18
		0.12	0.0044	0.0048	0.0070
M5	SONX120508TR-M12 F40M	3,0	0,11	0,12	0,18
		0.12	0.0044	0.0048	0.0070
K1	SONX120508TR-M12 MK2050	5,0	0,17	0,19	0,28
		0.20	0.0065	0.0075	0.011
K2	SONX120508TR-M12 MK2050	5,0	0,16	0,17	0,26
		0.20	0.0065	0.0065	0.010
K3	SONX120508TR-M12 MK2050	5,0	0,16	0,17	0,26
		0.20	0.0065	0.0065	0.010
K4	SONX120508TR-M12 MK2050	5,0	0,16	0,17	0,26
		0.20	0.0065	0.0065	0.010
K5	SONX120508TR-M12 MK2050	5,0	0,14	0,15	0,24
		0.20	0.0055	0.0060	0.0095
K6	SONX120508TR-M12 MK2050	5,0	0,16	0,17	0,26
		0.20	0.0065	0.0065	0.010
K7	SONX120508TR-M12 MK2050	5,0	0,14	0,15	0,24
		0.20	0.0055	0.0060	0.0095
N1	SONX120508TR-ME08 F40M	5,0	0,15	0,16	0,25
		0.20	0.0060	0.0065	0.010
N2	SONX120508TR-ME08 F40M	5,0	0,15	0,16	0,25
		0.20	0.0060	0.0065	0.010
N3	SONX120508TR-ME08 F40M	5,0	0,15	0,16	0,25
		0.20	0.0060	0.0065	0.010
N11	SONX120508TR-ME08 F40M	5,0	0,15	0,16	0,25
		0.20	0.0060	0.0065	0.010
S1	SONX120508TR-M12 T350M	3,0	0,11	0,12	0,18
		0.12	0.0044	0.0048	0.0070
S2	SONX120508TR-M12 T350M	3,0	0,11	0,12	0,18
		0.12	0.0044	0.0048	0.0070
S3	SONX120508TR-M12 T350M	3,0	0,10	0,11	0,17
		0.12	0.0040	0.0044	0.0065
S11	SONX120508TR-M12 T350M	4,0	0,13	0,14	0,20
		0.16	0.0050	0.0055	0.0080
S12	SONX120508TR-ME08 F40M	4,0	0,085	0,090	0,14
		0.16	0.0034	0.0036	0.0055

SMG = Seco material group
 f_z = mm/tooth (in/tooth), v_c = m/min (sf/min), a_p/DC = %
 All cutting data are start values

R217/220.99-12 – Cutting data $v_c = (m/min)/(sf/min)$

SMG	MP1501			MP2501			MK1500			MK2050			T350M			F40M		
	100%	30%	10%	100%	30%	10%	100%	30%	10%	100%	30%	10%	100%	30%	10%	100%	30%	10%
P1	315	415	490	280	365	435	—	—	—	275	360	430	245	320	380	210	275	330
	1025	1350	1600	920	1200	1425	—	—	—	900	1175	1400	800	1050	1250	690	900	1075
P2	305	400	480	270	355	425	—	—	—	265	350	415	235	310	370	205	270	320
	1000	1300	1575	890	1175	1400	—	—	—	870	1150	1350	770	1025	1225	670	890	1050
P3	270	350	410	240	310	365	—	—	—	235	305	360	205	270	320	180	235	275
	890	1150	1350	790	1025	1200	—	—	—	770	1000	1175	670	890	1050	590	770	900
P4	235	310	370	210	275	330	—	—	—	205	270	325	180	240	285	160	210	250
	770	1025	1225	690	900	1075	—	—	—	670	890	1075	590	790	940	520	690	820
P5	225	300	355	200	265	315	—	—	—	195	260	310	175	230	275	150	200	235
	740	980	1175	660	870	1025	—	—	—	640	850	1025	570	750	900	490	660	770
P6	255	335	395	225	300	350	—	—	—	220	295	345	195	260	305	170	225	265
	840	1100	1300	740	980	1150	—	—	—	720	970	1125	640	850	1000	560	740	870
P7	240	320	375	210	280	330	—	—	—	210	280	325	185	245	290	160	215	250
	790	1050	1225	690	920	1075	—	—	—	690	920	1075	610	800	950	520	710	820
P8	225	295	345	200	260	305	—	—	—	195	260	300	175	230	265	150	200	230
	740	970	1125	660	850	1000	—	—	—	640	850	980	570	750	870	490	660	750
P11	230	310	365	205	275	320	—	—	—	205	270	315	180	240	280	155	205	245
	750	1025	1200	670	900	1050	—	—	—	670	890	1025	590	790	920	510	670	800
P12	155	200	235	135	180	210	—	—	—	135	175	205	120	155	185	105	135	160
	510	660	770	445	590	690	—	—	—	445	570	670	395	510	610	345	445	520
M1	—	—	—	195	255	305	—	—	—	—	—	—	180	240	285	165	215	260
	—	—	—	640	840	1000	—	—	—	—	—	—	590	790	940	540	710	850
M2	—	—	—	160	215	250	—	—	—	—	—	—	150	200	235	135	180	215
	—	—	—	520	710	820	—	—	—	—	—	—	490	660	770	445	590	710
M3	—	—	—	130	175	205	—	—	—	—	—	—	120	160	190	110	145	175
	—	—	—	425	570	670	—	—	—	—	—	—	395	520	620	360	475	570
M4	—	—	—	105	135	160	—	—	—	—	—	—	100	125	150	90	115	135
	—	—	—	345	445	520	—	—	—	—	—	—	330	410	490	295	375	445
M5	—	—	—	85	115	135	—	—	—	—	—	—	80	105	125	75	95	115
	—	—	—	280	375	445	—	—	—	—	—	—	260	345	410	245	310	375
K1	245	320	380	215	280	335	305	400	475	290	380	450	185	245	295	165	215	255
	800	1050	1250	710	920	1100	1000	1300	1550	950	1250	1475	610	800	970	540	710	840
K2	215	285	335	190	250	295	270	360	420	255	340	400	165	220	260	145	190	225
	710	940	1100	620	820	970	890	1175	1375	840	1125	1300	540	720	850	475	620	740
K3	180	240	285	160	215	250	225	305	355	215	285	335	140	185	220	120	160	190
	590	790	940	520	710	820	740	1000	1175	710	940	1100	460	610	720	395	520	620
K4	175	230	270	155	205	240	215	290	340	205	275	320	135	180	210	115	155	180
	570	750	890	510	670	790	710	950	1125	670	900	1050	445	590	690	375	510	590
K5	105	140	165	95	125	145	135	180	205	125	170	195	85	110	125	70	95	110
	345	460	540	310	410	475	445	590	670	410	560	640	280	360	410	230	310	360
K6	150	205	240	135	180	210	190	255	300	180	240	285	120	155	185	100	135	160
	490	670	790	445	590	690	620	840	980	590	790	940	395	510	610	330	445	520
K7	135	180	210	120	160	185	170	230	265	165	215	250	105	140	165	90	120	140
	445	590	690	395	520	610	560	750	870	540	710	820	345	460	540	295	395	460
N1	—	—	—	—	—	—	—	—	—	—	—	—	—	—	—	1200	1575	1875
	—	—	—	—	—	—	—	—	—	—	—	—	—	—	—	3925	5175	6150
N2	—	—	—	—	—	—	—	—	—	—	—	—	—	—	—	480	640	750
	—	—	—	—	—	—	—	—	—	—	—	—	—	—	—	1575	2100	2450
N3	—	—	—	—	—	—	—	—	—	—	—	—	—	—	—	320	425	500
	—	—	—	—	—	—	—	—	—	—	—	—	—	—	—	1050	1400	1650
N11	—	—	—	—	—	—	—	—	—	—	—	—	—	—	—	365	485	570
	—	—	—	—	—	—	—	—	—	—	—	—	—	—	—	1200	1600	1875
S1	—	—	—	50	65	80	—	—	—	—	—	—	46	60	70	41	55	65
	—	—	—	165	215	260	—	—	—	—	—	—	150	195	230	135	180	215
S2	—	—	—	41	55	60	—	—	—	—	—	—	37	48	55	33	43	50
	—	—	—	135	180	195	—	—	—	—	—	—	120	155	180	110	140	165
S3	—	—	—	36	47	55	—	—	—	—	—	—	32	42	49	29	38	44
	—	—	—	120	155	180	—	—	—	—	—	—	105	140	160	95	125	145
S11	—	—	—	70	90	110	—	—	—	—	—	—	60	80	95	55	75	90
	—	—	—	230	295	360	—	—	—	—	—	—	195	260	310	180	245	295
S12	—	—	—	48	65	75	—	—	—	—	—	—	43	55	65	39	50	60
	—	—	—	155	215	245	—	—	—	—	—	—	140	180	215	130	165	195

Square shoulder and slot milling cutters
Helical milling cutters
Face milling cutters
Disc milling cutters
High feed milling cutters
Copy milling cutters
Plunge milling cutters
Chamfer milling cutters
Spot facing cutters
Inserts

Square shoulder and slot milling cutters

Helical milling cutters

Face milling cutters

Disc milling cutters

High feed milling cutters

Copy milling cutters

Plunge milling cutters

Chamfer milling cutters

Spot facing cutters

Inserts



Code keys metric and inch

R	217	69	25	32	3S	042	10	4	A
1	2	3	4	5	6	7	8	9	10

R	217	69	01.50	3	01.34	10	4	A
1	2	3	5	6	7	8	9	10

1.	2.	3.
Right hand rotation Cx = For Seco-Capto	215/217=With shank 220 = For Arbor 235 = Finishing	69 = Rectangular positive 2 cutting edges 94 = Tangential 4 cutting edges 59 = Square positive 4 cutting edges 15 = Finishing
4. (Not applicable for inch designation)	5.	6.
Shank diameter (except for Arbor type)	Cutter diameter	Shank type (except for Arbor type) 0 = Cylindrical 3 = Weldon 3S = Seco Weldon RE = Combimaster
7.	8.	9.
Max. axial cutting depth	Insert size xxS = short edge xxM = Medium edge xxL = Long edge xxH = Heavy duty	Effective No. of flutes (ZEFP)
10.		
A = With through coolant supply N = Coated S = Set H = Heavy Duty K = Full effective (for .59 only) R6 = Compatible with radius 6.3 mm (for .59 only)		

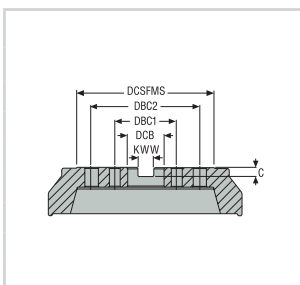

	Dimensions in mm					
	DCB	DCSFMS	DBC1	DBC2	KWW	C
16		30-35	-	-	8,4	5,6
22		42-47	-	-	10,4	6,3
27		48-62	-	-	12,4	7
32		60-90	-	-	14,4	8
40		90-130	66,7	-	16,4	9
60		130-270	101,6	177,8	25,7	14

	Dimensions in inch					
	DCB	DCSFMS	DBC1	DBC2	KWW	C
0.500		1.181 - 1.378			0.258	0.165
0.750		1.378 - 1.850			0.321	0.193
1.000		1.803 - 2.441			0.382	0.224
1.250		2.250 - 3.031			0.508	0.287
1.500		2.750 - 3.543			0.630	0.382
2.000		4.331			0.756	0.445
2.500		5.118 - 6.299 (8.858)	4.000	(7.000)	1.000	0.551

For a more exact DCSFMS and DCB measurement, see each product table.

Square shoulder and slot milling cutters

Helical milling cutters

Face milling cutters

Disc milling cutters

High feed milling cutters

Copy milling cutters

Plunge milling cutters

Chamfer milling cutters

Spot facing cutters

Inserts

Selection – Metric

Cutter	Insert	Material suitability					Corner radius (mm)					
		P	M	K	N	S						
Turbo	XO..06 	■	■	■	■	■	0,2/0,4/0,8/1,6	■	□	■	■	■
	XO..10 	■	■	■	■	■	0,2/0,4/0,8/1,2/1,6/2,0/2,4/3,1	■	■	■	■	■
	XO..12 	■	■	■	■	■	0,2/0,4/0,8/1,2/1,6/2,0/2,4/3,1/4,0/5,0/6,3	■	■	■	■	■
	XO..16 	■	■	■	■	■	0,4/0,8/1,2/1,6/2,0/2,4/3,1/4,0/5,0/6,3	■	■	■	■	■
	XO..18 	■	■	■	■	■	0,4/0,8/1,2/1,6/2,0/2,4/3,1/4,0/5,0/6,3	□	■	■	■	■
Helical T4	LO..08 	■	□	■	-	■	0,4/0,8/1,2/1,6	■	■	■	-	□
	LO..12 	■	■	■	■	■	0,4/0,8/1,2/1,6/2,0/2,4/3,1/4,0/5,0/6,3	■	■	■	-	□
R215/220.59 / R215/220.59K	AC15 SC12 	■	■	■	□	□	1,2/3,0/3,1/6,0	-	■	□	-	□
220.69-15	AC15 	■	■	■	□	□	1,2/3,0/3,1/6,0	-	■	□	-	□
Helical solution for side-finishing operation (small radial engagement)												
235.15		■	■	■	-	■	Chamfer	■	■	■	-	-



















1st choice	■
Alternative choice	■
Possible choice	□

High speed machine with low power/torque	
Strong stable machine with rigid connection	
Not recommended	

Unstable condition suitability	
Ramping ability	
Plunging ability	

Square shoulder and slot milling cutters
Helical milling cutters
Face milling cutters
Disc milling cutters
High feed milling cutters
Copy milling cutters
Plunge milling cutters
Chamfer milling cutters
Spot facing cutters
Inserts

Selection – Metric

Cutter	No. of cutting edges	Applica-tion	Cutter diameter (mm)/available depth of cut and number of teeth														See page	
			12	14	16	20	25	32	40	44	50	54	63	66	80	100		125
Turbo 06	2		10 (2)	15 (2)	20 (2)	20 (3) / 25 (3)												132
					15 (3)													
Turbo 10	2					25 (1)	25 (2)	25 (3)	34 (4)		42 (5)							137
						17 (2)	17 (3) / 25 (3) / 34 (3) / 42 (2)	34 (4) / 42 (4) / 50 (3)	34 (5) / 58 (4)	58 (5)	42 (6)							
Turbo 12	2						22 (2) / 33 (2)	33 (2)	33 (3) / 55 (3)	33 (3)		33 (4) / 44 (4) / 55 (4) / 66 (4)	44 (4)	33 (5) / 55 (5)	44 (5)			143
								22 (3) / 33 (3) / 44 (3) / 55 (3)	44 (4) / 65.5 (3)		44 (5) / 86 (5) / 106 (5)		77 (4) / 107 (5)		64 (6)			
Turbo 16	2							29 (2)	29 (3) / 43 (3)		57 (3)		43 (4)		71 (5)	71 (6)	153	
										71 (3)		43 (4) / 57 (4) / 85 (4) / 98 (4)		57 (5) / 85 (5)		71 (6)		
Turbo 18	2									47 (2)		47 (3) / 62 (3)	47 (3)	47 (4) / 62 (3)	47 (4)	47 (5) / 62 (5)	62 (6)	160
														62 (4) / 77 (4)		77 (4) / 93 (5)	77 (5)	
T4 08	4						29 (2) / 36 (2)	36 (3)	36 (3)		43 (4)							182
							43 (2)	43 (3) / 50 (3)	43 (4) / 50 (4)	57 (4)	57 (5)	64 (5)						
T4 12	4								35 (2)	35 (3)	35 (3) / 46 (3)		46 (4)					187
											58 (3)	46 (4) / 58 (4) / 81 (4)	69 (4)	58 (5) / 81 (4) / 92 (4)	81 (5)	69 (5) / 104 (5)	81 (6)	
215/220.59	2 & 4 half effective										50 (2) / 59 (2)		59 (2)		68 (2/3)	77 (3/4)	196, 197	
												77 (2) / 120 (2)		86 (2) / 120 (2) / 160 (2)		95 (2/3)	196, 197	
215/220.59K	2 & 4 full effective										63 (3) / 72 (3)		72 (4) / 110 (3)		72 (5)		196, 197	
220.69-15	2												38 (4)		38 (5) / 50 (5)	50 (6)	50 (7)	204
235.15	1							40 (2)				50 (3)			90 (3)		209	

x(y) Slotting and contouring operations : x indicates the maximum depth of cut (y indicates the number of teeth)

x(y) For contouring operations only : x indicates the maximum depth of cut (y indicates the number of teeth)

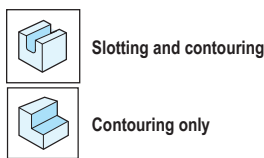

Square shoulder and slot milling cutters

Helical milling cutters

Face milling cutters

Disc milling cutters

High feed milling cutters

Copy milling cutters

Plunge milling cutters

Chamfer milling cutters

Spot facing cutters

Inserts

Selection – Inch

Cutter	Insert	Material suitability					Corner radius (inch)					
		P	M	K	N	S						
Turbo	XO..06 	■	■	■	■	■	.007/.016 .031/.063	■	□	■	■	■
	XO..10 	■	■	■	■	■	.007/.016/.031 .047/.063 .079/.094 .122	■	■	■	■	■
	XO..12 	■	■	■	■	■	.007/.016/.031 .047/.063 .079/.094 .122/.157 .197/.248	■	■	■	■	■
	XO..16 	■	■	■	■	■	.007/.016/.031 .047/.063 .079/.094 .122/.157 .197/.248	■	■	■	■	■
	XO..18 	■	■	■	■	■	.016/.031 .047/.063 .079/.094 .122/.157 .197/.248	□	■	■	■	■
Helical T4	LO..08 	■	□	■	-	■	.016/.031 .047/.063	■	■	■	-	□
	LO..12 	■	■	■	■	■	.016/.031 .047/.063 .079/.094 .122/.157 .197/.248	■	■	■	-	□
R215/220.59 / R215/220.59K	AC15 SC12 	■	■	■	□	□	.047/.122 .118/.236	-	■	□	-	□
220.69-15	AC15 	■	■	■	□	□	.047/.122 .118/.236	-	■	□	-	□
Helical solution for side-finishing operation (small radial engagement)												
235.15		■	■	■	-	■	Chamfer	■	■	■	-	-



















1st choice	■
Alternative choice	■
Possible choice	□

High speed machine with low power/torque	
Strong stable machine with rigid connection	
Not recommended	

Unstable condition suitability	
Ramping ability	
Plunging ability	

Square shoulder and slot milling cutters
Helical milling cutters
Face milling cutters
Disc milling cutters
High feed milling cutters
Copy milling cutters
Plunge milling cutters
Chamfer milling cutters
Spot facing cutters
Inserts

Selection – Inch

Cutter	No. of cutting edges	Applica-tion	Cutter diameter (inch)/available depth of cut and number of teeth							See page	
			0.750	1.00	1.25	1.50	2.00	2.50	3.00		4.00
Turbo 06	2		1.024 (3)								132
											
Turbo 10	2			1.024 (2)		1.378 (4)					137
				1.378 (3) / 1.693 (2)		1.339 (5)					
Turbo 12	2			0.870 (2) / 0.902 (2)	1.299 (2)	1.732 (3)	1.740 (4) / 2.591 (4)	2.953 (4)			143
					1.732 (3)	1.732 (4) / 2.165 (4) / 2.559 (3)	2.146 (5)				
Turbo 16	2					1.69 (3)	1.69 (3)	1.69 (4)	2.79 (5)		143
							1.69 (4) 2.24 (4) 3.89 (4)	2.24 (5) / 3.34 (5)			
Turbo 18	2					1.862 (2)	1.850 (3)	1.866 (4) / 2.409 (4) / 2.441 (4)	2.480 (5) / 3.024 (4)	3.024 (5)	160
							2.441 (3)	3.024 (4)			
Helical T4 08	4			1.417 (2)	1.417 (2)		1.693 (4)				182
				1.693 (2)		1.969 (4)					
Helical T4 12	4						1.406 (3) / 1.850 (3)				187
							2.283 (4) / 2.310 (4)	3.189 (4) / 3.211 (4)	3.189 (5) / 3.211 (5)		
215/220.59	2 & 4 half effective										196, 197
							3.031 (2)				
215/220.59K	2 & 4 full effective										196, 197
220.69-15	2						1.567 (3)				204
235.15	1						1.969 (3)		3.500 (3)		209

 x(y) Slotting and contouring operations : x indicates the maximum depth of cut (y indicates the number of teeth)

 x(y) For contouring operations only : x indicates the maximum depth of cut (y indicates the number of teeth)

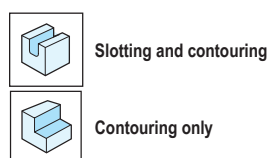

Square shoulder and slot milling cutters

Helical milling cutters

Face milling cutters

Disc milling cutters

High feed milling cutters

Copy milling cutters

Plunge milling cutters

Chamfer milling cutters

Spot facing cutters

Inserts

Selection – Metric

Cutter	Insert	Material suitability					Corner radius (mm)					
		P	M	K	N	S						
Right Helix R217/220.82-SNXO16	XO.X16 	■	■	■	□	■	0,4/0,8/1,2/ 1,6/2,0/2,4/3,1/ 4,0/5,0/6,3	-	■	-	■	■
	SN.U13 											
Right Helix R217/220.82-SNAC15-H	AC.T15 	■	■	■	□	□	1,2/3,0/3,1/6,0	-	■	■	-	-
	Left Helix R217/220.81-SNAC15-K R217/220.81-SNAC15-K 											









1st choice	■
Alternative choice	▣
Possible choice	□

High speed machine with low power/torque	
Strong stable machine with rigid connection	
Not recommended	

Unstable condition suitability	
Ramping ability	
Plunging ability	

Square shoulder and slot milling cutters
Helical milling cutters
Face milling cutters
Disc milling cutters
High feed milling cutters
Copy milling cutters
Plunge milling cutters
Chamfer milling cutters
Spot facing cutters
Inserts

Selection – Metric

Cutter	No. of cutting edges	Application	Cutter diameter (mm)/available depth of cut and number of teeth						See page
			50	63	80	100	125	160	
Right Helix R2177220.82-SNXO16	2/8		47 (3)	47 (4)	68 (5)				169
				69 (5) / 79 (4)	79 (6)				
Right Helix R217/220.82-SNAC15-H	2/8			46 (4)	57 (5)	57 (6)			178
									
Left Helix R217/220.81-SNAC15	2/8		68 (2)	68 (2)	68 (3)	68 (4)			177
									
Left Helix R217/220.81-SNAC15-K	2/8							176	
				68 (4)	79 (5)				

x(y)
x(y)

Slotting and contouring operations : x indicates the maximum depth of cut (y indicates the number of teeth)

For contouring operations only : x indicates the maximum depth of cut (y indicates the number of teeth)



Slotting and contouring



Contouring only

- Square shoulder and slot milling cutters
- Helical milling cutters
- Face milling cutters
- Disc milling cutters
- High feed milling cutters
- Copy milling cutters
- Plunge milling cutters
- Chamfer milling cutters
- Spot facing cutters
- Inserts

Selection – Inch

Cutter	Insert	Material suitability					Corner radius (inch)					
		P	M	K	N	S						
Right Helix R2177220.82-SNXO16	XO.X16 	■	■	■	□	■	.007/.016/.031 .047/.063 .079/.094 .122/.157 .197/.248	-	■	-	■	■
	SN.U13 											

1st choice	■	High speed machine with low power/torque 	Unstable condition suitability
Alternative choice	▣	Strong stable machine with rigid connection 	Ramping ability
Possible choice	□	Not recommended	Plunging ability

Selection – Inch

Cutter	No. of cutting edges	Applica-tion	Cutter diameter (inch)/available depth of cut and number of teeth						See page
			1.25	1.50	2.00	2.50	3.00	4.00	
Right Helix R2177220.82-SNXO16	2/8				1.85 (3)	1.85 (4)	2.68 (5)		170
						2.75 (5) / 3.11 (4)	3.11 (6)		

x(y)	Slotting and contouring operations : x indicates the maximum depth of cut (y indicates the number of teeth)		Slotting and contouring
x(y)	For contouring operations only : x indicates the maximum depth of cut (y indicates the number of teeth)		Contouring only

Square shoulder and slot milling cutters
Helical milling cutters
Face milling cutters
Disc milling cutters
High feed milling cutters
Copy milling cutters
Plunge milling cutters
Chamfer milling cutters
Spot facing cutters
Inserts



TURBO HELICAL

Seco's range of high-performance Turbo helical cutters offers high feeds, large depths of cut and high metal removal rates in contouring and profiling applications. These cutters provide a first choice for mixed production in all workpiece materials

- Insert size 06, cutter range 12-20 mm (0.75 inch)
- Insert size 10, cutter range 20-50 mm (1 inch)
- Insert size 12, cutter range 25-66 mm (1 - 2.5 inch)
- Insert size 16, cutter range 32-100 mm (1.5 - 3 inch)
- Insert size 18, cutter range 40-100 mm (1.5 - 4 inch)

Turbo 06 – R217.69-06 – Metric

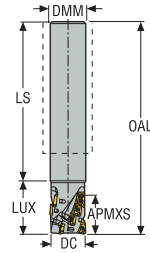

- For insert selection and cutting data recommendations, see page(s) 135-136
- For complete insert programme, see page(s) 866
- For ISO attribute explanation, see page 16
- KAPRS 90°

Designation	Item number	Type of mounting	DC	ZEFP	ZNP	APMXS	DMM	LUX	LS	OAL	RPMX	Weight	Insert
			mm			mm	mm	mm	mm	mm		kg	
R217.69-1612.0-10-06.2N	02709311	Cylindrical	12,0	2	4	10,0	16,0	23,0	66,0	98,0	54400	0,2	XO.X06..
R217.69-1616.0-15-06.3N	02709314	Cylindrical	16,0	3	9	15,0	16,0	30,0	80,0	110,0	48000	0,2	XO.X06..
R217.69-1616.0-20-06.2N	02709316	Cylindrical	16,0	2	8	20,0	16,0	30,0	80,0	110,0	48000	0,2	XO.X06..
R217.69-2020.0-25-06.3N	02709317	Cylindrical	20,0	3	15	25,0	20,0	35,0	85,0	120,0	44000	0,3	XO.X06..

Modification of the cutter body needed for radii > 0,8 mm

Spare Parts, included in delivery

For cutter	Insert key	Insert screw
R217.69-..	H4B-T06P	C01804-T06P

Accessories

For cutter	Insert clamping torque	Torque key
	0.5NM	T00-06P05

Torque and fixed keys, see page 894

Turbo 06 – R217.69-06 – Inch

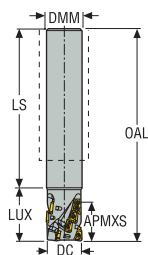

- For insert selection and cutting data recommendations, see page(s) 135-136
- For complete insert programme, see page(s) 866
- For ISO attribute explanation, see page 16
- KAPRS 90°

Designation	Item number	Type of mounting	DC	ZEFP	ZNP	APMXS	DMM	LUX	LS	OAL	RPMX	Weight	Insert
			inch			inch	inch	inch	inch	inch		lbs	
R217.69-00.75-0-06M3N	02710568	Cylindrical	0.750	3	15	1.024	0.750	1.378	3.622	5.000	44000	0.880	XO.X06..

Modification of the cutter body needed for radii > 0.031 in

Spare Parts, included in delivery

For cutter	Insert key	Insert screw
R217.69-..	H4B-T06P	C01804-T06P

Accessories

For cutter	Insert clamping torque	Torque key
R217.69-..	0.5NM	T00-06P05

Torque and fixed keys, see page 894

Square shoulder and slot milling cutters

Helical milling cutters

Face milling cutters

Disc milling cutters

High feed milling cutters

Copy milling cutters

Plunge milling cutters

Chamfer milling cutters

Spot facing cutters

Inserts

Turbo 06 – R217.69-06– Metric

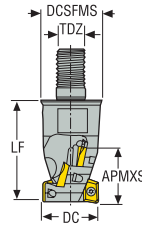

- For insert selection and cutting data recommendations, see page(s) 135-136
- For complete insert programme, see page(s) 866
- For ISO attribute explanation, see page 16
- KAPRS 90°

Designation	Item number	Type of mounting	DC	ZEFP	ZNP	APMXS	TDZ	DCSFMS	LF	RPMX	Weight	Insert
			mm			mm		mm	mm		kg	
R217.69-0814.RE-15-06.2N	02709297	Combimaster	14,0	2	6	15,0	M8	13,2	25,0	51200	0,1	XO.X06..
R217.69-1020.RE-20-06.3AN	02709306	Combimaster	20,0	3	12	20,0	M10	18,5	35,0	44800	0,1	XO.X06..

Modification of the cutter body needed for radii > 0,8 mm

Spare Parts, included in delivery

For cutter	Insert key	Insert screw
R217.69-..	H4B-T06P	C01804-T06P

Accessories

For cutter	Insert clamping torque	Torque key
R217.69-..	0.5NM	T00-06P05

Torque and fixed keys, see page 894

R217/220.69-06 – Insert selection – mm/Inch

SMG		f _z		
		100%	30%	10%
P1	XOMX060208R-M05 F40M	0,055 0.0022	0,060 0.0024	0,095 0.0038
P2	XOMX060208R-M05 F40M	0,055 0.0022	0,065 0.0026	0,095 0.0038
P3	XOMX060208R-M05 F40M	0,055 0.0022	0,060 0.0024	0,090 0.0036
P4	XOMX060208R-M05 F40M	0,055 0.0022	0,060 0.0024	0,090 0.0036
P5	XOMX060208R-M05 F40M	0,050 0.0020	0,055 0.0022	0,085 0.0034
P6	XOMX060208R-M05 F40M	0,050 0.0020	0,055 0.0022	0,085 0.0034
P7	XOMX060208R-M05 F40M	0,050 0.0020	0,055 0.0022	0,085 0.0034
P8	XOMX060208R-M05 F40M	0,055 0.0022	0,060 0.0024	0,090 0.0036
P11	XOMX060208R-M05 MP3000	0,050 0.0020	0,055 0.0022	0,085 0.0034
P12	XOMX060208R-M05 MP3000	0,036 0.0014	0,038 0.0015	0,060 0.0024
M1	XOMX060208R-M05 MS2050	0,055 0.0022	0,065 0.0026	0,095 0.0038
M2	XOMX060208R-M05 MS2050	0,050 0.0020	0,055 0.0022	0,085 0.0034
M3	XOMX060208R-M05 MS2050	0,042 0.0017	0,046 0.0018	0,070 0.0028
M4	XOMX060208R-M05 MS2050	0,036 0.0014	0,040 0.0016	0,060 0.0024
M5	XOMX060208R-M05 MS2050	0,036 0.0014	0,040 0.0016	0,060 0.0024
K1	XOMX060208R-M05 F40M	0,055 0.0022	0,065 0.0026	0,095 0.0038
K2	XOMX060208R-M05 F40M	0,050 0.0020	0,055 0.0022	0,085 0.0034
K3	XOMX060208R-M05 F40M	0,050 0.0020	0,055 0.0022	0,085 0.0034
K4	XOMX060208R-M05 F40M	0,050 0.0020	0,055 0.0022	0,085 0.0034
K5	XOMX060208R-M05 F40M	0,046 0.0018	0,050 0.0020	0,080 0.0032
K6	XOMX060208R-M05 F40M	0,050 0.0020	0,055 0.0022	0,085 0.0034
K7	XOMX060208R-M05 F40M	0,046 0.0018	0,050 0.0020	0,080 0.0032
N1	XOEX060204FR-E03 H15	0,060 0.0024	0,065 0.0026	0,10 0.0040
N2	XOEX060204FR-E03 H15	0,060 0.0024	0,065 0.0026	0,10 0.0040
N3	XOEX060204FR-E03 H15	0,060 0.0024	0,065 0.0026	0,10 0.0040
N11	XOEX060204FR-E03 H15	0,060 0.0024	0,065 0.0026	0,10 0.0040
S1	XOMX060208R-M05 F40M	0,036 0.0014	0,040 0.0016	0,060 0.0024
S2	XOMX060208R-M05 F40M	0,036 0.0014	0,040 0.0016	0,060 0.0024
S3	XOMX060208R-M05 F40M	0,034 0.0013	0,038 0.0015	0,055 0.0022
S11	XOMX060208R-M05 MS2050	0,042 0.0017	0,046 0.0018	0,070 0.0028
S12	XOMX060208R-M05 MS2050	0,042 0.0017	0,046 0.0018	0,070 0.0028
S13	XOMX060208R-M05 MS2050	0,036 0.0014	0,040 0.0016	0,060 0.0024
H5	XOMX060208R-M05 MP3000	0,036 0.0014	0,038 0.0015	0,060 0.0024
H8	XOMX060208R-M05 MP3000	0,028 0.0011	0,030 0.0012	0,046 0.0018
H11	XOMX060208R-M05 MP3000	0,036 0.0014	0,038 0.0015	0,060 0.0024
H12	XOMX060208R-M05 MP3000	0,028 0.0011	0,030 0.0012	0,046 0.0018

SMG = Seco material group
f_z = mm/tooth (in/tooth), v_c = m/min (sf/min), a_e/DC = %
All cutting data are start values

Square shoulder and slot milling cutters
Helical milling cutters
Face milling cutters
Disc milling cutters
High feed milling cutters
Copy milling cutters
Plunge milling cutters
Chamfer milling cutters
Spot facing cutters
Inserts

Turbo 10 – R217.69-10 – Metric

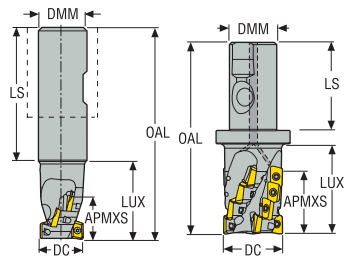

- For insert selection and cutting data recommendations, see page(s) 140-142
- For complete insert programme, see page(s) 867, 868
- For ISO attribute explanation, see page 16
- KAPRS 90°

Designation	Item number	Type of mounting	DC	ZEFP	ZNP	APMXS	DMM	LUX	LS	OAL	RPMX	Weight	Insert
			mm			mm	mm	mm	mm	mm		kg	
R217.69-2020.3-017-10.2A	02827022	Weldon	20,0	2	4	17,0	20,0	35,0	50,0	85,0	26300	0,2	XO.X10..
R217.69-2020.3-025-10.1A	02827023	Weldon	20,0	1	3	25,0	20,0	45,0	50,0	95,0	26300	0,3	XO.X10..
R217.69-2525.3-025-10.2A	02827024	Weldon	25,0	2	6	25,0	25,0	44,0	50,0	100,0	23500	0,4	XO.X10..
R217.69-2025.3S-025-10.3A	02827025	Seco-Weldon	25,0	3	9	25,0	20,0	43,0	50,0	100,0	23500	0,4	XO.X10.*
R217.69-2025.3S-034-10.3A	02827026	Seco-Weldon	25,0	3	12	34,0	20,0	43,0	50,0	100,0	23500	0,4	XO.X10.*
R217.69-2525.3S-034-10.3A	02827027	Seco-Weldon	25,0	3	12	34,0	25,0	43,0	56,0	110,0	23500	0,4	XO.X10.*
R217.69-2525.3S-042-10.2A	02827028	Seco-Weldon	25,0	2	10	42,0	25,0	53,0	56,0	120,0	23500	0,5	XO.X10..
R217.69-2532.3S-034-10.4A	02827029	Seco-Weldon	32,0	4	16	34,0	25,0	43,0	56,0	110,0	20800	0,5	XO.X10.*
R217.69-2532.3S-042-10.4A	02827030	Seco-Weldon	32,0	4	20	42,0	25,0	53,0	56,0	120,0	20800	0,4	XO.X10.*
R217.69-2532.3S-050-10.3A	02827031	Seco-Weldon	32,0	3	18	50,0	25,0	63,0	56,0	130,0	20800	0,5	XO.X10..
R217.69-3240.3S-058-10.4A	02827032	Seco-Weldon	40,0	4	28	58,0	32,0	72,0	60,0	144,0	18600	0,9	XO.X10..

Modification of the cutter body needed for radii > 2,0 mm
* No axial support in the front row for radii > 1,6 mm

Spare Parts, included in delivery

For cutter	Insert key	Insert screw
R217.69-..	H4B-T07P	C02506-T07P

Accessories

For cutter	Insert clamping torque	Torque key
R217.69-..	0.9NM	T00-07P09

Torque and fixed keys, see page 894

Square shoulder and slot milling cutters

Helical milling cutters

Face milling cutters

Disc milling cutters

High feed milling cutters

Copy milling cutters

Plunge milling cutters

Chamfer milling cutters

Spot facing cutters

Inserts

Turbo 10 – R217.69-10 – Inch

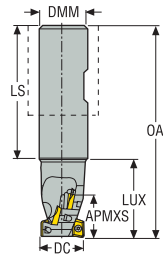

- For insert selection and cutting data recommendations, see page(s) 140-142
- For complete insert programme, see page(s) 867, 868
- For ISO attribute explanation, see page 16
- KAPRS 90°

Designation	Item number	Type of mounting	DC	ZEFP	ZNP	APMXS	DMM	LUX	LS	OAL	RPMX	Weight	Insert
			inch			inch	inch	inch	inch	inch		lbs	
R217.69-01.00-3-01.00-10-2A	02829883	Weldon	1.000	2	6	1.024	1.000	1.874	2.282	4.000	23500	0.880	XO.X10..
R217.69-01.00-3-01.34-10-3A	02865301	Weldon	1.000	3	12	1.378	1.000	1.969	2.282	4.250	23500	0.880	XO.X10..*
R217.69-01.00-3-01.65-10-2A	02865304	Weldon	1.000	2	10	1.693	1.000	2.078	2.422	4.500	23500	0.880	XO.X10..

Modification of the cutter body needed for radii > 0.079 in
* No axial support in the front row for radii > 0.063

Spare Parts, included in delivery

For cutter	Insert key	Insert screw
R217.69-..	H4B-T07P	C02506-T07P

Accessories

For cutter	Insert clamping torque	Torque key
R217.69-..	8.0IN.LBS	T00-07P09

Torque and fixed keys, see page 894

Turbo 10 – R217/220.69-10 – Metric

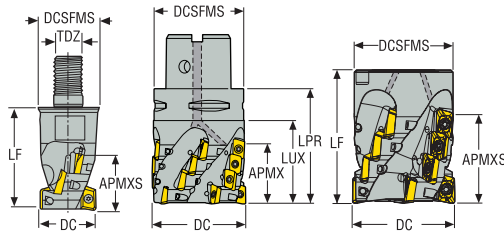

- For insert selection and cutting data recommendations, see page(s) 140-142
- For complete insert programme, see page(s) 867, 868
- For ISO attribute explanation, see page 16
- KAPRS 90°

Designation	Item number	Type of mounting	DC	ZEP	ZNP	APMXS	DCB	TDZ	DCSFMS	LF	LUX	RPMX	Weight	Insert
			mm			mm	mm		mm	mm	mm		kg	
R217.69-1020.RE-017-10.2A	02827017	Combimaster	20,0	2	4	17,0	–	M10	18,5	28,0	–	26300	0,1	XO.X10..
R217.69-1225.RE-017-10.3A	02827018	Combimaster	25,0	3	6	17,0	–	M12	23,0	35,0	–	23500	0,1	XO.X10..*
R217.69-1225.RE-025-10.2A	02827019	Combimaster	25,0	2	6	25,0	–	M12	23,0	40,0	–	23500	0,1	XO.X10..
R217.69-1632.RE-025-10.3A	02827020	Combimaster	32,0	3	9	25,0	–	M16	30,0	45,0	–	20800	0,2	XO.X10..
R217.69-1632.RE-034-10.4A	02827021	Combimaster	32,0	4	16	34,0	–	M16	30,0	50,0	–	20800	0,3	XO.X10..*
C4-R217.69-044-058-10.5A	02827033	Seco-Capto	44,0	5	35	58,0	–	–	40,0	90,0	–	16600	0,7	XO.X10..*
R220.69-00040-034-10.4A	02865893	Arbor	40,0	4	16	34,0	16,0	–	35,0	55,0	–	18600	0,3	XO.X10..
R220.69-00040-034-10.5A	02827038	Arbor	40,0	5	20	34,0	16,0	–	38,0	55,0	–	18600	0,3	XO.X10..*
R220.69-00050-042-10.5A	02865895	Arbor	50,0	5	25	42,0	27,0	–	48,0	65,0	–	16600	0,5	XO.X10..
R220.69-00050-042-10.6A	02827039	Arbor	50,0	6	30	42,0	27,0	–	48,0	65,0	–	16600	0,5	XO.X10..*

For Combimaster Shanks, see Machining Navigator Tooling System

Modification of the cutter body needed for radii > 2,0 mm
* No axial support in the front row for radii > 1,6 mm

Spare Parts, included in delivery

For cutter	Arbor screw	Insert key	Insert screw
R217.69-../Cx-R217.69-..	–	H4B-T07P	C02506-T07P
R220.69-00040	950D0850	H4B-T07P	C02506-T07P
R220.69-00050	MC6S12X60	H4B-T07P	C02506-T07P

Accessories

For cutter	Insert clamping torque	Torque key
R217/220.69-..	0.9NM	T00-07P09

Torque and fixed keys, see page 894

R217/220.69-10 – Insert selection – mm/Inch

SMG		f_z		
		100%	30%	10%
P1	XOMX10T308TR-ME07 MP2501	0,080	0,085	0,13
		0,0032	0,0034	0,0050
P2	XOMX10T308TR-ME07 MP2501	0,080	0,090	0,13
		0,0032	0,0036	0,0050
P3	XOMX10T308TR-ME07 MP2501	0,075	0,085	0,13
		0,0030	0,0034	0,0050
P4	XOMX10T308TR-M09 MP2501	0,095	0,10	0,16
		0,0038	0,0040	0,0065
P5	XOMX10T308TR-M09 MP2501	0,095	0,10	0,16
		0,0038	0,0040	0,0065
P6	XOMX10T308TR-M09 MP2501	0,095	0,10	0,16
		0,0038	0,0040	0,0065
P7	XOMX10T308TR-M09 MP2501	0,095	0,10	0,16
		0,0038	0,0040	0,0065
P8	XOMX10T308TR-M09 MP2501	0,095	0,11	0,16
		0,0038	0,0044	0,0065
P11	XOMX10T308TR-M09 T350M	0,095	0,10	0,16
		0,0038	0,0040	0,0065
P12	XOMX10T308TR-M09 T350M	0,065	0,070	0,11
		0,0026	0,0028	0,0044
M1	XOEX10T308R-M06 MS2050	0,070	0,075	0,12
		0,0028	0,0030	0,0048
M2	XOEX10T308R-M06 MS2050	0,060	0,070	0,10
		0,0024	0,0028	0,0040
M3	XOEX10T308R-M06 MS2050	0,050	0,055	0,085
		0,0020	0,0022	0,0034
M4	XOMX10T308TR-ME07 MS2050	0,050	0,055	0,085
		0,0020	0,0022	0,0034
M5	XOMX10T304TR-ME07 MS2050	0,050	0,055	0,085
		0,0020	0,0022	0,0034
K1	XOMX10T308TR-M09 MK2050	0,10	0,11	0,17
		0,0040	0,0044	0,0065
K2	XOMX10T308TR-M09 MK2050	0,095	0,10	0,16
		0,0038	0,0040	0,0065
K3	XOMX10T308TR-M09 MK2050	0,095	0,10	0,16
		0,0038	0,0040	0,0065
K4	XOMX10T308TR-M09 MK2050	0,095	0,10	0,16
		0,0038	0,0040	0,0065
K5	XOMX10T308TR-M09 MK2050	0,085	0,090	0,14
		0,0034	0,0036	0,0055
K6	XOMX10T308TR-M09 MK2050	0,095	0,10	0,16
		0,0038	0,0040	0,0065
K7	XOMX10T308TR-M09 MK2050	0,085	0,090	0,14
		0,0034	0,0036	0,0055
N1	XOEX10T308FR-E05 H15	0,075	0,080	0,12
		0,0030	0,0032	0,0048
N2	XOEX10T308FR-E05 H15	0,075	0,080	0,12
		0,0030	0,0032	0,0048
N3	XOEX10T308FR-E05 H15	0,075	0,080	0,12
		0,0030	0,0032	0,0048
N11	XOEX10T308FR-E05 H15	0,075	0,080	0,12
		0,0030	0,0032	0,0048
S1	XOMX10T308TR-ME07 F40M	0,050	0,055	0,085
		0,0020	0,0022	0,0034
S2	XOMX10T308TR-ME07 F40M	0,048	0,050	0,080
		0,0019	0,0020	0,0032
S3	XOMX10T308TR-ME07 F40M	0,050	0,055	0,085
		0,0020	0,0022	0,0034
S11	XOEX10T308R-M06 MS2050	0,050	0,055	0,085
		0,0020	0,0022	0,0034
S12	XOEX10T308R-M06 MS2050	0,044	0,048	0,075
		0,0020	0,0022	0,0034
S13	XOEX10T308R-M06 MS2050	0,044	0,048	0,075
		0,0017	0,0019	0,0030
H5	XOMX10T308TR-M09 MP3000	0,065	0,070	0,11
		0,0026	0,0028	0,0044
H8	XOMX10T308TR-M09 MP3000	0,048	0,055	0,080
		0,0019	0,0022	0,0032
H11	XOMX10T308TR-M09 MP3000	0,065	0,070	0,11
		0,0026	0,0028	0,0044
H12	XOMX10T308TR-M09 MP3000	0,048	0,055	0,080
		0,0019	0,0022	0,0032

SMG = Seco material group
 f_z = mm/tooth (in/tooth), v_c = m/min (sf/min), a_p /DC = %
 All cutting data are start values

R217/220.69-10 – Cutting data $v_c = (m/min)/(sf/min)$

SMG	MP1501			MP2501			MP3000			T350M			F40M		
	100%	30%	10%	100%	30%	10%	100%	30%	10%	100%	30%	10%	100%	30%	10%
P1	155	170	180	145	165	175	145	160	170	140	155	165	135	155	165
	510	560	590	475	540	570	475	520	560	460	510	540	445	510	540
P2	150	170	180	145	160	170	140	160	170	135	155	165	135	155	165
	490	560	590	475	520	560	460	520	560	445	510	540	445	510	540
P3	145	160	170	135	150	165	135	150	160	130	145	155	130	145	155
	475	520	560	445	490	540	445	490	520	425	475	510	425	475	510
P4	135	155	165	130	145	155	125	145	150	120	140	145	120	135	145
	445	510	540	425	475	510	410	475	490	395	460	475	395	445	475
P5	135	150	160	125	145	155	125	140	150	120	135	145	115	135	145
	445	490	520	410	475	510	410	460	490	395	445	475	375	445	475
P6	140	160	165	135	150	160	130	145	155	125	140	150	125	140	150
	460	520	540	445	490	520	425	475	510	410	460	490	410	460	490
P7	135	155	165	130	145	155	125	145	155	120	140	150	120	140	150
	445	510	540	425	475	510	410	475	510	395	460	490	395	460	490
P8	135	150	160	125	140	155	125	140	150	120	135	145	115	135	145
	445	490	520	410	460	510	410	460	490	395	445	475	375	445	475
P11	135	155	160	130	145	155	125	140	150	120	135	145	120	135	145
	445	510	520	425	475	510	410	460	490	395	445	475	395	445	475
P12	110	125	135	100	120	130	100	115	125	95	110	120	95	110	120
	360	410	445	330	395	425	330	375	410	310	360	395	310	360	395
M1	—	—	—	125	140	150	125	140	150	120	140	145	125	140	150
	—	—	—	410	460	490	410	460	490	395	460	475	410	460	490
M2	—	—	—	115	130	140	110	130	140	110	125	135	110	130	140
	—	—	—	375	425	460	360	425	460	360	410	445	360	425	460
M3	—	—	—	100	115	125	100	115	125	95	115	120	100	115	125
	—	—	—	330	375	410	330	375	410	310	375	395	330	375	410
M4	—	—	—	85	100	110	85	100	110	80	100	105	85	100	110
	—	—	—	280	330	360	280	330	360	260	330	345	280	330	360
M5	—	—	—	75	90	100	75	90	100	70	85	95	70	90	100
	—	—	—	245	295	330	245	295	330	230	280	310	230	295	330
K1	140	155	165	130	150	155	130	145	155	125	140	150	120	140	150
	460	510	540	425	490	510	425	475	510	410	460	490	395	460	490
K2	130	150	155	125	140	150	120	135	145	115	130	140	115	130	140
	425	490	510	410	460	490	395	445	475	375	425	460	375	425	460
K3	120	140	145	115	130	140	110	125	135	105	120	130	105	120	130
	395	460	475	375	425	460	360	410	445	345	395	425	345	395	425
K4	115	135	145	110	130	135	105	125	135	100	120	130	100	120	130
	375	445	475	360	425	445	345	410	445	330	395	425	330	395	425
K5	90	105	115	80	100	110	75	95	105	70	90	100	70	90	100
	295	345	375	260	330	360	245	310	345	230	295	330	230	295	330
K6	110	125	135	105	120	130	100	115	125	95	110	120	95	110	120
	360	410	445	345	395	425	330	375	410	310	360	395	310	360	395
K7	105	120	130	95	115	120	90	110	120	85	105	115	85	105	115
	345	395	425	310	375	395	295	360	395	280	345	375	280	345	375
N1	—	—	—	—	—	—	245	265	275	—	—	—	245	260	270
	—	—	—	—	—	—	800	870	900	—	—	—	800	850	890
N2	—	—	—	—	—	—	195	210	220	—	—	—	190	205	215
	—	—	—	—	—	—	640	690	720	—	—	—	620	670	710
N3	—	—	—	—	—	—	170	185	195	—	—	—	165	180	190
	—	—	—	—	—	—	560	610	640	—	—	—	540	590	620
N11	—	—	—	—	—	—	175	195	205	—	—	—	170	190	200
	—	—	—	—	—	—	570	640	670	—	—	—	560	620	660
S1	—	—	—	45	60	70	42	55	65	40	50	60	41	55	65
	—	—	—	150	195	230	140	180	215	130	165	195	135	180	215
S2	—	—	—	36	47	55	34	45	50	32	42	49	33	43	50
	—	—	—	120	155	180	110	150	165	105	140	160	110	140	165
S3	—	—	—	31	41	49	30	39	46	28	37	43	29	38	44
	—	—	—	100	135	160	100	130	150	90	120	140	95	125	145
S11	—	—	—	60	80	90	60	75	85	55	70	80	55	75	85
	—	—	—	195	260	295	195	245	280	180	230	260	180	245	280
S12	—	—	—	43	55	65	41	55	60	38	50	60	39	50	60
	—	—	—	140	180	215	135	180	195	125	165	195	130	165	195
S13	—	—	—	25	33	39	24	31	36	22	30	34	23	30	35
	—	—	—	80	110	130	80	100	120	70	100	110	75	100	115
H5	45	60	70	36	48	55	35	47	55	35	46	55	34	45	55
	150	195	230	120	155	180	115	155	180	115	150	180	110	150	180
H8	48	65	75	39	50	60	38	49	60	37	48	55	36	47	55
	155	215	245	130	165	195	125	160	195	120	155	180	120	155	180
H11	60	75	85	46	60	70	45	60	70	44	60	70	44	55	65
	195	245	280	150	195	230	150	195	230	145	195	230	145	180	215
H12	80	100	110	75	90	100	70	85	100	65	80	95	65	80	90
	260	330	360	245	295	330	230	280	330	215	260	310	215	260	295

Square shoulder and slot milling cutters
Helical milling cutters
Face milling cutters
Disc milling cutters
High feed milling cutters
Copy milling cutters
Plunge milling cutters
Chamfer milling cutters
Spot facing cutters
Inserts

R217/220.69-10 – Cutting data $v_c = (m/min)/(sf/min)$

SMG	MK1500			MK2050			MS2050			MS2500			MM4500			H15			
	100%	30%	10%	100%	30%	10%	100%	30%	10%	100%	30%	10%	100%	30%	10%	100%	30%	10%	
Square shoulder and slot milling cutters	P1	—	—	—	145	160	170	145	160	170	160	175	185	125	140	150	—	—	—
		—	—	—	475	520	560	475	520	560	520	570	610	410	460	490	—	—	—
Helical milling cutters	P2	—	—	—	145	160	170	140	160	170	155	170	185	125	140	150	—	—	—
		—	—	—	475	520	560	460	520	560	510	560	610	410	460	490	—	—	—
Face milling cutters	P3	—	—	—	135	150	160	135	150	160	150	165	175	115	130	140	—	—	—
		—	—	—	445	490	520	445	490	520	490	540	570	375	425	460	—	—	—
Disc milling cutters	P4	—	—	—	130	145	155	125	140	150	140	155	165	105	125	135	—	—	—
		—	—	—	425	475	510	410	460	490	460	510	540	345	410	445	—	—	—
High feed milling cutters	P5	—	—	—	125	145	150	125	140	150	135	155	165	105	120	130	—	—	—
		—	—	—	410	475	490	410	460	490	445	510	540	345	395	425	—	—	—
Copy milling cutters	P6	—	—	—	130	150	160	130	145	155	145	160	170	115	130	140	—	—	—
		—	—	—	425	490	520	425	475	510	475	520	560	375	425	460	—	—	—
Plunge milling cutters	P7	—	—	—	130	145	155	125	145	155	140	160	170	110	125	135	—	—	—
		—	—	—	425	475	510	410	475	510	460	520	560	360	410	445	—	—	—
Chamfer milling cutters	P8	—	—	—	125	140	150	125	140	150	135	155	165	105	120	130	—	—	—
		—	—	—	410	460	490	410	460	490	445	510	540	345	395	425	—	—	—
Spot facing cutters	P11	—	—	—	125	145	155	125	140	150	140	155	165	105	125	135	—	—	—
		—	—	—	410	475	510	410	460	490	460	510	540	345	410	445	—	—	—
Inserts	P12	—	—	—	100	120	125	100	115	125	115	130	140	80	95	105	—	—	—
		—	—	—	330	395	410	330	375	410	375	425	460	260	310	345	—	—	—
Square shoulder and slot milling cutters	M1	—	—	—	—	—	—	130	145	155	135	150	165	115	130	140	—	—	—
		—	—	—	—	—	—	425	475	510	445	490	540	375	425	460	—	—	—
Helical milling cutters	M2	—	—	—	—	—	—	120	135	145	125	140	150	100	120	130	—	—	—
		—	—	—	—	—	—	395	445	475	410	460	490	330	395	425	—	—	—
Face milling cutters	M3	—	—	—	—	—	—	105	120	130	110	125	140	90	105	115	—	—	—
		—	—	—	—	—	—	345	395	425	360	410	460	295	345	375	—	—	—
Disc milling cutters	M4	—	—	—	—	—	—	90	105	115	95	110	120	75	90	100	—	—	—
		—	—	—	—	—	—	295	345	375	310	360	395	245	295	330	—	—	—
High feed milling cutters	M5	—	—	—	—	—	—	75	95	105	85	100	110	65	80	90	—	—	—
		—	—	—	—	—	—	245	310	345	280	330	360	215	260	295	—	—	—
Copy milling cutters	K1	150	170	180	150	165	175	—	—	—	—	—	—	—	—	—	—	—	—
		490	560	590	490	540	570	—	—	—	—	—	—	—	—	—	—	—	—
Plunge milling cutters	K2	145	160	170	140	160	165	—	—	—	—	—	—	—	—	—	—	—	—
		475	520	560	460	520	540	—	—	—	—	—	—	—	—	—	—	—	—
Chamfer milling cutters	K3	135	150	160	130	150	155	—	—	—	—	—	—	—	—	—	—	—	—
		445	490	520	425	490	510	—	—	—	—	—	—	—	—	—	—	—	—
Spot facing cutters	K4	130	150	160	130	145	155	—	—	—	—	—	—	—	—	—	—	—	—
		425	490	520	425	475	510	—	—	—	—	—	—	—	—	—	—	—	—
Inserts	K5	100	120	130	100	115	125	—	—	—	—	—	—	—	—	—	—	—	—
		330	395	425	330	375	410	—	—	—	—	—	—	—	—	—	—	—	—
Square shoulder and slot milling cutters	K6	125	140	150	120	140	145	—	—	—	—	—	—	—	—	—	—	—	—
		410	460	490	395	460	475	—	—	—	—	—	—	—	—	—	—	—	—
Helical milling cutters	K7	115	135	145	115	130	140	—	—	—	—	—	—	—	—	—	—	—	—
		375	445	475	375	425	460	—	—	—	—	—	—	—	—	—	—	—	—
Face milling cutters	N1	—	—	—	—	—	—	—	—	—	—	—	—	—	—	—	245	260	270
		—	—	—	—	—	—	—	—	—	—	—	—	—	—	—	800	850	890
Disc milling cutters	N2	—	—	—	—	—	—	—	—	—	—	—	—	—	—	—	190	205	215
		—	—	—	—	—	—	—	—	—	—	—	—	—	—	—	620	670	710
Copy milling cutters	N3	—	—	—	—	—	—	—	—	—	—	—	—	—	—	—	165	185	195
		—	—	—	—	—	—	—	—	—	—	—	—	—	—	—	540	610	640
Plunge milling cutters	N11	—	—	—	—	—	—	—	—	—	—	—	—	—	—	—	175	190	200
		—	—	—	—	—	—	—	—	—	—	—	—	—	—	—	570	620	660
Chamfer milling cutters	S1	—	—	—	—	—	—	45	60	70	55	70	80	23	30	36	—	—	—
		—	—	—	—	—	—	150	195	230	180	230	260	75	100	120	—	—	—
Spot facing cutters	S2	—	—	—	—	—	—	36	47	55	43	55	65	19	25	29	—	—	—
		—	—	—	—	—	—	120	155	180	140	180	215	60	80	95	—	—	—
Helical milling cutters	S3	—	—	—	—	—	—	32	41	48	37	49	60	16	22	25	—	—	—
		—	—	—	—	—	—	105	135	155	120	160	195	50	70	80	—	—	—
Face milling cutters	S11	—	—	—	—	—	—	65	80	90	75	90	100	32	42	50	—	—	—
		—	—	—	—	—	—	215	260	295	245	295	330	105	140	165	—	—	—
Copy milling cutters	S12	—	—	—	—	—	—	43	55	65	50	65	75	30	39	46	—	—	—
		—	—	—	—	—	—	140	180	215	165	215	245	100	130	150	—	—	—
Disc milling cutters	S13	—	—	—	—	—	—	25	33	38	30	39	46	17	23	27	—	—	—
		—	—	—	—	—	—	80	110	125	100	130	150	55	75	90	—	—	—
Spot facing cutters	H5	—	—	—	—	—	—	—	—	—	—	—	—	—	—	—	—	—	—
		—	—	—	—	—	—	—	—	—	—	—	—	—	—	—	—	—	—
Helical milling cutters	H8	—	—	—	—	—	—	—	—	—	—	—	—	—	—	—	—	—	—
		—	—	—	—	—	—	—	—	—	—	—	—	—	—	—	—	—	—
Face milling cutters	H11	—	—	—	—	—	—	—	—	—	—	—	—	—	—	—	—	—	—
		—	—	—	—	—	—	—	—	—	—	—	—	—	—	—	—	—	—
Disc milling cutters	H12	—	—	—	—	—	—	—	—	—	—	—	—	—	—	—	—	—	—
		—	—	—	—	—	—	—	—	—	—	—	—	—	—	—	—	—	—

Turbo 12 – R217.69-12 – Metric

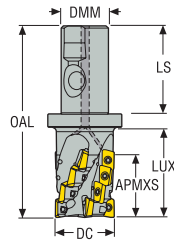

- For insert selection and cutting data recommendations, see page(s) 150-152
- For complete insert programme, see page(s) 869, 870
- For ISO attribute explanation, see page 16
- KAPRS 90°

Designation	Item number	Type of mounting	DC	ZEFP	ZNP	APMXS	DMM	LUX	LS	OAL	RPMX	Weight	Insert
			mm			mm	mm	mm	mm	mm		kg	
R217.69-2025.3S-022-12.2AN	02709523	Seco-Weldon	25,0	2	4	22,0	20,0	38,0	50,0	99,5	20800	0,4	XO.X12..*
R217.69-2525.3S-033-12.2AN	02709526	Seco-Weldon	25,0	2	6	33,0	25,0	43,0	56,0	115,5	20800	0,4	XO.X12..*
R217.69-2532.3S-033-12.2AN	02709528	Seco-Weldon	32,0	2	6	33,0	25,0	47,0	56,0	115,5	18400	0,5	XO.X12..
R217.69-2532.3S-033-12.3AN	02709530	Seco-Weldon	32,0	3	9	33,0	25,0	48,0	56,0	115,5	18400	0,5	XO.X12..*
R217.69-2532.3S-044-12.3AN	02629796	Seco-Weldon	32,0	3	12	44,0	25,0	58,0	56,0	125,5	18400	0,6	XO.X12..*
R217.69-3240.3S-033-12.3AN	02709540	Seco-Weldon	40,0	3	9	33,0	32,0	49,0	60,0	119,5	16400	0,8	XO.X12..
R217.69-3240.3S-044-12.4AN	02709541	Seco-Weldon	40,0	4	16	44,0	32,0	57,0	60,0	129,5	16400	0,8	XO.X12..*
R217.69-3240.3S-055-12.3AN	02709543	Seco-Weldon	40,0	3	15	55,0	32,0	69,0	60,0	139,5	16400	0,9	XO.X12..
R217.69-3250.3S-055-12.4AN	02709546	Seco-Weldon	50,0	4	20	55,0	32,0	67,0	60,0	139,5	14800	1,1	XO.X12..

Modification of the cutter body needed for radii > 3,1 mm
* No axial support in the front row for radii > 1,6 mm

Spare Parts, included in delivery

For cutter	Insert key	Insert screw
R217.69-...Ø25/R217.69-HSK	H4B-T10P	C03507-T10P
R217.69-...Ø32	H4B-T10P	C03508-T10P
R217.69-...Ø40-50	H4B-T10P	C03509-T10P

Accessories

For cutter	Insert clamping torque	Torque key
R217.69-...	3.0NM	T00-10P30

Torque and fixed keys, see page 894

Turbo 12 – R217.69-12 – Inch

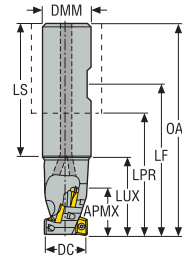

- For insert selection and cutting data recommendations, see page(s) 150-152
- For complete insert programme, see page(s) 869, 870
- For ISO attribute explanation, see page 16
- KAPRS 90°

Designation	Item number	Type of mounting	DC	ZEFP	ZNP	APMXS	DMM	LUX	LPR	OAL	RPMX	Weight	Insert
			inch			inch	inch	inch	inch	inch		lbs	
R217.69-01.25-3-12M3AN	02710789	Weldon	1.250	3	12	1.732	1.250	2.695	2.638	5.000	18400	1.320	XO.X12..*
R217.69-01.50-3-12S3AN	02710800	Weldon	1.500	3	12	1.732	1.500	2.510	2.925	5.252	16400	2.200	XO.X12..*
R217.69-01.50-3-12M4AN	02710799	Weldon	1.500	4	20	2.165	1.500	3.010	3.061	5.750	16400	2.430	XO.X12..*
R217.69-01.50-3-12L3AN	02710795	Weldon	1.500	3	18	2.559	1.500	3.262	3.636	5.998	16400	2.200	XO.X12..
R217.69-02.00-3-12M4AN	02710802	Weldon	2.000	4	24	2.591	1.500	3.311	3.311	5.998	14800	3.090	XO.X12..

Modification of the cutter body needed for radii > 0.122 in
* No axial support in the front row for radii > 0.063

Spare Parts, included in delivery

For cutter	Insert key	Insert screw
R217.69-01.00-01.25	H4B-T10P	C03507-T10P
R217.69-01.50-02.00	H4B-T10P	C03509-T10P

Accessories

For cutter	Insert clamping torque	Torque key
R217.69-..	3.0NM	T00-10P30

Torque and fixed keys, see page 894

Turbo 12 – R217/220.69-12 – Metric

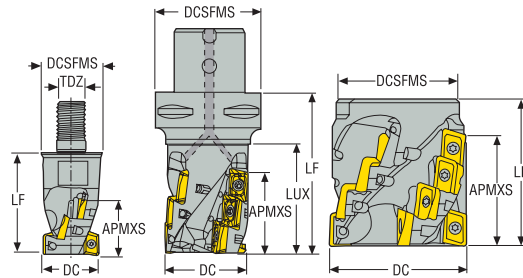

- For insert selection and cutting data recommendations, see page(s) 150-152
- For complete insert programme, see page(s) 869, 870
- For ISO attribute explanation, see page 16
- KAPRS 90°

Designation	Item number	Type of mounting	DC	ZEFP	ZNP	APMXS	DCB	TDZ	DCSFMS	LF	LUX	RPMX	Weight	Insert
			mm			mm	mm		mm	mm	mm		kg	
R217.69-1225.RE-022-12.2AN	02709506	Combimaster	25,0	2	4	22,5	–	M12	23,0	35,0	–	20800	0,2	XO.X12..*
R217.69-1632.RE-022-12.3AN	02709508	Combimaster	32,0	3	6	22,5	–	M16	30,0	40,0	–	18400	0,3	XO.X12..*
R217.69-2040.RE-033-12.3AN	02972763	Combimaster	40,0	3	9	33,0	–	M20	36,5	50,0	–	16400	0,4	XO.X12..
R217.69-2040.RE-044-12.4AN	02972764	Combimaster	40,0	4	16	44,0	–	M20	36,5	61,0	–	16400	0,4	XO.X12..*
R220.69-00050-033-12.4AN	02709941	Arbor	50,0	4	12	33,0	27,0	–	48,0	55,0	–	14800	0,4	XO.X12..
R220.69-00050-044-12.4AN	02709947	Arbor	50,0	4	16	44,0	27,0	–	48,0	65,0	–	14800	0,5	XO.X12..
R220.69-00050-044-12.5AN	02709951	Arbor	50,0	5	20	44,0	27,0	–	48,0	65,0	–	14800	0,5	XO.X12..*
R220.69-00063-033-12.5AN	02709956	Arbor	63,0	5	15	33,0	27,0	–	62,0	63,0	–	13200	1,0	XO.X12..
R220.69-00063-055-12.5AN	02709965	Arbor	63,0	5	25	55,0	27,0	–	60,0	75,0	–	13200	1,0	XO.X12..
R220.69-00063-077-12.4SAN	02717797	Arbor	63,0	4	28	77,0	27,0	–	60,0	100,0	–	13200	1,5	XO.X12..
R217.69-HSK63A.32-044-12.3AN	02717942	HSK	32,0	3	12	44,0	–	–	63,0	90,0	52,0	18400	1,0	XO.X12..*

For Combimaster Shanks, see Machining Navigator Tooling System

Modification of the cutter body needed for radii > 3,1 mm
* No axial support in the front row for radii > 1,6 mm

Square shoulder and slot milling cutters

Helical milling cutters

Face milling cutters

Disc milling cutters

High feed milling cutters

Copy milling cutters





Plunge milling cutters

Chamfer milling cutters

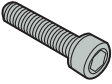

Spot facing cutters

Inserts

Spare Parts, included in delivery

For cutter	Arbor screw	Basic body	Insert key	Insert screw	Replaceable end
					
R217.69-..Ø25	-	-	H4B-T10P	C03507-T10P	-
R217.69-..J/C5-R217.69-Ø32	-	-	H4B-T10P	C03508-T10P	-
R217.69-..J/Cx-R217.69-Ø40-66	-	-	H4B-T10P	C03509-T10P	-
R220.69-Ø50-033	MC6S12X40	-	H4B-T10P	C03509-T10P	-
R220.69-Ø50/Ø63-033-044	MC6S12X50	-	H4B-T10P	C03509-T10P	-
R220.69-Ø50/Ø63-044-055	MC6S12X60	-	H4B-T10P	C03509-T10P	-
R220.69-00063	MP6S12X80	R220.69-00063044-12.4BAN	H4B-T10P	C03509-T10P	R220.69-RE063033-12.4AN
R217.69-..Ø25/R217.69-HSK	-	-	H4B-T10P	C03507-T10P	-

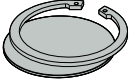
Accessories

For cutter	Coolant kit	Insert clamping torque	Torque key
			
R217/220.69-..	-	3.0NM	T00-10P30
R220.69-..SAN	LUBRICATION_SET_29	3.0NM	T00-10P30

Torque and fixed keys, see page 894

Square shoulder and slot milling cutters
Helical milling cutters
Face milling cutters
Disc milling cutters
High feed milling cutters
Copy milling cutters
Plunge milling cutters
Chamfer milling cutters
Spot facing cutters
Inserts

Turbo 12 – R217/220.69-12 – Inch

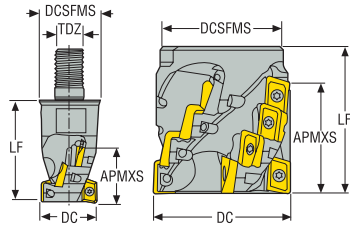

- For insert selection and cutting data recommendations, see page(s) 150-152
- For complete insert programme, see page(s) 869, 870
- For ISO attribute explanation, see page 16
- KAPRS 90°

Designation	Item number	Type of mounting	DC	ZEFP	ZNP	APMXS	DCB	TDZ	DCSFMS	LF	RPMX	Weight	Insert
			inch			inch	inch		inch	inch		lbs	
R217.69-1.00-12RE-12S2AN	02710788	Combimaster	1.000	2	4	0.870	–	M12	0.906	1.378	14800	0.440	XO.X12..*
R217.69-01.50-20RE-01.73-12-4A	03003976	Combimaster	1.500	4	16	1.732	–	M20	1.437	2.402	16400	0.880	XO.X12..*
R220.69-02.00-12S4AN	02710915	Arbor	2.000	4	16	1.740	1.000	–	2.047	2.750	14800	1.320	XO.X12..
R220.69-02.00-12M5AN	02710895	Arbor	2.000	5	25	2.146	1.000	–	2.047	3.250	14800	1.540	XO.X12..*
R220.69-02.50-12L4SAN	02722266	Arbor	2.500	4	28	2.953	1.000	–	2.441	4.020	13200	4.630	XO.X12..

For Combimaster Shanks, see Machining Navigator Tooling System

Modification of the cutter body needed for radii > 0.122 in
* No axial support in the front row for radii > 0.063

Spare Parts, included in delivery

For cutter	Arbor screw	Basic body	Insert key	Insert screw	Replaceable end
R217.69-01.00-01.25	–	–	H4B-T10P	C03507-T10P	–
R217.69-01.50	–	–	H4B-T10P	C03509-T10P	–
R220.69-..M5	UC6S1/2UNFX2-1/2	–	H4B-T10P	C03509-T10P	–
R220.69-..S4	UC6S1/2UNFX3	–	H4B-T10P	C03509-T10P	–
R220.69-..L4	UP6S1/2UNFX3-1/4	R220.69-02.50-12L4BAN	H4B-T10P	C03509-T10P	R220.69-02.50-RE-12.4AN

Accessories

For cutter	Coolant kit	Insert clamping torque	Torque key
R220.69-..	–	26.6IN.LBS	T00-10P30
R220.69-..L4	LUBRICATIONSET29	26.6IN.LBS	T00-10P30

Torque and fixed keys, see page 894

Turbo 12 – R217/220.69-12 – Metric

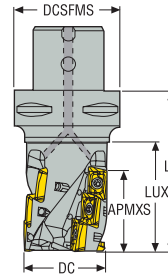

- For insert selection and cutting data recommendations, see page(s) 150-152
- For complete insert programme, see page(s) 869, 870
- For ISO attribute explanation, see page 16
- KAPRS 90°

Designation	Item number	Type of mounting	DC	ZEFP	ZNP	APMXS	DCSFMS	LF	LUX	RPMX	Weight	Insert
			mm			mm	mm	mm	mm		kg	
C5-R217.69-032-044-12.3AN	02717844	Seco-Capto	32,0	3	12	44,0	50,0	79,0	56,0	18400	0,7	XO.X12..*
C5-R217.69-032-055-12.3AN	02829929	Seco-Capto	32,0	3	15	55,0	50,0	90,0	67,0	18400	0,7	XO.X12..*
C6-R217.69-040-055-12.3AN	02717917	Seco-Capto	40,0	3	15	55,0	63,0	92,0	67,0	16400	1,1	XO.X12..
C6-R217.69-040-066-12.3AN	02829930	Seco-Capto	40,0	3	18	65,5	63,0	103,0	79,9	16400	1,2	XO.X12..
C4-R217.69-044-033-12.3AN	02717838	Seco-Capto	44,0	3	9	33,0	40,0	68,0	48,0	15500	0,6	XO.X12..
C6-R217.69-050-055-12.4AN	02717918	Seco-Capto	50,0	4	20	55,0	63,0	92,0	67,0	14800	1,4	XO.X12..
C5-R217.69-054-044-12.4AN	02717852	Seco-Capto	54,0	4	16	44,0	50,0	79,0	59,0	13900	1,2	XO.X12..
C6-R217.69-066-044-12.5AN	02717924	Seco-Capto	66,0	5	20	44,0	63,0	81,0	59,0	12000	1,9	XO.X12..
C6-R217.69-050-066-12.4SAN	02717991	Seco-Capto	50,0	4	24	66,0	63,0	101,0	76,0	14800	1,4	XO.X12..
C6-R217.69-050-086-12.5SAN	02829935	Seco-Capto	50,0	5	40	86,0	63,0	119,0	97,0	14800	1,7	XO.X12..
C6-R217.69-050-106-12.5SAN	02829936	Seco-Capto	50,0	5	50	106,0	63,0	140,0	118,0	12000	1,7	XO.X12..
C6-R217.69-063-107-12.5SAN	02829940	Seco-Capto	63,0	5	50	107,0	63,0	140,0	118,0	12000	2,4	XO.X12..

Modification of the cutter body needed for radii > 3,1 mm
* No axial support in the front row for radii > 1,6 mm

Spare Parts, included in delivery

For cutter	Assembly screw	Basic body	Insert key	Insert screw	Replaceable end
Cx-R217.69-Ø32	-	-	H4B-T10P	C03508-T10P	-
Cx-R217.69-Ø40-66	-	-	H4B-T10P	C03509-T10P	-
C6-R217.69-050-066-4SAN	MC6S10X40	C6-R217.69-050-044-12.4BAN	H4B-T10P	C03509-T10P	R220.69-RE050022-12.4AN
C6-R217.69-050-086-5SAN	MC6S10X40	C6-R217.69-050-064-12.5BAN	H4B-T10P	C03509-T10P	R220.69-RE050022-12.5AN
C6-R217.69-050-106-5SAN	MC6S10X40	C6-R217.69-050-084-12.5BAN	H4B-T10P	C03509-T10P	R220.69-RE050022-12.5AN
C6-R217.69-063-5SAN	MC6S10X40	C6-R217.69-063-074-12.5BAN	H4B-T10P	C03509-T10P	R220.69-RE063033-12.5AN

Accessories

For cutter	Coolant kit	Insert clamping torque	Torque key
Cx-R217.69-032-066	-	3.0NM	T00-10P30
C6-R217.69-050-SAN	LUBRICATION_SET_19	3.0NM	T00-10P30
C6-R217.69-063-SAN	-	3.0NM	T00-10P30

Torque and fixed keys, see page 894

Square shoulder and slot milling cutters
Helical milling cutters
Face milling cutters
Disc milling cutters
High feed milling cutters
Copy milling cutters
Plunge milling cutters
Chamfer milling cutters
Spot facing cutters
Inserts

R217/220.69-12 – Insert selection – mm/Inch

SMG		f _z		
		100%	30%	10%
P1	XOMX120408TR-ME08 MP2501	0,12	0,13	0,20
		0,0048	0,0050	0,0080
P2	XOMX120408TR-ME08 MP2501	0,12	0,13	0,20
		0,0048	0,0050	0,0080
P3	XOMX120408TR-ME08 MP2501	0,12	0,13	0,19
		0,0048	0,0050	0,0075
P4	XOMX120408TR-M12 MP2501	0,14	0,15	0,22
		0,0055	0,0060	0,0085
P5	XOMX120408TR-M12 MP2501	0,13	0,15	0,22
		0,0050	0,0060	0,0085
P6	XOMX120408TR-M12 MP2501	0,13	0,15	0,22
		0,0050	0,0060	0,0085
P7	XOMX120408TR-M12 MP2501	0,13	0,15	0,22
		0,0050	0,0060	0,0085
P8	XOMX120408TR-M12 MP2501	0,14	0,15	0,24
		0,0055	0,0060	0,0095
P11	XOMX120408TR-M12 T350M	0,13	0,15	0,22
		0,0050	0,0060	0,0085
P12	XOMX120408TR-M12 T350M	0,090	0,10	0,15
		0,0036	0,0040	0,0060
M1	XOEX120408R-M07 MS2050	0,10	0,11	0,16
		0,0040	0,0044	0,0065
M2	XOEX120408R-M07 MS2050	0,090	0,10	0,15
		0,0036	0,0040	0,0060
M3	XOEX120408R-M07 MS2050	0,070	0,080	0,12
		0,0028	0,0032	0,0048
M4	XOMX120408TR-ME08 MS2050	0,080	0,085	0,13
		0,0032	0,0034	0,0050
M5	XOMX120408TR-ME08 MS2050	0,080	0,085	0,13
		0,0032	0,0034	0,0050
K1	XOMX120408TR-MD13 MK2050	0,16	0,17	0,26
		0,0065	0,0065	0,010
K2	XOMX120408TR-MD13 MK2050	0,15	0,16	0,24
		0,0060	0,0065	0,0095
K3	XOMX120408TR-MD13 MK2050	0,15	0,16	0,24
		0,0060	0,0065	0,0095
K4	XOMX120408TR-MD13 MK2050	0,15	0,16	0,24
		0,0060	0,0065	0,0095
K5	XOMX120408TR-MD13 MK2050	0,13	0,14	0,22
		0,0050	0,0055	0,0085
K6	XOMX120408TR-MD13 MK2050	0,15	0,16	0,24
		0,0060	0,0065	0,0095
K7	XOMX120408TR-MD13 MK2050	0,13	0,14	0,22
		0,0050	0,0055	0,0085
N1	XOEX120408FR-E06 H15	0,11	0,12	0,18
		0,0044	0,0048	0,0070
N2	XOEX120408FR-E06 H15	0,11	0,12	0,18
		0,0044	0,0048	0,0070
N3	XOEX120408FR-E06 H15	0,11	0,12	0,18
		0,0044	0,0048	0,0070
N11	XOEX120408FR-E06 H15	0,11	0,12	0,18
		0,0044	0,0048	0,0070
S1	XOEX120408R-M07 F40M	0,065	0,070	0,10
		0,0026	0,0028	0,0040
S2	XOEX120408R-M07 F40M	0,060	0,065	0,095
		0,0024	0,0026	0,0038
S11	XOEX120408R-M07 MS2050	0,070	0,080	0,12
		0,0028	0,0032	0,0048
S12	XOEX120408R-M07 MS2050	0,070	0,080	0,12
		0,0028	0,0032	0,0048
S13	XOEX120408R-M07 MS2050	0,065	0,070	0,10
		0,0026	0,0028	0,0040
H5	XOMX120408TR-MD13 MP3000	0,10	0,11	0,17
		0,0040	0,0044	0,0065
H8	XOMX120408TR-MD13 MP3000	0,075	0,085	0,13
		0,0030	0,0034	0,0050
H11	XOMX120412TR-MD13 MP3000	0,10	0,11	0,17
		0,0040	0,0044	0,0065
H12	XOMX120408TR-MD13 MP3000	0,075	0,085	0,13
		0,0030	0,0034	0,0050

SMG = Seco material group
f_z = mm/tooth (in/tooth), v_c = m/min (sf/min), a_p/DC = %
All cutting data are start values

R217/220.69-12 – Cutting data $v_c = (m/min)/(sf/min)$

SMG	MP1501			MP2501			MP3000			T350M			F40M			MP2050		
	100%	30%	10%	100%	30%	10%	100%	30%	10%	100%	30%	10%	100%	30%	10%	100%	30%	10%
P1	150	165	175	140	160	170	140	155	165	135	150	160	125	140	150	150	170	180
	490	540	570	460	520	560	460	510	540	445	490	520	410	460	490	490	560	590
P2	145	165	175	140	155	165	135	155	165	130	150	160	125	140	150	150	165	175
	475	540	570	460	510	540	445	510	540	425	490	520	410	460	490	490	540	570
P3	140	155	165	130	150	160	130	145	155	125	140	150	115	130	140	140	160	170
	460	510	540	425	490	520	425	475	510	410	460	490	375	425	460	460	520	560
P4	130	150	160	125	140	150	120	140	150	115	135	140	105	125	135	135	150	160
	425	490	520	410	460	490	395	460	490	375	445	460	345	410	445	445	490	520
P5	130	145	155	120	140	150	120	135	145	115	130	140	105	120	135	130	150	160
	425	475	510	395	460	490	395	445	475	375	425	460	345	395	445	425	490	520
P6	135	155	165	130	145	155	125	145	155	120	140	150	115	130	140	140	155	165
	445	510	540	425	475	510	410	475	510	395	460	490	375	425	460	460	510	540
P7	135	150	160	125	145	155	125	140	150	120	135	145	110	125	135	135	150	160
	445	490	520	410	475	510	410	460	490	395	445	475	360	410	445	445	490	520
P8	130	145	155	120	140	150	120	135	145	115	130	140	105	120	130	130	145	160
	425	475	510	395	460	490	395	445	475	375	425	460	345	395	425	425	475	520
P11	130	150	160	125	140	150	120	135	150	115	135	145	105	125	135	135	150	160
	425	490	520	410	460	490	395	445	490	375	445	475	345	410	445	445	490	520
P12	105	120	130	100	115	125	95	110	125	90	105	115	80	100	110	105	125	135
	345	395	425	330	375	410	310	360	410	295	345	375	260	330	360	345	410	445
M1	—	—	—	120	135	150	120	135	145	115	135	145	110	125	140	130	145	155
	—	—	—	395	445	490	395	445	475	375	445	475	360	410	460	425	475	510
M2	—	—	—	110	125	135	105	125	135	105	120	130	100	115	125	120	135	145
	—	—	—	360	410	445	345	410	445	345	395	425	330	375	410	395	445	475
M3	—	—	—	95	115	125	95	110	125	90	110	120	85	105	115	105	120	130
	—	—	—	310	375	410	310	360	410	295	360	395	280	345	375	345	395	425
M4	—	—	—	80	100	105	80	100	105	75	95	105	70	90	95	90	105	115
	—	—	—	260	330	345	260	330	345	245	310	345	230	295	310	295	345	375
M5	—	—	—	70	85	95	70	85	95	65	85	90	60	75	85	80	95	105
	—	—	—	230	280	310	230	280	310	215	280	295	195	245	280	260	310	345
K1	130	150	160	125	145	155	125	140	150	115	135	145	110	125	135	—	—	—
	425	490	520	410	475	510	410	460	490	375	445	475	360	410	445	—	—	—
K2	125	140	155	120	135	145	115	130	145	110	125	140	105	120	130	—	—	—
	410	460	510	395	445	475	375	425	475	360	410	460	345	395	425	—	—	—
K3	115	130	145	110	125	135	105	120	135	100	115	130	95	110	120	—	—	—
	375	425	475	360	410	445	345	395	445	330	375	425	310	360	395	—	—	—
K4	115	130	140	105	120	135	100	120	130	100	115	125	90	105	115	—	—	—
	375	425	460	345	395	445	330	395	425	330	375	410	295	345	375	—	—	—
K5	85	100	110	75	95	105	75	90	100	70	85	95	60	75	85	—	—	—
	280	330	360	245	310	345	245	295	330	230	280	310	195	245	280	—	—	—
K6	105	120	135	100	115	125	95	110	125	90	105	120	80	100	110	—	—	—
	345	395	445	330	375	410	310	360	410	295	345	395	260	330	360	—	—	—
K7	100	115	125	90	110	120	90	105	115	85	100	110	75	90	100	—	—	—
	330	375	410	295	360	395	295	345	375	280	330	360	245	295	330	—	—	—
N1	—	—	—	—	—	—	240	260	270	—	—	—	230	245	255	—	—	—
	—	—	—	—	—	—	790	850	890	—	—	—	750	800	840	—	—	—
N2	—	—	—	—	—	—	190	205	215	—	—	—	175	190	200	—	—	—
	—	—	—	—	—	—	620	670	710	—	—	—	570	620	660	—	—	—
N3	—	—	—	—	—	—	165	180	190	—	—	—	150	165	175	—	—	—
	—	—	—	—	—	—	540	590	620	—	—	—	490	540	570	—	—	—
N11	—	—	—	—	—	—	170	190	200	—	—	—	160	175	185	—	—	—
	—	—	—	—	—	—	560	620	660	—	—	—	520	570	610	—	—	—
S1	—	—	—	42	55	65	39	55	60	37	49	55	34	45	50	48	65	75
	—	—	—	140	180	215	130	180	195	120	160	180	110	150	165	155	215	245
S2	—	—	—	34	44	50	32	42	49	30	39	46	27	36	42	38	50	60
	—	—	—	110	145	165	105	140	160	100	130	150	90	120	140	125	165	195
S3	—	—	—	29	39	45	28	37	43	26	34	40	24	31	37	34	44	50
	—	—	—	95	130	150	90	120	140	85	110	130	80	100	120	110	145	165
S11	—	—	—	60	75	85	55	70	80	50	70	75	47	60	70	65	85	95
	—	—	—	195	245	280	180	230	260	165	230	245	155	195	230	215	280	310
S12	—	—	—	40	55	60	38	50	60	36	47	55	32	43	50	47	60	70
	—	—	—	130	180	195	125	165	195	120	155	180	105	140	165	155	195	230
S13	—	—	—	23	31	36	22	30	34	21	28	32	19	25	29	27	35	42
	—	—	—	75	100	120	70	100	110	70	90	105	60	80	95	90	115	140
H5	42	55	65	34	45	55	34	44	55	33	43	50	28	37	44	—	—	—
	140	180	215	110	150	180	110	145	180	110	140	165	90	120	145	—	—	—
H8	45	60	70	36	48	55	36	48	55	35	46	55	30	40	47	—	—	—
	150	195	230	120	155	180	120	155	180	115	150	180	100	130	155	—	—	—
H11	55	70	80	43	55	65	43	55	65	42	55	65	36	48	55	50	65	75
	180	230	260	140	180	215	140	180	215	140	180	215	120	155	180	165	215	245
H12	80	95	105	70	90	95	70	85	95	65	80	90	55	70	80	80	95	105
	260	310	345	230	295	310	230	280	310	215	260	295	180	230	260	260	310	345

Square shoulder and slot milling cutters
Helical milling cutters
Face milling cutters
Disc milling cutters
High feed milling cutters
Copy milling cutters
Plunge milling cutters
Chamfer milling cutters
Spot facing cutters
Inserts

R217/220.69-12 – Cutting data $v_c = (m/min)/(sf/min)$

SMG	MK1500			MK2050			MS2500			MS2050			H15		
	100%	30%	10%	100%	30%	10%	100%	30%	10%	100%	30%	10%	100%	30%	10%
P1	—	—	—	155	175	185	170	185	195	150	170	180	—	—	—
	—	—	—	510	570	610	560	610	640	490	560	590	—	—	—
P2	—	—	—	155	175	185	165	185	195	150	165	180	—	—	—
	—	—	—	510	570	610	540	610	640	490	540	590	—	—	—
P3	—	—	—	145	165	175	155	175	185	140	155	170	—	—	—
	—	—	—	475	540	570	510	570	610	460	510	560	—	—	—
P4	—	—	—	135	155	165	150	165	180	130	150	160	—	—	—
	—	—	—	445	510	540	490	540	590	425	490	520	—	—	—
P5	—	—	—	135	155	165	145	165	175	125	145	155	—	—	—
	—	—	—	445	510	540	475	540	570	410	475	510	—	—	—
P6	—	—	—	145	160	175	155	170	185	135	155	165	—	—	—
	—	—	—	475	520	570	510	560	610	445	510	540	—	—	—
P7	—	—	—	140	160	170	150	170	180	130	150	160	—	—	—
	—	—	—	460	520	560	490	560	590	425	490	520	—	—	—
P8	—	—	—	135	155	165	145	165	175	125	145	155	—	—	—
	—	—	—	445	510	540	475	540	570	410	475	510	—	—	—
P11	—	—	—	140	155	165	150	165	175	130	150	160	—	—	—
	—	—	—	460	510	540	490	540	570	425	490	520	—	—	—
P12	—	—	—	110	125	140	120	135	150	100	120	130	—	—	—
	—	—	—	360	410	460	395	445	490	330	395	425	—	—	—
M1	—	—	—	—	—	—	145	160	175	135	150	165	—	—	—
	—	—	—	—	—	—	475	520	570	445	490	540	—	—	—
M2	—	—	—	—	—	—	130	150	160	120	140	150	—	—	—
	—	—	—	—	—	—	425	490	520	395	460	490	—	—	—
M3	—	—	—	—	—	—	115	135	145	105	125	135	—	—	—
	—	—	—	—	—	—	375	445	475	345	410	445	—	—	—
M4	—	—	—	—	—	—	100	115	130	90	105	120	—	—	—
	—	—	—	—	—	—	330	375	425	295	345	395	—	—	—
M5	—	—	—	—	—	—	85	105	115	75	95	105	—	—	—
	—	—	—	—	—	—	280	345	375	245	310	345	—	—	—
K1	155	175	185	160	180	190	—	—	—	—	—	—	—	—	—
	510	570	610	520	590	620	—	—	—	—	—	—	—	—	—
K2	150	165	180	155	170	180	—	—	—	—	—	—	—	—	—
	490	540	590	510	560	590	—	—	—	—	—	—	—	—	—
K3	135	155	170	140	160	170	—	—	—	—	—	—	—	—	—
	445	510	560	460	520	560	—	—	—	—	—	—	—	—	—
K4	135	155	165	140	155	170	—	—	—	—	—	—	—	—	—
	445	510	540	460	510	560	—	—	—	—	—	—	—	—	—
K5	100	120	130	105	125	135	—	—	—	—	—	—	—	—	—
	330	395	425	345	410	445	—	—	—	—	—	—	—	—	—
K6	125	145	155	130	150	160	—	—	—	—	—	—	—	—	—
	410	475	510	425	490	520	—	—	—	—	—	—	—	—	—
K7	120	135	150	120	140	150	—	—	—	—	—	—	—	—	—
	395	445	490	395	460	490	—	—	—	—	—	—	—	—	—
N1	—	—	—	—	—	—	—	—	—	—	—	—	260	280	290
	—	—	—	—	—	—	—	—	—	—	—	—	850	920	950
N2	—	—	—	—	—	—	—	—	—	—	—	—	200	220	230
	—	—	—	—	—	—	—	—	—	—	—	—	660	720	750
N3	—	—	—	—	—	—	—	—	—	—	—	—	175	195	205
	—	—	—	—	—	—	—	—	—	—	—	—	570	640	670
N11	—	—	—	—	—	—	—	—	—	—	—	—	185	200	215
	—	—	—	—	—	—	—	—	—	—	—	—	610	660	710
S1	—	—	—	—	—	—	55	70	80	44	55	70	—	—	—
	—	—	—	—	—	—	180	230	260	145	180	230	—	—	—
S2	—	—	—	—	—	—	43	55	65	35	46	55	—	—	—
	—	—	—	—	—	—	140	180	215	115	150	180	—	—	—
S3	—	—	—	—	—	—	38	49	60	31	40	48	—	—	—
	—	—	—	—	—	—	125	160	195	100	130	155	—	—	—
S11	—	—	—	—	—	—	75	90	105	60	80	90	—	—	—
	—	—	—	—	—	—	245	295	345	195	260	295	—	—	—
S12	—	—	—	—	—	—	50	70	80	43	55	65	—	—	—
	—	—	—	—	—	—	165	230	260	140	180	215	—	—	—
S13	—	—	—	—	—	—	30	39	47	24	32	38	—	—	—
	—	—	—	—	—	—	100	130	155	80	105	125	—	—	—
H5	—	—	—	—	—	—	—	—	—	—	—	—	—	—	—
	—	—	—	—	—	—	—	—	—	—	—	—	—	—	—
H8	—	—	—	—	—	—	—	—	—	—	—	—	—	—	—
	—	—	—	—	—	—	—	—	—	—	—	—	—	—	—
H11	—	—	—	—	—	—	—	—	—	—	—	—	—	—	—
	—	—	—	—	—	—	—	—	—	—	—	—	—	—	—
H12	—	—	—	—	—	—	—	—	—	—	—	—	—	—	—
	—	—	—	—	—	—	—	—	—	—	—	—	—	—	—

Turbo 16 – R217.69-16 – Metric

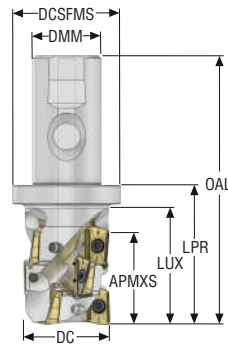

- For insert selection and cutting data recommendations, see page(s) 157-159
- For complete insert programme, see page(s) 871, 872
- For ISO attribute explanation, see page 16
- KAPRS 90°

Designation	Item number	Type of mounting	DC	ZEFP	ZNP	APMXS	DMM	DCSFMS	LUX	LPR	OAL	RPMX	Weight	Insert
			mm			mm	mm	mm	mm	mm	mm		kg	
R217.69-3240.3S-043-XO16.3A	10067004	Seco-Weldon	40,0	3	9	43,0	32,0	50,0	54,9	65,0	125,0	13200	0,2	XO.X16
R217.69-3240.3S-071-XO16.3A	10067005	Seco-Weldon	40,0	3	15	71,0	32,0	50,0	85,4	95,0	155,0	13200	0,2	XO.X16
R217.69-3250.3S-057-XO16.3A	10067006	Seco-Weldon	50,0	3	12	57,0	32,0	50,0	70,8	80,0	140,0	11800	1,0	XO.X16
R217.69-3250.3S-057-XO16.4A	10067007	Seco-Weldon	50,0	4	16	57,0	32,0	50,0	70,8	80,0	140,0	11800	0,2	XO.X16
R217.69-3250.3S-085-XO16.4A	10067008	Seco-Weldon	50,0	4	24	85,0	32,0	50,0	95,8	105,0	165,0	11800	1,4	XO.X16

Modification of the cutter body needed for radii > 3,1 mm

Spare Parts, included in delivery

For cutter	Insert key	Insert screw
R217.69-3240	H4B-T15P	C04009-T15P
R217.69-3250	H4B-T15P	C04011-T15P

Accessories

For cutter	Insert clamping torque	Key	Screw	Torque key
R217.69-..	3.5NM	T05P-2	SX2035-T05P	T00-15P35

Torque and fixed keys, see page 894

Square shoulder and slot milling cutters

Helical milling cutters

Face milling cutters

Disc milling cutters

High feed milling cutters

Copy milling cutters

Plunge milling cutters

Chamfer milling cutters

Spot facing cutters

Inserts

Turbo 16 – R217.69-16 – Inch

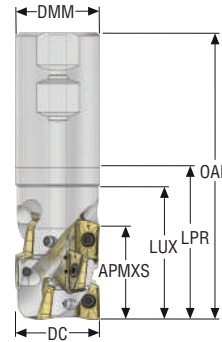

- For insert selection and cutting data recommendations, see page(s) 157-159
- For complete insert programme, see page(s) 871, 872
- For ISO attribute explanation, see page 16
- KAPRS 90°

Designation	Item number	Type of mounting	DC	ZEFP	ZNP	APMXS	DMM	LUX	LPR	OAL	RPMX	Weight	Insert
			inch			inch	inch	inch	inch	inch		lbs	
R217.69-01.50-3-1.69-XO16-3A	10067015	Weldon	1.500	3	9	1.693	1.500	2.417	2.441	5.169	13200	2.200	XO.X16
R217.69-02.00-3-1.69-XO16-3A	10067016	Weldon	2.000	3	9	1.693	2.000	2.512	2.535	5.823	13200	4.190	XO.X16
R217.69-02.00-3-2.24-XO16-4A	10067017	Weldon	2.000	4	16	2.244	2.000	3.130	3.035	6.323	11800	4.410	XO.X16

Modification of the cutter body needed for radii > 0.122 in

Spare Parts, included in delivery

For cutter	Insert key	Insert screw
R217.69-01.50	H4B-T15P	C04009-T15P
R217.69-02.00.3A	H4B-T15P	C04009-T15P
R217.69-02.00.4A	H4B-T15P	C04011-T15P

Accessories

For cutter	Insert clamping torque	Key	Screw	Torque key
R217.69-..	31.0IN.LBS	T05P-2	SX2035-T05P	T00-15P35

Torque and fixed keys, see page 894

Helical Turbo 16 – R217/220.69-16 – Metric

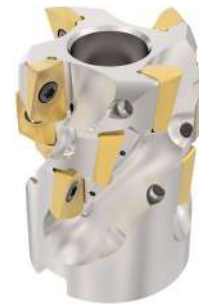
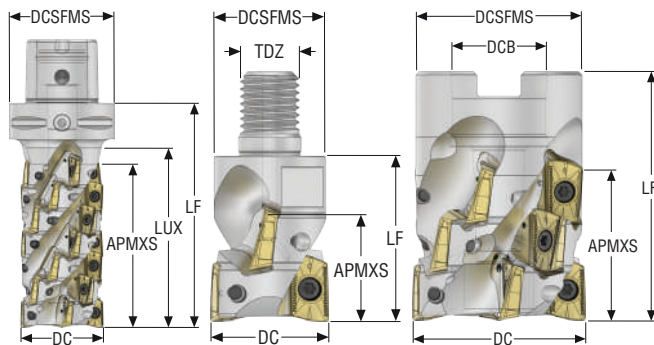

- For insert selection and cutting data recommendations, see page(s) 157-159
- For complete insert programme, see page(s) 871, 872
- For ISO attribute explanation, see page 16
- KAPRS 90°

Designation	Item number	Type of mounting	DC	ZEFP	ZNP	APMXS	DCB	DCSFMS	LF	LUX	RPMX	Weight	Insert
			mm			mm	mm	mm	mm	mm		kg	
C6-R217.69-050-098-XO16.4A	10067022	Seco-Capto	50,0	4	28	98,0	–	63,0	135,0	110,4	11800	2,5	XO.X16
R217.69-1632.RE-029-XO16.2A	10067002	Combimaster	32,0	2	4	29,0	–	30,0	45,0	–	14800	0,6	XO.X16
R217.69-2040.RE-029-XO16.3A	10067003	Combimaster	40,0	3	6	29,0	–	36,5	55,0	–	13200	0,6	XO.X16
R220.69-0050-043-XO16.4A	10067009	Arbor	50,0	4	12	43,0	27,0	46,0	72,0	–	11800	0,2	XO.X16
R220.69-0063-043-XO16.4A	10067010	Arbor	63,0	4	12	43,0	27,0	58,0	70,0	–	10500	1,2	XO.X16
R220.69-0063-057-XO16.5A	10067011	Arbor	63,0	5	20	57,0	27,0	58,0	80,0	–	10500	1,0	XO.X16
R220.69-0063-085-XO16.5SA	10067024	Arbor	63,0	5	30	85,0	27,0	58,0	108,9	–	10500	1,6	XO.X16
R220.69-0080-071-XO16.5A	10067012	Arbor	80,0	5	25	71,0	32,0	75,0	95,0	–	9300	1,0	XO.X16
R220.69-0080-071-XO16.6A	10067013	Arbor	80,0	6	30	71,0	32,0	75,0	95,0	–	9300	1,2	XO.X16
R220.69-0100-071-XO16.6A	10067014	Arbor	100,0	6	30	71,0	40,0	88,0	95,0	–	8300	4,3	XO.X16

Modification of the cutter body needed for radii > 3,1 mm

Spare Parts, included in delivery

For cutter	Arbor screw	Assembly screw	Basic body	Insert key	Insert screw	Replaceable end
Cx-R217.69-..	–	–	–	H4B-T15P	C04011-T15P	–
R217.69-1632-2040	–	–	–	H4B-T15P	C04009-T15P	–
R220.69-0050	MC6S12X60	–	–	H4B-T15P	C04009-T15P	–
R220.69-0063.4A	MC6S12X60	–	–	H4B-T15P	C04011-T15P	–
R220.69-0063.5A	MC6S12X70	–	–	H4B-T15P	C04011-T15P	–
R220.69-0063SA	MC6S12X40	MC6S5X35	R220.69-0063-057-XO16.5BA	H4B-T15P	C04011-T15P	R220.69-RE063-029-XO16.5A
R220.69-0080	MP6S16X80	–	–	H4B-T15PL	C04011-T15P	–
R220.69-0100	MP6S20X80	–	–	H4B-T15PL	C04011-T15P	–

Accessories

For cutter	Insert clamping torque	Key	Screw	Torque key
R217/220.69-..	3.5NM	T05P-2	SX2035-T05P	T00-15P35

Torque and fixed keys, see page 894

Turbo 16 – 220.69-16 – Inch

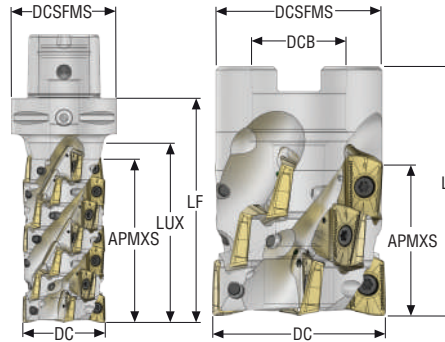
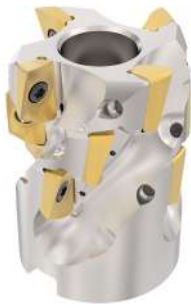

- For insert selection and cutting data recommendations, see page(s) 157-159
- For complete insert programme, see page(s) 871, 872
- For ISO attribute explanation, see page 16
- KAPRS 90°

Designation	Item number	Type of mounting	DC	ZEFP	ZNP	APMXS	DCB	DCSFMS	LF	LUX	RPMX	Weight	Insert
			inch			inch	inch	inch	inch	inch		lbs	
C6-R217.69-02.00-3.89-XO16-4A	10067023	Seco-Capto	2.000	4	28	3.858	–	2.480	5.350	4.382	11800	0.440	XO.X16
R220.69-02.00-1.69-XO16-4A	10067018	Arbor	2.000	4	12	1.693	1.000	1.850	2.750	–	11800	1.320	XO.X16
R220.69-02.50-1.69-XO16-4A	10067019	Arbor	2.500	4	12	1.693	1.000	2.283	2.750	–	10500	1.100	XO.X16
R220.69-02.50-2.24-XO16-5A	10067020	Arbor	2.500	5	20	2.244	1.000	2.283	3.250	–	10500	2.650	XO.X16
R220.69-02.50-3.34-XO16-5SA	10155391	Arbor	2.500	5	30	3.346	1.000	2.283	4.280	–	10500	3.090	XO.X16
R220.69-03.00-2.79-XO16-5A	10067021	Arbor	3.000	5	25	2.795	1.250	2.795	3.750	–	9300	2.200	XO.X16

Modification of the cutter body needed for radii > 3,1 mm

Spare Parts, included in delivery

For cutter	Arbor screw	Assembly screw	Basic body	Insert key	Insert screw	Replaceable end
C6-R217.69-...	–	–	–	H4B-T15P	C04011-T15P	–
R220.69-02.00	UC6S1/2UNFX2-1/2	–	–	H4B-T15P	C04009-T15P	–
R220.69-02.50.4A	UC6S1/2UNFX2-1/2	–	–	H4B-T15P	C04011-T15P	–
R220.69-02.50.5A	UC6S1/2UNFX3	–	–	H4B-T15P	C04011-T15P	–
R220.69-02.50-3.34	UC6S1/2UNFX1-1/2M	UC6S10UNFX1-1/2	R220.69-02.50-2.24-XO16-5BA	1/4HEX-T15PX50	C04011-T15P	R220.69-RE02.50-1.14-XO16-5A
R220.69-03.00	UP6S5/8UNFX3-1/4	–	–	H4B-T15PL	C04011-T15P	–

Accessories

For cutter	Adjustable Torque key	Insert clamping torque	Key	Screw	Torque key
C6-R217/220.69-02.00-03.00	–	31.0IN.LBS	T05P-2	SX2035-T05P	T00-15P35
C6-R217/220.69-02.50-SA	1/4HEX-S-HANDLE-0.8-5.0NM	31.0IN.LBS	T05P-2	SX2035-T05P	–

Torque and fixed keys, see page 894

R217/220.69-16 – Insert selection – Metric / Inch

SMG		f _z		
		100%	30%	10%
P1	XOMX160508TR-ME11 MP2501	0,13	0,15	0,22
		0,0050	0,0060	0,0085
P2	XOMX160508TR-ME11 MP2501	0,14	0,15	0,22
		0,0055	0,0060	0,0085
P3	XOMX160508TR-M13 MP2501	0,15	0,17	0,25
		0,0060	0,0065	0,010
P4	XOMX160508TR-M13 MP2501	0,15	0,16	0,25
		0,0060	0,0065	0,010
P5	XOMX160508TR-MD14 MP1501	0,16	0,17	0,26
		0,0065	0,0065	0,010
P6	XOMX160508TR-MD14 MP1501	0,16	0,17	0,26
		0,0065	0,0065	0,010
P7	XOMX160508TR-MD14 MP1501	0,16	0,17	0,26
		0,0065	0,0065	0,010
P8	XOMX160508TR-MD14 MP1501	0,16	0,18	0,28
		0,0065	0,0070	0,011
P11	XOMX160508TR-ME11 MP2050	0,12	0,13	0,20
		0,0048	0,0050	0,0080
P12	XOMX160508TR-ME11 MS2050	0,085	0,090	0,14
		0,0034	0,0036	0,0055
M1	XOMX160508R-M09 MS2050	0,11	0,12	0,19
		0,0044	0,0048	0,0075
M2	XOMX160508R-M09 MS2050	0,10	0,11	0,17
		0,0040	0,0044	0,0065
M3	XOMX160508R-M09 MS2050	0,080	0,090	0,13
		0,0032	0,0036	0,0050
M4	XOMX160508TR-ME11 MP2050	0,085	0,095	0,14
		0,0034	0,0038	0,0055
M5	XOMX160508TR-ME11 MP2050	0,085	0,095	0,14
		0,0034	0,0038	0,0055
K1	XOMX160508TR-M13 MK2050	0,16	0,17	0,26
		0,0065	0,0065	0,010
K2	XOMX160508TR-M13 MK2050	0,15	0,16	0,24
		0,0060	0,0065	0,0095
K3	XOMX160508TR-MD14 MK2050	0,16	0,17	0,26
		0,0065	0,0065	0,010
K4	XOMX160508TR-MD14 MK2050	0,16	0,17	0,26
		0,0065	0,0065	0,010
K5	XOMX160508TR-MD14 MK2050	0,14	0,15	0,24
		0,0055	0,0060	0,0095
K6	XOMX160508TR-MD14 MK2050	0,16	0,17	0,26
		0,0065	0,0065	0,010
K7	XOMX160508TR-MD14 MK2050	0,14	0,15	0,24
		0,0055	0,0060	0,0095
N1	XOEX160508FR-E07 H25	0,11	0,12	0,18
		0,0044	0,0048	0,0070
N2	XOEX160508FR-E07 H25	0,11	0,12	0,18
		0,0044	0,0048	0,0070
N3	XOEX160508FR-E07 H25	0,11	0,12	0,18
		0,0044	0,0048	0,0070
N11	XOEX160508FR-E07 H25	0,11	0,12	0,18
		0,0044	0,0048	0,0070
S1	XOMX160508TR-ME11 MP2050	0,085	0,095	0,14
		0,0034	0,0038	0,0055
S2	XOMX160508TR-ME11 MP2050	0,085	0,095	0,14
		0,0034	0,0038	0,0055
S3	XOMX160508TR-ME11 MP2050	0,080	0,085	0,13
		0,0032	0,0034	0,0050
S11	XOMX160508TR-ME11 MS2050	0,10	0,11	0,16
		0,0040	0,0044	0,0065
S12	XOMX160508TR-ME11 MS2050	0,10	0,11	0,16
		0,0040	0,0044	0,0065
S13	XOMX160508TR-ME11 MS2050	0,085	0,095	0,14
		0,0034	0,0038	0,0055
H5	XOMX160508TR-MD14 MP3000	0,11	0,12	0,18
		0,0044	0,0048	0,0070
H11	XOMX160508TR-MD14 MP3000	0,11	0,12	0,18
		0,0044	0,0048	0,0070
H12	XOMX160508TR-ME11 MP2050	0,065	0,070	0,11
		0,0026	0,0028	0,0044

SMG = Seco material group
f_z = mm/tooth (in/tooth), v_c = m/min (sf/min), a_p/DC = %
All cutting data are start values

Square shoulder and slot milling cutters
Helical milling cutters
Face milling cutters
Disc milling cutters
High feed milling cutters
Copy milling cutters
Plunge milling cutters
Chamfer milling cutters
Spot facing cutters
Inserts

R217/220.69-16 – Cutting data $v_c = (m/min)/(sf/min)$

SMG	MP1501			MP2501			MP3000			MK1500			MK2050		
	100%	30%	10%	100%	30%	10%	100%	30%	10%	100%	30%	10%	100%	30%	10%
P1	170	190	205	160	185	195	155	180	190	—	—	—	155	180	190
	560	620	670	520	610	640	510	590	620	—	—	—	510	590	620
P2	170	190	205	160	180	195	155	175	190	—	—	—	155	175	190
	560	620	670	520	590	640	510	570	620	—	—	—	510	570	620
P3	160	180	195	150	170	185	145	165	180	—	—	—	145	165	180
	520	590	640	490	560	610	475	540	590	—	—	—	475	540	590
P4	150	170	185	140	160	175	135	160	170	—	—	—	135	155	170
	490	560	610	460	520	570	445	520	560	—	—	—	445	510	560
P5	145	165	180	135	160	170	130	155	165	—	—	—	130	155	165
	475	540	590	445	520	560	425	510	540	—	—	—	425	510	540
P6	155	175	190	145	165	180	145	165	175	—	—	—	140	160	175
	510	570	620	475	540	590	475	540	570	—	—	—	460	520	570
P7	150	170	185	140	165	175	140	160	170	—	—	—	135	160	170
	490	560	610	460	540	570	460	520	560	—	—	—	445	520	560
P8	145	165	180	135	155	170	130	155	165	—	—	—	130	150	165
	475	540	590	445	510	560	425	510	540	—	—	—	425	490	540
P11	150	170	185	140	160	175	135	155	170	—	—	—	135	155	170
	490	560	610	460	520	570	445	510	560	—	—	—	445	510	560
P12	115	140	150	110	130	140	105	125	135	—	—	—	100	125	135
	375	460	490	360	425	460	345	410	445	—	—	—	330	410	445
M1	—	—	—	135	155	170	135	155	170	—	—	—	—	—	—
	—	—	—	445	510	560	445	510	560	—	—	—	—	—	—
M2	—	—	—	120	140	155	120	140	155	—	—	—	—	—	—
	—	—	—	395	460	510	395	460	510	—	—	—	—	—	—
M3	—	—	—	105	125	140	105	125	140	—	—	—	—	—	—
	—	—	—	345	410	460	345	410	460	—	—	—	—	—	—
M4	—	—	—	85	110	120	85	105	120	—	—	—	—	—	—
	—	—	—	280	360	395	280	345	395	—	—	—	—	—	—
M5	—	—	—	75	95	105	70	95	105	—	—	—	—	—	—
	—	—	—	245	310	345	230	310	345	—	—	—	—	—	—
K1	150	175	185	140	165	175	140	160	170	170	190	205	160	180	195
	490	570	610	460	540	570	460	520	560	560	620	670	520	590	640
K2	140	165	175	135	155	165	130	150	165	160	180	195	150	175	185
	460	540	570	445	510	540	425	490	540	520	590	640	490	570	610
K3	130	150	165	120	140	155	115	140	150	145	170	180	140	160	175
	425	490	540	395	460	510	375	460	490	475	560	590	460	520	570
K4	125	145	160	115	140	150	110	135	145	145	165	180	135	155	170
	410	475	520	375	460	490	360	445	475	475	540	590	445	510	560
K5	90	110	125	80	100	115	75	100	110	105	130	140	100	120	130
	295	360	410	260	330	375	245	330	360	345	425	460	330	395	425
K6	115	140	150	105	130	140	105	125	140	135	155	170	125	145	160
	375	460	490	345	425	460	345	410	460	445	510	560	410	475	520
K7	110	130	140	100	120	135	95	115	130	125	145	160	115	140	150
	360	425	460	330	395	445	310	375	425	410	475	520	375	460	490
N1	—	—	—	—	—	—	285	310	320	—	—	—	—	—	—
	—	—	—	—	—	—	940	1025	1050	—	—	—	—	—	—
N2	—	—	—	—	—	—	220	240	255	—	—	—	—	—	—
	—	—	—	—	—	—	720	790	840	—	—	—	—	—	—
N3	—	—	—	—	—	—	190	210	225	—	—	—	—	—	—
	—	—	—	—	—	—	620	690	740	—	—	—	—	—	—
N11	—	—	—	—	—	—	200	220	235	—	—	—	—	—	—
	—	—	—	—	—	—	660	720	770	—	—	—	—	—	—
S1	—	—	—	43	55	65	41	55	65	—	—	—	—	—	—
	—	—	—	140	180	215	135	180	215	—	—	—	—	—	—
S2	—	—	—	35	46	55	33	43	50	—	—	—	—	—	—
	—	—	—	115	150	180	110	140	165	—	—	—	—	—	—
S3	—	—	—	30	40	47	29	38	44	—	—	—	—	—	—
	—	—	—	100	130	155	95	125	145	—	—	—	—	—	—
S11	—	—	—	60	80	90	55	75	85	—	—	—	—	—	—
	—	—	—	195	260	295	180	245	280	—	—	—	—	—	—
S12	—	—	—	41	55	65	38	50	60	—	—	—	—	—	—
	—	—	—	135	180	215	125	165	195	—	—	—	—	—	—
S13	—	—	—	24	32	37	23	30	35	—	—	—	—	—	—
	—	—	—	80	105	120	75	100	115	—	—	—	—	—	—
H5	44	60	70	35	46	55	34	45	55	—	—	—	—	—	—
	145	195	230	115	150	180	110	150	180	—	—	—	—	—	—
H11	55	75	85	45	60	70	44	60	70	—	—	—	—	—	—
	180	245	280	150	195	230	145	195	230	—	—	—	—	—	—
H12	85	105	115	75	95	105	70	90	105	—	—	—	—	—	—
	280	345	375	245	310	345	230	295	345	—	—	—	—	—	—

R217/220.69-16 – Cutting data $v_c = (m/min)/(sf/min)$

SMG	MS2050			MP2050			MS2500			T350M			F40M			H25		
	100%	30%	10%	100%	30%	10%	100%	30%	10%	100%	30%	10%	100%	30%	10%	100%	30%	10%
P1	160	180	190	170	190	205	180	200	215	150	175	185	140	160	175	—	—	—
	520	590	620	560	620	670	590	660	710	490	570	610	460	520	570	—	—	—
P2	155	175	190	165	190	200	175	200	210	150	170	185	140	160	175	—	—	—
	510	570	620	540	620	660	570	660	690	490	560	610	460	520	570	—	—	—
P3	145	165	180	155	180	190	170	190	200	140	160	175	130	150	165	—	—	—
	475	540	590	510	590	620	560	620	660	460	520	570	425	490	540	—	—	—
P4	135	155	170	150	170	180	160	180	190	130	150	165	120	140	155	—	—	—
	445	510	560	490	560	590	520	590	620	425	490	540	395	460	510	—	—	—
P5	135	155	165	145	165	180	155	175	190	125	150	160	115	135	150	—	—	—
	445	510	540	475	540	590	510	570	620	410	490	520	375	445	490	—	—	—
P6	140	165	175	155	175	190	165	185	195	135	155	170	125	145	160	—	—	—
	460	540	570	510	570	620	540	610	640	445	510	560	410	475	520	—	—	—
P7	140	160	170	150	170	185	160	180	190	130	150	165	120	140	155	—	—	—
	460	520	560	490	560	610	520	590	620	425	490	540	395	460	510	—	—	—
P8	130	155	165	145	165	180	155	175	185	125	145	160	115	135	150	—	—	—
	425	510	540	475	540	590	510	570	610	410	475	520	375	445	490	—	—	—
P11	135	155	170	150	170	180	155	180	190	130	150	165	120	140	155	—	—	—
	445	510	560	490	560	590	510	590	620	425	490	540	395	460	510	—	—	—
P12	105	125	135	115	135	150	125	145	160	100	120	130	85	110	120	—	—	—
	345	410	445	375	445	490	410	475	520	330	395	425	280	360	395	—	—	—
M1	140	160	175	140	165	175	150	175	185	130	150	165	120	145	155	—	—	—
	460	520	570	460	540	570	490	570	610	425	490	540	395	475	510	—	—	—
M2	125	145	160	130	150	165	140	160	170	115	135	150	110	130	145	—	—	—
	410	475	520	425	490	540	460	520	560	375	445	490	360	425	475	—	—	—
M3	110	130	145	115	135	145	120	140	155	100	120	135	90	115	125	—	—	—
	360	425	475	375	445	475	395	460	510	330	395	445	295	375	410	—	—	—
M4	90	110	125	95	115	130	105	125	135	80	105	115	75	95	110	—	—	—
	295	360	410	310	375	425	345	410	445	260	345	375	245	310	360	—	—	—
M5	75	100	110	80	100	115	90	110	120	70	90	100	60	80	95	—	—	—
	245	330	360	260	330	375	295	360	395	230	295	330	195	260	310	—	—	—
K1	—	—	—	—	—	—	—	—	—	130	155	165	120	145	155	—	—	—
	—	—	—	—	—	—	—	—	—	425	510	540	395	475	510	—	—	—
K2	—	—	—	—	—	—	—	—	—	120	145	155	110	135	145	—	—	—
	—	—	—	—	—	—	—	—	—	395	475	510	360	445	475	—	—	—
K3	—	—	—	—	—	—	—	—	—	110	130	145	100	120	135	—	—	—
	—	—	—	—	—	—	—	—	—	360	425	475	330	395	445	—	—	—
K4	—	—	—	—	—	—	—	—	—	105	130	140	95	115	130	—	—	—
	—	—	—	—	—	—	—	—	—	345	425	460	310	375	425	—	—	—
K5	—	—	—	—	—	—	—	—	—	70	90	105	60	80	95	—	—	—
	—	—	—	—	—	—	—	—	—	230	295	345	195	260	310	—	—	—
K6	—	—	—	—	—	—	—	—	—	95	120	130	85	110	120	—	—	—
	—	—	—	—	—	—	—	—	—	310	395	425	280	360	395	—	—	—
K7	—	—	—	—	—	—	—	—	—	90	110	125	80	100	110	—	—	—
	—	—	—	—	—	—	—	—	—	295	360	410	260	330	360	—	—	—
N1	—	—	—	—	—	—	—	—	—	—	—	—	270	290	305	290	310	320
	—	—	—	—	—	—	—	—	—	—	—	—	890	950	1000	950	1025	1050
N2	—	—	—	—	—	—	—	—	—	—	—	—	205	225	235	220	240	255
	—	—	—	—	—	—	—	—	—	—	—	—	670	740	770	720	790	840
N3	—	—	—	—	—	—	—	—	—	—	—	—	170	195	205	190	210	225
	—	—	—	—	—	—	—	—	—	—	—	—	560	640	670	620	690	740
N11	—	—	—	—	—	—	—	—	—	—	—	—	180	205	215	200	220	235
	—	—	—	—	—	—	—	—	—	—	—	—	590	670	710	660	720	770
S1	43	55	70	48	60	75	55	70	80	38	50	60	35	46	55	—	—	—
	140	180	230	155	195	245	180	230	260	125	165	195	115	150	180	—	—	—
S2	35	46	55	38	50	60	43	55	65	31	41	48	28	37	44	—	—	—
	115	150	180	125	165	195	140	180	215	100	135	155	90	120	145	—	—	—
S3	31	41	48	34	44	50	38	50	60	27	36	42	25	33	38	—	—	—
	100	135	155	110	145	165	125	165	195	90	120	140	80	110	125	—	—	—
S11	60	80	90	65	85	100	75	95	110	55	70	85	48	65	75	—	—	—
	195	260	295	215	280	330	245	310	360	180	230	280	155	215	245	—	—	—
S12	42	55	65	46	60	70	50	70	80	36	48	60	33	44	55	—	—	—
	140	180	215	150	195	230	165	230	260	120	155	195	110	145	180	—	—	—
S13	24	32	38	27	35	42	30	40	46	22	28	33	20	26	30	—	—	—
	80	105	125	90	115	140	100	130	150	70	90	110	65	85	100	—	—	—
H5	—	—	—	—	—	—	—	—	—	34	44	50	29	39	45	—	—	—
	—	—	—	—	—	—	—	—	—	110	145	165	95	130	150	—	—	—
H11	—	—	—	49	65	75	—	—	—	43	55	65	37	49	60	—	—	—
	—	—	—	160	215	245	—	—	—	140	180	215	120	160	195	—	—	—
H12	—	—	—	80	105	115	90	110	125	65	85	95	55	75	85	—	—	—
	—	—	—	260	345	375	295	360	410	215	280	310	180	245	280	—	—	—

Square shoulder and slot milling cutters
Helical milling cutters
Face milling cutters
Disc milling cutters
High feed milling cutters
Copy milling cutters
Plunge milling cutters
Chamfer milling cutters
Spot facing cutters
Inserts

Turbo 18 – R217.69-18 – Metric

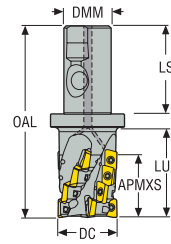

- For insert selection and cutting data recommendations, see page(s) 165-167
- For complete insert programme, see page(s) 873, 874
- For ISO attribute explanation, see page 16
- KAPRS 90°

Designation	Item number	Type of mounting	DC	ZEFP	ZNP	APMXS	DMM	LUX	LS	OAL	RPMX	Weight	Insert
			mm			mm	mm	mm	mm	mm		kg	
R217.69-3240.3S-047-18.2AN	02710003	Seco-Weldon	40,0	2	6	47,0	32,0	57,0	60,0	130,0	9900	0,8	XO.X18..
R217.69-3250.3S-047-18.3AN	02710010	Seco-Weldon	50,0	3	9	47,0	32,0	65,0	60,0	134,5	8900	1,1	XO.X18..

Modification of the cutter body needed for radii > 3,1 mm

Spare Parts, included in delivery

For cutter	Insert key	Insert screw
R217.69-..	H6B-T20P	C04510-T20P

Accessories

For cutter	Insert clamping torque	Torque key
R217.69-..	5.0NM	T00-20P50

Torque and fixed keys, see page 894

Turbo 18 – R217.69-18 – Inch

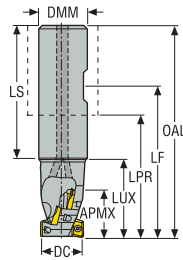



- For insert selection and cutting data recommendations, see page(s) 165-167
- For complete insert programme, see page(s) 873, 874
- For ISO attribute explanation, see page 16
- KAPRS 90°

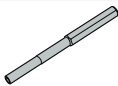

Designation	Item number	Type of mounting	DC	ZEFP	ZNP	APMXS	DMM	LUX	LPR	OAL	RPMX	Weight	Insert
			inch			inch	inch	inch	inch	inch		lbs	
R217.69-01.50-3-18S2AN	02710923	Weldon	1.500	2	6	1.862	1.500	2.618	2.750	5.439	9900	2.200	XO.X18
R217.69-02.00-3-18S3AN	02710934	Weldon	2.000	3	9	1.850	1.500	2.802	2.802	5.491	8900	2.870	XO.X18

Modification of the cutter body needed for radii > 0.122 in

Spare Parts, included in delivery

For cutter	Insert key	Insert screw
		
R217.69-..	H6B-T20P	C04510-T20P

Accessories

For cutter	Insert clamping torque	Torque key
		
R217.69-..	44.3IN.LBS	T00-20P50

Torque and fixed keys, see page 894

Square shoulder and slot milling cutters

Helical milling cutters

Face milling cutters

Disc milling cutters

High feed milling cutters

Copy milling cutters

Plunge milling cutters

Chamfer milling cutters

Spot facing cutters

Inserts

Turbo 18 – R217/220.69-18 – Metric

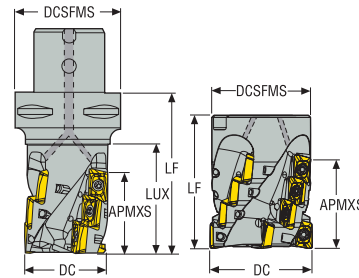





- For insert selection and cutting data recommendations, see page(s) 165-167
- For complete insert programme, see page(s) 873, 874
- For ISO attribute explanation, see page 16
- KAPRS 90°

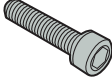

Designation	Item number	Type of mounting	DC	ZEFP	ZNP	APMXS	DCB	DCSFMS	LF	LUX	RPMX	Weight	Insert
			mm			mm	mm	mm	mm	mm		kg	
C5-R217.69-040-047-18.2AN	02717849	Seco-Capto	40,0	2	6	47,0	–	50,0	82,0	58,0	9900	0,8	XO.X18..
C6-R217.69-050-062-18.3AN	02717919	Seco-Capto	50,0	3	12	62,0	–	63,0	99,0	73,0	8900	1,5	XO.X18..
C5-R217.69-054-047-18.3AN	02717916	Seco-Capto	54,0	3	9	47,0	–	50,0	82,0	62,0	8600	1,1	XO.X18..
C6-R217.69-066-047-18.4AN	02717933	Seco-Capto	66,0	4	12	47,0	–	63,0	84,0	62,0	7700	1,7	XO.X18..
C8-R217.69-080-093-18.5SAN	02829948	Seco-Capto	80,0	5	30	93,0	–	80,0	140,0	110,0	7000	4,2	XO.X18..
R220.69-00063-047-18.4AN	02710017	Arbor	63,0	4	12	47,0	27,0	60,0	70,0	–	7900	0,8	XO.X18..
R220.69-00063-062-18.3AN	02710032	Arbor	63,0	3	12	62,0	27,0	60,0	85,0	–	7900	1,1	XO.X18..
R220.69-00063-062-18.4AN	02710034	Arbor	63,0	4	16	62,0	27,0	60,0	85,0	–	7900	1,0	XO.X18..
R220.69-00063-077-18.4SAN	02717825	Arbor	63,0	4	20	77,0	27,0	60,0	100,0	–	7900	1,3	XO.X18..
R220.69-00080-047-18.5AN	02710037	Arbor	80,0	5	15	47,0	32,0	77,0	70,0	–	7000	1,6	XO.X18..
R220.69-00080-062-18.5AN	02710039	Arbor	80,0	5	20	62,0	32,0	77,0	85,0	–	7000	1,9	XO.X18..
R220.69-00080-077-18.4SAN	02717831	Arbor	80,0	4	20	77,0	32,0	77,0	100,0	–	7000	2,4	XO.X18..
R220.69-00100-062-18.6AN	02710042	Arbor	100,0	6	24	62,0	40,0	90,0	85,0	–	6300	3,4	XO.X18..
R220.69-00100-077-18.5SAN	02717833	Arbor	100,0	5	25	77,0	40,0	90,0	100,0	–	6300	4,0	XO.X18..

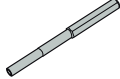
Modification of the cutter body needed for radii > 3,1 mm

Spare Parts, included in delivery

For cutter	Arbor screw	Assembly screw	Basic body	Insert key	Insert screw	Replaceable end
						
Cx-R217.69-..	-	-	-	H6B-T20P	C04510-T20P	-
C8-R217.69-080	-	MC6S16X40	C8-R217.69-080-062-18.5BAN	H6B-T20PL	C04510-T20P	R220.69-RE080031-18.5AN
R220.69-00063	MC6S12X60	-	-	H6B-T20P	C04510-T20P	-
R220.69-00063-SAN	MP6S12X80	-	R220.69-00063046-18.4BAN	H6B-T20P	C04510-T20P	R220.69-RE063031-18.4AN
R220.69-00080	MC6S16X70	-	-	H6B-T20P	C04510-T20P	-
R220.69-00080-SAN	MP6S16X80	-	R220.69-00080046-18.4BAN	H6B-T20PL	C04510-T20P	R220.69-RE080031-18.4AN
R220.69-00100	MC6S20X70	-	-	H6B-T20PL	C04510-T20P	-
R220.69-00100-SAN	MP6S20X80	-	R220.69-00100046-18.5BAN	H6B-T20PL	C04510-T20P	R220.69-RE100031-18.5AN

Accessories

For cutter	Coolant kit	Insert clamping torque	Torque key
			
Cx-R217/220.69-..	-	5.0NM	T00-20P50
R220.69-00063-SAN	LUBRICATION_SET_29	5.0NM	T00-20P50
R220.69-00080-SAN	LUBRICATION_SET_36	5.0NM	T00-20P50
R220.69-00100-SAN	LUBRICATION_SET_44	5.0NM	T00-20P50

Torque and fixed keys, see page 894

Square shoulder and slot milling cutters
Helical milling cutters
Face milling cutters
Disc milling cutters
High feed milling cutters
Copy milling cutters
Plunge milling cutters
Chamfer milling cutters
Spot facing cutters
Inserts

Turbo 18 – R217/220.69-18 – Inch

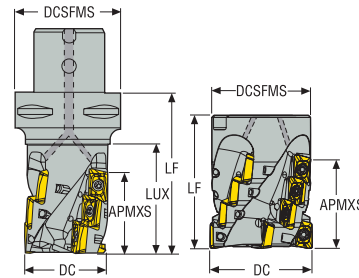

- For insert selection and cutting data recommendations, see page(s) 165-167
- For complete insert programme, see page(s) 873, 874
- For ISO attribute explanation, see page 16
- KAPRS 90°

Designation	Item number	Type of mounting	DC	ZEFP	ZNP	APMXS	DCB	DCSFMS	LF	LUX	RPMX	Weight	Insert
			inch			inch	inch	inch	inch	inch		lbs	
C6-R217.69-02.00-18M3AN	02721715	Seco-Capto	2.000	3	12	2.441	–	2.480	3.898	3.031	8900	2.430	XO.X18
C6-R217.69-02.50-18M4AN	02721716	Seco-Capto	2.500	4	16	2.409	–	2.480	3.898	3.898	7900	3.090	XO.X18
R220.69-02.50-18S4AN	02710940	Arbor	2.500	4	12	1.866	1.000	2.441	2.750	–	7900	2.200	XO.X18
R220.69-02.50-18M4AN	02710937	Arbor	2.500	4	16	2.441	1.000	2.441	3.346	–	7900	2.200	XO.X18
R220.69-02.50-18L4SAN	02722279	Arbor	2.500	4	20	3.024	1.000	2.441	3.937	–	7900	7.720	XO.X18
R220.69-03.00-18M5AN	02710942	Arbor	3.000	5	20	2.480	1.250	2.890	3.500	–	7000	3.970	XO.X18
R220.69-03.00-18L4SAN	02722281	Arbor	3.000	4	20	3.024	1.250	2.890	3.937	–	7000	6.610	XO.X18
R220.69-04.00-18L5SAN	02722282	Arbor	4.000	5	25	3.024	1.500	3.543	3.937	–	6300	8.820	XO.X18

Modification of the cutter body needed for radii > 0.122 in

Spare Parts, included in delivery

For cutter	Arbor screw	Basic body	Insert key	Insert screw	Replaceable end
Cx-R217.69-..	–	–	H6B-T20P	C04510-T20P	–
R220.69-02.50S	UC6S1/2UNFX2-1/2	–	H6B-T20P	C04510-T20P	–
R220.69-02.50M	UC6S1/2UNFX3	–	H6B-T20P	C04510-T20P	–
R220.69-02.50L	UP6S1/2UNFX3-1/4	R220.69-02.50-18L4BAN	H6B-T20P	C04510-T20P	R220.69-02.50-RE-18.4AN
R220.69-03.00M	UC6S5/8UNFX3	–	H6B-T20P	C04510-T20P	–
R220.69-03.00S	UP6S5/8UNFX3-1/4	R220.69-03.00-18L4BAN	H6B-T20PL	C04510-T20P	R220.69-03.00-RE-18.4AN
R220.69-04.00S	UP6S3/4UNFX3-1/4	R220.69-04.00-18L5BAN	H6B-T20PL	C04510-T20P	R220.69-04.00-RE-18.5AN

Accessories

For cutter	Coolant kit	Insert clamping torque	Torque key
Cx-R217/220.69-..	–	44.3IN.LBS	T00-20P50
R220.69-02.50-SAN	LUBRICATIONSET29	44.3IN.LBS	T00-20P50
R220.69-03.00-SAN	LUBRICATIONSET36	44.3IN.LBS	T00-20P50
R220.69-04.00-SAN	LUBRICATIONSET44	44.3IN.LBS	T00-20P50

Torque and fixed keys, see page 894

R217/220.69-18 – Insert selection – mm/Inch

SMG		f _z		
		100%	30%	10%
P1	XOMX180608TR-ME13 MP2501	0,15 0.0060	0,16 0.0065	0,24 0.0095
P2	XOMX180608TR-ME13 MP2501	0,15 0.0060	0,16 0.0065	0,25 0.010
P3	XOMX180608TR-ME13 MP2501	0,14 0.0055	0,15 0.0060	0,24 0.0095
P4	XOMX180608TR-M14 MP2501	0,15 0.0060	0,16 0.0065	0,25 0.010
P5	XOMX180608TR-M14 MP2501	0,15 0.0060	0,16 0.0065	0,24 0.0095
P6	XOMX180608TR-M14 MP2501	0,14 0.0055	0,16 0.0065	0,24 0.0095
P7	XOMX180608TR-M14 MP2501	0,14 0.0055	0,16 0.0065	0,24 0.0095
P8	XOMX180608TR-M14 MP2501	0,15 0.0060	0,17 0.0065	0,25 0.010
P11	XOMX180608TR-M14 T350M	0,14 0.0055	0,16 0.0065	0,24 0.0095
P12	XOMX180608TR-M14 T350M	0,10 0.0040	0,11 0.0044	0,17 0.0065
M1	XOMX180608R-M10 MS2050	0,11 0.0044	0,12 0.0048	0,19 0.0075
M2	XOMX180608R-M10 MS2050	0,10 0.0040	0,11 0.0044	0,17 0.0065
M3	XOMX180608R-M10 MS2050	0,085 0.0034	0,090 0.0036	0,14 0.0055
M4	XOMX180608TR-M14 T350M	0,10 0.0040	0,11 0.0044	0,17 0.0065
M5	XOMX180608TR-M14 T350M	0,10 0.0040	0,11 0.0044	0,17 0.0065
K1	XOMX180608TR-MD15 MK2050	0,17 0.0065	0,19 0.0075	0,28 0.011
K2	XOMX180608TR-MD15 MK2050	0,16 0.0065	0,17 0.0065	0,26 0.010
K3	XOMX180608TR-MD15 MK2050	0,16 0.0065	0,17 0.0065	0,26 0.010
K4	XOMX180608TR-MD15 MK2050	0,16 0.0065	0,17 0.0065	0,26 0.010
K5	XOMX180608TR-MD15 MK2050	0,14 0.0055	0,15 0.0060	0,24 0.0095
K6	XOMX180608TR-MD15 MK2050	0,16 0.0065	0,17 0.0065	0,26 0.010
K7	XOMX180608TR-MD15 MK2050	0,14 0.0055	0,15 0.0060	0,24 0.0095
N1	XOEX180608FR-E10 H25	0,15 0.0060	0,16 0.0065	0,24 0.0095
N2	XOEX180608FR-E10 H25	0,15 0.0060	0,16 0.0065	0,24 0.0095
N3	XOEX180608FR-E10 H25	0,15 0.0060	0,16 0.0065	0,24 0.0095
N11	XOEX180608FR-E10 H25	0,15 0.0060	0,16 0.0065	0,24 0.0095
S1	XOMX180608R-M10 F40M	0,075 0.0030	0,080 0.0032	0,12 0.0048
S2	XOMX180608R-M10 F40M	0,075 0.0030	0,080 0.0032	0,12 0.0048
S3	XOMX180608R-M10 F40M	0,070 0.0028	0,075 0.0030	0,11 0.0044
S11	XOMX180608R-M10 MS2050	0,085 0.0034	0,090 0.0036	0,14 0.0055
S12	XOMX180608R-M10 MS2050	0,085 0.0034	0,090 0.0036	0,14 0.0055
S13	XOMX180608R-M10 MS2050	0,075 0.0030	0,080 0.0032	0,12 0.0048
H5	XOMX180608TR-MD15 MP3000	0,11 0.0044	0,12 0.0048	0,18 0.0070
H8	XOMX180608TR-MD15 MP3000	0,080 0.0032	0,090 0.0036	0,14 0.0055
H11	XOMX180608TR-MD15 MP3000	0,11 0.0044	0,12 0.0048	0,18 0.0070
H12	XOMX180608TR-MD15 MP3000	0,080 0.0032	0,090 0.0036	0,14 0.0055

SMG = Seco material group
f_z = mm/tooth (in/tooth), v_c = m/min (sf/min), a_e/DC = %
All cutting data are start values

Square shoulder and slot milling cutters
Helical milling cutters
Face milling cutters
Disc milling cutters
High feed milling cutters
Copy milling cutters
Plunge milling cutters
Chamfer milling cutters
Spot facing cutters
Inserts

R217/220.69-18 – Cutting data $v_c = (m/min)/(sf/min)$

SMG	MP1501			MP2501			MP3000			T350M			F40M		
	100%	30%	10%	100%	30%	10%	100%	30%	10%	100%	30%	10%	100%	30%	10%
P1	150	165	175	140	160	170	140	155	165	135	150	160	125	140	155
	490	540	570	460	520	560	460	510	540	445	490	520	410	460	510
P2	145	165	175	140	155	170	135	155	165	130	150	160	125	140	150
	475	540	570	460	510	560	445	510	540	425	490	520	410	460	490
P3	140	155	165	130	150	160	130	145	155	125	140	150	115	130	145
	460	510	540	425	490	520	425	475	510	410	460	490	375	425	475
P4	130	150	160	125	140	150	120	140	150	115	135	145	110	125	135
	425	490	520	410	460	490	395	460	490	375	445	475	360	410	445
P5	130	145	155	120	140	150	120	135	145	115	130	140	105	120	135
	425	475	510	395	460	490	395	445	475	375	425	460	345	395	445
P6	135	155	165	130	145	155	125	145	155	120	140	150	115	130	140
	445	510	540	425	475	510	410	475	510	395	460	490	375	425	460
P7	135	150	160	125	145	155	125	140	150	120	135	145	110	125	135
	445	490	520	410	475	510	410	460	490	395	445	475	360	410	445
P8	130	145	155	120	140	150	120	135	145	115	130	140	105	120	130
	425	475	510	395	460	490	395	445	475	375	425	460	345	395	425
P11	130	150	160	125	140	150	120	140	150	115	135	145	110	125	135
	425	490	520	410	460	490	395	460	490	375	445	475	360	410	445
P12	105	125	135	100	115	125	95	110	120	90	105	115	80	100	110
	345	410	445	330	375	410	310	360	395	295	345	375	260	330	360
M1	—	—	—	120	140	150	120	135	145	115	135	145	110	130	140
	—	—	—	395	460	490	395	445	475	375	445	475	360	425	460
M2	—	—	—	110	125	135	105	125	135	105	120	130	100	115	125
	—	—	—	360	410	445	345	410	445	345	395	425	330	375	410
M3	—	—	—	95	115	125	95	110	125	90	110	120	85	105	115
	—	—	—	310	375	410	310	360	410	295	360	395	280	345	375
M4	—	—	—	80	100	110	80	100	110	80	95	105	70	90	100
	—	—	—	260	330	360	260	330	360	260	310	345	230	295	330
M5	—	—	—	70	90	100	70	85	95	65	85	95	60	80	90
	—	—	—	230	295	330	230	280	310	215	280	310	195	260	295
K1	135	150	160	125	145	155	125	140	150	120	135	145	110	125	135
	445	490	520	410	475	510	410	460	490	395	445	475	360	410	445
K2	125	145	155	120	135	145	115	135	145	110	130	140	100	120	130
	410	475	510	395	445	475	375	445	475	360	425	460	330	395	425
K3	115	135	145	110	125	135	105	125	135	100	120	130	90	110	120
	375	445	475	360	410	445	345	410	445	330	395	425	295	360	395
K4	115	130	140	105	125	135	100	120	130	95	115	125	90	105	115
	375	425	460	345	410	445	330	395	425	310	375	410	295	345	375
K5	85	100	110	75	95	105	75	90	100	70	85	95	60	80	85
	280	330	360	245	310	345	245	295	330	230	280	310	195	260	280
K6	105	125	135	100	115	125	95	110	125	90	105	120	80	100	110
	345	410	445	330	375	410	310	360	410	295	345	395	260	330	360
K7	100	115	125	90	110	120	90	105	115	85	100	110	75	90	100
	330	375	410	295	360	395	295	345	375	280	330	360	245	295	330
N1	—	—	—	—	—	—	245	260	270	—	—	—	230	245	255
	—	—	—	—	—	—	800	850	890	—	—	—	750	800	840
N2	—	—	—	—	—	—	190	205	215	—	—	—	175	190	200
	—	—	—	—	—	—	620	670	710	—	—	—	570	620	660
N3	—	—	—	—	—	—	165	180	190	—	—	—	150	165	180
	—	—	—	—	—	—	540	590	620	—	—	—	490	540	590
N11	—	—	—	—	—	—	170	190	200	—	—	—	160	175	185
	—	—	—	—	—	—	560	620	660	—	—	—	520	570	610
S1	—	—	—	42	55	65	40	50	60	38	50	60	34	45	55
	—	—	—	140	180	215	130	165	195	125	165	195	110	150	180
S2	—	—	—	34	45	55	32	42	50	30	40	47	28	36	43
	—	—	—	110	150	180	105	140	165	100	130	155	90	120	140
S3	—	—	—	30	40	46	28	37	44	27	35	41	24	32	38
	—	—	—	100	130	150	90	120	145	90	115	135	80	105	125
S11	—	—	—	60	75	85	55	70	80	50	70	80	47	60	75
	—	—	—	195	245	280	180	230	260	165	230	260	155	195	245
S12	—	—	—	40	55	65	38	50	60	36	47	55	33	43	50
	—	—	—	130	180	215	125	165	195	120	155	180	110	140	165
S13	—	—	—	24	31	37	22	29	35	21	28	33	19	25	30
	—	—	—	80	100	120	70	95	115	70	90	110	60	80	100
H5	43	55	65	34	45	55	34	44	50	33	44	50	29	38	45
	140	180	215	110	150	180	110	145	165	110	145	165	95	125	150
H8	46	60	70	37	49	55	36	47	55	36	46	55	31	40	48
	150	195	230	120	160	180	120	155	180	120	150	180	100	130	155
H11	55	70	80	44	60	70	43	55	65	42	55	65	37	48	55
	180	230	260	145	195	230	140	180	215	140	180	215	120	155	180
H12	80	95	105	70	90	100	70	85	95	65	80	90	55	70	80
	260	310	345	230	295	330	230	280	310	215	260	295	180	230	260

R217/220.69-18 – Cutting data $v_c = (m/min)/(sf/min)$

SMG	F30M			MK1500			MK2050			MS2050			H25		
	100%	30%	10%	100%	30%	10%	100%	30%	10%	100%	30%	10%	100%	30%	10%
P1	130	145	155	—	—	—	140	155	165	140	155	165	—	—	—
	425	475	510	—	—	—	460	510	540	460	510	540	—	—	—
P2	125	145	155	—	—	—	140	155	165	135	155	165	—	—	—
	410	475	510	—	—	—	460	510	540	445	510	540	—	—	—
P3	120	135	145	—	—	—	130	145	155	130	145	155	—	—	—
	395	445	475	—	—	—	425	475	510	425	475	510	—	—	—
P4	110	130	140	—	—	—	120	140	150	120	140	150	—	—	—
	360	425	460	—	—	—	395	460	490	395	460	490	—	—	—
P5	110	125	135	—	—	—	120	135	145	120	135	145	—	—	—
	360	410	445	—	—	—	395	445	475	395	445	475	—	—	—
P6	115	130	145	—	—	—	125	145	155	125	145	155	—	—	—
	375	425	475	—	—	—	410	475	510	410	475	510	—	—	—
P7	115	130	140	—	—	—	125	140	150	125	140	150	—	—	—
	375	425	460	—	—	—	410	460	490	410	460	490	—	—	—
P8	110	125	135	—	—	—	120	135	145	120	135	145	—	—	—
	360	410	445	—	—	—	395	445	475	395	445	475	—	—	—
P11	110	125	140	—	—	—	120	140	150	120	140	150	—	—	—
	360	410	460	—	—	—	395	460	490	395	460	490	—	—	—
P12	85	100	110	—	—	—	95	115	125	95	110	120	—	—	—
	280	330	360	—	—	—	310	375	410	310	360	395	—	—	—
M1	115	130	140	—	—	—	—	—	—	125	140	150	—	—	—
	375	425	460	—	—	—	—	—	—	410	460	490	—	—	—
M2	100	120	130	—	—	—	—	—	—	115	130	140	—	—	—
	330	395	425	—	—	—	—	—	—	375	425	460	—	—	—
M3	90	105	115	—	—	—	—	—	—	100	115	125	—	—	—
	295	345	375	—	—	—	—	—	—	330	375	410	—	—	—
M4	75	90	100	—	—	—	—	—	—	85	100	110	—	—	—
	245	295	330	—	—	—	—	—	—	280	330	360	—	—	—
M5	65	80	90	—	—	—	—	—	—	75	90	100	—	—	—
	215	260	295	—	—	—	—	—	—	245	295	330	—	—	—
K1	110	130	140	145	160	175	140	160	170	—	—	—	—	—	—
	360	425	460	475	520	570	460	520	560	—	—	—	—	—	—
K2	105	120	135	140	155	165	135	150	165	—	—	—	—	—	—
	345	395	445	460	510	540	445	490	540	—	—	—	—	—	—
K3	95	110	125	130	145	155	125	140	155	—	—	—	—	—	—
	310	360	410	425	475	510	410	460	510	—	—	—	—	—	—
K4	90	110	120	125	145	155	120	140	150	—	—	—	—	—	—
	295	360	395	410	475	510	395	460	490	—	—	—	—	—	—
K5	65	80	90	95	115	125	95	110	120	—	—	—	—	—	—
	215	260	295	310	375	410	310	360	395	—	—	—	—	—	—
K6	85	100	110	120	135	145	115	130	140	—	—	—	—	—	—
	280	330	360	395	445	475	375	425	460	—	—	—	—	—	—
K7	80	95	105	110	130	140	110	125	135	—	—	—	—	—	—
	260	310	345	360	425	460	360	410	445	—	—	—	—	—	—
N1	230	250	260	—	—	—	—	—	—	—	—	—	235	255	265
	750	820	850	—	—	—	—	—	—	—	—	—	770	840	870
N2	180	195	205	—	—	—	—	—	—	—	—	—	185	200	210
	590	640	670	—	—	—	—	—	—	—	—	—	610	660	690
N3	155	170	180	—	—	—	—	—	—	—	—	—	160	175	185
	510	560	590	—	—	—	—	—	—	—	—	—	520	570	610
N11	160	180	190	—	—	—	—	—	—	—	—	—	165	185	195
	520	590	620	—	—	—	—	—	—	—	—	—	540	610	640
S1	36	47	55	—	—	—	—	—	—	42	55	65	—	—	—
	120	155	180	—	—	—	—	—	—	140	180	215	—	—	—
S2	29	38	45	—	—	—	—	—	—	34	45	55	—	—	—
	95	125	150	—	—	—	—	—	—	110	150	180	—	—	—
S3	25	34	39	—	—	—	—	—	—	30	39	46	—	—	—
	80	110	130	—	—	—	—	—	—	100	130	150	—	—	—
S11	49	65	75	—	—	—	—	—	—	60	75	85	—	—	—
	160	215	245	—	—	—	—	—	—	195	245	280	—	—	—
S12	28	38	45	—	—	—	—	—	—	40	55	65	—	—	—
	90	125	150	—	—	—	—	—	—	130	180	215	—	—	—
S13	17	22	26	—	—	—	—	—	—	24	31	37	—	—	—
	55	70	85	—	—	—	—	—	—	80	100	120	—	—	—
H5	30	40	47	—	—	—	—	—	—	—	—	—	—	—	—
	100	130	155	—	—	—	—	—	—	—	—	—	—	—	—
H8	32	42	50	—	—	—	—	—	—	—	—	—	—	—	—
	105	140	165	—	—	—	—	—	—	—	—	—	—	—	—
H11	38	50	60	—	—	—	—	—	—	—	—	—	—	—	—
	125	165	195	—	—	—	—	—	—	—	—	—	—	—	—
H12	60	75	85	—	—	—	—	—	—	—	—	—	—	—	—
	195	245	280	—	—	—	—	—	—	—	—	—	—	—	—

Square shoulder and slot milling cutters
Helical milling cutters
Face milling cutters
Disc milling cutters
High feed milling cutters
Copy milling cutters
Plunge milling cutters
Chamfer milling cutters
Spot facing cutters
Inserts



HELICAL SN8-13

Keep up with customer demand for lower part prices. The Seco Helical SN8-13 features double-sided helix inserts with eight cutting edges that significantly lower cost per edge to boost slotting, side milling and circular rough milling efficiency. Built for difficult applications involving ISO P, M, K and S materials, the cutters offer application-specific sub-family designs featuring left or right-hand helixes, half or full effective teeth options, two front insert and many radii choices for long tool life and maximum chip evacuation. Reliable and user-friendly, the Helical SN8-13 also eliminates incorrect indexing of front and helix inserts, reducing operator error.

- Range is built with 4 sub families built with SN13 helix insert:
- SN.U13 insert offering 8 cutting edges in 3 geometries and several grades
- R217/220.82: XO16 lead insert = First choice
- R217/220.82-H: AC15 lead insert = Heavy Duty, R220.69-15H replacement
- R217/220.81: AC15 lead insert = Low Power, R215/220.59 replacement
- R217/220.81-K: AC15 lead insert = Long reach, R215/220.59 replacement

R217.82-SNXO16 – Metric

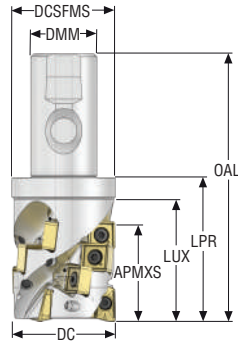

- For insert selection and cutting data recommendations, see page(s) 173-174
- For complete insert programme, see page(s) 847, 871, 872
- For ISO attribute explanation, see page 16
- KAPRS 90°

Designation	Item number	Type of mounting	DC	ZEPF	ZNP	APMXS	DMM	DCSFMS	LUX	LPR	OAL	RPMX	Weight	Insert
			mm			mm	mm	mm	mm	mm	mm		kg	
R217.82-3250.3S-047-SNXO16.3A	10127480	Seco-Weldon	50,0	3	12	47,0	32,0	50,0	60,0	70,0	130,0	11800	1,0	XO.X1605 / SN.U1306

Spare Parts, included in delivery

For cutter	Insert key	Insert screw	Insert screw 2
R217.82-..	1/4HEX-T15PX50	C55011-T15P	C04011-T15P

Accessories

For cutter	Adjustable Torque key	Insert clamping torque	Insert clamping torque 2	Torque key	Torque key 2
R217.82-..	1/4HEX-S-HANDLE-0.8-5.0NM	5.0NM	3.5NM	T00-15P50	T00-15P35

Torque and fixed keys, see page 894

Square shoulder and slot milling cutters

Helical milling cutters

Face milling cutters

Disc milling cutters

High feed milling cutters

Copy milling cutters

Plunge milling cutters

Chamfer milling cutters

Spot facing cutters

Inserts

R217.82-SNX016 – inch

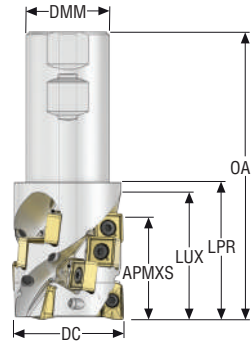

- For insert selection and cutting data recommendations, see page(s) 173-174
- For complete insert programme, see page(s) 847, 871, 872
- For ISO attribute explanation, see page 16
- KAPRS 90°

Designation	Item number	Type of mounting	DC	ZEFP	ZNP	APMXS	DMM	LUX	LPR	OAL	RPMX	Weight	Insert
			inch			inch	inch	inch	inch	inch		lbs	
R217.82-02.00-3-1.85-SNX016.3A	10127485	Weldon	2.000	3	12	1.850	1.500	2.362	2.441	5.169	11800	2.650	XO.X1605 / SN.U1306

Spare Parts, included in delivery

For cutter	Insert key	Insert screw	Insert screw 2
R217.82-..	1/4HEX-T15PX50	C55011-T15P	C04011-T15P

Accessories

For cutter	Adjustable Torque key	Insert clamping torque	Insert clamping torque 2	Torque key	Torque key 2
R217.82-..	1/4HEX-S-HANDLE-0.8-5.0NM	44.3IN.LBS	31.0IN.LBS	T00-15P50	T00-15P35

Torque and fixed keys, see page 894

R220.82-SNXO16 – Metric

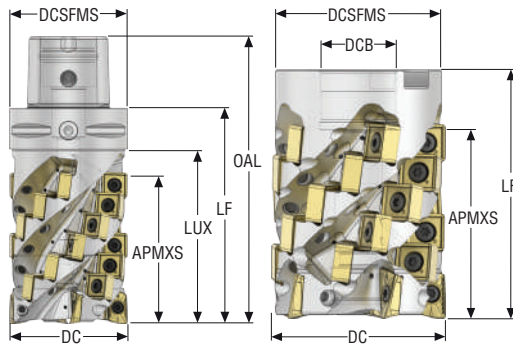

- For insert selection and cutting data recommendations, see page(s) 173-174
- For complete insert programme, see page(s) 847, 871, 872
- For ISO attribute explanation, see page 16
- KAPRS 90°

Designation	Item number	Type of mounting	DC	ZFP	ZNP	APMXS	DCB	DCSFMS	LF	RPMX	Weight	Insert
			mm			mm	mm	mm	mm		kg	
C6-R217.82-063-079-SNXO16.4SA	10127467	Seco-Capto	63,0	4	28	79,0	–	63,0	115,0	7400	1,8	XO.X1605 / SN.U1306
R220.82-0063-047-SNXO16.4A	10127481	Arbor	63,0	4	16	47,0	27,0	59,0	70,0	10500	0,9	XO.X1605 / SN.U1306
R220.82-0063-069-SNXO16.5A	10127482	Arbor	63,0	5	30	69,0	27,0	59,0	90,0	10500	1,2	XO.X1605 / SN.U1306
R220.82-0080-068-SNXO16.5A	10127483	Arbor	80,0	5	30	68,0	32,0	75,0	90,0	6500	2,0	XO.X1605 / SN.U1306
R220.82-0080-079-SNXO16.6A	10127484	Arbor	80,0	6	42	79,0	32,0	75,0	100,0	6500	2,2	XO.X1605 / SN.U1306

Spare Parts, included in delivery

For cutter	Arbor screw	Assembly screw	Basic body	Insert key	Insert screw	Insert screw 2	Replaceable end
Cx-R217.82	–	MC6S5X35	C6-R217.82-063-043-SN.4BA	1/4HEX-T15PX50	C55011-T15P	C04011-T15P	R220.82-RE063-036-SNXO16.4A
R220.82-0063-047	MC6S12X60	–	–	1/4HEX-T15PX50	C55011-T15P	C04011-T15P	–
R220.82-0063-069	MC6S12X80	–	–	1/4HEX-T15PX50	C55011-T15P	C04011-T15P	–
R220.82-0080	MP6S16X80	–	–	1/4HEX-T15PX90	C55011-T15P	C04011-T15P	–

Accessories

For cutter	Adjustable Torque key	Insert clamping torque	Insert clamping torque 2	Torque key	Torque key 2
Cx-R217/220.82	1/4HEX-S-HANDLE-0.8-5.0NM	5.0NM	3.5NM	T00-15P50	T00-15P35

Torque and fixed keys, see page 894

Square shoulder and slot milling cutters

Helical milling cutters

Face milling cutters

Disc milling cutters

High feed milling cutters

Copy milling cutters

Plunge milling cutters

Chamfer milling cutters

Spot facing cutters

Inserts

R220.82-SNXO16 – inch

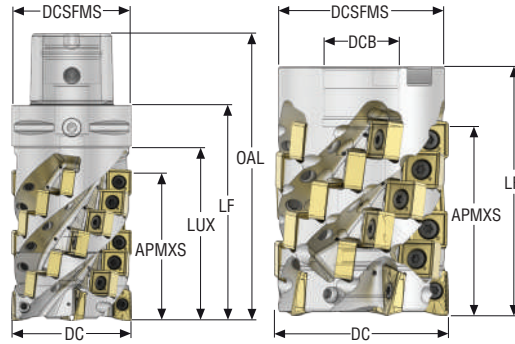

- For insert selection and cutting data recommendations, see page(s) 173-174
- For complete insert programme, see page(s) 847, 871, 872
- For ISO attribute explanation, see page 16
- KAPRS 90°

Designation	Item number	Type of mounting	DC	ZEPF	ZNP	APMXS	DCB	DCSFMS	LF	RPMX	Weight	Insert
			inch			inch	inch	inch	inch		lbs	
C6-R217.82-2.5-3.11-SNXO16.4SA	10128065	Seco-Capto	2.500	4	28	3.110	–	2.480	4.528	7400	3.970	XO.X1605 / SN.U1306
R220.82-02.50-1.85-SNXO16.4A	10127486	Arbor	2.500	4	16	1.850	1.000	2.323	2.750	10500	1.980	XO.X1605 / SN.U1306
R220.82-02.50-2.75-SNXO16.5A	10127487	Arbor	2.500	5	30	2.717	1.000	2.323	3.500	10500	2.650	XO.X1605 / SN.U1306
R220.82-03.00-2.68-SNXO16.5A	10127488	Arbor	3.000	5	30	2.677	1.250	2.795	3.500	6500	3.750	XO.X1605 / SN.U1306
R220.82-03.00-3.11-SNXO16.6A	10127489	Arbor	3.000	6	42	3.110	1.250	2.795	3.938	6500	4.190	XO.X1605 / SN.U1306

Spare Parts, included in delivery

For cutter	Arbor screw	Assembly screw	Basic body	Insert key	Insert screw	Insert screw 2	Replaceable end
Cx-R217.82	–	UC6S10UNFX1-1/2	C6-R217.82-2.5-1.69-SN.4BA	1/4HEX-T15PX50	C55011-T15P	C04011-T15P	R220.82-RE02.50-1.42-SNXO16.4A
R220.82-02.50.4A	UC6S1/2UNFX2-1/4	–	–	1/4HEX-T15PX50	C55011-T15P	C04011-T15P	–
R220.82-02.50.5A	UC6S1/2UNFX3	–	–	1/4HEX-T15PX50	C55011-T15P	C04011-T15P	–
R220.82-03.00	UP6SS/8UNFX3-1/4	–	–	1/4HEX-T15PX90	C55011-T15P	C04011-T15P	–

Accessories

For cutter	Adjustable Torque key	Insert clamping torque	Insert clamping torque 2	Torque key	Torque key 2
Cx-R217/220.82-..	1/4HEX-S-HANDLE-0.8-5.0NM	44.3IN.LBS	31.0IN.LBS	T00-15P50	T00-15P35

Torque and fixed keys, see page 894

R217/220.82-SNXO16 – Insert selection – mm/Inch

SMG			f _z		
			100%	30%	10%
P1	XOMX160508TR-M13 MP2501	SNXU130612TN-M12 MP2501	0,15	0,16	0,24
			0,0060	0,0065	0,0095
P2	XOMX160508TR-M13 MP2501	SNXU130612TN-M12 MP2501	0,15	0,16	0,25
			0,0060	0,0065	0,010
P3	XOMX160508TR-M13 MP2501	SNXU130612TN-M12 MP2501	0,14	0,15	0,24
			0,0055	0,0060	0,0095
P4	XOMX160508TR-M13 MP2501	SNXU130612TN-M12 MP2501	0,14	0,15	0,24
			0,0055	0,0060	0,0095
P5	XOMX160508TR-MD14 MP1501	SNGU130612TN-M14 MP1501	0,15	0,16	0,24
			0,0060	0,0065	0,0095
P6	XOMX160508TR-MD14 MP1501	SNGU130612TN-M14 MP1501	0,14	0,16	0,24
			0,0055	0,0065	0,0095
P7	XOMX160508TR-MD14 MP1501	SNGU130612TN-M14 MP1501	0,14	0,16	0,24
			0,0055	0,0065	0,0095
P8	XOMX160508TR-MD14 MP1501	SNGU130612TN-M14 MP1501	0,15	0,17	0,25
			0,0060	0,0065	0,010
P11	XOMX160508TR-ME11 T350M	SNXU130612TN-M12 T350M	0,11	0,12	0,19
			0,0044	0,0048	0,0075
P12	XOMX160508TR-ME11 T350M	SNXU130612TN-M12 T350M	0,080	0,085	0,13
			0,0032	0,0034	0,0050
M1	XOMX160508R-M09 MS2050	SNGU130612EN-ME10 MS2050	0,10	0,11	0,17
			0,0040	0,0044	0,0065
M2	XOMX160508R-M09 MS2050	SNGU130612EN-ME10 MS2050	0,095	0,10	0,16
			0,0038	0,0040	0,0065
M3	XOMX160508R-M09 MS2050	SNGU130612EN-ME10 MS2050	0,075	0,080	0,13
			0,0030	0,0032	0,0050
M4	XOMX160508TR-ME11 MS2050	SNGU130612EN-ME10 MS2050	0,080	0,085	0,13
			0,0032	0,0034	0,0050
M5	XOMX160508TR-ME11 MS2050	SNGU130612EN-ME10 MS2050	0,080	0,085	0,13
			0,0032	0,0034	0,0050
K1	XOMX160508TR-M13 MK2050	SNGU130612TN-M14 MK2050	0,15	0,16	0,25
			0,0060	0,0065	0,010
K2	XOMX160508TR-M13 MK2050	SNGU130612TN-M14 MK2050	0,14	0,15	0,22
			0,0055	0,0060	0,0085
K3	XOMX160508TR-M13 MK2050	SNGU130612TN-M14 MK2050	0,14	0,15	0,22
			0,0055	0,0060	0,0085
K4	XOMX160508TR-M13 MK2050	SNGU130612TN-M14 MK2050	0,14	0,15	0,22
			0,0055	0,0060	0,0085
K5	XOMX160508TR-M13 MK2050	SNGU130612TN-M14 MK2050	0,12	0,13	0,20
			0,0048	0,0050	0,0080
K6	XOMX160508TR-M13 MK2050	SNGU130612TN-M14 MK2050	0,14	0,15	0,22
			0,0055	0,0060	0,0085
K7	XOMX160508TR-M13 MK2050	SNGU130612TN-M14 MK2050	0,12	0,13	0,20
			0,0048	0,0050	0,0080
S1	XOMX160508TR-ME11 F40M	SNGU130612EN-ME10 MS2050	0,080	0,085	0,13
			0,0032	0,0034	0,0050
S2	XOMX160508TR-ME11 F40M	SNGU130612EN-ME10 MS2050	0,080	0,085	0,13
			0,0032	0,0034	0,0050
S3	XOMX160508TR-ME11 F40M	SNGU130612EN-ME10 MS2050	0,075	0,080	0,12
			0,0030	0,0032	0,0048
S11	XOMX160508TR-ME11 MS2050	SNGU130612EN-ME10 MS2050	0,090	0,10	0,15
			0,0036	0,0040	0,0060
S12	XOMX160508TR-ME11 MS2050	SNGU130612EN-ME10 MS2050	0,090	0,10	0,15
			0,0036	0,0040	0,0060
S13	XOMX160508TR-ME11 MS2050	SNGU130612EN-ME10 MS2050	0,080	0,085	0,13
			0,0032	0,0034	0,0050
H5	XOMX160508TR-MD14 MP1501	SNGU130612TN-M14 MP1501	0,10	0,11	0,17
			0,0040	0,0044	0,0065
H11	XOMX160508TR-MD14 MP1501	SNGU130612TN-M14 MP1501	0,10	0,11	0,17
			0,0040	0,0044	0,0065
H12	XOMX160508TR-ME11 MP2050	SNGU130612EN-ME10 MP2050	0,060	0,065	0,10
			0,0024	0,0026	0,0040

SMG = Seco material group
f_z = mm/tooth (in/tooth), v_c = m/min (sf/min), a_p/DC = %
All cutting data are start values

Square shoulder and slot milling cutters
Helical milling cutters
Face milling cutters
Disc milling cutters
High feed milling cutters
Copy milling cutters
Plunge milling cutters
Chamfer milling cutters
Spot facing cutters
Inserts

R217/220.82-SNXO16 – Cutting data $v_c = (m/min)/(sf/min)$

SMG	MP1501			MP2501			T350M			MS2500			MK2050			MS2050			MP2050			F40M					
	100%	30%	10%	100%	30%	10%	100%	30%	10%	100%	30%	10%	100%	30%	10%	100%	30%	10%	100%	30%	10%	100%	30%	10%			
P1	140	155	165	135	150	160	130	145	155	140	155	165	135	150	160	125	140	150	140	155	165	120	135	145	145	160	170
	460	510	540	445	490	520	425	475	510	460	510	540	445	490	520	410	460	490	460	510	540	395	445	475	475	525	555
P2	140	155	165	135	150	160	125	140	150	140	155	165	135	150	160	125	140	150	140	155	160	155	160	120	135	145	155
	460	510	540	445	490	520	410	460	490	460	510	540	445	490	520	410	460	490	460	510	520	460	510	395	445	475	475
P3	130	145	155	125	140	150	120	135	145	130	145	155	125	140	150	115	130	140	130	145	155	110	125	135	125	140	145
	425	475	510	410	460	490	395	445	475	425	475	510	410	460	490	375	425	460	425	475	475	410	460	360	410	445	445
P4	125	140	150	120	135	145	110	130	135	125	140	150	120	135	145	110	125	135	125	140	150	110	125	135	125	140	145
	410	460	490	395	445	475	360	425	445	410	460	490	395	445	475	360	410	445	410	460	475	410	460	345	395	425	425
P5	120	140	150	120	135	145	110	125	135	125	140	150	120	135	140	110	125	135	120	135	145	105	120	130	120	135	140
	395	460	490	395	445	475	375	425	445	410	460	490	395	445	460	360	410	445	410	445	475	395	445	345	395	425	425
P6	130	145	155	125	140	150	115	135	140	130	145	155	125	140	150	115	130	140	130	145	155	110	125	135	125	140	145
	425	475	510	410	460	490	375	445	460	425	475	510	410	460	490	375	425	460	425	475	475	410	460	360	410	445	445
P7	125	140	150	120	135	145	115	130	140	125	140	150	120	135	145	110	125	135	125	140	150	110	125	135	125	140	145
	410	460	490	395	445	475	375	425	445	410	460	490	395	445	475	360	410	445	410	460	475	410	460	345	395	425	425
P8	120	135	145	115	135	140	110	125	135	120	140	145	115	130	140	105	125	130	120	135	145	100	120	130	125	140	145
	395	445	475	375	445	460	360	410	445	395	460	475	375	425	460	345	410	425	395	445	475	330	395	410	410	475	475
P11	125	140	150	120	135	145	110	130	135	125	140	150	120	135	145	110	125	135	125	140	150	105	120	130	120	135	140
	410	460	490	395	445	475	360	425	445	410	460	490	395	445	475	360	410	445	410	460	475	410	460	345	395	425	425
P12	100	115	125	95	110	120	90	105	115	100	115	125	95	110	120	85	100	110	100	115	125	80	95	105	105	120	130
	330	375	410	310	360	395	295	345	375	330	375	410	310	360	395	280	330	360	330	375	410	260	310	345	345	395	425
M1	—	—	—	115	130	140	110	130	140	120	135	145	—	—	—	110	130	140	120	135	145	105	120	130	130	145	155
	—	—	—	375	425	460	360	425	460	395	445	475	—	—	—	360	425	460	395	445	475	345	395	425	425	475	475
M2	—	—	—	105	120	130	105	115	125	110	125	135	—	—	—	105	115	125	110	125	135	95	110	120	120	135	140
	—	—	—	345	395	425	345	375	410	360	410	445	—	—	—	345	375	410	360	410	445	310	360	395	395	445	445
M3	—	—	—	95	110	120	90	105	115	100	115	125	—	—	—	90	105	115	95	110	125	85	100	110	110	125	130
	—	—	—	310	360	395	295	345	375	330	375	410	—	—	—	295	345	375	310	375	395	280	330	360	360	410	410
M4	—	—	—	80	95	105	75	90	100	85	100	110	—	—	—	75	90	100	85	100	110	70	85	95	95	110	115
	—	—	—	260	310	345	245	295	330	280	330	360	—	—	—	245	295	330	280	330	360	230	280	310	310	360	360
M5	—	—	—	70	85	95	65	80	90	75	90	100	—	—	—	65	80	90	75	90	100	60	75	85	85	100	105
	—	—	—	230	280	310	215	260	295	245	295	330	—	—	—	215	260	295	245	295	330	195	245	280	280	330	330
K1	125	140	150	120	135	145	115	130	140	—	—	—	135	155	165	—	—	—	—	—	—	105	120	130	130	145	155
	410	460	490	395	445	475	375	425	460	—	—	—	445	510	540	—	—	—	—	—	—	345	395	425	425	475	475
K2	120	135	145	115	130	140	110	120	135	—	—	—	130	145	155	—	—	—	—	—	—	100	115	125	125	140	145
	395	445	475	375	425	460	360	395	445	—	—	—	425	475	510	—	—	—	—	—	—	330	375	410	410	460	460
K3	110	125	135	105	120	130	100	115	125	—	—	—	120	135	145	—	—	—	—	—	—	90	105	115	115	130	135
	360	410	445	345	395	425	330	375	410	—	—	—	395	445	475	—	—	—	—	—	—	295	345	375	375	425	425
K4	110	125	135	105	120	130	95	110	120	—	—	—	120	135	145	—	—	—	—	—	—	90	105	115	115	130	135
	360	410	445	345	395	425	310	360	395	—	—	—	395	445	475	—	—	—	—	—	—	295	345	375	375	425	425
K5	80	95	105	75	90	100	70	85	95	—	—	—	95	110	115	—	—	—	—	—	—	60	75	85	85	100	105
	260	310	345	245	295	330	230	280	310	—	—	—	310	360	375	—	—	—	—	—	—	195	245	280	280	330	330
K6	100	115	125	95	110	120	90	105	115	—	—	—	115	125	140	—	—	—	—	—	—	80	95	105	105	120	125
	330	375	410	310	360	395	295	345	375	—	—	—	375	410	460	—	—	—	—	—	—	260	310	345	345	395	395
K7	95	110	120	90	105	115	85	100	105	—	—	—	105	120	130	—	—	—	—	—	—	75	90	100	100	115	120
	310	360	395	295	345	375	280	330	345	—	—	—	345	395	425	—	—	—	—	—	—	245	295	330	330	385	385
S1	—	—	—	42	55	65	38	50	60	46	60	70	—	—	—	38	50	60	45	60	70	35	46	55	55	70	75
	—	—	—	140	180	215	125	165	195	150	195	230	—	—	—	125	165	195	150	195	230	115	150	180	180	230	230
S2	—	—	—	34	45	55	31	41	48	37	50	60	—	—	—	31	41	48	36	48	55	28	37	43	43	55	60
	—	—	—	110	150	180	100	135	155	120	165	195	—	—	—	100	135	155	120	155	180	90	120	140	140	180	180
S3	—	—	—	30	40	47	27	36	42	33	43	50	—	—	—	27	36	42	32	42	50	25	32	38	38	50	55
	—	—	—	100	130	155	90	120	140	110	140	165	—	—	—	90	120	140	105	140	165	80	105	125	125	160	160
S11	—	—	—	60	75	85	55	70	75	65	80	90	—	—	—	55	70	75	65	80	85	48	65	70	70	85	90
	—	—	—	195	245	280	180	230	245	215	260	295	—	—	—	180	230	245	215	260	280	155	215	230	230	280	280
S12	—	—	—	41	55	65	37	49	55																		

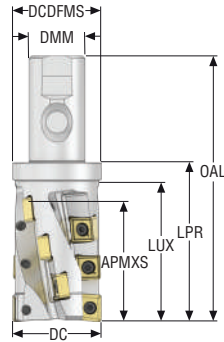

R217.81-SNAC15 Left Helix Troubleshooter – Metric



- For insert selection and cutting data recommendations, see page(s) 179-180
- For complete insert programme, see page(s) 829, 847
- For ISO attribute explanation, see page 16
- KAPRS 90°

Designation	Item number	Type of mounting	DC	ZEPF	ZNP	APMXS	DMM	DCSFMS	LUX	LPR	OAL	RPMX	Weight	Insert
			mm			mm	mm	mm	mm	mm	mm		kg	
R217.81-3250.3S-068-SNAC15.2	10127496	Seco-Weldon	50,0	2	12	68,0	32,0	50,0	79,0	90,0	150,0	8300	1,1	AC.T1506 / SN.U1306

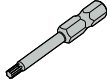
Spare Parts, included in delivery

For cutter	Insert key	Insert screw
		
R217.81-..	1/4HEX-T15PX50	C55011-T15P

Accessories

For cutter	Adjustable Torque key	Adjustable Torque key 2	Insert clamping torque	Torque key
				
R217.81-..	1/4HEX-S-HANDLE-0.8-5.0NM	1/4HEX-T-HANDLE-5.0-14.0NM	5.0NM	T00-15P50

Torque and fixed keys, see page 894

Square shoulder and slot milling cutters

Helical milling cutters

Face milling cutters

Disc milling cutters

High feed milling cutters

Copy milling cutters

Plunge milling cutters

Chamfer milling cutters

Spot facing cutters

Inserts

R220.81-SNAC15 – Left Helix Troubleshooter - Metric

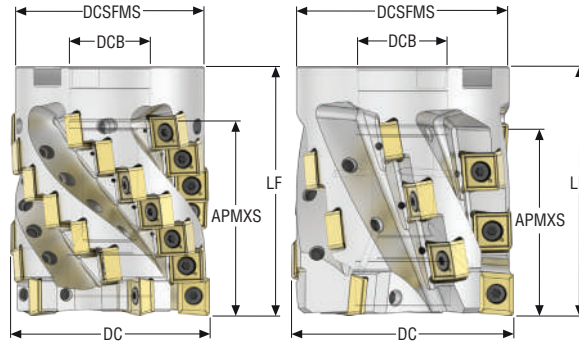

- For insert selection and cutting data recommendations, see page(s) 179-180
- For complete insert programme, see page(s) 829, 847
- For ISO attribute explanation, see page 16
- KAPRS 90°

Designation	Item number	Type of mounting	DC	ZFP	ZNP	APMXS	DCB	DCSFMS	LF	RPMX	Weight	Insert
			mm			mm	mm	mm	mm		kg	
R220.81-0063-068-SNAC15.2A	10127497	Arbor	63,0	2	12	68,0	27,0	59,0	90,0	7400	1,2	AC.T1506 / SN.U1306
R220.81-0063-068-SNAC15.4KA	10127494	Arbor	63,0	4	24	68,0	27,0	59,0	90,0	7400	1,1	AC.T1506 / SN.U1306
R220.81-0080-068-SNAC15.3A	10127498	Arbor	80,0	3	18	68,0	32,0	75,5	90,0	6500	2,2	AC.T1506 / SN.U1306
R220.81-0080-079-SNAC15.5KA	10127495	Arbor	80,0	5	35	79,0	32,0	75,0	100,0	6500	2,2	AC.T1506 / SN.U1306
R220.81-0100-068-SNAC15.4A	10127499	Arbor	100,0	4	24	68,0	40,0	91,0	90,0	5800	3,4	AC.T1506 / SN.U1306

Spare Parts, included in delivery

For cutter	Arbor screw	Insert key	Insert screw
R220.81-0063	MP6S12X80	1/4HEX-T15PX50	C55011-T15P
R220.81-0080	MP6S16X80	1/4HEX-T15PX90	C55011-T15P
R220.81-0100	MP6S20X80	1/4HEX-T15PX90	C55011-T15P

Accessories

For cutter	Adjustable Torque key	Adjustable Torque key 2	Insert clamping torque	Torque key
R217.81-..	1/4HEX-S-HANDLE-0.8-5.0NM	1/4HEX-T-HANDLE-5.0-14.0NM	5.0NM	T00-15P50

Torque and fixed keys, see page 894

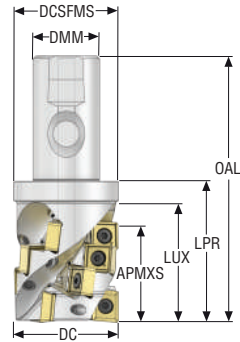

R217.82-SNAC15 – Right Helix for Heavy Duty – Metric



- For insert selection and cutting data recommendations, see page(s) 165-167
- For complete insert programme, see page(s) 829, 847
- For ISO attribute explanation, see page 16
- KAPRS 90°

Designation	Item number	Type of mounting	DC	ZEFP	ZNP	APMXS	DMM	DCSFMS	LUX	LPR	OAL	RPMX	Weight	Insert
			mm			mm	mm	mm	mm	mm	mm		kg	
R217.82-3250.3S-046-SNAC15.3HA	10127490	Seco-Weldon	50,0	3	12	47,0	32,0	50,0	57,0	68,0	128,0	8300	1,0	AC.T1506 / SN.U1306

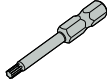
Spare Parts, included in delivery

For cutter	Insert key	Insert screw
		
R217.82-..	1/4HEX-T15PX50	C55011-T15P

Accessories

For cutter	Adjustable Torque key	Adjustable Torque key 2	Insert clamping torque	Torque key
				
R217.82-..	1/4HEX-S-HANDLE-0.8-5.0NM	1/4HEX-T-HANDLE-5.0-14.0NM	5.0NM	T00-15P50

Torque and fixed keys, see page 894

Square shoulder and slot milling cutters

Helical milling cutters

Face milling cutters

Disc milling cutters

High feed milling cutters

Copy milling cutters

Plunge milling cutters

Chamfer milling cutters

Spot facing cutters

Inserts

R220-82-SNAC15 Right Helix for Heavy Duty – Metric

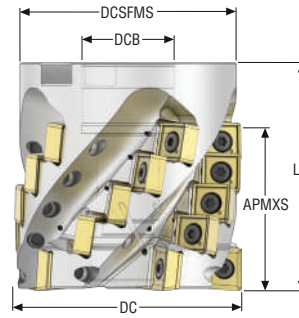

- For insert selection and cutting data recommendations, see page(s) 179-180
- For complete insert programme, see page(s) 829, 847
- For ISO attribute explanation, see page 16
- KAPRS 90°

Designation	Item number	Type of mounting	DC	ZEFP	ZNP	APMXS	DCB	DCSFMS	LF	RPMX	Weight	Insert
			mm			mm	mm	mm	mm		kg	
R220.82-0063-046-SNAC15.4HA	10127491	Arbor	63,0	4	16	46,0	27,0	59,0	70,0	7400	0,9	AC.T1506 / SN.U1306
R220.82-0080-057-SNAC15.5HA	10127492	Arbor	80,0	5	25	57,0	32,0	75,0	80,0	6500	1,8	AC.T1506 / SN.U1306
R220.82-0100-057-SNAC15.6HA	10127493	Arbor	100,0	6	30	57,0	40,0	90,0	75,0	5800	2,6	AC.T1506 / SN.U1306

Spare Parts, included in delivery

For cutter	Arbor screw	Insert key	Insert screw
R220.82-0063	MC6S12X60	1/4HEX-T15PX50	C55011-T15P
R220.82-0080	MC6S16X70	1/4HEX-T15PX90	C55011-T15P
R220.82-0100	MC6S20X50	1/4HEX-T15PX90	C55011-T15P

Accessories

For cutter	Adjustable Torque key	Adjustable Torque key 2	Insert clamping torque	Torque key
R220.82-0063-0080	1/4HEX-S-HANDLE-0.8-5.0NM	1/4HEX-T-HANDLE-5.0-14.0NM	5.0NM	T00-15P50
R220.82-0100	1/4HEX-S-HANDLE-0.8-5.0NM	1/4HEX-T-HANDLE-5.0-14.0NM	5.0NM	T00-15P50

Torque and fixed keys, see page 894

R217/220.82-SNAC15 – Insert selection – mm/Inch

SMG			f _z		
			100%	30%	10%
P1	ACET150612TR-M11 MP2501	SNXU130612TN-M12 MP2501	0,12	0,13	0,20
			0,0048	0,0050	0,0080
P2	ACET150612TR-M11 MP2501	SNXU130612TN-M12 MP2501	0,13	0,14	0,22
			0,0050	0,0055	0,0085
P3	ACET150612TR-M11 MP2501	SNXU130612TN-M12 MP2501	0,12	0,13	0,20
			0,0048	0,0050	0,0080
P4	ACET150612TR-M11 MP2501	SNXU130612TN-M12 MP2501	0,12	0,13	0,20
			0,0048	0,0050	0,0080
P5	ACET150612TR-M11 MP2501	SNGU130612TN-M14 MP2501	0,11	0,12	0,19
			0,0044	0,0048	0,0075
P6	ACET150612TR-M11 MP2501	SNGU130612TN-M14 MP2501	0,11	0,12	0,19
			0,0044	0,0048	0,0075
P7	ACET150612TR-M11 MP2501	SNGU130612TN-M14 MP2501	0,11	0,12	0,19
			0,0044	0,0048	0,0075
P8	ACET150612TR-M11 MP2501	SNGU130612TN-M14 MP2501	0,12	0,13	0,20
			0,0048	0,0050	0,0080
P11	ACET150612TR-M11 T350M	SNXU130612TN-M12 T350M	0,11	0,12	0,19
			0,0044	0,0048	0,0075
P12	ACET150612TR-M11 T350M	SNXU130612TN-M12 T350M	0,080	0,085	0,13
			0,0032	0,0034	0,0050
M1	ACET150612TR-ME10 MS2050	SNGU130612EN-ME10 MS2050	0,11	0,12	0,19
			0,0044	0,0048	0,0075
M2	ACET150612TR-ME10 MS2050	SNGU130612EN-ME10 MS2050	0,10	0,11	0,17
			0,0040	0,0044	0,0065
M3	ACET150612TR-ME10 MS2050	SNGU130612EN-ME10 MS2050	0,085	0,090	0,14
			0,0034	0,0036	0,0055
M4	ACET150612TR-M11 T350M	SNXU130612TN-M12 T350M	0,080	0,090	0,13
			0,0032	0,0036	0,0050
M5	ACET150612TR-M11 T350M	SNXU130612TN-M12 T350M	0,080	0,090	0,13
			0,0032	0,0036	0,0050
K1	ACET150612TR-M14 MK1500	SNGU130612TN-M14 MK2050	0,16	0,17	0,26
			0,0065	0,0065	0,010
K2	ACET150612TR-M14 MK1500	SNGU130612TN-M14 MK2050	0,15	0,16	0,24
			0,0060	0,0065	0,0095
K3	ACET150612TR-M14 MK1500	SNGU130612TN-M14 MK2050	0,15	0,16	0,24
			0,0060	0,0065	0,0095
K4	ACET150612TR-M14 MK1500	SNGU130612TN-M14 MK2050	0,15	0,16	0,24
			0,0060	0,0065	0,0095
K5	ACET150612TR-M14 MK1500	SNGU130612TN-M14 MK2050	0,13	0,14	0,22
			0,0050	0,0055	0,0085
K6	ACET150612TR-M14 MK1500	SNGU130612TN-M14 MK2050	0,15	0,16	0,24
			0,0060	0,0065	0,0095
K7	ACET150612TR-M14 MK1500	SNGU130612TN-M14 MK2050	0,13	0,14	0,22
			0,0050	0,0055	0,0085
S1	ACET150612TR-M11 F40M	SNXU130612TN-M12 F40M	0,080	0,090	0,13
			0,0032	0,0036	0,0050
S2	ACET150612TR-M11 F40M	SNXU130612TN-M12 F40M	0,080	0,090	0,13
			0,0032	0,0036	0,0050
S3	ACET150612TR-M11 F40M	SNXU130612TN-M12 F40M	0,075	0,080	0,12
			0,0030	0,0032	0,0048
S11	ACET150612TR-ME10 MS2050	SNGU130612EN-ME10 MS2050	0,085	0,090	0,14
			0,0034	0,0036	0,0055
S12	ACET150612TR-ME10 MS2050	SNGU130612EN-ME10 MS2050	0,085	0,090	0,14
			0,0034	0,0036	0,0055
S13	ACET150612TR-ME10 MS2050	SNGU130612EN-ME10 MS2050	0,075	0,080	0,12
			0,0030	0,0032	0,0048
H5	ACET150612TR-M11 T350M	SNXU130612TN-M12 T350M	0,080	0,085	0,13
			0,0032	0,0034	0,0050
H8	ACET150612TR-M11 T350M	SNXU130612TN-M12 T350M	0,060	0,065	0,10
			0,0024	0,0026	0,0040
H11	ACET150612TR-M11 T350M	SNXU130612TN-M12 T350M	0,080	0,085	0,13
			0,0032	0,0034	0,0050
H12	ACET150612TR-M11 T350M	SNXU130612TN-M12 T350M	0,060	0,065	0,10
			0,0024	0,0026	0,0040

SMG = Seco material group
 f_z = mm/tooth (in/tooth), v_c = m/min (sf/min), a_p/DC = %
 All cutting data are start values

Square shoulder and slot milling cutters
 Helical milling cutters
 Face milling cutters
 Disc milling cutters
 High feed milling cutters
 Copy milling cutters
 Plunge milling cutters
 Chamfer milling cutters
 Spot facing cutters
 Inserts

R217/220.82-SNAC15 – Cutting data $v_c = (m/min)/(sf/min)$

SMG	MP1501			MP2501			T350M			MS2500			MK2050			MS2050			MP2050			F40M			
	100%	30%	10%	100%	30%	10%	100%	30%	10%	100%	30%	10%	100%	30%	10%	100%	30%	10%	100%	30%	10%	100%	30%	10%	
P1	145	160	170	140	155	165	130	145	155	145	160	170	140	150	160	130	145	155	140	155	165	125	140	150	
	475	520	560	460	510	540	425	475	510	475	520	560	460	490	520	425	475	510	460	510	540	410	460	490	
P2	140	155	165	135	150	160	130	145	155	140	155	165	135	150	160	125	140	150	140	155	165	120	135	145	
	460	510	540	445	490	520	425	475	510	460	510	540	445	490	520	410	460	490	460	510	540	395	445	475	
P3	135	150	160	130	145	155	120	135	145	135	150	160	130	145	155	120	135	145	130	150	155	115	130	140	
	445	490	520	425	475	510	395	445	475	445	490	520	425	475	510	395	445	475	425	490	510	375	425	460	
P4	125	145	150	120	140	145	115	130	140	125	140	150	120	135	145	110	130	135	125	140	150	105	120	130	
	410	475	490	395	460	475	375	425	460	410	460	490	395	445	475	360	425	445	410	460	490	345	395	425	
P5	125	140	150	120	135	145	115	125	140	125	140	150	120	135	145	110	125	135	125	140	150	105	120	130	
	410	460	490	395	445	475	375	410	460	410	460	490	395	445	475	360	410	445	410	460	490	345	395	425	
P6	130	145	155	125	140	150	120	135	145	130	145	155	125	140	150	115	130	140	130	145	155	110	125	135	
	425	475	510	410	460	490	395	445	475	425	475	510	410	460	490	375	425	460	425	475	510	360	410	445	
P7	130	145	155	125	140	150	115	130	140	130	145	155	125	140	150	115	130	140	125	145	150	110	125	135	
	425	475	510	410	460	490	375	425	460	425	475	510	410	460	490	375	425	460	410	475	490	360	410	445	
P8	125	140	150	120	135	145	110	125	135	125	140	150	120	135	145	110	125	135	125	140	150	105	120	130	
	410	460	490	395	445	475	360	410	445	410	460	490	395	445	475	360	410	445	410	460	490	345	395	425	
P11	125	140	150	120	140	145	115	130	140	125	140	150	120	135	145	110	130	135	125	140	150	105	120	130	
	410	460	490	395	460	475	375	425	460	410	460	490	395	445	475	360	425	445	410	460	490	345	395	425	
P12	105	120	130	100	115	125	90	105	115	105	120	130	95	110	120	90	105	115	100	115	125	85	100	110	
	345	395	425	330	375	410	295	345	375	345	395	425	310	360	395	295	345	375	330	375	410	280	330	360	
M1	—	—	—	—	120	135	145	115	130	140	120	140	150	—	—	—	115	130	140	120	140	145	110	125	135
	—	—	—	395	445	475	375	425	460	395	460	490	—	—	—	375	425	460	395	460	475	360	410	445	
M2	—	—	—	—	110	125	135	105	120	130	115	130	140	—	—	—	105	120	130	110	125	135	100	115	125
	—	—	—	360	410	445	345	395	425	375	425	460	—	—	—	345	395	425	360	410	445	330	375	410	
M3	—	—	—	—	95	110	120	95	110	115	100	115	125	—	—	—	95	110	115	100	115	125	85	105	110
	—	—	—	310	360	395	310	360	375	330	375	410	—	—	—	310	360	375	330	375	410	280	345	360	
M4	—	—	—	—	80	100	105	80	95	105	85	105	110	—	—	—	80	95	105	85	100	110	75	90	100
	—	—	—	260	330	345	260	310	345	280	345	360	—	—	—	260	310	345	280	330	360	245	295	330	
M5	—	—	—	—	70	90	95	70	85	95	75	95	100	—	—	—	70	85	95	75	90	100	65	80	90
	—	—	—	230	295	310	230	280	310	245	310	330	—	—	—	230	280	310	245	295	330	215	260	295	
K1	130	145	155	125	140	150	115	130	140	—	—	—	140	155	165	—	—	—	—	—	—	110	125	135	
	425	475	510	410	460	490	375	425	460	—	—	—	460	510	540	—	—	—	—	—	—	360	410	445	
K2	120	135	145	120	130	140	110	125	135	—	—	—	135	150	160	—	—	—	—	—	—	100	115	125	
	395	445	475	395	425	460	360	410	445	—	—	—	445	490	520	—	—	—	—	—	—	330	375	410	
K3	110	130	140	110	125	135	100	115	125	—	—	—	125	140	150	—	—	—	—	—	—	95	110	120	
	360	425	460	360	410	445	330	375	410	—	—	—	410	460	490	—	—	—	—	—	—	310	360	395	
K4	110	125	135	105	120	130	100	115	125	—	—	—	120	135	145	—	—	—	—	—	—	90	105	115	
	360	410	445	345	395	425	330	375	410	—	—	—	395	445	475	—	—	—	—	—	—	295	345	375	
K5	85	100	110	80	95	105	70	85	95	—	—	—	95	110	120	—	—	—	—	—	—	65	80	90	
	280	330	360	260	310	345	230	280	310	—	—	—	310	360	395	—	—	—	—	—	—	215	260	295	
K6	105	120	130	100	115	125	90	105	115	—	—	—	115	130	140	—	—	—	—	—	—	85	100	110	
	345	395	425	330	375	410	295	345	375	—	—	—	375	425	460	—	—	—	—	—	—	280	330	360	
K7	95	115	120	90	110	115	85	100	110	—	—	—	110	125	135	—	—	—	—	—	—	75	95	100	
	310	375	395	295	360	375	280	330	360	—	—	—	360	410	445	—	—	—	—	—	—	245	310	330	
S1	—	—	—	—	44	60	65	39	50	60	48	65	70	—	—	—	39	50	60	47	60	70	36	48	55
	—	—	—	145	195	215	130	165	195	155	215	230	—	—	—	130	165	195	155	195	230	120	155	180	
S2	—	—	—	—	35	47	55	32	42	50	39	50	60	—	—	—	32	42	50	38	50	60	29	38	45
	—	—	—	115	155	180	105	140	165	130	165	195	—	—	—	105	140	165	125	165	195	95	125	150	
S3	—	—	—	—	32	41	49	28	37	43	34	45	55	—	—	—	28	37	43	33	44	50	26	34	39
	—	—	—	105	135	160	90	120	140	110	150	180	—	—	—	90	120	140	110	145	165	85	110	130	
S11	—	—	—	—	60	75	85	55	70	80	65	80	90	—	—	—	55	70	80	65	80	90	50	65	75
	—	—	—	195	245	280	180	230	260	215	260	295	—	—	—	180	230	260	215	260	295	165	215	245	
S12	—	—	—	—	43	55	65	38	50	60	47	60	70	—	—	—	38	50	60	45	60	70	35	46	55
	—	—	—	140	180	215	125	165	195	155	195	230	—	—	—	125	165	195	150	195	230	115	150	180	
S13	—	—	—	—	25	33	39	22	30	35	27	36	42	—	—	—	22	30	35	26	35	41	20	27	31
	—	—	—	80	110	130	70	100	115	90	120	140	—	—	—	70	100	115	85	115	135	65	90	100	
H5	44	60	65	37	48	55	35	46	55	—	—	—	—	—	—	—	—	—	—	—	—	31	40	48	
	145	195	215	120	155	180	115	150	180	—	—	—	—	—	—	—	—	—	—	—	—	100	130	155	
H8	48	60	70	39	50	60	37	49	60	—	—	—	—	—	—	—	—	—	—	—	—	33	43	50	
	155	195	230	130	165	195	120	160	195	—	—	—	—	—	—	—	—	—	—	—	—	110	140	165	
H11	55	70	80	47	60	70	45	60	70	—	—	—	—	—	—	—	—	—	—	49	65	75	39	50	60
	180	230	260	155	195	230	150	195	230	—	—	—	—	—	—	—	—	—	—	160	215	245	130	165	195
H12	80	95	105	75	90	100	65	80	90	80	9														



SQUARE T4 HELICAL

The Square T4 Helical cutter range takes our diverse milling portfolio to the next level with tools that features tangentially mounted inserts, each having 4 cutting edges.

- T4 Helical Insert size 08, cutter range 25-54mm (1 inch)
- T4 Helical Insert size 12, cutter range 40-100mm (2 - 3 inch)

T4 – R217.94-08 – Metric

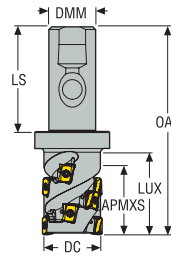

- For insert selection and cutting data recommendations, see page(s) 185-186
- For complete insert programme, see page(s) 831, 832
- For ISO attribute explanation, see page 16

Designation	Item number	Type of mounting	DC	ZEFP	ZNP	APMXS	DMM	LUX	LS	OAL	RPMX	Weight	Insert
			mm			mm	mm	mm	mm	mm		kg	
R217.94-2025.3S-029-08.2A	02926806	Seco-Weldon	25,0	2	8	29,0	20,0	44,0	50,0	100,0	20800	0,3	LOEX08..
R217.94-2025.3S-036-08.2A	02926807	Seco-Weldon	25,0	2	10	36,0	20,0	44,0	50,0	100,0	20800	0,3	LOEX08..
R217.94-2025.3S-043-08.2A	02926809	Seco-Weldon	25,0	2	12	43,0	20,0	49,0	50,0	105,0	20800	0,3	LOEX08..
R217.94-2532.3S-043-08.3A	02926813	Seco-Weldon	32,0	3	18	43,0	25,0	55,0	56,0	121,0	18400	0,5	LOEX08..
R217.94-2532.3S-050-08.3A	02926814	Seco-Weldon	32,0	3	21	50,0	25,0	59,0	56,0	125,0	18400	0,5	LOEX08..
R217.94-3240.3S-050-08.4A	02926816	Seco-Weldon	40,0	4	28	50,0	32,0	60,0	60,0	130,0	16400	0,9	LOEX08..

Spare Parts, included in delivery

For cutter	Insert key	Insert screw
R217.94-..	H4B-T08P	C02708B-T08P

Accessories

For cutter	Insert clamping torque	Torque key
R217.94-..	1.2NM	T00-08P12

Torque and fixed keys, see page 894

T4 – R217.94-08 – Inch

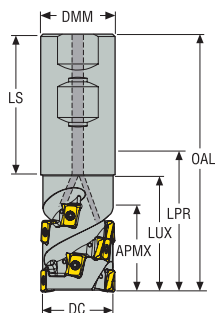

- For insert selection and cutting data recommendations, see page(s) 185-186
- For complete insert programme, see page(s) 831, 832
- For ISO attribute explanation, see page 16

Designation	Item number	Type of mounting	DC	ZEFP	ZNP	APMXS	DMM	LUX	LPR	OAL	RPMX	Weight	Insert
			inch			inch	inch	inch	inch	inch		lbs	
R217.94-01.00-3-01.40-08-2A	02941522	Weldon	0.996	2	10	1.417	1.000	1.870	1.772	4.252	20800	0.880	LOEX08..
R217.94-01.00-3-01.70-08-2A	02941527	Weldon	0.996	2	12	1.693	1.000	2.106	1.772	4.488	20800	0.880	LOEX08..

Spare Parts, included in delivery

For cutter	Insert key	Insert screw
R127.94-..	H4B-T08P	C02708B-T08P

Accessories

For size	Insert clamping torque	Torque key
R127.94-..	10.6IN.LBS	T00-08P12

Torque and fixed keys, see page 894

Square shoulder and slot milling cutters

Helical milling cutters

Face milling cutters

Disc milling cutters

High feed milling cutters

Copy milling cutters

Plunge milling cutters

Chamfer milling cutters

Spot facing cutters

Inserts

T4 – R217/220.94-08 – Metric

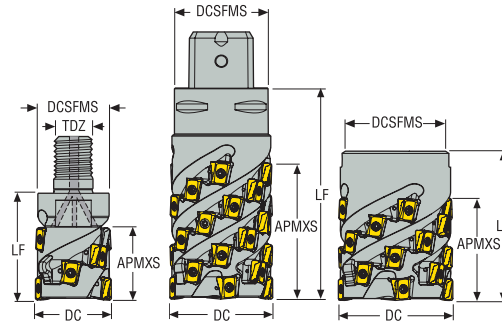

- For insert selection and cutting data recommendations, see page(s) 185-186
- For complete insert programme, see page(s) 831, 832
- For ISO attribute explanation, see page 16

Designation	Item number	Type of mounting	DC	ZEFP	ZNP	APMXS	DCB	TDZ	DCSFMS	LF	LUX	RPMX	Weight	Insert
			mm			mm	mm		mm	mm	mm		kg	
R217.94-1632.RE-036-08.3A	02926805	Combimaster	32,0	3	15	36,0	–	M16	30,0	55,0	–	18400	0,3	LOEX08..
R217.94-2040.RE-043-08.4A	02972768	Combimaster	40,0	4	24	43,0	–	M20	36,5	60,0	–	16400	0,45	LOEX08..
C4-R217.94-044-057-08.4A	02926819	Seco-Capto	44,0	4	32	57,0	–	–	40,0	90,0	70,0	15500	0,8	LOEX08..
R220.94-00050-043-08.4A	02926817	Arbor	50,0	4	24	43,0	27,0	–	48,0	65,0	–	14800	0,6	LOEX08..
R220.94-00050-057-08.5A	02926818	Arbor	50,0	5	40	57,0	27,0	–	48,0	70,0	–	14800	0,6	LOEX08..

For Combimaster Shanks, see Machining Navigator Tooling System

Spare Parts, included in delivery

For cutter	Arbor screw	Insert key	Insert screw
R217.94-../Cx-217.94-..	–	H4B-T08P	C02708B-T08P
R220.94-..	MC6S12X60	H4B-T08P	C02708B-T08P

Accessories

For cutter	Insert clamping torque	Torque key
Cx-R217/220.69-..	1.2NM	T00-08P12

Torque and fixed keys, see page 894

R217/220.94-08 – Insert selection – mm/Inch

SMG		f _z		
		100%	30%	10%
P1	LOEX080408TR-M08 F40M	0,090 0.0036	0,10 0.0040	0,15 0.0060
P2	LOEX080408TR-M08 F40M	0,090 0.0036	0,10 0.0040	0,15 0.0060
P3	LOEX080408TR-M08 F40M	0,085 0.0034	0,095 0.0038	0,14 0.0055
P4	LOEX080408TR-M08 F40M	0,085 0.0034	0,095 0.0038	0,14 0.0055
P5	LOEX080408TR-M08 F40M	0,085 0.0034	0,090 0.0036	0,14 0.0055
P6	LOEX080408TR-M08 F40M	0,080 0.0032	0,090 0.0036	0,14 0.0055
P7	LOEX080408TR-M08 F40M	0,080 0.0032	0,090 0.0036	0,14 0.0055
P8	LOEX080408TR-M08 F40M	0,085 0.0034	0,095 0.0038	0,14 0.0055
P11	LOEX080408TR-M08 MS2050	0,080 0.0032	0,090 0.0036	0,14 0.0055
P12	LOEX080408TR-M08 MS2050	0,055 0.0022	0,060 0.0024	0,095 0.0038
M1	LOEX080408TR-M08 MS2050	0,090 0.0036	0,10 0.0040	0,15 0.0060
M2	LOEX080408TR-M08 MS2050	0,085 0.0034	0,090 0.0036	0,14 0.0055
M3	LOEX080408TR-M08 MS2050	0,065 0.0026	0,075 0.0030	0,11 0.0044
M4	LOEX080408TR-M08 MS2050	0,060 0.0024	0,065 0.0026	0,095 0.0038
M5	LOEX080408TR-M08 MS2050	0,060 0.0024	0,065 0.0026	0,095 0.0038
K1	LOEX080408TR-MD08 MK2050	0,090 0.0036	0,10 0.0040	0,15 0.0060
K2	LOEX080408TR-MD08 MK2050	0,085 0.0034	0,090 0.0036	0,14 0.0055
K3	LOEX080408TR-MD08 MK2050	0,085 0.0034	0,090 0.0036	0,14 0.0055
K4	LOEX080408TR-MD08 MK2050	0,085 0.0034	0,090 0.0036	0,14 0.0055
K5	LOEX080408TR-MD08 MK2050	0,075 0.0030	0,080 0.0032	0,13 0.0050
K6	LOEX080408TR-MD08 MK2050	0,085 0.0034	0,090 0.0036	0,14 0.0055
K7	LOEX080408TR-MD08 MK2050	0,075 0.0030	0,080 0.0032	0,13 0.0050
N1	LOEX080408TR-M08 F40M	0,12 0.0048	0,13 0.0050	0,20 0.0080
N2	LOEX080408TR-M08 F40M	0,12 0.0048	0,13 0.0050	0,20 0.0080
N3	LOEX080408TR-M08 F40M	0,12 0.0048	0,13 0.0050	0,20 0.0080
N11	LOEX080408TR-M08 F40M	0,12 0.0048	0,13 0.0050	0,20 0.0080
S1	LOEX080408TR-M08 F40M	0,060 0.0024	0,065 0.0026	0,095 0.0038
S2	LOEX080408TR-M08 F40M	0,060 0.0024	0,065 0.0026	0,095 0.0038
S3	LOEX080408TR-M08 F40M	0,055 0.0022	0,060 0.0024	0,090 0.0036
S11	LOEX080408TR-M08 MS2050	0,065 0.0026	0,075 0.0030	0,11 0.0044
S12	LOEX080408TR-M08 MS2050	0,065 0.0026	0,075 0.0030	0,11 0.0044
S13	LOEX080408TR-M08 MS2050	0,060 0.0024	0,065 0.0026	0,095 0.0038
H5	LOEX080408TR-M08 MP3000	0,055 0.0022	0,060 0.0024	0,095 0.0038
H8	LOEX080408TR-M08 MP3000	0,044 0.0017	0,048 0.0019	0,070 0.0028
H11	LOEX080408TR-M08 MP3000	0,055 0.0022	0,060 0.0024	0,095 0.0038
H12	LOEX080408TR-M08 MP3000	0,044 0.0017	0,048 0.0019	0,070 0.0028

SMG = Seco material group
f_z = mm/tooth (in/tooth), v_c = m/min (sf/min), a_e/DC = %
All cutting data are start values

Square shoulder and slot milling cutters
Helical milling cutters
Face milling cutters
Disc milling cutters
High feed milling cutters
Copy milling cutters
Plunge milling cutters
Chamfer milling cutters
Spot facing cutters
Inserts

R217/220.94-08 – Cutting data $v_c = (m/min)/(sf/min)$

SMG	F40M			MP3000			MK2050			MS2050			MP2050		
	100%	30%	10%	100%	30%	10%	100%	30%	10%	100%	30%	10%	100%	30%	10%
P1	125	140	150	140	155	165	140	155	165	135	150	155	140	155	165
	410	460	490	460	510	540	460	510	540	445	490	510	460	510	540
P2	125	140	150	140	155	165	140	155	165	130	145	155	140	155	165
	410	460	490	460	510	540	460	510	540	425	475	510	460	510	540
P3	120	135	145	130	145	155	130	145	155	125	140	150	130	145	155
	395	445	475	425	475	510	425	475	510	410	460	490	425	475	510
P4	110	125	135	125	140	150	125	140	150	115	130	140	125	140	150
	360	410	445	410	460	490	410	460	490	375	425	460	410	460	490
P5	110	125	135	120	135	145	120	135	145	115	130	140	120	135	145
	360	410	445	395	445	475	395	445	475	375	425	460	395	445	475
P6	115	130	140	130	145	150	130	145	150	120	135	145	130	145	150
	375	425	460	425	475	490	425	475	490	395	445	475	425	475	490
P7	115	130	135	125	140	150	125	140	150	120	135	140	125	140	150
	375	425	445	410	460	490	410	460	490	395	445	460	410	460	490
P8	110	125	135	120	135	145	120	135	145	115	130	140	120	135	145
	360	410	445	395	445	475	395	445	475	375	425	460	395	445	475
P11	110	125	135	125	140	145	125	140	150	115	130	140	125	140	150
	360	410	445	410	460	475	410	460	490	375	425	460	410	460	490
P12	85	100	110	100	115	125	100	115	125	95	110	115	100	115	125
	280	330	360	330	375	410	330	375	410	310	360	375	330	375	410
M1	115	130	140	120	135	145	—	—	—	120	135	145	120	135	145
	375	425	460	395	445	475	—	—	—	395	445	475	395	445	475
M2	105	120	130	110	125	135	—	—	—	110	125	135	110	125	135
	345	395	425	360	410	445	—	—	—	360	410	445	360	410	445
M3	90	105	115	100	115	125	—	—	—	95	110	120	100	115	120
	295	345	375	330	375	410	—	—	—	310	360	395	330	375	395
M4	75	90	100	85	100	110	—	—	—	80	100	105	85	100	110
	245	295	330	280	330	360	—	—	—	260	330	345	280	330	360
M5	65	80	90	75	90	100	—	—	—	75	90	95	75	90	100
	215	260	295	245	295	330	—	—	—	245	295	310	245	295	330
K1	115	130	140	125	140	150	145	160	165	—	—	—	125	140	150
	375	425	460	410	460	490	475	520	540	—	—	—	410	460	490
K2	105	120	130	120	135	145	135	150	160	—	—	—	120	135	145
	345	395	425	395	445	475	445	490	520	—	—	—	395	445	475
K3	95	115	120	110	125	135	125	140	150	—	—	—	110	125	135
	310	375	395	360	410	445	410	460	490	—	—	—	360	410	445
K4	95	110	120	105	120	130	125	140	150	—	—	—	105	125	130
	310	360	395	345	395	425	410	460	490	—	—	—	345	410	425
K5	70	85	90	80	95	105	95	115	120	—	—	—	80	95	105
	230	280	295	260	310	345	310	375	395	—	—	—	260	310	345
K6	85	105	110	100	115	125	115	135	140	—	—	—	100	115	125
	280	345	360	330	375	410	375	445	460	—	—	—	330	375	410
K7	80	95	105	95	110	115	110	125	135	—	—	—	95	110	120
	260	310	345	310	360	375	360	410	445	—	—	—	310	360	395
N1	220	240	245	—	—	—	—	—	—	—	—	—	—	—	—
	720	790	800	—	—	—	—	—	—	—	—	—	—	—	—
N2	175	190	195	—	—	—	—	—	—	—	—	—	—	—	—
	570	620	640	—	—	—	—	—	—	—	—	—	—	—	—
N3	150	165	175	—	—	—	—	—	—	—	—	—	—	—	—
	490	540	570	—	—	—	—	—	—	—	—	—	—	—	—
N11	160	175	180	—	—	—	—	—	—	—	—	—	—	—	—
	520	570	590	—	—	—	—	—	—	—	—	—	—	—	—
S1	39	50	60	45	60	70	—	—	—	42	55	65	46	60	70
	130	165	195	150	195	230	—	—	—	140	180	215	150	195	230
S2	31	41	48	36	47	55	—	—	—	34	45	55	37	49	55
	100	135	155	120	155	180	—	—	—	110	150	180	120	160	180
S3	27	36	42	32	42	49	—	—	—	30	39	46	32	43	50
	90	120	140	105	140	160	—	—	—	100	130	150	105	140	165
S11	55	70	80	65	75	85	—	—	—	60	75	85	65	80	85
	180	230	260	215	245	280	—	—	—	195	245	280	215	260	280
S12	38	49	60	44	55	65	—	—	—	42	55	65	44	60	65
	125	160	195	145	180	215	—	—	—	140	180	215	145	195	215
S13	22	29	34	25	33	39	—	—	—	24	31	37	26	34	40
	70	95	110	80	110	130	—	—	—	80	100	120	85	110	130
H5	33	43	50	39	50	60	—	—	—	—	—	—	37	49	55
	110	140	165	130	165	195	—	—	—	—	—	—	120	160	180
H8	35	45	55	40	55	60	—	—	—	—	—	—	40	50	60
	115	150	180	130	180	195	—	—	—	—	—	—	130	165	195
H11	42	55	65	49	65	70	—	—	—	—	—	—	47	60	70
	140	180	215	160	215	230	—	—	—	—	—	—	155	195	230
H12	60	75	85	75	90	100	—	—	—	—	—	—	75	90	100
	195	245	280	245	295	330	—	—	—	—	—	—	245	295	330

T4 – R217/220.94-12 – Inch

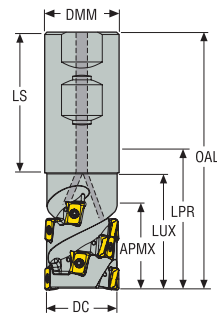

- For insert selection and cutting data recommendations, see page(s) 191-193
- For complete insert programme, see page(s) 831, 832
- For ISO attribute explanation, see page 16

Designation	Item number	Type of mounting	DC	ZEFP	ZNP	APMXS	DMM	LUX	LPR	OAL	RPMX	Weight	Insert
			inch			inch	inch	inch	inch	inch		lbs	
R217.94-02.00-3-2.28-12-4A	02998585	Weldon	2.000	4	20	2.310	1.500	3.106	4.528	5.715	9800	2.870	LOEX12..

Spare Parts, included in delivery

For cutter	Insert key	Insert screw
R217.94-..	H4B-T15P	C04012B-T15P

Accessories

For cutter	Insert clamping torque	Torque key
R217.94-..	3.5NM	T00-15P35

Torque and fixed keys, see page 894

Square shoulder and slot milling cutters

Helical milling cutters

Face milling cutters

Disc milling cutters

High feed milling cutters

Copy milling cutters

Plunge milling cutters

Chamfer milling cutters

Spot facing cutters

Inserts

T4 – R217/220.94-12 – Metric

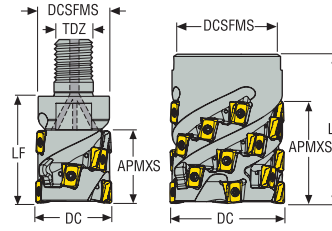

- For insert selection and cutting data recommendations, see page(s) 191-193
- For complete insert programme, see page(s) 831, 832
- For ISO attribute explanation, see page 16

Designation	Item number	Type of mounting	DC	ZEFP	ZNP	APMXS	DCB	TDZ	DCSFMS	LF	RPMX	Weight	Insert
			mm			mm	mm		mm	mm		kg	
R217.94-2040.RE-035-12.2A	03135367	Combimaster	40,0	2	6	35,0	–	M20	36,5	50,0	11000	0,4	LOEX12..
R220.94-00050-046-12.3A	02998575	Arbor	50,0	3	12	46,0	27,0	–	46,4	70,0	9900	0,5	LOEX12..
R220.94-00050-046-12.4A	02998576	Arbor	50,0	4	16	46,0	27,0	–	46,4	65,0	9900	0,5	LOEX12..
R220.94-00050-058-12.4A	02998577	Arbor	50,0	4	20	58,0	27,0	–	46,4	80,0	9900	0,6	LOEX12..
R220.94-00063-046-12.4A	02998578	Arbor	63,0	4	16	46,0	27,0	–	59,6	65,0	8800	0,9	LOEX12..
R220.94-00063-058-12.5A	02998579	Arbor	63,0	5	25	58,0	27,0	–	59,6	75,0	8800	1,1	LOEX12..
R220.94-00063-081-12.4A	02998580	Arbor	63,0	4	28	81,0	27,0	–	59,6	93,0	8800	1,3	LOEX12..
R220.94-00080-069-12.5A	02998581	Arbor	80,0	5	30	69,0	32,0	–	76,6	90,0	7800	2,2	LOEX12..
R220.94-00100-081-12.6A	02998583	Arbor	100,0	6	42	81,0	40,0	–	96,7	93,0	7000	3,7	LOEX12..

For Combimaster Shanks, see Machining Navigator Tooling System

Spare Parts, included in delivery

For cutter	Arbor screw	Insert key	Insert screw
R217.94-..	–	H4B-T15P	C04012B-T15P
R220.94-..Ø50-63	MC6S12X60	H4B-T15P	C04012B-T15P
R220.94-..Ø50-63-058	MC6S12X70	H4B-T15P	C04012B-T15P
R220.94-..Ø63-081	MP6S12X80	H4B-T15P	C04012B-T15P
R220.94-..Ø80	MP6S16X80	H4B-T15P	C04012B-T15P
R220.94-..Ø100	MP6S20X80	H4B-T15P	C04012B-T15P

Accessories

For cutter	Insert clamping torque	Torque key
R217.94-..	3.5NM	T00-15P35

Torque and fixed keys, see page 894

T4 – R217/220.94-12 – Inch

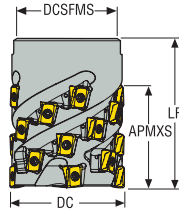

- For insert selection and cutting data recommendations, see page(s) 191-193
- For complete insert programme, see page(s) 831, 832
- For ISO attribute explanation, see page 16

Designation	Item number	Type of mounting	DC	ZEFP	ZNP	APMXS	DCB	DCSFMS	LF	RPMX	Weight	Insert
			inch			inch	inch	inch	inch		lbs	
R220.94-02.00-1.81-12-3A	02998586	Arbor	2.000	3	12	1.850	1.000	1.862	2.756	9800	1.320	LOEX12..
R220.94-02.00-2.28-12-4A	02998587	Arbor	2.000	4	20	2.283	1.000	1.862	3.150	9800	1.540	LOEX12..
R220.94-02.50-3.18-12-4A	02998589	Arbor	2.500	4	28	3.189	1.000	2.366	3.661	8800	2.870	LOEX12..
R220.94-02.50-3.18-12.4SA	03169706	Arbor	2.500	4	28	3.211	1.000	2.358	3.937	8800	3.090	LOEX12..
R220.94-03.00-3.18-12-5A	02998590	Arbor	3.000	5	35	3.189	1.250	2.870	3.740	8000	4.410	LOEX12..
R220.94-03.00-3.18-12.5SA	03169707	Arbor	3.000	5	35	3.211	1.250	2.858	3.937	7800	5.510	LOEX12..

Spare Parts, included in delivery

For cutter	Arbor screw	Basic body	Insert key	Insert screw	Replaceable end
R217.94-02.00-3A	UC6S1/2UNFX2-1/4	-	H4B-T15P	C04012B-T15P	-
R217.94-02.00-4A	UC6S1/2UNFX2-1/2	-	H4B-T15P	C04012B-T15P	-
R217.94-02.50	UP6S1/2UNFX3-1/4	-	H4B-T15P	C04012B-T15P	-
R217.94-02.50S	UP6S1/2UNFX3-1/4	R220.94-02.50-1.76-12.4BA	H4B-T15P	C04012B-T15P	R220.94-RE2.50-1.42-12.4A
R220.94-03.00	UP6S5/8UNFX3-1/4	-	H4B-T15P	C04012B-T15P	-
R220.94-03.00S	UP6S5/8UNFX3-1/4	R220.94-03.00-1.76-12.5BA	H4B-T15P	C04012B-T15P	R220.94-RE3.00-1.42-12.5A

Accessories

For cutter	Coolant kit	Insert clamping torque	Torque key
R220.94-..	-	3.5NM	T00-15P35
R220.94-..4SA	LUBRICATION_SET_19	3.5NM	T00-15P35
R220.94-..5SA	LUBRICATION_SET_29	3.5NM	T00-15P35

Torque and fixed keys, see page 894

T4 – R217/220.94-12 – Metric

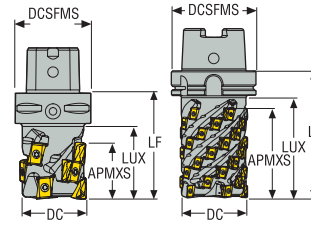

- For insert selection and cutting data recommendations, see page(s) 191-193
- For complete insert programme, see page(s) 831, 832
- For ISO attribute explanation, see page 16

Designation	Item number	Type of mounting	DC	ZEFP	ZNP	APMXS	DCSFMS	LF	LUX	RPMX	Weight	Insert
			mm			mm	mm	mm	mm		kg	
C5-R217.94-044-058-12.3A	03134236	Seco-Capto	44,0	3	15	58,0	50,0	95,0	73,0	10600	0,9	LOEX12..
C6-R217.94-050-081-12.4SA	03169703	Seco-Capto	50,0	4	28	81,0	63,0	115,0	91,0	10000	1,4	LOEX12..
C5-R217.94-054-069-12.4A	03134237	Seco-Capto	54,0	4	24	70,0	50,0	105,0	84,1	9700	1,3	LOEX12..
C6-R217.94-063-092-12.4SA	03169704	Seco-Capto	63,0	4	32	92,0	63,0	125,0	101,5	9000	2,3	LOEX12..
C6-R217.94-066-081-12.5A	03134238	Seco-Capto	66,0	5	35	81,0	63,0	115,0	101,7	8700	2,3	LOEX12..
R217.94-HSK100A-080-104-12.5SA	03169705	HSK	80,0	5	45	104,0	100,0	150,0	118,5	7800	5,4	LOEX12..

Spare Parts, included in delivery

For cutter	Assembly screw	Basic body	Insert key	Insert screw	Replaceable end
Cx-R217.94-..	–	–	H4B-T15P	C04012B-T15P	–
C6-R217.94-..050	220.17-692M	C6-R217.94-050-058-12.4BA	H4B-T15P	C04012B-T15P	R220.94-RE050023-12.4A
C6-R217.94-..063	MC6S12X35	C6-R217.94-063-056-12.4BA	H4B-T15P	C04012B-T15P	R220.94-RE063036-12.4A
R220.94-HSK100	MC6S16X40	R217.94-HSK100A-080-68-12.5BA	H4B-T15P	C04012B-T15P	R220.94-RE080036-12.5A

Accessories

For cutter	Coolant kit	Insert clamping torque	Torque key
Cx-R217.94-..	–	3.5NM	T00-15P35
Cx-R217.94-050-081	LUBRICATION_SET_19	3.5NM	T00-15P35
Cx-R217.94-063-092	LUBRICATION_SET_29	3.5NM	T00-15P35
R217.94-..HSK	LUBRICATION_SET_36	3.5NM	T00-15P35

Torque and fixed keys, see page 894

R217/220.94-12 – Insert selection – mm/Inch

SMG		f _z		
		100%	30%	10%
P1	LOEX120708R-M09 MP2501	0,10	0,11	0,17
		0.0040	0.0044	0.0065
P2	LOEX120708R-M09 MP2501	0,10	0,11	0,17
		0.0040	0.0044	0.0065
P3	LOEX120708R-M09 MP2501	0,095	0,11	0,16
		0.0038	0.0044	0.0065
P4	LOEX120708TR-M12 MP2501	0,13	0,14	0,22
		0.0050	0.0055	0.0085
P5	LOEX120708TR-M12 MP2501	0,12	0,14	0,20
		0.0048	0.0055	0.0080
P6	LOEX120708TR-M12 MP2501	0,12	0,13	0,20
		0.0048	0.0050	0.0080
P7	LOEX120708TR-M12 MP2501	0,12	0,13	0,20
		0.0048	0.0050	0.0080
P8	LOEX120708TR-M12 MP2501	0,13	0,14	0,22
		0.0050	0.0055	0.0085
P11	LOEX120708TR-M12 MS2500	0,12	0,13	0,20
		0.0048	0.0050	0.0080
P12	LOEX120708TR-M12 MS2500	0,085	0,095	0,14
		0.0034	0.0038	0.0055
M1	LOEX120708R-M09 MS2050	0,11	0,12	0,19
		0.0044	0.0048	0.0075
M2	LOEX120708R-M09 MS2050	0,10	0,11	0,17
		0.0040	0.0044	0.0065
M3	LOEX120708R-M09 MS2050	0,085	0,090	0,14
		0.0034	0.0036	0.0055
M4	LOEX120708TR-M12 MS2050	0,095	0,10	0,16
		0.0038	0.0040	0.0065
M5	LOEX120708TR-M12 MS2050	0,095	0,10	0,16
		0.0038	0.0040	0.0065
K1	LOEX120708TR-MD13 MK2050	0,16	0,17	0,26
		0.0065	0.0070	0.010
K2	LOEX120708TR-MD13 MK2050	0,15	0,16	0,24
		0.0060	0.0065	0.0095
K3	LOEX120708TR-MD13 MK2050	0,15	0,16	0,24
		0.0060	0.0065	0.0095
K4	LOEX120708TR-MD13 MK2050	0,15	0,16	0,24
		0.0060	0.0065	0.0095
K5	LOEX120708TR-MD13 MK2050	0,13	0,14	0,22
		0.0050	0.0055	0.0085
K6	LOEX120708TR-MD13 MK2050	0,15	0,16	0,24
		0.0060	0.0065	0.0095
K7	LOEX120708TR-MD13 MK2050	0,13	0,14	0,22
		0.0050	0.0055	0.0085
N1	LOEX120708R-M09 F40M	0,15	0,16	0,24
		0.0060	0.0065	0.0095
N2	LOEX120708R-M09 F40M	0,15	0,16	0,24
		0.0060	0.0065	0.0095
N3	LOEX120708R-M09 F40M	0,15	0,16	0,24
		0.0060	0.0065	0.0095
N11	LOEX120708R-M09 F40M	0,15	0,16	0,24
		0.0060	0.0065	0.0095
S1	LOEX120708TR-M12 F40M	0,095	0,10	0,16
		0.0038	0.0040	0.0065
S2	LOEX120708TR-M12 F40M	0,095	0,10	0,16
		0.0038	0.0040	0.0065
S3	LOEX120708TR-M12 F40M	0,090	0,095	0,15
		0.0036	0.0038	0.0060
S11	LOEX120716R-M09 MS2050	0,085	0,090	0,14
		0.0034	0.0036	0.0055
S12	LOEX120708R-M09 MS2050	0,085	0,090	0,14
		0.0034	0.0036	0.0055
S13	LOEX120708R-M09 MS2050	0,075	0,080	0,12
		0.0030	0.0032	0.0048
H5	LOEX120708TR-MD13 MP1501	0,090	0,10	0,15
		0.0036	0.0040	0.0060
H8	LOEX120708TR-MD13 MP1501	0,070	0,075	0,12
		0.0028	0.0030	0.0048
H11	LOEX120708TR-MD13 MP1501	0,090	0,10	0,15
		0.0036	0.0040	0.0060
H12	LOEX120708TR-M12 MS2500	0,065	0,070	0,11
		0.0026	0.0028	0.0044

SMG = Seco material group
f_z = mm/tooth (in/tooth), v_c = m/min (sf/min), a_e/DC = %
All cutting data are start values

Square shoulder and slot milling cutters
Helical milling cutters
Face milling cutters
Disc milling cutters
High feed milling cutters
Copy milling cutters
Plunge milling cutters
Chamfer milling cutters
Spot facing cutters
Inserts

R217/220.94-12 – Cutting data $v_c = (m/min)/(sf/min)$

SMG	MP1501			MP2501			MP3000			T350M			F40M			MP2050		
	100%	30%	10%	100%	30%	10%	100%	30%	10%	100%	30%	10%	100%	30%	10%	100%	30%	10%
P1	165	180	195	160	180	190	155	175	185	150	165	180	140	160	170	155	175	185
	540	590	640	520	590	620	510	570	610	490	540	590	460	520	560	510	570	610
P2	160	180	190	155	175	185	150	170	180	145	165	175	135	155	165	155	175	185
	520	590	620	510	570	610	490	560	590	475	540	570	445	510	540	510	570	610
P3	155	170	180	150	165	180	145	160	175	140	155	165	130	150	160	145	165	175
	510	560	590	490	540	590	475	520	570	460	510	540	425	490	520	475	540	570
P4	145	165	175	140	160	170	135	155	165	130	150	160	120	140	150	135	155	165
	475	540	570	460	520	560	445	510	540	425	490	520	395	460	490	445	510	540
P5	140	160	170	140	155	170	130	150	165	125	145	155	115	135	150	135	155	165
	460	520	560	460	510	560	425	490	540	410	475	510	375	445	490	445	510	540
P6	150	170	180	145	165	175	140	160	170	135	155	165	125	145	155	145	160	175
	490	560	590	475	540	570	460	520	560	445	510	540	410	475	510	475	520	570
P7	145	165	175	140	160	170	135	155	165	130	150	160	120	140	150	140	155	170
	475	540	570	460	520	560	445	510	540	425	490	520	395	460	490	460	510	560
P8	140	160	170	135	155	165	130	150	160	125	145	155	115	135	145	135	155	165
	460	520	560	445	510	540	425	490	520	410	475	510	375	445	475	445	510	540
P11	145	160	175	140	160	170	135	155	165	130	145	160	120	140	150	135	155	165
	475	520	570	460	520	560	445	510	540	425	475	520	395	460	490	445	510	540
P12	115	135	145	110	130	140	105	125	135	100	120	130	90	110	120	110	125	140
	375	445	475	360	425	460	345	410	445	330	395	425	295	360	395	360	410	460
M1	—	—	—	135	155	165	135	150	165	130	150	160	125	140	155	130	150	160
	—	—	—	445	510	540	445	490	540	425	490	520	410	460	510	425	490	520
M2	—	—	—	125	140	155	120	140	150	115	135	145	110	130	140	120	140	150
	—	—	—	410	460	510	395	460	490	375	445	475	360	425	460	395	460	490
M3	—	—	—	110	130	140	105	125	135	105	120	135	95	115	125	105	125	135
	—	—	—	360	425	460	345	410	445	345	395	445	310	375	410	345	410	445
M4	—	—	—	90	110	120	90	110	120	85	105	115	80	100	110	90	110	120
	—	—	—	295	360	395	295	360	395	280	345	375	260	330	360	295	360	395
M5	—	—	—	80	100	110	80	95	105	75	95	105	70	85	95	75	95	105
	—	—	—	260	330	360	260	310	345	245	310	345	230	280	310	245	310	345
K1	145	165	175	140	160	170	135	155	165	130	150	160	120	140	150	—	—	—
	475	540	570	460	520	560	445	510	540	425	490	520	395	460	490	—	—	—
K2	140	155	170	135	150	165	130	145	160	125	140	155	115	135	145	—	—	—
	460	510	560	445	490	540	425	475	520	410	460	510	375	445	475	—	—	—
K3	125	145	160	125	140	155	115	135	150	110	130	145	100	120	135	—	—	—
	410	475	520	410	460	510	375	445	490	360	425	475	330	395	445	—	—	—
K4	125	145	155	120	140	150	115	135	145	110	130	140	100	120	130	—	—	—
	410	475	510	395	460	490	375	445	475	360	425	460	330	395	425	—	—	—
K5	90	110	120	90	105	115	80	100	110	75	95	105	70	85	100	—	—	—
	295	360	395	295	345	375	260	330	360	245	310	345	230	280	330	—	—	—
K6	115	135	145	110	130	140	105	125	135	100	120	130	90	110	120	—	—	—
	375	445	475	360	425	460	345	410	445	330	395	425	295	360	395	—	—	—
K7	110	125	140	105	125	135	100	120	130	95	110	125	85	105	115	—	—	—
	360	410	460	345	410	445	330	395	425	310	360	410	280	345	375	—	—	—
N1	—	—	—	—	—	—	—	—	—	—	—	—	255	275	285	—	—	—
	—	—	—	—	—	—	—	—	—	—	—	—	840	900	940	—	—	—
N2	—	—	—	—	—	—	—	—	—	—	—	—	195	215	225	—	—	—
	—	—	—	—	—	—	—	—	—	—	—	—	640	710	740	—	—	—
N3	—	—	—	—	—	—	—	—	—	—	—	—	165	185	195	—	—	—
	—	—	—	—	—	—	—	—	—	—	—	—	540	610	640	—	—	—
N11	—	—	—	—	—	—	—	—	—	—	—	—	175	195	205	—	—	—
	—	—	—	—	—	—	—	—	—	—	—	—	570	640	670	—	—	—
S1	—	—	—	47	65	75	44	60	70	42	55	65	38	50	60	46	60	70
	—	—	—	155	215	245	145	195	230	140	180	215	125	165	195	150	195	230
S2	—	—	—	38	50	60	35	47	55	34	45	50	31	41	48	37	49	55
	—	—	—	125	165	195	115	155	180	110	150	165	100	135	155	120	160	180
S3	—	—	—	34	44	50	31	41	48	29	39	46	27	36	42	32	43	50
	—	—	—	110	145	165	100	135	155	95	130	150	90	120	140	105	140	165
S11	—	—	—	65	85	95	60	80	90	60	75	90	55	70	80	65	80	95
	—	—	—	215	280	310	195	260	295	195	245	295	180	230	260	215	260	310
S12	—	—	—	46	60	70	42	55	65	40	55	65	36	48	55	44	60	70
	—	—	—	150	195	230	140	180	215	130	180	215	120	155	180	145	195	230
S13	—	—	—	27	35	42	25	33	39	24	31	37	21	28	33	26	34	40
	—	—	—	90	115	140	80	110	130	80	100	120	70	90	110	85	110	130
H5	46	60	70	39	50	60	38	50	60	37	49	60	32	42	50	—	—	—
	150	195	230	130	165	195	125	165	195	120	160	195	105	140	165	—	—	—
H8	49	65	75	42	55	65	40	55	60	40	50	60	34	46	55	—	—	—
	160	215	245	140	180	215	130	180	195	130	165	195	110	150	180	—	—	—
H11	60	75	90	50	65	75	48	65	75	47	60	75	41	55	65	48	65	75
	195	245	295	165	215	245	155	215	245	155	195	245	135	180	215	155	215	245
H12	85	105	115	80	100	110	75	95	105	70	90	100	60	80	90	80	95	110
	280	345	375	260	330	360	245	310	345	230	295	330	195	260	295	260	310	360

R217/220.94-12 – Cutting data $v_c = (m/min)/(sf/min)$

SMG	MK1500			MK2050			MS2050			MS2500			MM4500		
	100%	30%	10%	100%	30%	10%	100%	30%	10%	100%	30%	10%	100%	30%	10%
P1	—	—	—	155	170	185	150	170	180	165	185	195	130	150	160
	—	—	—	510	560	610	490	560	590	540	610	640	425	490	520
P2	—	—	—	150	170	180	150	170	180	165	180	190	130	150	160
	—	—	—	490	560	590	490	560	590	540	590	620	425	490	520
P3	—	—	—	140	160	170	140	160	170	155	175	185	120	140	150
	—	—	—	460	520	560	460	520	560	510	570	610	395	460	490
P4	—	—	—	135	155	165	130	150	160	145	165	175	110	130	140
	—	—	—	445	510	540	425	490	520	475	540	570	360	425	460
P5	—	—	—	130	150	160	130	150	160	145	160	175	110	130	140
	—	—	—	425	490	520	425	490	520	475	520	570	360	425	460
P6	—	—	—	140	160	170	140	155	165	150	170	180	115	135	145
	—	—	—	460	520	560	460	510	540	490	560	590	375	445	475
P7	—	—	—	135	155	165	135	150	165	150	165	180	115	130	145
	—	—	—	445	510	540	445	490	540	490	540	590	375	425	475
P8	—	—	—	130	150	160	130	145	160	145	160	170	110	125	140
	—	—	—	425	490	520	425	475	520	475	520	560	360	410	460
P11	—	—	—	135	150	165	130	150	160	145	165	175	110	130	140
	—	—	—	445	490	540	425	490	520	475	540	570	360	425	460
P12	—	—	—	105	125	135	105	120	130	115	135	145	80	100	110
	—	—	—	345	410	445	345	395	425	375	445	475	260	330	360
M1	—	—	—	—	—	—	135	155	165	140	160	170	120	140	150
	—	—	—	—	—	—	445	510	540	460	520	560	395	460	490
M2	—	—	—	—	—	—	125	140	150	130	145	160	105	125	135
	—	—	—	—	—	—	410	460	490	425	475	520	345	410	445
M3	—	—	—	—	—	—	110	125	135	115	135	145	90	110	120
	—	—	—	—	—	—	360	410	445	375	445	475	295	360	395
M4	—	—	—	—	—	—	90	110	120	95	115	125	75	95	105
	—	—	—	—	—	—	295	360	395	310	375	410	245	310	345
M5	—	—	—	—	—	—	80	95	110	85	105	115	65	80	90
	—	—	—	—	—	—	260	310	360	280	345	375	215	260	295
K1	160	180	190	155	175	185	—	—	—	—	—	—	—	—	—
	520	590	620	510	570	610	—	—	—	—	—	—	—	—	—
K2	150	170	180	150	165	180	—	—	—	—	—	—	—	—	—
	490	560	590	490	540	590	—	—	—	—	—	—	—	—	—
K3	140	160	170	135	155	170	—	—	—	—	—	—	—	—	—
	460	520	560	445	510	560	—	—	—	—	—	—	—	—	—
K4	135	155	170	135	155	165	—	—	—	—	—	—	—	—	—
	445	510	560	445	510	540	—	—	—	—	—	—	—	—	—
K5	105	125	135	100	120	130	—	—	—	—	—	—	—	—	—
	345	410	445	330	395	425	—	—	—	—	—	—	—	—	—
K6	130	150	160	125	145	155	—	—	—	—	—	—	—	—	—
	425	490	520	410	475	510	—	—	—	—	—	—	—	—	—
K7	120	140	150	120	135	150	—	—	—	—	—	—	—	—	—
	395	460	490	395	445	490	—	—	—	—	—	—	—	—	—
N1	—	—	—	—	—	—	—	—	—	—	—	—	—	—	—
	—	—	—	—	—	—	—	—	—	—	—	—	—	—	—
N2	—	—	—	—	—	—	—	—	—	—	—	—	—	—	—
	—	—	—	—	—	—	—	—	—	—	—	—	—	—	—
N3	—	—	—	—	—	—	—	—	—	—	—	—	—	—	—
	—	—	—	—	—	—	—	—	—	—	—	—	—	—	—
N11	—	—	—	—	—	—	—	—	—	—	—	—	—	—	—
	—	—	—	—	—	—	—	—	—	—	—	—	—	—	—
S1	—	—	—	—	—	—	45	60	70	50	70	80	23	30	36
	—	—	—	—	—	—	150	195	230	165	230	260	75	100	120
S2	—	—	—	—	—	—	36	48	55	42	55	65	18	25	29
	—	—	—	—	—	—	120	155	180	140	180	215	60	80	95
S3	—	—	—	—	—	—	32	42	50	37	48	55	16	21	25
	—	—	—	—	—	—	105	140	165	120	155	180	50	70	80
S11	—	—	—	—	—	—	60	80	90	70	90	100	32	43	50
	—	—	—	—	—	—	195	260	295	230	295	330	105	140	165
S12	—	—	—	—	—	—	43	60	70	50	65	75	30	39	46
	—	—	—	—	—	—	140	195	230	165	215	245	100	130	150
S13	—	—	—	—	—	—	25	33	39	29	39	45	17	23	27
	—	—	—	—	—	—	80	110	130	95	130	150	55	75	90
H5	—	—	—	—	—	—	—	—	—	—	—	—	—	—	—
	—	—	—	—	—	—	—	—	—	—	—	—	—	—	—
H8	—	—	—	—	—	—	—	—	—	—	—	—	—	—	—
	—	—	—	—	—	—	—	—	—	—	—	—	—	—	—
H11	—	—	—	—	—	—	—	—	—	—	—	—	—	—	—
	—	—	—	—	—	—	—	—	—	—	—	—	—	—	—
H12	—	—	—	—	—	—	—	—	—	—	—	—	—	—	—
	—	—	—	—	—	—	—	—	—	—	—	—	—	—	—

Square shoulder and slot milling cutters
Helical milling cutters
Face milling cutters
Disc milling cutters
High feed milling cutters
Copy milling cutters
Plunge milling cutters
Chamfer milling cutters
Spot facing cutters
Inserts

Square shoulder and
slot milling cutters

Helical milling cutters

Face milling cutters

Disc milling cutters

High feed milling
cutters

Copy milling cutters

Plunge milling cutters

Chamfer milling cutters

Spot facing cutters

Inserts



R215/220.59 HELICAL

Our comprehensive selection of high-performance helical milling cutters incorporate the latest geometries and grades to achieve high feed rates, large depths of cut and aggressive metal removal in contouring and profiling operations. The helix angle allows the cutter to absorb most of the end load so it smoothly enter and exit the workpiece.

- Cutter range 50-100 mm (2 inch)
- Many options for different types of mounting

R215.59-12.4..K – Half effective – Metric

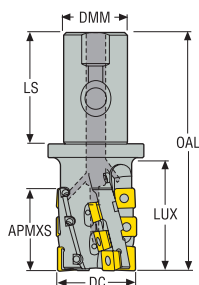



- For insert selection and cutting data recommendations, see page(s) 201-202
- For complete insert programme, see page(s) 829,843
- For ISO attribute explanation, see page 16

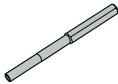

Designation	Item number	Type of mounting	DC	ZEFP	ZNP	APMXS	DMM	LS	LUX	OAL	RPMX	Weight	SC.T	AC.T
			mm			mm	mm	mm	mm	mm		kg		
R215.59-4050.3S-050-12.4A	75066227	Seco-Weldon	50,0	2	12	50,0	40,0	70,0	67,0	150,0	8300	1,4	10	2

Modification of the cutter body needed for radii > 3,0 mm

Spare Parts, included in delivery

For cutter	Insert key	Insert screw
		
R215.59-..	H6B-T20P	C45011-T20P

Accessories

For cutter	Insert clamping torque	Torque key
		
R215.59-..	5.0NM	T00-20P50

Torque and fixed keys, see page 894

Square shoulder and slot milling cutters

Helical milling cutters

Face milling cutters

Disc milling cutters

High feed milling cutters

Copy milling cutters

Plunge milling cutters

Chamfer milling cutters

Spot facing cutters

Inserts

R215.59-12.4 – Half effective – Metric

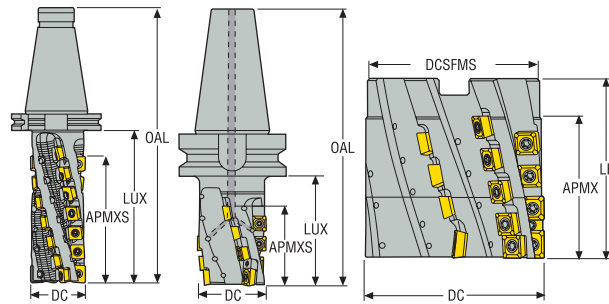





- For insert selection and cutting data recommendations, see page(s) 201-202
- For complete insert programme, see page(s) 829,843
- For ISO attribute explanation, see page 16

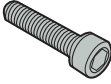

Designation	Item number	Type of mounting	DC	ZEFP	ZNP	APMXS	DCB	DCSFMS	LF	LUX	RPMX	Weight	SC.T	AC.T
			mm			mm	mm	mm	mm	mm		kg		
R215.59-BT50.050.059-12.4A	75066230	BT50	50,0	2	14	59,0	–	100,0	135,0	92,0	8300	4,5	12	2
R215.59-BT50.050.077-12.4A	75066231	BT50	50,0	2	18	77,0	–	100,0	148,0	110,0	8300	4,5	18	2
R215.59-BT50.063.086-12.4S	75034445	BT50	63,0	2	18	86,0	–	100,0	162,9	125,0	7400	6,8	18	2
R215.59-BT50.080.095-12.4S	75034446	BT50	80,0	2	22	96,0	–	100,0	173,0	135,0	6500	6,6	20	2
R215.59-50063120-12.4S	00026979	DIN2080	63,0	2	28	122,8	–	97,45	200,0	165,0	7400	5,6	26	2
R220.59-00063.059-12.4	75001999	Arbor	63,0	2	14	59,0	27,0	62,0	70,0	–	7400	0,9	12	2
R220.59-00080.068-12.4	75000111	Arbor	80,0	2	16	68,0	32,0	77,0	85,0	–	6500	1,5	14	2
R220.59-00080.068-12.6	75000109	Arbor	80,0	3	24	68,0	32,0	77,0	85,0	–	6500	2,2	21	3
R220.59-00100077-12.6S	75000112	Arbor	100,0	3	27	77,0	40,0	90,0	100,0	–	5800	3,7	24	3
R220.59-00100077-12.6SR6	75000247	Arbor	100,0	3	24	77,0	40,0	90,0	100,0	–	5800	4,4	21*	3*
R220.59-00100077-12.8S	75000113	Arbor	100,0	4	36	77,0	40,0	90,0	100,0	–	5800	3,9	32	3
R220.59-00100077-12.8SR6	75000248	Arbor	100,0	4	32	77,0	40,0	90,0	100,0	–	5800	4,5	28	4

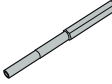
Modification of the cutter body needed for radii > 3,0 mm
 *Compatible with radii 6.0 mm only

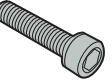
Spare Parts, included in delivery

For cutter	Arbor screw	Assembly screw	Basic body	Insert key	Insert screw	Replaceable end	Tenon	Tenon screw
								
R215.59-050	-	-	-	H6B-T20P	C45011-T20P	-	-	-
R215.59-060	-	215.59-691	R215.59-BT50.063.062-12.4B	H6B-T20P	C45011-T20P	R220.59-RE063024-12.4	-	-
R220.59-080	-	215.59-692S	R215.59-BT50.080.061-12.4B	H6B-T20PL	C45011-T20P	R220.59-RE080034-12.4	DK1010	TCEI0412
R215.59-50-4S	-	215.59-691	R215.59-CV50/50063096-12.4B	H6B-T20P	C45011-T20P	R220.59-RE063024-12.4	-	-
R220.59-00063	MC6S12X50	-	-	H6B-T20P	C45011-T20P	-	-	-
R220.59-00080	MC6S16X70	-	-	H6B-T20P	C45011-T20P	-	-	-
R220.59-00100..6S	215.59-693S	-	R220.59-00100043-12.6B	H6B-T20PL	C45011-T20P	R220.59-RE100034-12.6	DK1210	TCEI0412
R220.59-00100..6SR	215.59-693S	-	R220.59-00100043-12.6B	H6B-T20PL	C45011-T20P	R220.59-RE100034-12.6R6	DK1210	TCEI0412
R220.59-00100..8S	215.59-693S	-	R220.59-00100043-12.8B	H6B-T20PL	C45011-T20P	R220.59-RE100034-12.8	DK1210	TCEI0412
R220.59-00100..8SR	215.59-693S	-	R220.59-00100043-12.8B	H6B-T20PL	C45011-T20P	R220.59-RE100034-12.8R6	DK1210	TCEI0412

Accessories

For cutter	Insert clamping torque	Torque key
		
R215.59-..	5.0NM	T00-20P50

Torque and fixed keys, see page 894

Square shoulder and slot milling cutters
Helical milling cutters
Face milling cutters
Disc milling cutters
High feed milling cutters
Copy milling cutters
Plunge milling cutters
Chamfer milling cutters
Spot facing cutters
Inserts

R215.59-12.4 – Half effective – Metric

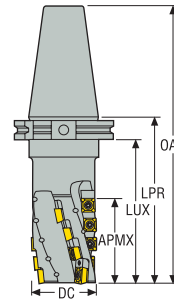

- For insert selection and cutting data recommendations, see page(s) 201-202
- For complete insert programme, see page(s) 829,843
- For ISO attribute explanation, see page 16

Designation	Item number	Type of mounting	DC	ZEFP	ZNP	APMXS	LF	LUX	RPMX	Weight	SC.T	AC.T
			mm			mm	mm	mm		kg		
R215.59-CV50050.077-12.4A	75066136	CV50	50,0	2	18	77,0	150,0	100,0	8300	4,2	16	2
R215.59-CV50050120-12.4	00026978	CV50	50,0	2	28	122,9	180,0	145,0	8300	4,5	26	2
R215.59-CV50063086-12.4S	75003346	CV50	63,0	2	20	86,0	160,0	120,0	7400	5,0	18	2
R215.59-CV50063086-12.4SR6	75000244	CV50	63,0	2	20	86,0	160,0	120,0	7400	5,1	16*	2*
R215.59-CV50063120-12.4S	00026980	CV50	63,0	2	28	122,8	200,0	165,0	7400	5,6	26	2
R215.59-CV50063120-12.4SR6	00027074	CV50	63,0	2	28	122,8	199,9	165,0	7400	5,8	24	2
R215.59-CV50063160-12.4S	00095805	CV50	63,0	2	36	158,7	234,9	200,0	7400	6,2	34	2
R215.59-CV50063160-12.4SR6	00095807	CV50	63,0	2	36	158,7	234,9	200,0	7400	6,2	32	2
R215.59-CV50080095-12.4S	75007713	CV50	80,0	2	22	96,0	150,0	131,0	6500	5,5	20	2
R215.59-CV50080095-12.6S	75003347	CV50	80,0	3	33	96,0	150,0	131,0	6500	5,9	30	3

Modification of the cutter body needed for radii > 3,0 mm
*Compatible with radii 6.0 mm only

Spare Parts, included in delivery

For cutter	Assembly screw	Basic body	Insert key	Insert screw	Replaceable end	Tenon	Tenon screw
R215.59-CV50-12.4	-	-	H6B-T20P	C45011-T20P	-	-	-
R215.59-CV5006-12.4S	215.59-691	R215.59-CV50063062-12.4B	H6B-T20P	C45011-T20P	R220.59-RE063024-12.4	-	-
R215.59-CV50-12.4SR	215.59-691	R215.59-CV50063062-12.4B	H6B-T20P	C45011-T20P	R220.59-RE063024-12.4R6	-	-
R215.59-63-120-12.4S	215.59-691	R215.59-CV50/50063096-12.4B	H6B-T20P	C45011-T20P	R220.59-RE063024-12.4	-	-
R215.59-63-120-12.4SR	215.59-691	R215.59-CV50/50063096-12.4B	H6B-T20P	C45011-T20P	R220.59-RE063024-12.4R6	-	-
R215.59-63-160-12.4S	215.59-691	R215.59-CV50/50063134-12.4B	H6B-T20P	C45011-T20P	R220.59-RE063024-12.4	-	-
R215.59-63-160-12.4SR	215.59-691	R215.59-CV50/50063134-12.4B	H6B-T20P	C45011-T20P	R220.59-RE063024-12.4R6	-	-
R215.59-CV5008-12.4S	215.59-692S	R215.59-CV50080061-12.4B	H6B-T20PL	C45011-T20P	R220.59-RE080034-12.4	DK1010	TCEI0412
R220.59-080-12.6S	215.59-692S	R215.59-CV50080061-12.6B	H6B-T20PL	C45011-T20P	R220.59-RE080034-12.6	DK1010	TCEI0412

Accessories

For cutter	Insert clamping torque	Torque key
R215.59-..	5.0NM	T00-20P50

Torque and fixed keys, see page 894

R215.59-12.4..K – Full effective – Metric

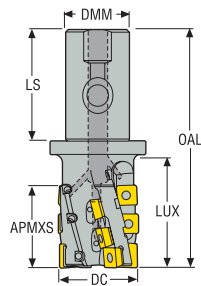

- For insert selection and cutting data recommendations, see page(s) 201-202
- For complete insert programme, see page(s) 829,843
- For ISO attribute explanation, see page 16

Designation	Item number	Type of mounting	DC	ZEFP	ZNP	APMXS	DMM	LS	LUX	OAL	RPMX	Weight	SC.T	AC.T
			mm			mm	mm	mm	mm	mm		kg		
R215.59-4050.3S-063-12.3K	00092248	Seco-Weldon	50,0	3	18	63,0	40,0	70,0	78,0	160,0	8300	1,5	15	3

Modification of the cutter body needed for radii > 3,0 mm

Spare Parts, included in delivery

For cutter	Insert key	Insert screw
R215.59-..	H6B-T20P	C45011-T20P

Accessories

For cutter	Insert clamping torque	Torque key
R215.59-..	5.0NM	T00-20P50

Torque and fixed keys, see page 894

Square shoulder and slot milling cutters

Helical milling cutters

Face milling cutters

Disc milling cutters

High feed milling cutters

Copy milling cutters

Plunge milling cutters

Chamfer milling cutters

Spot facing cutters

Inserts

R215/220.59-12.4 – Full effective – Metric

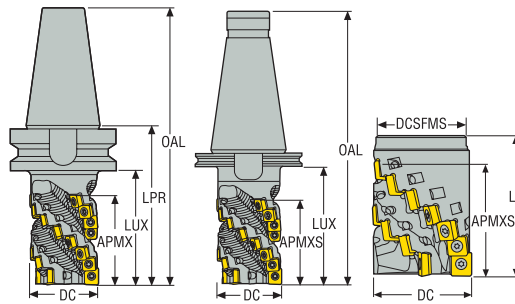

- For insert selection and cutting data recommendations, see page(s) 201-202
- For complete insert programme, see page(s) 829,843
- For ISO attribute explanation, see page 16

Designation	Item number	Type of mounting	DC	ZEFP	ZNP	APMX	DCB	DCSFMS	LF	LUX	RPMX	Weight	SC.T	AC.T
			mm			mm	mm	mm	mm	mm		kg		
R215.59-BT50050072-12.3K	00008459	BT50	50,0	3	21	73,0	–	100,0	145,0	103,0	8300	4,9	18	3
R215.59-BT50063110-12.3K	00008466	BT50	63,0	3	33	111,8	–	100,0	180,0	137,0	7400	5,7	30	3
R215.59-CV50063110-12.3K	00026532	CV50-DIN	63,0	3	33	111,8	–	97,45	165,0	126,0	7400	4,7	30	3
R215.59-50063110-12.3K	00026533	DIN2080	63,0	3	33	111,8	–	97,45	165,0	126,0	7400	5,2	30	3
R220.59-00063.072-12.4K	00008461	Arbor	63,0	4	28	72,0	27,0	62,0	90,0	–	7400	1,2	24	4
R220.59-00080.072-12.5K	00008462	Arbor	80,0	5	35	72,0	32,0	74,7	100,0	–	6500	2,3	30	5

Modification of the cutter body needed for radii > 3,0 mm

Spare Parts, included in delivery

For cutter	Arbor screw	Insert key	Insert screw
R215.59-..			
R215.59-..	–	H6B-T20P	C45011-T20P
R220.59-00063	MC6S12X80	H6B-T20P	C45011-T20P
R220.59-00080	MC6S16X80	H6B-T20P	C45011-T20P

Accessories

For cutter	Insert clamping torque	Torque key
R215.59-..		
R215.59-..	5.0NM	T00-20P50

Torque and fixed keys, see page 894

R215/220.59-12 – Insert selection – mm/Inch

SMG			f _z		
			100%	30%	10%
P1	ACET150612TR-M11 MP2501	SCET120612T-M11 MP2501	0,12 0.0048	0,13 0.0050	0,20 0.0080
P2	ACET150612TR-M11 MP2501	SCET120612T-M11 MP2501	0,13 0.0050	0,14 0.0055	0,22 0.0085
P3	ACET150612TR-M11 MP2501	SCET120612T-M11 MP2501	0,12 0.0048	0,13 0.0050	0,20 0.0080
P4	ACET150612TR-M11 MP2501	SCET120612T-M11 MP2501	0,12 0.0048	0,13 0.0050	0,20 0.0080
P5	ACET150612TR-M11 MP2501	SCET120612T-M11 MP2501	0,11 0.0044	0,12 0.0048	0,19 0.0075
P6	ACET150612TR-M11 MP2501	SCET120612T-M11 MP2501	0,11 0.0044	0,12 0.0048	0,19 0.0075
P7	ACET150612TR-M11 MP2501	SCET120612T-M11 MP2501	0,11 0.0044	0,12 0.0048	0,19 0.0075
P8	ACET150612TR-M11 MP2501	SCET120612T-M11 MP2501	0,12 0.0048	0,13 0.0050	0,20 0.0080
P11	ACET150612TR-M11 T350M	SCET120612T-M11 T350M	0,11 0.0044	0,12 0.0048	0,19 0.0075
P12	ACET150612TR-M11 T350M	SCET120612T-M11 T350M	0,080 0.0032	0,085 0.0034	0,13 0.0050
M1	ACET150612TR-ME10 MS2050	SCET120612R-M10 MS2050	0,11 0.0044	0,12 0.0048	0,19 0.0075
M2	ACET150612TR-ME10 MS2050	SCET120612R-M10 MS2050	0,10 0.0040	0,11 0.0044	0,17 0.0065
M3	ACET150612TR-ME10 MS2050	SCET120612R-M10 MS2050	0,085 0.0034	0,090 0.0036	0,14 0.0055
M4	ACET150612TR-M11 T350M	SCET120612T-M11 T350M	0,080 0.0032	0,090 0.0036	0,13 0.0050
M5	ACET150612TR-M11 T350M	SCET120612T-M11 T350M	0,080 0.0032	0,090 0.0036	0,13 0.0050
K1	ACET150612TR-M14 MK1500	SCET120612T-M14 MK1500	0,16 0.0065	0,17 0.0065	0,26 0.010
K2	ACET150612TR-M14 MK1500	SCET120612T-M14 MK1500	0,15 0.0060	0,16 0.0065	0,24 0.0095
K3	ACET150612TR-M14 MK1500	SCET120612T-M14 MK1500	0,15 0.0060	0,16 0.0065	0,24 0.0095
K4	ACET150612TR-M14 MK1500	SCET120612T-M14 MK1500	0,15 0.0060	0,16 0.0065	0,24 0.0095
K5	ACET150612TR-M14 MK1500	SCET120612T-M14 MK1500	0,13 0.0050	0,14 0.0055	0,22 0.0085
K6	ACET150612TR-M14 MK1500	SCET120612T-M14 MK1500	0,15 0.0060	0,16 0.0065	0,24 0.0095
K7	ACET150612TR-M14 MK1500	SCET120612T-M14 MK1500	0,13 0.0050	0,14 0.0055	0,22 0.0085
S1	ACET150612TR-M11 F40M	SCET120612T-M11 F40M	0,080 0.0032	0,090 0.0036	0,13 0.0050
S2	ACET150612TR-M11 F40M	SCET120612T-M11 F40M	0,080 0.0032	0,090 0.0036	0,13 0.0050
S3	ACET150612TR-M11 F40M	SCET120612T-M11 F40M	0,075 0.0030	0,080 0.0032	0,12 0.0048
S11	ACET150612TR-ME10 MS2050	SCET120612R-M10 MS2050	0,085 0.0034	0,090 0.0036	0,14 0.0055
S12	ACET150612TR-ME10 MS2050	SCET120612R-M10 MS2050	0,085 0.0034	0,090 0.0036	0,14 0.0055
S13	ACET150612TR-ME10 MS2050	SCET120612R-M10 MS2050	0,075 0.0030	0,080 0.0032	0,12 0.0048
H5	ACET150612TR-M11 T350M	SCET120612T-M11 T350M	0,080 0.0032	0,085 0.0034	0,13 0.0050
H8	ACET150612TR-M11 T350M	SCET120612T-M11 T350M	0,060 0.0024	0,065 0.0026	0,10 0.0040
H11	ACET150612TR-M11 T350M	SCET120612T-M11 T350M	0,080 0.0032	0,085 0.0034	0,13 0.0050
H12	ACET150612TR-M11 T350M	SCET120612T-M11 T350M	0,060 0.0024	0,065 0.0026	0,10 0.0040

SMG = Seco material group
 f_z = mm/tooth (in/tooth), v_c = m/min (sf/min), a_p/DC = %
 All cutting data are start values

Square shoulder and slot milling cutters
 Helical milling cutters
 Face milling cutters
 Disc milling cutters
 High feed milling cutters
 Copy milling cutters
 Plunge milling cutters
 Chamfer milling cutters
 Spot facing cutters
 Inserts

R215/220.59-12 – Cutting data $v_c = (m/min)/(sf/min)$

SMG	MP1501			MP2501			MP3000			T350M			MK1500			F40M			MS2050		
	100%	30%	10%	100%	30%	10%	100%	30%	10%	100%	30%	10%	100%	30%	10%	100%	30%	10%	100%	30%	10%
P1	135	145	155	125	140	150	120	135	140	120	135	140	—	—	—	115	125	135	120	135	140
	445	475	510	410	460	490	395	445	460	395	445	460	—	—	—	375	410	445	395	445	460
P2	130	145	150	125	140	145	120	130	140	120	130	140	—	—	—	110	125	135	120	135	140
	425	475	490	410	460	475	395	425	460	395	425	460	—	—	—	360	410	445	395	445	460
P3	125	140	145	120	130	140	115	125	135	110	125	135	—	—	—	105	120	125	115	125	135
	410	460	475	395	425	460	375	410	445	360	410	445	—	—	—	345	395	410	375	410	445
P4	120	130	140	115	125	135	105	120	130	105	120	125	—	—	—	100	115	120	105	120	130
	395	425	460	375	410	445	345	395	425	345	395	410	—	—	—	330	375	395	345	395	425
P5	115	130	140	110	125	130	105	120	125	105	120	125	—	—	—	100	110	120	105	120	125
	375	425	460	360	410	425	345	395	410	345	395	410	—	—	—	330	360	395	345	395	410
P6	125	135	145	115	130	140	110	125	130	110	125	130	—	—	—	105	115	125	110	125	130
	410	445	475	375	425	460	360	410	425	360	410	425	—	—	—	345	375	410	360	410	425
P7	120	135	140	115	130	135	110	120	130	110	120	130	—	—	—	100	115	120	110	120	130
	395	445	460	375	425	445	360	395	425	360	395	425	—	—	—	330	375	395	360	395	425
P8	115	130	135	110	125	130	105	115	125	105	115	125	—	—	—	100	110	120	105	120	125
	375	425	445	360	410	425	345	375	410	345	375	410	—	—	—	330	360	395	345	395	410
P11	120	130	140	115	125	135	105	120	125	105	120	125	—	—	—	100	115	120	110	120	130
	395	425	460	375	410	445	345	395	410	345	395	410	—	—	—	330	375	395	360	395	425
P12	100	110	120	95	105	115	85	100	110	85	100	105	—	—	—	80	95	100	90	100	110
	330	360	395	310	345	375	280	330	360	280	330	345	—	—	—	260	310	330	295	330	360
M1	—	—	—	110	125	130	105	120	125	105	120	125	—	—	—	100	115	125	110	125	130
	—	—	—	360	410	425	345	395	410	345	395	410	—	—	—	330	375	410	360	410	425
M2	—	—	—	100	115	120	95	110	120	100	110	120	—	—	—	95	105	115	100	115	120
	—	—	—	330	375	395	310	360	395	330	360	395	—	—	—	310	345	375	330	375	395
M3	—	—	—	90	105	110	90	100	110	90	100	110	—	—	—	85	95	105	90	105	110
	—	—	—	295	345	360	295	330	360	295	330	360	—	—	—	280	310	345	295	345	360
M4	—	—	—	80	95	100	75	90	95	75	90	95	—	—	—	70	85	95	80	90	100
	—	—	—	260	310	330	245	295	310	245	295	310	—	—	—	230	280	310	260	295	330
M5	—	—	—	70	85	90	65	80	90	70	80	90	—	—	—	65	75	85	70	85	90
	—	—	—	230	280	295	215	260	295	230	260	295	—	—	—	215	245	280	230	280	295
K1	120	135	140	115	125	135	110	120	130	105	120	130	125	140	150	100	115	120	—	—	—
	395	445	460	375	410	445	360	395	425	345	395	425	410	460	490	330	375	395	—	—	—
K2	115	130	135	110	120	130	100	115	125	105	115	125	120	135	145	95	110	115	—	—	—
	375	425	445	360	395	425	330	375	410	345	375	410	395	445	475	310	360	375	—	—	—
K3	105	120	130	100	115	120	95	110	115	95	110	115	115	125	135	90	100	110	—	—	—
	345	395	425	330	375	395	310	360	375	310	360	375	375	410	445	295	330	360	—	—	—
K4	105	120	125	100	110	120	90	105	115	95	105	115	110	125	135	85	100	105	—	—	—
	345	395	410	330	360	395	295	345	375	310	345	375	360	410	445	280	330	345	—	—	—
K5	80	95	105	75	90	95	70	85	90	70	85	90	90	105	110	65	75	85	—	—	—
	260	310	345	245	295	310	230	280	295	230	280	295	295	345	360	215	245	280	—	—	—
K6	100	110	120	95	105	115	85	100	110	85	100	110	105	120	130	80	95	100	—	—	—
	330	360	395	310	345	375	280	330	360	280	330	360	345	395	425	260	310	330	—	—	—
K7	95	105	115	90	100	110	80	95	100	80	95	100	100	115	120	75	90	95	—	—	—
	310	345	375	295	330	360	260	310	330	260	310	330	330	375	395	245	295	310	—	—	—
S1	—	—	—	46	60	65	40	55	60	41	55	60	—	—	—	38	50	55	44	55	65
	—	—	—	150	195	215	130	180	195	135	180	195	—	—	—	125	165	180	145	180	215
S2	—	—	—	37	49	55	33	43	50	33	44	50	—	—	—	30	40	47	35	47	55
	—	—	—	120	160	180	110	140	165	110	145	165	—	—	—	100	130	155	115	155	180
S3	—	—	—	33	43	50	29	38	45	29	39	46	—	—	—	27	35	42	31	41	49
	—	—	—	110	140	165	95	125	150	95	130	150	—	—	—	90	115	140	100	135	160
S11	—	—	—	60	75	85	55	70	75	55	70	75	—	—	—	50	65	75	60	75	80
	—	—	—	195	245	280	180	230	245	180	230	245	—	—	—	165	215	245	195	245	260
S12	—	—	—	45	60	65	39	50	60	40	50	60	—	—	—	36	48	55	42	55	65
	—	—	—	150	195	215	130	165	195	130	165	195	—	—	—	120	155	180	140	180	215
S13	—	—	—	26	34	41	23	30	36	23	31	36	—	—	—	21	28	33	25	33	39
	—	—	—	85	110	135	75	100	120	75	100	120	—	—	—	70	90	110	80	110	130
H5	47	60	70	38	50	60	34	45	55	36	48	55	—	—	—	32	42	49	—	—	—
	155	195	230	125	165	195	110	150	180	120	155	180	—	—	—	105	140	160	—	—	—
H8	50	65	70	41	55	60	37	49	55	39	50	60	—	—	—	34	44	50	—	—	—
	165	215	230	135	180	195	120	160	180	130	165	195	—	—	—	110	145	165	—	—	—
H11	60	70	80	48	60	70	44	55	65	46	60	65	—	—	—	40	55	60	—	—	—
	195	230	260	155	195	230	145	180	215	150	195	215	—	—	—	130	180	195	—	—	—
H12	75	90	100	70	85	90	65	80	85	65	80	85	—	—	—	60	70	80	—	—	—
	245	295	330	230	280	295	215	260	280	215	260	280	—	—	—	195	230	260	—	—	—



R215/220.69-15XH HELICAL

Helical mills for heavy duty, inserts with 4-cutting edges, single-sided inserts.

- Cutter range 50-100 mm (2 - 4 inch)
- Depth of cut ≤ 160 mm (6.3 inch), max 30% ae
- Slotting depth max 50% DC
- Insert corner radii range 1.2-6.3 mm (.047 - .248 inch)

R220.69-15H – High feed rates – Metric

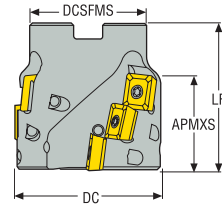

- For insert selection and cutting data recommendations, see page(s) 206-207
- For complete insert programme, see page(s) 829
- For ISO attribute explanation, see page 16

Designation	Item number	Type of mounting	DC	ZEFP	ZNP	APMXS	DCB	DCSFMS	LF	RPMX	Weight	Insert
			mm			mm	mm	mm	mm		kg	
R220.69-0063038-15.4H	75068039	Arbor	63,0	4	12	38,0	27,0	62,0	63,0	7400	0,7	AC.T15..
R220.69-0080038-15.5H	75066129	Arbor	80,0	5	15	38,0	32,0	77,0	63,0	6500	1,2	AC.T15..
R220.69-0080050-15.5H	75066350	Arbor	80,0	5	20	50,0	32,0	77,0	75,0	6500	1,5	AC.T15..
R220.69-0100050-15.6H	75068040	Arbor	100,0	6	24	50,0	40,0	90,0	75,0	5800	2,6	AC.T15..
R220.69-00125050-15.7H	00094725	Arbor	125,0	7	28	50,0	40,0	90,0	75,0	5200	3,5	AC.T15..

Modification of the cutter body needed for radii > 3,0 mm

Spare Parts, included in delivery

For cutter	Arbor screw	Axial support	Insert key	Insert screw	Setting key
R220.69-0063	MC6S12X50	CH9411-T09P	H6B-T20P	C45011-T20P	H4B-T09P
R220.69-0080	MC6S16X50	CH9411-T09P	H6B-T20P	C45011-T20P	H4B-T09P
R220.69-0100	MC6S20X50	CH9411-T09P	H6B-T20PL	C45011-T20P	H4B-T09P
R220.69-00125	-	CH9411-T09P	H6B-T20P	C45011-T20P	H4B-T09P

Accessories

For cutter	Insert clamping torque	Torque key
R220.69-..	5.0NM	T00-20P50

Torque and fixed keys, see page 894

Square shoulder and slot milling cutters
Helical milling cutters
Face milling cutters
Disc milling cutters
High feed milling cutters
Copy milling cutters
Plunge milling cutters
Chamfer milling cutters
Spot facing cutters
Inserts

R220.69-15H – High feed rates – inch

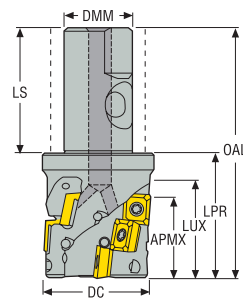

- For insert selection and cutting data recommendations, see page(s) 206-207
- For complete insert programme, see page(s) 829
- For ISO attribute explanation, see page 16

Designation	Item number	Type of mounting	DC	ZEFP	ZNP	APMXS	DMM	LUX	LPR	OAL	RPMX	Weight	Insert
			inch			inch	inch	inch	inch	inch		lbs	
R217.69-02.00-3-15HS3A	75072956	Weldon	2.000	3	9	1.567	1.500	1.567	2.833	5.195	7900	2.870	AC.T15..

Modification of the cutter body needed for radii > 0.118 in

Spare Parts, included in delivery

For cutter	Axial support	Insert key	Insert screw	Setting key
R217.69-..	CH9411-T09P	H6B-T20P	C45011-T20P	H4B-T09P

Accessories

Insert clamping torque	Torque key
44.3IN.LBS	T00-20P50

Torque and fixed keys, see page 894

Square shoulder and slot milling cutters

Helical milling cutters

Face milling cutters

Disc milling cutters

High feed milling cutters

Copy milling cutters

Plunge milling cutters

Chamfer milling cutters

Spot facing cutters

Inserts

R215/220.69-15 – Insert selection – mm/Inch

SMG		f _z		
		100%	30%	10%
P1	ACET150612TR-M11 MP2501	0,13	0,15	0,22
		0,0050	0,0060	0,0085
P2	ACET150612TR-M11 MP2501	0,14	0,15	0,22
		0,0055	0,0060	0,0085
P3	ACET150612TR-M11 MP2501	0,13	0,14	0,22
		0,0050	0,0055	0,0085
P4	ACET150612TR-M11 MP2501	0,13	0,14	0,20
		0,0050	0,0055	0,0080
P5	ACET150612TR-M11 MP2501	0,12	0,13	0,20
		0,0048	0,0050	0,0080
P6	ACET150612TR-M11 MP2501	0,12	0,13	0,20
		0,0048	0,0050	0,0080
P7	ACET150612TR-M11 MP2501	0,12	0,13	0,20
		0,0048	0,0050	0,0080
P8	ACET150612TR-M11 MP2501	0,13	0,14	0,22
		0,0050	0,0055	0,0085
P11	ACET150612TR-M11 T350M	0,12	0,13	0,20
		0,0048	0,0050	0,0080
P12	ACET150612TR-M11 T350M	0,085	0,090	0,14
		0,0034	0,0036	0,0055
M1	ACET150612TR-ME10 MS2050	0,12	0,13	0,20
		0,0048	0,0050	0,0080
M2	ACET150612TR-ME10 MS2050	0,11	0,12	0,19
		0,0044	0,0048	0,0075
M3	ACET150612TR-ME10 MS2050	0,090	0,10	0,15
		0,0036	0,0040	0,0060
M4	ACET150612TR-M11 T350M	0,085	0,095	0,14
		0,0034	0,0038	0,0055
M5	ACET150612TR-M11 T350M	0,085	0,095	0,14
		0,0034	0,0038	0,0055
K1	ACET150612TR-M14 MK1500	0,17	0,19	0,28
		0,0065	0,0075	0,011
K2	ACET150612TR-M14 MK1500	0,16	0,17	0,26
		0,0065	0,0065	0,010
K3	ACET150612TR-M14 MK1500	0,16	0,17	0,26
		0,0065	0,0065	0,010
K4	ACET150612TR-M14 MK1500	0,16	0,17	0,26
		0,0065	0,0065	0,010
K5	ACET150612TR-M14 MK1500	0,14	0,15	0,24
		0,0055	0,0060	0,0095
K6	ACET150612TR-M14 MK1500	0,16	0,17	0,26
		0,0065	0,0065	0,010
K7	ACET150612TR-M14 MK1500	0,14	0,15	0,24
		0,0055	0,0060	0,0095
S1	ACET150612TR-M11 F40M	0,085	0,095	0,14
		0,0034	0,0038	0,0055
S2	ACET150612TR-M11 F40M	0,085	0,095	0,14
		0,0034	0,0038	0,0055
S3	ACET150612TR-M11 F40M	0,080	0,090	0,13
		0,0032	0,0036	0,0050
S11	ACET150612TR-ME10 MS2050	0,090	0,10	0,15
		0,0036	0,0040	0,0060
S12	ACET150612TR-ME10 MS2050	0,090	0,10	0,15
		0,0036	0,0040	0,0060
S13	ACET150612TR-ME10 MS2050	0,080	0,085	0,13
		0,0032	0,0034	0,0050
H5	ACET150612TR-M11 T350M	0,085	0,090	0,14
		0,0034	0,0036	0,0055
H8	ACET150612TR-M11 T350M	0,065	0,070	0,11
		0,0026	0,0028	0,0044
H11	ACET150612TR-M11 T350M	0,085	0,090	0,14
		0,0034	0,0036	0,0055
H12	ACET150612TR-M11 T350M	0,065	0,070	0,11
		0,0026	0,0028	0,0044

SMG = Seco material group
 f_z = mm/tooth (in/tooth), v_c = m/min (sf/min), a_p/DC = %
 All cutting data are start values

R215/220.69-15 – Cutting data $v_c = (m/min)/(sf/min)$

SMG	MP1501			MP2501			MP3000			T350M			MK1500			F40M			MS2050		
	100%	30%	10%	100%	30%	10%	100%	30%	10%	100%	30%	10%	100%	30%	10%	100%	30%	10%	100%	30%	10%
P1	175	195	210	165	185	200	155	175	190	155	175	190	—	—	—	145	165	180	160	180	190
	570	640	690	540	610	660	510	570	620	510	570	620	—	—	—	475	540	590	520	590	620
P2	170	195	205	165	185	200	155	175	190	150	175	185	—	—	—	140	165	175	155	180	190
	560	640	670	540	610	660	510	570	620	490	570	610	—	—	—	460	540	570	510	590	620
P3	160	185	195	155	175	185	145	165	175	145	165	175	—	—	—	130	155	165	145	165	180
	520	610	640	510	570	610	475	540	570	475	540	570	—	—	—	425	510	540	475	540	590
P4	155	175	190	145	165	180	135	155	170	135	155	170	—	—	—	125	145	160	140	160	170
	510	570	620	475	540	590	445	510	560	445	510	560	—	—	—	410	475	520	460	520	560
P5	150	170	185	140	165	175	130	150	165	130	155	165	—	—	—	120	140	155	135	155	165
	490	560	610	460	540	570	425	490	540	425	510	540	—	—	—	395	460	510	445	510	540
P6	160	180	195	150	170	185	140	160	175	140	160	175	—	—	—	130	150	165	145	165	175
	520	590	640	490	560	610	460	520	570	460	520	570	—	—	—	425	490	540	475	540	570
P7	155	175	190	145	165	180	135	155	170	135	155	170	—	—	—	125	145	160	140	160	170
	510	570	620	475	540	590	445	510	560	445	510	560	—	—	—	410	475	520	460	520	560
P8	150	170	185	140	160	175	130	150	165	130	150	165	—	—	—	120	140	155	130	155	165
	490	560	610	460	520	570	425	490	540	425	490	540	—	—	—	395	460	510	425	510	540
P11	155	175	185	145	165	180	135	155	165	135	155	165	—	—	—	125	145	155	135	155	170
	510	570	610	475	540	590	445	510	540	445	510	540	—	—	—	410	475	510	445	510	560
P12	120	140	155	110	135	145	105	125	135	100	120	135	—	—	—	90	110	125	105	125	135
	395	460	510	360	445	475	345	410	445	330	395	445	—	—	—	295	360	410	345	410	445
M1	—	—	—	140	160	175	130	155	165	135	155	170	—	—	—	125	145	160	140	160	175
	—	—	—	460	520	570	425	510	540	445	510	560	—	—	—	410	475	520	460	520	570
M2	—	—	—	125	145	160	115	140	150	120	140	155	—	—	—	115	135	145	125	145	160
	—	—	—	410	475	520	375	460	490	395	460	510	—	—	—	375	445	475	410	475	520
M3	—	—	—	110	130	145	105	125	135	105	125	140	—	—	—	95	115	130	110	130	145
	—	—	—	360	425	475	345	410	445	345	410	460	—	—	—	310	375	425	360	425	475
M4	—	—	—	90	110	125	85	105	115	85	105	120	—	—	—	80	100	110	90	110	125
	—	—	—	295	360	410	280	345	375	280	345	395	—	—	—	260	330	360	295	360	410
M5	—	—	—	75	95	110	70	90	105	70	90	105	—	—	—	65	85	100	80	100	110
	—	—	—	245	310	360	230	295	345	230	295	345	—	—	—	215	280	330	260	330	360
K1	155	175	190	145	165	180	135	155	170	135	155	170	165	190	200	125	145	160	—	—	—
	510	570	620	475	540	590	445	510	560	445	510	560	540	620	660	410	475	520	—	—	—
K2	145	170	180	140	160	170	125	150	160	130	150	160	160	180	195	115	140	150	—	—	—
	475	560	590	460	520	560	410	490	520	425	490	520	520	590	640	375	460	490	—	—	—
K3	135	155	170	125	145	160	115	135	150	115	135	150	145	165	180	105	125	140	—	—	—
	445	510	560	410	475	520	375	445	490	375	445	490	475	540	590	345	410	460	—	—	—
K4	130	150	165	120	145	155	110	135	145	110	135	145	140	165	175	100	120	135	—	—	—
	425	490	540	395	475	510	360	445	475	360	445	475	460	540	570	330	395	445	—	—	—
K5	95	115	125	85	105	120	75	95	110	75	95	105	105	130	140	65	85	95	—	—	—
	310	375	410	280	345	395	245	310	360	245	310	345	345	425	460	215	280	310	—	—	—
K6	120	145	155	110	135	145	100	125	135	100	125	135	135	155	165	90	115	125	—	—	—
	395	475	510	360	445	475	330	410	445	330	410	445	445	510	540	295	375	410	—	—	—
K7	110	135	145	105	125	135	95	115	125	95	115	125	125	145	160	80	105	115	—	—	—
	360	445	475	345	410	445	310	375	410	310	375	410	410	475	520	260	345	375	—	—	—
S1	—	—	—	45	60	70	39	50	60	40	55	65	—	—	—	37	48	55	43	55	65
	—	—	—	150	195	230	130	165	195	130	180	215	—	—	—	120	155	180	140	180	215
S2	—	—	—	36	48	55	32	42	49	33	43	50	—	—	—	30	39	46	35	46	55
	—	—	—	120	155	180	105	140	160	110	140	165	—	—	—	100	130	150	115	150	180
S3	—	—	—	32	42	49	28	37	43	29	37	44	—	—	—	26	34	40	31	40	48
	—	—	—	105	140	160	90	120	140	95	120	145	—	—	—	85	110	130	100	130	155
S11	—	—	—	60	80	95	55	70	85	55	75	85	—	—	—	50	65	80	60	80	90
	—	—	—	195	260	310	180	230	280	180	245	280	—	—	—	165	215	260	195	260	295
S12	—	—	—	43	55	70	38	50	60	39	50	60	—	—	—	35	46	55	42	55	65
	—	—	—	140	180	230	125	165	195	130	165	195	—	—	—	115	150	180	140	180	215
S13	—	—	—	25	33	39	22	29	34	23	30	35	—	—	—	21	27	32	24	32	38
	—	—	—	80	110	130	70	95	110	75	100	115	—	—	—	70	90	105	80	105	125
H5	46	60	70	37	49	55	34	45	50	35	47	55	—	—	—	31	41	48	—	—	—
	150	195	230	120	160	180	110	150	165	115	155	180	—	—	—	100	135	155	—	—	—
H8	49	65	75	39	50	60	36	47	55	38	50	60	—	—	—	33	43	50	—	—	—
	160	215	245	130	165	195	120	155	180	125	165	195	—	—	—	110	140	165	—	—	—
H11	60	75	90	47	60	75	43	55	65	45	60	70	—	—	—	39	50	60	—	—	—
	195	245	295	155	195	245	140	180	215	150	195	230	—	—	—	130	165	195	—	—	—
H12	85	105	120	80	100	110	70	90	100	70	90	100	—	—	—	60	80	90	—	—	—
	280	345	395	260	330	360	230	295	330	230	295	330	—	—	—	195	260	295	—	—	—

Square shoulder and slot milling cutters

Helical milling cutters

Face milling cutters

Disc milling cutters

High feed milling cutters

Copy milling cutters

Plunge milling cutters

Chamfer milling cutters

Spot facing cutters

Inserts

Square shoulder and
slot milling cutters

Helical milling cutters

Face milling cutters

Disc milling cutters

High feed milling
cutters

Copy milling cutters

Plunge milling cutters

Chamfer milling cutters

Spot facing cutters

Inserts



R235.15 HELICAL

Helical mills for high surface finish in square shoulder and contouring operations.
Suitable for finishing operations.

- Cutter range 32-80mm, (1.25 - 3 inch)
- Depth of cut ≤ 90 mm (3.5 inch)
- Max $a_e = 1$ mm

R235.15 – Finishing operations – Metric

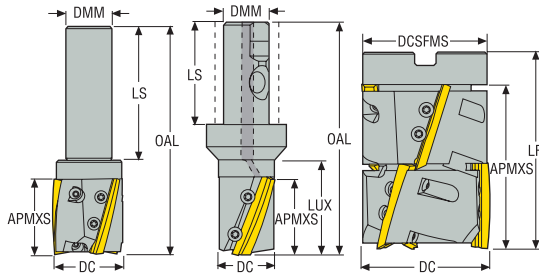

- For insert selection and cutting data recommendations, see page(s) 211-212
- For complete insert programme, see page(s) 880
- For ISO attribute explanation, see page 16

Designation	Item number	Type of mounting	DC	ZEPF	ZNP	APMXS	DCB	DMM	DCSFMS	LS	LF	OAL	LUX	RPMX	Weight	Insert
			mm			mm	mm	mm	mm	mm	mm	mm	mm		kg	
R235.15-2532.0-40	75036949	Cylindrical	32,0	2	2	40,0	-	25,0	-	71,0	-	140,0	40,0	8000	0,7	R235.15-032
R235.15A-3250.0-50	75036947	Cylindrical	50,0	3	3	50,0	-	32,0	-	95,0	-	155,0	50,0	5500	1,2	R235.15-050
R235.15-2532.3S-40A	75036948	Seco-Weldon	32,0	2	2	40,0	-	25,0	40,0	56,0	-	125,0	50,0	8000	0,7	R235.15-032
R235.15A-3250.3S-50A	75036946	Seco-Weldon	50,0	3	3	50,0	-	32,0	50,0	70,0	-	120,0	61,4	5500	0,9	R235.15-050
R235.15A-0080-90	75037122	Arbor	80,0	3	6	90,0	32,0	-	75,0	-	120,0	-	-	4400	3,2	R235.15-080

Spare Parts, included in delivery

For cutter	Arbor screw	Insert key	Insert screw	Setting gauge	Setting key
R235.15-2532	-	H6B-T25P	CL85012-T25P	-	-
R235.15-3250	-	H6B-T25P	CL85012-T25P	AU8019-T15P	H4B-T15P
R235.15A-0080	MC6S16X100	H6B-T25P	CL85012-T25P	AU8019-T15P	H4B-T15P

Accessories

For cutter	Insert clamping torque	Torque key
R235.15-..	6.0NM	T00T-25P60

Torque and fixed keys, see page 894

Square shoulder and slot milling cutters

Helical milling cutters

Face milling cutters

Disc milling cutters

High feed milling cutters

Copy milling cutters

Plunge milling cutters

Chamfer milling cutters

Spot facing cutters

Inserts

R235.15 – Finishing operations – inch

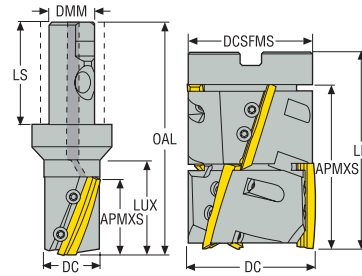

- For insert selection and cutting data recommendations, see page(s) 211-212
- For complete insert programme, see page(s) 880
- For ISO attribute explanation, see page 16

Designation	Item number	Type of mounting	DC	ZEFP	ZNP	APMXS	DCB	DMM	DCSFMS	LS	LF	OAL	LUX	RPMX	Weight	Insert
			inch			inch	inch	inch	inch	inch	inch	inch	inch		lbs	
R235.15A-02.00-3S-50A	75056423	Seco-Weldon	2.000	3	3	1.969	–	1.250	1.772	2.441	–	4.724	1.969	5500	2.200	R235.15-050
R235.15A-03.00-90	75056424	Shell mill	3.000	3	6	3.500	1.000	–	2.866	–	4.724	–	–	4400	7.280	R235.15-080

Spare Parts, included in delivery

For cutter	Arbor screw	Insert key	Insert screw	Setting gauge	Setting key
R235.15A-02.00	–	H6B-T25P	CL85012-T25P	AU8019-T15P	H4B-T15P
R235.15A-03.00	UC6S1/2UNFX4	H6B-T25P	CL85012-T25P	AU8019-T15P	H4B-T15P

Accessories

For cutter	Insert clamping torque	Torque key
R235.15-..	53.1IN.LBS	T00T-25P60

Torque and fixed keys, see page 894

R235.15 – Insert selection – mm/Inch

SMG		f_z
		3%
P1	R235.15-xxx-E05 F30M	0,20 0,0080
P2	R235.15-xxx-E05 F30M	0,22 0,0085
P3	R235.15-xxx-E05 F30M	0,20 0,0080
P4	R235.15-xxx-E05 F30M	0,20 0,0080
P5	R235.15-xxx-E05 F30M	0,19 0,0075
P6	R235.15-xxx-E05 F30M	0,19 0,0075
P7	R235.15-xxx-E05 F30M	0,19 0,0075
P8	R235.15-xxx-E05 F30M	0,20 0,0080
P11	R235.15-xxx-E05 F30M	0,19 0,0075
P12	R235.15-xxx-E05 F30M	0,13 0,0050
M1	R235.15-xxx-E05 F30M	0,22 0,0085
M2	R235.15-xxx-E05 F30M	0,19 0,0075
M3	R235.15-xxx-E05 F30M	0,15 0,0060
M4	R235.15-xxx-E05 F30M	0,13 0,0050
M5	R235.15-xxx-E05 F30M	0,13 0,0050
K1	R235.15-xxx-E05 F30M	0,22 0,0085
K2	R235.15-xxx-E05 F30M	0,19 0,0075
K3	R235.15-xxx-E05 F30M	0,19 0,0075
K4	R235.15-xxx-E05 F30M	0,19 0,0075
K5	R235.15-xxx-E05 F30M	0,17 0,0065
K6	R235.15-xxx-E05 F30M	0,19 0,0075
K7	R235.15-xxx-E05 F30M	0,17 0,0065
N1	R235.15-xxx-E05 F30M	0,28 0,011
N2	R235.15-xxx-E05 F30M	0,28 0,011
N3	R235.15-xxx-E05 F30M	0,28 0,011
N11	R235.15-xxx-E05 F30M	0,28 0,011
S1	R235.15-xxx-E05 F30M	0,13 0,0050
S2	R235.15-xxx-E05 F30M	0,13 0,0050
S3	R235.15-xxx-E05 F30M	0,13 0,0050
S11	R235.15-xxx-E05 F30M	0,15 0,0060
S12	R235.15-xxx-E05 F30M	0,15 0,0060
S13	R235.15-xxx-E05 F30M	0,13 0,0050

SMG = Seco material group
 f_z = mm/tooth (in/tooth), v_c = m/min (sf/min), a_p /DC = %
 All cutting data are start values

Square shoulder and slot milling cutters
 Helical milling cutters
 Face milling cutters
 Disc milling cutters
 High feed milling cutters
 Copy milling cutters
 Plunge milling cutters
 Chamfer milling cutters
 Spot facing cutters
 Inserts

R235.15 – Cutting data $v_c = (m/min)/(sf/min)$

	SMG	F30M	
Square shoulder and slot milling cutters		3%	
	P1	310 1025	
Helical milling cutters	P2	295 970	
	P3	260 850	
	P4	230 750	
	P5	220 720	
	P6	245 800	
	P7	235 770	
	P8	215 710	
	P11	225 740	
	P12	145 475	
	Disc milling cutters	M1	200 660
		M2	165 540
		M3	130 425
M4		100 330	
M5		85 280	
High feed milling cutters	K1	235 770	
	K2	210 690	
	K3	175 570	
	K4	170 560	
	K5	105 345	
	K6	150 490	
	K7	130 425	
Plunge milling cutters	N1	1450 4750	
	N2	590 1925	
	N3	390 1275	
	N11	445 1450	
Chamfer milling cutters	S1	70 230	
	S2	55 180	
	S3	49 160	
	S11	100 330	
	S12	70 230	
Spot facing cutters	S13	40 130	

Code keys metric and inch

R	220	53	0100	12	7	A
1	2	3	4	5	6	7

R	220	53	04.00	12	7	A
1	2	3	4	5	6	7

1.	2.	3.
R = Right hand rotation L = Left hand rotation Cx = For Seco-Capto	217 = With shank 220 = For arbor	Cutter system
4.	5.	6.
Mounting type & Cutter diameter 0xxx = shell mill mounting 8xxx = Flange mounting 9xxx = CAP mounting	Insert size	Effective No. of teeth (ZEFP)
7.		
A = With through coolant supply W = Insert locking with wedge G = Coarse pitch version for low power machines T = Close pitch version for high feed rates in powerful machines C = Cassettes S = Insert locking with screw M = Modified		

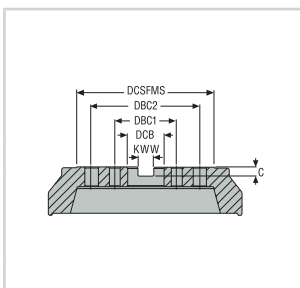

	Dimensions in mm					
	DCB	DCSFMS	DBC1	DBC2	KWW	C
16		30-35	-	-	8,4	5,6
22		42-47	-	-	10,4	6,3
27		48-62	-	-	12,4	7
32		60-90	-	-	14,4	8
40		90-130	66,7	-	16,4	9
60		130-270	101,6	177,8	25,7	14

	Dimensions in inch					
	DCB	DCSFMS	DBC1	DBC2	KWW	C
0.500		1.181 - 1.378			0.258	0.165
0.750		1.378 - 1.850			0.321	0.193
1.000		1.803 - 2.441			0.382	0.224
1.250		2.250 - 3.031			0.508	0.287
1.500		2.750 - 3.543			0.630	0.382
2.000		4.331			0.756	0.445
2.500		5.118 - 6.299 (8.858)	4.000	(7.000)	1.000	0.551

For a more exact DCSFMS and DCB measurement, see each product table.

Square shoulder and slot milling cutters

Helical milling cutters

Face milling cutters

Disc milling cutters

High feed milling cutters

Copy milling cutters

Plunge milling cutters

Chamfer milling cutters

Spot facing cutters

Inserts

Selection – Metric

Cutter family	Insert	a _p max	a _p rec.	Material suitability								KAPRS°
				P	M	K	N	S				
Double Quattromill R220.54-14	SN.X14..AN 	6.0	4.0	■	■	■	▣	■	▣	■	▣	48°
Double Quattromill R220.56-14	SN.X14..ZN 	8.0	6.0	■	▣	■	□	▣	▣	■	▣	71°
Double Quattromill R220.54-22	SNMX22..AN 	9.0	6.0	■	■	■	□	■	□	■	▣	48°
Double Quattromill R220.56-22	SNMX22..ZN 	13	9.0	■	▣	■	□	▣	□	■	▣	71°
Quattromill R220.53-09	SE.X09T3 	4.5	3.0	■	■	▣	■	■	■	▣	■	45°
Quattromill R220.53-12	SE.X1204 	6.0	4.5	■	■	▣	■	■	■	■	■	45°
Quattromill R220.53-15	SE.X1505 	7.5	6.0	■	■	■	■	■	▣	■	■	45°

1st choice	■	High speed machine with low power/ torque		Unstable condition suitability	
Alternative choice	▣	Strong stable machine with rigid conecion		a _p max = Maximum depth of cut possible a _p rec. = Recommended depth of cut for optimal result	
Possible choice	□	Not recommended			

Selection – Metric

Insert	No. of cutting edges	Applica-tion	Cutter diameter (mm) available with effective number of teeth													See page		
			20	24*/25	32	40	50	63	80	100	125	160	200	250	315			
SNMX14..AN	8						4	5	6	7	8	10	12					223, 224
							5	7	8	10	12	15	17					
													9	11	14	16		
SNMX14..ZN	8						4	5	6	7	8	10	12					223, 224
							5	7	8	10	12	15	17					
													9	11	14	16		
SNMX22..AN	8									5	5	6	8					239
										6	7	8	11					
														9	11	14		
SNMX22..ZN	8										5	6	8					239
										5	7	8	10					
															9	11	14	
SE.X09T3	4		2	3	4	4	5	6	6	7								272
						5	6	7	8	10								
														8	10	12		
											5	6	8	10		16		
SE.X1204	4										5	6	7					280, 281
						3	4	5	6	7	8	10						
						4	5	6	8	10	12							
									9	11	12	14	17	20				
													7	8	10	12		
											5	6	8	10	12	16		
SE.X1505	4								5	6	7	8	10	12				290
										7	9	10						
													7	8	10	12		
									5	6	8	10	12	16	18			

	Fixed pocket (x indicates number of teeth)		Troubleshooter for unstable fixturing and/or unstable conditions
	With cassette (x indicates number of teeth)		Basic choice
			Productivity

Square shoulder and slot milling cutters
Helical milling cutters
Face milling cutters
Disc milling cutters
High feed milling cutters
Copy milling cutters
Plunge milling cutters
Chamfer milling cutters
Spot facing cutters
Inserts

Selection – Metric

Cutter family	Insert	a _p max	a _p rec.	Material suitability								KAPRS°
				P	M	K	N	S				
Double Octomill R220.48-05	ON..05 	3,0	2,0	■	■	■	□	▣	■	▣	□	40°
Double Octomill R220.48-09	ON..09 	6,0	4,0	■	■	■	□	▣	□	■	□	40°
Octomill R220.43-05	OF..05 	3,5	2,5	▣	▣	▣	▣	▣	■	▣	▣	43°
Octomill R220.43-07	OF..07 	5,0	4,0	▣	▣	▣	▣	▣	▣	■	▣	43°
R220.88-12	SNMU12.. 	9,0	5,0	■	▣	■	-	-	■	■	■	88°
R220.88-16	SNMU16.. 	13,0	8,0	■	▣	■	-	-	□	■	■	88°

1st choice	■	High speed machine with low power/ torque		Unstable condition suitability
Alternative choice	▣	Strong stable machine with rigid conection		
Possible choice	□	Not recommended		

a_p max = Maximum depth of cut possible
a_p rec. = Recommended depth of cut for optimal result

Square shoulder and slot milling cutters
Helical milling cutters
Face milling cutters
Disc milling cutters
High feed milling cutters
Copy milling cutters
Plunge milling cutters
Chamfer milling cutters
Spot facing cutters
Inserts

Selection – Metric

Insert	No. of cutting edges	Application	Cutter diameter (mm) available with effective number of teeth														See page	
			20	24*/25	32	40	50	63	80	100	125	160	200	250	315	400		500
ON..05	16						4	5	6	7	8							252
				3	4	4	5	6										
						5	6	8	10	12	14							
										8	10	14	18					
ON..09	16							5	6	7	8	10	12	16	20			261, 262
								6	7	8	10	12						
									9	12	15	20	24	30	40	50	60	
													28					
OF..05	8				3	3	4	5	6	7	8	10						310, 311
						4	5	6	8									
												7						
											6	8	10	12	16	20		
OF..07	8						4	4	5	6	8	10						318
								6	9	12	15							
												7						
											6	8	10	12	16			
SNMU12..	8						4	6	7	8	10	12						297, 298
						4	5	7	9	11	13	16						
SNMU16..	8								6	8	10	12						304
								5	7	9	11	13						

x	Fixed pocket (x indicates number of teeth)		Troubleshooter for unstable fixturing and/or unstable conditions
x	With cassette (x indicates number of teeth)		Basic choice
			Productivity

Square shoulder and slot milling cutters
Helical milling cutters
Face milling cutters
Disc milling cutters
High feed milling cutters
Copy milling cutters
Plunge milling cutters
Chamfer milling cutters
Spot facing cutters
Inserts

Selection – inch

Cutter family	Insert	a _p max	a _p rec.	Material suitability								KAPRS°
				P	M	K	N	S				
Double Quattromill R220.54-14	SN.X14..AN 	0.236	0.157	■	■	■	▣	■	▣	■	▣	48°
Double Quattromill R220.56-14	SN.X14..ZN 	0.315	0.236	■	▣	■	▣	■	▣	■	▣	71°
Double Quattromill R220.54-22	SNMX22..AN 	0.354	0.236	■	■	■	□	■	□	■	▣	48°
Double Quattromill R220.56-22	SNMX22..ZN 	0.512	0.354	■	▣	■	□	■	□	■	▣	71°
Quattromill R220.53-09	SE.X09T3 	0.177	0.118	■	■	▣	■	■	■	▣	■	45°
Quattromill R220.53-12	SE.X1204 	0.236	0.177	■	■	▣	■	■	▣	■	■	45°
Quattromill R220.53-15	SE.X1505 	0.295	0.236	■	■	■	■	■	▣	■	■	45°

1st choice	■
Alternative choice	▣
Possible choice	□

High speed machine with low power/ torque	
Strong stable machine with rigid connecion	
Not recommended	

Unstable condition suitability	
a _p max = Maximum depth of cut possible a _p rec. = Recommended depth of cut for optimal result	

Square shoulder and slot milling cutters
Helical milling cutters
Face milling cutters
Disc milling cutters
High feed milling cutters
Copy milling cutters
Plunge milling cutters
Chamfer milling cutters
Spot facing cutters
Inserts

Selection – inch

Insert	No. of cutting edges	Applica-tion	Cutter diameter (inch) available with effective number of teeth													See page			
			0.75	1	1.25	1.5	2	2.5	3	4	5	6	8	10	12.5				
SNMX14..AN	8						4	5	6	7	8	10	12					223, 224	
							5	7	8	10	12	15	17						
													9	11	14	16			
SNMX14..ZN	8						4	5	6	7	8	10	12					223, 224	
							5	7	8	10	12	15	17						
													9	11	14	16			
SNMX22..AN	8								5	5	6	8						239	
									6	7	8	11							
														9	11	14			
SNMX22..ZN	8								5	5	6	8						239	
										7	8	10							
														9	11	14			
SE.X09T3	4		2	3	4	4	5	6	8									272	
SE.X1204	4					4	4	5	6	7	6	7						280, 281	
							5	6	8	10	8	10	12						
										12		12							
												17							
SE.X1505	4								6	7	10							290	

Fixed pocket (x indicates number of teeth)

With cassette (x indicates number of teeth)

Troubleshooter for unstable fixturing and/or unstable conditions

Basic choice

Productivity

Square shoulder and slot milling cutters

Helical milling cutters

Face milling cutters

Disc milling cutters

High feed milling cutters

Copy milling cutters

Plunge milling cutters

Chamfer milling cutters

Spot facing cutters

Inserts

Selection – inch

Cutter family	Insert	a _p max	a _p rec.	Material suitability								KAPRS°
				P	M	K	N	S				
Double Octomill R220.48-05	ON..05 	0.118	0.079	■	■	■	□	▣	▣	▣	40°	
Double Octomill R220.48-09	ON..09 	0.236	0.157	■	■	■	□	▣	□	■	40°	
Octomill R220.43-05	OF..05 	0.138	0.098	▣	▣	▣	▣	▣	■	▣	43°	
Octomill R220.43-07	OF..07 	0.197	0.157	▣	▣	▣	▣	▣	▣	■	43°	
R220.88-12	SNMU12.. 	0.354	0.197	■	▣	■	-	-	■	■	88°	
R220.88-16	SNMU16.. 	0.512	0.354	■	▣	■	-	-	□	■	88°	

1st choice	■	High speed machine with low power/ torque		Unstable condition suitability
Alternative choice	▣	Strong stable machine with rigid conection		
Possible choice	□	Not recommended		

a_p max = Maximum depth of cut possible
a_p rec. = Recommended depth of cut for optimal result

Selection – Inch

Insert	No. of cutting edges	Application	Cutter diameter (inch) available with effective number of teeth													See page	
			0.75	1	1.25	1.5	2	2.5	3	4	5	6	8	10	12.5		
ON..05	16				4	4	4	5	6	7							252
							5		10								
										8		14	18				
ON..09	16							5	6	7	8	10	12	16	20		261, 262
									9	12	15						
												10	12	16			
OF..05	8					3	4	5	6	7	8						310, 311
OF..07	8							4	5	6		10					318
SNMU12..	8					4	4	6	7	8	10	12					297, 298
							5	7	9	11	13	16					
SNMU16..	8								6	8	10	12					304
										7	9	11	13				

x	Fixed pocket (x indicates number of teeth)		Troubleshooter for unstable fixturing and/or unstable conditions
x	With cassette (x indicates number of teeth)		Basic choice
			Productivity

Square shoulder and slot milling cutters
Helical milling cutters
Face milling cutters
Disc milling cutters
High feed milling cutters
Copy milling cutters
Plunge milling cutters
Chamfer milling cutters
Spot facing cutters
Inserts



DOUBLE QUATTROMILL 14/22

Take full advantage of your machine tool's milling power for increased productivity with Seco's Double Quattromill™ face mill cutter for roughing and semi finishing. Achieve the industry's largest depths-of-cut and do so cost-effectively with eight multi-edge insert cutting edges.

- Insert size 14, cutter range 50-315mm (2 - 12.50 inches)
- Insert size 22, cutter range 80-315mm (3 - 12.50 inches)
- 8 cutting edges, double-sided inserts

R220.54-14 metric

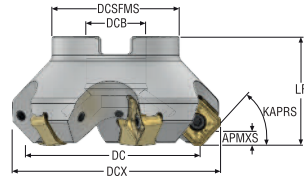

- For insert selection and cutting data recommendations, see page(s) 233-238
- For complete insert programme, see page(s) 857
- For ISO attribute explanation, see page 16

Designation	Item number	Type of mounting	DC	ZEFP	APMXS	KAPRS°	DCX	DCB	DCSFMS	LF	RPMX	Weight	Insert
			mm		mm		mm	mm	mm	mm		kg	
R220.54-0050-14-4A	03213622	Arbor	50,0	4	6,0	48,0	65,0	22,0	47,0	40,0	8500	0,5	SN.X1407AN
R220.54-0050-14-5A	03213629	Arbor	50,0	5	6,0	48,0	65,0	22,0	47,0	40,0	8500	0,4	SN.X1407AN
R220.54-0063-14-5A	03213623	Arbor	63,0	5	6,0	48,0	78,0	22,0	47,0	40,0	7600	0,6	SN.X1407AN
R220.54-0063-14-7A	03213630	Arbor	63,0	7	6,0	48,0	78,0	22,0	47,0	40,0	7600	0,6	SN.X1407AN
R220.54-0080-14-6A	03213624	Arbor	80,0	6	6,0	48,0	95,0	27,0	62,0	50,0	6700	1,2	SN.X1407AN
R220.54-0080-14-8A	03213631	Arbor	80,0	8	6,0	48,0	95,0	27,0	62,0	50,0	6700	1,2	SN.X1407AN
R220.54-0100-14-7A	03213625	Arbor	100,0	7	6,0	48,0	115,0	32,0	77,0	50,0	6000	1,8	SN.X1407AN
R220.54-0100-14-10A	03213632	Arbor	100,0	10	6,0	48,0	115,0	32,0	77,0	50,0	6000	1,8	SN.X1407AN
R220.54-0125-14-8A	03213626	Arbor	125,0	8	6,0	48,0	140,0	40,0	90,0	63,0	5400	3,5	SN.X1407AN
R220.54-0125-14-12A	03213633	Arbor	125,0	12	6,0	48,0	140,0	40,0	90,0	63,0	5400	3,4	SN.X1407AN
R220.54-8160-14-10A	03213627	Arbor	160,0	10	6,0	48,0	175,0	40,0	90,0	63,0	4700	5,9	SN.X1407AN
R220.54-8160-14-15A	03213634	Arbor	160,0	15	6,0	48,0	175,0	40,0	90,0	63,0	4700	5,8	SN.X1407AN
R220.54-8200-14-12A	03213628	Arbor	200,0	12	6,0	48,0	215,0	60,0	130,0	63,0	4200	8,2	SN.X1407AN
R220.54-8200-14-17A	03213635	Arbor	200,0	17	6,0	48,0	215,0	60,0	130,0	63,0	4200	7,6	SN.X1407AN

Square shoulder and slot milling cutters

Helical milling cutters

Face milling cutters

Disc milling cutters

High feed milling cutters

Copy milling cutters





Plunge milling cutters

Chamfer milling cutters

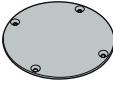

Spot facing cutters

Inserts

Spare Parts, included in delivery

For cutter	Arbor screw	Insert key	Insert screw	Lid	Lid screw
R220.54-0050-0063	220.17-691 	H4B-T15P 	C04011-T15P 	- 	- 
R220.54-0080-0125	-	H4B-T15P	C04011-T15P	-	-
R220.54-0080-0125	-	H4B-T15PL	C04011-T15P	-	-
R220.54-8160	-	H4B-T15PL	C04011-T15P	SC-160-90	MF6S4X10
R220.54-8200	-	H4B-T15PL	C04011-T15P	SC-200-90	MF6S4X10

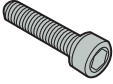
Accessories

For cutter	Arbor screw	Insert clamping torque	Torque key
R220.54-0050-0125	- 	3.5NM 	T00-15P35 
R220.54-8160	MC6S12X40	3.5NM	T00-15P35
R220.54-8200	MC6S16X50	3.5NM	T00-15P35

Torque and fixed keys, see page 894

- Square shoulder and slot milling cutters
- Helical milling cutters
- Face milling cutters
- Disc milling cutters
- High feed milling cutters
- Copy milling cutters
- Plunge milling cutters
- Chamfer milling cutters
- Spot facing cutters
- Inserts

Double Quattro R220.54-14 – inch

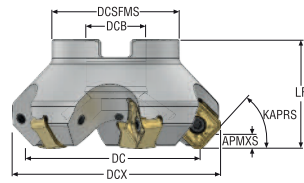

- For insert selection and cutting data recommendations, see page(s) 233-238
- For complete insert programme, see page(s) 857
- For ISO attribute explanation, see page 16

Designation	Item number	Type of mounting	DC	ZEFP	APMXS	KAPRS*	DCX	DCB	DCSFMS	LF	RPMX	Weight	Insert
			inch		inch		inch	inch	inch	inch		lbs	
R220.54-02.00-14-4A	03213636	Arbor	1.969	4	0.236	48.0	2.559	0.750	1.850	1.575	8500	1.100	SN.X1407AN
R220.54-02.00-14-5A	03213643	Arbor	1.969	5	0.236	48.0	2.559	0.750	1.850	1.575	8500	1.100	SN.X1407AN
R220.54-02.50-14-5A	03213637	Arbor	2.480	5	0.236	48.0	3.071	0.750	1.850	1.575	7600	1.320	SN.X1407AN
R220.54-02.50-14-7A	03213644	Arbor	2.480	7	0.236	48.0	3.071	0.750	1.850	1.575	7600	1.320	SN.X1407AN
R220.54-03.00-14-6A	03213638	Arbor	3.150	6	0.236	48.0	3.740	1.000	2.441	1.969	6700	3.090	SN.X1407AN
R220.54-03.00-14-8A	03213645	Arbor	3.150	8	0.236	48.0	3.740	1.000	2.441	1.969	6700	2.870	SN.X1407AN
R220.54-04.00-14-7A	03213639	Arbor	3.937	7	0.236	48.0	4.528	1.500	3.031	1.969	6000	3.970	SN.X1407AN
R220.54-04.00-14-10A	03213646	Arbor	3.937	10	0.236	48.0	4.528	1.500	3.031	1.969	6000	3.750	SN.X1407AN
R220.54-05.00-14-8A	03213640	Arbor	4.921	8	0.236	48.0	5.512	1.500	3.543	2.480	5400	8.380	SN.X1407AN
R220.54-05.00-14-12A	03213647	Arbor	4.921	12	0.236	48.0	5.512	1.500	3.543	2.480	5400	8.160	SN.X1407AN
R220.54-06.00-14-10A	03213641	Arbor	6.299	10	0.236	48.0	6.890	2.000	4.331	2.480	4700	13.670	SN.X1407AN
R220.54-06.00-14-15A	03213648	Arbor	6.299	15	0.236	48.0	6.890	2.000	4.331	2.480	4700	14.990	SN.X1407AN
R220.54-808.00-14-12A	03213642	Arbor	7.874	12	0.236	48.0	8.465	2.500	5.118	2.480	4200	16.760	SN.X1407AN
R220.54-808.00-14-17A	03213649	Arbor	7.874	17	0.236	48.0	8.465	2.500	5.118	2.480	4200	16.530	SN.X1407AN

Square shoulder and slot milling cutters

Helical milling cutters

Face milling cutters

Disc milling cutters

High feed milling cutters

Copy milling cutters

Plunge milling cutters

Chamfer milling cutters

Spot facing cutters

Inserts

Spare Parts, included in delivery

For cutter	Arbor screw	Insert key	Insert screw	Lid	Lid screw
R220.54-02.00-02.50	220.17-698	H4B-T15P	C04011-T15P	-	-
R220.54-03.00	UC6S1/2UNFX1-1/4	H4B-T15P	C04011-T15P	-	-
R220.54-04.00	UF6S3/4UNFX1-3/4	H4B-T15PL	C04011-T15P	-	-
R220.54-05.00	UC6S3/4UNFX1-1/4	H4B-T15PL	C04011-T15P	-	-
R220.54-06.00	-	H4B-T15PL	C04011-T15P	SC-160-90	MF6S4X10
R220.54-808.00-12A	-	H4B-T15PL	C04011-T15P	SC-200-90	MF6S4X10
R220.54-808.00	-	H4B-T15PL	C04011-T15P	SC-200-90	MF6S4X10

Accessories

For cutter	Arbor screw	Insert clamping torque	Torque key
R220.54-02.00-05.00	-	31.0IN.LBS	T00-15P35
R220.54-06.00	58215080	31.0IN.LBS	T00-15P35
R220.54-808.00	950DNC062225	31.0IN.LBS	T00-15P35

Torque and fixed keys, see page 894

Square shoulder and slot milling cutters
Helical milling cutters
Face milling cutters
Disc milling cutters
High feed milling cutters
Copy milling cutters
Plunge milling cutters
Chamfer milling cutters
Spot facing cutters
Inserts

Double Quattro R220.56-14 – Metric

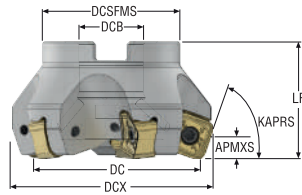

- For insert selection and cutting data recommendations, see page(s) 233-238
- For complete insert programme, see page(s) 857
- For ISO attribute explanation, see page 16

Designation	Item number	Type of mounting	DC	ZEFP	APMXS	KAPRS°	DCX	DCB	DCSFMS	LF	RPMX	Weight	Insert
			mm		mm		mm	mm	mm	mm		kg	
R220.56-0050-14-4A	03241895	Arbor	50,0	4	8,0	71,0	57,0	22,0	47,0	40,0	8500	0,4	SN.X1407ZN
R220.56-0050-14-5A	03241902	Arbor	50,0	5	8,0	71,0	57,0	22,0	47,0	40,0	8500	0,4	SN.X1407ZN
R220.56-0063-14-5A	03241896	Arbor	63,0	5	8,0	71,0	70,0	22,0	47,0	40,0	7600	0,5	SN.X1407ZN
R220.56-0063-14-6A	03241903	Arbor	63,0	6	8,0	71,0	70,0	22,0	47,0	40,0	7600	0,5	SN.X1407ZN
R220.56-0080-14-6A	03241897	Arbor	80,0	6	8,0	71,0	87,0	27,0	62,0	50,0	6700	1,0	SN.X1407ZN
R220.56-0080-14-8A	03241904	Arbor	80,0	8	8,0	71,0	87,0	27,0	62,0	50,0	6700	1,0	SN.X1407ZN
R220.56-0100-14-7A	03241898	Arbor	100,0	7	8,0	71,0	107,0	32,0	77,0	50,0	6000	1,6	SN.X1407ZN
R220.56-0100-14-10A	03241905	Arbor	100,0	10	8,0	71,0	107,0	32,0	77,0	50,0	6000	1,6	SN.X1407ZN
R220.56-0125-14-8A	03241899	Arbor	125,0	8	8,0	71,0	132,0	40,0	90,0	63,0	5400	3,1	SN.X1407ZN
R220.56-0125-14-12A	03241906	Arbor	125,0	12	8,0	71,0	132,0	40,0	90,0	63,0	5400	3,1	SN.X1407ZN
R220.56-8160-14-10A	03241900	Arbor	160,0	10	8,0	71,0	167,0	40,0	90,0	63,0	4700	5,1	SN.X1407ZN
R220.56-8160-14-15A	03241907	Arbor	160,0	15	8,0	71,0	167,0	40,0	90,0	63,0	4700	5,1	SN.X1407ZN
R220.56-8200-14-12A	03241901	Arbor	200,0	12	8,0	71,0	207,0	60,0	130,0	63,0	4200	6,9	SN.X1407ZN
R220.56-8200-14-17A	03241908	Arbor	200,0	17	8,0	71,0	207,0	60,0	130,0	63,0	4200	6,9	SN.X1407ZN

Square shoulder and slot milling cutters

Helical milling cutters

Face milling cutters

Disc milling cutters

High feed milling cutters

Copy milling cutters

Plunge milling cutters

Chamfer milling cutters

Spot facing cutters

Inserts

Spare Parts, included in delivery

For cutter	Arbor screw	Insert key	Insert screw	Lid	Lid screw
R220.56-0050-0063	220.17-692	H4B-T15P	C04011-T15P	-	-
R220.56-0080-0125	-	H4B-T15P	C04011-T15P	-	-
R220.56-0080-0125	-	H4B-T15PL	C04011-T15P	-	-
R220.56-8160	-	H4B-T15PL	C04011-T15P	SC-160-90	MF6S4X10
R220.56-8200	-	H4B-T15PL	C04011-T15P	SC-200-90	MF6S4X10

Accessories

For cutter	Arbor screw	Insert clamping torque	Torque key
R220.56-0050-0125	-	3.5NM	T00-15P35
R220.56-8160	MC6S12X40	3.5NM	T00-15P35
R220.56-8200	MC6S16X50	3.5NM	T00-15P35

Torque and fixed keys, see page 894

Square shoulder and slot milling cutters
Helical milling cutters
Face milling cutters
Disc milling cutters
High feed milling cutters
Copy milling cutters
Plunge milling cutters
Chamfer milling cutters
Spot facing cutters
Inserts

Double Quattro R220.56-14 – inch

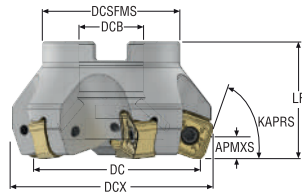

- For insert selection and cutting data recommendations, see page(s) 233-238
- For complete insert programme, see page(s) 857
- For ISO attribute explanation, see page 16

Designation	Item number	Type of mounting	DC	ZEFP	APMXS	KAPRS*	DCX	DCB	DCSFMS	LF	RPMX	Weight	Insert
			inch		inch		inch	inch	inch	inch		lbs	
R220.56-02.00-14-4A	03241909	Arbor	1.969	4	0.315	71.0	2.244	0.750	1.850	1.575	8500	0.880	SN.X1407ZN
R220.56-02.00-14-5A	03241916	Arbor	1.969	5	0.315	71.0	2.244	0.750	1.850	1.575	8500	0.880	SN.X1407ZN
R220.56-02.50-14-5A	03241910	Arbor	2.480	5	0.315	71.0	2.756	0.750	1.850	1.575	7600	1.100	SN.X1407ZN
R220.56-02.50-14-6A	03241917	Arbor	2.480	6	0.315	71.0	2.756	0.750	1.850	1.575	7600	1.100	SN.X1407ZN
R220.56-03.00-14-6A	03241911	Arbor	3.150	6	0.315	71.0	3.425	1.000	2.441	1.969	6700	2.650	SN.X1407ZN
R220.56-03.00-14-8A	03241918	Arbor	3.150	8	0.315	71.0	3.425	1.000	2.441	1.969	6700	2.650	SN.X1407ZN
R220.56-04.00-14-7A	03241912	Arbor	3.937	7	0.315	71.0	4.213	1.500	3.031	1.969	6000	3.530	SN.X1407ZN
R220.56-04.00-14-10A	03241919	Arbor	3.937	10	0.315	71.0	4.213	1.500	3.031	1.969	6000	3.530	SN.X1407ZN
R220.56-05.00-14-8A	03241913	Arbor	4.921	8	0.315	71.0	5.197	1.500	3.543	2.480	5400	7.500	SN.X1407ZN
R220.56-05.00-14-12A	03241920	Arbor	4.921	12	0.315	71.0	5.197	1.500	3.543	2.480	5400	7.500	SN.X1407ZN
R220.56-06.00-14-10A	03241914	Arbor	6.299	10	0.315	71.0	6.575	2.000	4.331	2.480	4700	13.230	SN.X1407ZN
R220.56-06.00-14-15A	03241921	Arbor	6.299	15	0.315	71.0	6.575	2.000	4.331	2.480	4700	12.570	SN.X1407ZN
R220.56-808.00-14-12A	03241915	Arbor	7.874	12	0.315	71.0	8.150	2.500	5.118	2.480	4200	15.210	SN.X1407ZN
R220.56-808.00-14-17A	03241922	Arbor	7.874	17	0.315	71.0	8.150	2.500	5.118	2.480	4200	14.990	SN.X1407ZN

Square shoulder and slot milling cutters

Helical milling cutters

Face milling cutters

Disc milling cutters

High feed milling cutters

Copy milling cutters

Plunge milling cutters

Chamfer milling cutters

Spot facing cutters

Inserts

Spare Parts, included in delivery

For cutter	Arbor screw	Insert key	Insert screw	Lid	Lid screw
R220.56-02.00-02.50	UC6S3/8UNFX1	H4B-T15P	C04011-T15P	-	-
R220.56-03.00	UC6S1/2UNFX1-1/4	H4B-T15P	C04011-T15P	-	-
R220.56-04.00	UF6S3/4UNFX1-3/4	H4B-T15PL	C04011-T15P	-	-
R220.56-05.00	UC6S3/4UNFX1-1/4	H4B-T15PL	C04011-T15P	-	-
R220.56-06.00	-	H4B-T15PL	C04011-T15P	SC-160-90	MF6S4X10
R220.56-808.00	-	H4B-T15PL	C04011-T15P	SC-200-90	MF6S4X10

Accessories

For cutter	Arbor screw	Insert clamping torque	Torque key
R220.56-02.00-05.00	-	31.0IN.LBS	T00-15P35
R220.56-06.00	58215080	31.0IN.LBS	T00-15P35
R220.56-808.00	950DNC062225	31.0IN.LBS	T00-15P35

Torque and fixed keys, see page 894

Square shoulder and slot milling cutters
Helical milling cutters
Face milling cutters
Disc milling cutters
High feed milling cutters
Copy milling cutters
Plunge milling cutters
Chamfer milling cutters
Spot facing cutters
Inserts

Double Quattro R220.54/56-14CA – Metric

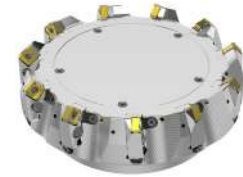
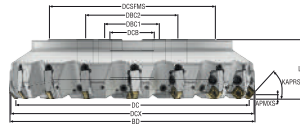

- For insert selection and cutting data recommendations, see page(s) 233-238
- For complete insert programme, see page(s) 857
- For ISO attribute explanation, see page 16

Designation	Item number	Type of mounting	DC	ZEFP	APMXS	KAPRS°	DCX	BD	DCB	DCSFMS	LF	RPMX	Weight	Insert
			mm		mm		mm	mm	mm	mm	mm		kg	
R220.54-8160-14-9CA	03213787	Arbor	160,0	9	6,0	48,0	175,0	176,5	40,0	90,0	80,0	4700	7,7	SN.X1407AN
R220.54-8200-14-11CA	03213788	Arbor	200,0	11	6,0	48,0	215,0	216,5	60,0	130,0	80,0	4200	9,8	SN.X1407AN
R220.54-8250-14-14CA	03213789	Arbor	250,0	14	6,0	48,0	265,0	266,5	60,0	130,0	80,0	3800	18,7	SN.X1407AN
R220.54-8315-14-16CA	03213790	Arbor	315,0	16	6,0	48,0	330,0	331,5	60,0	225,0	80,0	3400	32,0	SN.X1407AN
R220.56-8160-14-9CA	03245958	Arbor	160,0	9	8,0	71,0	167,0	175,5	40,0	90,0	80,0	4700	7,7	SN.X1407ZN
R220.56-8200-14-11CA	03245959	Arbor	200,0	11	8,0	71,0	207,0	215,5	60,0	130,0	80,0	4200	18,6	SN.X1407ZN
R220.56-8250-14-14CA	03245960	Arbor	250,0	14	8,0	71,0	257,0	265,5	60,0	130,0	80,0	3800	18,5	SN.X1407ZN
R220.56-8315-14-16CA	03245961	Arbor	315,0	16	8,0	71,0	322,0	330,5	60,0	225,0	80,0	3400	29,8	SN.X1407ZN

Spare Parts, included in delivery

For cutter	Adjustment unit	Cassette	Cassette screw	Insert key	Insert screw	Lid	Lid screw	Wedge clamp	Wedge screw
R220.54-8160	AU1114T-T15P	SN14AR	MC6S6X20	H4B-T15PL	C04011-T15P	SC-160-90	MF6S4X10	CW0810	LD8020-T25P
R220.54-8200	AU1114T-T15P	SN14AR	MC6S6X20	H4B-T15PL	C04011-T15P	SC-200-90	MF6S4X10	CW0810	LD8020-T25P
R220.54-8250	AU1114T-T15P	SN14AR	MC6S6X20	H4B-T15PL	C04011-T15P	SC-250-90	MF6S4X10	CW0810	LD8020-T25P
R220.54-8315	AU1114T-T15P	SN14AR	MC6S6X20	H4B-T15PL	C04011-T15P	SC-315-90	MF6S4X10	CW0810	LD8020-T25P
R220.56-8160	AU1114T-T15P	SN14ZR	MC6S6X20	H4B-T15PL	C04011-T15P	SC-160-90	MF6S4X8	CW0810	LD8020-T25P
R220.56-8200	AU1114T-T15P	SN14ZR	MC6S6X20	H4B-T15PL	C04011-T15P	SC-200-90	MF6S4X8	CW0810	LD8020-T25P
R220.56-8250	AU1114T-T15P	SN14ZR	MC6S6X20	H4B-T15PL	C04011-T15P	SC-250-90	MF6S4X10	CW0810	LD8020-T25P
R220.56-8315	AU1114T-T15P	SN14ZR	MC6S6X20	H4B-T15PL	C04011-T15P	SC-315-90	MF6S4X10	CW0810	LD8020-T25P

Accessories

For cutter	Arbor screw	Arbor screw 2	Insert clamping torque	Torque key
R220.54/56-8160	MC6S12X40	-	3.5NM	T00-15P35
R220.54/56-8200	MC6S16X50	-	3.5NM	T00-15P35
R220.54/56-8250	MC6S16X50	-	3.5NM	T00-15P35
R220.54/56-8315	MC6S16X50	MC6S20X50	3.5NM	T00-15P35

Torque and fixed keys, see page 894

Square shoulder and slot milling cutters
Helical milling cutters
Face milling cutters
Disc milling cutters
High feed milling cutters
Copy milling cutters
Plunge milling cutters
Chamfer milling cutters
Spot facing cutters
Inserts

Double Quattro R220.54/56-14CA – inch

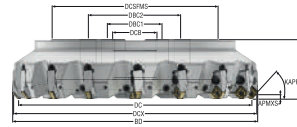

- For insert selection and cutting data recommendations, see page(s) 233-238
- For complete insert programme, see page(s) 857
- For ISO attribute explanation, see page 16

Designation	Item number	Type of mounting	DC	ZEP	APMXS	KAPRS°	DCX	BD	DCB	DCSFMS	LF	RPMX	Weight	Insert
			inch		inch		inch	inch	inch	inch	inch		lbs	
R220.54-06.00-14-9CA	03213791	Arbor	6.299	9	0.236	48,0	6.890	6.949	2.000	4.331	3.150	4700	16.090	SN.X1407AN
R220.54-808.00-14-11CA	03213792	Arbor	7.874	11	0.236	48,0	8.465	8.524	2.500	5.118	3.150	4200	32.850	SN.X1407AN
R220.54-810.00-14-14CA	03213793	Arbor	9.843	14	0.236	48,0	10.433	10.492	2.500	5.118	3.150	3800	41.890	SN.X1407AN
R220.54-812.50-14-16CA	03213794	Arbor	12.402	16	0.236	48,0	12.992	13.051	2.500	8.858	3.150	3400	65.700	SN.X1407AN
R220.56-06.00-14-9CA	03245962	Arbor	6.299	9	0.315	71,0	6.575	6.909	2.000	4.331	3.150	4700	17.420	SN.X1407ZN
R220.56-808.00-14-11CA	03245963	Arbor	7.874	11	0.315	71,0	8.150	8.484	2.500	5.118	3.150	4200	22.490	SN.X1407ZN
R220.56-810.00-14-14CA	03245964	Arbor	9.843	14	0.315	71,0	10.118	10.453	2.500	5.118	3.150	3800	43.650	SN.X1407ZN
R220.56-812.50-14-16CA	03245965	Arbor	12.402	16	0.315	71,0	12.677	13.012	2.500	8.858	3.150	3400	65.920	SN.X1407ZN

Spare Parts, included in delivery

For cutter	Adjustment unit	Cassette	Cassette screw	Insert screw	Lid	Lid screw	Wedge clamp	Wedge screw
R220.54-06.00	AU1114T-T15P	SN14AR	MC6S6X20	C04011-T15P	SC-160-90	MF6S4X10	CW0810	LD8020-T25P
R220.54-808.00	AU1114T-T15P	SN14AR	MC6S6X20	C04011-T15P	SC-200-90	MF6S4X8	CW0810	LD8020-T25P
R220.54-810.00	AU1114T-T15P	SN14AR	MC6S6X20	C04011-T15P	SC-250-90	MF6S4X10	CW0810	LD8020-T25P
R220.54-812.50	AU1114T-T15P	SN14AR	MC6S6X20	C04011-T15P	SC-315-90	MF6S4X10	CW0810	LD8020-T25P
R220.56-06.00	AU1114T-T15P	SN14ZR	MC6S6X20	C04011-T15P	SC-160-90	MF6S4X8	CW0810	LD8020-T25P
R220.56-808.00	AU1114T-T15P	SN14ZR	MC6S6X20	C04011-T15P	SC-200-90	MF6S4X8	CW0810	LD8020-T25P
R220.56-810.00	AU1114T-T15P	SN14ZR	MC6S6X20	C04011-T15P	SC-250-90	MF6S4X10	CW0810	LD8020-T25P
R220.56-812.50	AU1114T-T15P	SN14ZR	MC6S6X20	C04011-T15P	SC-315-90	MF6S4X10	CW0810	LD8020-T25P

Accessories

For cutter	Arbor screw	Insert clamping torque	Torque key
R220.54/56-06.00	58215080	31.0IN.LBS	T00-15P35
R220.54/56-06.00-810.00	950DNC062225	31.0IN.LBS	T00-15P35
R220.54/56-812.50	950DNC062225	31.0IN.LBS	T00-15P35

Torque and fixed keys, see page 894

R220.54-14 – Insert selection – mm/Inch

SMG		a _p	f _z			
			80%	60%	40%	20%
P1	SNMX1407ANTR-M10 T350M	5,0 0.20	0,24 0.0095	0,24 0.0095	0,25 0.010	0,32 0.013
P2	SNMX1407ANTR-M10 T350M	5,0 0.20	0,25 0.010	0,25 0.010	0,26 0.010	0,32 0.013
P3	SNMX1407ANTR-M16 MP2501	5,0 0.20	0,38 0.015	0,38 0.015	0,38 0.015	0,48 0.019
P4	SNMX1407ANTR-M16 MP2501	5,0 0.20	0,36 0.014	0,36 0.014	0,38 0.015	0,48 0.019
P5	SNMX1407ANTR-M16 MP2501	5,0 0.20	0,36 0.014	0,36 0.014	0,38 0.015	0,46 0.018
P6	SNMX1407ANTR-M16 MP2501	5,0 0.20	0,36 0.014	0,36 0.014	0,36 0.014	0,46 0.018
P7	SNMX1407ANTR-M10 T350M	5,0 0.20	0,22 0.0085	0,22 0.0085	0,24 0.0095	0,28 0.011
P8	SNMX1407ANTR-M10 T350M	5,0 0.20	0,24 0.0095	0,24 0.0095	0,24 0.0095	0,30 0.012
P11	SNMX1407ANTR-M10 MP2050	5,0 0.20	0,22 0.0085	0,22 0.0085	0,24 0.0095	0,28 0.011
P12	SNMX1407ANTR-M10 MP2050	4,0 0.16	0,16 0.0065	0,16 0.0065	0,16 0.0065	0,20 0.0080
M1	SNHX1407ANR-ME10 F40M	5,0 0.20	0,20 0.0080	0,20 0.0080	0,22 0.0085	0,26 0.010
M2	SNHX1407ANR-ME10 MS2050	5,0 0.20	0,19 0.0075	0,19 0.0075	0,20 0.0080	0,24 0.0095
M3	SNHX1407ANR-ME10 MS2050	4,0 0.16	0,15 0.0060	0,15 0.0060	0,16 0.0065	0,20 0.0080
M4	SNMX1407ANTR-M10 MP2050	3,0 0.12	0,17 0.0065	0,17 0.0065	0,17 0.0065	0,22 0.0085
M5	SNMX1407ANTR-M10 MP2050	3,0 0.12	0,17 0.0065	0,17 0.0065	0,17 0.0065	0,22 0.0085
K1	SNMX1407ANTR-M16 MK1500	5,0 0.20	0,40 0.016	0,40 0.016	0,40 0.016	0,50 0.020
K2	SNMX1407ANTR-M16 MK1500	5,0 0.20	0,36 0.014	0,36 0.014	0,38 0.015	0,46 0.018
K3	SNMX1407ANTR-M16 MP1501	5,0 0.20	0,36 0.014	0,36 0.014	0,38 0.015	0,46 0.018
K4	SNMX1407ANTR-M16 MP1501	5,0 0.20	0,36 0.014	0,36 0.014	0,38 0.015	0,46 0.018
K5	SNMX1407ANTR-M16 MP1501	5,0 0.20	0,32 0.013	0,32 0.013	0,34 0.013	0,42 0.017
K6	SNMX1407ANTR-M16 MK2050	5,0 0.20	0,36 0.014	0,36 0.014	0,38 0.015	0,46 0.018
K7	SNMX1407ANTR-M16 MK2050	5,0 0.20	0,32 0.013	0,32 0.013	0,34 0.013	0,42 0.017
N1	SNHX1407ANR-ME10 H25	5,0 0.20	0,26 0.010	0,26 0.010	0,28 0.011	0,34 0.013
N2	SNHX1407ANR-ME10 H25	5,0 0.20	0,26 0.010	0,26 0.010	0,28 0.011	0,34 0.013
N3	SNHX1407ANR-ME10 H25	5,0 0.20	0,26 0.010	0,26 0.010	0,28 0.011	0,34 0.013
N11	SNHX1407ANR-ME10 H25	5,0 0.20	0,26 0.010	0,26 0.010	0,28 0.011	0,34 0.013
S1	SNMX1407ANTR-M10 MS2500	3,0 0.12	0,17 0.0065	0,17 0.0065	0,17 0.0065	0,22 0.0085
S2	SNMX1407ANTR-M10 MS2500	3,0 0.12	0,17 0.0065	0,17 0.0065	0,17 0.0065	0,22 0.0085
S3	SNMX1407ANTR-M10 MS2500	3,0 0.12	0,15 0.0060	0,15 0.0060	0,16 0.0065	0,20 0.0080
S11	SNHX1407ANR-ME10 MS2050	3,5 0.14	0,16 0.0065	0,16 0.0065	0,16 0.0065	0,20 0.0080
S12	SNHX1407ANR-ME10 MS2050	3,5 0.14	0,16 0.0065	0,16 0.0065	0,16 0.0065	0,20 0.0080
S13	SNHX1407ANR-ME10 MS2050	3,0 0.12	0,14 0.0055	0,14 0.0055	0,14 0.0055	0,18 0.0070
H5	SNMX1407ANTR-M16 MP3000	4,0 0.16	0,25 0.010	0,25 0.010	0,26 0.010	0,32 0.013
H8	SNMX1407ANTR-M16 MP3000	3,5 0.14	0,19 0.0075	0,19 0.0075	0,20 0.0080	0,25 0.010
H11	SNMX1407ANTR-M16 MP1501	4,0 0.16	0,25 0.010	0,25 0.010	0,26 0.010	0,32 0.013
H12	SNMX1407ANTR-M16 MP1501	3,5 0.14	0,19 0.0075	0,19 0.0075	0,20 0.0080	0,25 0.010
H21	SNMX1407ANTR-M16 MP1501	3,5 0.14	0,19 0.0075	0,19 0.0075	0,20 0.0080	0,25 0.010

SMG = Seco material group
f_z = mm/tooth (in/tooth), v_c = m/min (sf/min), a_p/DC = %
All cutting data are start values

Square shoulder and slot milling cutters
Helical milling cutters
Face milling cutters
Disc milling cutters
High feed milling cutters
Copy milling cutters
Plunge milling cutters
Chamfer milling cutters
Spot facing cutters
Inserts

R220.54-14 – Cutting data $v_c = (m/min)/(sf/min)$

SMG	MK1500				MP1501				MP2501				T350M				MS2500				MM4500							
	100%	80%	60%	40%	100%	80%	60%	40%	100%	80%	60%	40%	100%	80%	60%	40%	100%	80%	60%	40%	100%	80%	60%	40%				
P1	—	—	—	—	310	330	360	395	275	295	315	350	240	255	275	305	300	320	345	380	170	180	195	215	210	225	245	275
	—	—	—	—	1025	1075	1175	1300	900	970	1025	1150	790	840	900	1000	980	1050	1125	1250	560	590	640	710	560	590	640	710
P2	—	—	—	—	295	320	345	380	265	280	305	335	230	245	265	295	285	310	335	365	160	175	185	205	160	175	185	205
	—	—	—	—	970	1050	1125	1250	870	920	1000	1100	750	800	870	970	940	1025	1100	1200	520	570	610	670	520	570	610	670
P3	—	—	—	—	260	280	300	335	230	245	265	295	200	215	230	260	250	270	290	325	140	150	165	180	140	150	165	180
	—	—	—	—	850	920	980	1100	750	800	870	970	660	710	750	850	820	890	950	1075	460	490	540	590	460	490	540	590
P4	—	—	—	—	230	245	265	295	200	215	235	260	175	190	205	230	220	235	255	285	125	135	145	160	125	135	145	160
	—	—	—	—	750	800	870	970	660	710	770	850	570	620	670	750	720	770	840	940	410	445	475	520	410	445	475	520
P5	—	—	—	—	225	240	260	280	200	210	230	250	170	185	200	215	215	230	250	270	120	130	140	155	120	130	140	155
	—	—	—	—	740	790	850	920	660	690	750	820	560	610	660	710	710	750	820	890	395	425	460	510	395	425	460	510
P6	—	—	—	—	250	270	290	315	220	240	260	280	195	210	225	245	240	260	280	305	135	145	160	170	135	145	160	170
	—	—	—	—	820	890	950	1025	720	790	850	920	640	690	740	800	790	850	920	1000	445	475	520	560	445	475	520	560
P7	—	—	—	—	235	255	275	300	210	225	245	265	185	195	210	230	230	245	265	290	130	140	150	160	130	140	150	160
	—	—	—	—	770	840	900	980	690	740	800	870	610	640	690	750	750	800	870	950	425	460	490	520	425	460	490	520
P8	—	—	—	—	215	235	250	280	195	205	225	250	170	180	195	215	210	225	245	270	120	125	135	155	120	125	135	155
	—	—	—	—	710	770	820	920	640	670	740	820	560	590	640	710	690	740	800	890	395	410	445	510	395	410	445	510
P11	—	—	—	—	230	245	265	290	205	220	235	255	175	190	205	225	220	240	260	280	125	135	145	160	125	135	145	160
	—	—	—	—	750	800	870	950	670	720	770	840	570	620	670	740	720	790	850	920	410	445	475	520	410	445	475	520
P12	—	—	—	—	150	160	170	190	130	140	150	170	115	125	130	145	145	155	165	185	80	85	95	105	80	85	95	105
	—	—	—	—	490	520	560	620	425	460	490	560	375	410	425	475	475	510	540	610	260	280	310	345	260	280	310	345
M1	—	—	—	—	—	—	—	—	190	205	220	240	175	190	205	225	205	220	240	265	140	150	160	175	140	150	160	175
	—	—	—	—	—	—	—	—	620	670	720	790	570	620	670	740	670	720	790	870	460	490	520	570	460	490	520	570
M2	—	—	—	—	—	—	—	—	160	170	185	200	150	160	170	185	175	185	200	220	115	125	135	145	115	125	135	145
	—	—	—	—	—	—	—	—	520	560	610	660	490	520	560	610	570	610	660	720	375	410	445	475	375	410	445	475
M3	—	—	—	—	—	—	—	—	130	135	150	160	120	130	140	150	140	150	160	175	95	100	110	120	95	100	110	120
	—	—	—	—	—	—	—	—	425	445	490	520	395	425	460	490	460	490	520	570	310	330	360	395	310	330	360	395
M4	—	—	—	—	—	—	—	—	100	105	110	125	90	95	105	115	105	115	120	135	70	75	80	90	70	75	80	90
	—	—	—	—	—	—	—	—	330	345	360	410	295	310	345	375	345	375	395	445	230	245	260	295	230	245	260	295
M5	—	—	—	—	—	—	—	—	80	85	95	105	75	80	85	95	90	95	100	115	60	65	70	75	60	65	70	75
	—	—	—	—	—	—	—	—	260	280	310	345	245	260	280	310	295	310	330	375	195	215	230	245	195	215	230	245
K1	250	270	290	330	235	250	275	300	210	225	240	265	180	195	210	230	—	—	—	—	—	—	—	—	—	—	—	—
	820	890	950	1075	770	820	900	980	690	740	790	870	590	640	690	750	—	—	—	—	—	—	—	—	—	—	—	—
K2	225	245	265	290	210	230	245	265	190	200	220	235	165	175	190	205	—	—	—	—	—	—	—	—	—	—	—	—
	740	800	870	950	690	750	800	870	620	660	720	770	540	570	620	670	—	—	—	—	—	—	—	—	—	—	—	—
K3	190	205	220	245	180	195	210	225	160	170	185	200	140	150	160	175	—	—	—	—	—	—	—	—	—	—	—	—
	620	670	720	800	590	640	690	740	520	560	610	660	460	490	520	570	—	—	—	—	—	—	—	—	—	—	—	—
K4	185	195	210	235	170	185	200	215	150	165	175	190	130	140	155	165	—	—	—	—	—	—	—	—	—	—	—	—
	610	640	690	770	560	610	660	710	490	540	570	620	425	460	510	540	—	—	—	—	—	—	—	—	—	—	—	—
K5	115	120	130	145	105	115	120	130	95	100	110	115	80	85	95	100	—	—	—	—	—	—	—	—	—	—	—	—
	375	395	425	475	345	375	395	425	310	330	360	375	260	280	310	330	—	—	—	—	—	—	—	—	—	—	—	—
K6	160	175	185	205	150	160	175	190	135	145	155	170	115	125	135	145	—	—	—	—	—	—	—	—	—	—	—	—
	520	570	610	670	490	520	570	620	445	475	510	560	375	410	445	475	—	—	—	—	—	—	—	—	—	—	—	—
K7	145	155	170	185	135	145	155	170	120	130	140	150	105	110	120	130	—	—	—	—	—	—	—	—	—	—	—	—
	475	510	560	610	445	475	510	560	395	425	460	490	345	360	395	425	—	—	—	—	—	—	—	—	—	—	—	—
N1	—	—	—	—	—	—	—	—	—	—	—	—	—	—	—	—	—	—	—	—	—	—	—	—	—	—	—	—
	—	—	—	—	—	—	—	—	—	—	—	—	—	—	—	—	—	—	—	—	—	—	—	—	—	—	—	—
N2	—	—	—	—	—	—	—	—	—	—	—	—	—	—	—	—	—	—	—	—	—	—	—	—	—	—	—	—
	—	—	—	—	—	—	—	—	—	—	—	—	—	—	—	—	—	—	—	—	—	—	—	—	—	—	—	—
N3	—	—	—	—	—	—	—	—	—	—	—	—	—	—	—	—	—	—	—	—	—	—	—	—	—	—	—	—
	—	—	—	—	—	—	—	—	—	—	—	—	—	—	—	—	—	—	—	—	—	—	—	—	—	—	—	—
N11	—	—	—	—	—	—	—	—	—	—	—	—	—	—	—	—	—	—	—	—	—	—	—	—	—	—	—	—
	—	—	—	—	—	—	—	—	—	—	—	—	—	—	—	—	—	—	—	—	—	—	—	—	—	—	—	—
S1	—	—	—	—	—	—	—	—	48	50	55	60	42	45	49	55	50	55	60	65	22	23	25	28	22	23	25	28
	—	—	—	—	—	—	—	—	155	165	180	195	140	150	160	180	165</											

R220.54-14 – Cutting data $v_c = (m/min)/(sf/min)$

SMG	F40M				MK2050				MS2050				MP3000				MP2050				H25			
	100%	80%	60%	40%	100%	80%	60%	40%	100%	80%	60%	40%	100%	80%	60%	40%	100%	80%	60%	40%	100%	80%	60%	40%
P1	205	220	240	265	230	245	270	295	230	245	265	290	260	280	300	330	270	290	310	345	—	—	—	—
	670	720	790	870	750	800	890	970	750	800	870	950	850	920	980	1075	890	950	1025	1125	—	—	—	—
P2	200	215	230	255	220	235	255	290	220	235	255	280	250	265	290	320	260	275	300	330	—	—	—	—
	660	710	750	840	720	770	840	950	720	770	840	920	820	870	950	1050	850	900	980	1075	—	—	—	—
P3	175	185	200	225	195	205	225	250	190	205	220	245	215	235	250	280	225	240	260	290	—	—	—	—
	570	610	660	740	640	670	740	820	620	670	720	800	710	770	820	920	740	790	850	950	—	—	—	—
P4	155	165	175	200	175	185	200	220	170	180	195	220	190	205	220	245	200	215	230	255	—	—	—	—
	510	540	570	660	570	610	660	720	560	590	640	720	620	670	720	800	660	710	750	840	—	—	—	—
P5	150	160	175	190	165	180	190	210	165	175	190	210	185	200	215	235	195	210	225	245	—	—	—	—
	490	520	570	620	540	580	620	690	540	570	620	690	610	660	710	770	640	690	740	800	—	—	—	—
P6	170	180	195	210	185	200	215	240	185	200	215	235	210	225	245	265	220	235	255	275	—	—	—	—
	560	590	640	690	610	660	710	790	610	660	710	770	690	740	800	870	720	770	840	900	—	—	—	—
P7	160	170	185	200	175	190	205	230	175	190	205	220	200	215	230	250	205	220	240	260	—	—	—	—
	520	560	610	660	570	620	670	750	570	620	670	720	660	710	750	820	670	720	790	850	—	—	—	—
P8	145	155	170	190	165	175	190	210	160	170	185	210	180	195	210	235	190	205	220	245	—	—	—	—
	475	510	560	620	540	570	620	690	520	560	610	690	590	640	690	770	620	670	720	800	—	—	—	—
P11	155	165	180	195	170	185	200	220	170	180	195	215	195	205	225	245	200	215	230	250	—	—	—	—
	510	540	590	640	560	610	660	720	560	590	640	710	640	670	740	800	660	710	750	820	—	—	—	—
P12	100	105	115	130	115	120	130	145	110	115	125	140	125	135	145	160	130	140	150	165	—	—	—	—
	330	345	375	425	375	395	425	475	360	375	410	460	410	445	475	520	425	460	490	540	—	—	—	—
M1	160	170	185	205	—	—	—	—	175	190	205	225	185	200	215	240	185	200	215	235	—	—	—	—
	520	560	610	670	—	—	—	—	570	620	670	740	610	660	710	790	610	660	710	770	—	—	—	—
M2	135	145	155	170	—	—	—	—	150	160	170	185	155	170	180	195	155	165	180	195	—	—	—	—
	445	475	510	560	—	—	—	—	490	520	560	610	510	560	590	640	510	540	590	640	—	—	—	—
M3	110	115	125	140	—	—	—	—	120	130	140	150	125	135	145	160	125	135	145	160	—	—	—	—
	360	375	410	460	—	—	—	—	395	425	460	490	410	445	475	520	410	445	475	520	—	—	—	—
M4	85	90	95	105	—	—	—	—	90	95	105	115	95	105	110	125	95	100	110	120	—	—	—	—
	280	295	310	345	—	—	—	—	295	310	345	375	310	345	360	410	310	330	360	395	—	—	—	—
M5	70	75	80	90	—	—	—	—	75	80	85	95	80	85	90	105	80	85	90	100	—	—	—	—
	230	245	260	295	—	—	—	—	245	260	280	310	260	280	295	345	260	280	295	330	—	—	—	—
K1	160	170	185	200	240	255	275	310	—	—	—	—	195	210	230	250	—	—	—	—	—	—	—	—
	520	560	610	660	790	840	900	1025	—	—	—	—	640	690	750	820	—	—	—	—	—	—	—	—
K2	140	155	165	180	215	230	250	275	—	—	—	—	180	190	205	225	—	—	—	—	—	—	—	—
	460	510	540	590	710	750	820	900	—	—	—	—	590	620	670	740	—	—	—	—	—	—	—	—
K3	120	130	140	150	180	195	210	230	—	—	—	—	150	160	175	190	—	—	—	—	—	—	—	—
	395	425	460	490	590	640	690	750	—	—	—	—	490	520	570	620	—	—	—	—	—	—	—	—
K4	115	125	135	145	175	185	200	220	—	—	—	—	145	155	165	180	—	—	—	—	—	—	—	—
	375	410	445	475	570	610	660	720	—	—	—	—	475	510	540	590	—	—	—	—	—	—	—	—
K5	70	75	80	90	105	115	125	135	—	—	—	—	90	95	100	110	—	—	—	—	—	—	—	—
	230	245	260	295	345	375	410	445	—	—	—	—	295	310	330	360	—	—	—	—	—	—	—	—
K6	100	110	115	130	155	165	175	195	—	—	—	—	125	135	145	160	—	—	—	—	—	—	—	—
	330	360	375	425	510	540	570	640	—	—	—	—	410	445	475	520	—	—	—	—	—	—	—	—
K7	90	95	105	115	135	145	160	175	—	—	—	—	115	120	130	140	—	—	—	—	—	—	—	—
	295	310	345	375	445	475	520	570	—	—	—	—	375	395	425	460	—	—	—	—	—	—	—	—
N1	1150	1225	1325	1500	—	—	—	—	—	—	—	—	—	—	—	—	—	—	—	—	1200	1275	1400	1525
	3775	4025	4350	4925	—	—	—	—	—	—	—	—	—	—	—	—	—	—	—	—	3925	4175	4600	5000
N2	465	500	540	600	—	—	—	—	—	—	—	—	—	—	—	—	—	—	—	—	485	520	560	610
	1525	1650	1775	1975	—	—	—	—	—	—	—	—	—	—	—	—	—	—	—	—	1600	1700	1825	2000
N3	310	330	360	405	—	—	—	—	—	—	—	—	—	—	—	—	—	—	—	—	320	345	375	410
	1025	1075	1175	1325	—	—	—	—	—	—	—	—	—	—	—	—	—	—	—	—	1050	1125	1225	1350
N11	355	380	410	460	—	—	—	—	—	—	—	—	—	—	—	—	—	—	—	—	370	395	425	465
	1175	1250	1350	1500	—	—	—	—	—	—	—	—	—	—	—	—	—	—	—	—	1225	1300	1400	1525
S1	39	41	44	49	—	—	—	—	42	45	49	55	45	48	50	55	47	50	55	60	—	—	—	—
	130	135	145	160	—	—	—	—	140	150	160	180	150	155	165	180	155	165	180	195	—	—	—	—
S2	31	33	36	40	—	—	—	—	34	37	39	44	36	39	42	46	38	40	43	48	—	—	—	—
	100	110	120	130	—	—	—	—	110	120	130	145	120	130	140	150	125	130	140	155	—	—	—	—
S3	28	30	32	35	—	—	—	—	31	33	35	38	32	34	37	41	33	36	39	42	—	—	—	—
	90	100	105	115	—	—	—	—	100	110	115	125	105	110	120	135	110	120	130	140	—	—	—	—
S11	55	60	60	70	—	—	—	—	60	65	70	75	65	65	70	80	65	70	75	85	—	—	—	—
	180	195	195	230	—	—	—	—	195	215	230	245	215	215	230	260	215	230	245	280	—	—	—	—
S12	37	40	43	48	—	—	—	—	41	44	47	55	43	46	50	55	45	48	50	60	—	—	—	—
	120	130	140	155	—	—	—	—	135	145	155	180	140	150	165	180	150	155	165	195	—	—	—	—
S13	22	23	25	28	—	—	—	—	24	26	28	31	25	27	29	32	26	28	30	34	—	—	—	—
	70	75	80	90	—	—	—	—	80	85	90	100	80	90	95	105	85	90	100	110	—	—	—	—
H5	33	35	38	42	—	—	—	—	—	—	—	—	39	41	45	50	—	—	—	—	—			

R220.56-14 – Insert selection – mm/Inch

SMG		a _p	f _z			
			80%	60%	40%	20%
P1	SNMX1407ZNTR-M10 T350M	6,0	0,19	0,19	0,19	0,24
		0,24	0,0075	0,0075	0,0075	0,0095
P2	SNMX1407ZNTR-M10 T350M	6,0	0,19	0,19	0,20	0,24
		0,24	0,0075	0,0075	0,0080	0,0095
P3	SNMX1407ZNTR-M16 MP2501	6,0	0,28	0,28	0,30	0,36
		0,24	0,011	0,011	0,012	0,014
P4	SNMX1407ZNTR-M16 MP2501	6,0	0,28	0,28	0,28	0,36
		0,24	0,011	0,011	0,011	0,014
P5	SNMX1407ZNTR-M16 MP2501	6,0	0,28	0,28	0,28	0,34
		0,24	0,011	0,011	0,011	0,013
P6	SNMX1407ZNTR-M16 MP2501	6,0	0,28	0,28	0,28	0,34
		0,24	0,011	0,011	0,011	0,013
P7	SNMX1407ZNTR-M10 T350M	6,0	0,17	0,17	0,18	0,22
		0,24	0,0065	0,0065	0,0070	0,0085
P8	SNMX1407ZNTR-M10 T350M	6,0	0,18	0,18	0,19	0,22
		0,24	0,0070	0,0070	0,0075	0,0085
P11	SNMX1407ZNTR-M10 MP2050	6,0	0,17	0,17	0,18	0,22
		0,24	0,0065	0,0065	0,0070	0,0085
P12	SNMX1407ZNTR-M10 MP2050	5,0	0,12	0,12	0,12	0,15
		0,20	0,0048	0,0048	0,0048	0,0060
M1	SNHX1407ZNR-ME10 MS2050	6,0	0,16	0,16	0,16	0,20
		0,24	0,0065	0,0065	0,0065	0,0080
M2	SNHX1407ZNR-ME10 MS2050	6,0	0,15	0,15	0,15	0,18
		0,24	0,0060	0,0060	0,0060	0,0070
M3	SNHX1407ZNR-ME10 MS2050	5,0	0,12	0,12	0,12	0,15
		0,20	0,0048	0,0048	0,0048	0,0060
M4	SNMX1407ZNTR-M10 MP2050	4,0	0,13	0,13	0,13	0,16
		0,16	0,0050	0,0050	0,0050	0,0065
M5	SNMX1407ZNTR-M10 MP2050	4,0	0,13	0,13	0,13	0,16
		0,16	0,0050	0,0050	0,0050	0,0065
K1	SNMX1407ZNTR-M16 MK1500	6,0	0,30	0,30	0,32	0,38
		0,24	0,012	0,012	0,013	0,015
K2	SNMX1407ZNTR-M16 MK1500	6,0	0,28	0,28	0,28	0,34
		0,24	0,011	0,011	0,011	0,013
K3	SNMX1407ZNTR-M16 MP1501	6,0	0,28	0,28	0,28	0,34
		0,24	0,011	0,011	0,011	0,013
K4	SNMX1407ZNTR-M16 MP1501	6,0	0,28	0,28	0,28	0,34
		0,24	0,011	0,011	0,011	0,013
K5	SNMX1407ZNTR-M16 MP1501	6,0	0,25	0,25	0,25	0,32
		0,24	0,010	0,010	0,010	0,013
K6	SNMX1407ZNTR-M16 MK2050	6,0	0,28	0,28	0,28	0,34
		0,24	0,011	0,011	0,011	0,013
K7	SNMX1407ZNTR-M16 MK2050	6,0	0,25	0,25	0,25	0,32
		0,24	0,010	0,010	0,010	0,013
S1	SNMX1407ZNTR-M10 MS2500	4,0	0,13	0,13	0,13	0,16
		0,16	0,0050	0,0050	0,0050	0,0065
S2	SNMX1407ZNTR-M10 MS2500	4,0	0,13	0,13	0,13	0,16
		0,16	0,0050	0,0050	0,0050	0,0065
S3	SNMX1407ZNTR-M10 MS2500	4,0	0,12	0,12	0,12	0,15
		0,16	0,0048	0,0048	0,0048	0,0060
S11	SNHX1407ZNR-ME10 MS2050	4,5	0,12	0,12	0,12	0,15
		0,18	0,0048	0,0048	0,0048	0,0060
S12	SNHX1407ZNR-ME10 MS2050	4,5	0,12	0,12	0,12	0,15
		0,18	0,0048	0,0048	0,0048	0,0060
S13	SNHX1407ZNR-ME10 MS2050	4,0	0,11	0,11	0,11	0,13
		0,16	0,0044	0,0044	0,0044	0,0050
H3	SNMX1407ZNTR-M16 MP1501	—	—	—	—	—
H5	SNMX1407ZNTR-M16 MP1501	5,0	0,19	0,19	0,20	0,24
		0,20	0,0075	0,0075	0,0080	0,0095
H7	SNMX1407ZNTR-M16 MP1501	—	—	—	—	—
H8	SNMX1407ZNTR-M16 MP1501	4,5	0,15	0,15	0,15	0,19
		0,18	0,0060	0,0060	0,0060	0,0075
H11	SNMX1407ZNTR-M16 MP1501	5,0	0,19	0,19	0,20	0,24
		0,20	0,0075	0,0075	0,0080	0,0095
H12	SNMX1407ZNTR-M16 MP1501	4,5	0,15	0,15	0,15	0,19
		0,18	0,0060	0,0060	0,0060	0,0075
H21	SNMX1407ZNTR-M16 MP1501	4,5	0,15	0,15	0,15	0,19
		0,18	0,0060	0,0060	0,0060	0,0075
H31	SNMX1407ZNTR-M16 MP1501	—	—	—	—	—

SMG = Seco material group
 f_z = mm/tooth (in/tooth), v_c = m/min (sf/min), a_p/DC = %
 All cutting data are start values

R220.56-14 – Cutting data $v_c = (m/min)/(sf/min)$

SMG	MK1500				MP1501				MP2501				T350M				MS2500			
	100%	80%	60%	40%	100%	80%	60%	40%	100%	80%	60%	40%	100%	80%	60%	40%	100%	80%	60%	40%
P1	—	—	—	—	260	270	295	330	230	240	260	295	230	245	265	295	290	305	330	370
	—	—	—	—	850	890	970	1075	750	790	850	970	750	800	870	970	950	1000	1075	1225
P2	—	—	—	—	250	265	285	315	220	235	255	280	225	240	260	285	280	300	325	355
	—	—	—	—	820	870	940	1025	720	770	840	920	740	790	850	940	920	980	1075	1175
P3	—	—	—	—	220	235	255	275	195	205	225	245	195	210	225	245	245	260	280	310
	—	—	—	—	720	770	840	900	640	670	740	800	640	690	740	800	800	850	920	1025
P4	—	—	—	—	195	205	220	250	170	180	195	220	175	185	200	220	215	230	250	275
	—	—	—	—	640	670	720	820	560	590	640	720	570	610	660	720	710	750	820	900
P5	—	—	—	—	185	195	210	240	165	175	190	210	170	180	195	210	210	225	240	265
	—	—	—	—	610	640	690	790	540	570	620	690	560	590	640	690	690	740	790	870
P6	—	—	—	—	210	220	240	270	185	195	210	235	190	200	215	235	235	250	270	295
	—	—	—	—	690	720	790	890	610	640	690	770	620	660	710	770	770	820	890	970
P7	—	—	—	—	195	210	225	250	175	185	200	225	180	190	205	225	225	235	255	280
	—	—	—	—	640	690	740	820	570	610	660	740	590	620	670	740	740	770	840	920
P8	—	—	—	—	185	195	210	235	165	175	190	205	165	175	190	210	205	220	235	260
	—	—	—	—	610	640	690	770	540	570	620	670	540	570	620	690	670	720	770	850
P11	—	—	—	—	190	200	220	245	170	180	195	215	175	185	200	220	215	230	250	275
	—	—	—	—	620	660	720	800	560	590	640	710	570	610	660	720	710	750	820	900
P12	—	—	—	—	130	135	145	165	115	120	130	145	115	120	130	145	140	150	160	180
	—	—	—	—	425	445	475	540	375	395	425	475	375	395	425	475	460	490	520	590
M1	—	—	—	—	—	—	—	—	160	170	185	200	175	185	200	220	200	215	230	255
	—	—	—	—	—	—	—	—	520	560	610	660	570	610	660	720	660	710	750	840
M2	—	—	—	—	—	—	—	—	130	140	150	170	145	155	165	180	170	180	195	210
	—	—	—	—	—	—	—	—	425	460	490	560	475	510	540	590	560	590	640	690
M3	—	—	—	—	—	—	—	—	110	115	125	140	115	125	135	150	135	145	155	175
	—	—	—	—	—	—	—	—	360	375	410	460	375	410	445	490	445	475	510	570
M4	—	—	—	—	—	—	—	—	85	90	95	110	90	95	105	115	105	110	120	135
	—	—	—	—	—	—	—	—	280	295	310	360	295	310	345	375	345	360	395	445
M5	—	—	—	—	—	—	—	—	70	75	80	90	75	80	85	95	85	90	100	110
	—	—	—	—	—	—	—	—	230	245	260	295	245	260	280	310	280	295	330	360
K1	250	265	285	315	200	210	225	250	175	185	200	220	180	190	205	225	—	—	—	—
	820	870	940	1025	660	690	740	820	570	610	660	720	590	620	670	740	—	—	—	—
K2	220	235	255	285	175	185	200	225	155	165	180	200	160	170	185	200	—	—	—	—
	720	770	840	940	570	610	660	740	510	540	590	660	520	560	610	660	—	—	—	—
K3	185	200	215	240	150	160	170	190	130	140	150	170	135	145	155	170	—	—	—	—
	610	660	710	790	490	520	560	620	425	460	490	560	445	475	510	560	—	—	—	—
K4	180	190	205	230	140	150	165	185	125	135	145	160	130	135	150	160	—	—	—	—
	590	620	670	750	460	490	540	610	410	445	475	520	425	445	490	520	—	—	—	—
K5	110	115	125	140	90	95	100	110	80	85	90	100	80	85	90	100	—	—	—	—
	360	375	410	460	295	310	330	360	260	280	295	330	260	280	295	330	—	—	—	—
K6	155	165	180	200	125	135	145	160	110	115	125	145	115	120	130	145	—	—	—	—
	510	540	590	660	410	445	475	520	360	375	410	475	375	395	425	475	—	—	—	—
K7	140	150	160	180	115	120	130	145	100	105	115	125	100	105	115	130	—	—	—	—
	460	490	520	590	375	395	425	475	330	345	375	410	330	345	375	425	—	—	—	—
S1	—	—	—	—	—	—	—	—	41	44	47	55	42	44	48	55	50	55	60	65
	—	—	—	—	—	—	—	—	135	145	155	180	140	145	155	180	165	180	195	215
S2	—	—	—	—	—	—	—	—	33	35	38	42	34	36	39	43	41	44	47	50
	—	—	—	—	—	—	—	—	110	115	125	140	110	120	130	140	135	145	155	165
S3	—	—	—	—	—	—	—	—	29	31	33	37	30	32	34	38	36	38	41	46
	—	—	—	—	—	—	—	—	95	100	110	120	100	105	110	125	120	125	135	150
S11	—	—	—	—	—	—	—	—	60	60	65	70	60	65	70	75	70	75	80	90
	—	—	—	—	—	—	—	—	195	195	215	230	195	215	230	245	230	245	260	295
S12	—	—	—	—	—	—	—	—	40	42	46	50	41	44	47	50	50	55	55	60
	—	—	—	—	—	—	—	—	130	140	150	165	135	145	155	165	165	180	180	195
S13	—	—	—	—	—	—	—	—	23	25	27	30	24	25	27	30	29	30	33	36
	—	—	—	—	—	—	—	—	75	80	90	100	80	80	90	100	95	100	110	120
H5	—	—	—	—	43	45	49	55	34	36	39	44	38	40	43	48	—	—	—	—
	—	—	—	—	140	150	160	180	110	120	130	145	125	130	140	155	—	—	—	—
H8	—	—	—	—	46	49	50	60	37	39	42	47	40	43	46	50	—	—	—	—
	—	—	—	—	150	160	165	195	120	130	140	155	130	140	150	165	—	—	—	—
H11	—	—	—	—	55	55	60	70	44	46	50	55	48	50	55	60	—	—	—	—
	—	—	—	—	180	180	195	230	145	150	165	180	155	165	180	195	—	—	—	—
H12	—	—	—	—	80	85	95	105	75	75	85	95	70	75	85	90	90	95	105	115
	—	—	—	—	260	280	310	345	245	245	280	310	230	245	280	295	295	310	345	375
H21	—	—	—	—	46	49	50	60	37	39	42	47	40	43	46	50	—	—	—	—
	—	—	—	—	150	160	165	195	120	130	140	155	130	140	150	165	—	—	—	—

Square shoulder and slot milling cutters
Helical milling cutters
Face milling cutters
Disc milling cutters
High feed milling cutters
Copy milling cutters
Plunge milling cutters
Chamfer milling cutters
Spot facing cutters
Inserts

R220.56-14 – Cutting data $v_c = (m/min)/(sf/min)$

SMG	F40M				MS2050				MP3000				MP2050			
	100%	80%	60%	40%	100%	80%	60%	40%	100%	80%	60%	40%	100%	80%	60%	40%
P1	200	215	230	255	220	235	255	285	250	265	290	320	260	275	300	335
	660	710	750	840	720	770	840	940	820	870	950	1050	850	900	980	1100
P2	195	205	225	245	215	230	245	270	245	260	280	310	255	270	290	320
	640	670	740	800	710	750	800	890	800	850	920	1025	840	890	950	1050
P3	170	180	195	215	190	200	215	235	215	225	245	270	220	235	255	280
	560	590	640	710	620	660	710	770	710	740	800	890	720	770	840	920
P4	150	160	175	195	165	175	190	210	190	200	215	240	195	205	225	250
	490	520	570	640	540	570	620	690	620	660	710	790	640	670	740	820
P5	145	155	170	185	160	170	185	200	185	195	210	230	190	200	215	240
	475	510	560	610	520	560	610	660	610	640	690	750	620	660	710	790
P6	165	175	190	205	180	190	205	225	205	220	235	260	215	225	245	265
	540	570	620	670	590	620	670	740	670	720	770	850	710	740	800	870
P7	155	165	180	195	170	180	195	215	195	205	220	245	200	215	230	250
	510	540	590	640	560	590	640	710	640	670	720	800	660	710	750	820
P8	145	155	165	180	160	170	180	200	180	190	205	225	185	200	215	235
	475	510	540	590	520	560	590	660	590	620	670	740	610	660	710	770
P11	150	160	175	190	165	175	190	210	190	200	215	235	195	205	225	245
	490	520	570	620	540	570	620	690	620	660	710	770	640	670	740	800
P12	100	105	115	125	110	115	125	140	125	130	140	155	125	135	145	160
	330	345	375	410	360	375	410	460	410	425	460	510	410	445	475	520
M1	160	165	180	200	175	185	200	220	185	195	210	230	180	195	210	230
	520	540	590	660	570	610	660	720	610	640	690	750	590	640	690	750
M2	130	140	150	165	145	155	165	180	155	160	175	190	150	160	175	190
	425	460	490	540	475	510	540	590	510	520	570	620	490	520	570	620
M3	105	115	120	135	115	125	135	150	125	130	140	155	125	130	140	155
	345	375	395	445	375	410	445	490	410	425	460	510	410	425	460	510
M4	80	85	95	105	90	95	105	115	95	100	110	120	95	100	110	120
	260	280	310	345	295	310	345	375	310	330	360	395	310	330	360	395
M5	70	70	80	85	75	80	85	95	80	85	90	100	80	85	90	100
	230	230	260	280	245	260	280	310	260	280	295	330	260	280	295	330
K1	155	165	175	195	—	—	—	—	195	205	220	245	—	—	—	—
	510	540	570	640	—	—	—	—	640	670	720	800	—	—	—	—
K2	140	150	160	175	—	—	—	—	175	185	200	220	—	—	—	—
	460	490	520	570	—	—	—	—	570	610	660	720	—	—	—	—
K3	120	125	135	150	—	—	—	—	145	155	170	185	—	—	—	—
	395	410	445	490	—	—	—	—	475	510	560	610	—	—	—	—
K4	110	120	130	140	—	—	—	—	140	150	160	175	—	—	—	—
	360	395	425	460	—	—	—	—	460	490	520	570	—	—	—	—
K5	70	70	80	85	—	—	—	—	85	90	95	110	—	—	—	—
	230	230	260	280	—	—	—	—	280	295	310	360	—	—	—	—
K6	100	105	115	125	—	—	—	—	125	130	140	155	—	—	—	—
	330	345	375	410	—	—	—	—	410	425	460	510	—	—	—	—
K7	85	90	100	110	—	—	—	—	110	115	125	140	—	—	—	—
	280	295	330	360	—	—	—	—	360	375	410	460	—	—	—	—
S1	38	40	44	48	42	44	48	55	44	47	50	55	46	49	55	60
	125	130	145	155	140	145	155	180	145	155	165	180	150	160	180	195
S2	31	33	35	39	34	36	39	43	36	38	41	45	37	39	42	47
	100	110	115	130	110	120	130	140	120	125	135	150	120	130	140	155
S3	27	29	31	34	30	32	34	38	31	33	36	40	33	35	37	41
	90	95	100	110	100	105	110	125	100	110	120	130	110	115	120	135
S11	55	55	60	65	60	65	70	75	60	65	70	80	65	70	75	80
	180	180	195	215	195	215	230	245	195	215	230	260	215	230	245	260
S12	37	40	43	46	41	44	47	50	43	46	49	55	45	48	50	55
	120	130	140	150	135	145	155	165	140	150	160	180	150	155	165	180
S13	21	23	25	27	24	25	27	30	25	26	28	32	26	27	30	33
	70	75	80	90	80	80	90	100	80	85	90	105	85	90	100	110
H5	33	35	37	42	—	—	—	—	38	41	44	49	—	—	—	—
	110	115	120	140	—	—	—	—	125	135	145	160	—	—	—	—
H8	35	37	40	44	—	—	—	—	41	43	47	50	—	—	—	—
	115	120	130	145	—	—	—	—	135	140	155	165	—	—	—	—
H11	42	44	48	55	—	—	—	—	49	50	55	60	49	50	55	60
	140	145	155	180	—	—	—	—	160	165	180	195	160	165	180	195
H12	60	65	70	80	—	—	—	—	80	85	90	100	80	85	95	100
	195	215	230	260	—	—	—	—	260	280	295	330	260	280	310	330
H21	35	37	40	44	—	—	—	—	41	43	47	50	—	—	—	—
	115	120	130	145	—	—	—	—	135	140	155	165	—	—	—	—

Double Quattro R220.54-22 – Metric

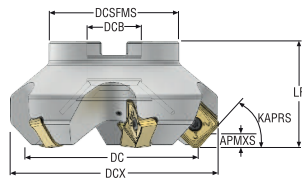

- For insert selection and cutting data recommendations, see page(s) 245-250
- For complete insert programme, see page(s) 857
- For ISO attribute explanation, see page 16

Designation	Item number	Type of mounting	DC	ZEFP	APMXS	KAPRS°	DCX	DCB	DCSFMS	LF	RPMX	Weight	Insert
			mm		mm		mm	mm	mm	mm		kg	
R220.54-0080-22-5A	03156810	Arbor	80,0	5	9,0	48,0	104,0	27,0	62,0	63,0	4600	1,6	SNMX2209AN
R220.54-0080-22-6A	03157469	Arbor	80,0	6	9,0	48,0	104,0	27,0	62,0	63,0	4600	1,5	SNMX2209AN
R220.54-0100-22-5A	03156811	Arbor	100,0	5	9,0	48,0	124,0	32,0	77,0	63,0	4000	2,3	SNMX2209AN
R220.54-0100-22-7A	03157470	Arbor	100,0	7	9,0	48,0	124,0	32,0	77,0	63,0	4000	2,2	SNMX2209AN
R220.54-0125-22-6A	03156812	Arbor	125,0	6	9,0	48,0	149,0	40,0	90,0	63,0	3700	3,2	SNMX2209AN
R220.54-0125-22-8A	03157471	Arbor	125,0	8	9,0	48,0	149,0	40,0	90,0	63,0	3700	3,2	SNMX2209AN
R220.54-8160-22-8A	03156813	Arbor	160,0	8	9,0	48,0	184,0	40,0	90,0	63,0	3300	5,7	SNMX2209AN
R220.54-8160-22-11A	03157472	Arbor	160,0	11	9,0	48,0	184,0	40,0	90,0	63,0	3300	5,7	SNMX2209AN

Spare Parts, included in delivery

For cutter	Insert key	Insert screw	Lid	Lid screw
R220.54-0080-0125	H6B-T20P	C05013-T20P	-	-
R220.54-0080-0125	H6B-T20PL	C05013-T20P	-	-
R220.54-8160	H6B-T20PL	C05013-T20P	SC-160-90	MF6S4X10

Accessories

For cutter	Arbor screw	Insert clamping torque	Torque key
R220.54-0080-0125	-	5.0NM	T00-20P50
R220.54-8160	MC6S12X40	5.0NM	T00-20P50

Torque and fixed keys, see page 894



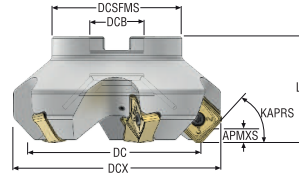
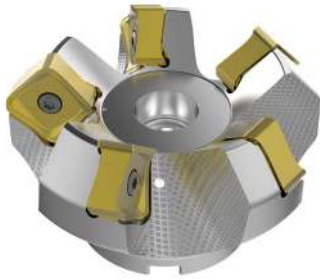

Double Quattro R220.54-22 – inch



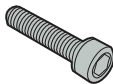
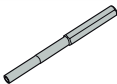

- For insert selection and cutting data recommendations, see page(s) 245-250
- For complete insert programme, see page(s) 857
- For ISO attribute explanation, see page 16

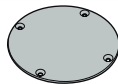
Designation	Item number	Type of mounting	DC	ZEFP	APMXS	KAPRS°	DCX	DCB	DCSFMS	LF	RPMX	Weight	Insert
			inch		inch		inch	inch	inch	inch		lbs	
R220.54-03.00-22-5A	03157473	Arbor	3.150	5	0.354	48.0	4.094	1.000	2.441	2.480	4600	3.750	SNMX2209AN
R220.54-03.00-22-6A	03157477	Arbor	3.150	6	0.354	48.0	4.094	1.000	2.441	2.480	4600	3.750	SNMX2209AN
R220.54-04.00-22-5A	03157474	Arbor	3.937	5	0.354	48.0	4.882	1.500	3.543	2.480	4000	5.730	SNMX2209AN
R220.54-04.00-22-7A	03157479	Arbor	3.937	7	0.354	48.0	4.882	1.500	3.543	2.480	4000	5.510	SNMX2209AN
R220.54-05.00-22-6A	03157475	Arbor	4.921	6	0.354	48.0	5.866	1.500	3.543	2.480	3700	7.500	SNMX2209AN
R220.54-05.00-22-8A	03157480	Arbor	4.921	8	0.354	48.0	5.866	1.500	3.543	2.480	3700	7.500	SNMX2209AN
R220.54-06.00-22-8A	03157476	Arbor	6.299	8	0.354	48.0	7.244	2.000	4.331	2.480	3300	13.010	SNMX2209AN
R220.54-06.00-22-11A	03157481	Arbor	6.299	11	0.354	48.0	7.244	2.000	4.331	2.480	3300	13.010	SNMX2209AN

Spare Parts, included in delivery

For cutter	Arbor screw	Insert key	Insert screw	Lid	Lid screw
R220.54-03.00					
R220.54-03.00	UC6S1/2UNFX1-1/4	H6B-T20P	C05013-T20P	-	-
R220.54-04.00	UC6S3/4UNFX1-1/4	H6B-T20PL	C05013-T20P	-	-
R220.54-05.00	UC6S3/4UNFX1-1/4	H6B-T20PL	C05013-T20P	-	-
R220.54-06.00	-	H6B-T20PL	C05013-T20P	SC-160-90	MF6S4X10

Accessories

For cutter	Arbor screw	Insert clamping torque	Torque key
R220.54-03.00-05.00			
R220.54-03.00-05.00	-	44.3IN.LBS	T00-20P50
R220.54-06.00	58215080	44.3IN.LBS	T00-20P50

Torque and fixed keys, see page 894



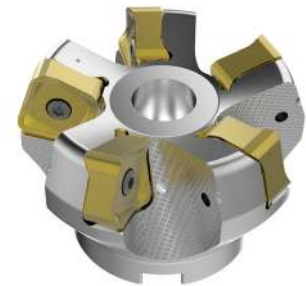
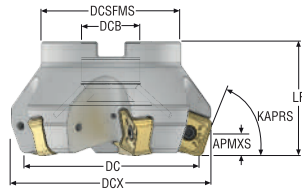

Double Quattro R220.56-22 – Metric

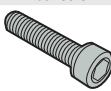
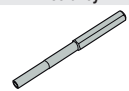

- For insert selection and cutting data recommendations, see page(s) 245-250
- For complete insert programme, see page(s) 857
- For ISO attribute explanation, see page 16

Designation	Item number	Type of mounting	DC	ZEFP	APMXS	KAPRS°	DCX	DCB	DCSFMS	LF	RPMX	Weight	Insert
			mm		mm		mm	mm	mm	mm		kg	
R220.56-0080-22-5A	03157447	Arbor	80,0	5	13,0	71,0	91,5	27,0	62,0	63,0	4600	1,4	SN.X2209ZN
R220.56-0100-22-5A	03156816	Arbor	100,0	5	13,0	71,0	111,5	32,0	77,0	63,0	4000	2,0	SN.X2209ZN
R220.56-0100-22-7A	03157448	Arbor	100,0	7	13,0	71,0	111,5	32,0	77,0	63,0	4000	1,9	SN.X2209ZN
R220.56-0125-22-6A	03156817	Arbor	125,0	6	13,0	71,0	136,5	40,0	90,0	63,0	3700	2,9	SN.X2209ZN
R220.56-0125-22-8A	03157449	Arbor	125,0	8	13,0	71,0	136,5	40,0	90,0	63,0	3700	2,9	SN.X2209ZN
R220.56-8160-22-8A	03156818	Arbor	160,0	8	13,0	71,0	171,5	40,0	90,0	63,0	3300	5,0	SN.X2209ZN
R220.56-8160-22-10A	03157450	Arbor	160,0	10	13,0	71,0	171,5	40,0	90,0	63,0	3300	4,9	SN.X2209ZN

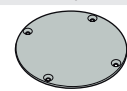
Spare Parts, included in delivery

For cutter	Arbor screw	Insert key	Insert screw	Lid	Lid screw
R220.56-0080	 MC6S12X35	 H6B-T20P	 C05013-T20P	 -	 -
R220.56-0100-0125	-	H6B-T20PL	C05013-T20P	-	-
R220.56-8160	-	H6B-T20PL	C05013-T20P	SC-160-90	MF6S4X10

Accessories

For cutter	Arbor screw	Insert clamping torque	Torque key
R220.56-0080-0125	-	5.0NM	T00-20P50
R220.56-8160	MC6S12X40	5.0NM	T00-20P50

Torque and fixed keys, see page 894

Square shoulder and slot milling cutters
Helical milling cutters
Face milling cutters
Disc milling cutters
High feed milling cutters
Copy milling cutters
Plunge milling cutters
Chamfer milling cutters
Spot facing cutters
Inserts

Double Quattro R220.56-22 – inch

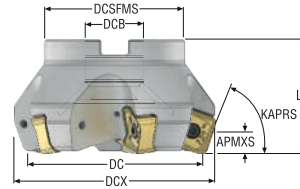
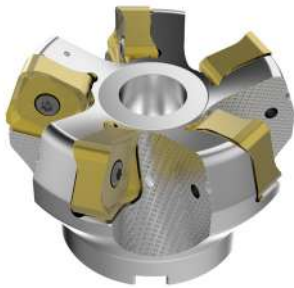

- For insert selection and cutting data recommendations, see page(s) 245-250
- For complete insert programme, see page(s) 857
- For ISO attribute explanation, see page 16

Designation	Item number	Type of mounting	DC	ZEFP	APMXS	KAPRS°	DCX	DCB	DCSFMS	LF	RPMX	Weight	Insert
			inch		inch		inch	inch	inch	inch		lbs	
R220.56-03.00-22-5A	03157454	Arbor	3.150	5	0.512	71.0	3.602	1.000	2.441	2.480	4600	3.090	SN.X2209ZN
R220.56-04.00-22-5A	03157451	Arbor	3.937	5	0.512	71.0	4.390	1.500	3.031	2.480	4000	4.630	SN.X2209ZN
R220.56-04.00-22-7A	03157455	Arbor	3.937	7	0.512	71.0	4.390	1.500	3.031	2.480	4000	4.410	SN.X2209ZN
R220.56-05.00-22-6A	03157452	Arbor	4.921	6	0.512	71.0	5.374	1.500	3.543	2.480	3700	7.050	SN.X2209ZN
R220.56-05.00-22-8A	03157456	Arbor	4.921	8	0.512	71.0	5.374	1.500	3.543	2.480	3700	7.050	SN.X2209ZN
R220.56-06.00-22-8A	03157453	Arbor	6.299	8	0.512	71.0	6.752	2.000	4.331	2.480	3300	10.800	SN.X2209ZN
R220.56-06.00-22-10A	03157457	Arbor	6.299	10	0.512	71.0	6.752	2.000	4.331	2.480	3300	10.360	SN.X2209ZN

Spare Parts, included in delivery

For cutter	Arbor screw	Insert key	Insert screw	Lid	Lid screw
R220.56-03.00	UC6S1/2UNFX1-1/4	H6B-T20P	C05013-T20P	-	-
R220.56-04.00	UC6S3/4UNFX1-1/4	H6B-T20PL	C05013-T20P	-	-
R220.56-05.00	UC6S3/4UNFX1-1/4	H6B-T20PL	C05013-T20P	-	-
R220.56-06.00	-	H6B-T20PL	C05013-T20P	SC-160-90	MF6S4X10

Accessories

For cutter	Arbor screw	Insert clamping torque	Torque key
R220.56-03.00-05.00	-	44.3IN.LBS	T00-20P50
R220.56-06.00	58215080	44.3IN.LBS	T00-20P50

Torque and fixed keys, see page 894

Double Quattro R220.54/56-22CS – Metric

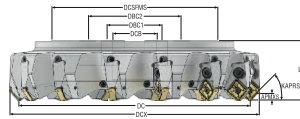

- For insert selection and cutting data recommendations, see page(s) 245-250
- For complete insert programme, see page(s) 857
- For ISO attribute explanation, see page 16

Designation	Item number	Type of mounting	DC	ZEFP	APMXS	KAPRS°	DCX	BD	DCB	DCSFMS	LF	RPMX	Weight	Insert
			mm		mm		mm	mm	mm	mm	mm		kg	
R220.54-8200-22-9CS	03167768	Arbor	200,0	9	9,0	48,0	224,0	–	60,0	130,0	80,0	2700	9,9	SN.X2209AN
R220.54-8250-22-11CS	03167769	Arbor	250,0	11	9,0	48,0	274,0	–	60,0	130,0	80,0	2500	17,9	SN.X2209AN
R220.54-8315-22-14CS	03167770	Arbor	315,0	14	9,0	48,0	339,0	–	60,0	225,0	80,0	2200	33,5	SN.X2209AN
R220.56-8200-22-9CS	03167771	Arbor	200,0	9	13,0	71,0	211,5	222,5	60,0	130,0	80,0	2700	9,9	SN.X2209ZN
R220.56-8250-22-11CS	03167772	Arbor	250,0	11	13,0	71,0	261,5	272,5	60,0	130,0	80,0	2500	18,0	SN.X2209ZN
R220.56-8315-22-14CS	03167773	Arbor	315,0	14	13,0	71,0	326,5	337,5	60,0	225,0	80,0	2200	29,2	SN.X2209ZN

Spare Parts, included in delivery

For cutter	Adjustment unit	Cassette	Cassette screw	Insert key	Insert screw	Lid	Lid screw	Wedge clamp	Wedge screw
R220.54-8200	AU1114T-T15P	SN22AR	MC6S8X30	H6B-T20PL	C05013-T20P	SC-200-90	MF6S4X10	CW0810	LD8018-T25P
R220.54-8250	AU1114T-T15P	SN22AR	MC6S8X30	H6B-T20PL	C05013-T20P	SC-250-90	MF6S4X10	CW0810	LD8020-T25P
R220.54-8315	AU1114T-T15P	SN22AR	MC6S8X30	H6B-T20PL	C05013-T20P	SC-315-90	MF6S4X10	CW0810	LD8020-T25P
R220.56-8200	AU1114T-T15P	SN22ZR	MC6S8X30	H6B-T20PL	C05013-T20P	SC-200-90	MF6S4X10	CW0810	LD8018-T25P
R220.56-8250	AU1114T-T15P	SN22ZR	MC6S8X30	H6B-T20PL	C05013-T20P	SC-250-90	MF6S4X10	CW0810	LD8020-T25P
R220.56-8315	AU1114T-T15P	SN22ZR	MC6S8X30	H6B-T20PL	C05013-T20P	SC-315-90	MF6S4X10	CW0810	LD8020-T25P

Accessories

For cutter	Arbor screw	Arbor screw 2	Insert clamping torque	Torque key
R220.54/56-8200-8250	MC6S16X50	–	5.0NM	T00-20P50
R220.54/56-8315	MC6S16X50	MC6S20X50	5.0NM	T00-20P50

Torque and fixed keys, see page 894

Double Quattro R220.54/56-22C – inch

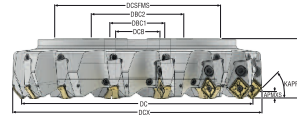

- For insert selection and cutting data recommendations, see page(s) 245-250
- For complete insert programme, see page(s) 857
- For ISO attribute explanation, see page 16

Designation	Item number	Type of mounting	DC	ZEPF	APMXS	KAPRS°	DCX	BD	DCB	DCSFMS	LF	RPMX	Weight	Insert
			inch		inch		inch	inch	inch	inch	inch		lbs	
R220.54-808.00-22-9C	03167774	Arbor	7.874	9	0.354	48,0	8.819	–	2.500	5.118	3.150	2700	23.150	SN.X2209AN
R220.54-810.00-22-11C	03167775	Arbor	9.843	11	0.354	48,0	10.787	–	2.500	5.118	3.150	2500	50.040	SN.X2209AN
R220.54-812.50-22-14C	03167776	Arbor	12.402	14	0.354	48,0	13.346	–	2.500	8.858	3.150	2200	80.250	SN.X2209AN
R220.56-808.00-22-9C	03167777	Arbor	7.874	9	0.512	71,0	8.335	8.760	2.500	5.118	3.150	2700	23.150	SN.X2209ZN
R220.56-810.00-22-11C	03167778	Arbor	9.843	11	0.512	71,0	10.307	10.728	2.500	5.118	3.150	2500	39.460	SN.X2209ZN
R220.56-812.50-22-14C	03167779	Arbor	12.402	14	0.512	71,0	12.866	13.287	2.500	8.858	3.150	2200	64.370	SN.X2209ZN

Spare Parts, included in delivery

For cutter	Adjustment unit	Cassette	Cassette screw	Insert screw	Lid	Lid screw	Wedge clamp	Wedge screw
R220.54-808.00	AU1114T-T15P	SN22AR	MC6S8X30	C05013-T20P	SC-200-90	MF6S4X10	CW0810	LD8018-T25P
R220.54-810.00	AU1114T-T15P	SN22AR	MC6S8X30	C05013-T20P	SC-250-90	MF6S4X10	CW0810	LD8020-T25P
R220.54-812.50	AU1114T-T15P	SN22AR	MC6S8X30	C05013-T20P	SC-315-90	MF6S4X10	CW0810	LD8020-T25P
R220.56-808.00	AU1114T-T15P	SN22ZR	MC6S8X30	C05013-T20P	SC-200-90	MF6S4X10	CW0810	LD8018-T25P
R220.56-810.00	AU1114T-T15P	SN22ZR	MC6S8X30	C05013-T20P	SC-250-90	MF6S4X10	CW0810	LD8020-T25P
R220.56-812.50	AU1114T-T15P	SN22ZR	MC6S8X30	C05013-T20P	SC-315-90	MF6S4X10	CW0810	LD8020-T25P

Accessories

For cutter	Arbor screw	Insert clamping torque	Torque key
R220.54/56-808.00-810.00	–	44.3IN.LBS	T00-20P50
R220.54/56-812.50	950DNC062225	44.3IN.LBS	T00-20P50

Torque and fixed keys, see page 894

R220.54-22 – Insert selection – mm/Inch

SMG		a _p	f _z			
			80%	60%	40%	20%
P1	SNMX2209ANTR-M12 T350M	7,0	0,30	0,30	0,30	0,38
		0,28	0,012	0,012	0,012	0,015
P2	SNMX2209ANTR-M12 T350M	7,0	0,30	0,30	0,32	0,38
		0,28	0,012	0,012	0,013	0,015
P3	SNMX2209ANTR-M18 MP2501	7,0	0,42	0,42	0,44	0,55
		0,28	0,017	0,017	0,017	0,022
P4	SNMX2209ANTR-M18 MP2501	7,0	0,42	0,42	0,44	0,55
		0,28	0,017	0,017	0,017	0,022
P5	SNMX2209ANTR-M18 MP2501	7,0	0,40	0,40	0,42	0,55
		0,28	0,016	0,016	0,017	0,022
P6	SNMX2209ANTR-M18 MP2501	7,0	0,40	0,40	0,42	0,50
		0,28	0,016	0,016	0,017	0,020
P7	SNMX2209ANTR-M12 T350M	7,0	0,28	0,28	0,28	0,34
		0,28	0,011	0,011	0,011	0,013
P8	SNMX2209ANTR-M12 T350M	7,0	0,28	0,28	0,30	0,36
		0,28	0,011	0,011	0,012	0,014
P11	SNMX2209ANTR-M12 MP2050	7,0	0,28	0,28	0,28	0,34
		0,28	0,011	0,011	0,011	0,013
P12	SNMX2209ANTR-M12 MP2050	6,0	0,19	0,19	0,19	0,24
		0,24	0,0075	0,0075	0,0075	0,0095
M1	SNMX2209ANTR-ME12 F40M	7,0	0,28	0,28	0,28	0,36
		0,28	0,011	0,011	0,011	0,014
M2	SNMX2209ANTR-ME12 F40M	7,0	0,25	0,25	0,26	0,32
		0,28	0,010	0,010	0,010	0,013
M3	SNMX2209ANTR-M12 MS2050	6,0	0,22	0,22	0,22	0,28
		0,24	0,0085	0,0085	0,0085	0,011
M4	SNMX2209ANTR-M12 MP2050	4,5	0,20	0,20	0,20	0,26
		0,18	0,0080	0,0080	0,0080	0,010
M5	SNMX2209ANTR-M12 MP2050	4,5	0,20	0,20	0,20	0,26
		0,18	0,0080	0,0080	0,0080	0,010
K1	SNMX2209ANTR-M18 MK1500	7,0	0,46	0,46	0,46	0,60
		0,28	0,018	0,018	0,018	0,024
K2	SNMX2209ANTR-M18 MK1500	7,0	0,40	0,40	0,42	0,55
		0,28	0,016	0,016	0,017	0,022
K3	SNMX2209ANTR-M18 MP1501	7,0	0,40	0,40	0,42	0,55
		0,28	0,016	0,016	0,017	0,022
K4	SNMX2209ANTR-M18 MP1501	7,0	0,40	0,40	0,42	0,55
		0,28	0,016	0,016	0,017	0,022
K5	SNMX2209ANTR-M18 MP1501	7,0	0,36	0,36	0,38	0,48
		0,28	0,014	0,014	0,015	0,019
K6	SNMX2209ANTR-M18 MK2050	7,0	0,40	0,40	0,42	0,55
		0,28	0,016	0,016	0,017	0,022
K7	SNMX2209ANTR-M18 MK2050	7,0	0,36	0,36	0,38	0,48
		0,28	0,014	0,014	0,015	0,019
S1	SNMX2209ANTR-M12 MS2050	4,5	0,20	0,20	0,20	0,26
		0,18	0,0080	0,0080	0,0080	0,010
S2	SNMX2209ANTR-M12 MS2050	4,5	0,20	0,20	0,20	0,26
		0,18	0,0080	0,0080	0,0080	0,010
S3	SNMX2209ANTR-M12 MS2050	4,5	0,19	0,19	0,19	0,24
		0,18	0,0075	0,0075	0,0075	0,0095
S11	SNMX2209ANTR-M12 MS2050	5,0	0,22	0,22	0,24	0,28
		0,20	0,0085	0,0085	0,0095	0,011
S12	SNMX2209ANTR-M12 MS2050	5,0	0,22	0,22	0,24	0,28
		0,20	0,0085	0,0085	0,0095	0,011
S13	SNMX2209ANTR-M12 MS2050	4,5	0,20	0,20	0,20	0,26
		0,18	0,0080	0,0080	0,0080	0,010
H5	SNMX2209ANTR-M18 MP1501	6,0	0,28	0,28	0,30	0,36
		0,24	0,011	0,011	0,012	0,014
H8	SNMX2209ANTR-M18 MP1501	5,0	0,22	0,22	0,22	0,28
		0,20	0,0085	0,0085	0,0085	0,011
H11	SNMX2209ANTR-M18 MP1501	6,0	0,28	0,28	0,30	0,36
		0,24	0,011	0,011	0,012	0,014
H12	SNMX2209ANTR-M18 MP1501	5,0	0,22	0,22	0,22	0,28
		0,20	0,0085	0,0085	0,0085	0,011
H21	SNMX2209ANTR-M18 MP1501	5,0	0,22	0,22	0,22	0,28
		0,20	0,0085	0,0085	0,0085	0,011

SMG = Seco material group
f_z = mm/tooth (in/tooth), v_c = m/min (sf/min), a_p/DC = %
All cutting data are start values

Square shoulder and slot milling cutters
Helical milling cutters
Face milling cutters
Disc milling cutters
High feed milling cutters
Copy milling cutters
Plunge milling cutters
Chamfer milling cutters
Spot facing cutters
Inserts

R220.54-22 – Cutting data $v_c = (m/min)/(sf/min)$

SMG	MK1500				MP1501				MP2501				T350M			
	100%	80%	60%	40%	100%	80%	60%	40%	100%	80%	60%	40%	100%	80%	60%	40%
P1	—	—	—	—	245	255	280	310	215	230	245	275	190	200	215	240
	—	—	—	—	800	840	920	1025	710	750	800	900	620	660	710	790
P2	—	—	—	—	235	245	265	300	205	220	235	265	180	190	205	230
	—	—	—	—	770	800	870	980	670	720	770	870	590	620	670	750
P3	—	—	—	—	205	220	240	265	185	195	210	235	160	170	185	205
	—	—	—	—	670	720	790	870	610	640	690	770	520	560	610	670
P4	—	—	—	—	185	195	210	235	160	170	185	210	140	150	160	180
	—	—	—	—	610	640	690	770	520	560	610	690	460	490	520	590
P5	—	—	—	—	175	185	205	225	155	165	180	200	135	145	155	175
	—	—	—	—	570	610	670	740	510	540	590	660	445	475	510	570
P6	—	—	—	—	200	210	230	250	175	185	200	225	155	160	175	195
	—	—	—	—	660	690	750	820	570	610	660	740	510	520	570	640
P7	—	—	—	—	190	200	215	240	165	175	190	210	145	155	165	185
	—	—	—	—	620	660	710	790	540	570	620	690	475	510	540	610
P8	—	—	—	—	175	185	200	220	155	165	175	195	135	140	155	170
	—	—	—	—	570	610	660	720	510	540	570	640	445	460	510	560
P11	—	—	—	—	180	195	210	230	160	170	185	205	140	150	160	180
	—	—	—	—	590	640	690	750	520	560	610	670	460	490	520	590
P12	—	—	—	—	120	130	140	155	105	115	125	135	95	100	105	120
	—	—	—	—	395	425	460	510	345	375	410	445	310	330	345	395
M1	—	—	—	—	—	—	—	—	150	155	170	190	140	145	160	180
	—	—	—	—	—	—	—	—	490	510	560	620	460	475	520	590
M2	—	—	—	—	—	—	—	—	125	135	145	160	120	125	135	150
	—	—	—	—	—	—	—	—	410	445	475	520	395	410	445	490
M3	—	—	—	—	—	—	—	—	105	110	120	130	95	100	110	120
	—	—	—	—	—	—	—	—	345	360	395	425	310	330	360	395
M4	—	—	—	—	—	—	—	—	80	85	90	100	75	80	85	95
	—	—	—	—	—	—	—	—	260	280	295	330	245	260	280	310
M5	—	—	—	—	—	—	—	—	65	70	75	85	60	65	70	80
	—	—	—	—	—	—	—	—	215	230	245	280	195	215	230	260
K1	230	245	265	300	185	195	210	240	165	175	190	210	145	150	165	185
	750	800	870	980	610	640	690	790	540	570	620	690	475	490	540	610
K2	210	225	240	270	170	180	195	215	150	160	170	190	130	135	150	165
	690	740	790	890	560	590	640	710	490	520	560	620	425	445	490	540
K3	180	190	205	225	140	150	165	180	125	135	145	160	110	115	125	140
	590	620	670	740	460	490	540	590	410	445	475	520	360	375	410	460
K4	170	180	195	215	135	145	155	170	120	125	140	155	105	110	120	135
	560	590	640	710	445	475	510	560	395	410	460	510	345	360	395	445
K5	105	110	120	135	85	90	95	105	75	80	85	95	65	70	75	80
	345	360	395	445	280	295	310	345	245	260	280	310	215	230	245	260
K6	150	160	170	190	120	125	135	150	105	110	120	135	90	100	105	115
	490	520	560	620	395	410	445	490	345	360	395	445	295	330	345	375
K7	135	140	155	170	105	115	125	135	95	100	110	120	85	90	95	105
	445	460	510	560	345	375	410	445	310	330	360	395	280	295	310	345
S1	—	—	—	—	—	—	—	—	39	41	44	50	35	37	40	44
	—	—	—	—	—	—	—	—	130	135	145	165	115	120	130	145
S2	—	—	—	—	—	—	—	—	31	33	36	40	28	30	32	36
	—	—	—	—	—	—	—	—	100	110	120	130	90	100	105	120
S3	—	—	—	—	—	—	—	—	28	29	31	35	25	26	28	31
	—	—	—	—	—	—	—	—	90	95	100	115	80	85	90	100
S11	—	—	—	—	—	—	—	—	55	55	60	70	48	50	55	60
	—	—	—	—	—	—	—	—	180	180	195	230	155	165	180	195
S12	—	—	—	—	—	—	—	—	37	39	43	48	33	35	38	43
	—	—	—	—	—	—	—	—	120	130	140	155	110	115	125	140
S13	—	—	—	—	—	—	—	—	22	23	25	28	20	21	22	25
	—	—	—	—	—	—	—	—	70	75	80	90	65	70	70	80
H5	—	—	—	—	40	43	46	50	32	34	37	41	31	33	35	40
	—	—	—	—	130	140	150	165	105	110	120	135	100	110	115	130
H8	—	—	—	—	43	46	49	55	35	37	40	44	33	35	38	43
	—	—	—	—	140	150	160	180	115	120	130	145	110	115	125	140
H11	—	—	—	—	50	55	60	65	41	44	47	55	39	42	45	50
	—	—	—	—	165	180	195	215	135	145	155	180	130	140	150	165
H12	—	—	—	—	80	80	90	100	70	75	80	90	60	65	70	75
	—	—	—	—	260	260	295	330	230	245	260	295	195	215	230	245
H21	—	—	—	—	43	46	49	55	35	37	40	44	33	35	38	43
	—	—	—	—	140	150	160	180	115	120	130	145	110	115	125	140

R220.54-22 – Cutting data $v_c = (m/min)/(sf/min)$

SMG	F40M				MS2050				MP2050				MK2050			
	100%	80%	60%	40%	100%	80%	60%	40%	100%	80%	60%	40%	100%	80%	60%	40%
P1	185	195	210	235	195	205	220	250	230	240	260	295	215	225	245	270
	610	640	690	770	640	670	720	820	750	790	850	970	710	740	800	890
P2	180	190	205	230	190	200	215	235	220	235	255	280	205	215	235	265
	590	620	670	750	620	660	710	770	720	770	840	920	670	710	770	870
P3	155	165	180	195	165	175	190	210	195	205	225	245	180	190	205	230
	510	540	590	640	540	570	620	690	640	670	740	800	590	620	670	750
P4	140	145	160	175	145	155	165	185	170	180	195	220	160	170	180	205
	460	475	520	570	475	510	540	610	560	590	640	720	520	560	590	670
P5	130	140	150	170	140	145	160	180	165	175	190	210	155	165	175	195
	425	460	490	560	460	475	520	590	540	570	620	690	510	540	570	640
P6	150	160	175	190	160	170	185	200	190	200	215	235	175	185	200	220
	490	520	570	620	520	560	610	660	620	660	710	770	570	610	660	720
P7	145	150	165	180	150	160	170	190	175	190	205	225	165	175	190	210
	475	490	540	590	490	520	560	620	570	620	670	740	540	570	620	690
P8	130	140	150	165	140	145	160	175	165	175	190	205	150	160	175	195
	425	460	490	540	460	475	520	570	540	570	620	670	490	520	570	640
P11	140	150	160	175	145	155	165	185	170	180	195	215	160	170	180	200
	460	490	520	570	475	510	540	610	560	590	640	710	520	560	590	660
P12	90	95	105	115	95	100	110	120	110	120	130	145	105	110	120	135
	295	310	345	375	310	330	360	395	360	395	425	475	345	360	395	445
M1	145	150	165	185	150	160	175	190	160	170	180	200	—	—	—	—
	475	490	540	610	490	520	570	620	520	560	590	660	—	—	—	—
M2	120	125	135	150	125	130	145	160	130	140	150	170	—	—	—	—
	395	410	445	490	410	425	475	520	425	460	490	560	—	—	—	—
M3	100	105	110	125	105	110	120	130	110	115	125	135	—	—	—	—
	330	345	360	410	345	360	395	425	360	375	410	445	—	—	—	—
M4	75	80	85	95	80	85	90	100	85	85	95	105	—	—	—	—
	245	260	280	310	260	280	295	330	280	280	310	345	—	—	—	—
M5	65	65	70	80	65	70	75	85	70	75	80	90	—	—	—	—
	215	215	230	260	215	230	245	280	230	245	260	295	—	—	—	—
K1	140	150	160	180	—	—	—	—	—	—	—	—	220	230	250	285
	460	490	520	590	—	—	—	—	—	—	—	—	720	750	820	940
K2	125	135	145	160	—	—	—	—	—	—	—	—	200	210	230	255
	410	445	475	520	—	—	—	—	—	—	—	—	660	690	750	840
K3	105	110	120	135	—	—	—	—	—	—	—	—	170	180	195	215
	345	360	395	445	—	—	—	—	—	—	—	—	560	590	640	710
K4	100	105	115	130	—	—	—	—	—	—	—	—	160	170	185	205
	330	345	375	425	—	—	—	—	—	—	—	—	520	560	610	670
K5	60	65	70	80	—	—	—	—	—	—	—	—	100	105	115	125
	195	215	230	260	—	—	—	—	—	—	—	—	330	345	375	410
K6	90	95	100	115	—	—	—	—	—	—	—	—	140	150	165	180
	295	310	330	375	—	—	—	—	—	—	—	—	460	490	540	590
K7	80	85	90	100	—	—	—	—	—	—	—	—	125	135	145	160
	260	280	295	330	—	—	—	—	—	—	—	—	410	445	475	520
S1	35	37	40	45	37	39	43	47	40	43	47	50	—	—	—	—
	115	120	130	150	120	130	140	155	130	140	155	165	—	—	—	—
S2	28	30	32	36	30	31	35	38	32	34	38	41	—	—	—	—
	90	100	105	120	100	100	115	125	105	110	125	135	—	—	—	—
S3	25	26	29	32	26	28	30	33	29	30	33	37	—	—	—	—
	80	85	95	105	85	90	100	110	95	100	110	120	—	—	—	—
S11	49	50	55	65	50	55	60	65	55	60	65	70	—	—	—	—
	160	165	180	215	165	180	195	215	180	195	215	230	—	—	—	—
S12	34	36	39	44	36	38	41	46	39	42	45	50	—	—	—	—
	110	120	130	145	120	125	135	150	130	140	150	165	—	—	—	—
S13	20	21	23	25	21	22	24	26	23	24	27	29	—	—	—	—
	65	70	75	80	70	70	80	85	75	80	90	95	—	—	—	—
H5	30	32	34	38	—	—	—	—	—	—	—	—	—	—	—	—
	100	105	110	125	—	—	—	—	—	—	—	—	—	—	—	—
H8	32	34	37	41	—	—	—	—	—	—	—	—	—	—	—	—
	105	110	120	135	—	—	—	—	—	—	—	—	—	—	—	—
H11	38	41	44	49	—	—	—	—	43	45	49	55	—	—	—	—
	125	135	145	160	—	—	—	—	140	150	160	180	—	—	—	—
H12	60	60	65	75	—	—	—	—	70	75	85	90	—	—	—	—
	195	195	215	245	—	—	—	—	230	245	280	295	—	—	—	—
H21	32	34	37	41	—	—	—	—	—	—	—	—	—	—	—	—
	105	110	120	135	—	—	—	—	—	—	—	—	—	—	—	—

Square shoulder and slot milling cutters
Helical milling cutters
Face milling cutters
Disc milling cutters
High feed milling cutters
Copy milling cutters
Plunge milling cutters
Chamfer milling cutters
Spot facing cutters
Inserts

R220.56-22 – Insert selection – mm/Inch

SMG		a _p	f _z			
			80%	60%	40%	20%
P1	SNMX2209ZNTR-M12 MP2501	10,0	0,22	0,22	0,22	0,28
		0,40	0,0085	0,0085	0,0085	0,011
P2	SNMX2209ZNTR-M12 MP2501	10,0	0,22	0,22	0,24	0,28
		0,40	0,0085	0,0085	0,0095	0,011
P3	SNMX2209ZNTR-M18 MP2501	10,0	0,32	0,32	0,34	0,40
		0,40	0,013	0,013	0,013	0,016
P4	SNMX2209ZNTR-M18 MP2501	10,0	0,32	0,32	0,32	0,40
		0,40	0,013	0,013	0,013	0,016
P5	SNMX2209ZNTR-M18 MP2501	10,0	0,30	0,30	0,32	0,40
		0,40	0,012	0,012	0,013	0,016
P6	SNMX2209ZNTR-M18 MP2501	10,0	0,30	0,30	0,32	0,38
		0,40	0,012	0,012	0,013	0,015
P7	SNMX2209ZNTR-M18 T350M	10,0	0,30	0,30	0,32	0,38
		0,40	0,012	0,012	0,013	0,015
P8	SNMX2209ZNTR-M18 T350M	10,0	0,32	0,32	0,34	0,40
		0,40	0,013	0,013	0,013	0,016
P11	SNMX2209ZNTR-M12 MP2050	10,0	0,20	0,20	0,20	0,26
		0,40	0,0080	0,0080	0,0080	0,010
P12	SNMX2209ZNTR-M12 MP2050	8,0	0,14	0,14	0,15	0,18
		0,32	0,0055	0,0055	0,0060	0,0070
M1	SNMX2209ZNTR-M12 MS2050	10,0	0,22	0,22	0,24	0,28
		0,40	0,0085	0,0085	0,0095	0,011
M2	SNMX2209ZNTR-M12 MS2050	10,0	0,20	0,20	0,22	0,26
		0,40	0,0080	0,0080	0,0085	0,010
M3	SNMX2209ZNTR-M12 MS2050	8,0	0,17	0,17	0,17	0,22
		0,32	0,0065	0,0065	0,0065	0,0085
M4	SNMX2209ZNTR-M12 MP2050	6,0	0,15	0,15	0,16	0,19
		0,24	0,0060	0,0060	0,0065	0,0075
M5	SNMX2209ZNTR-M12 MP2050	6,0	0,15	0,15	0,16	0,19
		0,24	0,0060	0,0060	0,0065	0,0075
K1	SNMX2209ZNTR-M18 MK1500	10,0	0,34	0,34	0,34	0,44
		0,40	0,013	0,013	0,013	0,017
K2	SNMX2209ZNTR-M18 MK1500	10,0	0,30	0,30	0,32	0,40
		0,40	0,012	0,012	0,013	0,016
K3	SNMX2209ZNTR-M18 MP1501	10,0	0,30	0,30	0,32	0,40
		0,40	0,012	0,012	0,013	0,016
K4	SNMX2209ZNTR-M18 MP1501	10,0	0,30	0,30	0,32	0,40
		0,40	0,012	0,012	0,013	0,016
K5	SNMX2209ZNTR-M18 MP1501	10,0	0,28	0,28	0,28	0,36
		0,40	0,011	0,011	0,011	0,014
K6	SNMX2209ZNTR-M18 MK2050	10,0	0,30	0,30	0,32	0,40
		0,40	0,012	0,012	0,013	0,016
K7	SNMX2209ZNTR-M18 MK2050	10,0	0,28	0,28	0,28	0,36
		0,40	0,011	0,011	0,011	0,014
S1	SNMX2209ZNTR-M12 MS2050	6,0	0,15	0,15	0,16	0,19
		0,24	0,0060	0,0060	0,0065	0,0075
S2	SNMX2209ZNTR-M12 MS2050	6,0	0,15	0,15	0,16	0,19
		0,24	0,0060	0,0060	0,0065	0,0075
S3	SNMX2209ZNTR-M12 MS2050	6,0	0,14	0,14	0,14	0,18
		0,24	0,0055	0,0055	0,0055	0,0070
S11	SNMX2209ZNTR-M12 MS2050	7,0	0,17	0,17	0,18	0,22
		0,28	0,0065	0,0065	0,0065	0,0085
S12	SNMX2209ZNTR-M12 MS2050	7,0	0,17	0,17	0,18	0,22
		0,28	0,0065	0,0065	0,0065	0,0085
S13	SNMX2209ZNTR-M12 MS2050	6,0	0,15	0,15	0,16	0,19
		0,24	0,0060	0,0060	0,0065	0,0075
H5	SNMX2209ZNTR-M18 MP1501	8,0	0,22	0,22	0,22	0,28
		0,32	0,0085	0,0085	0,0085	0,011
H8	SNMX2209ZNTR-M18 MP1501	7,0	0,17	0,17	0,17	0,22
		0,28	0,0065	0,0065	0,0065	0,0080
H11	SNMX2209ZNTR-M18 MP1501	8,0	0,22	0,22	0,22	0,28
		0,32	0,0085	0,0085	0,0085	0,011
H12	SNMX2209ZNTR-M18 MP1501	7,0	0,17	0,17	0,17	0,22
		0,28	0,0065	0,0065	0,0065	0,0080
H21	SNMX2209ZNTR-M18 MP1501	7,0	0,17	0,17	0,17	0,22
		0,28	0,0065	0,0065	0,0065	0,0080

SMG = Seco material group
 f_z = mm/tooth (in/tooth), v_c = m/min (sf/min), a_p/DC = %
 All cutting data are start values

R220.56-22 – Cutting data $v_c = (m/min)/(sf/min)$

SMG	MK1500				MP1501				MP2501				T350M			
	100%	80%	60%	40%	100%	80%	60%	40%	100%	80%	60%	40%	100%	80%	60%	40%
P1	—	—	—	—	245	255	280	315	215	230	245	280	190	200	215	240
	—	—	—	—	800	840	920	1025	710	750	800	920	620	660	710	790
P2	—	—	—	—	240	250	270	305	210	220	240	270	185	195	210	235
	—	—	—	—	790	820	890	1000	690	720	790	890	610	640	690	770
P3	—	—	—	—	210	220	240	270	185	195	210	240	160	170	185	205
	—	—	—	—	690	720	790	890	610	640	690	790	520	560	610	670
P4	—	—	—	—	185	195	210	235	165	170	185	210	140	150	160	180
	—	—	—	—	610	640	690	770	540	560	610	690	460	490	520	590
P5	—	—	—	—	180	190	205	225	160	170	180	200	140	145	160	175
	—	—	—	—	590	620	670	740	520	560	590	660	460	475	520	570
P6	—	—	—	—	200	210	230	260	180	190	205	230	155	165	180	200
	—	—	—	—	660	690	750	850	590	620	670	750	510	540	590	660
P7	—	—	—	—	190	200	215	245	170	180	190	215	145	155	170	190
	—	—	—	—	620	660	710	800	560	590	620	710	475	510	560	620
P8	—	—	—	—	175	185	200	225	155	165	180	200	135	145	155	175
	—	—	—	—	570	610	660	740	510	540	590	660	445	475	510	570
P11	—	—	—	—	185	195	210	235	165	175	185	210	145	150	165	185
	—	—	—	—	610	640	690	770	540	570	610	690	475	490	540	610
P12	—	—	—	—	125	130	140	160	110	115	125	140	95	100	110	120
	—	—	—	—	410	425	460	520	360	375	410	460	310	330	360	395
M1	—	—	—	—	—	—	—	—	150	160	175	195	140	150	160	180
	—	—	—	—	—	—	—	—	490	520	570	640	460	490	520	590
M2	—	—	—	—	—	—	—	—	130	135	145	160	120	125	135	150
	—	—	—	—	—	—	—	—	425	445	475	520	395	410	445	490
M3	—	—	—	—	—	—	—	—	105	110	120	135	100	105	110	125
	—	—	—	—	—	—	—	—	345	360	395	445	330	345	360	410
M4	—	—	—	—	—	—	—	—	80	85	95	105	75	80	85	95
	—	—	—	—	—	—	—	—	260	280	310	345	245	260	280	310
M5	—	—	—	—	—	—	—	—	70	70	75	85	65	65	70	80
	—	—	—	—	—	—	—	—	230	230	245	280	215	215	230	260
K1	235	250	270	305	190	200	215	240	170	175	190	215	145	155	165	185
	770	820	890	1000	620	660	710	790	560	570	620	710	475	510	540	610
K2	215	225	245	270	170	180	195	215	150	160	170	190	130	140	150	165
	710	740	800	890	560	590	640	710	490	520	560	620	425	460	490	540
K3	180	190	205	225	145	150	165	180	130	135	145	160	110	115	125	140
	590	620	670	740	475	490	540	590	425	445	475	520	360	375	410	460
K4	175	180	195	215	140	145	155	175	120	130	140	155	105	110	120	135
	570	590	640	710	460	475	510	570	395	425	460	510	345	360	395	445
K5	105	110	120	135	85	90	95	105	75	80	85	95	65	70	75	85
	345	360	395	445	280	295	310	345	245	260	280	310	215	230	245	280
K6	155	160	175	190	120	130	140	150	110	115	125	135	95	100	105	120
	510	520	570	620	395	425	460	490	360	375	410	445	310	330	345	395
K7	135	140	155	175	110	115	120	140	95	100	110	120	85	85	95	105
	445	460	510	570	360	375	395	460	310	330	360	395	280	280	310	345
S1	—	—	—	—	—	—	—	—	40	42	45	50	36	38	40	45
	—	—	—	—	—	—	—	—	130	140	150	165	120	125	130	150
S2	—	—	—	—	—	—	—	—	32	34	36	41	29	30	33	36
	—	—	—	—	—	—	—	—	105	110	120	135	95	100	110	120
S3	—	—	—	—	—	—	—	—	29	30	32	36	26	27	29	32
	—	—	—	—	—	—	—	—	95	100	105	120	85	90	95	105
S11	—	—	—	—	—	—	—	—	55	60	65	70	50	55	55	60
	—	—	—	—	—	—	—	—	180	195	215	230	165	180	180	195
S12	—	—	—	—	—	—	—	—	39	41	44	48	35	36	39	43
	—	—	—	—	—	—	—	—	130	135	145	155	115	120	130	140
S13	—	—	—	—	—	—	—	—	22	24	25	28	20	21	23	25
	—	—	—	—	—	—	—	—	70	80	80	90	65	70	75	80
H5	—	—	—	—	41	44	47	55	33	35	38	42	32	34	36	41
	—	—	—	—	135	145	155	180	110	115	125	140	105	110	120	135
H8	—	—	—	—	45	48	50	55	36	38	41	45	35	37	39	43
	—	—	—	—	150	155	165	180	120	125	135	150	115	120	130	140
H11	—	—	—	—	55	55	60	65	42	45	48	55	41	43	46	50
	—	—	—	—	180	180	195	215	140	150	155	180	135	140	150	165
H12	—	—	—	—	80	85	90	100	70	75	80	90	60	65	70	80
	—	—	—	—	260	280	295	330	230	245	260	295	195	215	230	260
H21	—	—	—	—	45	48	50	55	36	38	41	45	35	37	39	43
	—	—	—	—	150	155	165	180	120	125	135	150	115	120	130	140

Square shoulder and slot milling cutters
Helical milling cutters
Face milling cutters
Disc milling cutters
High feed milling cutters
Copy milling cutters
Plunge milling cutters
Chamfer milling cutters
Spot facing cutters
Inserts

R220.56-22 – Cutting data $v_c = (m/min)/(sf/min)$

SMG	F40M				MS2050				MK2050			
	100%	80%	60%	40%	100%	80%	60%	40%	100%	80%	60%	40%
P1	180	190	205	225	200	210	225	250	215	225	245	275
	590	620	670	740	660	690	740	820	710	740	800	900
P2	175	185	200	220	190	200	215	245	210	220	235	265
	570	610	660	720	620	660	710	800	690	720	770	870
P3	150	160	170	195	165	175	190	210	185	190	210	235
	490	520	560	640	540	570	620	690	610	620	690	770
P4	135	140	155	170	150	155	170	185	160	170	185	205
	445	460	510	560	490	510	560	610	520	560	610	670
P5	130	135	145	165	140	150	160	180	155	165	180	195
	425	445	475	540	460	490	520	590	510	540	590	640
P6	145	150	165	185	160	170	180	205	175	185	200	225
	475	490	540	610	520	560	590	670	570	610	660	740
P7	135	145	155	175	150	160	170	190	165	175	190	215
	445	475	510	570	490	520	560	620	540	570	620	710
P8	125	135	145	160	140	145	160	180	155	160	175	195
	410	445	475	520	460	475	520	590	510	520	570	640
P11	135	140	150	170	145	155	165	185	160	170	185	205
	445	460	490	560	475	510	540	610	520	560	610	670
P12	90	95	100	110	100	105	110	120	110	115	125	140
	295	310	330	360	330	345	360	395	360	375	410	460
M1	140	145	160	180	155	160	175	195	—	—	—	—
	460	475	520	590	510	520	570	640	—	—	—	—
M2	115	120	130	150	130	135	145	165	—	—	—	—
	375	395	425	490	425	445	475	540	—	—	—	—
M3	95	100	110	120	105	110	120	130	—	—	—	—
	310	330	360	395	345	360	395	425	—	—	—	—
M4	75	80	85	95	80	85	95	105	—	—	—	—
	245	260	280	310	260	280	310	345	—	—	—	—
M5	60	65	70	80	70	70	80	85	—	—	—	—
	195	215	230	260	230	230	260	280	—	—	—	—
K1	135	145	155	175	—	—	—	—	225	235	255	290
	445	475	510	570	—	—	—	—	740	770	840	950
K2	120	130	140	155	—	—	—	—	205	215	230	255
	395	425	460	510	—	—	—	—	670	710	750	840
K3	105	110	120	130	—	—	—	—	170	180	195	215
	345	360	395	425	—	—	—	—	560	590	640	710
K4	100	105	115	125	—	—	—	—	165	170	185	205
	330	345	375	410	—	—	—	—	540	560	610	670
K5	60	65	70	75	—	—	—	—	100	105	115	130
	195	215	230	245	—	—	—	—	330	345	375	425
K6	85	90	100	110	—	—	—	—	145	150	165	180
	280	295	330	360	—	—	—	—	475	490	540	590
K7	75	80	90	100	—	—	—	—	130	135	145	165
	245	260	295	330	—	—	—	—	425	445	475	540
S1	35	37	40	44	38	41	43	48	—	—	—	—
	115	120	130	145	125	135	140	155	—	—	—	—
S2	28	30	32	35	31	33	35	39	—	—	—	—
	90	100	105	115	100	110	115	130	—	—	—	—
S3	25	26	28	31	27	29	31	34	—	—	—	—
	80	85	90	100	90	95	100	110	—	—	—	—
S11	48	50	55	60	55	55	60	65	—	—	—	—
	155	165	180	195	180	180	195	215	—	—	—	—
S12	33	35	38	42	36	38	42	46	—	—	—	—
	110	115	125	140	120	125	140	150	—	—	—	—
S13	20	21	22	25	22	23	24	27	—	—	—	—
	65	70	70	80	70	75	80	90	—	—	—	—
H5	30	31	34	37	—	—	—	—	—	—	—	—
	100	100	110	120	—	—	—	—	—	—	—	—
H8	32	33	36	40	—	—	—	—	—	—	—	—
	105	110	120	130	—	—	—	—	—	—	—	—
H11	38	40	43	47	—	—	—	—	—	—	—	—
	125	130	140	155	—	—	—	—	—	—	—	—
H12	55	60	65	70	—	—	—	—	—	—	—	—
	180	195	215	230	—	—	—	—	—	—	—	—
H21	32	33	36	40	—	—	—	—	—	—	—	—
	105	110	120	130	—	—	—	—	—	—	—	—



DOUBLE OCTOMILL 05/09

The Double Octomill face milling cutter is a highly versatile, economic and productive tool that can be used for both roughing and finishing.

- Insert size 05, cutter range 25-200mm (1.25-8 inch)
- Insert size 09, cutter range 63-500mm (2.5-12.5 inch)
- Double-sided inserts with 16 cutting edges

Double Octomill™ R217.48-05 – Metric

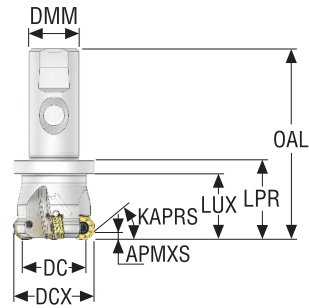

- For insert selection and cutting data recommendations, see page(s) 258 - 260
- For complete insert programme, see page(s) 838
- For ISO attribute explanation, see page 16

Designation	Item number	Type of mounting	DC	ZEFP	APMXS	KAPRS°	DCX	DMM	LUX	LPR	OAL	Weight	RPMX	Insert
			mm		mm		mm	mm	mm	mm	mm	kg		
R217.48-2025.3S-05-3SA	02810001	Seco-Weldon	25,0	3	3,0	40,0	33,0	20,0	33,0	40,0	90,0	0,3	20400	ON.U0504
R217.48-2532.3S-05-4SA	02810002	Seco-Weldon	32,0	4	3,0	40,0	40,0	25,0	33,0	40,0	90,0	0,5	18000	ON.U0504

Spare Parts, included in delivery

For cutter	Insert key	Insert screw
R217.48-..	H4B-T15P	C04009-T15P

Accessories

For cutter	Insert clamping torque	Torque key
R217.48-..	3.5NM	T00-15P35

Torque and fixed keys, see page 894

Square shoulder and slot milling cutters
Helical milling cutters
Face milling cutters
Disc milling cutters
High feed milling cutters
Copy milling cutters
Plunge milling cutters
Chamfer milling cutters
Spot facing cutters
Inserts

Double Octomill™ R217.48-05 – inch

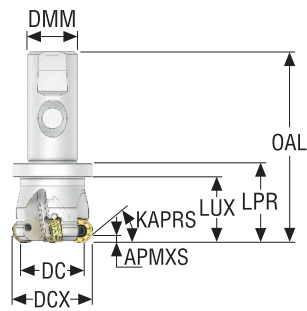

- For insert selection and cutting data recommendations, see page(s) 258 - 260
- For complete insert programme, see page(s) 838
- For ISO attribute explanation, see page 16

Designation	Item number	Type of mounting	DC	ZEFP	APMXS	KAPRS°	DCX	DMM	LUX	LPR	OAL	Weight	RPMX	Insert
			inch		inch		inch	inch	inch	inch	inch	lbs		
R217.48-01.25.3S-05-4SA	02810007	Seco-Weldon	1.250	4	0.118	40,0	1.575	0.750	1.299	1.575	3.543	1.100	20400	ON.U0504

Spare Parts, included in delivery

For cutter	Insert key	Insert screw
R217.48-..	H4B-T15P	C04009-T15P

Accessories

For cutter	Insert clamping torque	Torque key
R217.48-..	31.0IN.LBS	T00-15P35

Torque and fixed keys, see page 894

Square shoulder and slot milling cutters

Helical milling cutters

Face milling cutters

Disc milling cutters

High feed milling cutters

Copy milling cutters

Plunge milling cutters

Chamfer milling cutters

Spot facing cutters

Inserts

Double Octomill™ R220.48-05 – Metric

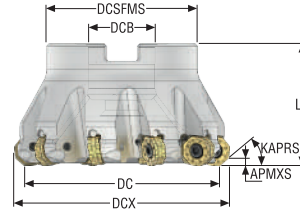

- For insert selection and cutting data recommendations, see page(s) 258 - 260
- For complete insert programme, see page(s) 838
- For ISO attribute explanation, see page 16

Designation	Item number	Type of mounting	DC	ZEFP	APMXS	KAPRS°	DCX	DCB	DCSFMS	LF	RPMX	Weight	Insert
			mm		mm		mm	mm	mm	mm		kg	
R220.48-0040-05-05SA	02810083	Arbor	40,0	5	3,0	40,0	48,35	16,0	35,0	40,0	16100	0,3	ON.U0504
R220.48-0050-05-04SA	02810003	Arbor	50,0	4	3,0	40,0	58,35	22,0	47,0	40,0	14400	0,4	ON.U0504
R220.48-0050-05-05SA	02810084	Arbor	50,0	5	3,0	40,0	58,35	22,0	47,0	40,0	14400	0,4	ON.U0504
R220.48-0050-05-06SA	02810085	Arbor	50,0	6	3,0	40,0	58,35	22,0	47,0	40,0	14400	0,4	ON.U0504
R220.48-0063-05-05SA	02810004	Arbor	63,0	5	3,0	40,0	71,35	22,0	47,0	40,0	12800	0,6	ON.U0504
R220.48-0063-05-06SA	02810086	Arbor	63,0	6	3,0	40,0	71,35	22,0	47,0	40,0	12800	0,6	ON.U0504
R220.48-0063-05-08SA	02810087	Arbor	63,0	8	3,0	40,0	71,35	22,0	47,0	40,0	12800	0,6	ON.U0504
R220.48-0080-05-06SA	02810005	Arbor	80,0	6	3,0	40,0	88,35	27,0	62,0	50,0	11400	1,2	ON.U0504
R220.48-0080-05-10SA	02810088	Arbor	80,0	10	3,0	40,0	88,35	27,0	62,0	50,0	11400	1,1	ON.U0504
R220.48-0100-05-07SA	02810089	Arbor	100,0	7	3,0	40,0	108,35	32,0	77,0	50,0	10200	1,8	ON.U0504
R220.48-0100-05-12SA	02810090	Arbor	100,0	12	3,0	40,0	108,35	32,0	77,0	50,0	10200	1,8	ON.U0504
R220.48-0125-05-08SA	02810091	Arbor	125,0	8	3,0	40,0	133,35	40,0	90,0	63,0	9100	3,4	ON.U0504
R220.48-0125-05-14SA	02810092	Arbor	125,0	14	3,0	40,0	133,35	40,0	90,0	63,0	9100	3,3	ON.U0504

Spare Parts, included in delivery

For cutter	Arbor screw	Insert key	Insert screw
R220.48-0040	TCEI0825	H4B-T15P	C04009-T15P
R220.48-0050-0063	220.17-692	H4B-T15P	C04009-T15P
R220.48-0080-0125	-	H4B-T15P	C04009-T15P
R220.48-0080-0125	-	H4B-T15PL	C04009-T15P

Accessories

For cutter	Insert clamping torque	Torque key
R220.48-..	3.5NM	T00-15P35

Torque and fixed keys, see page 894

Double Octomill™ R220.48-05 – inch

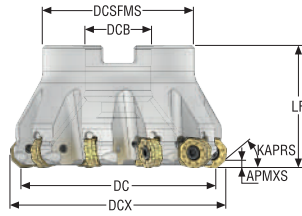

- For insert selection and cutting data recommendations, see page(s) 258 - 260
- For complete insert programme, see page(s) 838
- For ISO attribute explanation, see page 16

Designation	Item number	Type of mounting	DC	ZEFP	APMXS	KAPRS*	DCX	DCB	DCSFMS	LF	RPMX	Weight	Insert
			inch		inch		inch	inch	inch	inch		lbs	
R220.48-01.50-05-04SA	02810093	Arbor	1.575	4	0.118	40.0	1.904	0.500	1.378	1.575	16100	0.660	ON.U0504
R220.48-02.00-05-05SA	02810096	Arbor	1.969	5	0.118	40.0	2.297	0.750	1.850	1.575	14400	0.880	ON.U0504
R220.48-02.50-05-05SA	02810098	Arbor	2.480	5	0.118	40.0	2.809	0.750	1.850	1.575	12800	1.320	ON.U0504
R220.48-03.00-05-06SA	02810101	Arbor	3.150	6	0.118	40.0	3.478	1.000	2.441	1.969	11400	2.870	ON.U0504
R220.48-03.00-05-10SA	02810102	Arbor	3.150	10	0.118	40.0	3.478	1.000	2.441	1.969	11400	2.650	ON.U0504
R220.48-04.00-05-07SA	02810103	Arbor	3.937	7	0.118	40.0	4.266	1.500	3.031	1.969	10200	3.970	ON.U0504

Spare Parts, included in delivery

For cutter	Arbor screw	Insert key	Insert screw
R220.48-01.50	UC6S1/4UNFX1	H4B-T15P	C04009-T15P
R220.48-02.00 / 02.50	UC6S3/8UNFX1	H4B-T15P	C04009-T15P
R220.48-03.00	UC6S1/2UNFX1-1/4	H4B-T15P	C04009-T15P
R220.48-04.00	UF6S3/4UNFX1-3/4	H4B-T15P	C04009-T15P

Accessories

For cutter	Insert clamping torque	Torque key
R220.48-..	31.0IN.LBS	T00-15P35

Torque and fixed keys, see page 894



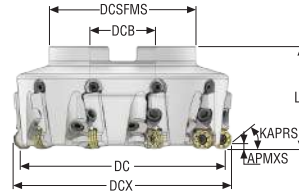



Double Octomill™ R220.48-05CS – Metric



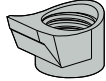

- For insert selection and cutting data recommendations, see page(s) 258 - 260
- For complete insert programme, see page(s) 838
- For ISO attribute explanation, see page 16

Designation	Item number	Type of mounting	DC	ZEFP	APMXS	KAPRS°	DCX	DCB	DCSFMS	LF	RPMX	Weight	Insert
			mm		mm		mm	mm	mm	mm		kg	
R220.48-0100-05-8CS	03000629	Arbor	100,0	8	3,0	40,0	108,0	32,0	77,0	63,0	10200	3,0	ON.U0504
R220.48-0125-05-10CS	03000630	Arbor	125,0	10	3,0	40,0	133,0	40,0	90,0	63,0	9100	4,0	ON.U0504
R220.48-8160-05-14CS	03000631	Arbor	160,0	14	3,0	40,0	168,0	40,0	90,0	63,0	8000	6,5	ON.U0504
R220.48-8200-05-18CS	03000632	Arbor	200,0	18	3,0	40,0	208,0	60,0	130,0	63,0	7200	9,0	ON.U0504

Spare Parts, included in delivery

For cutter	Adjustment unit	Cassette	Cassette screw	Insert key	Insert screw	Wedge clamp	Wedge screw
R220.48-0100-0125	 AU1114T-T15P	 ON05AR	 FS96018	 H4B-T15P	 C04009-T15P	 CW0810	 LD8020-T25P
R220.48-8160	AU1114T-T15P	ON05AR	FS96018	H4B-T15P	C04009-T15P	CW0810	LD8020-T25P
R220.48-8200	AU1114T-T15P	ON05AR	FS96018	H4B-T15P	C04009-T15P	CW0810	LD8020-T25P

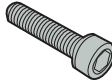
Accessories

For cutter	Arbor screw	Insert clamping torque	Torque key
R220.48-0100-0125	 -	 3.5NM	 T00-15P35
R220.48-8160	MC6S12X40	3.5NM	T00-15P35
R220.48-8200	MC6S16X50	3.5NM	T00-15P35

Torque and fixed keys, see page 894

Double Octomill™ R220.48-05CS – inch

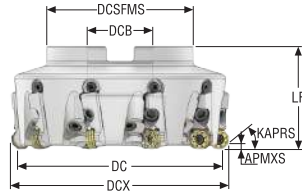

- For insert selection and cutting data recommendations, see page(s) 258 - 260
- For complete insert programme, see page(s) 838
- For ISO attribute explanation, see page 16

Designation	Item number	Type of mounting	DC	ZEFP	APMXS	KAPRS*	DCX	DCB	DCSFMS	LF	RPMX	Weight	Insert
			inch		inch		inch	inch	inch	inch		lbs	
R220.48-04.00-05-8CS	03000634	Arbor	3.937	8	0.118	40.0	4.252	1.500	3.031	2.480	10200	6.610	ON.U0504
R220.48-06.00-05-14CS	03000636	Arbor	6.299	14	0.118	40.0	6.614	2.000	4.331	2.480	8000	13.230	ON.U0504
R220.48-808.00-05-18CS	03000637	Arbor	7.874	18	0.118	40.0	8.189	2.500	5.118	2.480	7200	18.960	ON.U0504

Spare Parts, included in delivery

For cutter	Adjustment unit	Arbor screw	Cassette	Cassette screw	Insert key	Insert screw	Wedge clamp	Wedge screw
R220.48-04.00	AU1114T-T15P	UC6S3/4UNFX1-1/4	ON05AR	FS96018	H4B-T15P	C04009-T15P	CW0810	LD8020-T25P
R220.48-06.00	AU1114T-T15P	-	ON05AR	FS96018	H4B-T15P	C04009-T15P	CW0810	LD8020-T25P
R220.48-808.00	AU1114T-T15P	-	ON05AR	FS96018	H4B-T15P	C04009-T15P	CW0810	LD8020-T25P

Accessories

For cutter	Arbor screw	Insert clamping torque	Torque key
R220.48-04.00	-	31.0IN.LBS	T00-15P35
R220.48-06.00	58215080	31.0IN.LBS	T00-15P35
R220.48-808.00	-	31.0IN.LBS	T00-15P35

Torque and fixed keys, see page 894

Square shoulder and slot milling cutters

Helical milling cutters

Face milling cutters

Disc milling cutters

High feed milling cutters

Copy milling cutters

Plunge milling cutters

Chamfer milling cutters

Spot facing cutters

Inserts

R220.48-05 – Insert selection – mm/Inch

SMG		a _p	f _z			
			80%	60%	40%	20%
P1	ONMU050410ANTN-M11 T350M	1,8	0,26	0,26	0,26	0,34
		0,070	0,010	0,010	0,010	0,013
P2	ONMU050410ANTN-M11 T350M	1,8	0,26	0,26	0,28	0,34
		0,070	0,010	0,010	0,011	0,013
P3	ONMU050406ANTN-ME14 T350M	1,8	0,28	0,28	0,28	0,36
		0,070	0,011	0,011	0,011	0,014
P4	ONMU050406ANTN-ME14 MP2501	1,8	0,28	0,28	0,28	0,34
		0,070	0,011	0,011	0,011	0,013
P5	ONMU050406ANTN-ME14 MP2501	1,8	0,26	0,26	0,28	0,34
		0,070	0,010	0,010	0,011	0,013
P6	ONMU050406ANTN-ME14 MP2501	1,8	0,26	0,26	0,28	0,34
		0,070	0,010	0,010	0,011	0,013
P7	ONMU050406ANTN-ME14 T350M	1,8	0,26	0,26	0,28	0,34
		0,070	0,010	0,010	0,011	0,013
P8	ONMU050406ANTN-ME14 T350M	1,8	0,28	0,28	0,28	0,36
		0,070	0,011	0,011	0,011	0,014
P11	ONMU050410ANTN-M10 MP2050	1,8	0,24	0,24	0,25	0,30
		0,070	0,0095	0,0095	0,010	0,012
P12	ONMU050410ANTN-M10 MP2050	1,4	0,17	0,17	0,18	0,22
		0,055	0,0065	0,0065	0,0070	0,0085
M1	ONMU050410ANTN-ME11 F40M	1,8	0,24	0,24	0,25	0,30
		0,070	0,0095	0,0095	0,010	0,012
M2	ONMU050410ANTN-ME11 F40M	1,8	0,22	0,22	0,22	0,28
		0,070	0,0085	0,0085	0,0085	0,011
M3	ONMU050410ANTN-ME11 MS2050	1,4	0,18	0,18	0,19	0,24
		0,055	0,0070	0,0070	0,0075	0,0095
M4	ONMU050410ANTN-M10 MP2050	1,1	0,19	0,19	0,19	0,24
		0,044	0,0075	0,0075	0,0075	0,0095
M5	ONMU050410ANTN-M10 MP2050	1,1	0,19	0,19	0,19	0,24
		0,044	0,0075	0,0075	0,0075	0,0095
K1	ONMU050406ANTN-ME14 MP1501	1,8	0,30	0,30	0,30	0,38
		0,070	0,012	0,012	0,012	0,015
K2	ONMU050406ANTN-ME14 MP1501	1,8	0,26	0,26	0,28	0,34
		0,070	0,010	0,010	0,011	0,013
K3	ONMU050406ANTN-ME14 MK2050	1,8	0,26	0,26	0,28	0,34
		0,070	0,010	0,010	0,011	0,013
K4	ONMU050406ANTN-ME14 MK2050	1,8	0,26	0,26	0,28	0,34
		0,070	0,010	0,010	0,011	0,013
K5	ONMU050406ANTN-ME14 MK2050	1,8	0,24	0,24	0,25	0,30
		0,070	0,0095	0,0095	0,010	0,012
K6	ONMU050406ANTN-ME14 MK2050	1,8	0,26	0,26	0,28	0,34
		0,070	0,010	0,010	0,011	0,013
K7	ONMU050406ANTN-ME14 MK2050	1,8	0,24	0,24	0,25	0,30
		0,070	0,0095	0,0095	0,010	0,012
N1	ONMU050410ANTN-ME11 F40M	1,8	0,30	0,30	0,32	0,38
		0,070	0,012	0,012	0,013	0,015
N2	ONMU050410ANTN-ME11 F40M	1,8	0,30	0,30	0,32	0,38
		0,070	0,012	0,012	0,013	0,015
N3	ONMU050410ANTN-ME11 F40M	1,8	0,30	0,30	0,32	0,38
		0,070	0,012	0,012	0,013	0,015
N11	ONMU050410ANTN-ME11 F40M	1,8	0,30	0,30	0,32	0,38
		0,070	0,012	0,012	0,013	0,015
S1	ONMU050410ANTN-M11 T350M	1,1	0,19	0,19	0,19	0,24
		0,044	0,0075	0,0075	0,0075	0,0095
S2	ONMU050410ANTN-M11 T350M	1,1	0,17	0,17	0,18	0,22
		0,044	0,0065	0,0065	0,0070	0,0085
S3	ONMU050410ANTN-M11 T350M	1,3	0,18	0,18	0,19	0,24
		0,050	0,0070	0,0070	0,0075	0,0095
S11	ONMU050410ANTN-ME11 MS2050	1,3	0,18	0,18	0,19	0,24
		0,050	0,0070	0,0070	0,0075	0,0095
S12	ONMU050410ANTN-ME11 MS2050	1,3	0,18	0,18	0,19	0,24
		0,050	0,0070	0,0070	0,0075	0,0095
S13	ONMU050410ANTN-ME11 MS2050	1,1	0,17	0,17	0,17	0,22
		0,044	0,0065	0,0065	0,0065	0,0085
H5	ONMU050410ANTN-M11 MP3000	1,4	0,17	0,17	0,18	0,22
		0,055	0,0065	0,0065	0,0070	0,0085
H8	ONMU050410ANTN-M11 MP3000	1,3	0,13	0,13	0,13	0,17
		0,050	0,0050	0,0050	0,0050	0,0065
H11	ONMU050410ANTN-M11 MP3000	1,4	0,17	0,17	0,18	0,22
		0,055	0,0065	0,0065	0,0070	0,0085
H12	ONMU050410ANTN-M11 MP3000	1,3	0,13	0,13	0,13	0,17
		0,050	0,0050	0,0050	0,0050	0,0065
H21	ONMU050410ANTN-M11 MP3000	1,3	0,13	0,13	0,13	0,17
		0,050	0,0050	0,0050	0,0050	0,0065

SMG = Seco material group
 f_z = mm/tooth (in/tooth), v_c = m/min (sf/min), a_p/DC = %
 All cutting data are start values

R217/220.48-05 – Cutting data $v_c = (m/min)/(sf/min)$

SMG	MK1500				MP1501				MP2501				T350M				MM4500			
	100%	80%	60%	40%	100%	80%	60%	40%	100%	80%	60%	40%	100%	80%	60%	40%	100%	80%	60%	40%
P1	—	—	—	—	315	335	360	400	280	295	320	355	245	260	280	310	175	185	200	225
	—	—	—	—	1025	1100	1175	1300	920	970	1050	1175	800	850	920	1025	570	610	660	740
P2	—	—	—	—	305	325	350	385	270	290	310	340	235	250	270	295	170	180	195	220
	—	—	—	—	1000	1075	1150	1275	890	950	1025	1125	770	820	890	970	560	590	640	720
P3	—	—	—	—	265	285	305	335	235	250	270	300	205	220	235	260	150	160	175	185
	—	—	—	—	870	940	1000	1100	770	820	890	980	670	720	770	850	490	520	570	610
P4	—	—	—	—	240	255	270	300	210	225	240	265	185	195	210	230	130	140	150	170
	—	—	—	—	790	840	890	980	690	740	790	870	610	640	690	750	425	460	490	560
P5	—	—	—	—	225	240	260	285	200	215	230	255	175	185	200	220	125	135	145	160
	—	—	—	—	740	790	850	940	660	710	750	840	570	610	660	720	410	445	475	520
P6	—	—	—	—	255	270	290	325	225	240	260	290	195	210	225	250	140	150	165	180
	—	—	—	—	840	890	950	1075	740	790	850	950	640	690	740	820	460	490	540	590
P7	—	—	—	—	240	255	275	305	215	225	245	270	185	195	215	235	135	145	155	170
	—	—	—	—	790	840	900	1000	710	740	800	890	610	640	710	770	445	475	510	560
P8	—	—	—	—	225	240	255	285	200	210	230	250	175	185	200	220	125	135	145	155
	—	—	—	—	740	790	840	940	660	690	750	820	570	610	660	720	410	445	475	510
P11	—	—	—	—	235	250	270	300	205	220	235	265	180	190	205	230	130	140	150	165
	—	—	—	—	770	820	890	980	670	720	770	870	590	620	670	750	425	460	490	540
P12	—	—	—	—	150	160	175	195	135	145	155	170	115	125	135	150	85	90	100	110
	—	—	—	—	490	520	570	640	445	475	510	560	375	410	445	490	280	295	330	360
M1	—	—	—	—	—	—	—	—	195	210	225	245	180	195	210	230	145	155	170	185
	—	—	—	—	—	—	—	—	640	690	740	800	590	640	690	750	475	510	560	610
M2	—	—	—	—	—	—	—	—	160	170	185	205	150	160	175	190	120	130	140	155
	—	—	—	—	—	—	—	—	520	560	610	670	490	520	570	620	395	425	460	510
M3	—	—	—	—	—	—	—	—	130	140	150	165	120	130	140	155	100	105	110	125
	—	—	—	—	—	—	—	—	425	460	490	540	395	425	460	510	330	345	360	410
M4	—	—	—	—	—	—	—	—	100	105	115	130	95	100	110	120	75	80	85	95
	—	—	—	—	—	—	—	—	330	345	375	425	310	330	360	395	245	260	280	310
M5	—	—	—	—	—	—	—	—	85	90	95	105	80	85	90	100	65	65	75	80
	—	—	—	—	—	—	—	—	280	295	310	345	260	280	295	330	215	215	245	260
K1	305	325	350	380	245	260	280	305	215	230	245	270	185	200	215	235	—	—	—	—
	1000	1075	1150	1250	800	850	920	1000	710	750	800	890	610	660	710	770	—	—	—	—
K2	270	285	310	340	215	230	245	270	190	205	220	240	165	175	190	210	—	—	—	—
	890	940	1025	1125	710	750	800	890	620	670	720	790	540	570	620	690	—	—	—	—
K3	230	245	260	290	180	195	210	230	160	170	185	205	140	150	160	175	—	—	—	—
	750	800	850	950	590	640	690	750	520	560	610	670	460	490	520	570	—	—	—	—
K4	220	230	250	275	175	185	200	220	155	165	175	195	135	145	155	170	—	—	—	—
	720	750	820	900	570	610	660	720	510	540	570	640	445	475	510	560	—	—	—	—
K5	135	140	155	170	105	115	120	135	95	100	110	120	80	85	95	105	—	—	—	—
	445	460	510	560	345	375	395	445	310	330	360	395	260	280	310	345	—	—	—	—
K6	190	205	220	240	155	165	175	195	135	145	155	170	120	125	135	150	—	—	—	—
	620	670	720	790	510	540	570	640	445	475	510	560	395	410	445	490	—	—	—	—
K7	170	180	195	215	135	145	155	175	120	130	140	155	105	110	120	135	—	—	—	—
	560	590	640	710	445	475	510	570	395	425	460	510	345	360	395	445	—	—	—	—
N1	—	—	—	—	—	—	—	—	—	—	—	—	—	—	—	—	—	—	—	—
	—	—	—	—	—	—	—	—	—	—	—	—	—	—	—	—	—	—	—	—
N2	—	—	—	—	—	—	—	—	—	—	—	—	—	—	—	—	—	—	—	—
	—	—	—	—	—	—	—	—	—	—	—	—	—	—	—	—	—	—	—	—
N3	—	—	—	—	—	—	—	—	—	—	—	—	—	—	—	—	—	—	—	—
	—	—	—	—	—	—	—	—	—	—	—	—	—	—	—	—	—	—	—	—
N11	—	—	—	—	—	—	—	—	—	—	—	—	—	—	—	—	—	—	—	—
	—	—	—	—	—	—	—	—	—	—	—	—	—	—	—	—	—	—	—	—
S1	—	—	—	—	—	—	—	—	49	50	55	60	43	46	50	55	23	24	27	29
	—	—	—	—	—	—	—	—	160	165	180	195	140	150	165	180	75	80	90	95
S2	—	—	—	—	—	—	—	—	39	42	45	50	35	37	41	45	19	20	21	24
	—	—	—	—	—	—	—	—	130	140	150	165	115	120	135	150	60	65	70	80
S3	—	—	—	—	—	—	—	—	35	37	40	44	31	33	35	39	16	17	19	21
	—	—	—	—	—	—	—	—	115	120	130	145	100	110	115	130	50	55	60	70
S11	—	—	—	—	—	—	—	—	70	75	80	85	60	65	70	80	33	35	37	41
	—	—	—	—	—	—	—	—	230	245	260	280	195	215	230	260	110	115	120	135
S12	—	—	—	—	—	—	—	—	48	50	55	60	43	45	49	55	30	32	34	38
	—	—	—	—	—	—	—	—	155	165	180	195	140	150	160	180	100	105	110	125
S13	—	—	—	—	—	—	—	—	27	29	32	35	24	26	28	31	17	18	20	22
	—	—	—	—	—	—	—	—	90	95	105	115	80	85	90	100	55	60	65	70
H5	—	—	—	—	50	55	60	65	41	43	47	50	39	41	45	49	—	—	—	—
	—	—	—	—	165	180	195	215	135	140	155	165	130	135	150	160	—	—	—	—
H8	—	—	—	—	55	60	60	70	44	46	50	55	42	45	48	55	—	—	—	—
	—	—	—	—	180	195	195	230	145	150	165	180	140	150	155	180	—	—	—	—
H11	—	—	—	—	65	70	75	80	50	55	60	65	50	55	55	65	—	—	—	—
	—	—	—	—	215	230	245	260	165	180	195	215	165	180	180	215	—	—	—	—
H12	—	—	—	—	95	105	110	125	85	90	100	110	75	80	85	95	—	—	—	—
	—	—	—	—	310	345	360	410	280	295	330	360	245	260	280	310	—	—	—	—
H21	—	—	—	—	55	60	60	70	44	46	50	55	42	45	48	55	—	—	—	—
	—	—	—	—	180	195	195	230	145	150	165	180	140	150	155	180	—	—	—	—

Square shoulder and slot milling cutters
Helical milling cutters
Face milling cutters
Disc milling cutters
High feed milling cutters
Copy milling cutters
Plunge milling cutters
Chamfer milling cutters
Spot facing cutters
Inserts

R217/220.48-05 – Cutting data $v_c = (m/min)/(sf/min)$

SMG	F40M				MS2050				MP3000				MK2050			
	100%	80%	60%	40%	100%	80%	60%	40%	100%	80%	60%	40%	100%	80%	60%	40%
P1	210	225	240	270	240	255	275	305	265	280	305	335	275	290	315	350
	690	740	790	890	790	840	900	1000	870	920	1000	1100	900	950	1025	1150
P2	205	220	235	255	230	245	265	295	255	275	295	320	265	285	305	335
	670	720	770	840	750	800	870	970	840	900	970	1050	870	940	1000	1100
P3	180	190	205	225	205	215	235	255	225	240	255	280	235	245	265	295
	590	620	670	740	670	710	770	840	740	790	840	920	770	800	870	970
P4	160	170	185	200	180	190	205	230	200	210	230	250	205	220	240	260
	520	560	610	660	590	620	670	750	660	690	750	820	670	720	790	850
P5	150	160	175	190	170	185	195	220	190	200	220	240	200	210	225	250
	490	520	570	620	560	610	640	720	620	660	720	790	660	690	740	820
P6	170	180	195	220	195	205	220	245	215	225	245	275	220	235	255	285
	560	590	640	720	640	670	720	800	710	740	800	900	720	770	840	940
P7	160	170	185	205	180	195	210	230	200	215	230	255	210	225	240	270
	520	560	610	670	590	640	690	750	660	710	750	840	690	740	790	890
P8	150	160	170	190	170	185	195	215	190	200	215	235	195	210	225	245
	490	520	560	620	560	610	640	710	620	660	710	770	640	690	740	800
P11	155	165	180	200	175	190	205	225	195	210	225	250	205	215	235	260
	510	540	590	660	570	620	670	740	640	690	740	820	670	710	770	850
P12	100	110	115	130	115	125	135	145	130	135	145	160	135	140	150	170
	330	360	375	425	375	410	445	475	425	445	475	520	445	460	490	560
M1	165	175	190	205	185	200	215	240	190	205	220	240	—	—	—	—
	540	570	620	670	610	660	710	790	620	670	720	790	—	—	—	—
M2	135	145	155	175	155	165	175	195	160	170	180	200	—	—	—	—
	445	475	510	570	510	540	570	640	520	560	590	660	—	—	—	—
M3	110	115	125	140	125	135	145	160	130	135	145	165	—	—	—	—
	360	375	410	460	410	445	475	520	425	445	475	540	—	—	—	—
M4	85	90	100	110	95	100	110	125	100	105	115	125	—	—	—	—
	280	295	330	360	310	330	360	410	330	345	375	410	—	—	—	—
M5	70	75	80	90	80	85	95	100	80	85	95	105	—	—	—	—
	230	245	260	295	260	280	310	330	260	280	310	345	—	—	—	—
K1	165	175	185	205	—	—	—	—	205	215	235	255	290	305	330	360
	540	570	610	670	—	—	—	—	670	710	770	840	950	1000	1075	1175
K2	145	155	165	180	—	—	—	—	180	190	205	230	255	270	295	325
	475	510	540	590	—	—	—	—	590	620	670	750	840	890	970	1075
K3	120	130	140	155	—	—	—	—	155	165	175	195	215	230	250	275
	395	425	460	510	—	—	—	—	510	540	570	640	710	750	820	900
K4	115	125	135	145	—	—	—	—	145	155	165	185	205	220	235	260
	375	410	445	475	—	—	—	—	475	510	540	610	670	720	770	850
K5	70	75	80	90	—	—	—	—	90	95	100	115	125	135	145	160
	230	245	260	295	—	—	—	—	295	310	330	375	410	445	475	520
K6	105	110	120	130	—	—	—	—	130	135	145	160	180	195	210	230
	345	360	395	425	—	—	—	—	425	445	475	520	590	640	690	750
K7	90	95	105	115	—	—	—	—	115	120	130	145	160	170	185	205
	295	310	345	375	—	—	—	—	375	395	425	475	520	560	610	670
N1	1175	1250	1350	1525	—	—	—	—	—	—	—	—	—	—	—	—
	3850	4100	4425	5000	—	—	—	—	—	—	—	—	—	—	—	—
N2	480	510	550	610	—	—	—	—	—	—	—	—	—	—	—	—
	1575	1675	1800	2000	—	—	—	—	—	—	—	—	—	—	—	—
N3	320	340	365	410	—	—	—	—	—	—	—	—	—	—	—	—
	1050	1125	1200	1350	—	—	—	—	—	—	—	—	—	—	—	—
N11	365	385	420	470	—	—	—	—	—	—	—	—	—	—	—	—
	1200	1275	1375	1550	—	—	—	—	—	—	—	—	—	—	—	—
S1	40	42	46	50	45	48	50	55	46	49	55	60	—	—	—	—
	130	140	150	165	150	155	165	180	150	160	180	195	—	—	—	—
S2	32	34	37	41	36	38	42	46	37	39	43	47	—	—	—	—
	105	110	120	135	120	125	140	150	120	130	140	155	—	—	—	—
S3	28	30	32	36	32	34	37	40	33	35	37	41	—	—	—	—
	90	100	105	120	105	110	120	130	110	115	120	135	—	—	—	—
S11	55	60	65	70	65	65	70	80	65	70	75	80	—	—	—	—
	180	195	215	230	215	215	230	260	215	230	245	260	—	—	—	—
S12	39	41	44	49	44	47	50	55	45	48	50	55	—	—	—	—
	130	135	145	160	145	155	165	180	150	155	165	180	—	—	—	—
S13	22	24	26	28	25	27	29	32	26	27	30	33	—	—	—	—
	70	80	85	90	80	90	95	105	85	90	100	110	—	—	—	—
H5	34	36	39	43	—	—	—	—	40	42	45	50	—	—	—	—
	110	120	130	140	—	—	—	—	130	140	150	165	—	—	—	—
H8	36	39	42	46	—	—	—	—	42	45	49	55	—	—	—	—
	120	130	140	150	—	—	—	—	140	150	160	180	—	—	—	—
H11	43	46	49	55	—	—	—	—	50	55	60	65	—	—	—	—
	140	150	160	180	—	—	—	—	165	180	195	215	—	—	—	—
H12	65	70	75	80	—	—	—	—	80	85	95	105	—	—	—	—
	215	230	245	260	—	—	—	—	260	280	310	345	—	—	—	—
H21	36	39	42	46	—	—	—	—	42	45	49	55	—	—	—	—
	120	130	140	150	—	—	—	—	140	150	160	180	—	—	—	—

Double Octomill™ R217/220.48-09 – Metric

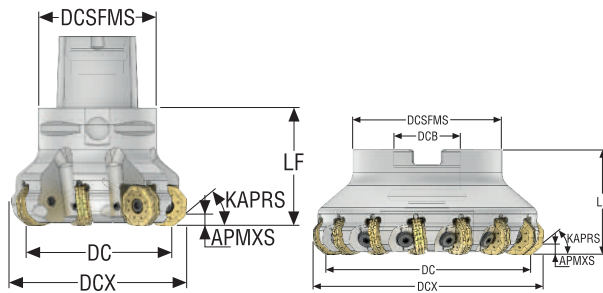

- For insert selection and cutting data recommendations, see page(s) 268 - 270
- For complete insert programme, see page(s) 838
- For ISO attribute explanation, see page 16

Designation	Item number	Type of mounting	DC	ZEFP	APMXS	KAPRS°	DCX	DCB	DCSFMS	LF	RPMX	Weight	Insert
			mm		mm		mm	mm	mm	mm		kg	
C6-R217.48-063-09-05SA	02731337	Seco-Capto	63,0	5	6,0	40,0	78,0	–	63,0	63,0	4900	1,5	ON.U0905
C6-R217.48-063-09-06SA	02731336	Seco-Capto	63,0	6	6,0	40,0	78,0	–	63,0	63,0	4900	1,5	ON.U0905
C6-R217.48-080-09-06SA	02731338	Seco-Capto	80,0	6	6,0	40,0	95,0	–	63,0	63,0	4400	1,7	ON.U0905
C6-R217.48-080-09-07SA	02731340	Seco-Capto	80,0	7	6,0	40,0	95,0	–	63,0	63,0	4400	1,8	ON.U0905
C6-R217.48-080-09-09M	02731344	Seco-Capto	80,0	9	6,0	40,0	95,0	–	63,0	63,0	4400	2,3	ON.U0905
C6-R217.48-100-09-07SA	02731347	Seco-Capto	100,0	7	6,0	40,0	115,0	–	63,0	80,0	3900	3,0	ON.U0905
C8-R217.48-100-09-07SA	02731341	Seco-Capto	100,0	7	6,0	40,0	115,0	–	80,0	80,0	3900	3,7	ON.U0905
C8-R217.48-100-09-08SA	02731342	Seco-Capto	100,0	8	6,0	40,0	115,0	–	80,0	80,0	3900	3,7	ON.U0905
C8-R217.48-100-09-12M	02731345	Seco-Capto	100,0	12	6,0	40,0	115,0	–	80,0	80,0	3900	4,0	ON.U0905
R220.48-0063-09-05SA	02670226	Arbor	63,0	5	6,0	40,0	78,0	22,0	47,0	40,0	4900	0,5	ON.U0905
R220.48-0063-09-06SA	02685780	Arbor	63,0	6	6,0	40,0	78,0	22,0	47,0	40,0	4900	0,5	ON.U0905
R220.48-0080-09-06SA	02670228	Arbor	80,0	6	6,0	40,0	95,0	27,0	62,0	50,0	4400	1,0	ON.U0905
R220.48-0080-09-07SA	02685781	Arbor	80,0	7	6,0	40,0	95,0	27,0	62,0	50,0	4400	1,0	ON.U0905
R220.48-0080-09-09M	02670210	Arbor	80,0	9	6,0	40,0	95,0	27,0	62,0	50,0	4400	1,2	ON.U0905
R220.48-0100-09-07SA	02670229	Arbor	100,0	7	6,0	40,0	115,0	32,0	77,0	50,0	3900	1,6	ON.U0905
R220.48-0100-09-08SA	02685782	Arbor	100,0	8	6,0	40,0	115,0	32,0	77,0	50,0	3900	1,6	ON.U0905
R220.48-0100-09-12M	02670213	Arbor	100,0	12	6,0	40,0	115,0	32,0	77,0	50,0	3900	1,9	ON.U0905
R220.48-0125-09-08SA	02670231	Arbor	125,0	8	6,0	40,0	140,0	40,0	90,0	63,0	3500	2,9	ON.U0905
R220.48-0125-09-10SA	02685847	Arbor	125,0	10	6,0	40,0	140,0	40,0	90,0	63,0	3500	3,0	ON.U0905
R220.48-0125-09-15M	02670214	Arbor	125,0	15	6,0	40,0	140,0	40,0	90,0	63,0	3500	3,4	ON.U0905
R220.48-8160-09-12S	02685849	Arbor	160,0	12	6,0	40,0	175,0	40,0	90,0	63,0	3100	4,4	ON.U0905
R220.48-8160-09-10S	02685776	Arbor	160,0	10	6,0	40,0	175,0	40,0	90,0	63,0	3100	4,2	ON.U0905
R220.48-8160-09-20M	02670215	Arbor	160,0	20	6,0	40,0	175,0	40,0	90,0	63,0	3100	4,8	ON.U0905
R220.48-8200-09-12S	02685845	Arbor	200,0	12	6,0	40,0	215,0	60,0	130,0	63,0	2700	5,4	ON.U0905
R220.48-8200-09-24M	02685773	Arbor	200,0	24	6,0	40,0	215,0	60,0	130,0	63,0	2700	6,0	ON.U0905
R220.48-8200-09-28M	02729891	Arbor	200,0	28	6,0	40,0	215,0	60,0	130,0	63,0	2700	5,9	ON.U0905
R220.48-8250-09-16S	02685777	Arbor	250,0	16	6,0	40,0	265,0	60,0	130,0	63,0	2500	13,0	ON.U0905
R220.48-8250-09-30M	02685774	Arbor	250,0	30	6,0	40,0	265,0	60,0	130,0	63,0	2500	14,1	ON.U0905
R220.48-8315-09-20S	02685846	Arbor	315,0	20	6,0	40,0	330,0	60,0	225,0	80,0	2200	27,0	ON.U0905
R220.48-8315-09-40M	02685775	Arbor	315,0	40	6,0	40,0	330,0	60,0	225,0	80,0	2200	28,6	ON.U0905

Square shoulder and slot milling cutters

Helical milling cutters

Face milling cutters

Disc milling cutters

High feed milling cutters

Copy milling cutters

Plunge milling cutters

Chamfer milling cutters

Spot facing cutters

Inserts

Spare Parts, included in delivery

For cutter	Arbor screw	Insert key	Insert screw	Wedge kit
Cx-R217.48-063-080SA	-	H6B-T20P	C05013-T20P	-
Cx-R217.48-063-080M	-	H6B-T20P	-	CW0816-RHA
Cx-R217.48-0100SA	-	H6B-T20PL	C05013-T20P	-
Cx-R217/220.48-0100-0125M	-	H6B-T20PL	-	CW0816-RHA
R220.48-0063SA	220.17-692	H6B-T20P	C05013-T20P	-
R220.48-0080SA	-	H6B-T20P	C05013-T20P	-
R220.48-0080M	-	H6B-T20P	-	CW0816-RHA
R220.48-0100-8315SA	-	H6B-T20PL	C05013-T20P	-
R220.48-8160-8315M	-	H6B-T20PL	-	CW0816-RHA

Accessories

For cutter	Arbor screw	Arbor screw 2	Insert clamping torque	Torque key
Cx-R217/220.48-063-0125SA	-	-	5.0NM	T00-20P50
Cx-R217/220.48-080-100M	-	-	-	-
R220.48-8160S	MC6S12X40	-	5.0NM	T00-20P50
R220.48-8160M	MC6S12X40	-	-	-
R220.48-8200-8250S	MC6S16X50	-	5.0NM	T00-20P50
R220.48-8200-8250M	MC6S16X50	-	-	-
R220.48-8315S	MC6S16X50	MC6S20X50	5.0NM	T00-20P50
R220.48-8315M	MC6S16X50	MC6S20X50	-	-

Torque and fixed keys, see page 894

Square shoulder and slot milling cutters
Helical milling cutters
Face milling cutters
Disc milling cutters
High feed milling cutters
Copy milling cutters
Plunge milling cutters
Chamfer milling cutters
Spot facing cutters
Inserts

Double Octomill™ R220.48-09 – inch

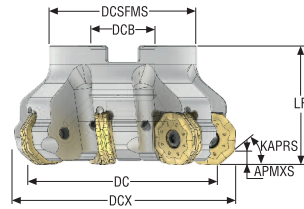

- For insert selection and cutting data recommendations, see page(s) 268 - 270
- For complete insert programme, see page(s) 838
- For ISO attribute explanation, see page 16

Designation	Item number	Type of mounting	DC	ZEFP	APMXS	KAPRS°	DCX	DCB	DCSFMS	LF	RPMX	Weight	Insert
			inch		inch		inch	inch	inch	inch		lbs	
R220.48-02.50-09-05SA	02685793	Arbor	2.480	5	0.236	40.0	3.071	0.750	1.850	1.575	4900	1.100	ON.U0905
R220.48-03.00-09-06SA	02685794	Arbor	3.150	6	0.236	40.0	3.740	1.000	2.441	1.969	4400	2.430	ON.U0905
R220.48-03.00-09-09M	02685806	Arbor	3.150	9	0.236	40.0	3.740	1.000	2.441	1.969	4400	2.870	ON.U0905
R220.48-04.00-09-07SA	02685795	Arbor	3.937	7	0.236	40.0	4.528	1.500	3.543	1.969	3900	3.530	ON.U0905
R220.48-04.00-09-12M	02685807	Arbor	3.937	12	0.236	40.0	4.528	1.500	3.543	1.969	3900	3.970	ON.U0905
R220.48-05.00-09-08SA	02685797	Arbor	4.921	8	0.236	40.0	5.512	1.500	3.543	2.480	3500	7.050	ON.U0905
R220.48-05.00-09-15M	02685808	Arbor	4.921	15	0.236	40.0	5.512	1.500	3.543	2.480	3500	8.160	ON.U0905
R220.48-06.00-09-10S	02685799	Arbor	6.299	10	0.236	40.0	6.890	2.000	4.331	2.480	3100	8.820	ON.U0905
R220.48-808.00-09-12S	02685801	Arbor	7.874	12	0.236	40.0	8.465	2.500	5.118	2.480	2700	11.900	ON.U0905
R220.48-810.00-09-16S	02685802	Arbor	9.843	16	0.236	40.0	10.433	2.500	5.118	2.480	2500	28.660	ON.U0905
R220.48-812.50-09-20S	02685803	Arbor	12.402	20	0.236	40.0	12.992	2.500	8.858	3.150	2200	59.520	ON.U0905

Square shoulder and slot milling cutters

Helical milling cutters

Face milling cutters

Disc milling cutters

High feed milling cutters

Copy milling cutters



Plunge milling cutters

Chamfer milling cutters

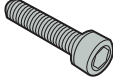
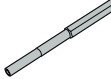

Spot facing cutters

Inserts

Spare Parts, included in delivery

For cutter	Arbor screw	Insert key	Insert screw	Wedge kit
R220.48-02.50	 UC6S3/8UNFX1	 H6B-T20P	 C05013-T20P	-
R220.48-03.00	UC6S1/2UNFX1-1/4	H6B-T20P	C05013-T20P	-
R220.48-03.00M	UC6S1/2UNFX1-1/4	H6B-T20P	-	CW0816-RHA
R220.48-04.00	UF6S3/4UNFX1-3/4	H6B-T20PL	C05013-T20P	-
R220.48-04.00M	UC6S3/4UNFX1-1/4	H6B-T20PL	-	CW0816-RHA
R220.48-05.00	UC6S3/4UNFX1-1/4	H6B-T20PL	C05013-T20P	-
R220.48-05.00M	UC6S3/4UNFX1-1/4	H6B-T20PL	-	CW0816-RHA
R220.48-06.00 - 812.00	-	H6B-T20PL	C05013-T20P	-

Accessories

For cutter	Arbor screw	Insert clamping torque	Torque key
R220.48-02.50-05.00-SA	 -	 44.3IN.LBS	 T00-20P50
R220.48-03.00-05.00-M	-	-	-
R220.48-06.00-S	58215080	44.3IN.LBS	T00-20P50
R220.48-08.00 - 810.00-S	-	44.3IN.LBS	T00-20P50
R220.48-812.50-S	950DNC062225	44.3IN.LBS	T00-20P50

Torque and fixed keys, see page 894

Square shoulder and slot milling cutters
Helical milling cutters
Face milling cutters
Disc milling cutters
High feed milling cutters
Copy milling cutters
Plunge milling cutters
Chamfer milling cutters
Spot facing cutters
Inserts

Double Octomill™ R/L220.48-09CS – Metric

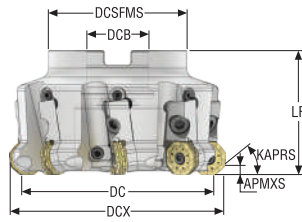

- For insert selection and cutting data recommendations, see page(s) 268 - 270
- For complete insert programme, see page(s) 838
- For ISO attribute explanation, see page 16

Designation	Item number	Type of mounting	DC	ZEFP	APMXS	KAPRS°	DCX	DCB	DCSFMS	LF	RPMX	Weight	Insert
			mm		mm		mm	mm	mm	mm		kg	
R220.48-0125-09-08CS	02883045	Arbor	125,0	8	6,0	40,0	140,0	40,0	90,0	80,0	3500	4,9	ON.U0905
R220.48-8160-09-10CS	02883046	Arbor	160,0	10	6,0	40,0	175,0	40,0	130,0	80,0	3100	7,6	ON.U0905
R220.48-8200-09-12CS	02883047	Arbor	200,0	12	6,0	40,0	215,0	60,0	160,0	80,0	2700	10,5	ON.U0905
R220.48-8250-09-16CS	02883048	Arbor	250,0	16	6,0	40,0	265,0	60,0	200,0	80,0	2500	19,6	ON.U0905
R220.48-8315-09-20CS	02883049	Arbor	315,0	20	6,0	40,0	330,0	60,0	225,0	80,0	2200	35,5	ON.U0905
L220.48-8250-09-16CS	02883053	Arbor	250,0	16	6,0	40,0	265,0	60,0	200,0	80,0	2500	19,6	ON.U0905
L220.48-0125-09-08CS	02883050	Arbor	125,0	8	6,0	40,0	140,0	40,0	90,0	80,0	3500	4,9	ON.U0905
L220.48-8160-09-10CS	02883051	Arbor	160,0	10	6,0	40,0	175,0	40,0	130,0	80,0	3100	7,6	ON.U0905
L220.48-8200-09-12CS	02883052	Arbor	200,0	12	6,0	40,0	215,0	60,0	160,0	80,0	2700	10,5	ON.U0905

Spare Parts, included in delivery

For cutter	Adjustment unit	Cassette (L)	Cassette (R)	Cassette screw	Insert key	Insert screw	Wedge clamp	Wedge screw
R220.48-0125	AU1114T-T15P	-	ON09AR	FS98030	H6B-T20PL	C05013-T20P	CW0810	LD8020-T25P
R220.48-8160	AU1114T-T15P	-	ON09AR	FS98030	H6B-T20PL	C05013-T20P	CW0810	LD8020-T25P
R220.48-8200-8250	AU1114T-T15P	-	ON09AR	FS98030	H6B-T20PL	C05013-T20P	CW0810	LD8020-T25P
R220.48-8315	AU1114T-T15P	-	ON09AR	FS98030	H6B-T20PL	C05013-T20P	CW0810	LD8020-T25P
L220.48-8200-8250	AU1114T-T15P	ON09AL	-	FS98030	H6B-T20PL	C05013-T20P	CW0810	LD8020-T25P
L220.48-0125	AU1114T-T15P	ON09AL	-	FS98030	H6B-T20PL	C05013-T20P	CW0810	LD8020-T25P
L220.48-8160	AU1114T-T15P	ON09AL	-	FS98030	H6B-T20PL	C05013-T20P	CW0810	LD8020-T25P

Accessories

For cutter	Arbor screw	Arbor screw 2	Insert clamping torque	Setting key	Torque key	Wedge key
R/L220.48-0125	-	-	5.0NM	T15P-4	T00-20P50	H6B-T25PL
R/L220.48-8160	MC6S12X40	-	5.0NM	T15P-4	T00-20P50	H6B-T25PL
R/L220.48-8200-8250	MC6S16X50	-	5.0NM	T15P-4	T00-20P50	H6B-T25PL
R220.48-8315	MC6S16X50	MC6S20X50	5.0NM	T15P-4	T00-20P50	H6B-T25PL

Torque and fixed keys, see page 894

Square shoulder and slot milling cutters
Helical milling cutters
Face milling cutters
Disc milling cutters
High feed milling cutters
Copy milling cutters
Plunge milling cutters
Chamfer milling cutters
Spot facing cutters
Inserts

Double Octomill™ R/L220.48-09CS – inch

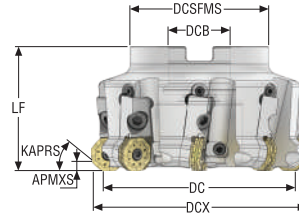

- For insert selection and cutting data recommendations, see page(s) 268 - 270
- For complete insert programme, see page(s) 838
- For ISO attribute explanation, see page 16

Designation	Item number	Type of mounting	DC	ZEFP	APMXS	KAPRS°	DCX	DCB	DCSFMS	LF	RPMX	Weight	Insert
			inch		inch		inch	inch	inch	inch		lbs	
L220.48-05.00-09-08CS	02882762	Arbor	4.921	8	0.236	40.0	5.512	1.500	3.543	3.150	3500	10.800	ON.U0905
L220.48-06.00-09-10CS	02882763	Arbor	6.299	10	0.236	40.0	6.890	2.000	4.331	3.150	3100	16.760	ON.U0905
L220.48-808.00-09-12CS	02883058	Arbor	7.874	12	0.236	40.0	8.465	2.500	5.118	3.150	2700	23.150	ON.U0905
L220.48-810.00-09-16CS	02883059	Arbor	9.843	16	0.236	40.0	10.433	2.500	5.118	3.150	2500	43.210	ON.U0905
L220.48-812.50-09-20CS	02882766	Arbor	12.402	20	0.236	40.0	12.992	2.500	8.858	3.150	2200	78.260	ON.U0905
R220.48-06.00-09-10CS	02882758	Arbor	6.299	10	0.236	40.0	6.890	2.000	4.331	3.150	3100	16.760	ON.U0905
R220.48-808.00-09-12CS	02883055	Arbor	7.874	12	0.236	40.0	8.465	2.500	5.118	3.150	2700	23.150	ON.U0905
R220.48-810.00-09-16CS	02883056	Arbor	9.843	16	0.236	40.0	10.433	2.500	5.118	3.150	2500	43.210	ON.U0905
R220.48-812.50-09-20CS	02883057	Arbor	12.402	20	0.236	40.0	12.992	2.500	8.858	3.150	2200	78.260	ON.U0905

Spare Parts, included in delivery

For cutter	Adjustment unit	Cassette (L)	Cassette (R)	Cassette screw	Insert key	Insert screw	Wedge clamp	Wedge screw
L220.48-05.00	AU1114T-T15P	ON09AL	-	FS98030	H6B-T20PL	C05013-T20P	CW0810	LD8020-T25P
L220.48-06.00	AU1114T-T15P	ON09AL	-	FS98030	H6B-T20PL	C05013-T20P	CW0810	LD8020-T25P
L220.48-808.00-810.00	AU1114T-T15P	ON09AL	-	FS98030	H6B-T20PL	C05013-T20P	CW0810	LD8020-T25P
L220.48-812.50	AU1114T-T15P	ON09AL	-	FS98030	H6B-T20PL	C05013-T20P	CW0810	LD8020-T25P
R220.48-06.00	AU1114T-T15P	-	ON09AR	FS98030	H6B-T20PL	C05013-T20P	CW0810	LD8020-T25P
R220.48-808.00-810.00	AU1114T-T15P	-	ON09AR	FS98030	H6B-T20PL	C05013-T20P	CW0810	LD8020-T25P
R220.48-812.50	AU1114T-T15P	-	ON09AR	FS98030	H6B-T20PL	C05013-T20P	CW0810	LD8020-T25P

Accessories

For cutter	Arbor screw	Insert clamping torque	Setting key	Torque key	Wedge key
L220.48-05.00	-	44.3IN.LBS	T15P-4	T00-20P50	H6B-T25PL
R/L220.48- 06.00	58215080	44.3IN.LBS	T15P-4	T00-20P50	H6B-T25PL
R/L220.48-808.00-810.00	-	44.3IN.LBS	T15P-4	T00-20P50	H6B-T25PL
R/L220.48-812.50	950DNC062225	44.3IN.LBS	T15P-4	T00-20P50	H6B-T25PL

Torque and fixed keys, see page 894

Double Octomill™ R220.48-09 CAP – Metric

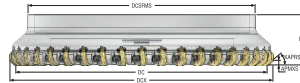

- For insert selection and cutting data recommendations, see page(s) 268 - 270
- For complete insert programme, see page(s) 838
- For ISO attribute explanation, see page 16

Designation	Item number	Type of mounting	DC	ZEFP	APMXS	KAPRS°	DCX	DCB	DCSFMS	LF	RPMX	Weight	Insert
			mm		mm		mm	mm	mm	mm		kg	
R220.48-9250-09-30M	02720552	CAP	250,0	30	6,0	40,0	265,0	–	220,0	63,0	2500	9,2	ON.U0905
R220.48-9315-09-40M	02720554	CAP	315,0	40	6,0	40,0	330,0	–	285,0	63,0	2200	13,2	ON.U0905
R220.48-9315-09-50M	02729890	CAP	315,0	50	6,0	40,0	330,0	–	285,0	63,0	2200	17,7	ON.U0905
R220.48-9355-09-50M	02671031	CAP	355,0	50	6,0	40,0	370,0	–	285,0	63,0	2000	15,1	ON.U0905
R220.48-9400-09-50M	02720555	CAP	400,0	50	6,0	40,0	415,0	–	370,0	63,0	1900	18,6	ON.U0905
R220.48-9500-09-60M	02720556	CAP	500,0	60	6,0	40,0	515,0	–	470,0	63,0	1700	27,0	ON.U0905

Spare Parts, included in delivery

For cutter	Insert key	Wedge kit
R220.48-9250-9500	H6B-T20P	CW0816-RHA

Torque and fixed keys, see page 894

Square shoulder and slot milling cutters

Helical milling cutters

Face milling cutters

Disc milling cutters

High feed milling cutters

Copy milling cutters

Plunge milling cutters

Chamfer milling cutters

Spot facing cutters

Inserts

R220.48-09 – Insert selection – mm/Inch

SMG		a_p	f_z			
			80%	60%	40%	20%
P1	ONMU090510ANTN-ME16 T350M	3,5	0,34	0,34	0,34	0,42
		0,14	0,013	0,013	0,013	0,017
P2	ONMU090510ANTN-ME16 T350M	3,5	0,34	0,34	0,36	0,44
		0,14	0,013	0,013	0,014	0,017
P3	ONMU090510ANTN-ME16 T350M	3,5	0,32	0,32	0,34	0,42
		0,14	0,013	0,013	0,013	0,017
P4	ONMU090510ANTN-ME16 MP2501	3,5	0,32	0,32	0,32	0,40
		0,14	0,013	0,013	0,013	0,016
P5	ONMU090510ANTN-ME16 MP2501	3,5	0,30	0,30	0,32	0,40
		0,14	0,012	0,012	0,013	0,016
P6	ONMU090510ANTN-ME16 MP2501	3,5	0,30	0,30	0,32	0,40
		0,14	0,012	0,012	0,013	0,016
P7	ONMU090510ANTN-ME16 T350M	3,5	0,30	0,30	0,32	0,40
		0,14	0,012	0,012	0,013	0,016
P8	ONMU090510ANTN-ME16 T350M	3,5	0,32	0,32	0,34	0,42
		0,14	0,013	0,013	0,013	0,017
P11	ONMU090520ANTN-M12 MP2050	3,5	0,26	0,26	0,28	0,34
		0,14	0,010	0,010	0,011	0,013
P12	ONMU090520ANTN-M12 MP2050	3,0	0,19	0,19	0,19	0,24
		0,12	0,0075	0,0075	0,0075	0,0095
M1	ONMU090520ANTN-ME13 F40M	3,5	0,26	0,26	0,28	0,34
		0,14	0,010	0,010	0,011	0,013
M2	ONMU090520ANTN-ME13 F40M	3,5	0,24	0,24	0,25	0,30
		0,14	0,0095	0,0095	0,010	0,012
M3	ONMU090520ANTN-ME13 MS2050	3,0	0,20	0,20	0,20	0,25
		0,12	0,0080	0,0080	0,0080	0,010
M4	ONMU090520ANTN-M12 MP2050	2,0	0,20	0,20	0,22	0,26
		0,080	0,0080	0,0080	0,0085	0,010
M5	ONMU090520ANTN-M12 MP2050	2,0	0,20	0,20	0,22	0,26
		0,080	0,0080	0,0080	0,0085	0,010
K1	ONMU090520ANTN-M15 MK1500	3,5	0,38	0,38	0,38	0,48
		0,14	0,015	0,015	0,015	0,019
K2	ONMU090520ANTN-M15 MK1500	3,5	0,34	0,34	0,34	0,44
		0,14	0,013	0,013	0,013	0,017
K3	ONMU090520ANTN-M15 MP1501	3,5	0,34	0,34	0,34	0,44
		0,14	0,013	0,013	0,013	0,017
K4	ONMU090520ANTN-M15 MP1501	3,5	0,34	0,34	0,34	0,44
		0,14	0,013	0,013	0,013	0,017
K5	ONMU090520ANTN-M15 MK2050	3,5	0,30	0,30	0,32	0,40
		0,14	0,012	0,012	0,013	0,016
K6	ONMU090520ANTN-M15 MK2050	3,5	0,34	0,34	0,34	0,44
		0,14	0,013	0,013	0,013	0,017
K7	ONMU090520ANTN-M15 MK2050	3,5	0,30	0,30	0,32	0,40
		0,14	0,012	0,012	0,013	0,016
N1	ONMU090520ANTN-ME12 F40M	3,5	0,34	0,34	0,34	0,44
		0,14	0,013	0,013	0,013	0,017
N2	ONMU090520ANTN-ME12 F40M	3,5	0,34	0,34	0,34	0,44
		0,14	0,013	0,013	0,013	0,017
N3	ONMU090520ANTN-ME12 F40M	3,5	0,34	0,34	0,34	0,44
		0,14	0,013	0,013	0,013	0,017
N11	ONMU090520ANTN-ME12 F40M	3,5	0,34	0,34	0,34	0,44
		0,14	0,013	0,013	0,013	0,017
S1	ONMU090520ANTN-M12 MS2500	2,0	0,20	0,20	0,22	0,26
		0,080	0,0080	0,0080	0,0085	0,010
S2	ONMU090520ANTN-M12 MS2500	2,0	0,20	0,20	0,22	0,26
		0,080	0,0080	0,0080	0,0085	0,010
S3	ONMU090520ANTN-M12 MS2500	2,0	0,19	0,19	0,20	0,25
		0,080	0,0075	0,0075	0,0080	0,010
S11	ONMU090520ANTN-ME13 MS2050	2,5	0,20	0,20	0,22	0,26
		0,10	0,0080	0,0080	0,0085	0,010
S12	ONMU090520ANTN-ME13 MS2050	2,5	0,20	0,20	0,22	0,26
		0,10	0,0080	0,0080	0,0085	0,010
S13	ONMU090520ANTN-ME13 MS2050	2,0	0,19	0,19	0,20	0,24
		0,080	0,0075	0,0075	0,0080	0,0095
H5	ONMU090520ANTN-M15 MP3000	3,0	0,24	0,24	0,24	0,30
		0,12	0,0095	0,0095	0,0095	0,012
H8	ONMU090520ANTN-M15 MP3000	2,5	0,19	0,19	0,19	0,24
		0,10	0,0075	0,0075	0,0075	0,0095
H11	ONMU090520ANTN-MD16 MP1501	3,0	0,28	0,28	0,28	0,34
		0,12	0,011	0,011	0,011	0,013
H12	ONMU090520ANTN-MD16 MP1501	2,5	0,22	0,22	0,22	0,28
		0,10	0,0085	0,0085	0,0085	0,011
H21	ONMU090520ANTN-MD16 MP1501	2,5	0,22	0,22	0,22	0,28
		0,10	0,0085	0,0085	0,0085	0,011

SMG = Seco material group
 f_z = mm/tooth (in/tooth), v_c = m/min (sf/min), a_p/DC = %
 All cutting data are start values

R217/220.48-09 – Cutting data $v_c = (m/min)/(sf/min)$

SMG	MK1500				MP1501				MP2501				T350M				MM4500			
	100%	80%	60%	40%	100%	80%	60%	40%	100%	80%	60%	40%	100%	80%	60%	40%	100%	80%	60%	40%
P1	—	—	—	—	295	315	345	385	265	280	305	340	230	245	265	295	160	175	185	210
	—	—	—	—	970	1025	1125	1275	870	920	1000	1125	750	800	870	970	520	570	610	690
P2	—	—	—	—	290	310	335	375	255	275	295	330	225	240	260	290	155	170	180	205
	—	—	—	—	950	1025	1100	1225	840	900	970	1075	740	790	850	950	510	560	590	670
P3	—	—	—	—	255	270	295	320	225	240	260	285	195	210	225	250	140	150	160	175
	—	—	—	—	840	890	970	1050	740	790	850	940	640	690	740	820	460	490	520	570
P4	—	—	—	—	225	240	260	290	200	210	230	255	175	185	200	220	120	130	140	155
	—	—	—	—	740	790	850	950	660	690	750	840	570	610	660	720	395	425	460	510
P5	—	—	—	—	220	235	250	275	195	205	225	245	170	180	195	210	120	125	135	150
	—	—	—	—	720	770	820	900	640	670	740	800	560	590	640	690	395	410	445	490
P6	—	—	—	—	245	260	285	310	215	230	250	275	190	200	220	240	135	140	155	170
	—	—	—	—	800	850	940	1025	710	750	820	900	620	660	720	790	445	460	510	560
P7	—	—	—	—	230	245	265	290	205	220	235	260	180	190	205	225	125	135	145	160
	—	—	—	—	750	800	870	950	670	720	770	850	590	620	670	740	410	445	475	520
P8	—	—	—	—	215	230	245	270	190	200	220	240	165	175	190	210	115	125	135	145
	—	—	—	—	710	750	800	890	620	660	720	790	540	570	620	690	375	410	445	475
P11	—	—	—	—	225	240	260	285	200	215	230	250	175	185	200	220	120	130	140	155
	—	—	—	—	740	790	850	940	660	710	750	820	570	610	660	720	395	425	460	510
P12	—	—	—	—	145	155	170	185	130	140	150	165	115	120	130	145	80	85	90	100
	—	—	—	—	475	510	560	610	425	460	490	540	375	395	425	475	260	280	295	330
M1	—	—	—	—	—	—	—	—	185	195	215	240	170	185	200	220	135	145	155	175
	—	—	—	—	—	—	—	—	610	640	710	790	560	610	660	720	445	475	510	570
M2	—	—	—	—	—	—	—	—	155	165	180	195	145	155	165	185	115	120	130	145
	—	—	—	—	—	—	—	—	510	540	590	640	475	510	540	610	375	395	425	475
M3	—	—	—	—	—	—	—	—	125	135	145	155	115	125	135	145	90	95	105	115
	—	—	—	—	—	—	—	—	410	445	475	510	375	410	445	475	295	310	345	375
M4	—	—	—	—	—	—	—	—	95	105	110	120	90	95	105	115	70	75	80	90
	—	—	—	—	—	—	—	—	310	345	360	395	295	310	345	375	230	245	260	295
M5	—	—	—	—	—	—	—	—	80	85	90	100	75	80	85	95	60	65	65	75
	—	—	—	—	—	—	—	—	260	280	295	330	245	260	280	310	195	215	215	245
K1	290	305	330	370	230	245	265	295	205	215	235	260	175	190	205	230	—	—	—	—
	950	1000	1075	1225	750	800	870	970	670	710	770	850	570	620	670	750	—	—	—	—
K2	260	280	300	330	205	220	240	260	185	195	210	230	160	170	185	200	—	—	—	—
	850	920	980	1075	670	720	790	850	610	640	690	750	520	560	610	660	—	—	—	—
K3	220	235	255	275	175	185	200	220	155	165	180	195	135	145	155	170	—	—	—	—
	720	770	840	900	570	610	660	720	510	540	590	640	445	475	510	560	—	—	—	—
K4	210	225	240	265	165	180	195	210	150	160	170	185	130	140	150	165	—	—	—	—
	690	740	790	870	540	590	640	690	490	520	560	610	425	460	490	540	—	—	—	—
K5	130	135	145	165	100	110	115	130	90	95	105	115	80	85	90	100	—	—	—	—
	425	445	475	540	330	360	375	425	295	310	345	375	260	280	295	330	—	—	—	—
K6	185	200	215	235	145	155	170	185	130	140	150	165	115	120	130	145	—	—	—	—
	610	660	710	770	475	510	560	610	425	460	490	540	375	395	425	475	—	—	—	—
K7	165	175	190	210	130	140	150	170	115	125	135	150	100	110	115	130	—	—	—	—
	540	570	620	690	425	460	490	560	375	410	445	490	330	360	375	425	—	—	—	—
N1	—	—	—	—	—	—	—	—	—	—	—	—	—	—	—	—	—	—	—	—
	—	—	—	—	—	—	—	—	—	—	—	—	—	—	—	—	—	—	—	—
N2	—	—	—	—	—	—	—	—	—	—	—	—	—	—	—	—	—	—	—	—
	—	—	—	—	—	—	—	—	—	—	—	—	—	—	—	—	—	—	—	—
N3	—	—	—	—	—	—	—	—	—	—	—	—	—	—	—	—	—	—	—	—
	—	—	—	—	—	—	—	—	—	—	—	—	—	—	—	—	—	—	—	—
N11	—	—	—	—	—	—	—	—	—	—	—	—	—	—	—	—	—	—	—	—
	—	—	—	—	—	—	—	—	—	—	—	—	—	—	—	—	—	—	—	—
S1	—	—	—	—	—	—	—	—	47	50	55	60	42	45	48	55	22	23	25	27
	—	—	—	—	—	—	—	—	155	165	180	195	140	150	155	180	70	75	80	90
S2	—	—	—	—	—	—	—	—	38	40	43	48	34	36	39	43	17	19	20	22
	—	—	—	—	—	—	—	—	125	130	140	155	110	120	130	140	55	60	65	70
S3	—	—	—	—	—	—	—	—	33	35	38	42	29	31	34	38	15	16	18	20
	—	—	—	—	—	—	—	—	110	115	125	140	95	100	110	125	49	50	60	65
S11	—	—	—	—	—	—	—	—	65	70	75	85	60	60	65	75	30	32	35	38
	—	—	—	—	—	—	—	—	215	230	245	280	195	195	215	245	100	105	115	125
S12	—	—	—	—	—	—	—	—	45	48	50	55	40	43	47	50	28	29	32	35
	—	—	—	—	—	—	—	—	150	155	165	180	130	140	155	165	90	95	105	115
S13	—	—	—	—	—	—	—	—	26	28	30	33	24	25	27	30	16	17	18	21
	—	—	—	—	—	—	—	—	85	90	100	110	80	80	90	100	50	55	60	70
H5	—	—	—	—	49	50	55	60	39	42	45	50	38	40	43	48	—	—	—	—
	—	—	—	—	160	165	180	195	130	140	150	165	125	130	140	155	—	—	—	—
H8	—	—	—	—	50	55	60	65	42	45	49	55	40	43	47	50	—	—	—	—
	—	—	—	—	165	180	195	215	140	150	160	180	130	140	155	165	—	—	—	—
H11	—	—	—	—	60	65	70	80	50	55	55	65	48	50	55	60	—	—	—	—
	—	—	—	—	195	215	230	260	165	180	180	215	155	165	180	195	—	—	—	—
H12	—	—	—	—	95	100	110	120	80	90	95	105	70	75	85	90	—	—	—	—
	—	—	—	—	310	330	360	395	260	295	310	345	230	245	280	295	—	—	—	—
H21	—	—	—	—	50	55	60	65	42	45	49	55	40	43	47	50	—	—	—	—
	—	—	—	—	165	180	195	215	140	150	160	180	130	140	155	165	—	—	—	—

Square shoulder and slot milling cutters
Helical

R217/220.48-09 – Cutting data $v_c = (m/min)/(sf/min)$

SMG	F40M				MS2050				MP3000				MK2050				MP2050			
	100%	80%	60%	40%	100%	80%	60%	40%	100%	80%	60%	40%	100%	80%	60%	40%	100%	80%	60%	40%
P1	200	215	230	255	225	240	260	285	250	265	290	320	235	250	270	300	260	275	300	335
	660	710	750	840	740	790	850	940	820	870	950	1050	770	820	890	980	850	900	980	1100
P2	195	205	225	250	215	230	245	275	245	260	280	315	225	240	260	290	250	270	290	325
	640	670	740	820	710	750	800	900	800	850	920	1025	740	790	850	950	820	890	950	1075
P3	170	180	195	215	190	200	215	240	215	230	245	270	200	210	230	255	220	235	255	280
	560	590	640	710	620	660	710	790	710	750	800	890	660	690	750	840	720	770	840	920
P4	150	160	175	195	165	175	190	215	190	200	215	240	180	190	205	225	195	210	225	250
	490	520	570	640	540	570	620	710	620	660	710	790	590	620	670	740	640	690	740	820
P5	145	155	170	185	160	175	185	205	185	195	210	230	170	180	195	215	190	205	220	240
	475	510	560	610	520	570	610	670	610	640	690	750	560	590	640	710	620	670	720	790
P6	165	175	190	205	180	195	210	230	205	220	235	260	190	205	220	245	215	230	245	270
	540	570	620	670	590	640	690	750	670	720	770	850	620	670	720	800	710	750	800	890
P7	155	165	180	195	170	185	200	215	195	205	225	245	180	190	205	230	200	215	230	255
	510	540	590	640	560	610	660	710	640	670	740	800	590	620	670	750	660	710	750	840
P8	145	155	165	180	160	170	180	205	180	190	205	225	165	175	190	215	185	200	215	235
	475	510	540	590	520	560	590	670	590	620	670	740	540	570	620	710	610	660	710	770
P11	150	160	175	190	165	180	190	210	190	200	215	235	175	185	200	225	195	210	225	245
	490	520	570	620	540	590	620	690	620	660	710	770	570	610	660	740	640	690	740	800
P12	100	105	115	125	110	115	125	140	125	130	140	155	115	125	135	145	125	135	145	165
	330	345	375	410	360	375	410	460	410	425	460	510	375	410	445	475	410	445	475	540
M1	155	165	180	200	175	185	200	220	180	195	210	235	—	—	—	—	180	190	210	230
	510	540	590	660	570	610	660	720	590	640	690	770	—	—	—	—	590	620	690	750
M2	130	140	150	165	145	155	170	185	155	165	175	195	—	—	—	—	150	160	175	190
	425	460	490	540	475	510	560	610	510	540	570	640	—	—	—	—	490	520	570	620
M3	105	110	120	135	115	125	135	150	120	130	140	155	—	—	—	—	120	130	140	155
	345	360	395	445	375	410	445	490	395	425	460	510	—	—	—	—	395	425	460	510
M4	80	85	95	105	90	95	105	115	95	100	110	120	—	—	—	—	95	100	110	120
	260	280	310	345	295	310	345	375	310	330	360	395	—	—	—	—	310	330	360	395
M5	70	75	80	85	75	80	85	95	80	85	90	100	—	—	—	—	80	85	90	100
	230	245	260	280	245	260	280	310	260	280	295	330	—	—	—	—	260	280	295	330
K1	155	165	175	200	—	—	—	—	190	205	220	250	245	260	280	310	—	—	—	—
	510	540	570	660	—	—	—	—	620	670	720	820	800	850	920	1025	—	—	—	—
K2	140	150	160	175	—	—	—	—	175	185	200	220	220	235	255	280	—	—	—	—
	460	490	520	570	—	—	—	—	570	610	660	720	720	770	840	920	—	—	—	—
K3	120	125	135	150	—	—	—	—	145	155	170	185	185	200	215	235	—	—	—	—
	395	410	445	490	—	—	—	—	475	510	560	610	610	660	710	770	—	—	—	—
K4	110	120	130	140	—	—	—	—	140	150	160	175	175	190	205	225	—	—	—	—
	360	395	425	460	—	—	—	—	460	490	520	570	570	620	670	740	—	—	—	—
K5	70	75	80	90	—	—	—	—	85	90	100	110	110	115	125	140	—	—	—	—
	230	245	260	295	—	—	—	—	280	295	330	360	360	375	410	460	—	—	—	—
K6	100	105	115	125	—	—	—	—	125	130	145	155	155	165	180	200	—	—	—	—
	330	345	375	410	—	—	—	—	410	425	475	510	510	540	590	660	—	—	—	—
K7	90	95	100	110	—	—	—	—	110	115	125	140	140	150	160	175	—	—	—	—
	295	310	330	360	—	—	—	—	360	375	410	460	460	490	520	570	—	—	—	—
S1	38	41	44	48	42	45	49	55	44	47	50	55	—	—	—	—	46	49	55	60
	125	135	145	155	140	150	160	180	145	155	165	180	—	—	—	—	150	160	180	195
S2	31	33	35	39	34	36	39	44	36	38	41	45	—	—	—	—	37	40	42	47
	100	110	115	130	110	120	130	145	120	125	135	150	—	—	—	—	120	130	140	155
S3	27	28	31	34	30	32	34	38	31	33	36	40	—	—	—	—	32	34	38	42
	90	90	100	110	100	105	110	125	100	110	120	130	—	—	—	—	105	110	125	140
S11	55	55	60	65	60	65	70	75	60	65	70	80	—	—	—	—	65	70	75	80
	180	180	195	215	195	215	230	245	195	215	230	260	—	—	—	—	215	230	245	260
S12	37	39	42	47	41	43	47	50	42	45	49	55	—	—	—	—	44	47	50	55
	120	130	140	155	135	140	155	165	140	150	160	180	—	—	—	—	145	155	165	180
S13	22	23	25	27	24	25	27	31	25	27	28	32	—	—	—	—	26	28	30	33
	70	75	80	90	80	80	90	100	80	90	90	105	—	—	—	—	85	90	100	110
H5	33	35	38	42	—	—	—	—	38	41	44	49	—	—	—	—	—	—	—	—
	110	115	125	140	—	—	—	—	125	135	145	160	—	—	—	—	—	—	—	—
H8	35	37	41	44	—	—	—	—	41	43	47	50	—	—	—	—	—	—	—	—
	115	120	135	145	—	—	—	—	135	140	155	165	—	—	—	—	—	—	—	—
H11	42	44	48	55	—	—	—	—	49	50	55	60	—	—	—	—	49	50	55	60
	140	145	155	180	—	—	—	—	160	165	180	195	—	—	—	—	160	165	180	195
H12	60	65	75	80	—	—	—	—	80	85	90	100	—	—	—	—	80	85	95	105
	195	215	245	260	—	—	—	—	260	280	295	330	—	—	—	—	260	280	310	345
H21	35	37	41	44	—	—	—	—	41	43	47	50	—	—	—	—	—	—	—	—
	115	120	135	145	—	—	—	—	135	140	155	165	—	—	—	—	—	—	—	—



QUATTROMILL 09/12/15

QuattroMill™ is more than a general-purpose face mill. It is a simple solution with more teeth per cutter that increases productivity, ease of use, reliability and precision for the full range of face milling applications and materials.

- Insert size 09, cutter range 20-315mm (0.75-3 inch)
- Insert size 12, cutter range 40-315mm (1.5-8 inch)
- Insert size 15, cutter range 63-315mm (3-6 inch)

Square shoulder and
slot milling cutters

Helical milling cutters

Face milling cutters

Disc milling cutters

High feed milling
cutters

Copy milling cutters

Plunge milling cutters

Chamfer milling cutters

Spot facing cutters

Inserts

Quattromill R217.53-09 – Metric

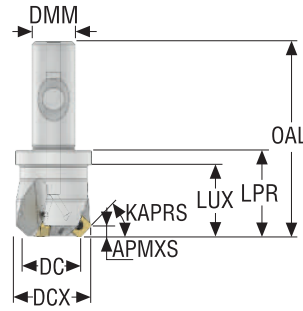

- For insert selection and cutting data recommendations, see page(s) 277-279
- For complete insert programme, see page(s) 844
- For ISO attribute explanation, see page 16

Designation	Item number	Type of mounting	DC	ZEFP	APMXS	KAPRS°	DCX	DMM	LUX	LPR	OAL	Weight	RPMX	Insert
			mm		mm		mm	mm	mm	mm	mm	kg		
R217.53-2020.3S-09-2A	02422248	Seco-Weldon	20,0	2	4,5	45,0	30,0	20,0	33,0	40,0	90,0	0,3	25100	SE.X09T3
R217.53-2025.3S-09-3A	02422250	Seco-Weldon	25,0	3	4,5	45,0	35,0	20,0	33,0	40,0	90,0	0,4	22400	SE.X09T3
R217.53-2032.3S-09-4A	02422251	Seco-Weldon	32,0	4	4,5	45,0	42,0	20,0	33,0	40,0	90,0	0,4	19800	SE.X09T3

Spare Parts, included in delivery

For cutter	Insert key	Insert screw
R217.53..	H4B-T09P	C03008-T09P

Accessories

For cutter	Insert clamping torque	Torque key
	2.0NM	T00-09P20

Torque and fixed keys, see page 894

Quattromill R217.53-09 – inch

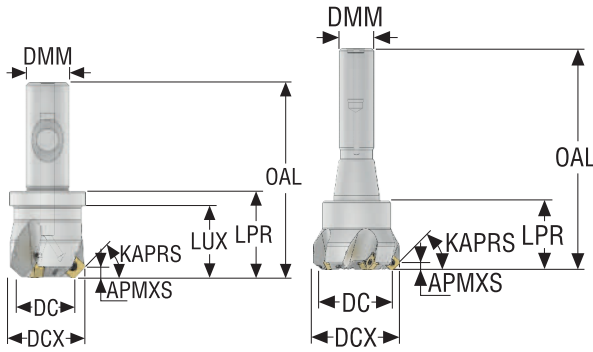

- For insert selection and cutting data recommendations, see page(s) 277-279
- For complete insert programme, see page(s) 844
- For ISO attribute explanation, see page 16

Designation	Item number	Type of mounting	DC	ZEFP	APMXS	KAPRS°	DCX	DMM	LUX	LPR	OAL	Weight	RPMX	Insert
			inch		inch		inch	inch	inch	inch	inch	lbs		
R217.53-00.75.3S-09-2A	02422259	Seco-Weldon	0.787	2	0.177	45,0	1.181	0.750	1.299	1.575	3.543	0.880	25100	SE.X09T3
R217.53-01.00.3S-09-3A	02422260	Seco-Weldon	0.984	3	0.177	45,0	1.378	0.750	1.299	1.575	3.543	0.880	22400	SE.X09T3
R217.53-01.25.3S-09-4A	02422261	Seco-Weldon	1.260	4	0.177	45,0	1.654	0.750	1.299	1.575	3.543	1.100	19800	SE.X09T3
R217.53-02.00.R8-09-5	02422262	Bridgeport R8	1.575	5	0.180	45,0	1.969	0.949	–	1.890	6.024	2.430	15800	SE.X09T3

Spare Parts, included in delivery

For cutter	Insert key	Insert screw
R217.53-...	H4B-T09P	C03008-T09P

Accessories

Insert clamping torque	Torque key
17.7IN.LBS	T00-09P20

Torque and fixed keys, see page 894

Square shoulder and slot milling cutters

Helical milling cutters

Face milling cutters

Disc milling cutters

High feed milling cutters

Copy milling cutters

Plunge milling cutters

Chamfer milling cutters

Spot facing cutters

Inserts

Quattromill R220.53-09 – Metric

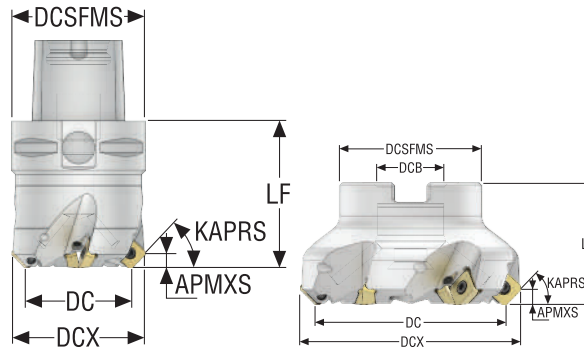

- For insert selection and cutting data recommendations, see page(s) 277-279
- For complete insert programme, see page(s) 844
- For ISO attribute explanation, see page 16

Designation	Item number	Type of mounting	DC	ZEFP	APMXS	KAPRS°	DCX	DCB	DCSFMS	LF	RPMX	Weight	Insert
			mm		mm		mm	mm	mm	mm		kg	
C5-R217.53-040-09-4A	02745046	Seco-Capto	40,0	4	4,5	45,0	50,0	–	50,0	55,0	17700	0,9	SE.X09T3
R220.53-0032-09-4A	02422230	Arbor	32,0	4	4,5	45,0	42,0	16,0	35,0	40,0	19800	0,3	SE.X09T3
R220.53-0040-09-4A	02422231	Arbor	40,0	4	4,5	45,0	50,0	22,0	47,0	40,0	17700	0,4	SE.X09T3
R220.53-0040-09-5A	02422161	Arbor	40,0	5	4,5	45,0	50,0	22,0	47,0	40,0	17700	0,4	SE.X09T3
R220.53-0050-09-5A	02422232	Arbor	50,0	5	4,5	45,0	60,0	22,0	47,0	40,0	15800	0,5	SE.X09T3
R220.53-0050-09-6A	02422162	Arbor	50,0	6	4,5	45,0	60,0	22,0	47,0	40,0	15800	0,5	SE.X09T3
R220.53-0063-09-6A	02422233	Arbor	63,0	6	4,5	45,0	73,0	22,0	47,0	40,0	14100	0,6	SE.X09T3
R220.53-0063-09-7A	02422163	Arbor	63,0	7	4,5	45,0	73,0	22,0	47,0	40,0	14100	0,6	SE.X09T3
R220.53-0080-09-6A	02422234	Arbor	80,0	6	4,5	45,0	90,0	27,0	62,0	50,0	12500	1,2	SE.X09T3
R220.53-0080-09-8A	02422164	Arbor	80,0	8	4,5	45,0	90,0	27,0	62,0	50,0	12500	1,2	SE.X09T3
R220.53-0100-09-7A	02422235	Arbor	100,0	7	4,5	45,0	110,0	32,0	77,0	50,0	11200	1,8	SE.X09T3
R220.53-0100-09-10A	02422165	Arbor	100,0	10	4,5	45,0	110,0	32,0	77,0	50,0	11200	1,8	SE.X09T3

Spare Parts, included in delivery

For cutter	Arbor screw	Insert key	Insert screw
C5-R217.53-..	–	H4B-T09P	C03008-T09P
R220.53-0032	220.17-690	H4B-T09P	C03008-T09P
R220.53-0040-0063	220.17-696	H4B-T09P	C03008-T09P
R220.53-0080-0100	–	H4B-T09P	C03008-T09P

Accessories

For cutter	Insert clamping torque	Torque key
C5-R217/220.53-..	2.0NM	T00-09P20

Torque and fixed keys, see page 894

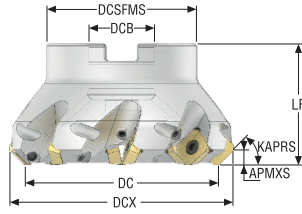

Quattromill R220.53-09 – inch





- For insert selection and cutting data recommendations, see page(s) 277-279
- For complete insert programme, see page(s) 844
- For ISO attribute explanation, see page 16

Designation	Item number	Type of mounting	DC	ZEFP	APMXS	KAPRS*	DCX	DCB	DCSFMS	LF	RPMX	Weight	Insert
			inch		inch		inch	inch	inch	inch		lbs	
R220.53-01.50-09-4A	02422254	Arbor	1.575	4	0.180	45,0	1.969	0.750	1.850	1.575	17700	1.100	SE.X09T3
R220.53-02.00-09-5A	02422255	Arbor	1.969	5	0.180	45,0	2.362	0.750	1.850	1.575	15800	1.320	SE.X09T3
R220.53-02.50-09-6A	02422256	Arbor	2.480	6	0.180	45,0	2.874	0.750	1.850	1.575	14100	1.540	SE.X09T3
R220.53-03.00-09-6A	02422257	Arbor	3.150	6	0.180	45,0	3.543	1.000	2.441	1.969	12500	3.530	SE.X09T3

Spare Parts, included in delivery

For cutter	Arbor screw	Insert key	Insert screw
			
R220.53-01.50	220.17-698	H4B-T09P	C03008-T09P
R220.53-02.00	220.17-698	H4B-T09P	C03008-T09P
R220.53-02.50	220.17-698	H4B-T09P	C03008-T09P
R220.53-03.00	UC6S1/2UNFX1-1/4	H4B-T09P	C03008-T09P

Accessories

For cutter	Insert clamping torque	Torque key
		
R220.53--	17.7IN.LBS	T00-09P20

Torque and fixed keys, see page 894

Square shoulder and slot milling cutters

Helical milling cutters

Face milling cutters

Disc milling cutters

High feed milling cutters

Copy milling cutters

Plunge milling cutters

Chamfer milling cutters

Spot facing cutters

Inserts

Quattromill R220.53-09C – Metric

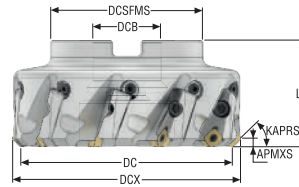

- For insert selection and cutting data recommendations, see page(s) 277-279
- For complete insert programme, see page(s) 844
- For ISO attribute explanation, see page 16

Designation	Item number	Type of mounting	DC	ZEFP	APMXS	KAPRS°	DCX	DCB	DCSFMS	LF	RPMX	Weight	Insert
			mm		mm		mm	mm	mm	mm		kg	
R220.53-0080-09-5C	02510157	Arbor	80,0	5	4,5	45,0	90,0	27,0	62,0	50,0	7400	1,7	SE.X09T3
R220.53-0080-09-6C	02510183	Arbor	80,0	6	4,5	45,0	90,0	27,0	62,0	50,0	7400	1,7	SE.X09T3
R220.53-0100-09-6C	02510181	Arbor	100,0	6	4,5	45,0	110,0	32,0	77,0	50,0	6600	2,5	SE.X09T3
R220.53-0100-09-8C	02510185	Arbor	100,0	8	4,5	45,0	110,0	32,0	77,0	50,0	6600	2,6	SE.X09T3
R220.53-0125-09-8C	02510182	Arbor	125,0	8	4,5	45,0	135,0	40,0	90,0	63,0	5900	4,2	SE.X09T3
R220.53-0125-09-10C	02510190	Arbor	125,0	10	4,5	45,0	135,0	40,0	90,0	63,0	5900	4,2	SE.X09T3
R220.53-8160-09-10C	02510158	Arbor	160,0	10	4,5	45,0	170,0	40,0	90,0	63,0	5200	6,6	SE.X09T3
R220.53-8160-09-14C	02510228	Arbor	160,0	14	4,5	45,0	170,0	40,0	90,0	63,0	5200	6,6	SE.X09T3
R220.53-8200-09-8C	02510192	Arbor	200,0	8	4,5	45,0	210,0	60,0	130,0	63,0	4700	9,4	SE.X09T3
R220.53-8250-09-10C	02510229	Arbor	250,0	10	4,5	45,0	260,0	60,0	130,0	63,0	4200	17,1	SE.X09T3
R220.53-8250-09-16C	02510226	Arbor	250,0	16	4,5	45,0	260,0	60,0	130,0	63,0	4200	17,2	SE.X09T3
R220.53-8315-09-12C	02510230	Arbor	315,0	12	4,5	45,0	325,0	60,0	225,0	80,0	3700	32,6	SE.X09T3

Spare Parts, included in delivery

For cutter	Adjustment unit	Cassette	Cassette screw	Insert key	Insert screw
R220.53-0080-0125	AU1114T-T15P	SE09AR-53	FS96018	H4B-T09P	C03008-T09P
R220.53-8160	AU1114T-T15P	SE09AR-53	FS96018	H4B-T09P	C03008-T09P
R220.53-8250-8200	AU1114T-T15P	SE09AR-53	FS96018	H4B-T09P	C03008-T09P
R220.53-8315	AU1114T-T15P	SE09AR-53	FS96018	H4B-T09P	C03008-T09P

Accessories

For cutter	Arbor screw	Arbor screw 2	Insert clamping torque	Key	Setting key	Torque key
R220.53-0080-0125	-	-	2.0NM	H04-4	T15P-4	T00-09P20
R220.53-8160	MC6S12X40	-	2.0NM	H04-4	T15P-4	T00-09P20
R220.53-8250-8200	MC6S16X50	-	2.0NM	H04-4	T15P-4	T00-09P20
R220.53-8315	MC6S16X50	MC6S20X50	2.0NM	H04-4	T15P-4	T00-09P20

Torque and fixed keys, see page 894

R217/220.53-09 – Insert selection – mm/Inch

SMG		a _p	f _z			
			80%	60%	40%	20%
P1	SEMX09T3AFTN-ME06 T350M	2,5	0,17	0,17	0,17	0,22
		0.10	0.0065	0.0065	0.0065	0.0085
P2	SEMX09T3AFTN-ME06 T350M	2,5	0,17	0,17	0,17	0,22
		0.10	0.0065	0.0065	0.0065	0.0085
P3	SEMX09T3AFTN-M08 MP2501	2,5	0,18	0,18	0,19	0,24
		0.10	0.0070	0.0070	0.0075	0.0095
P4	SEMX09T3AFTN-M08 MP2501	2,5	0,18	0,18	0,18	0,22
		0.10	0.0070	0.0070	0.0070	0.0085
P5	SEMX09T3AFTN-M08 MP2501	2,5	0,17	0,17	0,18	0,22
		0.10	0.0065	0.0065	0.0070	0.0085
P6	SEMX09T3AFTN-M08 MP2501	2,5	0,17	0,17	0,18	0,22
		0.10	0.0065	0.0065	0.0070	0.0085
P7	SEMX09T3AFTN-M08 T350M	2,5	0,17	0,17	0,18	0,22
		0.10	0.0065	0.0065	0.0070	0.0085
P8	SEMX09T3AFTN-M08 T350M	2,5	0,18	0,18	0,19	0,24
		0.10	0.0070	0.0070	0.0075	0.0095
P11	SEEX09T3AFTN-M08 T350M	2,5	0,17	0,17	0,18	0,22
		0.10	0.0065	0.0065	0.0070	0.0085
P12	SEEX09T3AFTN-M08 T350M	2,0	0,12	0,12	0,12	0,15
		0.080	0.0048	0.0048	0.0048	0.0060
M1	SEEX09T3AFN-M05 F40M	2,5	0,13	0,13	0,13	0,16
		0.10	0.0050	0.0050	0.0050	0.0065
M2	SEEX09T3AFN-M05 F40M	2,5	0,12	0,12	0,12	0,15
		0.10	0.0048	0.0048	0.0048	0.0060
M3	SEEX09T3AFN-M05 MS2050	2,0	0,095	0,095	0,095	0,12
		0.080	0.0038	0.0038	0.0038	0.0048
M4	SEMX09T3AFTN-ME06 T350M	1,6	0,11	0,11	0,11	0,14
		0.065	0.0044	0.0044	0.0044	0.0055
M5	SEMX09T3AFTN-ME06 T350M	1,6	0,11	0,11	0,11	0,14
		0.065	0.0044	0.0044	0.0044	0.0055
K1	SEEX09T3AFTN-D09 MP1501	2,5	0,24	0,24	0,24	0,30
		0.10	0.0095	0.0095	0.0095	0.012
K2	SEEX09T3AFTN-D09 MP1501	2,5	0,22	0,22	0,22	0,28
		0.10	0.0085	0.0085	0.0085	0.011
K3	SEEX09T3AFTN-M08 MK2050	2,5	0,17	0,17	0,18	0,22
		0.10	0.0065	0.0065	0.0070	0.0085
K4	SEEX09T3AFTN-M08 MK2050	2,5	0,17	0,17	0,18	0,22
		0.10	0.0065	0.0065	0.0070	0.0085
K5	SEEX09T3AFTN-M08 MK2050	2,5	0,16	0,16	0,16	0,20
		0.10	0.0065	0.0065	0.0065	0.0080
K6	SEEX09T3AFTN-M08 MK2050	2,5	0,17	0,17	0,18	0,22
		0.10	0.0065	0.0065	0.0070	0.0085
K7	SEEX09T3AFTN-M08 MK2050	2,5	0,16	0,16	0,16	0,20
		0.10	0.0065	0.0065	0.0065	0.0080
N1	SEEX09T3AFN-E04 H15	2,5	0,16	0,16	0,17	0,20
		0.10	0.0065	0.0065	0.0065	0.0080
N2	SEEX09T3AFN-E04 H15	2,5	0,16	0,16	0,17	0,20
		0.10	0.0065	0.0065	0.0065	0.0080
N3	SEEX09T3AFN-E04 H15	2,5	0,16	0,16	0,17	0,20
		0.10	0.0065	0.0065	0.0065	0.0080
N11	SEEX09T3AFN-E04 H15	2,5	0,16	0,16	0,17	0,20
		0.10	0.0065	0.0065	0.0065	0.0080
S1	SEEX09T3AFTN-ME07 T350M	1,6	0,11	0,11	0,11	0,14
		0.065	0.0044	0.0044	0.0044	0.0055
S2	SEEX09T3AFTN-ME07 T350M	1,6	0,11	0,11	0,11	0,14
		0.065	0.0044	0.0044	0.0044	0.0055
S3	SEEX09T3AFTN-ME07 T350M	1,6	0,10	0,10	0,11	0,13
		0.065	0.0040	0.0040	0.0044	0.0050
S11	SEEX09T3AFN-M05 MS2050	1,9	0,095	0,095	0,095	0,12
		0.075	0.0038	0.0038	0.0038	0.0048
S12	SEEX09T3AFN-M05 MS2050	1,9	0,095	0,095	0,095	0,12
		0.075	0.0038	0.0038	0.0038	0.0048
S13	SEEX09T3AFN-M05 MS2050	1,6	0,085	0,085	0,085	0,10
		0.065	0.0034	0.0034	0.0034	0.0040
H5	SEEX09T3AFTN-D09 MP1501	2,0	0,14	0,14	0,15	0,18
		0.080	0.0055	0.0055	0.0060	0.0070
H8	SEEX09T3AFTN-D09 MP1501	1,9	0,11	0,11	0,11	0,14
		0.075	0.0044	0.0044	0.0044	0.0055
H11	SEEX09T3AFTN-D09 MP1501	2,0	0,14	0,14	0,15	0,18
		0.080	0.0055	0.0055	0.0060	0.0070
H12	SEEX09T3AFTN-D09 MP1501	1,9	0,11	0,11	0,11	0,14
		0.075	0.0044	0.0044	0.0044	0.0055
H21	SEEX09T3AFTN-D09 MP1501	1,9	0,11	0,11	0,11	0,14
		0.075	0.0044	0.0044	0.0044	0.0055

SMG = Seco material group
 f_z = mm/tooth (in/tooth), v_c = m/min (sf/min), a_p/DC = %
 All cutting data are start values

Square shoulder and slot milling cutters
 Helical milling cutters
 Face milling cutters
 Disc milling cutters
 High feed milling cutters
 Copy milling cutters
 Plunge milling cutters
 Chamfer milling cutters
 Spot facing cutters
 Inserts

R217/220.53-09 – Cutting data $v_c = (m/min)/(sf/min)$

SMG	MK1500				MP1501				MP2501				T350M				T25M			
	100%	80%	60%	40%	100%	80%	60%	40%	100%	80%	60%	40%	100%	80%	60%	40%	100%	80%	60%	40%
P1	—	—	—	—	320	340	370	400	295	315	340	380	260	275	295	330	295	315	340	375
	—	—	—	—	1050	1125	1225	1300	970	1025	1125	1250	850	900	970	1075	970	1025	1125	1225
P2	—	—	—	—	305	325	350	390	290	305	330	365	250	270	290	315	285	305	330	365
	—	—	—	—	1000	1075	1150	1275	950	1000	1075	1200	820	890	950	1025	940	1000	1075	1200
P3	—	—	—	—	270	285	310	345	250	270	290	320	220	235	250	280	250	265	290	320
	—	—	—	—	890	940	1025	1125	820	890	950	1050	720	770	820	920	820	870	950	1050
P4	—	—	—	—	235	250	270	300	220	235	255	285	195	205	220	245	220	235	255	280
	—	—	—	—	770	820	890	980	720	770	840	940	640	670	720	800	720	770	840	920
P5	—	—	—	—	225	240	260	290	215	230	245	270	185	200	215	235	215	230	245	270
	—	—	—	—	740	790	850	950	710	750	800	890	610	660	710	770	710	750	800	890
P6	—	—	—	—	260	275	300	325	240	260	280	305	210	225	240	265	240	255	275	300
	—	—	—	—	850	900	980	1075	790	850	920	1000	690	740	790	870	790	840	900	980
P7	—	—	—	—	245	260	280	305	230	245	260	285	200	210	230	250	225	240	260	285
	—	—	—	—	800	850	920	1000	750	800	850	940	660	690	750	820	740	790	850	940
P8	—	—	—	—	225	240	260	290	210	225	245	270	185	195	210	235	210	225	240	270
	—	—	—	—	740	790	850	950	690	740	800	890	610	640	690	770	690	740	790	890
P11	—	—	—	—	240	255	275	295	220	235	255	280	195	205	220	245	220	235	255	275
	—	—	—	—	790	840	900	970	720	770	840	920	640	670	720	800	720	770	840	900
P12	—	—	—	—	155	165	180	195	145	155	165	180	125	135	145	160	140	150	165	180
	—	—	—	—	510	540	590	640	475	510	540	590	410	445	475	520	460	490	540	590
M1	—	—	—	—	—	—	—	—	210	220	240	260	195	205	225	245	230	245	265	295
	—	—	—	—	—	—	—	—	690	720	790	850	640	670	740	800	750	800	870	970
M2	—	—	—	—	—	—	—	—	175	185	200	220	160	170	185	205	195	205	220	240
	—	—	—	—	—	—	—	—	570	610	660	720	520	560	610	670	640	670	720	790
M3	—	—	—	—	—	—	—	—	140	150	160	175	130	140	150	165	155	165	180	195
	—	—	—	—	—	—	—	—	460	490	520	570	425	460	490	540	510	540	590	640
M4	—	—	—	—	—	—	—	—	110	115	125	135	100	110	115	125	120	125	135	150
	—	—	—	—	—	—	—	—	360	375	410	445	330	360	375	410	395	410	445	490
M5	—	—	—	—	—	—	—	—	90	95	105	110	85	90	95	105	100	105	115	125
	—	—	—	—	—	—	—	—	295	310	345	360	280	295	310	345	330	345	375	410
K1	325	345	370	410	240	255	275	310	230	245	260	290	200	210	230	250	—	—	—	—
	1075	1125	1225	1350	790	840	900	1025	750	800	850	950	660	690	750	820	—	—	—	—
K2	290	310	335	365	215	230	245	275	205	220	235	255	180	190	205	225	—	—	—	—
	950	1025	1100	1200	710	750	800	900	670	720	770	840	590	620	670	740	—	—	—	—
K3	245	260	280	310	180	195	210	230	175	185	200	215	150	160	175	190	—	—	—	—
	800	850	920	1025	590	640	690	750	570	610	660	710	490	520	570	620	—	—	—	—
K4	235	250	270	295	175	185	200	220	165	175	190	205	145	155	165	180	—	—	—	—
	770	820	890	970	570	610	660	720	540	570	620	670	475	510	540	590	—	—	—	—
K5	140	150	165	180	105	115	125	135	100	105	115	125	85	95	100	110	—	—	—	—
	460	490	540	590	345	375	410	445	330	345	375	410	280	310	330	360	—	—	—	—
K6	205	220	235	260	150	160	175	195	145	155	165	185	125	135	145	160	—	—	—	—
	670	720	770	850	490	520	570	640	475	510	540	610	410	445	475	520	—	—	—	—
K7	180	195	210	230	135	145	160	175	130	135	145	165	110	120	130	140	—	—	—	—
	590	640	690	750	445	475	520	570	425	445	475	540	360	395	425	460	—	—	—	—
N1	—	—	—	—	—	—	—	—	—	—	—	—	—	—	—	—	—	—	—	—
	—	—	—	—	—	—	—	—	—	—	—	—	—	—	—	—	—	—	—	—
N2	—	—	—	—	—	—	—	—	—	—	—	—	—	—	—	—	—	—	—	—
	—	—	—	—	—	—	—	—	—	—	—	—	—	—	—	—	—	—	—	—
N3	—	—	—	—	—	—	—	—	—	—	—	—	—	—	—	—	—	—	—	—
	—	—	—	—	—	—	—	—	—	—	—	—	—	—	—	—	—	—	—	—
N11	—	—	—	—	—	—	—	—	—	—	—	—	—	—	—	—	—	—	—	—
	—	—	—	—	—	—	—	—	—	—	—	—	—	—	—	—	—	—	—	—
S1	—	—	—	—	—	—	—	—	55	55	60	65	47	50	55	60	—	—	—	—
	—	—	—	—	—	—	—	—	180	180	195	215	155	165	180	195	—	—	—	—
S2	—	—	—	—	—	—	—	—	42	45	49	55	38	41	44	47	—	—	—	—
	—	—	—	—	—	—	—	—	140	150	160	180	125	135	145	155	—	—	—	—
S3	—	—	—	—	—	—	—	—	37	40	43	46	33	36	38	42	—	—	—	—
	—	—	—	—	—	—	—	—	120	130	140	150	110	120	125	140	—	—	—	—
S11	—	—	—	—	—	—	—	—	75	80	85	95	65	70	75	85	—	—	—	—
	—	—	—	—	—	—	—	—	245	260	280	310	215	230	245	280	—	—	—	—
S12	—	—	—	—	—	—	—	—	50	55	60	65	45	48	50	60	—	—	—	—
	—	—	—	—	—	—	—	—	165	180	195	215	150	155	165	195	—	—	—	—
S13	—	—	—	—	—	—	—	—	30	32	34	37	27	28	30	33	—	—	—	—
	—	—	—	—	—	—	—	—	100	105	110	120	90	90	100	110	—	—	—	—
H5	—	—	—	—	50	55	60	65	43	46	50	55	41	44	48	55	—	—	—	—
	—	—	—	—	165	180	195	215	140	150	165	180	135	145	155	180	—	—	—	—
H8	—	—	—	—	55	60	65	70	46	49	55	60	44	47	50	55	—	—	—	—
	—	—	—	—	180	195	215	230	150	160	180	195	145	155	165	180	—	—	—	—
H11	—	—	—	—	65	70	75	80	55	60	65	70	55	55	60	65	—	—	—	—
	—	—	—	—	215	230	245	260	180	195	215	230	180	180	195	215	—	—	—	—
H12	—	—	—	—	100	105	115	125	90	100	105	115	80	85	90	100	—	—	—	—
	—	—	—	—	330	345	375	410	295	330	345	375	260	280	295	330	—	—	—	—
H21	—	—	—	—	55	60	65	70	46	49	55	60	44	47	50	55	—	—	—	—
	—	—	—	—	180	195	215	230	150	160	180	195	145	155	165	180	—	—	—	—

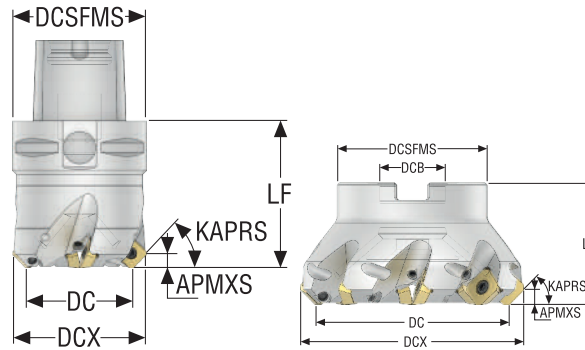

Quattromill R217/220.53-12 – Metric





- For insert selection and cutting data recommendations, see page(s) 287-289
- For complete insert programme, see page(s) 845
- For ISO attribute explanation, see page 16

Designation	Item number	Type of mounting	DC	ZEFP	APMXS	KAPRS°	DCX	DCB	DCSFMS	LF	RPMX	Weight	Insert
			mm		mm		mm	mm	mm	mm		kg	
C5-R217.53-040-12-3A	02745057	Seco-Capto	40,0	3	6,0	45,0	52,0	–	50,0	55,0	16500	0,8	SE.X1204
C6-R217.53-040-12-3A	02745061	Seco-Capto	40,0	3	6,0	45,0	52,0	–	63,0	63,0	16500	1,2	SE.X1204
C5-R217.53-050-12-4A	02745058	Seco-Capto	50,0	4	6,0	45,0	62,0	–	50,0	55,0	14800	0,9	SE.X1204
C6-R217.53-050-12-4A	02745062	Seco-Capto	50,0	4	6,0	45,0	62,0	–	63,0	63,0	14800	1,3	SE.X1204
C5-R217.53-063-12-5A	02745059	Seco-Capto	63,0	5	6,0	45,0	75,0	–	50,0	55,0	13200	1,1	SE.X1204
C6-R217.53-063-12-5A	02745063	Seco-Capto	63,0	5	6,0	45,0	75,0	–	63,0	63,0	13200	1,6	SE.X1204
C5-R217.53-080-12-6A	02745060	Seco-Capto	80,0	6	6,0	45,0	92,0	–	50,0	55,0	11700	1,2	SE.X1204
C6-R217.53-080-12-6A	02745064	Seco-Capto	80,0	6	6,0	45,0	92,0	–	63,0	63,0	11700	1,9	SE.X1204
R220.53-0040-12-4A	02410704	Arbor	40,0	4	6,0	45,0	52,0	22,0	47,0	40,0	16500	0,4	SE.X1204
R220.53-0050-12-4A	00040081	Arbor	50,0	4	6,0	45,0	62,0	22,0	47,0	40,0	14800	0,5	SE.X1204
R220.53-0050-12-5A	00040082	Arbor	50,0	5	6,0	45,0	62,0	22,0	47,0	40,0	14800	0,4	SE.X1204
R220.53-0063-12-5A	00040083	Arbor	63,0	5	6,0	45,0	75,0	22,0	47,0	40,0	13200	0,6	SE.X1204
R220.53-0063-12-6A	00040084	Arbor	63,0	6	6,0	45,0	75,0	22,0	47,0	40,0	13200	0,6	SE.X1204
R220.53-0080-12-6A	00040085	Arbor	80,0	6	6,0	45,0	92,0	27,0	62,0	50,0	11700	1,1	SE.X1204
R220.53-0080-12-8A	00040086	Arbor	80,0	8	6,0	45,0	92,0	27,0	62,0	50,0	11700	1,1	SE.X1204
R220.53-0100-12-5A	02448963	Arbor	100,0	5	6,0	45,0	112,0	32,0	77,0	50,0	10500	1,8	SE.X1204
R220.53-0100-12-7A	00040087	Arbor	100,0	7	6,0	45,0	112,0	32,0	77,0	50,0	10500	1,8	SE.X1204
R220.53-0100-12-10A	00040088	Arbor	100,0	10	6,0	45,0	112,0	32,0	77,0	50,0	10500	1,7	SE.X1204
R220.53-0125-12-6A	02448964	Arbor	125,0	6	6,0	45,0	137,0	40,0	90,0	63,0	9400	3,1	SE.X1204
R220.53-0125-12-8A	00040089	Arbor	125,0	8	6,0	45,0	137,0	40,0	90,0	63,0	9400	3,1	SE.X1204
R220.53-0125-12-12A	00040090	Arbor	125,0	12	6,0	45,0	137,0	40,0	90,0	63,0	9400	2,7	SE.X1204
R220.53-8160-12-7	02448965	Arbor	160,0	7	6,0	45,0	172,0	40,0	90,0	63,0	8300	4,6	SE.X1204
R220.53-8160-12-10	00040091	Arbor	160,0	10	6,0	45,0	172,0	40,0	90,0	63,0	8300	4,6	SE.X1204

Spare Parts, included in delivery

For cutter	Arbor screw	Insert key	Insert screw
			
Cx-R217.53-12	-	H4B-T15P	C04011-T15P
R220.53-0040-0063	220.17-696	H4B-T15P	C04011-T15P
R220.53-0080-0125	-	H4B-T15P	C04011-T15P
R220.53-0080-0125	-	H4B-T15PL	C04011-T15P
R220.53-0080-0125	-	1/4HEX-T15PX90	C04011-T15P
R220.53-8160	-	1/4HEX-T15PX90	C04011-T15P

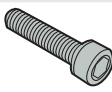
Accessories

For cutter	Adjustable Torque key	Arbor screw	Insert clamping torque	Torque key
				
Cx-R217/220.53-0040-0100	-	-	3.5NM	T00-15P35
R220.53-0125	1/4HEX-S-HANDLE-0.8-5.0NM	-	3.5NM	T00-15P35
R220.53-8160	1/4HEX-S-HANDLE-0.8-5.0NM	MC6S12X40	3.5NM	T00-15P35

Torque and fixed keys, see page 894

Square shoulder and slot milling cutters
Helical milling cutters
Face milling cutters
Disc milling cutters
High feed milling cutters
Copy milling cutters
Plunge milling cutters
Chamfer milling cutters
Spot facing cutters
Inserts

Quattromill R217/220.53-12 – Metric

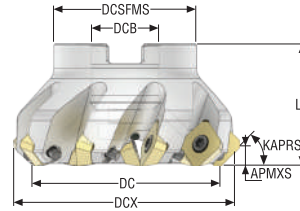

- For insert selection and cutting data recommendations, see page(s) 287-289
- For complete insert programme, see page(s) 845
- For ISO attribute explanation, see page 16

Designation	Item number	Type of mounting	DC	ZFP	APMXS	KAPRS°	DCX	DCB	DCSFMS	LF	RPMX	Weight	Insert
			mm		mm		mm	mm	mm	mm		kg	
R220.53-0063-12-9A	02997159	Arbor	63,0	9	6,0	43,87	75,0	22,0	47,0	40,0	13200	0,6	SE.X1204
R220.53-0080-12-11A	02997160	Arbor	80,0	11	6,0	43,87	92,0	27,0	62,0	50,0	11700	1,1	SE.X1204

Spare Parts, included in delivery

For cutter	Back insert key	Front insert key	Insert screw
R220.53-0063-0080	H6B-H3.0	T15P-E8	C04008-H3

Accessories

For cutter	Insert clamping torque
R220.53-0063-0080	3.5NM

Torque and fixed keys, see page 894

Quattromill R217/220.53-12 – inch

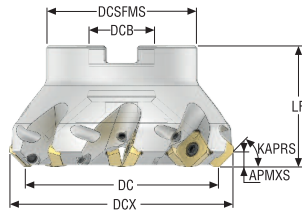

- For insert selection and cutting data recommendations, see page(s) 287-289
- For complete insert programme, see page(s) 845
- For ISO attribute explanation, see page 16

Designation	Item number	Type of mounting	DC	ZEFP	APMXS	KAPRS*	DCX	DCB	DCSFMS	LF	RPMX	Weight	Insert
			inch		inch		inch	inch	inch	inch		lbs	
R220.53-01.50-12-4A	02422139	Arbor	1.575	4	0.236	45.0	2.047	0.750	1.850	1.575	16500	1.100	SE.X1204
R220.53-02.00-12-4A	02422140	Arbor	1.969	4	0.236	45.0	2.441	0.750	1.850	1.575	14800	1.320	SE.X1204
R220.53-02.00-12-5A	02422141	Arbor	1.969	5	0.236	45.0	2.441	0.750	1.850	1.575	14800	1.320	SE.X1204
R220.53-02.50-12-5A	02422142	Arbor	2.480	5	0.236	45.0	2.953	0.750	1.850	1.575	13200	1.320	SE.X1204
R220.53-02.50-12-6A	02422143	Arbor	2.480	6	0.236	45.0	2.953	0.750	1.850	1.575	13200	1.320	SE.X1204
R220.53-03.00-12-6A	02422144	Arbor	3.150	6	0.236	45.0	3.622	1.000	2.441	1.969	11700	3.310	SE.X1204
R220.53-03.00-12-8A	02422145	Arbor	3.150	8	0.236	45.0	3.622	1.000	2.441	1.969	11700	3.310	SE.X1204
R220.53-04.00-12-7A	02422146	Arbor	3.937	7	0.236	45.0	4.409	1.500	3.543	1.969	10500	5.070	SE.X1204
R220.53-04.00-12-10A	02422147	Arbor	3.937	10	0.236	45.0	4.409	1.500	3.543	1.969	10500	4.850	SE.X1204
R220.53-05.00-12-6A	02449819	Arbor	4.921	6	0.236	45.0	5.394	1.500	3.543	2.480	9400	8.380	SE.X1204
R220.53-05.00-12-8A	02422148	Arbor	4.921	8	0.236	45.0	5.394	1.500	3.543	2.480	9400	8.380	SE.X1204
R220.53-06.00-12-10	02422150	Arbor	6.299	10	0.236	45.0	6.772	2.000	3.543	2.480	8300	10.800	SE.X1204
R220.53-06.00-12-7	02449820	Arbor	6.299	7	0.236	45.0	6.772	2.000	3.543	2.480	8300	10.800	SE.X1204
R220.53-06.00-12-16	02449821	Arbor	6.299	16	0.236	45.0	6.772	2.000	3.543	2.480	8300	10.580	SE.X1204
R220.53-808.00-12-12	02422151	Arbor	7.874	12	0.236	45.0	8.346	2.500	5.118	2.480	7400	17.640	SE.X1204

Square shoulder and slot milling cutters

Helical milling cutters

Face milling cutters

Disc milling cutters

High feed milling cutters

Copy milling cutters



Plunge milling cutters

Chamfer milling cutters





Spot facing cutters

Inserts

Spare Parts, included in delivery

For cutter	Arbor screw	Insert key	Insert screw
R220.53-01.50-02.50	 220.17-698	 H4B-T15P	 C04011-T15P
R220.53-03.00	UC6S1/2UNFX1-1/4	H4B-T15P	C04011-T15P
R220.53-04.00	UF6S3/4UNFX1-3/4	H4B-T15PL	C04011-T15P
R220.53-05.00	UF6S3/4UNFX2	1/4HEX-T15PX90	C04011-T15P
R220.53-06.00	-	1/4HEX-T15PX90	C04011-T15P
R220.53-808.00	-	H4B-T15PL	C04011-T15P

Accessories

For cutter	Adjustable Torque key	Arbor screw	Insert clamping torque	Torque key
R220.53-01.50 - 04.00	 -	 -	 31.0IN.LBS	 T00-15P35
R220.53-05.00	1/4HEX-S-HANDLE-0.8-5.0NM	-	31.0IN.LBS	T00-15P35
R220.53-06.00	1/4HEX-S-HANDLE-0.8-5.0NM	58215080	31.0IN.LBS	T00-15P35
R220.53-808.00	-	-	31.0IN.LBS	T00-15P35

Torque and fixed keys, see page 894

Square shoulder and slot milling cutters
Helical milling cutters
Face milling cutters
Disc milling cutters
High feed milling cutters
Copy milling cutters
Plunge milling cutters
Chamfer milling cutters
Spot facing cutters
Inserts

Quattromill R220.53-12C – Metric

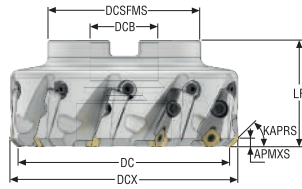

- For insert selection and cutting data recommendations, see page(s) 287-289
- For complete insert programme, see page(s) 845
- For ISO attribute explanation, see page 16

Designation	Item number	Type of mounting	DC	ZEFP	APMXS	KAPRS°	DCX	DCB	DCSFMS	LF	RPMX	Weight	Insert
			mm		mm		mm	mm	mm	mm		kg	
R220.53-0080-12-5C	02448838	Arbor	80,0	5	6,0	45,0	90,0	27,0	62,0	50,0	7400	1,7	SE.X1204
R220.53-0080-12-6C	02448867	Arbor	80,0	6	6,0	45,0	92,0	27,0	62,0	50,0	7400	1,7	SE.X1204
R220.53-0100-12-6C	02448839	Arbor	100,0	6	6,0	45,0	112,0	32,0	77,0	50,0	6600	2,6	SE.X1204
R220.53-0100-12-8C	02448888	Arbor	100,0	8	6,0	45,0	112,0	32,0	77,0	50,0	6600	2,6	SE.X1204
R220.53-0125-12-8C	02448846	Arbor	125,0	8	6,0	45,0	137,0	40,0	90,0	63,0	5900	4,2	SE.X1204
R220.53-0125-12-10C	02448890	Arbor	125,0	10	6,0	45,0	137,0	40,0	90,0	63,0	5900	4,2	SE.X1204
R220.53-8160-12-7C	02510195	Arbor	160,0	7	6,0	45,0	172,0	40,0	90,0	63,0	5200	6,5	SE.X1204
R220.53-8160-12-10C	02448847	Arbor	160,0	10	6,0	45,0	172,0	40,0	90,0	63,0	5200	6,6	SE.X1204
R220.53-8160-12-14C	02448893	Arbor	160,0	14	6,0	45,0	172,0	40,0	90,0	63,0	5200	6,6	SE.X1204
R220.53-8200-12-8C	02448894	Arbor	200,0	8	6,0	45,0	212,0	60,0	130,0	63,0	4700	9,4	SE.X1204
R220.53-8200-12-12C	02448849	Arbor	200,0	12	6,0	45,0	212,0	60,0	130,0	63,0	4700	9,3	SE.X1204
R220.53-8250-12-10C	02448896	Arbor	250,0	10	6,0	45,0	262,0	60,0	130,0	63,0	4200	17,0	SE.X1204
R220.53-8250-12-16C	02448853	Arbor	250,0	16	6,0	45,0	262,0	60,0	130,0	63,0	4200	16,0	SE.X1204
R220.53-8315-12-12C	02448900	Arbor	315,0	12	6,0	45,0	327,0	60,0	225,0	80,0	3700	32,9	SE.X1204

Square shoulder and slot milling cutters

Helical milling cutters

Face milling cutters

Disc milling cutters

High feed milling cutters

Copy milling cutters

Plunge milling cutters

Chamfer milling cutters

Spot facing cutters

Inserts

Spare Parts, included in delivery

For cutter	Adjustment unit	Cassette	Cassette screw	Insert key	Insert screw
R220.53-0080-0125	AU1114T-T15P	SE12AR-53	FS96018	H4B-T15P	C04009-T15P
R220.53-0080-0125	AU1114T-T15P	SE12AR-53	FS96018	H4B-T15PL	C04009-T15P
R220.53-8160	AU1114T-T15P	SE12AR-53	FS96018	H4B-T15PL	C04009-T15P
R220.53-8200-8250	AU1114T-T15P	SE12AR-53	FS96018	H4B-T15PL	C04009-T15P
R220.53-8315	AU1114T-T15P	SE12AR-53	FS96018	H4B-T15PL	C04009-T15P

Accessories

For cutter	Arbor screw	Arbor screw 2	Insert clamping torque	Key	Setting key	Torque key
R220.53-0080-0125	-	-	3.5NM	H04-4	T15P-4	T00-15P35
R220.53-8160	MC6S12X40	-	3.5NM	H04-4	T15P-4	T00-15P35
R220.53-8200-8250	MC6S16X50	-	3.5NM	H04-4	T15P-4	T00-15P35
R220.53-8315	MC6S16X50	MC6S20X50	3.5NM	H04-4	T15P-4	T00-15P35

Torque and fixed keys, see page 894

Square shoulder and slot milling cutters
Helical milling cutters
Face milling cutters
Disc milling cutters
High feed milling cutters
Copy milling cutters
Plunge milling cutters
Chamfer milling cutters
Spot facing cutters
Inserts

R217/220.53-12 – Insert selection – mm/Inch

SMG		a _p	f _z			
			80%	60%	40%	20%
P1	SEMX1204AFTN-ME12 T350M	3,5 0.14	0,25 0.010	0,25 0.010	0,25 0.010	0,32 0.013
P2	SEMX1204AFTN-ME12 T350M	3,5 0.14	0,25 0.010	0,25 0.010	0,26 0.010	0,32 0.013
P3	SEMX1204AFTN-M15 MP2501	3,5 0.14	0,30 0.012	0,30 0.012	0,32 0.013	0,38 0.015
P4	SEMX1204AFTN-M15 MP2501	3,5 0.14	0,30 0.012	0,30 0.012	0,30 0.012	0,38 0.015
P5	SEMX1204AFTN-M15 MP2501	3,5 0.14	0,28 0.011	0,28 0.011	0,30 0.012	0,38 0.015
P6	SEMX1204AFTN-M15 MP2501	3,5 0.14	0,28 0.011	0,28 0.011	0,30 0.012	0,36 0.014
P7	SEMX1204AFTN-M15 MP2501	3,5 0.14	0,28 0.011	0,28 0.011	0,30 0.012	0,36 0.014
P8	SEEX1204AFTN-M14 T350M	3,5 0.14	0,30 0.012	0,30 0.012	0,32 0.013	0,38 0.015
P11	SEEX1204AFN-M10 MM4500	3,5 0.14	0,20 0.0080	0,20 0.0080	0,22 0.0085	0,26 0.010
P12	SEEX1204AFN-M10 MM4500	3,0 0.12	0,14 0.0055	0,14 0.0055	0,15 0.0060	0,18 0.0070
M1	SEEX1204AFN-M10 F40M	3,5 0.14	0,22 0.0085	0,22 0.0085	0,24 0.0095	0,30 0.012
M2	SEEX1204AFN-M10 F40M	3,5 0.14	0,20 0.0080	0,20 0.0080	0,22 0.0085	0,26 0.010
M3	SEEX1204AFN-M10 MS2050	3,0 0.12	0,17 0.0065	0,17 0.0065	0,17 0.0065	0,22 0.0085
M4	SEEX1204AFN-M10 MM4500	2,0 0.080	0,16 0.0065	0,16 0.0065	0,16 0.0065	0,20 0.0080
M5	SEEX1204AFN-M10 MM4500	2,0 0.080	0,16 0.0065	0,16 0.0065	0,16 0.0065	0,20 0.0080
K1	SEMX1204AFTN-M15 MK1500	3,5 0.14	0,32 0.013	0,32 0.013	0,32 0.013	0,40 0.016
K2	SEMX1204AFTN-M15 MK1500	3,5 0.14	0,28 0.011	0,28 0.011	0,30 0.012	0,38 0.015
K3	SEMX1204AFTN-M15 MP1501	3,5 0.14	0,28 0.011	0,28 0.011	0,30 0.012	0,38 0.015
K4	SEMX1204AFTN-M15 MP1501	3,5 0.14	0,28 0.011	0,28 0.011	0,30 0.012	0,38 0.015
K5	SEMX1204AFTN-M15 MP1501	3,5 0.14	0,26 0.010	0,26 0.010	0,26 0.010	0,34 0.013
K6	SEMX1204AFTN-M15 MK2050	3,5 0.14	0,28 0.011	0,28 0.011	0,30 0.012	0,38 0.015
K7	SEMX1204AFTN-M15 MK2050	3,5 0.14	0,26 0.010	0,26 0.010	0,26 0.010	0,34 0.013
N1	SEEX1204AFN-E08 H25	3,5 0.14	0,24 0.0095	0,24 0.0095	0,24 0.0095	0,30 0.012
N2	SEEX1204AFN-E08 H25	3,5 0.14	0,24 0.0095	0,24 0.0095	0,24 0.0095	0,30 0.012
N3	SEEX1204AFN-E08 H25	3,5 0.14	0,24 0.0095	0,24 0.0095	0,24 0.0095	0,30 0.012
N11	SEEX1204AFN-E08 H25	3,5 0.14	0,24 0.0095	0,24 0.0095	0,24 0.0095	0,30 0.012
S1	SEEX1204AFTN-ME11 T350M	2,0 0.080	0,17 0.0065	0,17 0.0065	0,18 0.0070	0,22 0.0085
S2	SEEX1204AFTN-ME11 T350M	2,0 0.080	0,17 0.0065	0,17 0.0065	0,18 0.0070	0,22 0.0085
S3	SEEX1204AFTN-ME11 T350M	2,0 0.080	0,16 0.0065	0,16 0.0065	0,16 0.0065	0,20 0.0080
S11	SEEX1204AFN-M10 MS2050	2,5 0.10	0,17 0.0065	0,17 0.0065	0,18 0.0070	0,22 0.0085
S12	SEEX1204AFN-M10 MS2050	2,5 0.10	0,17 0.0065	0,17 0.0065	0,18 0.0070	0,22 0.0085
S13	SEEX1204AFN-M10 MS2050	2,0 0.080	0,16 0.0065	0,16 0.0065	0,16 0.0065	0,20 0.0080
H5	SEMX1204AFTN-MD19 MP3000	3,0 0.12	0,24 0.0095	0,24 0.0095	0,25 0.010	0,30 0.012
H8	SEMX1204AFTN-MD19 MP3000	2,5 0.10	0,19 0.0075	0,19 0.0075	0,20 0.0080	0,24 0.0095
H11	SEMX1204AFTN-MD19 MP1501	3,0 0.12	0,24 0.0095	0,24 0.0095	0,25 0.010	0,30 0.012
H12	SEMX1204AFTN-MD19 MP1501	2,5 0.10	0,19 0.0075	0,19 0.0075	0,20 0.0080	0,24 0.0095
H21	SEMX1204AFTN-MD19 MP1501	2,5 0.10	0,19 0.0075	0,19 0.0075	0,20 0.0080	0,24 0.0095

SMG = Seco material group
f_z = mm/tooth (in/tooth), v_c = m/min (sf/min), a_p/DC = %
All cutting data are start values

Square shoulder and slot milling cutters
Helical milling cutters
Face milling cutters
Disc milling cutters
High feed milling cutters
Copy milling cutters
Plunge milling cutters
Chamfer milling cutters
Spot facing cutters
Inserts

R217/220.53-12 – Cutting data $v_c = (m/min)/(sf/min)$

SMG	MK1500				MP1501				MP2501				T350M				MM4500			
	100%	80%	60%	40%	100%	80%	60%	40%	100%	80%	60%	40%	100%	80%	60%	40%	100%	80%	60%	40%
P1	—	—	—	—	305	325	350	395	270	290	310	350	235	250	270	305	195	210	225	245
	—	—	—	—	1000	1075	1150	1300	890	950	1025	1150	770	820	890	1000	640	690	740	800
P2	—	—	—	—	300	315	340	385	265	280	305	340	230	245	265	295	190	200	215	240
	—	—	—	—	980	1025	1125	1275	870	920	1000	1125	750	800	870	970	620	660	710	790
P3	—	—	—	—	260	280	300	335	230	245	265	300	200	215	230	260	165	175	190	210
	—	—	—	—	850	920	980	1100	750	800	870	980	660	710	750	850	540	570	620	690
P4	—	—	—	—	230	245	265	295	205	215	235	260	180	190	205	230	145	155	165	185
	—	—	—	—	750	800	870	970	670	710	770	850	590	620	670	750	475	510	540	610
P5	—	—	—	—	225	240	260	280	200	210	230	250	175	185	200	220	140	150	160	175
	—	—	—	—	740	790	850	920	660	690	750	820	570	610	660	720	460	490	520	570
P6	—	—	—	—	250	270	290	315	225	240	255	280	195	205	225	245	160	170	180	200
	—	—	—	—	820	890	950	1025	740	790	840	920	640	670	740	800	520	560	590	660
P7	—	—	—	—	240	255	275	300	210	225	240	265	185	195	210	230	150	160	170	185
	—	—	—	—	790	840	900	980	690	740	790	870	610	640	690	750	490	520	560	610
P8	—	—	—	—	220	235	255	280	195	205	225	250	170	180	195	220	140	145	160	175
	—	—	—	—	720	770	840	920	640	670	740	820	560	590	640	720	460	475	520	570
P11	—	—	—	—	230	245	265	290	205	220	235	260	180	190	205	225	145	155	165	180
	—	—	—	—	750	800	870	950	670	720	770	850	590	620	670	740	475	510	540	590
P12	—	—	—	—	150	160	175	195	135	145	155	170	115	125	135	150	95	100	110	120
	—	—	—	—	490	520	570	640	445	475	510	560	375	410	445	490	310	330	360	395
M1	—	—	—	—	—	—	—	—	190	200	220	245	175	190	205	230	160	170	185	205
	—	—	—	—	—	—	—	—	620	660	720	800	570	620	670	750	520	560	610	670
M2	—	—	—	—	—	—	—	—	160	170	185	200	150	160	170	190	135	145	155	170
	—	—	—	—	—	—	—	—	520	560	610	660	490	520	560	620	445	475	510	560
M3	—	—	—	—	—	—	—	—	130	135	145	165	120	125	135	155	110	115	125	140
	—	—	—	—	—	—	—	—	425	445	475	540	395	410	445	510	360	375	410	460
M4	—	—	—	—	—	—	—	—	100	105	115	125	95	100	105	120	85	90	95	105
	—	—	—	—	—	—	—	—	330	345	375	410	310	330	345	395	280	295	310	345
M5	—	—	—	—	—	—	—	—	85	90	95	105	80	80	90	100	70	75	80	90
	—	—	—	—	—	—	—	—	280	295	310	345	260	260	295	330	230	245	260	295
K1	295	315	340	380	235	250	270	305	210	220	240	270	180	195	210	235	—	—	—	—
	970	1025	1125	1250	770	820	890	1000	690	720	790	890	590	640	690	770	—	—	—	—
K2	270	285	310	335	215	225	245	270	190	200	215	235	165	175	190	205	—	—	—	—
	890	940	1025	1100	710	740	800	890	620	660	710	770	540	570	620	670	—	—	—	—
K3	225	240	260	285	180	190	205	225	160	170	185	200	140	150	160	175	—	—	—	—
	740	790	850	940	590	620	670	740	520	560	610	660	460	490	520	570	—	—	—	—
K4	215	230	250	270	170	185	200	215	155	160	175	190	135	140	155	165	—	—	—	—
	710	750	820	890	560	610	660	710	510	520	570	620	445	460	510	540	—	—	—	—
K5	130	140	150	170	105	110	120	135	95	100	105	120	80	85	95	105	—	—	—	—
	425	460	490	560	345	360	395	445	310	330	345	395	260	280	310	345	—	—	—	—
K6	190	205	220	240	150	160	175	190	135	145	155	170	115	125	135	145	—	—	—	—
	620	670	720	790	490	520	570	620	445	475	510	560	375	410	445	475	—	—	—	—
K7	170	180	195	215	135	145	155	170	120	125	135	155	105	110	120	135	—	—	—	—
	560	590	640	710	445	475	510	560	395	410	445	510	345	360	395	445	—	—	—	—
N1	—	—	—	—	—	—	—	—	—	—	—	—	—	—	—	—	—	—	—	—
	—	—	—	—	—	—	—	—	—	—	—	—	—	—	—	—	—	—	—	—
N2	—	—	—	—	—	—	—	—	—	—	—	—	—	—	—	—	—	—	—	—
	—	—	—	—	—	—	—	—	—	—	—	—	—	—	—	—	—	—	—	—
N3	—	—	—	—	—	—	—	—	—	—	—	—	—	—	—	—	—	—	—	—
	—	—	—	—	—	—	—	—	—	—	—	—	—	—	—	—	—	—	—	—
N11	—	—	—	—	—	—	—	—	—	—	—	—	—	—	—	—	—	—	—	—
	—	—	—	—	—	—	—	—	—	—	—	—	—	—	—	—	—	—	—	—
S1	—	—	—	—	—	—	—	—	49	50	55	60	43	46	49	55	26	27	29	33
	—	—	—	—	—	—	—	—	160	165	180	195	140	150	160	180	85	90	95	110
S2	—	—	—	—	—	—	—	—	39	42	45	49	35	37	40	44	21	22	24	26
	—	—	—	—	—	—	—	—	130	140	150	160	115	120	130	145	70	70	80	85
S3	—	—	—	—	—	—	—	—	35	37	39	44	31	33	35	39	18	19	21	23
	—	—	—	—	—	—	—	—	115	120	130	145	100	110	115	130	60	60	70	75
S11	—	—	—	—	—	—	—	—	70	70	80	85	60	65	70	75	36	38	42	46
	—	—	—	—	—	—	—	—	230	230	260	280	195	215	230	245	120	125	140	150
S12	—	—	—	—	—	—	—	—	47	50	55	60	42	45	48	55	33	35	38	42
	—	—	—	—	—	—	—	—	155	165	180	195	140	150	155	180	110	115	125	140
S13	—	—	—	—	—	—	—	—	27	29	31	35	24	26	28	31	19	21	22	24
	—	—	—	—	—	—	—	—	90	95	100	115	80	85	90	100	60	70	70	80
H5	—	—	—	—	50	55	60	65	40	43	46	50	39	41	45	50	—	—	—	—
	—	—	—	—	165	180	195	215	130	140	150	165	130	135	150	165	—	—	—	—
H8	—	—	—	—	55	55	65	70	43	46	50	55	41	44	48	55	—	—	—	—
	—	—	—	—	180	180	215	230	140	150	165	180	135	145	155	180	—	—	—	—
H11	—	—	—	—	65	70	75	80	50	55	60	65	49	55	55	65	—	—	—	—
	—	—	—	—	215	230	245	260	165	180	195	215	160	180	180	215	—	—	—	—
H12	—	—	—	—	95	105	110	120	85	90	100	110	75	80	85	95	—	—	—	—
	—	—	—	—	310	345	360	395	280	295	330	360	245	260	280	310	—	—	—	—
H21	—	—	—	—	55	55	65	70	43	46	50	55	41	44	48	55	—	—	—	—
	—	—	—	—	180	180	215	230	140	150	165	180	135	145	155	180	—	—	—	—

R217/220.53-12 – Cutting data $v_c = (m/min)/(sf/min)$

SMG	F40M				MS2050				MP3000				MK2050				H25			
	80%	60%	40%	20%	80%	60%	40%	20%	80%	60%	40%	20%	80%	60%	40%	20%	80%	60%	40%	20%
P1	220	235	265	300	270	290	325	365	305	330	370	415	285	305	345	390	—	—	—	—
	720	770	870	980	890	950	1075	1200	1000	1075	1225	1350	940	1000	1125	1275	—	—	—	—
P2	210	230	255	290	265	285	310	355	300	325	350	405	275	300	335	375	—	—	—	—
	690	750	840	950	870	940	1025	1175	980	1075	1150	1325	900	980	1100	1225	—	—	—	—
P3	185	200	225	255	225	245	270	305	255	280	310	345	240	260	295	330	—	—	—	—
	610	660	740	840	740	800	890	1000	840	920	1025	1125	790	850	970	1075	—	—	—	—
P4	165	180	200	225	205	220	240	275	235	250	270	310	215	230	260	290	—	—	—	—
	540	590	660	740	670	720	790	900	770	820	890	1025	710	750	850	950	—	—	—	—
P5	160	175	190	215	195	210	230	260	225	240	260	300	210	225	245	280	—	—	—	—
	520	570	620	710	640	690	750	850	740	790	850	980	690	740	800	920	—	—	—	—
P6	180	195	215	245	220	235	255	295	250	270	290	335	235	255	275	315	—	—	—	—
	590	640	710	800	720	770	840	970	820	890	950	1100	770	840	900	1025	—	—	—	—
P7	170	185	200	230	210	225	240	280	235	255	275	315	220	240	260	300	—	—	—	—
	560	610	660	750	690	740	790	920	770	840	900	1025	720	790	850	980	—	—	—	—
P8	155	170	190	215	190	205	230	255	215	235	260	290	205	220	245	275	—	—	—	—
	510	560	620	710	620	670	750	840	710	770	850	950	670	720	800	900	—	—	—	—
P11	165	180	195	225	200	215	235	270	230	245	270	305	215	230	255	290	—	—	—	—
	540	590	640	740	660	710	770	890	750	800	890	1000	710	750	840	950	—	—	—	—
P12	110	115	130	145	130	140	155	175	150	160	175	200	140	150	170	190	—	—	—	—
	360	375	425	475	425	460	510	570	490	520	570	660	460	490	560	620	—	—	—	—
M1	170	185	205	235	210	230	250	285	225	240	260	300	—	—	—	—	—	—	—	—
	560	610	670	770	690	750	820	940	740	790	850	980	—	—	—	—	—	—	—	—
M2	145	155	170	195	175	190	205	235	185	200	215	250	—	—	—	—	—	—	—	—
	475	510	560	640	570	620	670	770	610	660	710	820	—	—	—	—	—	—	—	—
M3	115	125	140	155	140	150	170	190	150	160	180	200	—	—	—	—	—	—	—	—
	375	410	460	510	460	490	560	620	490	520	590	660	—	—	—	—	—	—	—	—
M4	90	95	105	125	110	120	130	150	115	125	140	155	—	—	—	—	—	—	—	—
	295	310	345	410	360	395	425	490	375	410	460	510	—	—	—	—	—	—	—	—
M5	75	80	90	100	90	100	110	125	95	105	115	130	—	—	—	—	—	—	—	—
	245	260	295	330	295	330	360	410	310	345	375	425	—	—	—	—	—	—	—	—
K1	170	180	205	230	—	—	—	—	235	255	280	320	300	320	360	405	—	—	—	—
	560	590	670	750	—	—	—	—	770	840	920	1050	980	1050	1175	1325	—	—	—	—
K2	150	165	180	205	—	—	—	—	210	230	245	285	270	290	320	365	—	—	—	—
	490	540	590	670	—	—	—	—	690	750	800	940	890	950	1050	1200	—	—	—	—
K3	130	140	150	175	—	—	—	—	180	195	210	240	230	245	270	310	—	—	—	—
	425	460	490	570	—	—	—	—	590	640	690	790	750	800	890	1025	—	—	—	—
K4	125	135	145	165	—	—	—	—	170	185	200	230	220	235	255	295	—	—	—	—
	410	445	475	540	—	—	—	—	560	610	660	750	720	770	840	970	—	—	—	—
K5	75	80	90	100	—	—	—	—	105	110	125	140	135	145	160	180	—	—	—	—
	245	260	295	330	—	—	—	—	345	360	410	460	445	475	520	590	—	—	—	—
K6	110	115	130	145	—	—	—	—	150	160	175	200	190	205	225	260	—	—	—	—
	360	375	425	475	—	—	—	—	490	520	570	660	620	670	740	850	—	—	—	—
K7	95	105	115	130	—	—	—	—	130	140	160	180	170	185	205	230	—	—	—	—
	310	345	375	425	—	—	—	—	425	460	520	590	560	610	670	750	—	—	—	—
N1	1225	1325	1475	1700	—	—	—	—	1750	1875	2050	2350	—	—	—	—	1550	1675	1875	2100
	4025	4350	4850	5575	—	—	—	—	5750	6150	6725	7700	—	—	—	—	5075	5500	6150	6900
N2	500	540	590	680	—	—	—	—	700	760	830	950	—	—	—	—	630	680	750	850
	1650	1775	1925	2225	—	—	—	—	2300	2500	2725	3125	—	—	—	—	2075	2225	2450	2800
N3	330	360	395	455	—	—	—	—	470	510	550	630	—	—	—	—	420	450	500	570
	1075	1175	1300	1500	—	—	—	—	1550	1675	1800	2075	—	—	—	—	1375	1475	1650	1875
N11	380	410	455	520	—	—	—	—	530	580	630	720	—	—	—	—	480	520	580	650
	1250	1350	1500	1700	—	—	—	—	1750	1900	2075	2350	—	—	—	—	1575	1700	1900	2125
S1	42	45	50	55	50	55	60	70	55	60	65	75	—	—	—	—	—	—	—	—
	140	150	165	180	165	180	195	230	180	195	215	245	—	—	—	—	—	—	—	—
S2	34	36	40	46	41	44	49	55	43	47	50	60	—	—	—	—	—	—	—	—
	110	120	130	150	135	145	160	180	140	155	165	195	—	—	—	—	—	—	—	—
S3	30	32	36	41	36	39	43	49	38	41	45	50	—	—	—	—	—	—	—	—
	100	105	120	135	120	130	140	160	125	135	150	165	—	—	—	—	—	—	—	—
S11	60	65	70	80	70	75	85	95	75	80	90	100	—	—	—	—	—	—	—	—
	195	215	230	260	230	245	280	310	245	260	295	330	—	—	—	—	—	—	—	—
S12	41	44	49	55	49	55	60	65	50	55	60	70	—	—	—	—	—	—	—	—
	135	145	160	180	160	180	195	215	165	180	195	230	—	—	—	—	—	—	—	—
S13	24	25	28	32	28	31	34	39	30	33	36	41	—	—	—	—	—	—	—	—
	80	80	90	105	90	100	110	130	100	110	120	135	—	—	—	—	—	—	—	—
H5	36	39	43	49	—	—	—	—	46	50	55	60	—	—	—	—	—	—	—	—
	120	130	140	160	—	—	—	—	150	165	180	195	—	—	—	—	—	—	—	—
H8	38	42	46	50	—	—	—	—	50	55	60	65	—	—	—	—	—	—	—	—
	125	140	150	165	—	—	—	—	165	180	195	215	—	—	—	—	—	—	—	—
H11	46	49	55	60	—	—	—	—	60	65	70	80	—	—	—	—	—	—	—	—
	150	160	180	195	—	—	—	—	195	215	230	260	—	—	—	—	—	—	—	—
H12	70	75	80	95	—	—	—	—	95	100	115	125	—	—	—	—	—	—	—	—
	230	245	260	310	—	—	—	—	310	330	375	410	—	—	—	—	—	—	—	—
H21	38	42	46	50	—	—	—	—	50	55	60	65	—	—	—	—	—	—	—	—
	125	140	150	165	—	—	—	—	165	180	195	215	—	—	—	—	—	—	—	—

Square shoulder and slot milling cutters
Helical milling cutters
Face milling cutters
Disc milling cutters
High feed milling cutters
Copy milling cutters
Plunge milling cutters
Chamfer milling cutters
Spot facing cutters
Inserts

Quattromill R220.53-15 – Metric

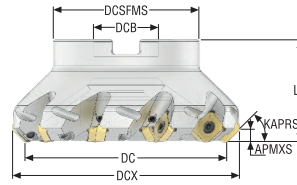

- For insert selection and cutting data recommendations, see page(s) 293-295
- For complete insert programme, see page(s) 845
- For ISO attribute explanation, see page 16

Designation	Item number	Type of mounting	DC	ZEFP	APMXS	KAPRS°	DCX	DCB	DCSFMS	LF	RPMX	Weight	Insert
			mm		mm		mm	mm	mm	mm		kg	
R220.53-0063-15-5A	02486622	Arbor	63,0	5	7,5	45,0	78,0	22,0	47,0	40,0	8300	0,6	SE.X1505
R220.53-0080-15-6A	02486624	Arbor	80,0	6	7,5	45,0	96,0	27,0	62,0	50,0	7400	1,2	SE.X1505
R220.53-0080-15-7A	02486625	Arbor	80,0	7	7,5	45,0	96,0	27,0	62,0	50,0	7400	1,2	SE.X1505
R220.53-0100-15-7A	02486627	Arbor	100,0	7	7,5	45,0	116,0	32,0	77,0	50,0	6600	1,8	SE.X1505
R220.53-0100-15-9A	02486628	Arbor	100,0	9	7,5	45,0	116,0	32,0	77,0	50,0	6600	1,8	SE.X1505
R220.53-0125-15-8A	02486630	Arbor	125,0	8	7,5	45,0	141,0	40,0	90,0	63,0	5900	3,3	SE.X1505
R220.53-0125-15-10A	02486631	Arbor	125,0	10	7,5	45,0	141,0	40,0	90,0	63,0	5900	3,2	SE.X1505
R220.53-8160-15-10	02486633	Arbor	160,0	10	7,5	45,0	176,0	40,0	90,0	63,0	5200	4,8	SE.X1505
R220.53-8200-15-12	02486636	Arbor	200,0	12	7,5	45,0	216,0	60,0	130,0	63,0	4700	7,7	SE.X1505

Spare Parts, included in delivery

For cutter	Arbor screw	Insert key	Insert screw
R220.53-0063	220.17-696	H6B-T20P	C05013-T20P
R220.53-0080-0125	-	H6B-T20P	C05013-T20P
R220.53-0080-0125	-	H6B-T20PL	C05013-T20P
R220.53-0080-0125	-	1/4HEX-T20PX90	C05013-T20P
R220.53-8160	-	1/4HEX-T20PX90	C05013-T20P
R220.53-8200	-	1/4HEX-T20PX90	C05013-T20P

Accessories

For cutter	Adjustable Torque key	Adjustable Torque key 2	Arbor screw	Insert clamping torque	Torque key
R220.53-0063-0100	-	-	-	5.0NM	T00-20P50
R220.53-0125	1/4HEX-S-HANDLE-0.8-5.0NM	1/4HEX-T-HANDLE-5.0-14.0NM	-	5.0NM	T00-20P50
R220.53-8160	1/4HEX-S-HANDLE-0.8-5.0NM	1/4HEX-T-HANDLE-5.0-14.0NM	MC6S12X40	5.0NM	T00-20P50
R220.53-8200	1/4HEX-S-HANDLE-0.8-5.0NM	1/4HEX-T-HANDLE-5.0-14.0NM	MC6S16X50	5.0NM	T00-20P50

Torque and fixed keys, see page 894

Quattromill R220.53-15 – inch

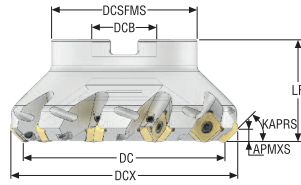

- For insert selection and cutting data recommendations, see page(s) 293-295
- For complete insert programme, see page(s) 845
- For ISO attribute explanation, see page 16

Designation	Item number	Type of mounting	DC	ZEFP	APMXS	KAPRS*	DCX	DCB	DCSFMS	LF	RPMX	Weight	Insert
			inch		inch		inch	inch	inch	inch		lbs	
R220.53-03.00-15-6A	02486638	Arbor	3.150	6	0.295	45.0	3.740	1.000	2.441	1.969	7400	3.310	SE.X1505
R220.53-04.00-15-7A	02486644	Arbor	3.937	7	0.295	45.0	4.528	1.500	3.543	1.969	6600	5.070	SE.X1505
R220.53-06.00-15-10	02486653	Arbor	6.299	10	0.295	45.0	6.890	2.000	3.543	2.480	5200	10.800	SE.X1505

Spare Parts, included in delivery

For cutter	Arbor screw	Insert key	Insert screw
R220.53-03.00	UC6S1/2UNFX1-1/4	H6B-T20P	C05013-T20P
R220.53-04.00	UF6S3/4UNFX1-3/4	H6B-T20PL	C05013-T20P
R220.53-06.00 / 808.00	-	1/4HEX-T20PX90	C05013-T20P

Accessories

For cutter	Adjustable Torque key	Adjustable Torque key 2	Arbor screw	Insert clamping torque	Torque key
R220.53-03.00-04.00	-	-	-	44.3IN.LBS	T00-20P50
R220.53-06.00	1/4HEX-S-HANDLE-0.8-5.0NM	1/4HEX-T-HANDLE-5.0-14.0NM	58215080	44.3IN.LBS	T00-20P50

Torque and fixed keys, see page 894

Square shoulder and slot milling cutters

Helical milling cutters

Face milling cutters

Disc milling cutters

High feed milling cutters

Copy milling cutters

Plunge milling cutters

Chamfer milling cutters

Spot facing cutters

Inserts

Quattromill R220.53-15C – Metric

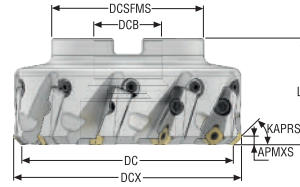

- For insert selection and cutting data recommendations, see page(s) 293-295
- For complete insert programme, see page(s) 845
- For ISO attribute explanation, see page 16

Designation	Item number	Type of mounting	DC	ZEFP	APMXS	KAPRS°	DCX	DCB	DCSFMS	LF	RPMX	Weight	Insert
			mm		mm		mm	mm	mm	mm		kg	
R220.53-0080-15-5C	02510197	Arbor	80,0	5	7,5	45,0	96,0	27,0	62,0	50,0	7400	1,7	SE.X1505
R220.53-0100-15-6C	02510198	Arbor	100,0	6	7,5	45,0	116,0	32,0	77,0	50,0	6600	2,6	SE.X1505
R220.53-0125-15-8C	02510199	Arbor	125,0	8	7,5	45,0	141,0	40,0	90,0	63,0	5900	4,2	SE.X1505
R220.53-8160-15-7C	02510219	Arbor	160,0	7	7,5	45,0	176,0	40,0	90,0	63,0	5200	6,5	SE.X1505
R220.53-8160-15-10C	02510202	Arbor	160,0	10	7,5	45,0	176,0	40,0	90,0	63,0	5200	6,6	SE.X1505
R220.53-8200-15-8C	02510221	Arbor	200,0	8	7,5	45,0	216,0	60,0	130,0	63,0	4700	9,4	SE.X1505
R220.53-8200-15-12C	02510204	Arbor	200,0	12	7,5	45,0	216,0	60,0	130,0	63,0	4700	9,8	SE.X1505
R220.53-8250-15-10C	02510234	Arbor	250,0	10	7,5	45,0	266,0	60,0	130,0	63,0	4200	17,0	SE.X1505
R220.53-8250-15-16C	02510231	Arbor	250,0	16	7,5	45,0	260,0	60,0	130,0	63,0	4200	17,1	SE.X1505
R220.53-8315-15-12C	02510235	Arbor	315,0	12	7,5	45,0	331,0	60,0	225,0	80,0	3700	32,6	SE.X1505
R220.53-8315-15-18C	02510232	Arbor	315,0	18	7,5	45,0	331,0	60,0	225,0	80,0	3700	38,0	SE.X1505

Spare Parts, included in delivery

For cutter	Adjustment unit	Cassette	Cassette screw	Insert key	Insert screw
R220.53-0080-0125	AU1114T-T15P	SE15AR-53	FS96018	H6B-T20P	C05010-T20P
R220.53-0080-0125	AU1114T-T15P	SE15AR-53	FS96018	H6B-T20PL	C05010-T20P
R220.53-8160	AU1114T-T15P	SE15AR-53	FS96018	H6B-T20PL	C05010-T20P
R220.53-8200-8250	AU1114T-T15P	SE15AR-53	FS96018	H6B-T20PL	C05010-T20P
R220.53-8315	AU1114T-T15P	SE15AR-53	FS96018	H6B-T20PL	C05010-T20P

Accessories

For cutter	Arbor screw	Arbor screw 2	Insert clamping torque	Key	Setting key	Torque key
R220.53-0080-0125	-	-	5.0NM	H04-4	T15P-4	T00-20P50
R220.53-8160	MC6S12X40	-	5.0NM	H04-4	T15P-4	T00-20P50
R220.53-8200-8250	MC6S16X50	-	5.0NM	H04-4	T15P-4	T00-20P50
R220.53-8315	MC6S16X50	MC6S20X50	5.0NM	H04-4	T15P-4	T00-20P50

Torque and fixed keys, see page 894

R220.53-15 – Insert selection – mm/Inch

SMG		a _p	f _z			
			80%	60%	40%	20%
P1	SEMX1505AFTN-ME15 T350M	4,5	0,30	0,30	0,30	0,38
		0.18	0.012	0.012	0.012	0.015
P2	SEMX1505AFTN-ME15 T350M	4,5	0,30	0,30	0,30	0,38
		0.18	0.012	0.012	0.012	0.015
P3	SEMX1505AFTN-M18 MP2501	4,5	0,36	0,36	0,38	0,46
		0.18	0.014	0.014	0.015	0.018
P4	SEMX1505AFTN-M18 MP2501	4,5	0,36	0,36	0,36	0,46
		0.18	0.014	0.014	0.014	0.018
P5	SEMX1505AFTN-M18 MP2501	4,5	0,36	0,36	0,36	0,46
		0.18	0.014	0.014	0.014	0.017
P6	SEMX1505AFTN-M18 MP2501	4,5	0,34	0,34	0,36	0,44
		0.18	0.013	0.013	0.014	0.017
P7	SEMX1505AFTN-M18 T350M	4,5	0,34	0,34	0,36	0,44
		0.18	0.013	0.013	0.014	0.017
P8	SEMX1505AFTN-M18 T350M	4,5	0,36	0,36	0,38	0,46
		0.18	0.014	0.014	0.015	0.018
P11	SEEX1505AFN-M12 MP2050	4,5	0,26	0,26	0,28	0,34
		0.18	0.010	0.010	0.011	0.013
P12	SEEX1505AFN-M12 MP2050	3,5	0,19	0,19	0,20	0,24
		0.14	0.0075	0.0075	0.0080	0.0095
M1	SEEX1505AFN-M12 F40M	4,5	0,28	0,28	0,28	0,34
		0.18	0.011	0.011	0.011	0.013
M2	SEEX1505AFN-M12 MS2050	4,5	0,25	0,25	0,26	0,32
		0.18	0.010	0.010	0.010	0.013
M3	SEEX1505AFN-M12 MS2050	3,5	0,20	0,20	0,22	0,26
		0.14	0.0080	0.0080	0.0085	0.010
M4	SEEX1505AFN-M12 MP2050	2,5	0,20	0,20	0,22	0,26
		0.10	0.0080	0.0080	0.0085	0.010
M5	SEEX1505AFN-M12 MP2050	2,5	0,20	0,20	0,22	0,26
		0.10	0.0080	0.0080	0.0085	0.010
K1	SEMX1505AFTN-M18 MK1500	4,5	0,38	0,38	0,40	0,50
		0.18	0.015	0.015	0.016	0.020
K2	SEMX1505AFTN-M18 MK1500	4,5	0,36	0,36	0,36	0,46
		0.18	0.014	0.014	0.014	0.017
K3	SEMX1505AFTN-M18 MP1501	4,5	0,36	0,36	0,36	0,46
		0.18	0.014	0.014	0.014	0.017
K4	SEMX1505AFTN-M18 MP1501	4,5	0,36	0,36	0,36	0,46
		0.18	0.014	0.014	0.014	0.017
K5	SEMX1505AFTN-M18 MP1501	4,5	0,32	0,32	0,32	0,40
		0.18	0.013	0.013	0.013	0.016
K6	SEMX1505AFTN-M18 MK2050	4,5	0,36	0,36	0,36	0,46
		0.18	0.014	0.014	0.014	0.017
K7	SEMX1505AFTN-M18 MK2050	4,5	0,32	0,32	0,32	0,40
		0.18	0.013	0.013	0.013	0.016
N1	SEEX1505AFN-E10 H25	4,5	0,28	0,28	0,30	0,38
		0.18	0.011	0.011	0.012	0.015
N2	SEEX1505AFN-E10 H25	4,5	0,28	0,28	0,30	0,38
		0.18	0.011	0.011	0.012	0.015
N3	SEEX1505AFN-E10 H25	4,5	0,28	0,28	0,30	0,38
		0.18	0.011	0.011	0.012	0.015
N11	SEEX1505AFN-E10 H25	4,5	0,28	0,28	0,30	0,38
		0.18	0.011	0.011	0.012	0.015
S1	SEEX1505AFN-M12 T350M	2,5	0,19	0,19	0,20	0,24
		0.10	0.0075	0.0075	0.0080	0.0095
S2	SEEX1505AFN-M12 T350M	2,5	0,19	0,19	0,20	0,24
		0.10	0.0075	0.0075	0.0080	0.0095
S3	SEEX1505AFN-M12 T350M	2,5	0,18	0,18	0,18	0,22
		0.10	0.0070	0.0070	0.0070	0.0085
S11	SEEX1505AFN-M12 MS2050	3,0	0,20	0,20	0,22	0,26
		0.12	0.0080	0.0080	0.0085	0.010
S12	SEEX1505AFN-M12 MS2050	3,0	0,20	0,20	0,22	0,26
		0.12	0.0080	0.0080	0.0085	0.010
S13	SEEX1505AFN-M12 MS2050	2,5	0,19	0,19	0,20	0,24
		0.10	0.0075	0.0075	0.0080	0.0095
H5	SEMX1505AFTN-MD20 MP3000	3,5	0,28	0,28	0,28	0,36
		0.14	0.011	0.011	0.011	0.014
H8	SEMX1505AFTN-MD20 MP3000	3,0	0,22	0,22	0,22	0,28
		0.12	0.0085	0.0085	0.0085	0.011
H11	SEMX1505AFTN-MD20 MP1501	3,5	0,28	0,28	0,28	0,36
		0.14	0.011	0.011	0.011	0.014
H12	SEMX1505AFTN-MD20 MP1501	3,0	0,22	0,22	0,22	0,28
		0.12	0.0085	0.0085	0.0085	0.011
H21	SEMX1505AFTN-MD20 MP1501	3,0	0,22	0,22	0,22	0,28
		0.12	0.0085	0.0085	0.0085	0.011

SMG = Seco material group
 f_z = mm/tooth (in/tooth), v_c = m/min (sf/min), a_p/DC = %
 All cutting data are start values

Square shoulder and slot milling cutters
 Helical milling cutters
 Face milling cutters
 Disc milling cutters
 High feed milling cutters
 Copy milling cutters
 Plunge milling cutters
 Chamfer milling cutters
 Spot facing cutters
 Inserts

R220.53-15 – Cutting data $v_c = (m/min)/(sf/min)$

SMG	MK1500				MP1501				MP2501				T350M			
	80%	60%	40%	20%	80%	60%	40%	20%	80%	60%	40%	20%	80%	60%	40%	20%
P1	—	—	—	—	285	305	340	390	250	270	300	345	220	235	260	300
	—	—	—	—	940	1000	1125	1275	820	890	980	1125	720	770	850	980
P2	—	—	—	—	275	300	330	380	245	265	290	335	210	230	255	290
	—	—	—	—	900	980	1075	1250	800	870	950	1100	690	750	840	950
P3	—	—	—	—	240	260	290	325	215	230	255	290	185	200	220	250
	—	—	—	—	790	850	950	1075	710	750	840	950	610	660	720	820
P4	—	—	—	—	210	230	255	290	190	205	225	260	165	175	195	225
	—	—	—	—	690	750	840	950	620	670	740	850	540	570	640	740
P5	—	—	—	—	205	220	245	280	180	195	220	245	155	170	190	215
	—	—	—	—	670	720	800	920	590	640	720	800	510	560	620	710
P6	—	—	—	—	230	250	275	315	205	220	245	280	180	195	215	245
	—	—	—	—	750	820	900	1025	670	720	800	920	590	640	710	800
P7	—	—	—	—	220	235	260	300	195	210	230	265	170	185	200	230
	—	—	—	—	720	770	850	980	640	690	750	870	560	610	660	750
P8	—	—	—	—	205	220	240	275	180	195	215	245	155	170	185	210
	—	—	—	—	670	720	790	900	590	640	710	800	510	560	610	690
P11	—	—	—	—	215	230	255	290	190	205	225	255	165	180	195	225
	—	—	—	—	710	750	840	950	620	670	740	840	540	590	640	740
P12	—	—	—	—	140	150	170	190	125	135	150	170	110	115	130	150
	—	—	—	—	460	490	560	620	410	445	490	560	360	375	425	490
M1	—	—	—	—	—	—	—	—	175	190	210	240	165	175	195	225
	—	—	—	—	—	—	—	—	570	620	690	790	540	570	640	740
M2	—	—	—	—	—	—	—	—	145	155	175	200	135	145	165	185
	—	—	—	—	—	—	—	—	475	510	570	660	445	475	540	610
M3	—	—	—	—	—	—	—	—	120	130	140	165	110	120	130	150
	—	—	—	—	—	—	—	—	395	425	460	540	360	395	425	490
M4	—	—	—	—	—	—	—	—	90	100	110	125	85	95	105	120
	—	—	—	—	—	—	—	—	295	330	360	410	280	310	345	395
M5	—	—	—	—	—	—	—	—	75	85	90	105	70	75	85	100
	—	—	—	—	—	—	—	—	245	280	295	345	230	245	280	330
K1	275	295	325	375	220	235	260	300	195	210	230	265	170	180	200	230
	900	970	1075	1225	720	770	850	980	640	690	750	870	560	590	660	750
K2	240	260	295	330	190	210	235	265	170	185	205	235	150	160	180	205
	790	850	970	1075	620	690	770	870	560	610	670	770	490	520	590	670
K3	205	220	250	280	165	175	200	225	145	155	175	195	125	135	155	170
	670	720	820	920	540	570	660	740	475	510	570	640	410	445	510	560
K4	195	210	235	265	155	170	190	215	140	150	165	190	120	130	145	165
	640	690	770	870	510	560	620	710	460	490	540	620	395	425	475	540
K5	120	130	145	165	95	105	115	130	85	90	105	115	75	80	90	100
	395	425	475	540	310	345	375	425	280	295	345	375	245	260	295	330
K6	170	185	210	235	135	150	165	185	120	130	145	165	105	115	130	145
	560	610	690	770	445	490	540	610	395	425	475	540	345	375	425	475
K7	155	165	185	210	125	135	150	170	110	120	130	150	95	105	115	130
	510	540	610	690	410	445	490	560	360	395	425	490	310	345	375	425
N1	—	—	—	—	—	—	—	—	—	—	—	—	—	—	—	—
	—	—	—	—	—	—	—	—	—	—	—	—	—	—	—	—
N2	—	—	—	—	—	—	—	—	—	—	—	—	—	—	—	—
	—	—	—	—	—	—	—	—	—	—	—	—	—	—	—	—
N3	—	—	—	—	—	—	—	—	—	—	—	—	—	—	—	—
	—	—	—	—	—	—	—	—	—	—	—	—	—	—	—	—
N11	—	—	—	—	—	—	—	—	—	—	—	—	—	—	—	—
	—	—	—	—	—	—	—	—	—	—	—	—	—	—	—	—
S1	—	—	—	—	—	—	—	—	45	48	55	60	40	43	48	55
	—	—	—	—	—	—	—	—	150	155	180	195	130	140	155	180
S2	—	—	—	—	—	—	—	—	36	39	43	49	32	35	39	44
	—	—	—	—	—	—	—	—	120	130	140	160	105	115	130	145
S3	—	—	—	—	—	—	—	—	32	34	38	43	29	31	34	39
	—	—	—	—	—	—	—	—	105	110	125	140	95	100	110	130
S11	—	—	—	—	—	—	—	—	60	70	75	85	55	60	65	75
	—	—	—	—	—	—	—	—	195	230	245	280	180	195	215	245
S12	—	—	—	—	—	—	—	—	43	47	50	60	38	42	46	55
	—	—	—	—	—	—	—	—	140	155	165	195	125	140	150	180
S13	—	—	—	—	—	—	—	—	25	27	30	34	23	24	27	31
	—	—	—	—	—	—	—	—	80	90	100	110	75	80	90	100
H5	—	—	—	—	47	50	55	65	38	41	45	50	36	39	43	49
	—	—	—	—	155	165	180	215	125	135	150	165	120	130	140	160
H8	—	—	—	—	50	55	60	70	41	44	49	55	39	42	47	55
	—	—	—	—	165	180	195	230	135	145	160	180	130	140	155	180
H11	—	—	—	—	60	65	70	80	48	50	55	65	46	49	55	60
	—	—	—	—	195	215	230	260	155	165	180	215	150	160	180	195
H12	—	—	—	—	90	100	110	120	80	85	95	110	70	75	85	95
	—	—	—	—	295	330	360	395	260	280	310	360	230	245	280	310
H21	—	—	—	—	50	55	60	70	41	44	49	55	39	42	47	55
	—	—	—	—	165	180	195	230	135	145	160	180	130	140	155	180

R220.53-15 – Cutting data $v_c = (m/min)/(sf/min)$

SMG	F40M				MS2050				MP3000				MK2050				MP2050				H25			
	80%	60%	40%	20%	80%	60%	40%	20%	80%	60%	40%	20%	80%	60%	40%	20%	80%	60%	40%	20%	80%	60%	40%	20%
P1	195	210	230	265	245	265	290	330	225	245	270	310	250	275	300	345	275	300	335	385	—	—	—	—
	640	690	750	870	800	870	950	1075	740	800	890	1025	820	900	980	1125	900	980	1100	1275	—	—	—	—
P2	190	205	225	260	235	255	285	320	215	235	265	295	245	265	295	335	270	290	325	365	—	—	—	—
	620	670	740	850	770	840	940	1050	710	770	870	970	800	870	970	1100	890	950	1075	1200	—	—	—	—
P3	165	180	195	225	205	225	250	280	195	210	230	260	215	230	255	290	235	255	285	320	—	—	—	—
	540	590	640	740	670	740	820	920	640	690	750	850	710	750	840	950	770	840	940	1050	—	—	—	—
P4	145	155	175	200	185	200	220	250	170	185	205	230	190	205	225	260	210	225	250	290	—	—	—	—
	475	510	570	660	610	660	720	820	560	610	670	750	620	670	740	850	690	740	820	950	—	—	—	—
P5	140	150	170	190	175	190	210	235	160	175	195	220	180	195	220	245	205	220	240	275	—	—	—	—
	460	490	560	620	570	620	690	770	520	570	640	720	590	640	720	800	670	720	790	900	—	—	—	—
P6	160	170	190	215	195	215	240	265	185	200	220	255	205	225	245	280	230	250	270	310	—	—	—	—
	520	560	620	710	640	710	790	870	610	660	720	840	670	740	800	920	750	820	890	1025	—	—	—	—
P7	150	160	180	205	185	200	225	250	175	190	210	240	195	210	230	265	215	235	255	290	—	—	—	—
	490	520	590	670	610	660	740	820	570	620	690	790	640	690	750	870	710	770	840	950	—	—	—	—
P8	140	150	165	190	175	185	210	235	160	175	195	220	180	195	215	245	200	215	240	270	—	—	—	—
	460	490	540	620	570	610	690	770	520	570	640	720	590	640	710	800	660	710	790	890	—	—	—	—
P11	145	160	175	200	180	195	220	245	170	185	205	235	190	205	225	260	210	225	250	285	—	—	—	—
	475	520	570	660	590	640	720	800	560	610	670	770	620	670	740	850	690	740	820	940	—	—	—	—
P12	95	105	115	130	120	130	140	160	110	120	135	155	125	135	150	170	135	145	165	185	—	—	—	—
	310	345	375	425	395	425	460	520	360	395	445	510	410	445	490	560	445	475	540	610	—	—	—	—
M1	150	165	180	210	190	205	230	260	160	175	195	220	—	—	—	—	195	210	235	265	—	—	—	—
	490	540	590	690	620	670	750	850	520	570	640	720	—	—	—	—	640	690	770	870	—	—	—	—
M2	125	135	150	170	160	170	190	215	135	145	165	185	—	—	—	—	165	175	195	220	—	—	—	—
	410	445	490	560	520	560	620	710	445	475	540	610	—	—	—	—	540	570	640	720	—	—	—	—
M3	105	110	120	140	130	140	155	175	110	120	135	155	—	—	—	—	130	140	160	175	—	—	—	—
	345	360	395	460	425	460	510	570	360	395	445	510	—	—	—	—	425	460	520	570	—	—	—	—
M4	80	85	95	110	100	110	120	135	90	95	105	120	—	—	—	—	100	110	120	140	—	—	—	—
	260	280	310	360	330	360	395	445	295	310	345	395	—	—	—	—	330	360	395	460	—	—	—	—
M5	65	70	80	90	85	90	100	115	75	80	90	100	—	—	—	—	85	90	100	115	—	—	—	—
	215	230	260	295	280	295	330	375	245	260	295	330	—	—	—	—	280	295	330	375	—	—	—	—
K1	150	160	180	205	—	—	—	—	170	185	210	235	265	285	315	365	—	—	—	—	—	—	—	—
	490	520	590	670	—	—	—	—	560	610	690	770	870	940	1025	1200	—	—	—	—	—	—	—	—
K2	130	145	160	180	—	—	—	—	155	165	185	210	235	255	285	320	—	—	—	—	—	—	—	—
	425	475	520	590	—	—	—	—	510	540	610	690	770	840	940	1050	—	—	—	—	—	—	—	—
K3	110	120	135	155	—	—	—	—	130	140	160	175	195	215	240	270	—	—	—	—	—	—	—	—
	360	395	445	510	—	—	—	—	425	460	520	570	640	710	790	890	—	—	—	—	—	—	—	—
K4	105	115	130	145	—	—	—	—	125	135	150	170	190	205	230	260	—	—	—	—	—	—	—	—
	345	375	425	475	—	—	—	—	410	445	490	560	620	670	750	850	—	—	—	—	—	—	—	—
K5	65	70	80	90	—	—	—	—	75	85	95	105	115	125	140	160	—	—	—	—	—	—	—	—
	215	230	260	295	—	—	—	—	245	280	310	345	375	410	460	520	—	—	—	—	—	—	—	—
K6	95	100	115	130	—	—	—	—	110	120	135	150	165	180	200	225	—	—	—	—	—	—	—	—
	310	330	375	425	—	—	—	—	360	395	445	490	540	590	660	740	—	—	—	—	—	—	—	—
K7	85	90	100	115	—	—	—	—	100	105	120	135	150	160	180	205	—	—	—	—	—	—	—	—
	280	295	330	375	—	—	—	—	330	345	395	445	490	520	590	670	—	—	—	—	—	—	—	—
N1	1100	1175	1275	1475	—	—	—	—	1225	1325	1500	1700	—	—	—	—	—	—	—	—	1475	1600	1775	1975
	3600	3850	4175	4850	—	—	—	—	4025	4350	4925	5575	—	—	—	—	—	—	—	—	4850	5250	5825	6475
N2	440	475	520	600	—	—	—	—	495	540	610	690	—	—	—	—	—	—	—	—	590	640	720	800
	1450	1550	1700	1975	—	—	—	—	1625	1775	2000	2275	—	—	—	—	—	—	—	—	1925	2100	2350	2625
N3	295	320	345	400	—	—	—	—	330	360	405	460	—	—	—	—	—	—	—	—	395	430	480	530
	970	1050	1125	1300	—	—	—	—	1075	1175	1325	1500	—	—	—	—	—	—	—	—	1300	1400	1575	1750
N11	335	365	395	460	—	—	—	—	380	410	465	530	—	—	—	—	—	—	—	—	455	490	550	610
	1100	1200	1300	1500	—	—	—	—	1250	1350	1525	1750	—	—	—	—	—	—	—	—	1500	1600	1800	2000
S1	37	40	45	50	47	50	55	65	41	44	49	55	—	—	—	—	50	55	60	70	—	—	—	—
	120	130	150	165	155	165	180	215	135	145	160	180	—	—	—	—	165	180	195	230	—	—	—	—
S2	30	32	36	41	38	41	45	50	33	36	40	44	—	—	—	—	40	43	48	55	—	—	—	—
	100	105	120	135	125	135	150	165	110	120	130	145	—	—	—	—	130	140	155	180	—	—	—	—
S3	26	29	32	36	33	36	39	45	29	31	35	40	—	—	—	—	36	38	42	48	—	—	—	—
	85	95	105	120	110	120	130	150	95	100	115	130	—	—	—	—	120	125	140	155	—	—	—	—
S11	50	55	60	70	65	70	80	90	55	60	65	75	—	—	—	—	70	75	85	95	—	—	—	—
	165	180	195	230	215	230	260	295	180	195	215	245	—	—	—	—	230	245	280	310	—	—	—	—
S12	36	39	43	49	44	49	55	60	38	42	46	55	—	—	—	—	48	50	60	65	—	—	—	—
	120	130	140	160	145	160	180	195																



R220.88 (SNMU)

The R220.88 cutters with SNMU12/16 inserts provide high depth-of-cut capabilities, along with an economical eight cutting edges per insert. These cutters provide strong performance in machining steels and cast iron and are available in two insert sizes, 12 and 16. This tool is ideal for roughing and semi-finishing operations.

- Insert size 12, cutter range 40-160mm (1.5-6.0 inch)
- Insert size 16, cutter range 63-160mm (2.5-6.0 inch)

R220.88-12 – Metric

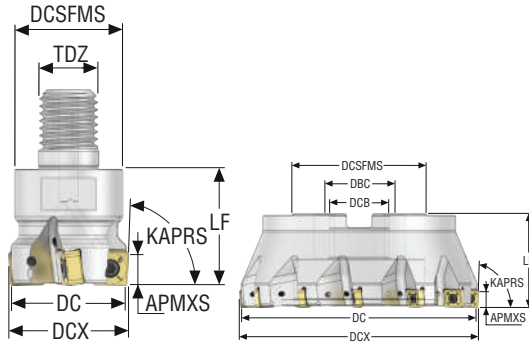

- For insert selection and cutting data recommendations, see page(s) 301-302
- For complete insert programme, see page(s) 856
- For ISO attribute explanation, see page 16

Designation	Item number	Type of mounting	DC	ZEFP	APMXS	KAPRS°	DCX	DCB	DCSFMS	LF	RPMX	Weight	Insert
			mm		mm		mm	mm	mm	mm		kg	
R217.88-2040.RE-12-4SAP	10130009	Combimaster	40,0	4	9,0	88,0	41,4	–	37,0	40,0	12600	0,4	SN.U1204
R220.88-0040-12-4SAP	10130008	Arbor	40,0	4	9,0	88,0	41,4	16,0	35,0	40,0	12600	0,3	SN.U1204
R220.88-0050-12-4SAP	10134775	Arbor	50,0	4	9,0	88,0	51,2	22,0	47,0	40,0	12600	0,5	SN.U1204
R220.88-0050-12-5SAP	10134776	Arbor	50,0	5	9,0	88,0	51,2	22,0	47,0	40,0	12600	0,5	SN.U1204
R220.88-0063-12-6SAP	10134777	Arbor	63,0	6	9,0	88,0	64,5	22,0	47,0	40,0	11200	0,6	SN.U1204
R220.88-0063-12-7SAP	10134778	Arbor	63,0	7	9,0	88,0	64,5	22,0	47,0	40,0	11200	0,6	SN.U1204
R220.88-0080-12-7SAP	10134779	Arbor	80,0	7	9,0	88,0	81,16	27,0	62,0	50,0	9900	1,2	SN.U1204
R220.88-0080-12-9SAP	10134780	Arbor	80,0	9	9,0	88,0	81,16	27,0	62,0	50,0	9900	1,2	SN.U1204
R220.88-0100-12-8SAP	10134782	Arbor	100,0	8	9,0	88,0	101,15	32,0	77,0	50,0	8900	1,9	SN.U1204
R220.88-0100-12-11SAP	10134781	Arbor	100,0	11	9,0	88,0	101,15	32,0	77,0	50,0	8900	1,9	SN.U1204
R220.88-0125-12-10SAP	10134783	Arbor	125,0	10	9,0	88,0	126,15	40,0	90,0	63,0	7900	3,6	SN.U1204
R220.88-0125-12-13SAP	10134784	Arbor	125,0	13	9,0	88,0	126,15	40,0	90,0	63,0	7900	3,7	SN.U1204
R220.88-8160-12-12SAP	10134785	Arbor	160,0	12	9,0	88,0	161,14	40,0	90,0	63,0	7000	5,6	SN.U1204
R220.88-8160-12-16SAP	10134786	Arbor	160,0	16	9,0	88,0	161,14	40,0	90,0	63,0	7000	5,6	SN.U1204

Square shoulder and slot milling cutters

Helical milling cutters

Face milling cutters

Disc milling cutters

High feed milling cutters

Copy milling cutters

Plunge milling cutters

Chamfer milling cutters

Spot facing cutters

Inserts

Spare Parts, included in delivery

For cutter	Arbor screw	Insert key	Insert screw	Lid	Lid screw
R217.88-..	-	1/4HEX-T15PX50	C04011-T15P	-	-
R220.88-0040	220.17-690	1/4HEX-T15PX50	C04011-T15P	-	-
R220.88-0050-0063	220.17-692	1/4HEX-T15PX50	C04011-T15P	-	-
R220.88-0080	MC6S12X35	1/4HEX-T15PX90	C04011-T15P	-	-
R220.88-0100	MC6S16X35	1/4HEX-T15PX90	C04011-T15P	-	-
R220.88-0125	MC6S20X40	1/4HEX-T15PX90	C04011-T15P	-	-
R220.88-8160	-	1/4HEX-T15PX90	C04011-T15P	SC-160-90	MF6S4X10

Accessories

For cutter	Adjustable Torque key	Arbor screw	Insert clamping torque	Torque key
R217/220.88-0040-0125	1/4HEX-S-HANDLE-0.8-5.0NM	-	3.5NM	T00-15P35
R220.88-8160	1/4HEX-S-HANDLE-0.8-5.0NM	MC6S12X40	3.5NM	T00-15P35

Torque and fixed keys, see page 894

- Square shoulder and slot milling cutters
- Helical milling cutters
- Face milling cutters
- Disc milling cutters
- High feed milling cutters
- Copy milling cutters
- Plunge milling cutters
- Chamfer milling cutters
- Spot facing cutters
- Inserts

R220.88-12 – inch

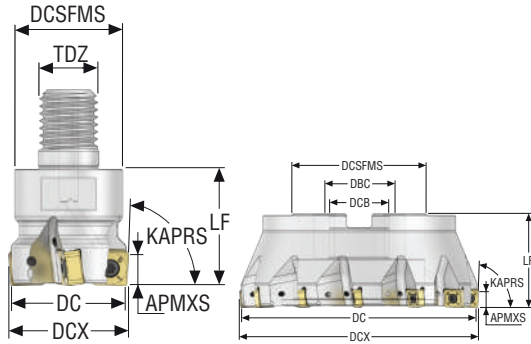

- For insert selection and cutting data recommendations, see page(s) 301-302
- For complete insert programme, see page(s) 856
- For ISO attribute explanation, see page 16

Designation	Item number	Type of mounting	DC	ZEFP	APMXS	KAPRS*	DCX	DCB	DCSFMS	LF	RPMX	Weight	Insert
			inch		inch		inch	inch	inch	inch		lbs	
R217.88-01.50-20RE-12-4SAP	10134800	Combimaster	1.500	4	0.354	88.0	1.563	–	1.457	1.575	12600	0.880	SN.U1204
R220.88-01.50-12-4SAP	10134787	Arbor	1.500	4	0.354	88.0	1.558	0.500	1.378	1.575	12600	0.660	SN.U1204
R220.88-02.00-12-4SAP	10134788	Arbor	2.000	4	0.354	88.0	2.051	0.750	1.850	1.575	12600	1.100	SN.U1204
R220.88-02.00-12-5SAP	10134789	Arbor	2.000	5	0.354	88.0	2.051	0.750	1.850	1.575	12600	1.100	SN.U1204
R220.88-02.50-12-6SAP	10134790	Arbor	2.500	6	0.354	88.0	2.549	0.750	1.850	1.575	11200	1.320	SN.U1204
R220.88-02.50-12-7SAP	10134791	Arbor	2.500	7	0.354	88.0	2.549	0.750	1.850	1.575	11200	1.320	SN.U1204
R220.88-03.00-12-7SAP	10134792	Arbor	3.000	7	0.354	88.0	3.046	1.000	2.441	1.969	9900	2.650	SN.U1204
R220.88-03.00-12-9SAP	10134793	Arbor	3.000	9	0.354	88.0	3.046	1.000	2.441	1.969	9900	2.650	SN.U1204
R220.88-04.00-12-8SAP	10134795	Arbor	4.000	8	0.354	88.0	4.039	1.500	3.031	1.969	8900	4.190	SN.U1204
R220.88-04.00-12-11SAP	10134794	Arbor	4.000	11	0.354	88.0	4.039	1.500	3.031	1.969	8900	4.190	SN.U1204
R220.88-05.00-12-10SAP	10134796	Arbor	5.000	10	0.354	88.0	5.039	1.500	3.543	2.480	7900	8.380	SN.U1204
R220.88-05.00-12-13SAP	10134797	Arbor	5.000	13	0.354	88.0	5.039	1.500	3.543	2.480	7900	8.380	SN.U1204
R220.88-06.00-12-12SAP	10134798	Arbor	6.000	12	0.354	88.0	6.039	2.000	4.331	2.480	7000	11.020	SN.U1204
R220.88-06.00-12-16SAP	10134799	Arbor	6.000	16	0.354	88.0	6.039	2.000	4.331	2.480	7000	11.020	SN.U1204

Square shoulder and slot milling cutters

Helical milling cutters

Face milling cutters

Disc milling cutters

High feed milling cutters

Copy milling cutters

Plunge milling cutters

Chamfer milling cutters

Spot facing cutters

Inserts

Spare Parts, included in delivery

For cutter	Arbor screw	Insert key	Insert screw	Lid	Lid screw
R217.88-..	-	1/4HEX-T15PX90	C04011-T15P	-	-
R220.88-01.50	UC6S1/4UNFX1	1/4HEX-T15PX50	C04011-T15P	-	-
R220.88-02.00-02.50	UC6S3/8UNFX1	1/4HEX-T15PX50	C04011-T15P	-	-
R220.88-03.00	UC6S1/2UNFX1-1/4	1/4HEX-T15PX90	C04011-T15P	-	-
R220.88-04.00	UC6S3/4UNFX1-1/4	1/4HEX-T15PX90	C04011-T15P	-	-
R220.88-05.00	UC6S3/4UNFX1-1/4	1/4HEX-T15PX90	C04011-T15P	-	-
R220.88-06.00	-	1/4HEX-T15PX90	C04011-T15P	SC-160-90	MF6S4X10

Accessories

For cutter	Adjustable Torque key	Arbor screw	Insert clamping torque	Torque key
R217/220-01.50-05.00	1/4HEX-S-HANDLE-0.8-5.0NM	-	31.0IN.LBS	T00-15P35
R217/220-06.00	1/4HEX-S-HANDLE-0.8-5.0NM	58215080	31.0IN.LBS	T00-15P35

Torque and fixed keys, see page 894

Square shoulder and slot milling cutters
Helical milling cutters
Face milling cutters
Disc milling cutters
High feed milling cutters
Copy milling cutters
Plunge milling cutters
Chamfer milling cutters
Spot facing cutters
Inserts

R220.88-12 – Insert selection – mm/Inch

SMG		a _p	f _z			
			80%	60%	40%	20%
P1	SNMU120410TN-M10 T350M	5,0	0,14	0,14	0,15	0,18
		0.20	0.0055	0.0055	0.0060	0.0070
P2	SNMU120410TN-M10 T350M	5,0	0,15	0,15	0,15	0,18
		0.20	0.0060	0.0060	0.0060	0.0070
P3	SNMU120410TN-M10 T350M	5,0	0,14	0,14	0,14	0,17
		0.20	0.0055	0.0055	0.0055	0.0065
P4	SNMU120412TN-M16 MP2501	5,0	0,24	0,24	0,24	0,30
		0.20	0.0095	0.0095	0.0095	0.012
P5	SNMU120412TN-M16 MP2501	5,0	0,22	0,22	0,24	0,28
		0.20	0.0085	0.0085	0.0095	0.011
P6	SNMU120412TN-M16 MP2501	5,0	0,22	0,22	0,24	0,28
		0.20	0.0085	0.0085	0.0095	0.011
P7	SNMU120410TN-M10 T350M	5,0	0,13	0,13	0,13	0,17
		0.20	0.0050	0.0050	0.0055	0.0065
P8	SNMU120410TN-M10 T350M	5,0	0,14	0,14	0,14	0,17
		0.20	0.0055	0.0055	0.0055	0.0065
P11	SNMU120410TN-M10 MS2500	5,0	0,13	0,13	0,13	0,17
		0.20	0.0050	0.0050	0.0055	0.0065
P12	SNMU120410TN-M10 MS2500	4,5	0,090	0,090	0,095	0,11
		0.18	0.0036	0.0036	0.0038	0.0044
M1	SNMU120410TN-M10 F40M	5,0	0,15	0,15	0,15	0,18
		0.20	0.0060	0.0060	0.0060	0.0070
M2	SNMU120410TN-M10 F40M	5,0	0,13	0,13	0,14	0,17
		0.20	0.0050	0.0050	0.0055	0.0065
M3	SNMU120410TN-M10 MS2050	4,5	0,11	0,11	0,11	0,13
		0.18	0.0044	0.0044	0.0044	0.0050
M4	SNMU120410TN-M10 MS2050	3,0	0,095	0,095	0,10	0,12
		0.12	0.0038	0.0038	0.0040	0.0048
M5	SNMU120410TN-M10 MS2050	3,0	0,095	0,095	0,10	0,12
		0.12	0.0038	0.0038	0.0040	0.0048
K1	SNMU120412TN-M16 MK1500	5,0	0,25	0,25	0,26	0,32
		0.20	0.010	0.010	0.010	0.013
K2	SNMU120412TN-M16 MK1500	5,0	0,22	0,22	0,24	0,28
		0.20	0.0085	0.0085	0.0095	0.011
K3	SNMU120412TN-M16 MP1501	5,0	0,22	0,22	0,24	0,28
		0.20	0.0085	0.0085	0.0095	0.011
K4	SNMU120412TN-M16 MP1501	5,0	0,22	0,22	0,24	0,28
		0.20	0.0085	0.0085	0.0095	0.011
K5	SNMU120412TN-M16 MK2050	5,0	0,20	0,20	0,22	0,26
		0.20	0.0080	0.0080	0.0085	0.010
K6	SNMU120412TN-M16 MK2050	5,0	0,22	0,22	0,24	0,28
		0.20	0.0085	0.0085	0.0095	0.011
K7	SNMU120412TN-M16 MK2050	5,0	0,20	0,20	0,22	0,26
		0.20	0.0080	0.0080	0.0085	0.010
H5	SNMU120410TN-MD13 MP1501	4,5	0,16	0,16	0,16	0,19
		0.18	0.0065	0.0065	0.0065	0.0075
H8	SNMU120410TN-MD13 MP1501	4,0	0,12	0,12	0,12	0,15
		0.16	0.0048	0.0048	0.0048	0.0060
H11	SNMU120410TN-MD13 MP1501	4,5	0,16	0,16	0,16	0,19
		0.18	0.0065	0.0065	0.0065	0.0075
H12	SNMU120410TN-MD13 MP1501	4,0	0,12	0,12	0,12	0,15
		0.16	0.0048	0.0048	0.0048	0.0060
H21	SNMU120410TN-MD13 MP1501	4,0	0,12	0,12	0,12	0,15
		0.16	0.0048	0.0048	0.0048	0.0060

SMG = Seco material group
 f_z = mm/tooth (in/tooth), v_c = m/min (sf/min), a_p/DC = %
 All cutting data are start values

Square shoulder and slot milling cutters
 Helical milling cutters
 Face milling cutters
 Disc milling cutters
 High feed milling cutters
 Copy milling cutters
 Plunge milling cutters
 Chamfer milling cutters
 Spot facing cutters
 Inserts

R217/220.88-12 – Cutting data $v_c = (m/min)/(sf/min)$

SMG	MK1500				MP1501				MP2501				T350M				MS2500			
	80%	60%	40%	20%	80%	60%	40%	20%	80%	60%	40%	20%	80%	60%	40%	20%	80%	60%	40%	20%
P1	—	—	—	—	270	295	330	370	240	260	290	325	210	225	255	285	310	335	375	425
	—	—	—	—	890	970	1075	1225	790	850	950	1075	690	740	840	940	1025	1100	1225	1400
P2	—	—	—	—	265	285	315	360	235	255	280	320	205	220	245	275	305	330	360	410
	—	—	—	—	870	940	1025	1175	770	840	920	1050	670	720	800	900	1000	1075	1175	1350
P3	—	—	—	—	230	250	280	315	205	220	245	280	180	190	215	245	265	290	315	360
	—	—	—	—	750	820	920	1025	670	720	800	920	590	620	710	800	870	950	1025	1175
P4	—	—	—	—	205	220	245	275	180	195	215	245	155	170	190	215	235	255	280	315
	—	—	—	—	670	720	800	900	590	640	710	800	510	560	620	710	770	840	920	1025
P5	—	—	—	—	200	215	235	270	175	190	205	240	155	165	180	210	225	240	270	305
	—	—	—	—	660	710	770	890	570	620	670	790	540	590	690	740	790	840	890	1000
P6	—	—	—	—	225	240	265	305	200	215	235	270	175	185	205	235	250	270	300	345
	—	—	—	—	740	790	870	1000	660	710	770	890	570	610	670	770	820	890	980	1125
P7	—	—	—	—	210	230	250	285	185	200	220	255	165	175	190	220	240	255	285	325
	—	—	—	—	690	750	820	940	610	660	720	840	540	570	620	720	790	840	940	1075
P8	—	—	—	—	195	210	235	265	170	185	205	235	150	160	180	205	225	240	265	305
	—	—	—	—	640	690	770	870	560	610	670	770	490	520	590	670	740	790	870	1000
P11	—	—	—	—	205	220	240	280	180	195	215	245	160	170	185	215	230	250	275	315
	—	—	—	—	670	720	790	920	590	640	710	800	520	560	610	710	750	820	900	1025
P12	—	—	—	—	135	145	160	180	120	130	145	160	105	110	125	140	155	165	180	205
	—	—	—	—	445	475	520	590	395	425	475	520	345	360	410	460	510	540	590	670
M1	—	—	—	—	—	—	—	—	170	180	200	230	155	170	190	215	220	235	255	295
	—	—	—	—	—	—	—	—	560	590	660	750	510	560	620	710	720	770	840	970
M2	—	—	—	—	—	—	—	—	140	155	165	195	130	145	155	180	180	195	215	245
	—	—	—	—	—	—	—	—	460	510	540	640	425	475	510	590	590	640	710	800
M3	—	—	—	—	—	—	—	—	115	125	135	160	110	115	130	145	145	160	175	195
	—	—	—	—	—	—	—	—	375	410	445	520	360	375	425	475	475	520	570	640
M4	—	—	—	—	—	—	—	—	90	95	105	120	85	90	100	115	115	120	135	155
	—	—	—	—	—	—	—	—	295	310	345	395	280	295	330	375	375	395	445	510
M5	—	—	—	—	—	—	—	—	75	80	90	100	70	75	85	95	95	100	110	125
	—	—	—	—	—	—	—	—	245	260	295	330	230	245	280	310	310	330	360	410
K1	260	285	315	355	210	225	250	285	185	200	220	250	160	175	195	220	—	—	—	—
	850	940	1025	1175	690	740	820	940	610	660	720	820	520	570	640	720	—	—	—	—
K2	235	255	280	320	190	205	220	255	165	180	195	225	145	160	170	200	—	—	—	—
	770	840	920	1050	620	670	720	840	540	590	640	740	475	520	560	660	—	—	—	—
K3	200	215	235	275	160	175	190	215	140	155	165	190	125	135	145	170	—	—	—	—
	660	710	770	900	520	570	620	710	460	510	540	620	410	445	475	560	—	—	—	—
K4	190	205	225	260	155	165	180	205	135	145	160	185	120	125	140	160	—	—	—	—
	620	670	740	850	510	540	590	670	445	475	520	610	395	410	460	520	—	—	—	—
K5	120	125	140	160	95	100	110	125	85	90	95	110	70	80	85	95	—	—	—	—
	395	410	460	520	310	330	360	410	280	295	310	360	230	260	280	310	—	—	—	—
K6	170	180	200	230	135	145	160	185	120	130	140	160	105	110	120	140	—	—	—	—
	560	590	660	750	445	475	520	610	395	425	460	520	345	360	395	460	—	—	—	—
K7	150	165	175	205	120	130	140	160	105	115	125	145	95	100	110	125	—	—	—	—
	490	540	570	670	395	425	460	520	345	375	410	475	310	330	360	410	—	—	—	—
H5	—	—	—	—	45	48	55	60	36	39	43	49	34	37	41	46	—	—	—	—
	—	—	—	—	150	155	180	195	120	130	140	160	110	120	135	150	—	—	—	—
H8	—	—	—	—	49	50	60	65	39	42	47	50	38	40	45	50	—	—	—	—
	—	—	—	—	160	165	195	215	130	140	155	165	125	130	150	165	—	—	—	—
H11	—	—	—	—	55	60	70	75	46	49	55	60	44	47	55	60	—	—	—	—
	—	—	—	—	180	195	230	245	150	160	180	195	145	155	180	195	—	—	—	—
H12	—	—	—	—	85	95	105	115	75	85	90	105	65	75	80	90	100	105	115	130
	—	—	—	—	280	310	345	375	245	280	295	345	215	245	260	295	330	345	375	425

R217/220.88-12 – Cutting data $v_c = (m/min)/(sf/min)$

SMG	F40M				MP3000				MS2050				MK2050			
	80%	60%	40%	20%	80%	60%	40%	20%	80%	60%	40%	20%	80%	60%	40%	20%
P1	215	235	260	295	270	290	325	370	230	250	275	310	280	305	340	380
	710	770	850	970	890	950	1075	1225	750	820	900	1025	920	1000	1125	1250
P2	210	230	250	285	265	285	310	360	225	240	265	305	275	295	325	370
	690	750	820	940	870	940	1025	1175	740	790	870	1000	900	970	1075	1225
P3	185	200	220	250	230	250	275	310	195	210	230	265	240	260	285	325
	610	660	720	820	750	820	900	1025	640	690	750	870	790	850	940	1075
P4	165	175	195	220	205	220	245	275	175	185	210	235	210	230	255	285
	540	570	640	720	670	720	800	900	570	610	690	770	690	750	840	940
P5	155	170	185	215	195	210	235	265	165	180	200	225	205	220	245	275
	510	560	610	710	640	690	770	870	540	590	660	740	670	720	800	900
P6	175	190	210	240	220	235	260	300	185	200	225	255	225	245	275	310
	570	620	690	790	720	770	850	980	610	660	740	840	740	800	900	1025
P7	165	180	200	225	205	220	250	280	175	190	210	240	215	230	260	295
	540	590	660	740	670	720	820	920	570	620	690	790	710	750	850	970
P8	155	170	185	210	195	210	230	265	165	180	195	225	205	220	240	275
	510	560	610	690	640	690	750	870	540	590	640	740	670	720	790	900
P11	160	175	195	220	200	215	240	275	170	185	205	235	210	225	250	285
	520	570	640	720	660	710	790	900	560	610	670	770	690	740	820	940
P12	105	115	125	140	135	145	160	175	115	120	135	150	140	150	165	185
	345	375	410	460	445	475	520	570	375	395	445	490	460	490	540	610
M1	170	185	200	230	195	215	235	270	180	195	215	245	—	—	—	—
	560	610	660	750	640	710	770	890	590	640	710	800	—	—	—	—
M2	140	150	170	190	165	175	195	225	150	160	180	205	—	—	—	—
	460	490	560	620	540	570	640	740	490	520	590	670	—	—	—	—
M3	115	125	135	155	135	145	160	180	120	130	145	165	—	—	—	—
	375	410	445	510	445	475	520	590	395	425	475	540	—	—	—	—
M4	90	95	105	120	105	110	120	140	95	100	110	125	—	—	—	—
	295	310	345	395	345	360	395	460	310	330	360	410	—	—	—	—
M5	75	80	90	100	85	90	100	115	80	85	95	105	—	—	—	—
	245	260	295	330	280	295	330	375	260	280	310	345	—	—	—	—
K1	165	180	200	225	210	225	245	285	—	—	—	—	295	320	350	400
	540	590	660	740	690	740	800	940	—	—	—	—	970	1050	1150	1300
K2	150	160	180	200	185	200	220	255	—	—	—	—	260	280	315	360
	490	520	590	660	610	660	720	840	—	—	—	—	850	920	1025	1175
K3	125	135	150	170	155	170	190	215	—	—	—	—	220	240	265	305
	410	445	490	560	510	560	620	710	—	—	—	—	720	790	870	1000
K4	120	130	145	165	150	160	180	205	—	—	—	—	210	230	255	290
	395	425	475	540	490	520	590	670	—	—	—	—	690	750	840	950
K5	75	80	85	100	95	100	110	125	—	—	—	—	130	140	155	175
	245	260	280	330	310	330	360	410	—	—	—	—	425	460	510	570
K6	105	115	125	145	130	140	160	180	—	—	—	—	185	200	225	255
	345	375	410	475	425	460	520	590	—	—	—	—	610	660	740	840
K7	95	100	110	125	120	130	140	160	—	—	—	—	170	180	195	225
	310	330	360	410	395	425	460	520	—	—	—	—	560	590	640	740
H5	35	38	42	47	41	44	49	55	—	—	—	—	—	—	—	—
	115	125	140	155	135	145	160	180	—	—	—	—	—	—	—	—
H8	38	41	44	50	45	48	50	60	—	—	—	—	—	—	—	—
	125	135	145	165	150	155	165	195	—	—	—	—	—	—	—	—
H11	45	48	55	60	55	55	65	70	—	—	—	—	—	—	—	—
	150	155	180	195	180	180	215	230	—	—	—	—	—	—	—	—
H12	70	75	80	90	85	90	100	115	—	—	—	—	—	—	—	—
	230	245	260	295	280	295	330	375	—	—	—	—	—	—	—	—

Square shoulder and slot milling cutters
Helical milling cutters
Face milling cutters
Disc milling cutters
High feed milling cutters
Copy milling cutters
Plunge milling cutters
Chamfer milling cutters
Spot facing cutters
Inserts

R220.88-16 – Metric

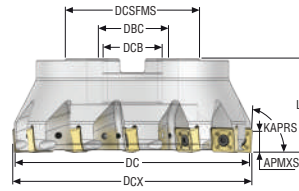

- For insert selection and cutting data recommendations, see page(s) 306-307
- For complete insert programme, see page(s) 856
- For ISO attribute explanation, see page 16

Designation	Item number	Type of mounting	DC	ZEFP	APMXS	KAPRS°	DCX	DCB	DCSFMS	LF	RPMX	Weight	Insert
			mm		mm		mm	mm	mm	mm		kg	
R220.88-0063-16-5SAP	10134810	Arbor	63,0	5	13,0	88,0	64,75	22,0	47,0	40,0	7100	0,5	SN.U1606
R220.88-0080-16-6SAP	10134811	Arbor	80,0	6	13,0	88,0	81,62	27,0	62,0	50,0	6300	1,5	SN.U1606
R220.88-0080-16-7SAP	10134812	Arbor	80,0	7	13,0	88,0	81,62	27,0	62,0	50,0	6300	1,1	SN.U1606
R220.88-0100-16-8SAP	10134813	Arbor	100,0	8	13,0	88,0	101,6	32,0	77,0	50,0	5600	1,9	SN.U1606
R220.88-0100-16-9SAP	10134814	Arbor	100,0	9	13,0	88,0	101,6	32,0	77,0	50,0	5600	1,8	SN.U1606
R220.88-0125-16-10SAP	10134815	Arbor	125,0	10	13,0	88,0	126,6	40,0	90,0	63,0	5000	3,6	SN.U1606
R220.88-0125-16-11SAP	10134816	Arbor	125,0	11	13,0	88,0	126,6	40,0	90,0	63,0	5000	3,6	SN.U1606
R220.88-8160-16-12SAP	10134817	Arbor	160,0	12	13,0	88,0	161,58	40,0	90,0	63,0	4400	5,9	SN.U1204
R220.88-8160-16-13SAP	10134818	Arbor	160,0	13	13,0	88,0	161,58	40,0	90,0	63,0	4400	5,4	SN.U1204

Spare Parts, included in delivery

For cutter	Arbor screw	Insert key	Insert screw	Lid	Lid screw
R220.88-0063	220.17-692	1/4HEX-T20PX50	C05013-T20P	-	-
R220.88-0080	MC6S12X35	1/4HEX-T20PX90	C05013-T20P	-	-
R220.88-0100	MC6S16X35	1/4HEX-T20PX90	C05013-T20P	-	-
R220.88-0125	MC6S20X40	1/4HEX-T20PX90	C05013-T20P	-	-
R220.88-8160	-	1/4HEX-T20PX90	C05013-T20P	SC-160-90	MF6S4X10

Accessories

For cutter	Adjustable Torque key	Adjustable Torque key 2	Arbor screw	Insert clamping torque	Torque key
R220.88-0063-0125	1/4HEX-S-HANDLE-0.8-5.0NM	1/4HEX-T-HANDLE-5.0-14.0NM	-	5.0NM	T00-20P50
R220.88-8160	1/4HEX-S-HANDLE-0.8-5.0NM	1/4HEX-T-HANDLE-5.0-14.0NM	MC6S12X40	5.0NM	T00-20P50

Torque and fixed keys, see page 894



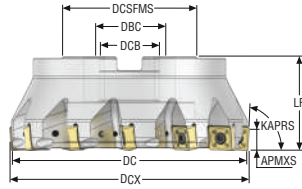

R220.88-16 – inch





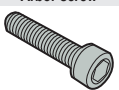

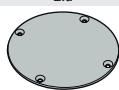
- For insert selection and cutting data recommendations, see page(s) 306-307
- For complete insert programme, see page(s) 856
- For ISO attribute explanation, see page 16

Designation	Item number	Type of mounting	DC	ZEFP	APMXS	KAPRS*	DCX	DCB	DCSFMS	LF	RPMX	Weight	Insert
			inch		inch		inch	inch	inch	inch		lbs	
R220.88-03.00-16-6SAP	10134819	Arbor	3.000	6	0.512	88.0	3.064	1.000	2.441	1.969	6300	2.430	SN.U1606
R220.88-03.00-16-7SAP	10134820	Arbor	3.000	7	0.512	88.0	3.064	1.000	2.441	1.969	6300	2.430	SN.U1606
R220.88-04.00-16-8SAP	10134821	Arbor	4.000	8	0.512	88.0	4.063	1.500	3.031	1.969	5600	3.970	SN.U1606
R220.88-04.00-16-9SAP	10134822	Arbor	4.000	9	0.512	88.0	4.063	1.500	3.031	1.969	5600	3.970	SN.U1606
R220.88-05.00-16-10SAP	10134823	Arbor	5.000	10	0.512	88.0	5.063	1.500	3.543	2.480	5000	8.160	SN.U1606
R220.88-05.00-16-11SAP	10134824	Arbor	5.000	11	0.512	88.0	5.063	1.500	3.543	2.480	5000	8.160	SN.U1606
R220.88-06.00-16-12SAP	10134825	Arbor	6.000	12	0.512	88.0	6.062	2.000	4.331	2.480	4400	10.580	SN.U1204
R220.88-06.00-16-13SAP	10134826	Arbor	6.000	13	0.512	88.0	6.062	2.000	4.331	2.480	4400	10.580	SN.U1204

Spare Parts, included in delivery

For cutter	Arbor screw	Insert key	Insert screw	Lid	Lid screw
R220.88-03.00					
R220.88-03.00	UC6S1/2UNFX1-1/4	1/4HEX-T20PX90	C05013-T20P	-	-
R220.88-04.00	UC6S3/4UNFX1-1/4	1/4HEX-T20PX90	C05013-T20P	-	-
R220.88-05.00	UC6S3/4UNFX1-1/4	1/4HEX-T20PX90	C05013-T20P	-	-
R220.88-06.00	-	1/4HEX-T20PX90	C05013-T20P	SC-160-90	MF6S4X10

Accessories

For cutter	Adjustable Torque key	Adjustable Torque key 2	Arbor screw	Insert clamping torque	Torque key
R220.88-03.00-05.00					
R220.88-03.00-05.00	1/4HEX-S-HANDLE-0.8-5.0NM	1/4HEX-T-HANDLE-5.0-14.0NM	-	44.3IN.LBS	T00-20P50
R220.88-06.00	1/4HEX-S-HANDLE-0.8-5.0NM	1/4HEX-T-HANDLE-5.0-14.0NM	58215080	44.3IN.LBS	T00-20P50

Torque and fixed keys, see page 894

R220.88-16 – Insert selection – mm/Inch

SMG		a _p	f _z			
			80%	60%	40%	20%
P1	SNMU160612TN-M10 MP2501	8,0	0,16	0,16	0,16	0,20
		0,32	0,0065	0,0065	0,0065	0,0080
P2	SNMU160612TN-M10 MP2501	8,0	0,16	0,16	0,16	0,20
		0,32	0,0065	0,0065	0,0065	0,0080
P3	SNMU160612TN-M10 MP2501	8,0	0,15	0,15	0,15	0,19
		0,32	0,0060	0,0060	0,0060	0,0075
P4	SNMU160612TN-M18 MP2501	8,0	0,26	0,26	0,26	0,32
		0,32	0,010	0,010	0,010	0,013
P5	SNMU160612TN-M18 MP2501	8,0	0,25	0,25	0,26	0,32
		0,32	0,010	0,010	0,010	0,013
P6	SNMU160612TN-M18 MP2501	8,0	0,25	0,25	0,25	0,32
		0,32	0,010	0,010	0,010	0,013
P7	SNMU160612TN-M18 T350M	8,0	0,25	0,25	0,25	0,32
		0,32	0,010	0,010	0,010	0,013
P8	SNMU160612TN-M18 T350M	8,0	0,26	0,26	0,26	0,32
		0,32	0,010	0,010	0,010	0,013
P11	SNMU160612TN-M18 T350M	8,0	0,25	0,25	0,25	0,32
		0,32	0,010	0,010	0,010	0,013
P12	SNMU160612TN-M18 T350M	6,0	0,17	0,17	0,18	0,22
		0,24	0,0065	0,0065	0,0070	0,0085
K1	SNMU160612TN-M18 MK1500	8,0	0,28	0,28	0,28	0,34
		0,32	0,011	0,011	0,011	0,013
K2	SNMU160612TN-M18 MK1500	8,0	0,25	0,25	0,26	0,32
		0,32	0,010	0,010	0,010	0,013
K3	SNMU160612TN-M18 MP1501	8,0	0,25	0,25	0,26	0,32
		0,32	0,010	0,010	0,010	0,013
K4	SNMU160612TN-M18 MP1501	8,0	0,25	0,25	0,26	0,32
		0,32	0,010	0,010	0,010	0,013
K5	SNMU160612TN-M18 MK2050	8,0	0,22	0,22	0,24	0,28
		0,32	0,0085	0,0085	0,0095	0,011
K6	SNMU160612TN-M18 MK2050	8,0	0,25	0,25	0,26	0,32
		0,32	0,010	0,010	0,010	0,013
K7	SNMU160612TN-M18 MK2050	8,0	0,22	0,22	0,24	0,28
		0,32	0,0085	0,0085	0,0095	0,011
H5	SNMU160612TN-MD16 MP1501	6,0	0,18	0,18	0,19	0,22
		0,24	0,0070	0,0070	0,0075	0,0085
H8	SNMU160612TN-MD16 MP1501	5,0	0,14	0,14	0,14	0,18
		0,20	0,0055	0,0055	0,0055	0,0070
H11	SNMU160612TN-MD16 MP1501	6,0	0,18	0,18	0,19	0,22
		0,24	0,0070	0,0070	0,0075	0,0085
H12	SNMU160612TN-MD16 MP1501	5,0	0,14	0,14	0,14	0,18
		0,20	0,0055	0,0055	0,0055	0,0070
H21	SNMU160612TN-MD16 MP1501	5,0	0,14	0,14	0,14	0,18
		0,20	0,0055	0,0055	0,0055	0,0070

SMG = Seco material group
 f_z = mm/tooth (in/tooth), v_c = m/min (sf/min), a_p/DC = %
 All cutting data are start values

Square shoulder and slot milling cutters
 Helical milling cutters
 Face milling cutters
 Disc milling cutters
 High feed milling cutters
 Copy milling cutters
 Plunge milling cutters
 Chamfer milling cutters
 Spot facing cutters
 Inserts

R217/220.88-16 – Cutting data $v_c = (m/min)/(sf/min)$

SMG	MK1500				MP1501				MP2501				T350M			
	80%	60%	40%	20%	80%	60%	40%	20%	80%	60%	40%	20%	80%	60%	40%	20%
P1	—	—	—	—	260	280	315	360	230	250	280	320	200	215	245	280
	—	—	—	—	850	920	1025	1175	750	820	920	1050	660	710	800	920
P2	—	—	—	—	255	275	305	350	225	240	270	310	195	210	235	270
	—	—	—	—	840	900	1000	1150	740	790	890	1025	640	690	770	890
P3	—	—	—	—	225	240	270	310	200	215	240	275	170	185	210	240
	—	—	—	—	740	790	890	1025	660	710	790	900	560	610	690	790
P4	—	—	—	—	195	215	240	270	175	190	210	240	150	165	185	210
	—	—	—	—	640	710	790	890	570	620	690	790	490	540	610	690
P5	—	—	—	—	190	205	230	260	170	180	200	230	145	160	175	200
	—	—	—	—	620	670	750	850	560	590	660	750	475	520	570	660
P6	—	—	—	—	215	230	260	290	190	205	230	260	165	180	200	225
	—	—	—	—	710	750	850	950	620	670	750	850	540	590	660	740
P7	—	—	—	—	200	220	245	275	180	195	215	245	155	170	190	210
	—	—	—	—	660	720	800	900	590	640	710	800	510	560	620	690
P8	—	—	—	—	190	205	230	260	165	180	200	230	145	155	175	200
	—	—	—	—	620	670	750	850	540	590	660	750	475	510	570	660
P11	—	—	—	—	195	210	235	265	175	190	210	235	150	165	185	205
	—	—	—	—	640	690	770	870	570	620	690	770	490	540	610	670
P12	—	—	—	—	130	145	155	175	115	125	140	155	100	110	120	135
	—	—	—	—	425	475	510	570	375	410	460	510	330	360	395	445
K1	250	270	305	350	200	215	245	280	175	190	215	245	155	165	190	215
	820	890	1000	1150	660	710	800	920	570	620	710	800	510	540	620	710
K2	225	245	270	310	180	195	215	245	160	175	190	220	140	150	165	190
	740	800	890	1025	590	640	710	800	520	570	620	720	460	490	540	620
K3	190	205	230	260	155	165	185	210	135	145	160	185	120	125	140	160
	620	670	750	850	510	540	610	690	445	475	520	610	395	410	460	520
K4	185	200	220	250	145	160	175	200	130	140	155	175	115	120	135	155
	610	660	720	820	475	520	570	660	425	460	510	570	375	395	445	510
K5	115	125	135	155	90	100	105	125	80	85	95	110	70	75	80	95
	375	410	445	510	295	330	345	410	260	280	310	360	230	245	260	310
K6	160	175	195	220	130	140	155	175	115	125	135	155	100	105	120	135
	520	570	640	720	425	460	510	570	375	410	445	510	330	345	395	445
K7	145	155	170	200	115	125	135	160	105	110	120	140	90	95	105	120
	475	510	560	660	375	410	445	520	345	360	395	460	295	310	345	395
H5	—	—	—	—	44	47	50	60	35	38	42	47	34	37	40	45
	—	—	—	—	145	155	165	195	115	125	140	155	110	120	130	150
H11	—	—	—	—	55	60	65	75	45	49	55	60	43	47	50	60
	—	—	—	—	180	195	215	245	150	160	180	195	140	155	165	195
H12	—	—	—	—	85	90	100	115	75	80	90	100	65	70	80	90
	—	—	—	—	280	295	330	375	245	260	295	330	215	230	260	295

Square shoulder and slot milling cutters
Helical milling cutters
Face milling cutters
Disc milling cutters
High feed milling cutters
Copy milling cutters
Plunge milling cutters
Chamfer milling cutters
Spot facing cutters
Inserts

R217/220.88-16 – Cutting data $v_c = (m/min)/(sf/min)$

SMG	F40M				MP3000				MK2050			
	80%	60%	40%	20%	80%	60%	40%	20%	80%	60%	40%	20%
P1	175	190	210	240	265	285	315	355	225	245	275	315
	570	620	690	790	870	940	1025	1175	740	800	900	1025
P2	170	185	205	235	255	275	305	345	220	240	270	305
	560	610	670	770	840	900	1000	1125	720	790	890	1000
P3	150	160	180	205	225	240	270	305	195	210	235	270
	490	520	590	670	740	790	890	1000	640	690	770	890
P4	130	145	160	180	200	215	235	265	170	185	210	235
	425	475	520	590	660	710	770	870	560	610	690	770
P5	130	140	155	175	190	205	225	260	165	180	200	225
	425	460	510	570	620	670	740	850	540	590	660	740
P6	145	155	175	195	215	235	255	290	185	200	225	255
	475	510	570	640	710	770	840	950	610	660	740	840
P7	135	145	165	185	205	220	240	275	175	190	215	240
	445	475	540	610	670	720	790	900	570	620	710	790
P8	125	135	155	175	190	205	225	255	165	175	200	225
	410	445	510	570	620	670	740	840	540	570	660	740
P11	130	140	160	180	200	215	235	265	170	185	205	235
	425	460	520	590	660	710	770	870	560	610	670	770
P12	90	95	105	120	130	140	155	175	115	125	135	155
	295	310	345	395	425	460	510	570	375	410	445	510
M1	135	150	165	190	190	205	230	260	—	—	—	—
	445	490	540	620	620	670	750	850	—	—	—	—
M2	115	125	135	155	160	170	190	215	—	—	—	—
	375	410	445	510	520	560	620	710	—	—	—	—
M3	95	105	115	130	130	140	155	175	—	—	—	—
	310	345	375	425	425	460	510	570	—	—	—	—
M4	75	80	90	100	100	110	120	135	—	—	—	—
	245	260	295	330	330	360	395	445	—	—	—	—
M5	60	65	75	85	85	90	100	110	—	—	—	—
	195	215	245	280	280	295	330	360	—	—	—	—
K1	135	145	165	185	200	220	245	275	240	255	290	330
	445	475	540	610	660	720	800	900	790	840	950	1075
K2	120	130	145	165	180	195	215	245	215	230	255	290
	395	425	475	540	590	640	710	800	710	750	840	950
K3	105	110	125	140	150	165	180	210	180	195	215	245
	345	360	410	460	490	540	590	690	590	640	710	800
K4	100	105	115	135	145	155	175	200	175	185	205	235
	330	345	375	445	475	510	570	660	570	610	670	770
K5	60	65	70	85	90	95	110	120	110	115	125	145
	195	215	230	280	295	310	360	395	360	375	410	475
K6	85	95	105	115	125	135	155	175	155	165	185	210
	280	310	345	375	410	445	510	570	510	540	610	690
K7	80	85	90	105	115	125	140	155	140	150	160	190
	260	280	295	345	375	410	460	510	460	490	520	620
H5	29	32	35	39	40	43	48	55	—	—	—	—
	95	105	115	130	130	140	155	180	—	—	—	—
H8	32	34	38	43	43	47	50	55	—	—	—	—
	105	110	125	140	140	155	165	180	—	—	—	—
H11	37	40	44	50	50	55	60	70	—	—	—	—
	120	130	145	165	165	180	195	230	—	—	—	—
H12	55	60	70	75	85	90	95	110	—	—	—	—
	180	195	230	245	280	295	310	360	—	—	—	—



OCTOMILL 05/07

Octomill™ 05 and 07 provide one of the most comprehensive ranges of face milling cutters on the market. Designed to handle many applications, Octomill 05 and 07 offer high performance and process security. These cutters excel in medium to rough machining in steel and stainless steel. With eight edges, the cutters are more economical than traditional cutters due to a lower cost per cutting edge.

- Insert size 05, cutter range 32-315mm (1.5-4 inch)
- Insert size 07, cutter range 50-315mm (2.5-6 inch)
- Octomill 05 is for small machines and Octomill 07 is for medium sized machines

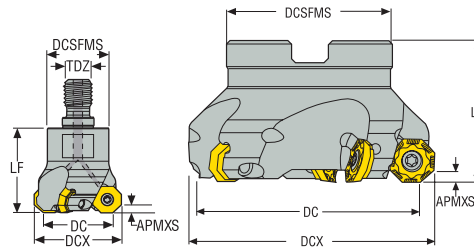

Octomill R217/R220.43-05 – Metric





- For insert selection and cutting data recommendations, see page(s) 315 - 317
- For complete insert programme, see page(s) 837
- For ISO attribute explanation, see page 16

Designation	Item number	Type of mounting	DC	ZEFP	APMXS	KAPRS°	DCX	DCB	TDZ	DCSFMS	LF	RPMX	Weight	Insert
			mm		mm		mm	mm		mm	mm		kg	
R217.43-1632.RE-05.3A	00005768	Combimaster	32,0	3	3,5	43,0	40,0	–	M16	30,0	40,0	14800	0,3	OFEX/OFMT05
R217.43-1642.RE-05.3A	00005769	Combimaster	42,0	3	3,5	43,0	50,0	–	M16	30,0	40,0	13000	0,3	OFEX/OFMT05
R220.43-0032-05	75069157	Arbor	32,0	3	3,5	43,0	41,0	16,0	–	35,0	40,0	14800	0,2	OFEX/OFMT05
R220.43-0040-05	75069158	Arbor	40,0	3	3,5	43,0	49,0	16,0	–	35,0	40,0	13200	0,3	OFEX/OFMT05
R220.43-0040-05-4A	00026516	Arbor	40,0	4	3,5	43,0	49,0	16,0	–	35,0	40,0	13200	0,3	OFEX/OFMT05
R220.43-0050-05	75069159	Arbor	50,0	4	3,5	43,0	59,0	22,0	–	47,0	40,0	11900	0,4	OFEX/OFMT05
R220.43-0050-05-5A	00026517	Arbor	50,0	5	3,5	43,0	59,0	22,0	–	47,0	40,0	11900	0,4	OFEX/OFMT05
R220.43-0063-05	75069160	Arbor	63,0	5	3,5	43,0	72,0	22,0	–	47,0	40,0	10600	0,6	OFEX/OFMT05
R220.43-0063-05-6A	00026518	Arbor	63,0	6	3,5	43,0	72,0	22,0	–	47,0	40,0	10600	0,5	OFEX/OFMT05
R220.43-0080-05	75069161	Arbor	80,0	6	3,5	43,0	89,0	27,0	–	62,0	50,0	9400	1,1	OFEX/OFMT05
R220.43-0080-05-8A	00026519	Arbor	80,0	8	3,5	43,0	89,0	27,0	–	62,0	50,0	9400	1,1	OFEX/OFMT05
R220.43-0100-05	75069162	Arbor	100,0	7	3,5	43,0	109,0	32,0	–	77,0	50,0	8400	1,8	OFEX/OFMT05
R220.43-0125-05	75079618	Arbor	125,0	8	3,5	43,0	134,0	40,0	–	90,0	63,0	7500	3,3	OFEX/OFMT05
R220.43-8160-05	75080766	Arbor	160,0	10	3,5	43,0	169,0	40,0	–	90,0	63,0	6600	5,1	OFEX/OFMT05

Spare Parts, included in delivery

For cutter	Arbor screw	Insert key	Insert screw
			
R217.43-..	-	H4B-T15P	C04008-T15P
R220.43-0032	220.17-690	H4B-T15P	C04008-T15P
R220.43-0040	TCEI0825	H4B-T15P	C04008-T15P
R220.43-0050-0063	220.17-692	H4B-T15P	C04008-T15P
R220.43-0080-0125	-	H4B-T15P	C04008-T15P
R220.43-0080-0125	-	H4B-T15PL	C04008-T15P
R220.43-8160	-	H4B-T15PL	C04008-T15P

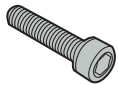
Accessories

For cutter	Arbor screw	Insert clamping torque	Torque key
			
R217/220.43-0032-0125	-	3.5NM	T00-15P35
R220.43-8160	MC6S12X40	3.5NM	T00-15P35

Torque and fixed keys, see page 894

- Square shoulder and slot milling cutters
- Helical milling cutters
- Face milling cutters
- Disc milling cutters
- High feed milling cutters
- Copy milling cutters
- Plunge milling cutters
- Chamfer milling cutters
- Spot facing cutters
- Inserts

Octomill R220.43-05 – inch

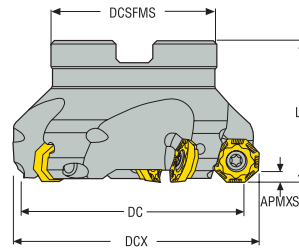

- For insert selection and cutting data recommendations, see page(s) 315 - 317
- For complete insert programme, see page(s) 837
- For ISO attribute explanation, see page 16

Designation	Item number	Type of mounting	DC	ZEFP	APMXS	KAPRS°	DCX	DCB	DCSFMS	LF	RPMX	Weight	Insert
			inch		inch		inch	inch	inch	inch		lbs	
R220.43-01.50-05	00086837	Arbor	1.575	3	0.138	43.0	2.047	0.500	1.378	1.575	13200	0.880	OFEX/OFMT05
R220.43-02.00-05	00086838	Arbor	1.969	4	0.138	43.0	2.441	0.750	1.850	1.575	11900	1.100	OFEX/OFMT05
R220.43-02.50-05	00086839	Arbor	2.480	5	0.138	43.0	2.953	0.750	1.850	1.575	10600	1.320	OFEX/OFMT05
R220.43-03.00-05	00086840	Arbor	3.150	6	0.138	43.0	3.622	1.000	2.441	1.969	9400	2.870	OFEX/OFMT05
R220.43-04.00-05	00086841	Arbor	3.937	7	0.138	43.0	4.291	1.500	3.543	1.969	8400	4.190	OFEX/OFMT05

Spare Parts, included in delivery

For cutter	Arbor screw	Insert key	Insert screw
R220.43-1.50	UC6S1/4UNFX1	H4B-T15P	C04008-T15P
R220.43-02.00	UC6S3/8UNFX1	H4B-T15P	C04008-T15P
R220.43-02.50-04.00	-	H4B-T15P	C04008-T15P
R220.43-02.50-04.00	-	H4B-T15PL	C04008-T15P

Accessories

For cutter	Insert clamping torque	Torque key
R220.43-1.50	31.0IN.LBS	T00-15P35
R220.43-02.00-02.50	31.0IN.LBS	T00-15P35
R220.43-03.00-04.00	31.0IN.LBS	T00-15P35

Torque and fixed keys, see page 894

Octomill R220.43-05C/CT/CG – Metric

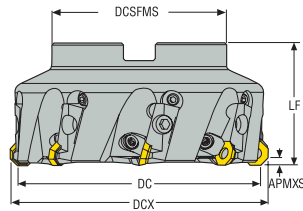

- For insert selection and cutting data recommendations, see page(s) 315 - 317
- For complete insert programme, see page(s) 837
- For ISO attribute explanation, see page 16

Designation	Item number	Type of mounting	DC	ZEFP	APMXS	KAPRS°	DCX	DCB	DCSFMS	LF	RPMX	Weight	Insert
			mm		mm		mm	mm	mm	mm		kg	
R220.43-0100-05C	00090985	Arbor	100,0	6	3,5	43,0	109,0	32,0	77,0	50,0	4300	2,5	OFEX05T305
R220.43-0125-05C	00090988	Arbor	125,0	8	3,5	43,0	134,0	40,0	90,0	63,0	3800	3,7	OFEX05T305
R220.43-0125-05CT	00090989	Arbor	125,0	10	3,5	43,0	134,0	40,0	90,0	63,0	3800	4,0	OFEX05T305
R220.43-8160-05C	00090991	Arbor	160,0	10	3,5	43,0	169,0	40,0	90,0	63,0	3300	5,8	OFEX05T305
R220.43-8160-05CT	00090992	Arbor	160,0	14	3,5	43,0	169,0	40,0	90,0	63,0	3300	5,8	OFEX05T305
R220.43-8160-05CG	00090990	Arbor	160,0	7	3,5	43,0	169,0	40,0	90,0	63,0	3300	5,9	OFEX05T305
R220.43-8200-05C	00090994	Arbor	200,0	12	3,5	43,0	209,0	60,0	130,0	63,0	3000	8,4	OFEX05T305
R220.43-8200-05CT	00090995	Arbor	200,0	18	3,5	43,0	209,0	60,0	130,0	63,0	3000	7,4	OFEX05T305
R220.43-8250-05C	00090997	Arbor	250,0	16	3,5	43,0	259,0	60,0	130,0	63,0	2700	14,3	OFEX05T305
R220.43-8250-05CT	00090998	Arbor	250,0	22	3,5	43,0	259,0	60,0	130,0	63,0	2700	19,0	OFEX05T305
R220.43-8315-05C	00091000	Arbor	315,0	20	3,5	43,0	324,0	60,0	225,0	80,0	2400	28,0	OFEX05T305
R220.43-8315-05CT	00091001	Arbor	315,0	28	3,5	43,0	324,0	60,0	225,0	80,0	2400	27,5	OFEX05T305

Square shoulder and slot milling cutters

Helical milling cutters

Face milling cutters

Disc milling cutters

High feed milling cutters

Copy milling cutters

Plunge milling cutters

Chamfer milling cutters

Spot facing cutters

Inserts

Spare Parts, included in delivery

For cutter	Adjustment unit	Arbor screw	Cassette	Cassette screw	Insert wedge	Wedge screw
R220.43-0100	AU1114T-T15P	MC6S16X35	OF05AR	FS96018	CW0810	LD8020-T25P
R220.43-0125C	AU1114T-T15P	-	OF05AR	FS96018	CW0810	LD8020-T25P
R220.43-0125	AU1114T-T15P	-	OF05AR	FS96018	334.5-640	LD8020-T25P
R220.43-8160C/CG	AU1114T-T15P	-	OF05AR	FS96018	CW0810	LD8020-T25P
R220.43-8160CT	AU1114T-T15P	-	OF05AR	FS96018	334.5-640	LD8020-T25P
R220.43-8200-8250C/CG	AU1114T-T15P	-	OF05AR	FS96018	CW0810	LD8020-T25P
R220.43-8200-8250CT	AU1114T-T15P	-	OF05AR	FS96018	334.5-640	LD8020-T25P
R220.43-8315-05C	AU1114T-T15P	-	OF05AR	FS96018	CW0810	LD8020-T25P
R220.43-8315-05CT	AU1114T-T15P	-	OF05AR	FS96018	334.5-640	LD8020-T25P

Accessories

For cutter	Arbor screw	Arbor screw 2	Nest key	Setting key
R220.43-0100-0125C	-	-	H05-4	T15P-4
R220.43-0125CT	-	-	-	T15P-4
R220.43-8160C/CG	MC6S12X40	-	H05-4	T15P-4
R220.43-8160CT	MC6S12X40	-	-	T15P-4
R220.43-8200-8250C/CG	MC6S16X50	-	H05-4	T15P-4
R220.43-8200-8250CT	MC6S16X50	-	-	T15P-4
R220.43-8315-05C	MC6S16X50	MC6S20X50	H05-4	T15P-4
R220.43-8315-05CT	MC6S16X50	MC6S20X50	-	T15P-4

Torque and fixed keys, see page 894

R220.43-05 – Insert selection – mm/Inch

SMG		a _p	f _z			
			80%	60%	40%	20%
P1	OFEX05T305TN-M08 T350M	2,0 0,080	0,18 0,0070	0,18 0,0070	0,18 0,0070	0,22 0,0085
P2	OFEX05T305TN-M08 T350M	2,0 0,080	0,18 0,0070	0,18 0,0070	0,19 0,0075	0,24 0,0095
P3	OFEX05T305TN-M08 T350M	2,0 0,080	0,17 0,0065	0,17 0,0065	0,18 0,0070	0,22 0,0085
P4	OFEX05T305TN-M08 MP2501	2,0 0,080	0,17 0,0065	0,17 0,0065	0,17 0,0065	0,22 0,0085
P5	OFEX05T305TN-M08 MP2501	2,0 0,080	0,16 0,0065	0,16 0,0065	0,17 0,0065	0,20 0,0080
P6	OFEX05T305TN-M08 MP2501	2,0 0,080	0,16 0,0065	0,16 0,0065	0,17 0,0065	0,20 0,0080
P7	OFEX05T305TN-M08 MP2501	2,0 0,080	0,16 0,0065	0,16 0,0065	0,17 0,0065	0,20 0,0080
P8	OFEX05T305TN-M08 T350M	2,0 0,080	0,17 0,0065	0,17 0,0065	0,18 0,0070	0,22 0,0085
P11	OFEX05T305TN-M08 T350M	2,0 0,080	0,16 0,0065	0,16 0,0065	0,17 0,0065	0,20 0,0080
P12	OFEX05T305TN-M08 T350M	1,7 0,065	0,11 0,0044	0,11 0,0044	0,12 0,0048	0,14 0,0055
M1	OFEX05T305N-M05 F30M	2,0 0,080	0,11 0,0044	0,11 0,0044	0,12 0,0048	0,14 0,0055
M2	OFEX05T305N-M05 F30M	2,0 0,080	0,10 0,0040	0,10 0,0040	0,11 0,0044	0,13 0,0050
M3	OFEX05T305TN-ME07 F40M	1,7 0,065	0,12 0,0048	0,12 0,0048	0,12 0,0048	0,15 0,0060
M4	OFEX05T305TN-ME07 F40M	1,3 0,050	0,11 0,0044	0,11 0,0044	0,11 0,0044	0,13 0,0050
M5	OFEX05T305TN-ME07 F40M	1,3 0,050	0,11 0,0044	0,11 0,0044	0,11 0,0044	0,13 0,0050
K1	OFEX05T305TN-M08 MK1500	2,0 0,080	0,18 0,0070	0,18 0,0070	0,19 0,0075	0,24 0,0095
K2	OFEX05T305TN-M08 MK1500	2,0 0,080	0,17 0,0065	0,17 0,0065	0,17 0,0065	0,20 0,0080
K3	OFEX05T305TN-D09 MP1501	2,0 0,080	0,19 0,0075	0,19 0,0075	0,19 0,0075	0,24 0,0095
K4	OFEX05T305TN-D09 MP1501	2,0 0,080	0,19 0,0075	0,19 0,0075	0,19 0,0075	0,24 0,0095
K5	OFEX05T305TN-D09 MP1501	2,0 0,080	0,17 0,0065	0,17 0,0065	0,17 0,0065	0,22 0,0085
K6	OFEX05T305TN-D09 MP1501	2,0 0,080	0,19 0,0075	0,19 0,0075	0,19 0,0075	0,24 0,0095
K7	OFEX05T305TN-D09 MP1501	2,0 0,080	0,17 0,0065	0,17 0,0065	0,17 0,0065	0,22 0,0085
N1	OFEX05T305N-E04 H15	2,0 0,080	0,12 0,0048	0,12 0,0048	0,12 0,0048	0,15 0,0060
N2	OFEX05T305N-E04 H15	2,0 0,080	0,12 0,0048	0,12 0,0048	0,12 0,0048	0,15 0,0060
N3	OFEX05T305N-E04 H15	2,0 0,080	0,12 0,0048	0,12 0,0048	0,12 0,0048	0,15 0,0060
N11	OFEX05T305N-E04 H15	2,0 0,080	0,12 0,0048	0,12 0,0048	0,12 0,0048	0,15 0,0060
S1	OFEX05T305TN-ME07 F40M	1,3 0,050	0,11 0,0044	0,11 0,0044	0,11 0,0044	0,13 0,0050
S2	OFEX05T305TN-ME07 F40M	1,3 0,050	0,11 0,0044	0,11 0,0044	0,11 0,0044	0,13 0,0050
S3	OFEX05T305TN-ME07 F40M	1,3 0,050	0,10 0,0040	0,10 0,0040	0,10 0,0040	0,12 0,0048
S11	OFEX05T305TN-ME07 F40M	1,5 0,060	0,12 0,0048	0,12 0,0048	0,12 0,0048	0,15 0,0060
S12	OFEX05T305TN-ME07 F40M	1,5 0,060	0,12 0,0048	0,12 0,0048	0,12 0,0048	0,15 0,0060
S13	OFEX05T305TN-ME07 F40M	1,3 0,050	0,11 0,0044	0,11 0,0044	0,11 0,0044	0,13 0,0050
H5	OFEX05T305TN-D09 MP1501	1,7 0,065	0,13 0,0050	0,13 0,0050	0,13 0,0050	0,16 0,0065
H8	OFEX05T305TN-D09 MP1501	1,5 0,060	0,10 0,0040	0,10 0,0040	0,10 0,0040	0,13 0,0050
H11	OFEX05T305TN-D09 MP1501	1,7 0,065	0,13 0,0050	0,13 0,0050	0,13 0,0050	0,16 0,0065
H12	OFEX05T305TN-D09 MP1501	1,5 0,060	0,10 0,0040	0,10 0,0040	0,10 0,0040	0,13 0,0050
H21	OFEX05T305TN-D09 MP1501	1,5 0,060	0,10 0,0040	0,10 0,0040	0,10 0,0040	0,13 0,0050

SMG = Seco material group
f_z = mm/tooth (in/tooth), v_c = m/min (sf/min), a_p/DC = %
All cutting data are start values

Square shoulder and slot milling cutters
Helical milling cutters
Face milling cutters
Disc milling cutters
High feed milling cutters
Copy milling cutters
Plunge milling cutters
Chamfer milling cutters
Spot facing cutters
Inserts

R217/220.43-05 – Cutting data $v_c = (m/min)/(sf/min)$

SMG	F40M				MP1501				MP2501				T350M				T25M			
	100%	80%	60%	40%	100%	80%	60%	40%	100%	80%	60%	40%	100%	80%	60%	40%	100%	80%	60%	40%
P1	225	235	255	285	325	340	370	410	295	315	335	375	255	270	295	325	285	305	325	360
	740	770	840	940	1075	1125	1225	1350	970	1025	1100	1225	840	890	970	1075	940	1000	1075	1175
P2	220	230	250	270	315	335	360	390	290	305	330	360	250	265	285	315	280	295	315	350
	720	750	820	890	1025	1100	1175	1275	950	1000	1075	1175	820	870	940	1025	920	970	1025	1150
P3	190	200	215	235	275	290	315	345	250	265	285	315	220	230	250	275	245	260	280	310
	620	660	710	770	900	950	1025	1125	820	870	940	1025	720	750	820	900	800	850	920	1025
P4	170	180	190	210	240	255	275	305	220	235	250	280	195	205	220	245	215	225	245	270
	560	590	620	690	790	840	900	1000	720	770	820	920	640	670	720	800	710	740	800	890
P5	160	170	185	205	230	245	265	295	210	225	240	265	185	195	210	235	205	215	235	260
	520	560	610	670	750	800	870	970	690	740	790	870	610	640	690	770	670	710	770	850
P6	185	195	210	225	265	280	300	330	240	255	275	300	210	225	240	260	235	250	265	290
	610	640	690	740	870	920	980	1075	790	840	900	980	690	740	790	850	770	820	870	950
P7	170	185	195	215	250	265	285	310	230	240	260	285	200	210	225	245	220	235	250	275
	560	610	640	710	820	870	940	1025	750	790	850	940	660	690	740	800	720	770	820	900
P8	160	170	185	200	230	245	265	290	210	225	240	265	185	195	210	230	205	215	235	260
	520	560	610	660	750	800	870	950	690	740	790	870	610	640	690	750	670	710	770	850
P11	170	175	190	210	240	255	275	300	220	235	250	275	195	205	220	240	215	225	245	265
	560	570	620	690	790	840	900	980	720	770	820	900	640	670	720	790	710	740	800	870
P12	110	115	125	135	155	165	180	195	145	155	165	175	125	135	145	155	140	145	155	175
	360	375	410	445	510	540	590	640	475	510	540	570	410	445	475	510	460	475	510	570
M1	175	185	200	220	—	—	—	—	205	220	235	260	195	205	220	240	225	235	255	285
	570	610	660	720	—	—	—	—	670	720	770	850	640	670	720	790	740	770	840	940
M2	145	155	165	180	—	—	—	—	170	180	195	215	160	170	180	200	185	195	210	235
	475	510	540	590	—	—	—	—	560	590	640	710	520	560	590	660	610	640	690	770
M3	120	125	135	145	—	—	—	—	140	150	160	170	130	140	150	160	150	160	170	185
	395	410	445	475	—	—	—	—	460	490	520	560	425	460	490	520	490	520	560	610
M4	90	95	105	115	—	—	—	—	105	115	120	135	100	105	115	125	115	120	130	145
	295	310	345	375	—	—	—	—	345	375	395	445	330	345	375	410	375	395	425	475
M5	75	80	85	95	—	—	—	—	90	95	100	110	85	90	95	105	95	100	110	120
	245	260	280	310	—	—	—	—	295	310	330	360	280	295	310	345	310	330	360	395
K1	175	185	195	215	250	265	285	310	230	240	260	285	200	210	225	250	—	—	—	—
	570	610	640	710	820	870	940	1025	750	790	850	940	660	690	740	820	—	—	—	—
K2	150	160	175	190	220	230	250	280	200	210	230	255	175	185	200	220	—	—	—	—
	490	520	570	620	720	750	820	920	660	690	750	840	570	610	660	720	—	—	—	—
K3	130	135	145	165	185	195	210	235	170	180	195	215	150	155	170	185	—	—	—	—
	425	445	475	540	610	640	690	770	560	590	640	710	490	510	560	610	—	—	—	—
K4	125	130	140	155	175	190	200	225	160	170	185	205	140	150	160	180	—	—	—	—
	410	425	460	510	570	620	660	740	520	560	610	670	460	490	520	590	—	—	—	—
K5	75	80	85	95	110	115	125	140	100	105	115	125	85	90	100	110	—	—	—	—
	245	260	280	310	360	375	410	460	330	345	375	410	280	295	330	360	—	—	—	—
K6	110	115	125	135	155	165	180	200	145	150	165	180	125	130	140	155	—	—	—	—
	360	375	410	445	510	540	590	660	475	490	540	590	410	425	460	510	—	—	—	—
K7	95	105	110	120	140	150	160	175	130	135	145	160	110	120	125	140	—	—	—	—
	310	345	360	395	460	490	520	570	425	445	475	520	360	395	410	460	—	—	—	—
N1	1250	1325	1425	1600	—	—	—	—	—	—	—	—	—	—	—	—	—	—	—	—
	4100	4350	4675	5250	—	—	—	—	—	—	—	—	—	—	—	—	—	—	—	—
N2	510	540	580	640	—	—	—	—	—	—	—	—	—	—	—	—	—	—	—	—
	1675	1775	1900	2100	—	—	—	—	—	—	—	—	—	—	—	—	—	—	—	—
N3	340	355	385	430	—	—	—	—	—	—	—	—	—	—	—	—	—	—	—	—
	1125	1175	1275	1400	—	—	—	—	—	—	—	—	—	—	—	—	—	—	—	—
N11	385	410	440	490	—	—	—	—	—	—	—	—	—	—	—	—	—	—	—	—
	1275	1350	1450	1600	—	—	—	—	—	—	—	—	—	—	—	—	—	—	—	—
S1	42	45	48	55	—	—	—	—	50	55	60	65	47	49	55	60	—	—	—	—
	140	150	155	180	—	—	—	—	165	180	195	215	155	160	180	195	—	—	—	—
S2	34	36	39	43	—	—	—	—	42	45	48	55	38	40	43	47	—	—	—	—
	110	120	130	140	—	—	—	—	140	150	155	180	125	130	140	155	—	—	—	—
S3	30	32	34	38	—	—	—	—	37	39	42	46	33	35	38	41	—	—	—	—
	100	105	110	125	—	—	—	—	120	130	140	150	110	115	125	135	—	—	—	—
S11	60	60	65	75	—	—	—	—	70	75	80	90	65	70	75	80	—	—	—	—
	195	195	215	245	—	—	—	—	230	245	260	295	215	230	245	260	—	—	—	—
S12	41	43	46	50	—	—	—	—	50	55	55	65	45	47	50	55	—	—	—	—
	135	140	150	165	—	—	—	—	165	180	180	215	150	155	165	180	—	—	—	—
S13	24	25	27	30	—	—	—	—	29	31	33	37	26	28	30	33	—	—	—	—
	80	80	90	100	—	—	—	—	95	100	110	120	85	90	100	110	—	—	—	—
H5	36	38	41	45	50	55	60	65	43	46	49	55	42	44	47	50	—	—	—	—
	120	125	135	150	165	180	195	215	140	150	160	180	140	145	155	165	—	—	—	—
H8	38	40	43	48	55	60	65	70	45	48	50	55	44	46	50	55	—	—	—	—
	125	130	140	155	180	195	215	230	150	155	165	180	145	150	165	180	—	—	—	—
H11	46	49	50	55	65	70	75	85	55	60	65	70	55	55	60	65	—	—	—	—
	150	160	165	180	215	230	245	280	180	195	215	230	180	180	195	215	—	—	—	—
H12	70	70	80	85	100	105	115	125	90	95	100	115	80	85	90	100	—	—	—	—
	230	230	260	280	330	345	375	410	295	31										

R217/220.43-05 – Cutting data $v_c = (m/min)/(sf/min)$

SMG	MK1500				F30M				F15M				H15			
	80%	60%	40%	20%	80%	60%	40%	20%	80%	60%	40%	20%	80%	60%	40%	20%
P1	—	—	—	—	285	305	335	375	—	—	—	—	—	—	—	—
	—	—	—	—	940	1000	1100	1225	—	—	—	—	—	—	—	—
P2	—	—	—	—	275	295	320	365	—	—	—	—	—	—	—	—
	—	—	—	—	900	970	1050	1200	—	—	—	—	—	—	—	—
P3	—	—	—	—	240	255	280	315	—	—	—	—	—	—	—	—
	—	—	—	—	790	840	920	1025	—	—	—	—	—	—	—	—
P4	—	—	—	—	210	225	250	280	—	—	—	—	—	—	—	—
	—	—	—	—	690	740	820	920	—	—	—	—	—	—	—	—
P5	—	—	—	—	205	220	235	270	—	—	—	—	—	—	—	—
	—	—	—	—	670	720	770	890	—	—	—	—	—	—	—	—
P6	—	—	—	—	230	245	265	300	—	—	—	—	—	—	—	—
	—	—	—	—	750	800	870	980	—	—	—	—	—	—	—	—
P7	—	—	—	—	215	230	250	285	—	—	—	—	—	—	—	—
	—	—	—	—	710	750	820	940	—	—	—	—	—	—	—	—
P8	—	—	—	—	200	215	235	265	—	—	—	—	—	—	—	—
	—	—	—	—	660	710	770	870	—	—	—	—	—	—	—	—
P11	—	—	—	—	210	225	245	275	—	—	—	—	—	—	—	—
	—	—	—	—	690	740	800	900	—	—	—	—	—	—	—	—
P12	—	—	—	—	135	145	160	175	—	—	—	—	—	—	—	—
	—	—	—	—	445	475	520	570	—	—	—	—	—	—	—	—
M1	—	—	—	—	220	240	260	295	—	—	—	—	—	—	—	—
	—	—	—	—	720	790	850	970	—	—	—	—	—	—	—	—
M2	—	—	—	—	185	195	215	240	—	—	—	—	—	—	—	—
	—	—	—	—	610	640	710	790	—	—	—	—	—	—	—	—
M3	—	—	—	—	145	155	170	195	—	—	—	—	—	—	—	—
	—	—	—	—	475	510	560	640	—	—	—	—	—	—	—	—
M4	—	—	—	—	115	120	130	150	—	—	—	—	—	—	—	—
	—	—	—	—	375	395	425	490	—	—	—	—	—	—	—	—
M5	—	—	—	—	95	100	110	125	—	—	—	—	—	—	—	—
	—	—	—	—	310	330	360	410	—	—	—	—	—	—	—	—
K1	340	370	405	465	220	235	255	290	300	320	350	395	—	—	—	—
	1125	1225	1325	1525	720	770	840	950	980	1050	1150	1300	—	—	—	—
K2	300	325	360	410	195	210	225	255	260	280	310	350	—	—	—	—
	980	1075	1175	1350	640	690	740	840	850	920	1025	1150	—	—	—	—
K3	255	275	305	350	165	175	190	215	220	240	260	295	—	—	—	—
	840	900	1000	1150	540	570	620	710	720	790	850	970	—	—	—	—
K4	245	260	290	330	155	170	180	205	210	225	250	285	—	—	—	—
	800	850	950	1075	510	560	590	670	690	740	820	940	—	—	—	—
K5	150	160	180	200	95	100	110	125	130	140	150	170	—	—	—	—
	490	520	590	660	310	330	360	410	425	460	490	560	—	—	—	—
K6	215	230	255	295	140	150	160	180	185	200	220	250	—	—	—	—
	710	750	840	970	460	490	520	590	610	660	720	820	—	—	—	—
K7	190	205	230	255	120	130	145	160	165	175	195	220	—	—	—	—
	620	670	750	840	395	425	475	520	540	570	640	720	—	—	—	—
N1	—	—	—	—	1600	1725	1900	2175	2200	2375	2625	2925	1750	1875	2075	2325
	—	—	—	—	5250	5650	6225	7125	7225	7800	8600	9600	5750	6150	6800	7625
N2	—	—	—	—	640	690	770	870	890	960	1050	1175	700	760	840	940
	—	—	—	—	2100	2275	2525	2850	2925	3150	3450	3850	2300	2500	2750	3075
N3	—	—	—	—	430	465	510	580	590	640	700	790	470	500	560	630
	—	—	—	—	1400	1525	1675	1900	1925	2100	2300	2600	1550	1650	1825	2075
N11	—	—	—	—	490	530	590	670	680	730	800	900	540	580	640	720
	—	—	—	—	1600	1750	1925	2200	2225	2400	2625	2950	1775	1900	2100	2350
S1	—	—	—	—	55	55	60	70	—	—	—	—	—	—	—	—
	—	—	—	—	180	180	195	230	—	—	—	—	—	—	—	—
S2	—	—	—	—	42	45	50	55	—	—	—	—	—	—	—	—
	—	—	—	—	140	150	165	180	—	—	—	—	—	—	—	—
S3	—	—	—	—	37	40	43	49	—	—	—	—	—	—	—	—
	—	—	—	—	120	130	140	160	—	—	—	—	—	—	—	—
S11	—	—	—	—	75	80	85	100	—	—	—	—	—	—	—	—
	—	—	—	—	245	260	280	330	—	—	—	—	—	—	—	—
S12	—	—	—	—	43	46	50	55	—	—	—	—	—	—	—	—
	—	—	—	—	140	150	165	180	—	—	—	—	—	—	—	—
S13	—	—	—	—	25	26	29	33	—	—	—	—	—	—	—	—
	—	—	—	—	80	85	95	110	—	—	—	—	—	—	—	—
H5	—	—	—	—	45	48	55	60	—	—	—	—	—	—	—	—
	—	—	—	—	150	155	180	195	—	—	—	—	—	—	—	—
H8	—	—	—	—	47	50	55	60	—	—	—	—	—	—	—	—
	—	—	—	—	155	165	180	195	—	—	—	—	—	—	—	—
H11	—	—	—	—	55	60	65	75	—	—	—	—	—	—	—	—
	—	—	—	—	180	195	215	245	—	—	—	—	—	—	—	—
H12	—	—	—	—	85	90	100	110	—	—	—	—	—	—	—	—
	—	—	—	—	280	295	330	360	—	—	—	—	—	—	—	—
H21	—	—	—	—	47	50	55	60	—	—	—	—	—	—	—	—
	—	—	—	—	155	165	180	195	—	—	—	—	—	—	—	—

Square shoulder and slot milling cutters
Helical milling cutters
Face milling cutters
Disc milling cutters
High feed milling cutters
Copy milling cutters
Plunge milling cutters
Chamfer milling cutters
Spot facing cutters
Inserts

Octomill R220.43-07W – Metric

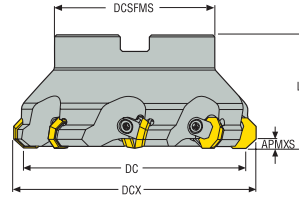

- For insert selection and cutting data recommendations, see page(s) 322-324
- For complete insert programme, see page(s) 836
- For ISO attribute explanation, see page 16

Designation	Item number	Type of mounting	DC	ZEFP	APMXS	KAPRS°	DCX	DCB	DCSFMS	LF	RPMX	Weight	Insert
			mm		mm		mm	mm	mm	mm		kg	
R220.43-0050-07W	00034758	Arbor	50,0	4	5,0	43,0	62,0	22,0	47,0	60,0	6300	0,4	OF..0704
R220.43-0063-07W	00005691	Arbor	63,0	4	5,0	43,0	75,0	22,0	47,0	40,0	5600	0,6	OF..0704
R220.43-0080-07W	00005692	Arbor	80,0	5	5,0	43,0	92,0	27,0	62,0	50,0	5000	1,3	OF..0704
R220.43-0100-07W	00005693	Arbor	100,0	6	5,0	43,0	112,0	32,0	77,0	50,0	4400	1,8	OF..0704
R220.43-0125-07W	00005694	Arbor	125,0	8	5,0	43,0	137,0	40,0	90,0	63,0	4000	3,2	OF..0704
R220.43-8160-07W	00005695	Arbor	160,0	10	5,0	43,0	172,0	40,0	90,0	63,0	3500	5,1	OF..0704

Spare Parts, included in delivery

For cutter	Arbor screw	Insert key	Insert wedge	Wedge key	Wedge screw
R220.43-0050	220.17-696	-	334.5-640	H6B-T25P	LD8018-T25P
R220.43-0063	MF6S10X40	-	CW0810	H6B-T25P	LD8018-T25P
R220.43-0080	MC6S12X35	-	CW0810	H6B-T25P	LD8018-T25P
R220.43-0100-8160	-	-	CW0810	H6B-T25PL	LD8018-T25P
R220.43-0100-8160	-	1/4HEX-T25PX90	CW0810	-	LD8018-T25P

Torque and fixed keys, see page 894

Octomill R220.43-07W – inch

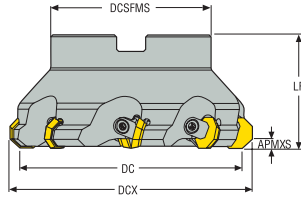

- For insert selection and cutting data recommendations, see page(s) 322-324
- For complete insert programme, see page(s) 836
- For ISO attribute explanation, see page 16

Designation	Item number	Type of mounting	DC	ZEFP	APMXS	KAPRS°	DCX	DCB	DCSFMS	LF	RPMX	Weight	Insert
			inch		inch		inch	inch	inch	inch		lbs	
R220.43-02.50-07W	00003262	Arbor	2.480	4	0.197	43.0	2.953	0.750	1.850	1.575	6000	1.540	OF..0704
R220.43-03.00-07W	00003266	Arbor	3.150	5	0.197	43.0	3.622	1.000	2.441	1.969	5000	3.530	OF..0704
R220.43-04.00-07W	00003268	Arbor	3.937	6	0.197	43.0	4.409	1.500	3.543	1.969	4400	5.070	OF..0704
R220.43-05.00-07W	00003273	Arbor	4.921	8	0.197	43.0	5.394	1.500	3.543	2.480	4000	7.050	OF..0704
R220.43-06.00-07W	00003278	Arbor	6.299	10	0.197	43.0	6.772	2.000	4.331	2.480	3500	11.680	OF..0704

Spare Parts, included in delivery

For cutter	Arbor screw	Insert wedge	Wedge key	Wedge screw
R220.43-02.50	UF6S3/8UNFX11/2	CW0810	H6B-T25P	LD8018-T25P
R220.43-03.00	UF6S1/2UNFX1-1/2	CW0810	H6B-T25P	LD8018-T25P
R220.43-04.00	UF6S3/4UNFX2	CW0810	H6B-T25PL	LD8020-T25P
R220.43-05.00 / 06.00	-	CW0810	1/4HEX-T25PX90	LD8018-T25P

Torque and fixed keys, see page 894

Square shoulder and slot milling cutters

Helical milling cutters

Face milling cutters

Disc milling cutters

High feed milling cutters

Copy milling cutters

Plunge milling cutters

Chamfer milling cutters

Spot facing cutters

Inserts

Octomill R220.43-07C/CG/CT – Metric

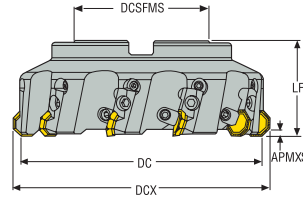

- For insert selection and cutting data recommendations, see page(s) 322-324
- For complete insert programme, see page(s) 836
- For ISO attribute explanation, see page 16

Designation	Item number	Type of mounting	DC	ZEFP	APMXS	KAPRS°	DCX	DCB	DCSFMS	LF	RPMX	Weight	Insert
			mm		mm		mm	mm	mm	mm		kg	
R220.43-0100-07C	75077234	Arbor	100,0	6	5,0	43,0	112,0	32,0	77,0	50,0	4300	2,3	OF..0704
R220.43-0125-07C	75077237	Arbor	125,0	8	5,0	43,0	137,0	40,0	90,0	63,0	3800	3,6	OF..0704
R220.43-8160-07C	75077240	Arbor	160,0	10	5,0	43,0	172,0	40,0	90,0	63,0	3300	5,7	OF..0704
R220.43-8160-07CT	75077241	Arbor	160,0	14	5,0	43,0	172,0	40,0	90,0	63,0	3300	5,6	OF..0704
R220.43-8160-07CG	75077239	Arbor	160,0	7	5,0	43,0	172,0	40,0	90,0	63,0	3300	5,8	OF..0704
R220.43-8200-07C	75077243	Arbor	200,0	12	5,0	43,0	212,0	60,0	130,0	63,0	3000	8,3	OF..0704
R220.43-8200-07CT	75077244	Arbor	200,0	18	5,0	43,0	212,0	60,0	130,0	63,0	3000	8,1	OF..0704
R220.43-8250-07C	75077246	Arbor	250,0	16	5,0	43,0	262,0	60,0	130,0	63,0	2700	14,3	OF..0704
R220.43-8250-07CT	75077247	Arbor	250,0	22	5,0	43,0	262,0	60,0	130,0	63,0	2700	16,9	OF..0704
R220.43-8315-07CT	75077250	Arbor	315,0	28	5,0	43,0	327,0	60,0	225,0	80,0	2400	28,0	OF..0704

Spare Parts, included in delivery

For cutter	Adjustment unit	Arbor screw	Cassette	Cassette screw	Insert wedge	Wedge key	Wedge screw
R220.43-0100-C	AU1114T-T15P	MC6S16X35	OF07AR	FS96018	CW0810	H6B-T25PL	LD8020-T25P
R220.43-0125C	AU1114T-T15P	-	OF07AR	FS96018	CW0810	H6B-T25PL	LD8020-T25P
R220.43-8160C/CG	AU1114T-T15P	-	OF07AR	FS96018	CW0810	H6B-T25PL	LD8020-T25P
R220.43-0125-8315-CT	AU1114T-T15P	-	OF07AR	FS96018	334.5-640	H6B-T25PL	LD8020-T25P
R220.43-8160C/CG	AU1114T-T15P	-	OF07AR	FS96018	CW0810	-	LD8020-T25P
R220.43-8200-8500C	AU1114T-T15P	-	OF07AR	FS96018	CW0810	H6B-T25PL	LD8020-T25P
R220.43-8315-CT	AU1114T-T15P	-	OF07AR	FS96018	334.5-640	H6B-T25PL	LD8020-T25P

Accessories

For cutter	Arbor screw	Arbor screw 2	Nest key	Setting key
R220.43-0100-0125	-	-	H05-4	T15P-4
R220.43-8160	MC6S12X40	-	H05-4	T15P-4
R220.43-8200-8250	MC6S16X50	-	H05-4	T15P-4
R220.43-8315	MC6S16X50	MC6S20X50	H05-4	T15P-4

Torque and fixed keys, see page 894

Octomill R220.43-07T – Metric

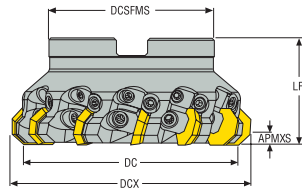

- For insert selection and cutting data recommendations, see page(s) 322-324
- For complete insert programme, see page(s) 836
- For ISO attribute explanation, see page 16

Designation	Item number	Type of mounting	DC	ZEFP	APMXS	KAPRS°	DCX	DCB	DCSFMS	LF	RPMX	Weight	Insert
			mm		mm		mm	mm	mm	mm		kg	
R220.43-0063-07-6T	00004368	Arbor	63,0	6	5,0	43,0	75,0	22,0	47,0	50,0	5600	0,8	OF..0704
R220.43-0080-07-9T	00004369	Arbor	80,0	9	5,0	43,0	92,0	27,0	62,0	50,0	5000	1,2	OF..0704
R220.43-0100-07-12T	00004371	Arbor	100,0	12	5,0	43,0	112,0	32,0	77,0	50,0	4400	1,6	OF..0704
R220.43-0125-07-15T	00004372	Arbor	125,0	15	5,0	43,0	137,0	40,0	90,0	63,0	4000	3,0	OF..0704

Spare Parts, included in delivery

For cutter	Arbor screw	Axial setting unit	Insert/Clamp key	Insert wedge	Setting key	Setting screw (axial)	Wedge clamp axial adj.	Wedge screw
R220.43-0063	MF6S10X40	AS6011	H6B-T25P	334.5-640	T15P-4ST	LD6019-T15P	CW0608	LD8020-T25P
R220.43-0080	MC6S12X35	AS6011	H6B-T25P	334.5-640	T15P-4ST	LD6019-T15P	CW0608	LD8020-T25P
R220.43-0100-0125	-	AS6011	H6B-T25PL	334.5-640	T15P-4ST	LD6019-T15P	CW0608	LD8020-T25P

Torque and fixed keys, see page 894

Square shoulder and slot milling cutters

Helical milling cutters

Face milling cutters

Disc milling cutters

High feed milling cutters

Copy milling cutters

Plunge milling cutters

Chamfer milling cutters

Spot facing cutters

Inserts

R220.43-07 – Insert selection – mm/Inch

SMG		a _p	f _z			
			80%	60%	40%	20%
P1	OFER070405TN-ME15 T350M	3,0	0,32	0,32	0,34	0,42
		0,12	0,013	0,013	0,013	0,017
P2	OFER070405TN-ME15 T350M	3,0	0,34	0,34	0,34	0,42
		0,12	0,013	0,013	0,013	0,017
P3	OFER070405TN-ME15 T350M	3,0	0,32	0,32	0,32	0,40
		0,12	0,013	0,013	0,013	0,016
P4	OFER070405TN-M16 MP2501	3,0	0,32	0,32	0,34	0,42
		0,12	0,013	0,013	0,013	0,017
P5	OFER070405TN-M16 MP2501	3,0	0,32	0,32	0,34	0,42
		0,12	0,013	0,013	0,013	0,017
P6	OFER070405TN-M16 MP2501	3,0	0,32	0,32	0,32	0,40
		0,12	0,013	0,013	0,013	0,016
P7	OFER070405TN-M16 T350M	3,0	0,32	0,32	0,32	0,40
		0,12	0,013	0,013	0,013	0,016
P8	OFER070405TN-M16 T350M	3,0	0,34	0,34	0,34	0,42
		0,12	0,013	0,013	0,013	0,017
P11	OFER070405TN-ME15 T350M	3,0	0,30	0,30	0,30	0,38
		0,12	0,012	0,012	0,012	0,015
P12	OFER070405TN-ME15 T350M	2,5	0,20	0,20	0,22	0,26
		0,10	0,0080	0,0080	0,0085	0,010
M1	OFER070405TN-ME10 F40M	3,0	0,22	0,22	0,22	0,28
		0,12	0,0085	0,0085	0,0085	0,011
M2	OFER070405TN-ME10 F40M	3,0	0,20	0,20	0,20	0,26
		0,12	0,0080	0,0080	0,0080	0,010
M3	OFER070405TN-ME15 T350M	2,5	0,25	0,25	0,25	0,32
		0,10	0,010	0,010	0,010	0,013
M4	OFER070405TN-ME15 T350M	1,8	0,22	0,22	0,22	0,28
		0,070	0,0085	0,0085	0,0085	0,011
M5	OFER070405TN-ME15 T350M	1,8	0,22	0,22	0,22	0,28
		0,070	0,0085	0,0085	0,0085	0,011
K1	OFER070405TN-M16 MK1500	3,0	0,36	0,36	0,36	0,46
		0,12	0,014	0,014	0,014	0,018
K2	OFER070405TN-M16 MK1500	3,0	0,32	0,32	0,34	0,42
		0,12	0,013	0,013	0,013	0,017
K3	OFER070405TN-M16 MP1501	3,0	0,32	0,32	0,34	0,42
		0,12	0,013	0,013	0,013	0,017
K4	OFER070405TN-M16 MP1501	3,0	0,32	0,32	0,34	0,42
		0,12	0,013	0,013	0,013	0,017
K5	OFER070405TN-M16 MP1501	3,0	0,30	0,30	0,30	0,36
		0,12	0,012	0,012	0,012	0,014
K6	OFER070405TN-M16 MK2050	3,0	0,32	0,32	0,34	0,42
		0,12	0,013	0,013	0,013	0,017
K7	OFER070405TN-M16 MK2050	3,0	0,30	0,30	0,30	0,36
		0,12	0,012	0,012	0,012	0,014
N1	OFER070405N-E07 H15	3,0	0,20	0,20	0,20	0,25
		0,12	0,0080	0,0080	0,0080	0,010
N2	OFER070405N-E07 H15	3,0	0,20	0,20	0,20	0,25
		0,12	0,0080	0,0080	0,0080	0,010
N3	OFER070405N-E07 H15	3,0	0,20	0,20	0,20	0,25
		0,12	0,0080	0,0080	0,0080	0,010
N11	OFER070405N-E07 H15	3,0	0,20	0,20	0,20	0,25
		0,12	0,0080	0,0080	0,0080	0,010
S1	OFER070405TN-ME15 T350M	1,8	0,22	0,22	0,22	0,28
		0,070	0,0085	0,0085	0,0085	0,011
S2	OFER070405TN-ME15 T350M	1,8	0,22	0,22	0,22	0,28
		0,070	0,0085	0,0085	0,0085	0,011
S3	OFER070405TN-ME15 T350M	1,8	0,20	0,20	0,20	0,26
		0,070	0,0080	0,0080	0,0080	0,010
S11	OFER070405TN-ME10 F40M	2,0	0,17	0,17	0,17	0,20
		0,080	0,0065	0,0065	0,0065	0,0080
S12	OFER070405TN-ME10 F40M	2,0	0,17	0,17	0,17	0,20
		0,080	0,0065	0,0065	0,0065	0,0080
S13	OFER070405TN-ME10 F40M	1,8	0,15	0,15	0,15	0,19
		0,070	0,0060	0,0060	0,0060	0,0075
H5	OFEN070405TN-D18 MP3000	2,5	0,25	0,25	0,26	0,32
		0,10	0,010	0,010	0,010	0,013
H8	OFEN070405TN-D18 MP3000	2,0	0,19	0,19	0,20	0,24
		0,080	0,0075	0,0075	0,0080	0,0095
H11	OFEN070405TN-D18 MP1501	2,5	0,25	0,25	0,26	0,32
		0,10	0,010	0,010	0,010	0,013
H12	OFEN070405TN-D18 MP1501	2,0	0,19	0,19	0,20	0,24
		0,080	0,0075	0,0075	0,0080	0,0095
H21	OFEN070405TN-D18 MP1501	2,0	0,19	0,19	0,20	0,24
		0,080	0,0075	0,0075	0,0080	0,0095

SMG = Seco material group
 f_z = mm/tooth (in/tooth), v_c = m/min (sf/min), a_p/DC = %
 All cutting data are start values

R220.43-07 – Cutting data $v_c = (m/min)/(sf/min)$

SMG	F40M				MP1501				MP2501				T350M				T25M			
	100%	80%	60%	40%	100%	80%	60%	40%	100%	80%	60%	40%	100%	80%	60%	40%	100%	80%	60%	40%
P1	220	235	255	280	285	305	330	360	255	270	290	320	255	270	290	320	210	225	245	265
	720	770	840	920	940	1000	1075	1175	840	890	950	1050	840	890	950	1050	690	740	800	870
P2	210	225	240	270	275	290	315	350	245	255	280	310	245	255	280	310	205	215	230	260
	690	740	790	890	900	950	1025	1150	800	840	920	1025	800	840	920	1025	670	710	750	850
P3	185	195	210	235	240	255	275	310	215	225	245	275	215	225	245	275	180	190	205	230
	610	640	690	770	790	840	900	1025	710	740	800	900	710	740	800	900	590	620	670	750
P4	165	175	190	210	215	230	245	270	190	205	220	240	190	205	220	240	160	170	185	200
	540	570	620	690	710	750	800	890	620	670	720	790	620	670	720	790	520	560	610	660
P5	160	170	180	200	205	220	235	260	185	195	210	230	185	195	210	230	150	160	175	190
	520	560	590	660	670	720	770	850	610	640	690	750	610	640	690	750	490	520	570	620
P6	180	190	205	230	230	245	265	295	205	215	235	265	205	215	235	265	170	180	195	220
	590	620	670	750	750	800	870	970	670	710	770	870	670	710	770	870	560	590	640	720
P7	170	180	195	215	220	230	250	280	195	205	220	250	195	205	220	250	160	170	185	205
	560	590	640	710	720	750	820	920	640	670	720	820	640	670	720	820	520	560	610	670
P8	155	165	180	200	200	215	230	260	180	190	205	230	180	190	205	230	150	160	170	190
	510	540	590	660	660	710	750	850	590	620	670	750	590	620	670	750	490	520	560	620
P11	165	175	185	210	210	225	245	270	190	200	215	240	190	200	215	240	155	165	180	200
	540	570	610	690	690	740	800	890	620	660	710	790	620	660	710	790	510	540	590	660
P12	110	115	125	135	140	150	160	180	125	130	145	160	125	135	145	155	105	110	120	130
	360	375	410	445	460	490	520	590	410	425	475	520	410	445	475	510	345	360	395	425
M1	170	180	195	220	—	—	—	—	175	185	200	225	185	200	215	240	165	175	185	210
	560	590	640	720	—	—	—	—	570	610	660	740	610	660	710	790	540	570	610	690
M2	145	150	165	180	—	—	—	—	145	155	170	185	155	165	180	195	135	145	155	170
	475	490	540	590	—	—	—	—	475	510	560	610	510	540	590	640	445	475	510	560
M3	115	125	135	145	—	—	—	—	120	125	135	155	130	135	145	160	110	120	130	140
	375	410	445	475	—	—	—	—	395	410	445	510	425	445	475	520	360	395	425	460
M4	90	95	105	115	—	—	—	—	90	100	105	115	100	105	115	125	85	90	100	110
	295	310	345	375	—	—	—	—	295	330	345	375	330	345	375	410	280	295	330	360
M5	75	80	85	95	—	—	—	—	75	80	90	100	85	90	95	105	70	75	80	90
	245	260	280	310	—	—	—	—	245	260	295	330	280	295	310	345	230	245	260	295
K1	165	175	190	215	215	230	250	280	195	205	220	245	—	—	—	—	160	170	185	205
	540	570	620	710	710	750	820	920	640	670	720	800	—	—	—	—	520	560	610	670
K2	150	160	175	190	195	205	225	245	175	185	200	220	—	—	—	—	145	155	165	180
	490	520	570	620	640	670	740	800	570	610	660	720	—	—	—	—	475	510	540	590
K3	130	135	145	160	165	175	190	210	145	155	170	185	—	—	—	—	120	130	140	155
	425	445	475	520	540	570	620	690	475	510	560	610	—	—	—	—	395	425	460	510
K4	120	130	140	155	160	165	180	200	140	150	160	175	—	—	—	—	115	125	135	145
	395	425	460	510	520	540	590	660	460	490	520	570	—	—	—	—	375	410	445	475
K5	75	80	85	95	95	100	110	125	85	90	95	110	—	—	—	—	70	75	80	90
	245	260	280	310	310	330	360	410	280	295	310	360	—	—	—	—	230	245	260	295
K6	105	115	125	135	140	150	160	175	125	130	140	155	—	—	—	—	105	110	120	130
	345	375	410	445	460	490	520	570	410	425	460	510	—	—	—	—	345	360	395	425
K7	95	100	110	120	125	130	140	160	110	115	125	140	—	—	—	—	90	95	105	115
	310	330	360	395	410	425	460	520	360	375	410	460	—	—	—	—	295	310	345	375
N1	1225	1300	1400	1550	—	—	—	—	—	—	—	—	—	—	—	—	—	—	—	—
	4025	4275	4600	5075	—	—	—	—	—	—	—	—	—	—	—	—	—	—	—	—
N2	495	530	570	630	—	—	—	—	—	—	—	—	—	—	—	—	—	—	—	—
	1625	1750	1875	2075	—	—	—	—	—	—	—	—	—	—	—	—	—	—	—	—
N3	330	350	380	420	—	—	—	—	—	—	—	—	—	—	—	—	—	—	—	—
	1075	1150	1250	1375	—	—	—	—	—	—	—	—	—	—	—	—	—	—	—	—
N11	380	400	435	480	—	—	—	—	—	—	—	—	—	—	—	—	—	—	—	—
	1250	1300	1425	1575	—	—	—	—	—	—	—	—	—	—	—	—	—	—	—	—
S1	42	45	48	55	—	—	—	—	45	48	50	55	46	49	55	60	—	—	—	—
	140	150	155	180	—	—	—	—	150	155	165	180	150	160	180	195	—	—	—	—
S2	34	36	39	43	—	—	—	—	36	38	41	46	37	39	43	47	—	—	—	—
	110	120	130	140	—	—	—	—	120	125	135	150	120	130	140	155	—	—	—	—
S3	30	32	34	38	—	—	—	—	32	34	37	41	33	35	38	42	—	—	—	—
	100	105	110	125	—	—	—	—	105	110	120	135	110	115	125	140	—	—	—	—
S11	60	60	70	75	—	—	—	—	65	65	70	80	65	70	75	80	—	—	—	—
	195	195	230	245	—	—	—	—	215	215	230	260	215	230	245	260	—	—	—	—
S12	41	43	47	50	—	—	—	—	44	46	50	55	45	47	50	55	—	—	—	—
	135	140	155	165	—	—	—	—	145	150	165	180	150	155	165	180	—	—	—	—
S13	24	25	27	30	—	—	—	—	25	27	29	32	26	28	30	33	—	—	—	—
	80	80	90	100	—	—	—	—	80	90	95	105	85	90	100	110	—	—	—	—
H5	36	38	41	45	47	50	55	60	38	40	43	48	42	44	48	50	—	—	—	—
	120	125	135	150	155	165	180	195	125	130	140	155	140	145	155	165	—	—	—	—
H8	39	41	44	49	50	55	60	65	41	43	46	50	44	47	50	55	—	—	—	—
	130	135	145	160	165	180	195	215	135	140	150	165	145	155	165	180	—	—	—	—
H11	46	49	55	55	60	65	70	75	48	50	55	60	55	55	60	65	—	—	—	—
	150	160	180	180	195	215	230	245	155	165	180	195	180	180	195	215	—	—	—	—
H12	70	75	80	90	90	95	105	115	80	85	90	100	80	85	90	100	—	—	—	—
	230	245	260	295	295	310	345	375	260	280	295	330	260	280	295	330	—	—	—	—

R220.43-07 – Cutting data $v_c = (m/min)/(sf/min)$

SMG	MK1500				MK2050				F15M				F30M				H15			
	80%	60%	40%	20%	80%	60%	40%	20%	80%	60%	40%	20%	80%	60%	40%	20%	80%	60%	40%	20%
P1	—	—	—	—	265	285	315	360	—	—	—	—	245	265	295	330	—	—	—	—
	—	—	—	—	870	940	1025	1175	—	—	—	—	800	870	970	1075	—	—	—	—
P2	—	—	—	—	255	275	305	345	—	—	—	—	240	260	290	325	—	—	—	—
	—	—	—	—	840	900	1000	1125	—	—	—	—	790	850	950	1075	—	—	—	—
P3	—	—	—	—	220	240	270	305	—	—	—	—	210	230	250	285	—	—	—	—
	—	—	—	—	720	790	890	1000	—	—	—	—	690	750	820	940	—	—	—	—
P4	—	—	—	—	200	215	235	270	—	—	—	—	185	200	220	250	—	—	—	—
	—	—	—	—	660	710	770	890	—	—	—	—	610	660	720	820	—	—	—	—
P5	—	—	—	—	190	205	225	255	—	—	—	—	180	195	215	240	—	—	—	—
	—	—	—	—	620	670	740	840	—	—	—	—	590	640	710	790	—	—	—	—
P6	—	—	—	—	215	230	260	295	—	—	—	—	200	215	240	270	—	—	—	—
	—	—	—	—	710	750	850	970	—	—	—	—	660	710	790	890	—	—	—	—
P7	—	—	—	—	200	220	245	275	—	—	—	—	190	205	225	255	—	—	—	—
	—	—	—	—	660	720	800	900	—	—	—	—	620	670	740	840	—	—	—	—
P8	—	—	—	—	185	200	225	255	—	—	—	—	180	195	210	240	—	—	—	—
	—	—	—	—	610	660	740	840	—	—	—	—	590	640	690	790	—	—	—	—
P11	—	—	—	—	195	210	235	270	—	—	—	—	185	200	220	250	—	—	—	—
	—	—	—	—	640	690	770	890	—	—	—	—	610	660	720	820	—	—	—	—
P12	—	—	—	—	130	140	155	175	—	—	—	—	120	130	145	160	—	—	—	—
	—	—	—	—	425	460	510	570	—	—	—	—	395	425	475	520	—	—	—	—
M1	—	—	—	—	—	—	—	—	—	—	—	—	195	210	230	260	—	—	—	—
	—	—	—	—	—	—	—	—	—	—	—	—	640	690	750	850	—	—	—	—
M2	—	—	—	—	—	—	—	—	—	—	—	—	160	175	195	215	—	—	—	—
	—	—	—	—	—	—	—	—	—	—	—	—	520	570	640	710	—	—	—	—
M3	—	—	—	—	—	—	—	—	—	—	—	—	130	140	155	175	—	—	—	—
	—	—	—	—	—	—	—	—	—	—	—	—	425	460	510	570	—	—	—	—
M4	—	—	—	—	—	—	—	—	—	—	—	—	100	105	120	135	—	—	—	—
	—	—	—	—	—	—	—	—	—	—	—	—	330	345	395	445	—	—	—	—
M5	—	—	—	—	—	—	—	—	—	—	—	—	85	90	100	115	—	—	—	—
	—	—	—	—	—	—	—	—	—	—	—	—	280	295	330	375	—	—	—	—
K1	290	310	350	395	275	295	330	370	270	290	325	365	190	205	230	255	—	—	—	—
	950	1025	1150	1300	900	970	1075	1225	890	950	1075	1200	620	670	750	840	—	—	—	—
K2	260	280	310	350	245	265	290	330	245	260	285	325	170	185	205	225	—	—	—	—
	850	920	1025	1150	800	870	950	1075	800	850	940	1075	560	610	670	740	—	—	—	—
K3	220	240	260	295	210	225	245	280	205	220	240	275	145	155	170	190	—	—	—	—
	720	790	850	970	690	740	800	920	670	720	790	900	475	510	560	620	—	—	—	—
K4	210	225	250	285	200	215	235	270	195	210	230	260	135	150	165	185	—	—	—	—
	690	740	820	940	660	710	770	890	640	690	750	850	445	490	540	610	—	—	—	—
K5	130	140	155	175	120	130	145	165	120	130	140	160	85	90	100	110	—	—	—	—
	425	460	510	570	395	425	475	540	395	425	460	520	280	295	330	360	—	—	—	—
K6	185	200	220	250	175	190	210	235	175	185	205	230	120	130	145	160	—	—	—	—
	610	660	720	820	570	620	690	770	570	610	670	750	395	425	475	520	—	—	—	—
K7	165	175	200	225	155	165	185	215	155	165	180	205	110	115	125	145	—	—	—	—
	540	570	660	740	510	540	610	710	510	540	590	670	360	375	410	475	—	—	—	—
N1	—	—	—	—	—	—	—	—	2000	2175	2425	2725	1400	1500	1650	1875	1600	1725	1900	2150
	—	—	—	—	—	—	—	—	6550	7125	7950	8950	4600	4925	5425	6150	5250	5650	6225	7050
N2	—	—	—	—	—	—	—	—	810	880	970	1100	560	610	670	760	640	690	770	870
	—	—	—	—	—	—	—	—	2650	2875	3175	3600	1825	2000	2200	2500	2100	2275	2525	2850
N3	—	—	—	—	—	—	—	—	540	580	650	730	375	405	445	510	430	460	510	580
	—	—	—	—	—	—	—	—	1775	1900	2125	2400	1225	1325	1450	1675	1400	1500	1675	1900
N11	—	—	—	—	—	—	—	—	620	670	740	840	430	465	510	580	490	530	590	660
	—	—	—	—	—	—	—	—	2025	2200	2425	2750	1400	1525	1675	1900	1600	1750	1925	2175
S1	—	—	—	—	—	—	—	—	—	—	—	—	46	50	55	65	—	—	—	—
	—	—	—	—	—	—	—	—	—	—	—	—	150	165	180	215	—	—	—	—
S2	—	—	—	—	—	—	—	—	—	—	—	—	37	40	45	50	—	—	—	—
	—	—	—	—	—	—	—	—	—	—	—	—	120	130	150	165	—	—	—	—
S3	—	—	—	—	—	—	—	—	—	—	—	—	33	36	39	44	—	—	—	—
	—	—	—	—	—	—	—	—	—	—	—	—	110	120	130	145	—	—	—	—
S11	—	—	—	—	—	—	—	—	—	—	—	—	65	70	75	90	—	—	—	—
	—	—	—	—	—	—	—	—	—	—	—	—	215	230	245	295	—	—	—	—
S12	—	—	—	—	—	—	—	—	—	—	—	—	37	41	45	50	—	—	—	—
	—	—	—	—	—	—	—	—	—	—	—	—	120	135	150	165	—	—	—	—
S13	—	—	—	—	—	—	—	—	—	—	—	—	22	23	26	30	—	—	—	—
	—	—	—	—	—	—	—	—	—	—	—	—	70	75	85	100	—	—	—	—
H5	—	—	—	—	—	—	—	—	—	—	—	—	40	43	47	55	—	—	—	—
	—	—	—	—	—	—	—	—	—	—	—	—	130	140	155	180	—	—	—	—
H8	—	—	—	—	—	—	—	—	—	—	—	—	42	45	50	55	—	—	—	—
	—	—	—	—	—	—	—	—	—	—	—	—	140	150	165	180	—	—	—	—
H11	—	—	—	—	—	—	—	—	—	—	—	—	50	55	60	70	—	—	—	—
	—	—	—	—	—	—	—	—	—	—	—	—	165	180	195	230	—	—	—	—
H12	—	—	—	—	—	—	—	—	—	—	—	—	75	80	90	105	—	—	—	—
	—	—	—	—	—	—	—	—	—	—	—	—	245	260	295	345	—	—	—	—
H21	—	—	—	—	—	—	—	—	—	—	—	—	42	45	50	55	—	—	—	—
	—	—	—	—	—	—	—	—	—	—	—	—	140	150	165	180	—	—	—	—

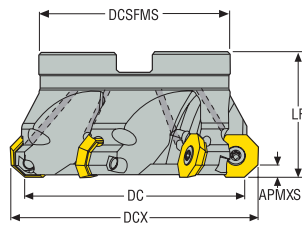

Octomill R220.43-07S/SA – Metric



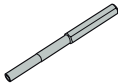

- For insert selection and cutting data recommendations, see page(s) 326 - 327
- For complete insert programme, see page(s) 837
- For ISO attribute explanation, see page 16

Designation	Item number	Type of mounting	DC	ZEFP	APMXS	KAPRS°	DCX	DCB	DCSFMS	LF	RPMX	Weight	Insert
			mm		mm		mm	mm	mm	mm		kg	
R220.43-0080-07SA	00090771	Arbor	80,0	5	5,0	43,0	92,0	27,0	62,0	50,0	6200	1,0	OF..0704
R220.43-0100-07SA	00090773	Arbor	100,0	6	5,0	43,0	112,0	32,0	77,0	50,0	5600	1,7	OF..0704
R220.43-0125-07S	00045811	Arbor	125,0	8	5,0	43,0	137,0	40,0	90,0	63,0	5100	3,0	OF..0704

Spare Parts, included in delivery

For cutter	Insert key	Insert screw
		
R220.43-0080-0125	H6B-T20P	C05013-T20P
R220.43-0080-0125	H6B-T20PL	C05013-T20P

Accessories

For cutter	Insert clamping torque	Torque key
		
R220.43-..	5.0NM	T00-20P50

Torque and fixed keys, see page 894

Square shoulder and slot milling cutters

Helical milling cutters

Face milling cutters

Disc milling cutters

High feed milling cutters

Copy milling cutters

Plunge milling cutters

Chamfer milling cutters

Spot facing cutters

Inserts

R220.43-7S – Insert selection – mm/Inch

SMG		a _p	f _z			
			80%	60%	40%	20%
P1	OFMT070405TN-ME13 MP2501	3,0	0,28	0,28	0,30	0,36
		0.12	0.011	0.011	0.012	0.014
P2	OFMT070405TN-ME13 MP2501	3,0	0,28	0,28	0,30	0,36
		0.12	0.011	0.011	0.012	0.014
P3	OFMT070405TN-ME13 MP2501	3,0	0,28	0,28	0,28	0,34
		0.12	0.011	0.011	0.011	0.013
P4	OFMT070405TN-M15 MP2501	3,0	0,30	0,30	0,32	0,40
		0.12	0.012	0.012	0.013	0.016
P5	OFMT070405TN-M15 MP2501	3,0	0,30	0,30	0,32	0,38
		0.12	0.012	0.012	0.013	0.015
P6	OFMT070405TN-M15 MP2501	3,0	0,30	0,30	0,30	0,38
		0.12	0.012	0.012	0.012	0.015
P7	OFMT070405TN-M15 MP2501	3,0	0,30	0,30	0,30	0,38
		0.12	0.012	0.012	0.012	0.015
P8	OFMT070405TN-ME13 MP2501	3,0	0,28	0,28	0,28	0,34
		0.12	0.011	0.011	0.011	0.013
P11	OFMT070405TN-ME13 MP2501	3,0	0,26	0,26	0,26	0,34
		0.12	0.010	0.010	0.010	0.013
P12	OFMT070405TN-ME13 MP2501	2,5	0,18	0,18	0,19	0,22
		0.10	0.0070	0.0070	0.0075	0.0085
M1	OFET070405TN-ME10 F40M	3,0	0,22	0,22	0,22	0,28
		0.12	0.0085	0.0085	0.0085	0.011
M2	OFET070405TN-ME10 F40M	3,0	0,20	0,20	0,20	0,26
		0.12	0.0080	0.0080	0.0080	0.010
M3	OFET070405TN-ME10 F40M	2,5	0,16	0,16	0,17	0,20
		0.10	0.0065	0.0065	0.0065	0.0080
M4	OFET070405TN-ME10 F40M	1,8	0,15	0,15	0,15	0,19
		0.070	0.0060	0.0060	0.0060	0.0075
M5	OFET070405TN-ME10 F40M	1,8	0,15	0,15	0,15	0,19
		0.070	0.0060	0.0060	0.0060	0.0075
K1	OFMT070405TN-M15 MP2501	3,0	0,34	0,34	0,34	0,42
		0.12	0.013	0.013	0.013	0.017
K2	OFMT070405TN-M15 MP2501	3,0	0,30	0,30	0,32	0,38
		0.12	0.012	0.012	0.013	0.015
K3	OFMT070405TN-M15 MP2501	3,0	0,30	0,30	0,32	0,38
		0.12	0.012	0.012	0.013	0.015
K4	OFMT070405TN-M15 MP2501	3,0	0,30	0,30	0,32	0,38
		0.12	0.012	0.012	0.013	0.015
K5	OFMT070405TN-M15 MP2501	3,0	0,28	0,28	0,28	0,34
		0.12	0.011	0.011	0.011	0.013
K6	OFMT070405TN-M15 MP2501	3,0	0,30	0,30	0,32	0,38
		0.12	0.012	0.012	0.013	0.015
K7	OFMT070405TN-M15 MP2501	3,0	0,28	0,28	0,28	0,34
		0.12	0.011	0.011	0.011	0.013
N1	OFET070405TN-ME10 F30M	3,0	0,28	0,28	0,30	0,36
		0.12	0.011	0.011	0.012	0.014
N2	OFET070405TN-ME10 F30M	3,0	0,28	0,28	0,30	0,36
		0.12	0.011	0.011	0.012	0.014
N3	OFET070405TN-ME10 F30M	3,0	0,28	0,28	0,30	0,36
		0.12	0.011	0.011	0.012	0.014
N11	OFET070405TN-ME10 F30M	3,0	0,28	0,28	0,30	0,36
		0.12	0.011	0.011	0.012	0.014
S1	OFET070405TN-ME15 F40M	1,8	0,22	0,22	0,22	0,28
		0.070	0.0085	0.0085	0.0085	0.011
S2	OFET070405TN-ME15 F40M	1,8	0,20	0,20	0,20	0,26
		0.070	0.0080	0.0080	0.0080	0.010
S3	OFET070405TN-ME15 F40M	2,0	0,17	0,17	0,17	0,20
		0.080	0.0065	0.0065	0.0065	0.0080
S11	OFET070405TN-ME10 F40M	2,0	0,17	0,17	0,17	0,20
		0.080	0.0065	0.0065	0.0065	0.0080
S12	OFET070405TN-ME10 F40M	1,8	0,15	0,15	0,15	0,19
		0.070	0.0060	0.0060	0.0060	0.0075
S13	OFET070405TN-ME10 F40M	2,5	0,20	0,20	0,22	0,26
		0.10	0.0080	0.0080	0.0085	0.010
H5	OFMT070405TN-M15 F40M	2,0	0,16	0,16	0,17	0,20
		0.080	0.0065	0.0065	0.0065	0.0080
H8	OFMT070405TN-M15 F40M	2,5	0,20	0,20	0,22	0,26
		0.10	0.0080	0.0080	0.0085	0.010
H11	OFMT070405TN-M15 F40M	2,0	0,16	0,16	0,17	0,20
		0.080	0.0065	0.0065	0.0065	0.0080
H12	OFMT070405TN-M15 F40M	2,0	0,16	0,16	0,17	0,20
		0.080	0.0065	0.0065	0.0065	0.0080
H21	OFMT070405TN-M15 F40M	2,0	0,16	0,16	0,17	0,20
		0.080	0.0065	0.0065	0.0065	0.0080

SMG = Seco material group
 f_z = mm/tooth (in/tooth), v_c = m/min (sf/min), a_p/DC = %
 All cutting data are start values

R220.43-07S – Cutting data $v_c = (m/min)/(sf/min)$

SMG	F40M				MP2501				F30M			
	80%	60%	40%	20%	80%	60%	40%	20%	80%	60%	40%	20%
P1	235	255	280	315	285	310	340	390	275	300	335	375
	770	840	920	1025	940	1025	1125	1275	900	980	1100	1225
P2	225	240	270	305	280	300	330	380	270	290	325	365
	740	790	890	1000	920	980	1075	1250	890	950	1075	1200
P3	195	210	235	270	240	260	290	330	240	255	280	320
	640	690	770	890	790	850	950	1075	790	840	920	1050
P4	175	190	210	235	215	235	255	290	210	225	245	280
	570	620	690	770	710	770	840	950	690	740	800	920
P5	170	180	200	230	205	225	250	280	200	215	240	270
	560	590	660	750	670	740	820	920	660	710	790	890
P6	190	205	230	255	230	250	280	310	225	245	270	305
	620	670	750	840	750	820	920	1025	740	800	890	1000
P7	180	195	215	245	220	235	265	295	215	230	255	290
	590	640	710	800	720	770	870	970	710	750	840	950
P8	165	180	200	225	200	220	245	280	200	215	235	270
	540	590	660	740	660	720	800	920	660	710	770	890
P11	175	185	210	235	215	230	255	285	205	225	250	280
	570	610	690	770	710	750	840	940	670	740	820	920
P12	115	125	135	155	140	150	165	190	135	145	160	180
	375	410	445	510	460	490	540	620	445	475	520	590
M1	180	195	220	245	200	220	240	270	215	235	260	295
	590	640	720	800	660	720	790	890	710	770	850	970
M2	150	165	180	205	165	180	200	225	180	195	215	240
	490	540	590	670	540	590	660	740	590	640	710	790
M3	125	135	145	170	135	145	160	185	145	160	170	195
	410	445	475	560	445	475	520	610	475	520	560	640
M4	95	105	115	130	105	115	125	140	110	120	135	150
	310	345	375	425	345	375	410	460	360	395	445	490
M5	80	85	95	110	85	95	105	120	95	100	110	125
	260	280	310	360	280	310	345	395	310	330	360	410
K1	175	190	215	245	220	240	260	300	—	—	—	—
	570	620	710	800	720	790	850	980	—	—	—	—
K2	160	175	190	215	195	210	235	265	—	—	—	—
	520	570	620	710	640	690	770	870	—	—	—	—
K3	135	145	160	185	165	180	200	225	—	—	—	—
	445	475	520	610	540	590	660	740	—	—	—	—
K4	130	140	155	175	160	170	190	215	—	—	—	—
	425	460	510	570	520	560	620	710	—	—	—	—
K5	80	85	95	110	95	105	115	130	—	—	—	—
	260	280	310	360	310	345	375	425	—	—	—	—
K6	115	125	135	155	140	150	170	190	—	—	—	—
	375	410	445	510	460	490	560	620	—	—	—	—
K7	100	110	120	140	125	135	150	170	—	—	—	—
	330	360	395	460	410	445	490	560	—	—	—	—
N1	1300	1400	1550	1750	—	—	—	—	1575	1700	1850	2125
	4275	4600	5075	5750	—	—	—	—	5175	5575	6075	6975
N2	530	570	630	710	—	—	—	—	630	680	750	860
	1750	1875	2075	2325	—	—	—	—	2075	2225	2450	2825
N3	350	380	420	475	—	—	—	—	420	455	500	570
	1150	1250	1375	1550	—	—	—	—	1375	1500	1650	1875
N11	400	435	480	540	—	—	—	—	480	520	570	650
	1300	1425	1575	1775	—	—	—	—	1575	1700	1875	2125
S1	45	48	55	60	—	—	—	—	50	55	60	70
	150	155	180	195	—	—	—	—	165	180	195	230
S2	36	39	43	49	—	—	—	—	42	45	50	55
	120	130	140	160	—	—	—	—	140	150	165	180
S3	32	34	38	43	—	—	—	—	37	40	44	50
	105	110	125	140	—	—	—	—	120	130	145	165
S11	60	70	75	85	—	—	—	—	75	80	85	100
	195	230	245	280	—	—	—	—	245	260	280	330
S12	43	47	50	60	—	—	—	—	42	46	50	60
	140	155	165	195	—	—	—	—	140	150	165	195
S13	25	27	30	35	—	—	—	—	24	26	29	33
	80	90	100	115	—	—	—	—	80	85	95	110
H5	38	41	45	50	—	—	—	—	—	—	—	—
	125	135	150	165	—	—	—	—	—	—	—	—
H8	41	44	49	55	—	—	—	—	—	—	—	—
	135	145	160	180	—	—	—	—	—	—	—	—
H11	49	55	55	65	—	—	—	—	—	—	—	—
	160	180	180	215	—	—	—	—	—	—	—	—
H12	75	80	90	100	—	—	—	—	—	—	—	—
	245	260	295	330	—	—	—	—	—	—	—	—
H21	41	44	49	55	—	—	—	—	—	—	—	—
	135	145	160	180	—	—	—	—	—	—	—	—

Square shoulder and slot milling cutters
Helical milling cutters
Face milling cutters
Disc milling cutters
High feed milling cutters
Copy milling cutters
Plunge milling cutters
Chamfer milling cutters
Spot facing cutters
Inserts

Square shoulder and
slot milling cutters

Helical milling cutters

Face milling cutters

Disc milling cutters

High feed milling
cutters

Copy milling cutters

Plunge milling cutters

Chamfer milling cutters

Spot facing cutters

Inserts



R220.60

Face mills for heavy duty. Strong inserts and the cutter is equipped with cassettes for handling high metal removal.

- Cutter range 63-250 mm
- Inserts SPEN/SPER/SPMR19
- Available in many different grades for most common workpiece materials

R220.60-19CM – Metric

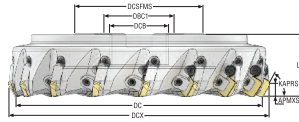

- For insert selection and cutting data recommendations, see page(s) 330 - 331
- For complete insert programme, see page(s) 859
- For ISO attribute explanation, see page 16

Designation	Item number	Type of mounting	DC	ZEFP	APMXS	KAPRS°	DCX	DCB	DCSFMS	LF	RPMX	Weight	Insert
			mm		mm		mm	mm	mm	mm		kg	
R220.60-0063-19-4CM	00073305	Arbor	63,0	4	12,0	60,0	77,6	22,0	47,0	50,0	3700	1,1	SP..1906ZETR
R220.60-0080-19-5CM	00073306	Arbor	80,0	5	12,0	60,0	94,5	27,0	62,0	50,0	3300	1,7	SP..1906ZETR
R220.60-0100-19-6CM	00073307	Arbor	100,0	6	12,0	60,0	114,4	32,0	77,0	50,0	2900	2,4	SP..1906ZETR
R220.60-0125-19-8CM	00073309	Arbor	125,0	8	12,0	60,0	139,3	40,0	90,0	63,0	2600	4,0	SP..1906ZETR
R220.60-8160-19-10CM	00073311	Arbor	160,0	10	12,0	60,0	174,3	40,0	90,0	63,0	2300	6,3	SP..1906ZETR
R220.60-8200-19-12CM	00073313	Arbor	200,0	12	12,0	60,0	214,2	60,0	168,0	63,0	2000	9,0	SP..1906ZETR
R220.60-8250-19-16CM	00073318	Arbor	250,0	16	12,0	60,0	264,2	60,0	218,0	63,0	1800	20,0	SP..1906ZETR

Spare Parts, included in delivery

For cutter	Adjustment unit	Arbor screw	Cassette	Cassette screw	Insert wedge	Wedge key	Wedge screw
R220.66-0063	AU1114T-T15P	220.17-692	SP19DRM	FS96018	CW0813	H6B-T25P	LD8020-T25P
R220.66-0080	AU1114T-T15P	MC6S12X35	SP19DRM	FS96018	CW0813	H6B-T25P	LD8020-T25P
R220.66-0100	AU1114T-T15P	-	SP19DRM	FS96018	CW0813	H6B-T25PL	LD8020-T25P
R220.66-0125	AU1114T-T15P	-	SP19DRM	FS96018	CW0813	H6B-T25PL	LD8020-T25P
R220.66-8160	AU1114T-T15P	-	SP19DRM	FS96018	CW0813	H6B-T25PL	LD8020-T25P
R220.66-8200-8250	AU1114T-T15P	-	SP19DRM	FS96018	CW0813	H6B-T25PL	LD8020-T25P

Accessories

For cutter	Arbor screw	Arbor screw 2	Key	Setting key
R220.66-0063-0080	-	-	5SMS795	T15P-4
R220.66-0100	5803216	-	-	T15P-4
R220.66-0125	5804020	-	-	T15P-4
R220.66-8160	MC6S12X40	MC6S12X50	-	T15P-4
R220.66-8200-8250	MC6S16X50	-	-	T15P-4

Torque and fixed keys, see page 894

R220.60-19 – Insert selection – mm/Inch

SMG		a _p	f _z			
			80%	60%	40%	20%
P1	SPER1906ZETR-M17 T350M	7,0	0,30	0,30	0,30	0,36
		0,28	0,012	0,012	0,012	0,014
P2	SPER1906ZETR-M17 T350M	7,0	0,30	0,30	0,30	0,38
		0,28	0,012	0,012	0,012	0,015
P3	SPER1906ZETR-M17 T350M	7,0	0,28	0,28	0,28	0,36
		0,28	0,011	0,011	0,011	0,014
P4	SPEN1906ZETR-MD20 MP2501	7,0	0,30	0,30	0,32	0,38
		0,28	0,012	0,012	0,013	0,015
P5	SPEN1906ZETR-MD20 MP2501	7,0	0,30	0,30	0,30	0,38
		0,28	0,012	0,012	0,012	0,015
P6	SPEN1906ZETR-MD20 MP2501	7,0	0,30	0,30	0,30	0,38
		0,28	0,012	0,012	0,012	0,015
P7	SPER1906ZETR-M17 T350M	7,0	0,26	0,26	0,28	0,34
		0,28	0,010	0,010	0,011	0,013
P8	SPER1906ZETR-M17 T350M	7,0	0,28	0,28	0,28	0,36
		0,28	0,011	0,011	0,011	0,014
P11	SPMR1906ZETR-M17 MP2050	7,0	0,26	0,26	0,28	0,34
		0,28	0,010	0,010	0,011	0,013
P12	SPMR1906ZETR-M17 MP2050	6,0	0,18	0,18	0,19	0,24
		0,24	0,0070	0,0070	0,0075	0,0095
M1	SPER1906ZETR-M17 T350M	7,0	0,30	0,30	0,30	0,38
		0,28	0,012	0,012	0,012	0,015
M2	SPER1906ZETR-M17 T350M	7,0	0,26	0,26	0,28	0,34
		0,28	0,010	0,010	0,011	0,013
M3	SPMR1906ZETR-M17 MP2050	6,0	0,22	0,22	0,22	0,28
		0,24	0,0085	0,0085	0,0085	0,011
M4	SPMR1906ZETR-M17 MP2050	4,5	0,19	0,19	0,19	0,24
		0,18	0,0075	0,0075	0,0075	0,0095
M5	SPMR1906ZETR-M17 MP2050	4,5	0,19	0,19	0,19	0,24
		0,18	0,0075	0,0075	0,0075	0,0095
K1	SPEN1906ZETR-D25 MP1501	7,0	0,42	0,42	0,42	0,50
		0,28	0,017	0,017	0,017	0,020
K2	SPEN1906ZETR-D25 MP1501	7,0	0,38	0,38	0,38	0,48
		0,28	0,015	0,015	0,015	0,019
K3	SPEN1906ZETR-D25 MP1501	7,0	0,38	0,38	0,38	0,48
		0,28	0,015	0,015	0,015	0,019
K4	SPEN1906ZETR-D25 MP1501	7,0	0,38	0,38	0,38	0,48
		0,28	0,015	0,015	0,015	0,019
K5	SPEN1906ZETR-D25 MP1501	7,0	0,34	0,34	0,34	0,42
		0,28	0,013	0,013	0,013	0,017
K6	SPEN1906ZETR-D25 MP1501	7,0	0,38	0,38	0,38	0,48
		0,28	0,015	0,015	0,015	0,019
K7	SPEN1906ZETR-D25 MP1501	7,0	0,34	0,34	0,34	0,42
		0,28	0,013	0,013	0,013	0,017

SMG = Seco material group
 f_z = mm/tooth (in/tooth), v_c = m/min (sf/min), a_p/DC = %
 All cutting data are start values

R220.60-19 – Cutting data $v_c = (m/min)/(sf/min)$

SMG	MP1501				MP2501				T350M				T25M				MP2050			
	100%	80%	60%	40%	100%	80%	60%	40%	100%	80%	60%	40%	100%	80%	60%	40%	100%	80%	60%	40%
P1	200	210	230	255	180	185	205	225	170	175	190	210	160	170	185	200	220	230	250	280
	660	690	750	840	590	610	670	740	560	570	620	690	520	560	610	660	720	750	820	920
P2	195	200	220	245	170	180	195	220	160	170	185	205	155	160	175	195	215	225	245	275
	640	660	720	800	560	590	640	720	520	560	610	670	510	520	570	640	710	740	800	900
P3	170	175	190	215	150	155	170	190	140	150	160	180	135	140	155	175	190	200	215	240
	560	570	620	710	490	510	560	620	460	490	520	590	445	460	510	570	620	660	710	790
P4	150	160	170	190	135	140	150	170	125	135	145	160	120	130	140	150	165	175	190	210
	490	520	560	620	445	460	490	560	410	445	475	520	395	425	460	490	540	570	620	690
P5	145	150	165	185	130	135	145	165	120	130	140	155	115	120	130	150	160	165	180	205
	475	490	540	610	425	445	475	540	395	425	460	510	375	395	425	490	520	540	590	670
P6	160	170	185	210	145	150	165	185	135	145	155	175	130	135	150	165	185	190	210	225
	520	560	610	690	475	490	540	610	445	475	510	570	425	445	490	540	610	620	690	740
P7	155	160	175	195	135	140	155	175	130	135	145	165	125	130	140	155	170	180	195	215
	510	520	570	640	445	460	510	570	425	445	475	540	410	425	460	510	560	590	640	710
P8	140	150	160	180	125	130	145	160	120	125	135	150	115	120	130	145	160	165	180	205
	460	490	520	590	410	425	475	520	395	410	445	490	375	395	425	475	520	540	590	670
P11	150	155	170	190	130	140	150	170	125	130	140	160	120	125	135	155	165	175	190	210
	490	510	560	620	425	460	490	560	410	425	460	520	395	410	445	510	540	570	620	690
P12	100	105	115	130	90	95	100	115	85	90	95	105	80	85	90	100	110	115	125	140
	330	345	375	425	295	310	330	375	280	295	310	345	260	280	295	330	360	375	410	460
M1	—	—	—	—	125	130	140	155	125	130	140	160	125	130	140	160	155	160	175	195
	—	—	—	—	410	425	460	510	410	425	460	520	410	425	460	520	510	520	570	640
M2	—	—	—	—	105	110	115	130	105	110	120	135	105	110	120	135	125	135	145	160
	—	—	—	—	345	360	375	425	345	360	395	445	345	360	395	445	410	445	475	520
M3	—	—	—	—	85	90	95	110	85	90	100	110	85	90	100	110	105	110	120	135
	—	—	—	—	280	295	310	360	280	295	330	360	280	295	330	360	345	360	395	445
M4	—	—	—	—	65	70	75	85	65	70	75	85	65	70	75	85	80	85	95	105
	—	—	—	—	215	230	245	280	215	230	245	280	215	230	245	280	260	280	310	345
M5	—	—	—	—	55	60	65	70	55	60	65	70	55	60	65	70	70	70	80	85
	—	—	—	—	180	195	215	230	180	195	215	230	180	195	215	230	230	230	260	280
K1	155	160	175	195	135	140	155	175	125	135	145	165	120	130	140	155	—	—	—	—
	510	520	570	640	445	460	510	570	410	445	475	540	395	425	460	510	—	—	—	—
K2	135	145	155	175	120	125	140	155	115	120	130	145	110	115	125	140	—	—	—	—
	445	475	510	570	395	410	460	510	375	395	425	475	360	375	410	460	—	—	—	—
K3	115	120	130	150	105	110	115	130	95	100	110	125	95	100	105	120	—	—	—	—
	375	395	425	490	345	360	375	425	310	330	360	410	310	330	345	395	—	—	—	—
K4	110	115	125	140	100	105	110	125	95	100	105	120	90	95	100	115	—	—	—	—
	360	375	410	460	330	345	360	410	310	330	345	395	295	310	330	375	—	—	—	—
K5	70	70	80	90	60	65	70	80	55	60	65	70	55	55	60	70	—	—	—	—
	230	230	260	295	195	215	230	260	180	195	215	230	180	180	195	230	—	—	—	—
K6	100	100	110	125	85	90	100	110	80	85	95	105	80	80	90	100	—	—	—	—
	330	330	360	410	280	295	330	360	260	280	310	345	260	260	295	330	—	—	—	—
K7	90	90	100	110	80	80	90	100	75	75	85	95	70	75	80	90	—	—	—	—
	295	295	330	360	260	260	295	330	245	245	280	310	230	245	260	295	—	—	—	—

Square shoulder and slot milling cutters
Helical milling cutters
Face milling cutters
Disc milling cutters
High feed milling cutters
Copy milling cutters
Plunge milling cutters
Chamfer milling cutters
Spot facing cutters
Inserts



R220.30 -12

This cutter family can meet the highest surface finish requirements in a variety of materials. The strength is in cast iron materials due to a comprehensive offer in geometry and grade combinations. The adjustable pocket ensures a high run out accuracy and the precise inserts reduces the efforts to set the cutter. The single sided inserts are light cutting and include a long wiper flat to meet the requirements of bigger diameter cutters. The included crown design on the SEEX1203 inserts compensates a misalignment between spindle head and the workpiece to ensure a superb surface finish and appearance. The inserts offer is ideal for special cutters like hybrid cutters for rough-finishing with dedicated roughing inserts as well as pure finishing cutters with customized pitches and handling units.

- DC = 80 – 355 mm
- Available in both course and close pitch versions
- Available in both cassette version and fix pocket and also for mounting as CAP

R220.30-12CT – Metric

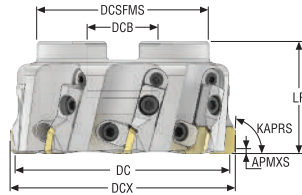

- For insert selection and cutting data recommendations, see page(s) 336 - 337
- For complete insert programme, see page(s) 845
- For ISO attribute explanation, see page 16

Designation	Item number	Type of mounting	DC	ZEFP	APMXS	KAPRS°	DCX	DCB	DCSFMS	LF	RPMX	Weight	Insert
			mm		mm		mm	mm	mm	mm		kg	
R220.30-0080-12CT	75068850	Arbor	80,0	6	1,0	88,0	80,75	27,0	56,0	50,0	4800	1,1	SE..1203
R220.30-0100-12CT	75068851	Arbor	100,0	8	1,0	88,0	100,72	32,0	77,0	50,0	4300	1,8	SE..1203
R220.30-0125-12CT	75068852	Arbor	125,0	10	1,0	88,0	126,02	40,0	90,0	63,0	3800	3,3	SE..1203
R220.30-8250-12CT	75068855	Arbor	250,0	22	1,0	88,0	250,91	60,0	130,0	63,0	2700	16,5	SE..1203

Spare Parts, included in delivery

For cutter	Adjustment unit	Arbor screw	Cassette	Cassette screw	Insert wedge	Key	Wedge screw
R220.30-0080	AU1114T-T15P	MF6S12X45	SE12PRC	FS95018	334.5-640	H04-4	268-650
R220.30-0100	AU1114T-T15P	MC6S16X35	SE12PRC	FS95018	334.5-640	H04-4	268-650
R220.30-0125-8250	AU1114T-T15P	-	SE12PRC	FS95018	334.5-640	H04-4	268-650

Torque and fixed keys, see page 894

Square shoulder and slot milling cutters

Helical milling cutters

Face milling cutters

Disc milling cutters

High feed milling cutters

Copy milling cutters

Plunge milling cutters

Chamfer milling cutters

Spot facing cutters

Inserts



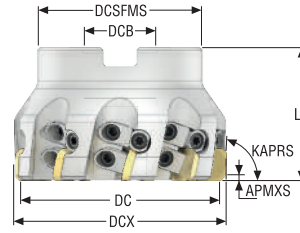

R220.30-12ST – Metric

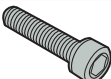
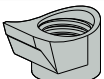

- For insert selection and cutting data recommendations, see page(s) 336 - 337
- For complete insert programme, see page(s) 845
- For ISO attribute explanation, see page 16

Designation	Item number	Type of mounting	DC	ZEFP	APMXS	KAPRS°	DCX	DCB	DCSFMS	LF	RPMX	Weight	Insert
			mm		mm		mm	mm	mm	mm		kg	
R220.30-0080-12ST	75038551	Arbor	80,0	9	1,0	88,0	80,75	27,0	56,0	50,0	5300	1,2	SE..1203
R220.30-8160-12ST	75036394	Arbor	160,0	20	1,0	88,0	160,97	40,0	90,0	63,0	3800	5,6	SE..1203
R220.30-8200-12ST	75066297	Arbor	200,0	25	1,0	88,0	200,94	60,0	130,0	63,0	3300	7,2	SE..1203

Spare Parts, included in delivery

For cutter	Arbor screw	Insert wedge	Key	Setting gauge	Setting screw	Wedge screw
R220.30-0080	 MC6S12X40	 CW0608	 T15P-4ST	 AS6011	 LD6019-T15P	 LD6018T-T15P
R220.30-8160-8200	-	CW0608	T15P-4ST	AS6011	LD6019-T15P	LD6018T-T15P

Torque and fixed keys, see page 894

R220.30-12ST CAP – Metric

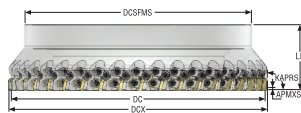

- For insert selection and cutting data recommendations, see page(s) 336 - 337
- For complete insert programme, see page(s) 845
- For ISO attribute explanation, see page 16

Designation	Item number	Type of mounting	DC	ZEFP	APMXS	KAPRS°	DCX	DCB	DCSFMS	LF	RPMX	Weight	Insert
			mm		mm		mm	mm	mm	mm		kg	
R220.30-9250-12ST	75077274	Arbor	250,0	32	1,0	88,0	250,97	–	220,0	63,0	3000	9,2	SE..1203
R220.30-9355-12ST	75077276	Arbor	355,0	44	1,0	88,0	355,94	–	285,0	63,0	2500	15,9	SE..1203

Spare Parts, included in delivery

For cutter	Insert wedge	Key	Setting gauge	Setting screw	Wedge screw
R220.30-9250-9355	CW0608	T15P-4ST	AS6011	LD6019-T15P	LD6018T-T15P

Torque and fixed keys, see page 894

Square shoulder and slot milling cutters

Helical milling cutters

Face milling cutters

Disc milling cutters

High feed milling cutters

Copy milling cutters

Plunge milling cutters

Chamfer milling cutters

Spot facing cutters

Inserts

R220.30-12 – Insert selection – mm/Inch

SMG		a _p	f _z			
			80%	60%	40%	20%
P1	SEEX1203AFTN-M13 T350M	0,60	0,18	0,18	0,19	0,22
		0.024	0.0070	0.0070	0.0075	0.0085
P2	SEEX1203AFTN-M13 T350M	0,60	0,19	0,19	0,19	0,24
		0.024	0.0075	0.0075	0.0075	0.0095
P3	SEEX1203AFTN-M13 T350M	0,60	0,18	0,18	0,18	0,22
		0.024	0.0070	0.0070	0.0070	0.0085
P4	SEEX1203AFTN-M13 T350M	0,60	0,17	0,17	0,18	0,22
		0.024	0.0065	0.0065	0.0070	0.0085
P5	SEEX1203AFTN-M13 T350M	0,60	0,17	0,17	0,17	0,22
		0.024	0.0065	0.0065	0.0065	0.0085
P6	SEEX1203AFTN-M13 T350M	0,60	0,17	0,17	0,17	0,20
		0.024	0.0065	0.0065	0.0065	0.0080
P7	SEEX1203AFTN-M13 T350M	0,60	0,17	0,17	0,17	0,20
		0.024	0.0065	0.0065	0.0065	0.0080
P8	SEEX1203AFTN-M13 T350M	0,60	0,18	0,18	0,18	0,22
		0.024	0.0070	0.0070	0.0070	0.0085
P11	SEEX1203AFTN-M13 T350M	0,60	0,17	0,17	0,17	0,20
		0.024	0.0065	0.0065	0.0065	0.0080
P12	SEEX1203AFTN-M13 T350M	0,48	0,11	0,11	0,12	0,14
		0.019	0.0044	0.0044	0.0048	0.0055
M1	SEEX1203AFTN-M13 T350M	0,60	0,19	0,19	0,19	0,24
		0.024	0.0075	0.0075	0.0075	0.0095
M2	SEEX1203AFTN-M13 T350M	0,60	0,17	0,17	0,17	0,22
		0.024	0.0065	0.0065	0.0065	0.0085
M3	SEEX1203AFTN-M13 T350M	0,48	0,14	0,14	0,14	0,17
		0.019	0.0055	0.0055	0.0055	0.0065
M4	SEEX1203AFTN-M13 T350M	0,36	0,12	0,12	0,12	0,15
		0.014	0.0048	0.0048	0.0048	0.0060
M5	SEEX1203AFTN-M13 T350M	0,36	0,12	0,12	0,12	0,15
		0.014	0.0048	0.0048	0.0048	0.0060
K1	SEEX1203AFTN-MD14 MH1000	0,60	0,20	0,20	0,20	0,25
		0.024	0.0080	0.0080	0.0080	0.010
K2	SEEX1203AFTN-MD14 MH1000	0,60	0,18	0,18	0,19	0,22
		0.024	0.0070	0.0070	0.0075	0.0085
K3	SEEX1203AFTN-MD14 MH1000	0,60	0,18	0,18	0,19	0,22
		0.024	0.0070	0.0070	0.0075	0.0085
K4	SEEX1203AFTN-MD14 MH1000	0,60	0,18	0,18	0,19	0,22
		0.024	0.0070	0.0070	0.0075	0.0085
K5	SEEX1203AFTN-MD14 MH1000	0,60	0,16	0,16	0,17	0,20
		0.024	0.0065	0.0065	0.0065	0.0080
K6	SEEX1203AFTN-MD14 MH1000	0,60	0,18	0,18	0,19	0,22
		0.024	0.0070	0.0070	0.0075	0.0085
K7	SEEX1203AFTN-MD14 MH1000	0,60	0,16	0,16	0,17	0,20
		0.024	0.0065	0.0065	0.0065	0.0080
H5	SEEX1203AFTN-MD14 F15M	0,48	0,12	0,12	0,13	0,15
		0.019	0.0048	0.0048	0.0050	0.0065
H8	SEEX1203AFTN-MD14 F15M	0,42	0,095	0,095	0,095	0,12
		0.017	0.0038	0.0038	0.0038	0.0048
H11	SEEX1203AFTN-MD14 F15M	0,48	0,12	0,12	0,13	0,15
		0.019	0.0048	0.0048	0.0050	0.0065
H12	SEEX1203AFTN-MD14 F15M	0,42	0,095	0,095	0,095	0,12
		0.017	0.0038	0.0038	0.0038	0.0048
H21	SEEX1203AFTN-MD14 F15M	0,42	0,095	0,095	0,095	0,12
		0.017	0.0038	0.0038	0.0038	0.0048

SMG = Seco material group
 f_z = mm/tooth (in/tooth), v_c = m/min (sf/min), a_p/DC = %
 All cutting data are start values

R220.30-12 – Cutting data $v_c = (m/min)/(sf/min)$

SMG	T350M				F15M				MK1500				MH1000				H15			
	100%	80%	60%	40%	100%	80%	60%	40%	100%	80%	60%	40%	100%	80%	60%	40%	100%	80%	60%	40%
P1	225	235	255	275	225	240	255	285	—	—	—	—	—	—	—	—	—	—	—	—
	740	770	840	900	740	790	840	940	—	—	—	—	—	—	—	—	—	—	—	—
P2	215	225	245	270	220	230	250	280	—	—	—	—	—	—	—	—	—	—	—	—
	710	740	800	890	720	750	820	920	—	—	—	—	—	—	—	—	—	—	—	—
P3	185	195	210	235	190	200	220	240	—	—	—	—	—	—	—	—	—	—	—	—
	610	640	690	770	620	660	720	790	—	—	—	—	—	—	—	—	—	—	—	—
P4	165	175	190	210	170	180	190	215	—	—	—	—	—	—	—	—	—	—	—	—
	540	570	620	690	560	590	620	710	—	—	—	—	—	—	—	—	—	—	—	—
P5	160	170	180	200	165	175	185	205	—	—	—	—	200	210	225	245	—	—	—	—
	520	560	590	660	540	570	610	670	—	—	—	—	660	690	740	800	—	—	—	—
P6	180	190	205	225	185	195	210	230	—	—	—	—	225	235	250	280	—	—	—	—
	590	620	670	740	610	640	690	750	—	—	—	—	740	770	820	920	—	—	—	—
P7	170	180	190	215	175	185	195	220	—	—	—	—	210	220	240	265	—	—	—	—
	560	590	620	710	570	610	640	720	—	—	—	—	690	720	790	870	—	—	—	—
P8	155	165	180	200	160	170	185	205	—	—	—	—	195	205	220	245	—	—	—	—
	510	540	590	660	520	560	610	670	—	—	—	—	640	670	720	800	—	—	—	—
P11	165	175	185	205	170	180	190	215	—	—	—	—	205	215	230	255	—	—	—	—
	540	570	610	670	560	590	620	710	—	—	—	—	670	710	750	840	—	—	—	—
P12	110	115	125	135	—	—	—	—	—	—	—	—	135	145	155	165	—	—	—	—
	360	375	410	445	—	—	—	—	—	—	—	—	445	475	510	540	—	—	—	—
M1	165	175	185	210	—	—	—	—	—	—	—	—	—	—	—	—	—	—	—	—
	540	570	610	690	—	—	—	—	—	—	—	—	—	—	—	—	—	—	—	—
M2	140	145	155	175	—	—	—	—	—	—	—	—	—	—	—	—	—	—	—	—
	460	475	510	570	—	—	—	—	—	—	—	—	—	—	—	—	—	—	—	—
M3	110	115	125	140	—	—	—	—	—	—	—	—	—	—	—	—	—	—	—	—
	360	375	410	460	—	—	—	—	—	—	—	—	—	—	—	—	—	—	—	—
M4	85	90	100	110	—	—	—	—	—	—	—	—	—	—	—	—	—	—	—	—
	280	295	330	360	—	—	—	—	—	—	—	—	—	—	—	—	—	—	—	—
M5	75	75	85	90	—	—	—	—	—	—	—	—	—	—	—	—	—	—	—	—
	245	245	280	295	—	—	—	—	—	—	—	—	—	—	—	—	—	—	—	—
K1	170	180	190	215	175	185	200	220	270	285	310	345	210	220	240	265	140	145	155	175
	560	590	620	710	570	610	660	720	890	940	1025	1125	690	720	790	870	460	475	510	570
K2	150	160	170	190	155	165	175	195	245	255	275	300	190	200	215	235	125	130	140	155
	490	520	560	620	510	540	570	640	800	840	900	980	620	660	710	770	410	425	460	510
K3	130	135	145	160	130	140	150	165	205	215	235	255	160	170	180	200	105	110	120	130
	425	445	475	520	425	460	490	540	670	710	770	840	520	560	590	660	345	360	395	425
K4	125	130	140	155	125	130	145	155	195	205	220	245	150	160	170	190	100	105	115	125
	410	425	460	510	410	425	475	510	640	670	720	800	490	520	560	620	330	345	375	410
K5	75	80	85	95	75	80	90	95	120	125	135	150	95	100	105	115	60	65	70	75
	245	260	280	310	245	260	295	310	395	410	445	490	310	330	345	375	195	215	230	245
K6	110	115	120	135	110	115	125	140	175	180	195	215	135	140	150	165	90	90	100	110
	360	375	395	445	360	375	410	460	570	590	640	710	445	460	490	540	295	295	330	360
K7	95	100	110	120	100	105	110	125	155	165	175	190	120	125	135	150	80	85	90	95
	310	330	360	395	330	345	360	410	510	540	570	620	395	410	445	490	260	280	295	310
H5	36	38	41	45	37	39	42	46	—	—	—	—	45	47	50	55	—	—	—	—
	120	125	135	150	120	130	140	150	—	—	—	—	150	155	165	180	—	—	—	—
H8	38	41	44	48	39	42	45	49	—	—	—	—	48	50	55	60	—	—	—	—
	125	135	145	155	130	140	150	160	—	—	—	—	155	165	180	195	—	—	—	—
H11	46	49	55	55	47	50	55	60	—	—	—	—	55	60	65	70	—	—	—	—
	150	160	180	180	155	165	180	195	—	—	—	—	180	195	215	230	—	—	—	—
H12	70	75	80	85	70	75	80	90	—	—	—	—	85	90	95	105	—	—	—	—
	230	245	260	280	230	245	260	295	—	—	—	—	280	295	310	345	—	—	—	—
H21	38	41	44	48	39	42	45	49	—	—	—	—	48	50	55	60	—	—	—	—
	125	135	145	155	130	140	150	160	—	—	—	—	155	165	180	195	—	—	—	—

Square shoulder and slot milling cutters
Helical milling cutters
Face milling cutters
Disc milling cutters
High feed milling cutters
Copy milling cutters
Plunge milling cutters
Chamfer milling cutters
Spot facing cutters
Inserts



R230.19

This finishing cutter subsist on an exceptional run out even though it is a fixed pocket solution. The axial mounted inserts have a high accuracy and are light cutting at the same time thanks to the positive rake face design. The small wiper flat length created furthermore low axial tool pressure and the high run out accuracy enables you to run above the wiper flat and still achieve an excellent surface finish. This family is ideal for weak machines and smaller diameter in steel and stainless-steel materials.

- DC = 30 – 100 mm
- R230.19 Face mills for finishing
- Inserts with 4 cutting edges
- Single sided inserts

R230.19 - Metric – Metric

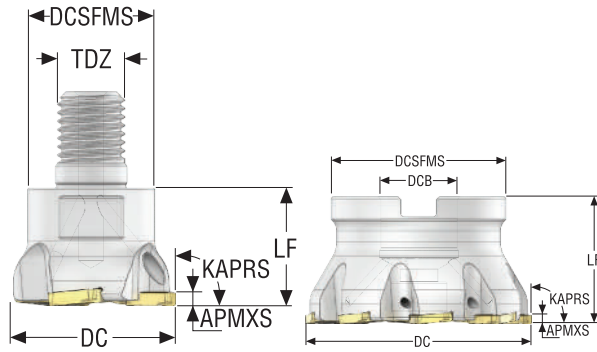

- For insert selection and cutting data recommendations, see page(s) 340 - 341
- For complete insert programme, see page(s) N/A
- For ISO attribute explanation, see page 16

Designation	Item number	Type of mounting	DC	ZEPF	APMXS	KAPRS°	DCSFMS	DCB	TDZ	LF	Weight	RPMX	Insert
			mm		mm		mm	mm		mm	kg		
R230.19-1030.RE-SN1103-3A	02735709	Combimaster	30,0	3	2,6	90,0	18,5	–	M10	20,0	0,1	18900	SNHQ1103xxR
R230.19-1640.RE-SN1203-3A	02735718	Combimaster	40,0	3	3,1	90,0	30,0	–	M16	28,0	0,2	16700	SNHQ1203xxR
R230.19-0050-SN1203-5A	02735719	Arbor	50,0	5	3,1	90,0	42,0	22,0	–	40,0	0,3	12300	SNHQ1203xxR
R230.19-0063-SN1203-6A	02735734	Arbor	63,0	5	3,1	90,0	50,0	27,0	–	45,0	0,6	10900	SNHQ1203xxR
R230.19-0080-SN1203-8A	02735736	Arbor	80,0	5	3,1	90,0	62,0	27,0	–	45,0	1,0	9700	SNHQ1203xxR
R230.19-0100-SN1203-10A	02735737	Arbor	100,0	10	3,1	90,0	77,0	32,0	–	50,0	1,7	8700	SNHQ1203xxR

Spare Parts, included in delivery

For cutter	Arbor screw	Insert key	Insert screw
R230.19-1103	–	H4B-T09P	C93505-T09P
R230.19-1203	–	H4B-T15P	C94006-T15P
R230.19-1203 ø50	220.17-692M	H4B-T15P	C94006-T15P
R230.19-1203 ø63-80	MC6S12X35	H4B-T15P	C94006-T15P
R230.19-1203 ø100	MC6S16X40	H4B-T15PL	C94006-T15P

Accessories

For cutter	Insert clamping torque	Torque key
R230.19-1103	2.0NM	T00-09P20
R230.19-1203	3.5NM	T00-15P35

Torque and fixed keys, see page 894

Square shoulder and slot milling cutters

Helical milling cutters

Face milling cutters

Disc milling cutters

High feed milling cutters

Copy milling cutters

Plunge milling cutters

Chamfer milling cutters

Spot facing cutters

Inserts

R230.19 – Insert selection – mm/Inch

SMG		a _p	f _z			
			80%	60%	40%	20%
P1	SNHQ120308TR4-M07 F40M	1,9	0,12	0,12	0,12	0,15
		0,075	0,0048	0,0048	0,0048	0,0060
P2	SNHQ120308TR4-M07 F40M	1,9	0,12	0,12	0,13	0,15
		0,075	0,0048	0,0048	0,0050	0,0060
P3	SNHQ120308TR4-M07 F40M	1,9	0,12	0,12	0,12	0,14
		0,075	0,0048	0,0048	0,0048	0,0055
P4	SNHQ120308TR4-M07 F40M	1,9	0,11	0,11	0,12	0,14
		0,075	0,0044	0,0044	0,0048	0,0055
P5	SNHQ120308TR4-M07 F40M	1,9	0,11	0,11	0,11	0,14
		0,075	0,0044	0,0044	0,0044	0,0055
P6	SNHQ120308TR4-M07 F40M	1,9	0,11	0,11	0,11	0,14
		0,075	0,0044	0,0044	0,0044	0,0055
P7	SNHQ120308TR4-M07 F40M	1,9	0,11	0,11	0,11	0,14
		0,075	0,0044	0,0044	0,0044	0,0055
P8	SNHQ120308TR4-M07 F40M	1,9	0,12	0,12	0,12	0,14
		0,075	0,0048	0,0048	0,0048	0,0055
P11	SNHQ120308TR4-M07 F40M	1,9	0,11	0,11	0,11	0,14
		0,075	0,0044	0,0044	0,0044	0,0055
P12	SNHQ120308TR4-M07 F40M	1,5	0,080	0,080	0,080	0,10
		0,060	0,0032	0,0032	0,0032	0,0040
M1	SNHQ120308TR4-M07 F40M	1,9	0,12	0,12	0,13	0,15
		0,075	0,0048	0,0048	0,0050	0,0060
M2	SNHQ120308TR4-M07 F40M	1,9	0,11	0,11	0,11	0,14
		0,075	0,0044	0,0044	0,0044	0,0055
M3	SNHQ120308TR4-M07 F40M	1,5	0,095	0,095	0,095	0,12
		0,060	0,0038	0,0038	0,0038	0,0048
M4	SNHQ120308TR4-M07 F40M	1,1	0,090	0,090	0,090	0,11
		0,044	0,0036	0,0036	0,0036	0,0044
M5	SNHQ120308TR4-M07 F40M	1,1	0,090	0,090	0,090	0,11
		0,044	0,0036	0,0036	0,0036	0,0044
K1	SNHQ120308TR4-M07 MP2501	1,9	0,12	0,12	0,13	0,15
		0,075	0,0048	0,0048	0,0050	0,0060
K2	SNHQ120308TR4-M07 MP2501	1,9	0,11	0,11	0,11	0,14
		0,075	0,0044	0,0044	0,0044	0,0055
K3	SNHQ120308TR4-M07 MP2501	1,9	0,11	0,11	0,11	0,14
		0,075	0,0044	0,0044	0,0044	0,0055
K4	SNHQ120308TR4-M07 MP2501	1,9	0,11	0,11	0,11	0,14
		0,075	0,0044	0,0044	0,0044	0,0055
K5	SNHQ120308TR4-M07 MP2501	1,9	0,10	0,10	0,10	0,13
		0,075	0,0040	0,0040	0,0040	0,0050
K6	SNHQ120308TR4-M07 MP2501	1,9	0,11	0,11	0,11	0,14
		0,075	0,0044	0,0044	0,0044	0,0055
K7	SNHQ120308TR4-M07 MP2501	1,9	0,10	0,10	0,10	0,13
		0,075	0,0040	0,0040	0,0040	0,0050
S1	SNHQ120308TR4-M07 F40M	1,1	0,090	0,090	0,090	0,11
		0,044	0,0036	0,0036	0,0036	0,0044
S2	SNHQ120308TR4-M07 F40M	1,1	0,090	0,090	0,090	0,11
		0,044	0,0036	0,0036	0,0036	0,0044
S3	SNHQ120308TR4-M07 F40M	1,1	0,085	0,085	0,085	0,10
		0,044	0,0034	0,0034	0,0034	0,0040
S11	SNHQ120308TR4-M07 F40M	1,3	0,095	0,095	0,10	0,12
		0,050	0,0038	0,0038	0,0040	0,0048
S12	SNHQ120308TR4-M07 F40M	1,3	0,095	0,095	0,10	0,12
		0,050	0,0038	0,0038	0,0040	0,0048
S13	SNHQ120308TR4-M07 F40M	1,1	0,090	0,090	0,090	0,11
		0,044	0,0036	0,0036	0,0036	0,0044

SMG = Seco material group
 f_z = mm/tooth (in/tooth), v_c = m/min (sf/min), a_p/DC = %
 All cutting data are start values

R230.19 – Cutting data $v_c = (m/min)/(sf/min)$

SMG	F40M				F30M				MP2501			
	100%	80%	60%	40%	100%	80%	60%	40%	100%	80%	60%	40%
P1	225	240	260	285	240	250	270	290	300	315	340	380
	740	790	850	940	790	820	890	950	980	1025	1125	1250
P2	220	235	250	275	225	240	255	285	290	310	330	360
	720	770	820	900	740	790	840	940	950	1025	1075	1175
P3	190	200	215	240	200	210	225	250	250	265	285	315
	620	660	710	790	660	690	740	820	820	870	940	1025
P4	170	175	190	210	175	185	200	220	220	235	250	280
	560	570	620	690	570	610	660	720	720	770	820	920
P5	165	175	185	200	165	175	190	210	215	230	245	265
	540	570	610	660	540	570	620	690	710	750	800	870
P6	185	195	210	230	190	200	215	235	245	255	275	305
	610	640	690	750	620	660	710	770	800	840	900	1000
P7	175	185	195	220	175	185	200	225	230	240	260	290
	570	610	640	720	570	610	660	740	750	790	850	950
P8	160	170	180	200	165	175	190	210	210	225	240	265
	520	560	590	660	540	570	620	690	690	740	790	870
P11	170	180	190	210	170	180	195	215	225	235	255	280
	560	590	620	690	560	590	640	710	740	770	840	920
P12	110	115	125	135	110	120	130	140	145	150	165	180
	360	375	410	445	360	395	425	460	475	490	540	590
M1	180	190	205	220	180	190	205	230	210	220	240	260
	590	620	670	720	590	620	670	750	690	720	790	850
M2	145	155	165	180	150	160	170	190	175	185	200	215
	475	510	540	590	490	520	560	620	570	610	660	710
M3	120	125	135	145	125	130	140	155	140	150	160	175
	395	410	445	475	410	425	460	510	460	490	520	570
M4	90	100	105	115	95	100	110	120	110	115	125	135
	295	330	345	375	310	330	360	395	360	375	410	445
M5	75	80	85	95	80	85	90	100	90	95	105	110
	245	260	280	310	260	280	295	330	295	310	345	360
K1	175	185	200	215	180	190	205	225	230	245	265	285
	570	610	660	710	590	620	670	740	750	800	870	940
K2	155	165	175	190	160	170	180	200	205	215	235	250
	510	540	570	620	520	560	590	660	670	710	770	820
K3	130	140	150	160	135	140	155	170	175	185	195	215
	425	460	490	520	445	460	510	560	570	610	640	710
K4	125	135	145	155	130	135	145	160	165	175	190	205
	410	445	475	510	425	445	475	520	540	570	620	670
K5	75	80	85	95	80	85	90	100	100	105	115	125
	245	260	280	310	260	280	295	330	330	345	375	410
K6	110	115	125	135	115	120	130	140	145	155	165	180
	360	375	410	445	375	395	425	460	475	510	540	590
K7	100	105	110	125	100	105	115	125	130	135	145	165
	330	345	360	410	330	345	375	410	425	445	475	540
S1	43	46	49	55	45	48	50	55	55	55	60	65
	140	150	160	180	150	155	165	180	180	180	195	215
S2	35	37	39	43	36	38	41	45	43	45	48	55
	115	120	130	140	120	125	135	150	140	150	155	180
S3	30	32	34	37	32	34	36	39	37	40	42	46
	100	105	110	120	105	110	120	130	120	130	140	150
S11	60	65	70	75	65	65	70	75	75	80	85	90
	195	215	230	245	215	215	230	245	245	260	280	295
S12	41	44	47	50	36	38	41	44	50	55	60	65
	135	145	155	165	120	125	135	145	165	180	195	215
S13	24	26	27	30	21	22	24	26	30	32	34	37
	80	85	90	100	70	70	80	85	100	105	110	120

Square shoulder and slot milling cutters
Helical milling cutters
Face milling cutters
Disc milling cutters
High feed milling cutters
Copy milling cutters
Plunge milling cutters
Chamfer milling cutters
Spot facing cutters
Inserts

A full range of cutters for all kinds of disc Milling operations

Seco's disc mills, available from 0,7 to 32 mm (0.029 to 1.25") in width, offer a wide range of cutter diameters and connection types suitable for all relevant machine tools and disc milling applications.

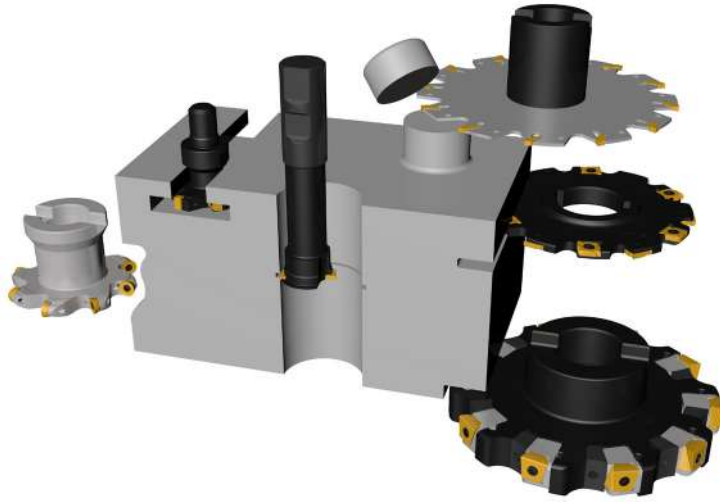

The core of the range consists of 4 main cutter families



Min

Max



335.10 for narrow slotting and sawing
Width 2,25-4,1mm, .089"-.122"



335.19 for small width of cut and sawing
Fixed pockets
Width 4-12mm, .156"-.500"



335.18 for medium width of cut
Fixed and adjustable width
Width 8-20mm, .312"-.750"



335.25 for large width of cut
Fixed and adjustable width
Width 13,5 -32mm, .53"-1.26"

And 4 other families dedicated to specific disc milling operation

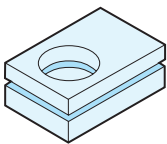

335.14 and 335.15 for circlips groove and narrow slotting
Width 0,7-5,15mm, .029"-.203"



335.29, 335.18 and 335.25 equipped with round insert - full radius profile and copy milling. Fixed and adjustable width
Width 5 - 20 mm, .197"-.787"

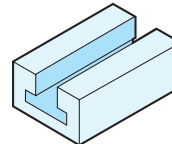
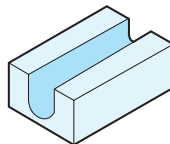

335.16 for T-slots
Width 11 - 22 mm, 0.387" - 0.823"



Square shoulder and slot milling cutters
Helical milling cutters
Face milling cutters
Disc milling cutters
High feed milling cutters
Copy milling cutters
Plunge milling cutters
Chamfer milling cutters
Spot facing cutters
Inserts



335.14

Small diameter disc milling cutter system dedicated for shallow grooving, circlips grooving, top and bottom chamfering, full radius profile and threading

- Exchangeable carbide head systems to help controlling machining costs
- Width of cut range 0.7-6.0 mm (0.043-0.236 inch)
- Diameter insert range 9.7-34.7 mm (.381 - 1.36 inch)
- A comprehensive range of cylindrical carbide and steel shanks, complemented with integrated ER collet chuck holder
- High precision width of cut $\pm 0.02\text{mm}$ - $\pm 0.0008''$

Disc Milling cutter 335.14

Disc milling cutter with exchangeable carbide head



A broad range of heads and shanks available for all your disc milling operation by circular interpolation or linear slotting.

- Strong, Reliable and precise connection between the head and the cutter body
- Cover all type of material with universal M geometry and F32M grade
- Heads from diameter 9.7 mm

Cylindrical



ER collet chuck



2 types of shanks available: cylindrical available both in steel and carbide, or ER collet chuck system

Grooving

Head from dia 9.7 to 34.7 mm (0.382" to 1.366") for bore with minimum dia 10mm (0.393")
Width from 1 to 6 mm (0.039 to 0.236")



Square shoulder and slot milling cutters
Helical milling cutters
Face milling cutters
Disc milling cutters
High feed milling cutters
Copy milling cutters
Plunge milling cutters
Chamfer milling cutters
Spot facing cutters
Inserts

Disc Milling cutter 335.14

Circlip groove

Head from dia 9.7 to 21.7 mm (0.382 to 0.854") and width from 0.7 to 5.15 mm (.029" to .203")



Full radius profile

Head from dia 11.7 to 21.7 (0.460 to 0.854") and width from 1 to 5 mm (0.039 to 0.197")



Top & bottom Chamfering profile

Head from dia 11.7 to 21.7 (0.460 to 0.854") and width from 1 to 4 mm (0.039 to 0.157")



Threading

Head from dia 11,7 to 27,7 mm (0.460 to 0.854") for partial metric threads with pitch 1-6 mm and full profile whitworth threads with pitch 19 to 11 tpi and UN threads with pitch 24 to 6 tpi.



Square shoulder and slot milling cutters

Helical milling cutters

Face milling cutters

Disc milling cutters

High feed milling cutters

Copy milling cutters

Plunge milling cutters

Chamfer milling cutters

Spot facing cutters

Inserts

Code key – Heads

R	335	14	217	150	12	Z3	M03	F32M
1	2	3	4	5	6	7	8	9

1.	2.	3.
Right hand rotation	Disc Milling code	System
4.	5.	6.
Head diameter example: 21.7mm	Width of cut : example 1.5mm Alternative: R20: Corner radius for full radius - example R=2mm C45: Top/ bottom chamfering - example 45° Threading code key: see page 347	Connection size (insert / shank) in mm Example: 12mm
7.	8.	9.
Number of teeth Example Zc=3	Edge geometry	Grade

- Square shoulder and slot milling cutters
- Helical milling cutters
- Face milling cutters
- Disc milling cutters
- High feed milling cutters
- Copy milling cutters
- Plunge milling cutters
- Chamfer milling cutters
- Spot facing cutters
- Inserts

Code key – Heads Threading

R	335	14	217	M	N	P	250500	12	Z3
1	2	3	4	5	6	7	8	9	10

1.	2.	3.
Right hand	Disc milling code	System
4.	5.	6.
Head diameter example: 21.7 mm	Thread type (W and UN)	Internal thread (E = external, X = internal/external)
7.	8.	9.
Partial profile (F = full profile)	Pitch size (2,50-5,00 mm or ex. only a fixed pitch 2,5 mm, 16 tpi...)	Connection size
10		
No. of teeth		

Square shoulder and
slot milling cutters

Helical milling cutters

Face milling cutters

Disc milling cutters

High feed milling
cutters

Copy milling cutters

Plunge milling cutters

Chamfer milling cutters

Spot facing cutters

Inserts

Code key – Shank

Cylindrical shank

335	14	16	9	0	45	110	E
1	2	3	4	5	6	7	8

1.	2.	3.
Disc Milling code	System	Shank diameter DMM = 16mm Alternative inch, example 0625 for DMM=0.625"
4.	5.	6.
Connection size (insert/shank) in mm Example: 9mm	.0 cylindrical connection type	Access length including insert 45 mm Alternative Inch, example 177 for 1.77"
7.	8.	
Overall length including insert 110 mm Alternative Inch, example 433 for 4.33"	-E for carbide shank otherwise steel shank	

Collet chuck

335	14	ER25	12	30
1	2	3	4	5

1.	2.	3.
Disc Milling code	System	ER Collet chuck size
4.	5.	
Connection size (insert / shank) in mm Example: 12mm	Access length in mm including insert Example 30mm	

Selection – shanks

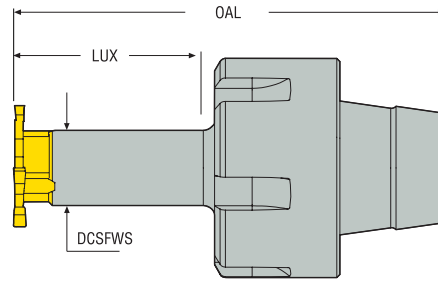
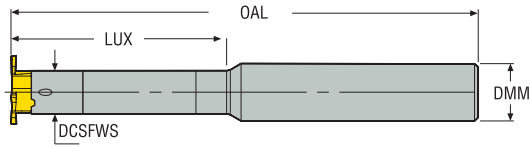

		Shank diameter mm								Shank diameter inch				ER collect chuck size			
		DMM = 10		DMM = 12		DMM = 16		DMM = 20		DMM=0.5		DMM=0.625		ER11	ER16	ER25	ER32
		OAL	LUX	OAL	LUX	OAL	LUX	OAL	LUX	OAL	LUX	OAL	LUX	LUX mm (inch)			
Connection size (DCSFWS)	6	60	15	80	21					3.15	0.83			16 (0.63)			
				90	30					3.54	1.18						
				100	42					3.94	1.65						
	8	60	17	95	29					3.74	1.14			16 (0.63)	22 (0.866)		
				110	42					4.33	1.65						
				120	56					4.72	2.2						
	9					80	18					3.15	0.71	22 (0.866)	22 (0.866)	22 (0.866)	
						100	32					3.94	1.26				
						110	45					4.33	1.77				
						130	64					5.12	2.52				
	12					80	24					3.15	0.94	30 (1.181)	30 (1.181)	30 (1.181)	
						100	42					3.94	1.65				
					130	60					5.12	2.36					
					160	85					6.3	3.35					
14					100	42					3.94	1.65			19 (0.748)	19 (0.748)	
					130	60					5.12	2.36			35 (1.378)	35 (1.378)	
					160	85					6.3	3.35					
See page								100	35							360-361	
																	362

The dimensions OAL and LUX are indicated for a tool with 3 teeth.

Shank in steel
Shank in carbide

Square shoulder and slot milling cutters
 Helical milling cutters
 Face milling cutters
 Disc milling cutters
 High feed milling cutters
 Copy milling cutters
 Plunge milling cutters
 Chamfer milling cutters
 Spot facing cutters
 Inserts

335.14 insert: general grooving

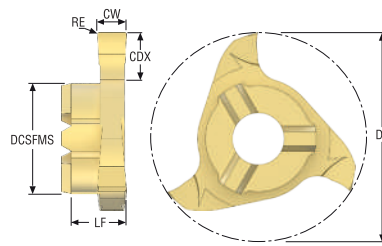

- Suitable shank, see page 360-362
- Cutting data, see page(s) 363 - 366
- Technical information, see page 368
- For ISO attribute explanation, see page 16

Designation	DC	CW	CDX	DCSFMS	LF	RE	ZEPF	Grades Coated			
	mm Inch	mm Inch	mm Inch	mm Inch	mm Inch	mm Inch		F32M			
R335.14-097100.06Z3-M01	9,7 0.382	1,0 0.039	1,5 0.059	6,0 0.236	3,35 0.132	0,1 0.004	3	■			
R335.14-097150.06Z3-M01	9,7 0.382	1,5 0.059	1,5 0.059	6,0 0.236	3,5 0.138	0,2 0.008	3	■			
R335.14-097200.06Z3-M01	9,7 0.382	2,0 0.079	1,5 0.059	6,0 0.236	3,5 0.138	0,2 0.008	3	■			
R335.14-097250.06Z3-M01	9,7 0.382	2,5 0.098	1,5 0.059	6,0 0.236	3,5 0.138	0,2 0.008	3	■			
R335.14-137100.08Z3-M01	13,7 0.539	1,0 0.039	2,5 0.098	8,0 0.315	4,35 0.171	0,1 0.004	3	■			
R335.14-137150.08Z3-M01	13,7 0.539	1,5 0.059	2,5 0.098	8,0 0.315	4,5 0.177	0,2 0.008	3	■			
R335.14-137200.08Z3-M01	13,7 0.539	2,0 0.079	2,5 0.098	8,0 0.315	4,5 0.177	0,2 0.008	3	■			
R335.14-137250.08Z3-M01	13,7 0.539	2,5 0.098	2,5 0.098	8,0 0.315	4,5 0.177	0,2 0.008	3	■			
R335.14-177150.09Z3-M02	17,7 0.697	1,5 0.059	3,5 0.138	9,0 0.354	5,75 0.226	0,2 0.008	3	■			
R335.14-177200.09Z3-M02	17,7 0.697	2,0 0.079	3,5 0.138	9,0 0.354	5,75 0.226	0,2 0.008	3	■			
R335.14-177250.09Z3-M02	17,7 0.697	2,5 0.098	3,5 0.138	9,0 0.354	5,75 0.226	0,2 0.008	3	■			
R335.14-177300.09Z3-M02	17,7 0.697	3,0 0.118	3,5 0.138	9,0 0.354	5,75 0.226	0,2 0.008	3	■			
R335.14-177400.09Z3-M02	17,7 0.697	4,0 0.157	3,5 0.138	9,0 0.354	5,75 0.226	0,2 0.008	3	■			
R335.14-217150.12Z3-M03	21,7 0.854	1,5 0.059	4,5 0.177	12,0 0.472	5,7 0.224	0,2 0.008	3	■			
R335.14-217200.12Z3-M03	21,7 0.854	2,0 0.079	4,5 0.177	12,0 0.472	5,7 0.224	0,2 0.008	3	■			
R335.14-217250.12Z3-M03	21,7 0.854	2,5 0.098	4,5 0.177	12,0 0.472	5,7 0.224	0,2 0.008	3	■			
R335.14-217300.12Z3-M03	21,7 0.854	3,0 0.118	4,5 0.177	12,0 0.472	5,7 0.224	0,2 0.008	3	■			
R335.14-217400.12Z3-M03	21,7 0.854	4,0 0.157	4,5 0.177	12,0 0.472	5,7 0.224	0,2 0.008	3	■			
R335.14-217500.12Z3-M03	21,7 0.854	5,0 0.197	4,5 0.177	12,0 0.472	5,7 0.224	0,2 0.008	3	■			
R335.14-277150.14Z3-M03	27,7 1.091	1,5 0.059	6,5 0.256	14,0 0.551	6,5 0.256	0,2 0.008	3	■			
R335.14-277200.14Z3-M03	27,7 1.091	2,0 0.079	6,5 0.256	14,0 0.551	6,5 0.256	0,2 0.008	3	■			
R335.14-277250.14Z3-M03	27,7 1.091	2,5 0.098	6,5 0.256	14,0 0.551	6,5 0.256	0,2 0.008	3	■			

Square shoulder and slot milling cutters

Helical milling cutters

Face milling cutters

Disc milling cutters

High feed milling cutters

Copy milling cutters

Plunge milling cutters

Chamfer milling cutters

Spot facing cutters

Inserts

	Designation	DC	CW	CDX	DCSFMS	LF	RE	ZEFP	Grades Coated				
		mm <i>Inch</i>	mm <i>Inch</i>	mm <i>Inch</i>	mm <i>Inch</i>	mm <i>Inch</i>	mm <i>Inch</i>		F32M				
Square shoulder and slot milling cutters	R335.14-277300.14Z3-M03	27,7 <i>1.091</i>	3,0 <i>0.118</i>	6,5 <i>0.256</i>	14,0 <i>0.551</i>	6,5 <i>0.256</i>	0,2 <i>0.008</i>	3	■				
Helical milling cutters	R335.14-277350.14Z3-M03	27,7 <i>1.091</i>	3,5 <i>0.138</i>	6,5 <i>0.256</i>	14,0 <i>0.551</i>	6,5 <i>0.256</i>	0,2 <i>0.008</i>	3	■				
	R335.14-277400.14Z3-M03	27,7 <i>1.091</i>	4,0 <i>0.157</i>	6,5 <i>0.256</i>	14,0 <i>0.551</i>	6,5 <i>0.256</i>	0,2 <i>0.008</i>	3	■				
	R335.14-277500.14Z3-M03	27,7 <i>1.091</i>	5,0 <i>0.197</i>	6,5 <i>0.256</i>	14,0 <i>0.551</i>	6,6 <i>0.260</i>	0,2 <i>0.008</i>	3	■				
Face milling cutters	R335.14-277600.14Z3-M03	27,7 <i>1.091</i>	6,0 <i>0.236</i>	6,5 <i>0.256</i>	14,0 <i>0.551</i>	6,6 <i>0.260</i>	0,2 <i>0.008</i>	3	■				
Disc milling cutters													
High feed milling cutters													
Copy milling cutters													
Plunge milling cutters													
Chamfer milling cutters													
Spot facing cutters													
Inserts													

335.14 insert: general grooving

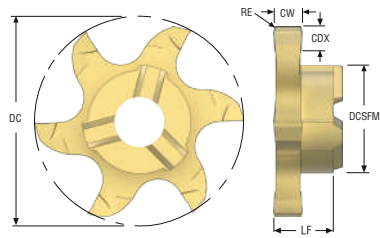

- Suitable shank, see page 360-362
- Cutting data, see page(s) 363 - 366
- Technical information, see page 368
- For ISO attribute explanation, see page 16

Designation	DC	CW	CDX	DCSFMS	LF	RE	ZEFP	Grades Coated			
	mm Inch	mm Inch	mm Inch	mm Inch	mm Inch	mm Inch		F32M			
R335.14-217150.12Z6-M03	21,7 0.854	1,5 0.059	4,5 0.177	12,0 0.472	6,25 0.246	0,1 0.004	6	■			
R335.14-217200.12Z6-M03	21,7 0.854	2,0 0.079	4,5 0.177	12,0 0.472	6,25 0.246	0,2 0.008	6	■			
R335.14-217250.12Z6-M03	21,7 0.854	2,5 0.098	4,5 0.177	12,0 0.472	6,25 0.246	0,2 0.008	6	■			
R335.14-217300.12Z6-M03	21,7 0.854	3,0 0.118	4,5 0.177	12,0 0.472	6,25 0.246	0,2 0.008	6	■			
R335.14-217400.12Z6-M03	21,7 0.854	4,0 0.157	4,5 0.177	12,0 0.472	6,25 0.246	0,2 0.008	6	■			
R335.14-277150.14Z6-M03	27,7 1.091	1,5 0.059	6,5 0.256	14,0 0.551	6,45 0.254	0,1 0.004	6	■			
R335.14-277200.14Z6-M03	27,7 1.091	2,0 0.079	6,5 0.256	14,0 0.551	6,4 0.252	0,2 0.008	6	■			
R335.14-277250.14Z6-M03	27,7 1.091	2,5 0.098	6,5 0.256	14,0 0.551	6,4 0.252	0,2 0.008	6	■			
R335.14-277300.14Z6-M03	27,7 1.091	3,0 0.118	6,5 0.256	14,0 0.551	6,4 0.252	0,2 0.008	6	■			
R335.14-277400.14Z6-M03	27,7 1.091	4,0 0.157	6,5 0.256	14,0 0.551	6,4 0.252	0,2 0.008	6	■			
R335.14-277500.14Z6-M03	27,7 1.091	5,0 0.197	6,5 0.256	14,0 0.551	6,35 0.250	0,2 0.008	6	■			
R335.14-277600.14Z6-M03	27,7 1.091	6,0 0.236	6,5 0.256	14,0 0.551	6,35 0.250	0,2 0.008	6	■			
R335.14-347150.14Z6-M03	34,7 1.366	1,5 0.059	10,0 0.394	14,0 0.551	6,25 0.246	0,1 0.004	6	■			
R335.14-347200.14Z6-M03	34,7 1.366	2,0 0.079	10,0 0.394	14,0 0.551	6,25 0.246	0,2 0.008	6	■			
R335.14-347250.14Z6-M03	34,7 1.366	2,5 0.098	10,0 0.394	14,0 0.551	6,25 0.246	0,2 0.008	6	■			
R335.14-347300.14Z6-M03	34,7 1.366	3,0 0.118	10,0 0.394	14,0 0.551	6,25 0.246	0,2 0.008	6	■			

Square shoulder and slot milling cutters

Helical milling cutters

Face milling cutters

Disc milling cutters

High feed milling cutters

Copy milling cutters

Plunge milling cutters

Chamfer milling cutters

Spot facing cutters

Inserts

335.14 insert: For circlips groove

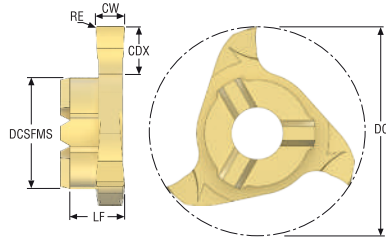

- Suitable shank, see page 360-362
- Cutting data, see page(s) 363 - 366
- Technical information, see page 368
- For ISO attribute explanation, see page 16

Designation	DC	CW	CDX	DCSFMS	LF	RE	ZEFP	Grades Coated		
	mm Inch	mm Inch	mm Inch	mm Inch	mm Inch	mm Inch		F32M		
R335.14-097070.06Z3-M01	9,7 0.382	0,74 0.029	1,5 0.059	6,0 0.236	3,35 0.132	0,0 -	3	■		
R335.14-097080.06Z3-M01	9,7 0.382	0,84 0.033	1,5 0.059	6,0 0.236	3,35 0.132	0,0 -	3	■		
R335.14-097090.06Z3-M01	9,7 0.382	0,94 0.037	1,5 0.059	6,0 0.236	3,35 0.132	0,0 -	3	■		
R335.14-097110.06Z3-M01	9,7 0.382	1,21 0.048	1,5 0.059	6,0 0.236	3,5 0.138	0,0 -	3	■		
R335.14-097130.06Z3-M01	9,7 0.382	1,41 0.056	1,5 0.059	6,0 0.236	3,5 0.138	0,1 0.004	3	■		
R335.14-177110.09Z3-M02	17,7 0.697	1,21 0.048	3,5 0.138	9,0 0.354	5,75 0.226	0,0 -	3	■		
R335.14-177130.09Z3-M02	17,7 0.697	1,41 0.056	3,5 0.138	9,0 0.354	5,75 0.226	0,1 0.004	3	■		
R335.14-177160.09Z3-M02	17,7 0.697	1,71 0.067	3,5 0.138	9,0 0.354	5,75 0.226	0,1 0.004	3	■		
R335.14-217160.12Z3-M03	21,7 0.854	1,71 0.067	4,5 0.177	12,0 0.472	5,7 0.224	0,1 0.004	3	■		
R335.14-217185.12Z3-M03	21,7 0.854	1,96 0.077	4,5 0.177	12,0 0.472	5,7 0.224	0,15 0.006	3	■		
R335.14-217215.12Z3-M03	21,7 0.854	2,26 0.089	4,5 0.177	12,0 0.472	5,7 0.224	0,15 0.006	3	■		
R335.14-217265.12Z3-M03	21,7 0.854	2,76 0.109	4,5 0.177	12,0 0.472	5,7 0.224	0,15 0.006	3	■		
R335.14-217315.12Z3-M03	21,7 0.854	3,26 0.128	4,5 0.177	12,0 0.472	5,7 0.224	0,15 0.006	3	■		
R335.14-217415.12Z3-M03	21,7 0.854	4,26 0.168	4,5 0.177	12,0 0.472	5,7 0.224	0,15 0.006	3	■		
R335.14-217515.12Z3-M03	21,7 0.854	5,26 0.207	4,5 0.177	12,0 0.472	5,7 0.224	0,15 0.006	3	■		

335.14 insert: Full radius profile

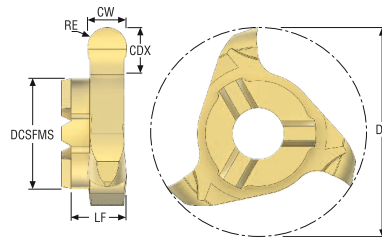

- Suitable shank, see page 360-362
- Cutting data, see page(s) 363 - 366
- Technical information, see page 368
- For ISO attribute explanation, see page 16

Designation	DC	CW	CDX	DCSFMS	LF	RE	ZEFP	Grades Coated			
	mm Inch	mm Inch	mm Inch	mm Inch	mm Inch	mm Inch		F32M			
R335.14-117R11.06Z3-M01	11,7 0.461	2,2 0.087	2,5 0.098	6,0 0.236	3,5 0.138	1,1 0.043	3	■			
R335.14-177R11.09Z3-M02	17,7 0.697	2,2 0.087	3,5 0.138	9,0 0.354	5,75 0.226	1,1 0.043	3	■			
R335.14-217R05.12Z3-M03	21,7 0.854	1,0 0.039	4,5 0.177	12,0 0.472	5,6 0.220	0,5 0.020	3	■			
R335.14-217R10.12Z3-M03	21,7 0.854	2,0 0.079	4,5 0.177	12,0 0.472	5,75 0.226	1,0 0.039	3	■			
R335.14-217R15.12Z3-M03	21,7 0.854	3,0 0.118	4,5 0.177	12,0 0.472	5,75 0.226	1,5 0.059	3	■			
R335.14-217R20.12Z3-M03	21,7 0.854	4,0 0.157	4,5 0.177	12,0 0.472	5,75 0.226	2,0 0.079	3	■			
R335.14-217R25.12Z3-M03	21,7 0.854	5,0 0.197	4,5 0.177	12,0 0.472	5,75 0.226	2,5 0.098	3	■			

Square shoulder and slot milling cutters

Helical milling cutters

Face milling cutters

Disc milling cutters

High feed milling cutters

Copy milling cutters

Plunge milling cutters

Chamfer milling cutters

Spot facing cutters

Inserts

335.14 insert: Top and Bottom chamfering

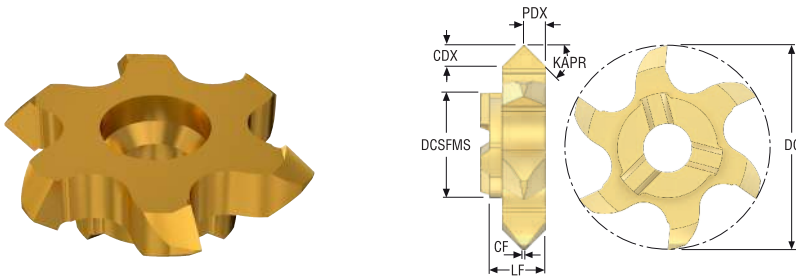

- Suitable shank, see page 360-362
- Cutting data, see page(s) 363 - 366
- Technical information, see page 368
- For ISO attribute explanation, see page 16

Designation	DC		CF		CDX		PDX		DCSFMS		LF		KAPR		ZEFP		Grades Coated	
	mm	Inch	mm	Inch	mm	Inch	mm	Inch	mm	Inch	mm	Inch	mm	Inch	mm	Inch		
R335.14-097C45.06Z6-M01	9,7	0.382	0,2	0.008	1,2	0.047	1,5	0.059	6,0	0.236	3,4	0.134	45,0	6	■			
R335.14-137C45.08Z6-M01	13,7	0.539	0,2	0.008	1,8	0.071	2,2	0.087	8,0	0.315	4,6	0.181	45,0	6	■			
R335.14-177C45.09Z6-M02	17,7	0.697	0,2	0.008	2,2	0.087	2,8	0.110	9,0	0.354	5,8	0.228	45,0	6	■			
R335.14-217C45.12Z6-M03	21,7	0.854	0,2	0.008	2,0	0.079	2,3	0.091	12,0	0.472	6,05	0.238	45,0	6	■			

Square shoulder and slot milling cutters
Helical milling cutters
Face milling cutters
Disc milling cutters
High feed milling cutters
Copy milling cutters
Plunge milling cutters
Chamfer milling cutters
Spot facing cutters
Inserts

335.14 Insert: Threading profile Whitworth

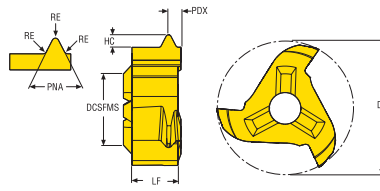

- Suitable shank, see page 360-362
- Cutting data, see page(s) 367
- Technical information, see page 368
- For ISO attribute explanation, see page 16

Designation	DC	HC	PNA	PDX	DCSFMS	LF	RE	ZEFP	Grades Coated			
									F32M			
R335.14-117WXF11.06Z3	11,7 0.461	1,48 0.058	55,0 2.165	1,6 0.063	6,0 0.236	3,6 0.142	0,31 0.012	3	■			
R335.14-117WXF14.06Z3	11,7 0.461	1,16 0.046	55,0 2.165	1,3 0.051	6,0 0.236	3,6 0.142	0,24 0.009	3	■			
R335.14-117WXF19.06Z3	11,7 0.461	0,86 0.034	55,0 2.165	1,1 0.043	6,0 0.236	3,6 0.142	0,18 0.007	3	■			
R335.14-157WXF14.08Z3	15,7 0.618	1,17 0.046	55,0 2.165	1,5 0.059	8,0 0.315	4,6 0.181	0,24 0.009	3	■			
R335.14-177WXF11.09Z3	17,7 0.697	1,48 0.058	55,0 2.165	1,45 0.057	9,0 0.354	5,85 0.230	0,31 0.012	3	■			
R335.14-177WXF14.09Z3	17,7 0.697	1,16 0.046	55,0 2.165	1,25 0.049	9,0 0.354	5,85 0.230	0,24 0.009	3	■			
R335.14-177WXF19.09Z3	17,7 0.697	0,856 0.034	55,0 2.165	0,95 0.037	9,0 0.354	5,85 0.230	0,18 0.007	3	■			

Square shoulder and slot milling cutters

Helical milling cutters

Face milling cutters

Disc milling cutters

High feed milling cutters

Copy milling cutters

Plunge milling cutters

Chamfer milling cutters

Spot facing cutters

Inserts

335.14 Insert: Threading Partial profile

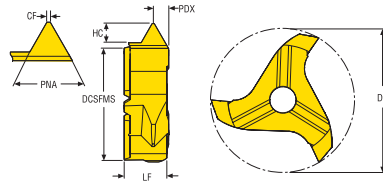

- Suitable shank, see page 360-362
- Cutting data, see page(s) 367
- Technical information, see page 368
- For ISO attribute explanation, see page 16

Designation	DC	HC	CF	PNA	PDX	DCSFMS	LF	ZEFP	Grades Coated				
	mm Inch	mm Inch	mm Inch	mm Inch	mm Inch	mm Inch	mm Inch		F32M				
R335.14-117MNP100200.06Z3	11,7 0.461	1,25 0.049	0,13 0.005	60,0 2.362	0,8 0.031	6,0 0.236	3,6 0.142	3	■				
R335.14-117MNP200300.06Z3	11,7 0.461	1,78 0.070	0,25 0.010	60,0 2.362	1,2 0.047	6,0 0.236	3,6 0.142	3	■				
R335.14-157MNP150275.08Z3	15,7 0.618	1,67 0.066	0,19 0.007	60,0 2.362	1,1 0.043	8,0 0.315	4,6 0.181	3	■				
R335.14-157MNP250300.08Z3	15,7 0.618	1,78 0.070	0,31 0.012	60,0 2.362	1,2 0.047	8,0 0.315	4,6 0.181	3	■				
R335.14-177MNP100200.09Z3	17,7 0.697	1,19 0.047	0,12 0.005	60,0 2.362	1,15 0.045	9,0 0.354	5,85 0.230	3	■				
R335.14-177MNP150275.09Z3	17,7 0.697	1,62 0.064	0,19 0.007	60,0 2.362	1,25 0.049	9,0 0.354	5,85 0.230	3	■				
R335.14-177MNP200375.09Z3	17,7 0.697	2,22 0.087	0,25 0.010	60,0 2.362	1,65 0.065	9,0 0.354	5,85 0.230	3	■				
R335.14-177MNP300550.09Z3	17,7 0.697	3,25 0.128	0,38 0.015	60,0 2.362	2,25 0.089	9,0 0.354	5,85 0.230	3	■				
R335.14-217MNP100200.12Z3	21,7 0.854	1,19 0.047	0,12 0.005	60,0 2.362	1,25 0.049	12,0 0.472	5,85 0.230	3	■				
R335.14-217MNP200375.12Z3	21,7 0.854	2,22 0.087	0,25 0.010	60,0 2.362	1,65 0.065	12,0 0.472	5,85 0.230	3	■				
R335.14-217MNP250450.12Z3	21,7 0.854	2,7 0.106	0,25 0.010	60,0 2.362	2,15 0.085	12,0 0.472	5,85 0.230	3	■				
R335.14-217MNP350600.12Z3	21,7 0.854	3,84 0.151	0,44 0.017	60,0 2.362	2,65 0.104	12,0 0.472	5,85 0.230	3	■				
R335.14-277MNP250500.14Z3	27,7 1.091	2,93 0.115	0,37 0.015	60,0 2.362	2,6 0.102	14,0 0.551	6,6 0.260	3	■				
R335.14-277MNP400600.14Z3	27,7 1.091	4,6 0.181	0,5 0.020	60,0 2.362	3,0 0.118	14,0 0.551	6,6 0.260	3	■				

335.14 Insert: Threading profile UN

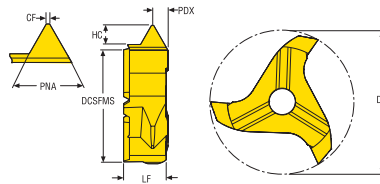

- Suitable shank, see page 360-362
- Cutting data, see page(s) 367
- Technical information, see page 368
- For ISO attribute explanation, see page 16

Designation	DC	HC	CF	PNA	PDX	DCSFMS	LF	ZEPF	Grades Coated			
	mm Inch	mm Inch	mm Inch	mm Inch	mm Inch	mm Inch	mm Inch		F32M			
R335.14-177UNNF10.09Z3	17,7 0.697	1,375 0.054	0,32 0.013	60,0 2.362	1,25 0.049	9,0 0.354	5,85 0.230	3	■			
R335.14-177UNNF11.09Z3	17,7 0.697	1,249 0.049	0,29 0.011	60,0 2.362	1,05 0.041	9,0 0.354	5,85 0.230	3	■			
R335.14-177UNNF12.09Z3	17,7 0.697	1,146 0.045	0,27 0.011	60,0 2.362	1,05 0.041	9,0 0.354	5,85 0.230	3	■			
R335.14-177UNNF14.09Z3	17,7 0.697	0,982 0.039	0,23 0.009	60,0 2.362	0,85 0.033	9,0 0.354	5,85 0.230	3	■			
R335.14-177UNNF16.09Z3	17,7 0.697	0,859 0.034	0,2 0.008	60,0 2.362	0,85 0.033	9,0 0.354	5,85 0.230	3	■			
R335.14-177UNNF18.09Z3	17,7 0.697	0,763 0.030	0,18 0.007	60,0 2.362	0,85 0.033	9,0 0.354	5,85 0.230	3	■			
R335.14-177UNNF20.09Z3	17,7 0.697	0,687 0.027	0,16 0.006	60,0 2.362	0,65 0.026	9,0 0.354	5,85 0.230	3	■			
R335.14-177UNNF24.09Z3	17,7 0.697	0,572 0.023	0,13 0.005	60,0 2.362	0,65 0.026	9,0 0.354	5,85 0.230	3	■			
R335.14-177UNNF6.09Z3	17,7 0.697	2,291 0.090	0,53 0.021	60,0 2.362	1,65 0.065	9,0 0.354	5,85 0.230	3	■			
R335.14-177UNNF8.09Z3	17,7 0.697	1,718 0.068	0,4 0.016	60,0 2.362	1,45 0.057	9,0 0.354	5,85 0.230	3	■			

Square shoulder and slot milling cutters

Helical milling cutters

Face milling cutters

Disc milling cutters

High feed milling cutters

Copy milling cutters

Plunge milling cutters

Chamfer milling cutters

Spot facing cutters

Inserts

335.14 shank - Cylindrical version – Metric

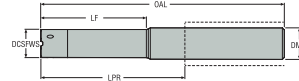













- Cutting data, see page(s) 363 - 367
- Technical information, see page 368
- For ISO attribute explanation, see page 16

Designation	Item number	DCSFWS	DMM	OAL	LF	LPR	Through coolant	RPMX	Weight	Insert
		mm	mm	mm	mm	mm			kg	
335.14-1006.0-015-060	03042024	6,0	10,0	56,5	11,5	16,5	–	30000	0,1	R335.14...06Z..
335.14-1206.0-021-080-E	03042025	6,0	12,0	76,5	17,5	31,5	✓	30000	0,1	R335.14...06Z..
335.14-1206.0-030-090-E	03042026	6,0	12,0	86,5	26,5	41,5	✓	30000	0,1	R335.14...06Z..
335.14-1206.0-042-100-E	03042027	6,0	12,0	96,5	38,5	51,5	✓	30000	0,2	R335.14...06Z..
335.14-1008.0-017-060	03042040	8,0	10,0	55,5	12,5	15,5	–	30000	0,1	R335.14...08Z..
335.14-1208.0-029-095-E	03042041	8,0	12,0	90,5	24,5	45,5	✓	30000	0,2	R335.14...08Z..
335.14-1208.0-042-110-E	03042042	8,0	12,0	105,5	37,5	60,5	✓	30000	0,2	R335.14...08Z..
335.14-1208.0-056-120-E	03042043	8,0	12,0	115,5	51,5	70,5	✓	30000	0,2	R335.14...08Z..
335.14-1609.0-018-080	03042028	9,0	16,0	74,2	12,2	26,2	✓	30000	0,1	R335.14...09Z..
335.14-1609.0-032-100-E	03042029	9,0	16,0	94,2	26,2	46,2	✓	30000	0,3	R335.14...09Z..
335.14-1609.0-045-110-E	03042030	9,0	16,0	104,2	39,2	56,2	✓	30000	0,2	R335.14...09Z..
335.14-1609.0-064-130-E	03042031	9,0	16,0	124,2	58,2	76,2	✓	30000	0,3	R335.14...09Z..
335.14-1612.0-024-080	03042032	12,0	16,0	74,3	18,3	26,3	✓	30000	0,1	R335.14...12Z..
335.14-1612.0-042-100-E	03042033	12,0	16,0	94,3	36,3	46,3	✓	30000	0,2	R335.14...12Z..
335.14-1612.0-060-130-E	03042034	12,0	16,0	124,3	54,3	76,3	✓	30000	0,3	R335.14...12Z..
335.14-1612.0-085-160-E	03042035	12,0	16,0	154,3	76,3	106,3	✓	30000	0,4	R335.14...12Z..
335.14-1614.0-042-100-E	03042036	14,3	16,0	93,5	35,5	45,5	✓	30000	0,3	R335.14...14Z..
335.14-1614.0-060-130-E	03042037	14,3	16,0	123,5	53,5	75,5	✓	30000	0,3	R335.14...14Z..
335.14-1614.0-085-160-E	03042038	14,3	16,0	153,5	78,5	105,5	✓	30000	0,4	R335.14...14Z..
335.14-2014.0-036-100	03042039	14,0	20,0	93,5	29,2	43,5	✓	30000	0,2	R335.14...14Z..

Spare Parts, included in delivery

Accessories

For cutter	Insert key	Insert screw	Insert clamping torque	Torque key
335.14-...06	 H4B-T08P	 C92608-T08P	 2.0NM	T00-08P20
335.14-...08	 H4B-T10P	 C93510-T10P	 3.5NM	T00-10P35
335.14-...09	 H4B-T15P	 C94012-T15P	 5.0NM	T00-15P50
335.14-...12/14	 H6B-T20P	 C95012-T20P	 7.0NM	–

-E = Carbide shank with DMM tolerance = h6
Steel shank: DMM tolerance = g6

335.14 shank - Cylindrical version – inch

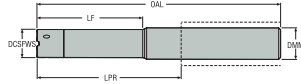

- Cutting data, see page(s) 363 - 367
- Technical information, see page 368
- For ISO attribute explanation, see page 16

Designation	Item number	DCSFWS	DMM	OAL	LF	LPR	Through coolant	RPMX	Weight	Insert
		inch	inch	inch	inch	inch			lbs	
335.14-050006.0-083-315-E	03042121	0.236	0.500	3.012	0.689	1.240	✓	30000	0.220	R334.14...06Z..
335.14-050006.0-118-354-E	03042122	0.236	0.500	3.406	1.043	1.634	✓	30000	0.440	R334.14...06Z..
335.14-050006.0-165-394-E	03042107	0.236	0.500	3.799	1.516	2.028	✓	30000	0.440	R334.14...06Z..
335.14-050008.0-114-374-E	03042123	0.315	0.500	3.563	0.965	1.791	✓	30000	0.440	R334.14...08Z..
335.14-050008.0-165-433-E	03042124	0.315	0.500	4.154	1.476	2.382	✓	30000	0.440	R334.14...08Z..
335.14-050008.0-220-472-E	03042119	0.315	0.500	4.547	2.028	2.776	✓	30000	0.440	R334.14...08Z..
335.14-062509.0-071-315	03042108	0.354	0.625	2.921	0.480	1.031	✓	30000	0.220	R334.14...09Z..
335.14-062509.0-126-394-E	03042109	0.354	0.625	3.709	1.031	1.819	✓	30000	0.440	R334.14...09Z..
335.14-062509.0-177-433-E	03042110	0.354	0.625	4.102	1.543	2.213	✓	30000	0.440	R334.14...09Z..
335.14-062509.0-252-512-E	03042111	0.354	0.625	4.890	2.291	3.000	✓	30000	0.660	R334.14...09Z..
335.14-062512.0-094-315	03042112	0.472	0.625	2.925	0.720	1.035	✓	30000	0.220	R334.14...12Z..
335.14-062512.0-165-394-E	03042113	0.472	0.625	3.713	1.429	1.823	✓	30000	0.440	R334.14...12Z..
335.14-062512.0-236-512-E	03042114	0.472	0.625	4.894	2.138	3.004	✓	30000	0.660	R334.14...12Z..
335.14-062512.0-335-630-E	03042115	0.472	0.625	6.075	3.122	4.185	✓	30000	0.660	R334.14...12Z..
335.14-062514.0-165-394-E	03042116	0.551	0.625	3.681	1.398	1.791	✓	30000	0.440	R334.14...14Z..
335.14-062514.0-236-512-E	03042117	0.551	0.625	4.862	2.106	2.972	✓	30000	0.880	R334.14...14Z..
335.14-062514.0-335-630-E	03042118	0.551	0.625	6.043	3.091	4.154	✓	30000	0.880	R334.14...14Z..

Spare Parts, included in delivery

Accessories

For cutter	Insert key	Insert screw	Insert clamping torque	Torque key
335.14-..06	H4B-T08P	C92608-T08P	17.7IN.LBS	T00-08P20
335.14-..08	H4B-T10P	C93510-T10P	31.0IN.LBS	T00-10P35
335.14-..09	H4B-T15P	C94012-T15P	44.3IN.LBS	T00-15P50
335.14-..12/14	H6B-T20P	C95012-T20P	62.0IN.LBS	-

-E = Carbide shank with DMM tolerance = h6
Steel shank: DMM tolerance = g6

Square shoulder and slot milling cutters

Helical milling cutters

Face milling cutters

Disc milling cutters

High feed milling cutters

Copy milling cutters

Plunge milling cutters

Chamfer milling cutters

Spot facing cutters

Inserts

335.14 Shank with ER collet

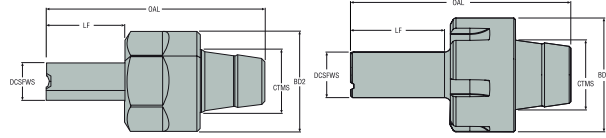

















- Cutting data, see page(s) 363 - 367
- Technical information, see page 368
- For ISO attribute explanation, see page 16

Designation	Item number	DCSFWS	CTMS	OAL	LF	BD2	RPMX	Design	Weight	Insert
		mm	mm	mm	mm	mm			kg	
335.14-ER11-06-016	03042072	6,0	ER 11	34,9	12,5	16,0	20000	1	0,1	R335.14...06Z..
335.14-ER11-08-016	03042085	8,0	ER 11	33,8	11,5	16,0	20000	1	0,1	R335.14...08Z..
335.14-ER16-08-022	03042086	8,0	ER 16	49,6	17,5	32,0	20000	2	0,2	R335.14...08Z..
335.14-ER11-09-022	03042073	9,0	ER 11	38,5	16,2	16,0	20000	1	0,1	R335.14...09Z..
335.14-ER16-09-022	03042074	9,0	ER 16	48,3	16,2	32,0	20000	2	0,2	R335.14...09Z..
335.14-ER25-09-022	03042075	9,0	ER 25	55,3	16,2	35,0	20000	2	0,2	R335.14...09Z..
335.14-ER16-12-030	03042076	12,0	ER 16	56,4	24,3	32,0	20000	2	0,2	R335.14...12Z..
335.14-ER25-12-030	03042078	12,0	ER 25	63,4	24,3	35,0	20000	2	0,2	R335.14...12Z..
335.14-ER32-12-030	03042079	12,0	ER 32	69,4	24,3	50,0	20000	2	0,4	R335.14...12Z..
335.14-ER25-14-019	03042080	14,0	ER 25	52,3	12,5	35,0	20000	2	0,2	R335.14...14Z..
335.14-ER25-14-035	03042081	14,0	ER 25	67,6	28,5	35,0	20000	2	0,2	R335.14...14Z..
335.14-ER32-14-019	03042082	14,0	ER 32	58,3	12,5	50,0	20000	2	0,5	R335.14...14Z..
335.14-ER32-14-035	03042083	14,0	ER 32	73,6	28,5	50,0	20000	2	0,4	R335.14...14Z..

Spare Parts, included in delivery

Accessories

For cutter	Insert key	Insert screw	Insert clamping torque	Torque key
335.14-ER..-06	 H4B-T08P	 C92608-T08P	 2.0NM	 T00-08P20
335.14-ER..-08	 H4B-T10P	 C93510-T10P	 3.5NM	 T00-10P35
335.14-ER..-09	 H4B-T15P	 C94012-T15P	 5.0NM	 T00-15P50
335.14-ER..-12/14	 H6B-T20P	 C95012-T20P	 7.0NM	 -

R335.14 – Grooving and Chamfering – Insert selection – mm/Inch

SMG		f _z		
		15%	10%	5%
P1	R335.14...-M01 F32M	0,036	0,042	0,060
		0.0014	0.0017	0.0024
P2	R335.14...-M01 F32M	0,036	0,042	0,060
		0.0014	0.0017	0.0024
P3	R335.14...-M01 F32M	0,034	0,040	0,055
		0.0013	0.0016	0.0022
P4	R335.14...-M01 F32M	0,034	0,040	0,055
		0.0013	0.0016	0.0022
P5	R335.14...-M01 F32M	0,032	0,038	0,055
		0.0013	0.0015	0.0022
P6	R335.14...-M01 F32M	0,032	0,038	0,055
		0.0013	0.0015	0.0022
P7	R335.14...-M01 F32M	0,032	0,038	0,055
		0.0013	0.0015	0.0022
P8	R335.14...-M01 F32M	0,034	0,040	0,055
		0.0013	0.0016	0.0022
P11	R335.14...-M01 F32M	0,032	0,038	0,055
		0.0013	0.0015	0.0022
P12	R335.14...-M01 F32M	0,020	0,024	0,032
		0.00075	0.00090	0.0013
M1	R335.14...-M01 F32M	0,036	0,042	0,060
		0.0014	0.0017	0.0024
M2	R335.14...-M01 F32M	0,032	0,038	0,055
		0.0013	0.0015	0.0022
M3	R335.14...-M01 F32M	0,026	0,030	0,042
		0.0010	0.0012	0.0017
M4	R335.14...-M01 F32M	0,020	0,025	0,034
		0.00080	0.00095	0.0013
M5	R335.14...-M01 F32M	0,020	0,025	0,034
		0.00080	0.00095	0.0013
K1	R335.14...-M01 F32M	0,036	0,042	0,060
		0.0014	0.0017	0.0024
K2	R335.14...-M01 F32M	0,032	0,038	0,055
		0.0013	0.0015	0.0022
K3	R335.14...-M01 F32M	0,032	0,038	0,055
		0.0013	0.0015	0.0022
K4	R335.14...-M01 F32M	0,032	0,038	0,055
		0.0013	0.0015	0.0022
K5	R335.14...-M01 F32M	0,030	0,034	0,048
		0.0012	0.0013	0.0019
K6	R335.14...-M01 F32M	0,032	0,038	0,055
		0.0013	0.0015	0.0022
K7	R335.14...-M01 F32M	0,030	0,034	0,048
		0.0012	0.0013	0.0019
N1	R335.14...-M01 F32M	0,046	0,055	0,075
		0.0018	0.0022	0.0030
N2	R335.14...-M01 F32M	0,046	0,055	0,075
		0.0018	0.0022	0.0030
N3	R335.14...-M01 F32M	0,046	0,055	0,075
		0.0018	0.0022	0.0030
N11	R335.14...-M01 F32M	0,046	0,055	0,075
		0.0018	0.0022	0.0030
S1	R335.14...-M01 F32M	0,020	0,025	0,034
		0.00080	0.00095	0.0013
S2	R335.14...-M01 F32M	0,020	0,025	0,034
		0.00080	0.00095	0.0013
S3	R335.14...-M01 F32M	0,018	0,022	0,030
		0.00070	0.00085	0.0012
S11	R335.14...-M01 F32M	0,026	0,030	0,042
		0.0010	0.0012	0.0017
S12	R335.14...-M01 F32M	0,026	0,030	0,042
		0.0010	0.0012	0.0017
S13	R335.14...-M01 F32M	0,020	0,025	0,034
		0.00080	0.00095	0.0013
H5	R335.14...-M01 F32M	0,020	0,024	0,032
		0.00075	0.00090	0.0013
H8	R335.14...-M01 F32M	0,011	0,014	0,019
		0.00044	0.00055	0.00075
H11	R335.14...-M01 F32M	0,020	0,024	0,032
		0.00075	0.00090	0.0013
H12	R335.14...-M01 F32M	0,011	0,014	0,019
		0.00044	0.00055	0.00075
H21	R335.14...-M01 F32M	0,011	0,014	0,019
		0.00044	0.00055	0.00075

SMG = Seco material group
 f_z = mm/tooth (in/tooth), v_c = m/min (sf/min), a_p/DC = %
 All cutting data are start values

Square shoulder and slot milling cutters
 Helical milling cutters
 Face milling cutters
 Disc milling cutters
 High feed milling cutters
 Copy milling cutters
 Plunge milling cutters
 Chamfer milling cutters
 Spot facing cutters
 Inserts

R335.14 – Grooving and Chamfering – Insert selection – mm/Inch

SMG		f _z					
		15%	10%	5%			
Square shoulder and slot milling cutters	P1	R335.14...-M02 F32M	0,060 0,0024	0,070 0,0028	0,095 0,0038		
	P2	R335.14...-M02 F32M	0,060 0,0024	0,070 0,0028	0,10 0,0040		
	Helical milling cutters	P3	R335.14...-M02 F32M	0,055 0,0022	0,065 0,0026	0,095 0,0038	
		P4	R335.14...-M02 F32M	0,055 0,0022	0,065 0,0026	0,090 0,0036	
		P5	R335.14...-M02 F32M	0,055 0,0022	0,065 0,0026	0,090 0,0036	
		P6	R335.14...-M02 F32M	0,055 0,0022	0,065 0,0026	0,090 0,0036	
		P7	R335.14...-M02 F32M	0,055 0,0022	0,065 0,0026	0,090 0,0036	
		P8	R335.14...-M02 F32M	0,055 0,0022	0,065 0,0026	0,095 0,0038	
	Face milling cutters	P11	R335.14...-M02 F32M	0,055 0,0022	0,065 0,0026	0,090 0,0036	
		P12	R335.14...-M02 F32M	0,032 0,0013	0,038 0,0015	0,055 0,0022	
		Disc milling cutters	M1	R335.14...-M02 F32M	0,060 0,0024	0,070 0,0028	0,10 0,0040
			M2	R335.14...-M02 F32M	0,055 0,0022	0,065 0,0026	0,090 0,0036
M3	R335.14...-M02 F32M		0,044 0,0017	0,050 0,0020	0,070 0,0028		
M4	R335.14...-M02 F32M		0,034 0,0014	0,042 0,0016	0,055 0,0022		
M5	R335.14...-M02 F32M		0,034 0,0014	0,042 0,0016	0,055 0,0022		
High feed milling cutters	K1	R335.14...-M02 F32M	0,060 0,0024	0,070 0,0028	0,10 0,0040		
	K2	R335.14...-M02 F32M	0,055 0,0022	0,065 0,0026	0,090 0,0036		
	K3	R335.14...-M02 F32M	0,055 0,0022	0,065 0,0026	0,090 0,0036		
	K4	R335.14...-M02 F32M	0,055 0,0022	0,065 0,0026	0,090 0,0036		
	K5	R335.14...-M02 F32M	0,048 0,0019	0,060 0,0024	0,080 0,0032		
	K6	R335.14...-M02 F32M	0,055 0,0022	0,065 0,0026	0,090 0,0036		
	K7	R335.14...-M02 F32M	0,048 0,0019	0,060 0,0024	0,080 0,0032		
Copy milling cutters	N1	R335.14...-M02 F32M	0,075 0,0030	0,090 0,0036	0,13 0,0050		
	N2	R335.14...-M02 F32M	0,075 0,0030	0,090 0,0036	0,13 0,0050		
	N3	R335.14...-M02 F32M	0,075 0,0030	0,090 0,0036	0,13 0,0050		
	N11	R335.14...-M02 F32M	0,075 0,0030	0,090 0,0036	0,13 0,0050		
Plunge milling cutters	S1	R335.14...-M02 F32M	0,034 0,0014	0,042 0,0016	0,055 0,0022		
	S2	R335.14...-M02 F32M	0,034 0,0014	0,042 0,0016	0,055 0,0022		
	S3	R335.14...-M02 F32M	0,030 0,0012	0,036 0,0014	0,048 0,0019		
	S11	R335.14...-M02 F32M	0,044 0,0017	0,050 0,0020	0,070 0,0028		
	S12	R335.14...-M02 F32M	0,044 0,0017	0,050 0,0020	0,070 0,0028		
	S13	R335.14...-M02 F32M	0,034 0,0014	0,042 0,0016	0,055 0,0022		
Chamfer milling cutters	H5	R335.14...-M02 F32M	0,032 0,0013	0,038 0,0015	0,055 0,0022		
	H8	R335.14...-M02 F32M	0,019 0,00075	0,022 0,00090	0,032 0,0012		
	H11	R335.14...-M02 F32M	0,032 0,0013	0,038 0,0015	0,055 0,0022		
	H12	R335.14...-M02 F32M	0,019 0,00075	0,022 0,00090	0,032 0,0012		
	H21	R335.14...-M02 F32M	0,019 0,00075	0,022 0,00090	0,032 0,0012		

SMG = Seco material group
 f_z = mm/tooth (in/tooth), v_c = m/min (sf/min), a_p/DC = %
 All cutting data are start values

R335.14 – Grooving and Chamfering – Insert selection – mm/Inch

SMG		f _z			
		20%	15%	10%	5%
P1	R335.14...-M03 F32M	0,065	0,070	0,085	0,12
		0,0026	0,0028	0,0034	0,0048
P2	R335.14...-M03 F32M	0,065	0,070	0,085	0,12
		0,0026	0,0028	0,0034	0,0048
P3	R335.14...-M03 F32M	0,060	0,070	0,080	0,11
		0,0024	0,0028	0,0032	0,0044
P4	R335.14...-M03 F32M	0,060	0,065	0,080	0,11
		0,0024	0,0026	0,0032	0,0044
P5	R335.14...-M03 F32M	0,060	0,065	0,080	0,11
		0,0024	0,0026	0,0032	0,0044
P6	R335.14...-M03 F32M	0,060	0,065	0,075	0,11
		0,0024	0,0026	0,0030	0,0044
P7	R335.14...-M03 F32M	0,060	0,065	0,075	0,11
		0,0024	0,0026	0,0030	0,0044
P8	R335.14...-M03 F32M	0,060	0,070	0,080	0,11
		0,0024	0,0028	0,0032	0,0044
P11	R335.14...-M03 F32M	0,060	0,065	0,075	0,11
		0,0024	0,0026	0,0030	0,0044
P12	R335.14...-M03 F32M	0,036	0,040	0,046	0,065
		0,0014	0,0016	0,0018	0,0026
M1	R335.14...-M03 F32M	0,065	0,070	0,085	0,12
		0,0026	0,0028	0,0034	0,0048
M2	R335.14...-M03 F32M	0,060	0,065	0,080	0,11
		0,0024	0,0026	0,0032	0,0044
M3	R335.14...-M03 F32M	0,046	0,050	0,065	0,085
		0,0018	0,0020	0,0026	0,0034
M4	R335.14...-M03 F32M	0,038	0,042	0,050	0,070
		0,0015	0,0016	0,0020	0,0028
M5	R335.14...-M03 F32M	0,038	0,042	0,050	0,070
		0,0015	0,0016	0,0020	0,0028
K1	R335.14...-M03 F32M	0,065	0,070	0,085	0,12
		0,0026	0,0028	0,0034	0,0048
K2	R335.14...-M03 F32M	0,060	0,065	0,080	0,11
		0,0024	0,0026	0,0032	0,0044
K3	R335.14...-M03 F32M	0,060	0,065	0,080	0,11
		0,0024	0,0026	0,0032	0,0044
K4	R335.14...-M03 F32M	0,060	0,065	0,080	0,11
		0,0024	0,0026	0,0032	0,0044
K5	R335.14...-M03 F32M	0,055	0,060	0,070	0,095
		0,0022	0,0024	0,0028	0,0038
K6	R335.14...-M03 F32M	0,060	0,065	0,080	0,11
		0,0024	0,0026	0,0032	0,0044
K7	R335.14...-M03 F32M	0,055	0,060	0,070	0,095
		0,0022	0,0024	0,0028	0,0038
N1	R335.14...-M03 F32M	0,080	0,090	0,11	0,15
		0,0032	0,0036	0,0044	0,0060
N2	R335.14...-M03 F32M	0,080	0,090	0,11	0,15
		0,0032	0,0036	0,0044	0,0060
N3	R335.14...-M03 F32M	0,080	0,090	0,11	0,15
		0,0032	0,0036	0,0044	0,0060
N11	R335.14...-M03 F32M	0,080	0,090	0,11	0,15
		0,0032	0,0036	0,0044	0,0060
S1	R335.14...-M03 F32M	0,038	0,042	0,050	0,070
		0,0015	0,0016	0,0020	0,0028
S2	R335.14...-M03 F32M	0,038	0,042	0,050	0,070
		0,0015	0,0016	0,0020	0,0028
S3	R335.14...-M03 F32M	0,032	0,036	0,042	0,060
		0,0013	0,0014	0,0017	0,0024
S11	R335.14...-M03 F32M	0,046	0,050	0,065	0,085
		0,0018	0,0020	0,0026	0,0034
S12	R335.14...-M03 F32M	0,046	0,050	0,065	0,085
		0,0018	0,0020	0,0026	0,0034
S13	R335.14...-M03 F32M	0,038	0,042	0,050	0,070
		0,0015	0,0016	0,0020	0,0028
H5	R335.14...-M03 F32M	0,036	0,040	0,046	0,065
		0,0014	0,0016	0,0018	0,0026
H8	R335.14...-M03 F32M	0,020	0,024	0,028	0,038
		0,00080	0,00090	0,0011	0,0015
H11	R335.14...-M03 F32M	0,036	0,040	0,046	0,065
		0,0014	0,0016	0,0018	0,0026
H12	R335.14...-M03 F32M	0,020	0,024	0,028	0,038
		0,00080	0,00090	0,0011	0,0015
H21	R335.14...-M03 F32M	0,020	0,024	0,028	0,038
		0,00080	0,00090	0,0011	0,0015

SMG = Seco material group
 f_z = mm/tooth (in/tooth), v_c = m/min (sf/min), a_p/DC = %
 All cutting data are start values

Square shoulder and slot milling cutters
 Helical milling cutters
 Face milling cutters
 Disc milling cutters
 High feed milling cutters
 Copy milling cutters
 Plunge milling cutters
 Chamfer milling cutters
 Spot facing cutters
 Inserts

R335.14 – Grooving and Chamfering – Cutting data $v_c = (m/min)/(sf/min)$

	335.14				
	20%	15%	10%	5%	
SMG					
Square shoulder and slot milling cutters	P1	230 750	240 790	255 840	275 900
	P2	225 740	235 770	245 800	265 870
Helical milling cutters	P3	195 640	200 660	215 710	230 750
	P4	170 560	180 590	190 620	205 670
Face milling cutters	P5	165 540	170 560	180 590	195 640
	P6	185 610	190 620	205 670	220 720
Disc milling cutters	P7	175 570	180 590	195 640	205 670
	P8	165 540	170 560	180 590	195 640
High feed milling cutters	P11	170 560	175 570	190 620	200 660
	P12	105 345	110 360	120 395	130 425
Copy milling cutters	M1	195 640	205 670	215 710	235 770
	M2	160 520	165 540	175 570	190 620
Plunge milling cutters	M3	125 410	135 445	140 460	150 490
	M4	100 330	100 330	110 360	115 375
Spot facing cutters	M5	80 260	85 280	90 295	95 310
	K1	225 740	235 770	250 820	270 890
Chamfer milling cutters	K2	200 660	205 670	220 720	235 770
	K3	165 540	175 570	185 610	200 660
Inserts	K4	160 520	165 540	175 570	190 620
	K5	95 310	100 330	105 345	115 375
Spot facing cutters	K6	140 460	145 475	155 510	170 560
	K7	125 410	130 425	135 445	150 490
Spot facing cutters	N1	1000 3275	1050 3450	1100 3600	1200 3925
	N2	325 1075	340 1125	355 1175	385 1275
Spot facing cutters	N3	215 710	225 740	235 770	260 850
	N11	290 950	300 980	315 1025	345 1125
Spot facing cutters	S1	29 95	31 100	32 105	35 115
	S2	24 80	25 80	26 85	28 90
Spot facing cutters	S3	21 70	22 70	23 75	25 80
	S11	41 135	43 140	45 150	49 160
Spot facing cutters	S12	38 125	40 130	42 140	45 150
	S13	22 70	23 75	24 80	26 85
Spot facing cutters	H5	55 180	55 180	60 195	65 215
	H8	60 195	60 195	65 215	70 230
Spot facing cutters	H11	70 230	75 245	80 260	85 280
	H12	70 230	70 230	75 245	80 260
Spot facing cutters	H21	60 195	60 195	65 215	70 230

335.14 – Threading – Cutting data $v_c = (m/min)/(sf/min)$

SMG	R335.14		v_c
	f_z		
P1	0,070		275
	0.0028		900
P2	0,070		270
	0.0028		890
P3	0,070		230
	0.0028		750
P4	0,065		205
	0.0026		670
P5	0,065		195
	0.0026		640
P6	0,065		215
	0.0026		710
P7	0,065		205
	0.0026		670
P8	0,070		195
	0.0028		640
P11	0,065		200
	0.0026		660
P12	0,044		120
	0.0017		395
	0,070		215
M1	0,065		175
	0.0026		570
M2	0,050		130
	0.0020		425
M3	0,046		100
	0.0018		330
M4	0,046		80
	0.0018		260
M5	0,070		210
	0.0028		690
K1	0,065		185
	0.0026		610
K2	0,065		180
	0.0026		590
K3	0,065		150
	0.0026		490
K4	0,060		90
	0.0024		295
K5	0,065		130
	0.0026		425
K6	0,060		115
	0.0024		375
K7	0,090		970
	0.0036		3175
N1	0,090		620
	0.0036		2025
N2	0,090		415
	0.0036		1350
N3	0,090		475
	0.0036		1550
N11	0,046		50
	0.0018		165
S1	0,046		41
	0.0018		135
S2	0,042		35
	0.0017		115
S3	0,050		65
	0.0020		215
S11	0,050		50
	0.0020		165
S12	0,046		39
	0.0018		130
S13	0,044		43
	0.0017		140
H5	0,034		45
	0.0013		150
H8	0,044		60
	0.0017		195
H11	0,034		55
	0.0013		180
H12	0,034		45
	0.0013		150
H21	0,034		45
	0.0013		150

Square shoulder and slot milling cutters
Helical milling cutters
Face milling cutters
Disc milling cutters
High feed milling cutters
Copy milling cutters
Plunge milling cutters
Chamfer milling cutters
Spot facing cutters
Inserts

Technical information – Threading

Recommendation for circular interpolation

To avoid vibration and insert damage when working with internal circular interpolation, we recommend a progressive entrance into the material. The circular arc angle for the progressive immersion should be between 45° and 180°

When calculating cutting datas for circular interpolation please be aware of the real radial depth of cut and the feed speed related to the centre of the cutter- See page 885 for more info



Milling insert with 6 cutting edges



If vibrations appear when working with milling insert with 6 cutting edges please reduce the radial depth of cut to reduce the number of teeth into contact with the material , an alternative is to choose an insert with 3 cutting edges instead.

Holder recommendation

For best result in terms of stability, precision and reliability, it is recommended to use the following SECO-Tooling holders

- High precision collet chucks ERHP 5672
- Shrink fit Holder SFD 5603, SFR 5600 and SFS 5801
- ER Collet chuck ER 5675
- Power Milling Chuck, PMC

Please see SECO Tooling System catalogue for more information.



- Square shoulder and slot milling cutters
- Helical milling cutters
- Face milling cutters
- Disc milling cutters
- High feed milling cutters
- Copy milling cutters
- Plunge milling cutters
- Chamfer milling cutters
- Spot facing cutters
- Inserts

Technical information – Threading

Pitch (as of/up to)

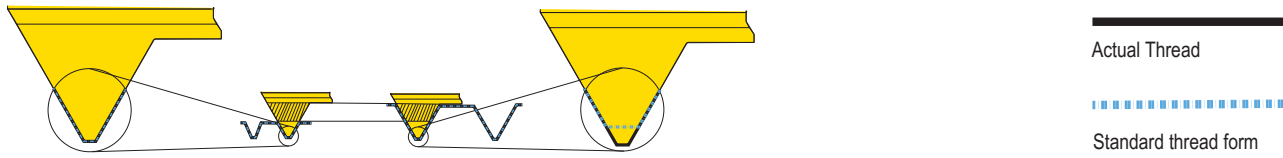

Thread milling by circular interpolation can cause thread profile violation when using insert for partial thread. Keep this in mind during the process of selecting tool. The tool diameter need to be small enough compare to the hole diameter. The pitch also needs to be considered.

Insert with partial profile for Metric ISO-Threads are multi tools. That means that each insert could machine different pitches. The insert is designed to meet the minimum pitch size (TPN); Machining this pitch will result in a standard conform thread form.

The given maximum pitch size (TPX) can be machined also with this insert at the expense of standard conformity: The result will be a slightly deeper thread than the standard. The deeper thread is normally accepted, but the application and use needs to be evaluated.

Following table is a recommendation over maximum tool diameter in relation to the thread size and pitch:

ISO-Thread, partial profile											
Pitch	M12	M16	M20	M24	M27	M30	M36	M42	M48	M56	M60
1	10	14	18	22	25	28	34	40	45	53	57
1,5	8	12	16	20	24	26	32	37	43	51	55
2	7	10	14	18	22	24	30	35	40	48	52
2,5	6	8	12	16	20	22	28	32	37	45	48
3		6	10	14	18	20	26	30	36	43	47
3,5				12	16	18	24	29	35	42	46
4							22	27	32	39	43
4,5								24	30	37	40
5								22	27	34	37
5,5								20	25	31	35
6								19	23	29	32

Code key - Fixed pocket cutters - Metric

Arbor or arbor hole type

R	335	25	080	15	22	4	NA
1	2	3	4	5	6	7	8

1.	2.	3.
For stub arbor mounting /right hand rotation	Disc milling cutters	System
4.	5.	6.
Cutter diameter	Cutter width	Dimension of arbor bore
7.	8.	
4 = ZEFP value	N=Three side cutting A = Through coolant supply	

Cylindrical or Combimaster type

R	335	18	16	50	RE	10	3	NA
1	2	3	4	5	6	7	8	9

1.	2.	3.
Right hand rotation	Disc milling cutter	System
4.	5.	6.
-DMM value for Cyl. version -M value (thread) for Combimaster version	Cutter diameter	-RE for Combimaster -.0 for Cyl. shanks
7.	8.	
3=ZEFP Value	N=Three side cutting A = Through coolant supply	

Code key - Adjustable cutters - Metric

For adjustable disc milling cutters

R	335	18	-	200	-	12	15	XL	-	40	-	8N	-	R6
1	2	3		4		5	6	7		8		9		10

1.	2.	3.
For stub arbor mounting/ right hand rotation	Disc milling cutters	System
4.	5.	6.
Cutter diameter	Minimum cutter width (adjustable cassettes)	Maximum cutter width (adjustable cassettes)
7.	8.	9.
Enlarged chip space	Dimension of arbor bore	8=ZFP value N=Three side cutting R=Right hand version for two side cutting L=Left hand version for two side cutting
10.		
Insert radius if round inserts used		

Square shoulder and
slot milling cutters

Helical milling cutters

Face milling cutters

Disc milling cutters

High feed milling
cutters

Copy milling cutters

Plunge milling cutters

Chamfer milling cutters

Spot facing cutters

Inserts

Code key - Fixed pocket cutters - Inch

Arbor or arbor hole type

R	335	18	03.00	0.37F	4N
1	2	3	4	5	6

1.	2.	3.
For stub arbor mounting /right hand rotation	Disc milling cutters	System
4.	5.	6.
Cutter diameter	Cutter width (0.37 = 0.375 inch) F = fixed width, manufacturer's option	4 = ZEFP value N = Three side cutting A = Through coolant supply

Cylindrical or Combimaster type

R	335	18	02.00	RE	3NA
1	2	3	4	5	6

1.	2.	3.
Right hand rotation	Disc milling cutter	System
4.	5.	6.
Cutter diameter	.RE = Combimaster, connection size .0 = for Cylindrical shanks	3 = ZEFP value N=Three side cutting A = Through coolant supply

Code key - Adjustable cutters - inch

For adjustable disc milling cutters

R	335	18	08.00	XL0809N	R6
1	2	3	4	5	6

1.	2.	3.
For stub arbor mounting/ right hand rotation	Disc milling cutters	System
4.	5.	6.
Cutter diameter	08 Cutter body width min (16ths of an inch) 09 Cutter body width max (16ths of an inch) XL: For enlarged chip space, manufacturer's option N = Three side cutting R = Right-hand version, two side cutting L = Left-hand version, two side cutting	R6 Insert radius in mm if round inserts used

Square shoulder and
slot milling cutters

Helical milling cutters

Face milling cutters

Disc milling cutters

High feed milling
cutters

Copy milling cutters

Plunge milling cutters

Chamfer milling cutters

Spot facing cutters

Inserts

Selection – Metric

Full side and face - fixed pocket design

System	Insert	Application	Diameters (mm) available and max depth of cut (mm)												Max no. of cutting edges	Radii available (mm)	See page				
			24	32	40	50	63	80	100	125	160	200	250	315							
335.15	335.15 	1,1 - 2,65 3,15 - 5,15 	3	3			3										2	-	378		
							5														
335.10	150.10 	2,25/2,5 3,1 4,1 			12	15	15	24	30	34	39						1	R0,15/R0,3	383		
					12	15	15	24	30	43	39	59	84	117							
							16	22	29	34	39	59	84	117							
335.19	SNHQ / 335.19 	4 5 6 7/8 10 12 			11	14	17	26	32	45	42						4	R0,2/R0,4/R0,8/R1,2/ R1,6/R2,0/R2,4/R3,0/ R3,1/R3,5/R4,0/ R5,0/R6,0	395		
					11	14	17	26	32	45	43										
						14	17	26	32	31	43	61	86								
							17	26	26	32	44	62	87								
											27	33	46	63	88						
											27	29	45	64	89						
335.18 LNK	LNKT 	8 10 12 14 17 20 		9	12	15	15	23	27	34							4	R0,4/R0,8/R1,6/R2,0/ R2,4/R3,1/R4,0	411		
				9	12	15	15	24	28	34											
						15	15	24	28	34											
							15	23	26	34	51										
								24	26	33	50										
335.25	XNHQ 	15 20 25 						22	25	32	52	64					4	R0,4/R0,8/R1,2/ R1,6/R2,0/R2,4/R3,1/ R4,0/R5,0/R6,0	436		
									25	32	51	64	88								
										33	50	62	87								

Full radius profile – fixed pocket design

System	Insert	Application	Diameters (mm) available and max depth of cut (mm)												Max no. of cutting edges	Radii available (mm)	See page			
			25	32	40	50	63	80	100	125	160	200	250	315						
335.19	SNHQ / 335.19 	4 6 7/8 10 12 			11	14	17	26	32	45	42						4	R2,0/R3,0/R3,5/ R4,0/R5,0/R6,0	395	
						14	17	26	32	31	43	61	86							
							17	26	32	32	44	62	87							
										27	33	46	63	88						
										27	29	45	64	89						
335.29	Round insert 	5 6 7 8 10 12 		6	8	10	12										4	R2,5/R3,0/R3,5/ R4,0/R5,0/R6,0	458	
				6	8	10	12	15												
					8	10	12	15												
					8	10	12	15	20											
							12	15	20											
		Full radius				12	15	20												

Basic choice (X indicates the maximum radial depth of cut "CDX" in slotting in mm)

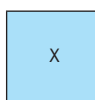

Alternative choice (X indicates the maximum radial depth of cut "CDX" in slotting in mm)

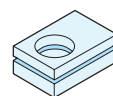
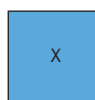

Circlop groove and shallow slotting

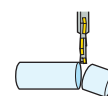

Sawing

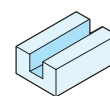

Full side and face

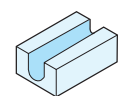

Full radius profile

Selection – Metric

Full side and and face - adjustable in width

System	Insert	Application	Diameters (mm) available and max depth of cut (mm)								Max no. of cutting edges	Radii available (mm)	See page
			80	100	125	160	200	250	315				
335.18 LNK	LNK	8 - 10		14	27	32	50	63	88	121	4	R0,4/R0,8/R1,6/R2,0/R2,4/R3,1/R4,0	411
		10 - 12		14	27	32	50	63	88	121			
		12 - 15		14	27	32	50	63	88	121			
335.25	XNHQ	13.5 - 17			24	32	50	63	88	121	4	R0,4/R0,8/R1,2/R1,6/R2,0/R2,4/R3,1/R4,0/R5,0/R6,0	436
		17 - 21			24	32	50	63	88	121			
		21 - 26				32	50	63	88	113			
335.18/335.25	Round insert	8 - 10	Full radius	15	28	33	51	63	88	121	4	R4,0	411-436
		10 - 12		15	28	33	51	63	88	121		R5,0	
		12 - 15		15	28	33	51	63	88	121		R6,0	
		16 - 17			28	36	54	67	92	124		R8,0	
		20 - 21							92	124		R10,0	

Half side and face

System	Insert	Application	Diameters (mm) available and max depth of cut (mm)								Max no. of cutting edges	Radii available (mm)	See page
			80	100	125	160	200	250	315				
335.18 LNK	LNK	≤5		14	27	32	50	63	88	121	2+2	R0,4/R0,8/R1,6/R2,0/R2,4/R3,1/R4,0	411
		≤6		14	27	32	50	63	88	121			
		≤7,5		14	27	32	50	63	88	121			
335.25	XNHQ	≤8,5			24	32	50	63	88	121	2+2	R0,4/R0,8/R1,2/R1,6/R2,0/R2,4/R3,1/R4,0/R5,0/R6,0	436
		≤11			24	32	50	63	88	121			
		≤13				32	50	63	88	113			
335.18/335.25	Round insert	≤4	Full radius	15	28	33	51	63	88	121	4	R4,0	411-436
		≤5		15	28	33	51	63	88	121		R5,0	
		≤6		15	28	33	51	63	88	121		R6,0	
		≤8			28	36	54	67	92	124		R8,0	
		≤10							92	124		R10,0	

Basic choice (X indicates the maximum radial depth of cut "CDX" in slotting in mm)



Alternative choice (X indicates the maximum radial depth of cut "CDX" in slotting in mm)

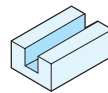

Full side and face

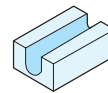

Full radius profile

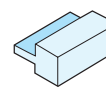

Half side and face

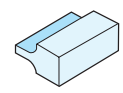

Half radius profile

Square shoulder and slot milling cutters
Helical milling cutters
Face milling cutters
Disc milling cutters
High feed milling cutters
Copy milling cutters
Plunge milling cutters
Chamfer milling cutters
Spot facing cutters
Inserts

Selection – Inch

Full side and face - fixed pocket design

System	Insert	Application	Diameters (inch) available and max depth of cut (inch)											Max no. of cutting edges	Radii available (inch)	See page	
			1.00	1.25	1.50	2.00	2.50	3.00	4.00	5.00	6.00	8.00	10.00				
335.15	335.15 	.124-.203 					0.22								2	-	378
335.10	150.10 	.089-.098 			0.47	0.62	0.63	0.73	1.06	1.36	1.41				1	.006 .012	383
					0.47	0.62	0.63	0.73	1.06	1.36	1.41						
335.19	SNHQ / 335.19 				0.45	0.6	0.7	0.95	1.32						4	.008 / .016 .031 / .047 .063 / .079 .094 / .118 .122 / .138 .157 / .197 .236	395
					0.45	0.6	0.7	0.95	1.32	1.41	1.91						
						0.6	0.7	0.95	1.32	1.45	1.95	2.51					
							0.56	0.81	1.07	1.45	1.95						
							0.56	0.81	1.11	1.49	2.02						
335.18 LNK	LNKT 			0.35	0.41	0.59	0.63	0.71	1.06	1.38					4	.016 / .031 .063 / .079 .094 / .122 .157	411
				0.35	0.41	0.59	0.63	0.71	1.06	1.38							
						0.59	0.62	0.87	1.14	1.38	1.81						
								0.71	1.06								
								0.71	1.06	1.38							
335.25	XNHQ 	0.750 								1.33	1.83	2.48		4	.031 / .047 .063 / .079 .094 / .122 .157 / .197 .236	436	
											1.35	1.85	2.43				3.43

Full radius profile – fixed pocket design

System	Insert	Application	Diameters (inch) available and max depth of cut (inch)											Max no. of cutting edges	Radii available (inch)	See page	
			1.00	1.25	1.50	2.00	2.50	3.00	4.00	5.00	6.00	8.00	10.00				
335.29	Round insert 	0.236 			0.30	0.41									4	0.118 0.157 0.197	458
						0.41	0.60										
							0.59	0.70									

Basic choice (X indicates the maximum radial depth of cut "CDX" in slotting in mm)

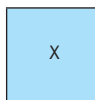

Alternative choice (X indicates the maximum radial depth of cut "CDX" in slotting in mm)

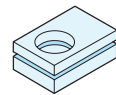
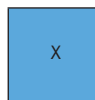

Circclip groove and shallow slotting

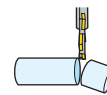

Sawing

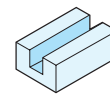

Full side and face

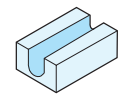

Full radius profile

Selection – Inch

Full side and and face - adjustable in width

System	Insert	Application	Diameters (inch) available and max depth of cut (inch)						Max no. of cutting edges	Radii available (inch)	See page
			4.00	5.00	6.00	8.00	10.00	12.00			
335.18 LNK	LNK	.315 - .394	1.1	1.34	1.77	2.42	3.39	4.39	4	.0157 / .031 .063 / .079 .094 / .122 .157	411
		.394 - .472	1.01	1.33	1.77	2.42	3.39	4.39			
		.472 - .591	1.01	1.33	1.77	2.42	3.39	4.39			
335.25	XNHQ	.53 - .67	1.01	1.33	1.80	2.42	3.42	4.46	4	.016 / .031 .063 / .079 .094 / .122 .157 / .197	436
		.67 - .83	1.01	1.33	1.80	2.42	3.42	4.46			
		.83 - 1.02		1.33	1.79	2.41	3.41	4.41			
		1.02 - 1.26			1.79	2.41	3.41	4.41			
335.18	Round insert	.315 - .394	1.14	1.38	1.77	2.42	3.39	4.39	4	.157/.197 .236/.315 .393	411
		.394 - .472	1.06	1.38	1.81	2.42	3.39	4.39			
		.472 - .591	1.05	1.37	1.83	2.42	3.39	4.39			
		.630 - .669		1.41	1.91	2.54	3.54	4.58			
		.789 - .827					3.54	4.54			

Half side and face

System	Insert	Application	Diameters (inch) available and max depth of cut (inch)						Max no. of cutting edges	Radii available (inch)	See page
			4.00	5.00	6.00	8.00	10.00	12.00			
335.18 LNK	LNK	≤0.197	1.10	1.34	1.77	2.42	3.39	4.39	2+2	.016 / .031 .063 / .079 .094 / .122 .157	411
		≤0.236	1.01	1.33	1.77	2.42	3.39	4.39			
		≤0.295	1.01	1.33	1.79	2.42	3.39	4.39			
335.25	XNHQ	≤0.354	1.01	1.33	1.80	2.42	3.42	4.46	2+2	.016 / .031 .063 / .079 .094 / .122 .157 / .197	436
		≤0.437	1.01	1.33	1.80	2.42	3.42	4.46			
		≤0.512		1.33	1.79	2.41	3.41	4.41			
		≤0.630			1.79	2.41	3.41	4.41			
335.18	Round insert	≤0.157	1.14	1.38	1.77	2.42	3.39	4.39	4	.157 .157 .197 .315 .315	411
		≤0.197	1.06	1.38	1.81	2.42	3.39	4.39			
		≤0.236	1.05	1.37	1.83	2.42	3.39	4.39			
		≤0.315		1.41	1.91	2.54	3.54	4.58			
		≤0.393					3.54	4.54			

Basic choice (X indicates the maximum radial depth of cut "CDX" in slotting in mm)



Alternative choice (X indicates the maximum radial depth of cut "CDX" in slotting in mm)

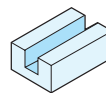

Full side and face

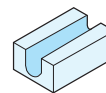

Full radius profile

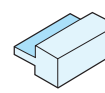

Half side and face

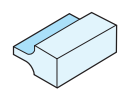

Half radius profile

Square shoulder and slot milling cutters

Helical milling cutters

Face milling cutters

Disc milling cutters

High feed milling cutters

Copy milling cutters

Plunge milling cutters

Chamfer milling cutters

Spot facing cutters

Inserts

Square shoulder and
slot milling cutters

Helical milling cutters

Face milling cutters

Disc milling cutters

High feed milling
cutters

Copy milling cutters

Plunge milling cutters

Chamfer milling cutters

Spot facing cutters

Inserts



335.15

Disc Milling cutter system designed to generate circle snap-ring grooves and shallow slotting grooves

- Width of cut 1.1-5.15 mm (.043 - .202 inch)
- Cutter range diameter 24-63 mm (1 - 2.5 inch)
- Available with Weldon, Arbor and Combimaster with through coolant connection
- Economical light cutting insert with 2 cutting edges design
- Insert width precision +0/+0.05mm - +0/+0.002"

R335.15 – Metric

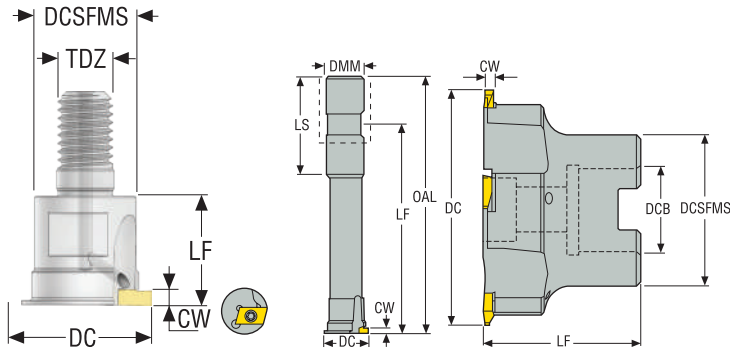

- For insert selection and cutting data recommendations, see page(s) 381 - 382
- For complete insert programme, see page(s) 883
- For ISO attribute explanation, see page 16

Designation	Item number	Type of mounting	DC	CWN	CWX	ZEFP	DCB	DCSFMS	DMM	LS	LF	OAL	TDZ	RPMX	Weight	Insert
			mm	mm	mm		mm	mm	mm	mm	mm	mm			kg	
R335.15-20024.3-03-1	75002642	Weldon	24,0	1,1	2,65	1	-	-	20,0	50,0	105,05	130,0	-	28200	0,3	R335.15-13..
R335.15-1024.RE-03.1A	03329402	Combimaster	24,0	1,1	2,65	1	-	18,5	-	-	20,0	-	M10	28200	0,5	R335.15-13..
R335.15-25034.3-03-2	75002643	Weldon	34,0	1,1	2,65	2	-	-	25,0	56,0	98,05	130,0	-	23600	0,5	R335.15-13..
R335.15-1234.RE-03.2A	03329403	Combimaster	34,0	1,1	2,65	2	-	23,0	-	-	30,0	-	M12	23600	0,2	R335.15-13..
R335.15-063-03.22-5	75011752	Arbor	63,0	1,1	2,65	5	22,0	40,0	-	-	40,0	-	-	17300	0,5	R335.15-13..
R335.15-063-05.22-5	75011753	Arbor	63,0	3,15	5,15	5	22,0	40,0	-	-	40,0	-	-	17300	0,4	R335.15-18..

CW depends on the insert width

For groove depth (CDX), please see insert pages 883

Spare Parts, included in delivery

Accessories

For cutter	Arbor screw	Insert key	Insert screw	Insert clamping torque	Torque key
R335.15 DC = 24/34	-	H4B-T15P	C03509-T15P	3.0NM	T00-15P30
R335.15 DC = 63	220.17-692	H4B-T15P	C03509-T15P	3.0NM	T00-15P30

Torque and fixed keys, see page 894

Square shoulder and slot milling cutters

Helical milling cutters

Face milling cutters

Disc milling cutters

High feed milling cutters

Copy milling cutters

Plunge milling cutters

Chamfer milling cutters

Spot facing cutters

Inserts

R335.15 – inch

Width 0.043 - 0.202 inch

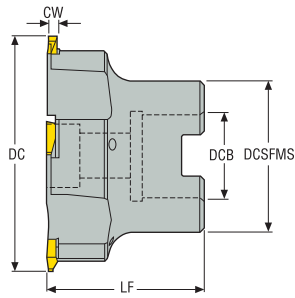

- For insert selection and cutting data recommendations, see page(s) 381 - 382
- For complete insert programme, see page(s) 883
- For ISO attribute explanation, see page 16

Designation	Item number	Type of mounting	DC	CWN	CWX	ZEFP	DCB	DCSFMS	LF	RPMX	Weight	Insert
			inch	inch	inch		inch	inch	inch		lbs	
R335.15-02.50-18	75072222	Arbor	2.500	0.124	0.203	5	0.750	1.571	1.571	17300	1.100	R335.15-18...

CW depends on the insert width

For groove depth (CDX), please see insert pages 883

Spare Parts, included in delivery

Accessories

For cutter	Arbor screw	Insert key	Insert screw	Insert clamping torque	Torque key
R335.15-02.50-..	UC6S3/8UNFX1-1/4	H4B-T15P	C03509-T15P	3.0NM	T00-15P30

Torque and fixed keys, see page 894

Square shoulder and slot milling cutters
Helical milling cutters
Face milling cutters
Disc milling cutters
High feed milling cutters
Copy milling cutters
Plunge milling cutters
Chamfer milling cutters
Spot facing cutters
Inserts

R335.15– Insert selection – mm/Inch

SMG			f _z		
			10%	5%	2%
P1	R335.15-13..FG-E08 F40M	R335.15-18..FG-M12 F40M	0,19 0.0075	0,26 0.010	0,42 0.017
P2	R335.15-13..FG-E08 F40M	R335.15-18..FG-M12 F40M	0,19 0.0075	0,26 0.010	0,42 0.017
P3	R335.15-13..FG-E08 F40M	R335.15-18..FG-M12 F40M	0,18 0.0070	0,25 0.010	0,40 0.016
P4	R335.15-13..FG-E08 F40M	R335.15-18..FG-M12 F40M	0,18 0.0070	0,25 0.010	0,40 0.016
P5	R335.15-13..FG-E08 F40M	R335.15-18..FG-M12 F40M	0,17 0.0065	0,24 0.0095	0,38 0.015
P6	R335.15-13..FG-E08 F40M	R335.15-18..FG-M12 F40M	0,17 0.0065	0,24 0.0095	0,38 0.015
P7	R335.15-13..FG-E08 F40M	R335.15-18..FG-M12 F40M	0,17 0.0065	0,24 0.0095	0,38 0.015
P8	R335.15-13..FG-E08 F40M	R335.15-18..FG-M12 F40M	0,18 0.0070	0,25 0.010	0,40 0.016
P11	R335.15-13..FG-E08 F40M	R335.15-18..FG-M12 F40M	0,17 0.0065	0,24 0.0095	0,38 0.015
P12	R335.15-13..FG-E08 F40M	R335.15-18..FG-M12 F40M	0,12 0.0048	0,16 0.0065	0,26 0.010
M1	R335.15-13..FG-E08 F40M	R335.15-18..FG-M12 F40M	0,19 0.0075	0,26 0.010	0,42 0.017
M2	R335.15-13..FG-E08 F40M	R335.15-18..FG-M12 F40M	0,17 0.0065	0,24 0.0095	0,38 0.015
M3	R335.15-13..FG-E08 F40M	R335.15-18..FG-M12 F40M	0,14 0.0055	0,19 0.0075	0,30 0.012
M4	R335.15-13..FG-E08 F40M	R335.15-18..FG-M12 F40M	0,12 0.0048	0,17 0.0065	0,26 0.010
M5	R335.15-13..FG-E08 F40M	R335.15-18..FG-M12 F40M	0,12 0.0048	0,17 0.0065	0,26 0.010
K1	R335.15-13..FG-E08 F40M	R335.15-18..FG-M12 F40M	0,19 0.0075	0,26 0.010	0,42 0.017
K2	R335.15-13..FG-E08 F40M	R335.15-18..FG-M12 F40M	0,17 0.0065	0,24 0.0095	0,38 0.015
K3	R335.15-13..FG-E08 F40M	R335.15-18..FG-M12 F40M	0,17 0.0065	0,24 0.0095	0,38 0.015
K4	R335.15-13..FG-E08 F40M	R335.15-18..FG-M12 F40M	0,17 0.0065	0,24 0.0095	0,38 0.015
K5	R335.15-13..FG-E08 F40M	R335.15-18..FG-M12 F40M	0,16 0.0065	0,22 0.0085	0,34 0.013
K6	R335.15-13..FG-E08 F40M	R335.15-18..FG-M12 F40M	0,17 0.0065	0,24 0.0095	0,38 0.015
K7	R335.15-13..FG-E08 F40M	R335.15-18..FG-M12 F40M	0,16 0.0065	0,22 0.0085	0,34 0.013
N1	R335.15-13..FG-E08 F40M	R335.15-18..FG-M12 F40M	0,24 0.0095	0,34 0.013	0,55 0.022
N2	R335.15-13..FG-E08 F40M	R335.15-18..FG-M12 F40M	0,24 0.0095	0,34 0.013	0,55 0.022
N3	R335.15-13..FG-E08 F40M	R335.15-18..FG-M12 F40M	0,24 0.0095	0,34 0.013	0,55 0.022
N11	R335.15-13..FG-E08 F40M	R335.15-18..FG-M12 F40M	0,24 0.0095	0,34 0.013	0,55 0.022
S1	R335.15-13..FG-E08 F40M	R335.15-18..FG-M12 F40M	0,12 0.0048	0,17 0.0065	0,26 0.010
S2	R335.15-13..FG-E08 F40M	R335.15-18..FG-M12 F40M	0,12 0.0048	0,17 0.0065	0,26 0.010
S3	R335.15-13..FG-E08 F40M	R335.15-18..FG-M12 F40M	0,11 0.0044	0,16 0.0065	0,25 0.010
S11	R335.15-13..FG-E08 F40M	R335.15-18..FG-M12 F40M	0,14 0.0055	0,19 0.0075	0,30 0.012
S12	R335.15-13..FG-E08 F40M	R335.15-18..FG-M12 F40M	0,14 0.0055	0,19 0.0075	0,30 0.012
S13	R335.15-13..FG-E08 F40M	R335.15-18..FG-M12 F40M	0,12 0.0048	0,17 0.0065	0,26 0.010
H5	R335.15-13..FG-E08 F40M	R335.15-18..FG-M12 F40M	0,12 0.0048	0,16 0.0065	0,26 0.010
H8	R335.15-13..FG-E08 F40M	R335.15-18..FG-M12 F40M	0,090 0.0036	0,12 0.0048	0,20 0.0080
H11	R335.15-13..FG-E08 F40M	R335.15-18..FG-M12 F40M	0,12 0.0048	0,16 0.0065	0,26 0.010
H12	R335.15-13..FG-E08 F40M	R335.15-18..FG-M12 F40M	0,090 0.0036	0,12 0.0048	0,20 0.0080
H21	R335.15-13..FG-E08 F40M	R335.15-18..FG-M12 F40M	0,090 0.0036	0,12 0.0048	0,20 0.0080

SMG = Seco material group
 f_z = mm/tooth (in/tooth), v_c = m/min (sf/min), a_p/DC = %
 All cutting data are start values

Square shoulder and slot milling cutters
 Helical milling cutters
 Face milling cutters
 Disc milling cutters
 High feed milling cutters
 Copy milling cutters
 Plunge milling cutters
 Chamfer milling cutters
 Spot facing cutters
 Inserts

R335.15 – Cutting data $v_c = (m/min)/(sf/min)$

	F40M		
	SMG		
		10%	5%
			2%
Square shoulder and slot milling cutters	P1	260	285
		850	940
Helical milling cutters	P2	255	275
		840	900
Face milling cutters	P3	220	240
		720	790
Disc milling cutters	P4	195	210
		640	690
High feed milling cutters	P5	190	205
		620	670
Copy milling cutters	P6	210	230
		690	750
Plunge milling cutters	P7	200	215
		660	710
Chamfer milling cutters	P8	185	200
		610	660
Spot facing cutters	P11	195	210
		640	690
Inserts	P12	125	135
		410	445
Square shoulder and slot milling cutters	M1	205	225
		670	740
Helical milling cutters	M2	170	185
		560	610
Face milling cutters	M3	135	150
		445	490
Disc milling cutters	M4	105	115
		345	375
High feed milling cutters	M5	90	95
		295	310
Copy milling cutters	K1	200	220
		660	720
Plunge milling cutters	K2	180	195
		590	640
Chamfer milling cutters	K3	150	165
		490	540
Spot facing cutters	K4	145	155
		475	510
Inserts	K5	90	95
		295	310
Square shoulder and slot milling cutters	K6	130	140
		425	460
Helical milling cutters	K7	110	120
		360	395
Face milling cutters	N1	1500	1625
		4925	5325
Disc milling cutters	N2	600	650
		1975	2125
High feed milling cutters	N3	405	435
		1325	1425
Copy milling cutters	N11	460	495
		1500	1625
Plunge milling cutters	S1	49	55
		160	180
Chamfer milling cutters	S2	40	43
		130	140
Spot facing cutters	S3	35	37
		115	120
Inserts	S11	70	75
		230	245
Square shoulder and slot milling cutters	S12	60	65
		195	215
Helical milling cutters	S13	34	36
		110	120
Face milling cutters	H5	41	45
		135	150
Disc milling cutters	H8	44	48
		145	155
High feed milling cutters	H11	55	60
		180	195
Copy milling cutters	H12	50	55
		165	180
Plunge milling cutters	H21	44	48
		145	155



335.10

Easy to use and reliable disc milling cutter system dedicated for slim slotting and cut-off operations.

- Self-clamping carbide insert design, the insert is retained by the spring action of the steel part of the cutter
- Width of cut 2.25-4.1 mm (.088 - .161 inch)
- Cutter range diameter 40-315 mm (1.5 - 6.0 inch)
- Available with Weldon, Combimaster, Arbor and Arbor hole connection
- Large cutter diameter with HSS cutter body material for high rigidity and reliability
- Small cutter diameter with internal coolant and close pitch design for high productivity
- Insert width precision from +/- 0.05 to 0.08mm - +/-0.002 to 0.003"

Cutter 335.10 - Insert 150.10 – Metric

Width 2,25/2,5/3,1 mm – full side – close pitch design with internal coolant

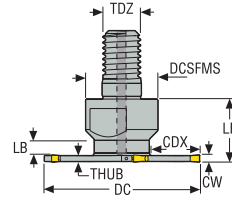

- For insert selection and cutting data recommendations, see page(s) 393-394
- For complete insert programme, see page(s) 877
- For ISO attribute explanation, see page 16

Designation	Item number	Type of mounting	DC	CWN	CWX	CDX	ZEFP	TDZ	DCSFMS	THUB	LF	LB	Through coolant	RPMX	Weight	Insert 150.10
			mm	mm	mm	mm			mm	mm	mm	mm			kg	
R335.10-1040.RE-02-4A	02926773	Combimaster	40,0	2,25	2,5	12,7	4	M10	18,5	1,9	20,0	5,3	✓	3970	0,2	-2.25N/2.5N
R335.10-1250.RE-02-5A	02926774	Combimaster	50,0	2,25	2,5	15,4	5	M12	23,0	1,9	20,0	-	✓	3180	0,1	-2.25N/2.5N
R335.10-1663.RE-02-7A	03054405	Combimaster	63,0	2,25	2,5	15,7	7	M16	30,0	1,9	23,0	-	✓	2520	0,2	-2.25N/2.5N
R335.10-1680.RE-02-9A	03054406	Combimaster	80,0	2,25	2,5	24,1	9	M16	30,0	1,9	23,0	-	✓	1980	0,2	-2.25N/2.5N
R335.10-20100.RE-02-11A	03054407	Combimaster	100,0	2,25	2,5	30,4	11	M20	36,5	1,9	25,0	-	✓	1580	0,4	-2.25N/2.5N
R335.10-1040.RE-03-4A	02926776	Combimaster	40,0	3,1	3,1	12,9	4	M10	18,5	2,4	20,0	4,3	✓	3970	0,1	-3N
R335.10-1250.RE-03-5A	02926777	Combimaster	50,0	3,1	3,1	15,6	5	M12	23,0	2,4	20,0	4,3	✓	3180	0,1	-3N
R335.10-1663.RE-03-7A	03054398	Combimaster	63,0	3,1	3,1	15,9	7	M16	30,0	2,4	23,0	0,0	✓	2520	0,2	-3N
R335.10-1680.RE-03-9A	03054399	Combimaster	80,0	3,1	3,1	24,3	9	M16	30,0	2,4	23,0	0,0	✓	1980	0,2	-3N
R335.10-20100.RE-03-11A	03054400	Combimaster	100,0	3,1	3,1	30,6	11	M20	36,5	2,4	25,0	0,0	✓	1580	0,4	-3N
R335.10-20125.RE-03-13A	03279546	Combimaster	125,0	3,1	3,1	43,1	13	M20	36,5	2,4	25,0	0,0	✓	1270	0,7	-3N

Spare Parts, included in delivery

For cutter	Insert key
R335.10-..	335.10-155
R335.10-Ø125	150.10-150

Torque and fixed keys, see page 894

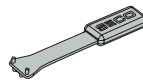

Square shoulder and slot milling cutters
Helical milling cutters
Face milling cutters
Disc milling cutters
High feed milling cutters
Copy milling cutters
Plunge milling cutters
Chamfer milling cutters
Spot facing cutters
Inserts

Width 0.089/0.098/0.122 inch – full side – close pitch design with internal coolant

Cutter 335.10 - Insert 150.10 – Inch

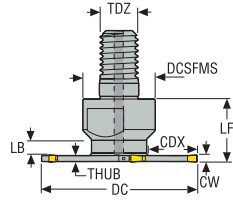

- For insert selection and cutting data recommendations, see page(s) 393-394
- For complete insert programme, see page(s) 877
- For ISO attribute explanation, see page 16

Designation	Item number	Type of mounting	DC	CWN	CWX	CDX	ZEFP	TDZ	DCSFMS	THUB	LF	LB	Through coolant	RPMX	Weight	Insert 150.10
			inch	inch	inch	inch			inch	inch	inch	inch			lbs	
R335.10-02.00-12RE-02-5A	03054409	Combimaster	2.000	0.089	0.098	0.622	5	M12	0.906	0.075	0.787	-	✓	3180	0.660	-2.25N/2.5N
R335.10-02.50-16RE-02-7A	03054410	Combimaster	2.500	0.089	0.098	0.626	7	M16	1.181	0.075	0.906	-	✓	2520	0.660	-2.25N/2.5N
R335.10-02.00-12RE-03-5A	03054402	Combimaster	2.000	0.122	0.122	0.630	5	M12	0.906	0.094	0.787	0.169	✓	3180	0.220	-3N

Spare Parts, included in delivery

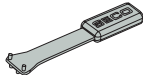
For cutter	Insert key
	
	335.10-155

Torque and fixed keys, see page 894

Square shoulder and slot milling cutters
Helical milling cutters
Face milling cutters
Disc milling cutters
High feed milling cutters
Copy milling cutters
Plunge milling cutters
Chamfer milling cutters
Spot facing cutters
Inserts

Cutter 335.10 - Insert 150.10 – Metric

Width 2,25/2,5/3,1 mm – full side – HSS body

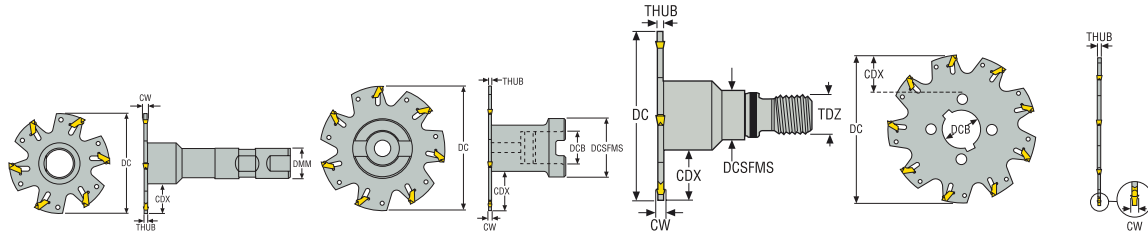

- For insert selection and cutting data recommendations, see page(s) 393-394
- For complete insert programme, see page(s) 877
- For ISO attribute explanation, see page 16

Designation	Item number	Type of mounting	DC	CWN	CWX	CDX	ZEFP	DMM	TDZ	DCB	DCSFMS	THUB	RPMX	Weight	Insert 150.10
			mm	mm	mm	mm	mm	mm	mm	mm	mm	mm	mm	kg	
R335.10-25063.3-02-5	75034462	Weldon	63,0	2,25	2,5	15,0	5	25,0	–	–	–	1,9	4000	0,6	-2.25N/2.5N
R335.10-063-02.22-5	75034464	Arbor	63,0	2,25	2,5	15,0	5	–	–	22,0	32,0	1,9	4000	0,5	-2.25N/2.5N
R335.10-1663.RE-02-5	02731371	Combimaster	63,0	2,25	2,5	16,0	5	–	M16	–	30,0	1,9	4000	0,3	-2.25N/2.5N
R335.10-32080.3-02-6	75034463	Weldon	80,0	2,25	2,5	19,5	6	32,0	–	–	–	1,9	3500	1,1	-2.25N/2.5N
R335.10-080-02.22-6	75034465	Arbor	80,0	2,25	2,5	19,5	6	–	–	22,0	40,0	1,9	3500	0,5	-2.25N/2.5N
335.10-080-02.22-6	75034458	Arbor hole	80,0	2,25	2,5	22,5	6	–	–	22,0	–	1,9	3500	0,1	-2.25N/2.5N
R335.10-1680.RE-02-6	02731373	Combimaster	80,0	2,25	2,5	19,5	6	–	M16	–	30,0	1,9	3500	0,4	-2.25N/2.5N
R335.10-100-02.27-7	75034466	Arbor	100,0	2,25	2,5	25,5	7	–	–	27,0	48,0	1,9	3200	0,9	-2.25N/2.5N
335.10-100-02.27-7	75034459	Arbor hole	100,0	2,25	2,5	29,0	7	–	–	27,0	–	1,9	3200	0,1	-2.25N/2.5N
R335.10-125-02.32-9	75034467	Arbor	125,0	2,25	2,5	33,0	9	–	–	32,0	58,0	1,9	2800	1,3	-2.25N/2.5N
335.10-125-02.32-9	75028096	Arbor hole	125,0	2,25	2,5	34,5	9	–	–	32,0	–	1,9	2800	0,2	-2.25N/2.5N
R335.10-160-02.40-12	75034468	Arbor	160,0	2,25	2,5	39,5	12	–	–	40,0	80,0	1,9	2400	2,4	-2.25N/2.5N
335.10-160-02.40-12	75034460	Arbor hole	160,0	2,25	2,5	39,5	12	–	–	40,0	–	1,9	2400	0,3	-2.25N/2.5N
R335.10-25063.3-03-5	75027293	Weldon	63,0	3,1	3,1	15,0	5	25,0	–	–	–	2,4	4000	0,5	-3N
R335.10-063-03.22-5	75027298	Arbor	63,0	3,1	3,1	15,0	5	–	–	22,0	32,0	2,4	4000	0,4	-3N
R335.10-1663.RE-03-5	02731375	Combimaster	63,0	3,1	3,1	16,0	5	–	M16	–	30,0	2,4	4000	0,3	-3N
R335.10-32080.3-03-6	75027296	Weldon	80,0	3,1	3,1	19,5	6	32,0	–	–	–	2,4	3500	1,1	-3N
R335.10-080-03.22-6	75027301	Arbor	80,0	3,1	3,1	19,5	6	–	–	22,0	40,0	2,4	3500	0,5	-3N
335.10-080-03.22-6	75012752	Arbor hole	80,0	3,1	3,1	22,5	6	–	–	22,0	–	2,4	3500	0,1	-3N
R335.10-1680.RE-03-6	02731378	Combimaster	80,0	3,1	3,1	19,5	6	–	M16	–	30,0	2,4	3500	0,5	-3N
R335.10-100-03.27-7	75027303	Arbor	100,0	3,1	3,1	25,5	7	–	–	27,0	48,0	2,4	3200	0,7	-3N
335.10-100-03.27-7	75012754	Arbor hole	100,0	3,1	3,1	29,0	7	–	–	27,0	–	2,4	3200	0,2	-3N
R335.10-125-03.32-9	75027307	Arbor	125,0	3,1	3,1	33,0	9	–	–	32,0	58,0	2,4	2800	1,4	-3N
335.10-125-03.32-9	75012756	Arbor hole	125,0	3,1	3,1	34,5	9	–	–	32,0	–	2,4	2800	0,3	-3N
R335.10-160-03.40-12	75027311	Arbor	160,0	3,1	3,1	39,5	12	–	–	40,0	80,0	2,4	2400	2,4	-3N
335.10-160-03.40-12	75012758	Arbor hole	160,0	3,1	3,1	39,5	12	–	–	40,0	–	2,4	2400	0,3	-3N
335.10-200-03.40-14	75027697	Arbor hole	200,0	3,1	3,1	59,5	14	–	–	40,0	–	2,4	2200	0,5	-3N
335.10-250-03.40-18	75028688	Arbor hole	250,0	3,1	3,1	84,5	18	–	–	40,0	–	2,4	2000	1,0	-3N
335.10-315-03.40-24	75005264	Arbor hole	315,0	3,1	3,1	117,0	24	–	–	40,0	–	2,4	1700	1,3	-3N

Width 4,1 mm – full side – HSS body

Cutter 335.10 - Insert 150.10 – Metric

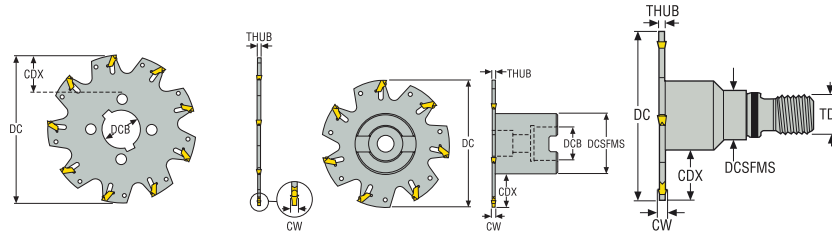

- For insert selection and cutting data recommendations, see page(s) 393-394
- For complete insert programme, see page(s) 877
- For ISO attribute explanation, see page 16

Designation	Item number	Type of mounting	DC	CWN	CWX	CDX	ZEFP	ZNP	DMM	TDZ	DCB	DCSFMS	THUB	RPMX	Weight	Insert 150.10
			mm	mm	mm	mm			mm		mm	mm	mm		kg	
R335.10-25063.3-04-5	75027294	Weldon	63,0	4,1	4,1	15,0	5	5	25,0	-	-	-	3,4	4000	0,5	-4N
R335.10-063-04.22-5	75027299	Arbor	63,0	4,1	4,1	15,0	5	5	-	-	22,0	32,0	3,4	4000	0,4	-4N
R335.10-1663.RE-04-5	02731380	Combimaster	63,0	4,1	4,1	16,0	5	5	-	M16	-	30,0	3,4	4000	0,3	-4N
R335.10-32080.3-04-6	75027297	Weldon	80,0	4,1	4,1	19,5	6	6	32,0	-	-	-	3,4	3500	1,1	-4N
R335.10-080-04.22-6	75027302	Arbor	80,0	4,1	4,1	19,5	6	6	-	-	22,0	40,0	3,4	3500	0,5	-4N
335.10-080-04.22-6	75012753	Arbor hole	80,0	4,1	4,1	22,5	6	6	-	-	22,0	-	3,4	3500	0,1	-4N
R335.10-1680.RE-04-6	02731382	Combimaster	80,0	4,1	4,1	19,5	6	6	-	M16	-	30,0	3,4	3500	0,5	-4N
R335.10-100-04.27-7	75027304	Arbor	100,0	4,1	4,1	25,5	7	7	-	-	27,0	48,0	3,4	3200	0,7	-4N
335.10-100-04.27-7	75012755	Arbor hole	100,0	4,1	4,1	29,0	7	7	-	-	27,0	-	3,4	3200	0,2	-4N
R335.10-125-04.32-9	75027309	Arbor	125,0	4,1	4,1	33,0	9	9	-	-	32,0	58,0	3,4	2800	1,5	-4N
335.10-125-04.32-9	75012757	Arbor hole	125,0	4,1	4,1	34,5	9	9	-	-	32,0	-	3,4	2800	0,4	-4N
R335.10-160-04.40-12	75027312	Arbor	160,0	4,1	4,1	39,5	12	12	-	-	40,0	80,0	3,4	2400	2,5	-4N
335.10-160-04.40-12	75012759	Arbor hole	160,0	4,1	4,1	39,5	12	12	-	-	40,0	-	3,4	2400	0,5	-4N
335.10-200-04.40-14	75027826	Arbor hole	200,0	4,1	4,1	59,5	14	14	-	-	40,0	-	3,4	2200	0,9	-4N
335.10-250-04.40-18	75028689	Arbor hole	250,0	4,1	4,1	84,5	18	18	-	-	40,0	-	3,4	2000	1,2	-4N
335.10-315-04.40-24	75034461	Arbor hole	315,0	4,1	4,1	117,0	24	24	-	-	40,0	-	3,4	1700	1,9	-4N

For Arbor hole type cutters 335.10-..., no drive holes for cutter dia 80-100 mm. For cutter dia > 100 mm, please use Seco drive rings, see page 389
 Note: For R335.10-... cutter types, the blade is assembled on the holder in the delivery

Square shoulder and slot milling cutters
 Helical milling cutters
 Face milling cutters
 Disc milling cutters
 High feed milling cutters
 Copy milling cutters
 Plunge milling cutters
 Chamfer milling cutters
 Spot facing cutters
 Inserts

Cutter 335.10 - Insert 150.10 – inch

Width 0.089/0.098/0.122 inch – full side – HSS body

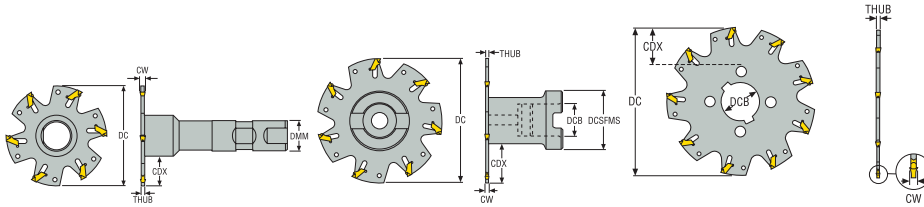

- For insert selection and cutting data recommendations, see page(s) 393-394
- For complete insert programme, see page(s) 877
- For ISO attribute explanation, see page 16

Designation	Item number	Type of mounting	DC	CWN	CWX	CDX	ZEFP	DMM	TDZ	DCB	DCSFMS	THUB	RPMX	Weight	Insert 150.10
			inch	inch	inch	inch		inch		inch	inch	inch		lbs	
R335.10-02.50-3-2	75054664	Weldon	2.500	0.089	0.098	0.602	5	1.000	–	–	–	0.075	4000	0.440	2.25N/2.5N
R335.10-02.50-2B	75054670	Arbor	2.500	0.089	0.098	0.600	5	–	–	0.750	1.575	0.075	4000	1.100	2.25N/2.5N
R335.10-03.00-3-2	75054665	Weldon	3.000	0.089	0.098	0.728	6	1.250	–	–	–	0.075	3500	2.430	2.25N/2.5N
R335.10-03.00-2B	75054671	Arbor	3.000	0.089	0.098	0.693	6	–	–	0.750	1.575	0.075	3500	1.760	2.25N/2.5N
335.10-03.00-2	75054743	Arbor hole	3.000	0.089	0.098	0.669	6	–	–	1.000	–	0.075	3500	0.440	2.25N/2.5N
R335.10-04.00-2B	75054680	Arbor	4.000	0.089	0.098	1.035	7	–	–	1.000	1.890	0.075	3200	1.540	2.25N/2.5N
335.10-04.00-2	75054744	Arbor hole	4.000	0.089	0.098	1.161	7	–	–	1.000	–	0.075	3200	0.660	2.25N/2.5N
R335.10-05.00-2B	75054681	Arbor	5.000	0.089	0.098	1.339	9	–	–	1.250	2.283	0.075	2800	3.750	2.25N/2.5N
335.10-05.00-2	75054745	Arbor hole	5.000	0.089	0.098	1.398	9	–	–	1.250	–	0.075	2800	0.880	2.25N/2.5N
R335.10-06.00-2B	75054682	Arbor	6.000	0.089	0.098	1.406	12	–	–	1.500	3.150	0.075	2400	6.170	2.25N/2.5N
335.10-06.00-2	75054746	Arbor hole	6.000	0.089	0.098	1.555	12	–	–	1.250	–	0.075	2400	0.880	2.25N/2.5N
R335.10-02.50-3-3	75054666	Weldon	2.500	0.122	0.122	0.602	5	1.000	–	–	–	0.094	4000	1.540	3N
R335.10-02.50-3B	75054672	Arbor	2.500	0.122	0.122	0.600	5	–	–	0.750	1.575	0.094	4000	1.760	3N
R335.10-03.00-3-3	75054667	Weldon	3.000	0.122	0.122	0.728	6	1.250	–	–	–	0.094	3500	2.650	3N
R335.10-03.00-3B	75054673	Arbor	3.000	0.122	0.122	0.693	6	–	–	0.750	1.575	0.094	3500	1.980	3N
335.10-03.00-3	75070139	Arbor hole	3.000	0.122	0.122	0.669	6	–	–	1.000	–	0.094	3500	0.220	3N
R335.10-04.00-3B	75054683	Arbor	4.000	0.122	0.122	1.035	7	–	–	1.000	1.890	0.094	3200	2.650	3N
335.10-04.00-3	75014456	Arbor hole	4.000	0.122	0.122	1.161	7	–	–	1.000	–	0.094	3200	0.440	3N
R335.10-05.00-3B	75054684	Arbor	5.000	0.122	0.122	1.339	9	–	–	1.250	2.283	0.094	2800	3.970	3N
335.10-05.00-3	75014458	Arbor hole	5.000	0.122	0.122	1.398	9	–	–	1.250	–	0.094	2800	0.660	3N
R335.10-06.00-3B	75054685	Arbor	6.000	0.122	0.122	1.406	12	–	–	1.500	3.150	0.094	2400	5.510	3N
335.10-06.00-3	75014460	Arbor hole	6.000	0.122	0.122	1.555	12	–	–	1.250	–	0.094	2400	0.660	3N

For Arbor hole type cutters 335.10-..., no drive holes for cutter dia 3.00 -4.00". For cutter dia > 4.00", please use Seco drive rings, see page 391
 Note: For R335.10-... cutter types, the blade is assembled on the holder in the delivery

Spare Parts – Metric

Holder for Weldon type

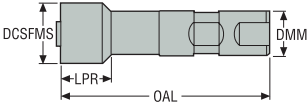

Designation	DMM	DCSFMS	OAL	LPR
335.10-25.3	25	32	106	25
335.10-32.3	32	40	150	30

Holder for Arbor type

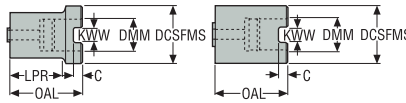

Designation	DMM	DCSFMS	OAL	LPR	KWW	C
335.10-2232	22	40	50	36	10,4	6,3
335.10-2240M	22	40	50	-	10,4	6,3
335.10-2748	27	48	50	-	12,4	7
335.10-3258	32	58	63	-	14,4	8
335.10-4080	40	80	63	-	16,4	9

Note: Assembly screws delivered Weldon, Arbor and Combimaster holders

Combimaster type

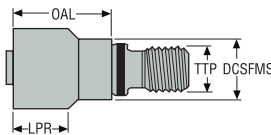

Designation	LPR	TDZ	DCSFMS	OAL
335.10-16RE-10	28	M16	30	30
335.10-16RE-18	28	M16	30	40

Note: Assembly screws delivered Weldon, Arbor and Combimaster holders

Drive rings for Arbor hole type

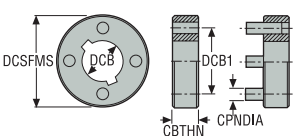

Designation	DCB	DCSFMS	CBTHN	DCB1	CPNDIA
335.10-14532	32	55	10	45	5,7
335.10-16340	40	80	12	63	10,7

Drive ring to be ordered separately

Arbor hole type

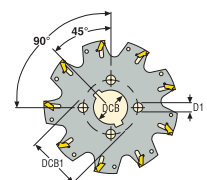

Designation	DCB	DCB1	D1
335.10-080	22	-	-
335.10-100	27	-	-
335.10-125	32	45	6
335.10-160-315	40	63	11

Spare parts (key included in delivery)

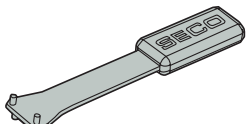

For cutter	Insert removal key
R335.10-...	150.10-150

Square shoulder and slot milling cutters
Helical milling cutters
Face milling cutters
Disc milling cutters
High feed milling cutters
Copy milling cutters
Plunge milling cutters
Chamfer milling cutters
Spot facing cutters
Inserts

Assembly components/Standard parts – metric

Weldon type cutters

Designation	Cutter body Part No.	Holder Part No.	Assembly screw	Insert key	Torque Nm
R335.10-25063.3-02-5	B-R335.10-063.10-02	335.10-25.3	3 x 335.10-0516-T15P	H6B-T15P	5 Nm
R335.10-32080.3-02-6	B-R335.10-080.18-02	335.10-32.3	3 x 335.10-0516-T15P	H6B-T15P	5 Nm
R335.10-25063.3-03-5	B-R335.10-063.10-03	335.10-25.3	3 x 335.10-0516-T15P	H6B-T15P	5 Nm
R335.10-32080.3-03-6	B-R335.10-080.18-03	335.10-32.3	3 x 335.10-0516-T15P	H6B-T15P	5 Nm
R335.10-25063.3-04-5	B-R335.10-063.10-04	335.10-25.3	3 x 335.10-0516-T15P	H6B-T15P	5 Nm
R335.10-32080.3-04-6	B-R335.10-080.18-04	335.10-32.3	3 x 335.10-0516-T15P	H6B-T15P	5 Nm

Arbor type cutters

Designation	Cutter body Part No.	Holder Part No.	Assembly screw	Insert key	Torque Nm	Arbor screw
R335.10-063-02.22-5	B-R335.10-063.10-02	335.10-2232	3 x 335.10-0516-T15P	H6B-T15P	5 Nm	220.17-696
R335.10-080-02.22-6	B-R335.10-080.18-02	335.10-2240M	3 x 335.10-0516-T15P	H6B-T15P	5 Nm	220.17-696
R335.10-063-03.22-5	B-R335.10-063.10-03	335.10-2232	3 x 335.10-0516-T15P	H6B-T15P	5 Nm	220.17-696
R335.10-080-03.22-6	B-R335.10-080.18-03	335.10-2240M	3 x 335.10-0516-T15P	H6B-T15P	5 Nm	220.17-696
R335.10-063-04.22-5	B-R335.10-063.10-04	335.10-2232	3 x 335.10-0516-T15P	H6B-T15P	5 Nm	220.17-696
R335.10-080-04.22-6	B-R335.10-080.18-04	335.10-2240M	3 x 335.10-0516-T15P	H6B-T15P	5 Nm	220.17-696

Arbor type cutters

Designation	Cutter body Part No.	Holder Part No.	Assembly screw	Insert key	Torque Nm	Arbor screw
R335.10-100-02.27-7	B-R335.10-100.27-02	335.10-2748	4 x 335.10-0516-T15P	H6B-T15P	5 Nm	MC6S 12x40
R335.10-100-03.27-7	B-R335.10-100.27-03	335.10-2748	4 x 335.10-0516-T15P	H6B-T15P	5 Nm	MC6S 12x40
R335.10-100-04.27-7	B-R335.10-100.27-04	335.10-2748	4 x 335.10-0516-T15P	H6B-T15P	5 Nm	MC6S 12x40
R335.10-125-02.32-9	B-R335.10-125.32-02	335.10-3258	4 x 335.10-0516-T15P	H6B-T15P	5 Nm	220.17-694
R335.10-125-03.32-9	B-R335.10-125.32-03	335.10-3258	4 x 335.10-0516-T15P	H6B-T15P	5 Nm	220.17-694
R335.10-125-04.32-9	B-R335.10-125.32-04	335.10-3258	4 x 335.10-0516-T15P	H6B-T15P	5 Nm	220.17-694
R335.10-160-02.40-12	B-R335.10-160.40-02	335.10-4080	4 x 335.10-1030-T30P	H6B-T30PL	5 Nm	MC6S 20x40
R335.10-160-03.40-12	B-R335.10-160.40-03	335.10-4080	4 x 335.10-1030-T30P	H6B-T30PL	5 Nm	MC6S 20x40
R335.10-160-04.40-12	B-R335.10-160.40-04	335.10-4080	4 x 335.10-1030-T30P	H6B-T30PL	5 Nm	MC6S 20x40

Combimaster

Designation	Cutter body Part No.	Holder Part No.	Assembly screw	Insert key	Torque Nm
R335.10-1663.RE-02-5	B-R335.10-063.10-02	335.10-16RE-10	3 x 335.10-0516-T15P	H6B-T15P	5 Nm
R335.10-1680.RE-02-6	B-R335.10-080.18-02	335.10-16RE-18	3 x 335.10-0516-T15P	H6B-T15P	5 Nm
R335.10-1663.RE-03-5	B-R335.10-063.10-03	335.10-16RE-10	3 x 335.10-0516-T15P	H6B-T15P	5 Nm
R335.10-1680.RE-03-6	B-R335.10-080.18-03	335.10-16RE-18	3 x 335.10-0516-T15P	H6B-T15P	5 Nm
R335.10-1663.RE-04-5	B-R335.10-063.10-04	335.10-16RE-10	3 x 335.10-0516-T15P	H6B-T15P	5 Nm
R335.10-1680.RE-04-6	B-R335.10-080.18-04	335.10-16RE-18	3 x 335.10-0516-T15P	H6B-T15P	5 Nm

Spare Parts – Inch

Holder for Weldon type				
Designation	DMM	DCSFMS	OAL	LPR
335.10-01.00-3-A	1.00	1.25	4.17	1.00
335.10-01.25-3-A	1.25	1.50	5.90	1.18

Holder for Arbor type						
Designation	DMM	DCSFMS	OAL	LPR	KWW	C
335.10-00.75-1.25B-A	0.75	1.26	1.969	1.50	0.32	0.20
335.10-00.75-1.50B-A	0.75	1.58	1.969	-	0.32	0.20
335.10-01.00-1.89B-A	1.00	1.89	1.969	-	0.38	0.23
335.10-01.25-2.28B-A	1.25	2.28	2.480	-	0.51	0.28
335.10-01.50-3.15B-A	1.50	3.15	2.480	-	0.63	0.38

Note: Assembly screws delivered with Weldon and arbor holders

Drive rings for Arbor hole type					
Designation	DCB	DCSFMS	CBTHN	DCB1	CPNDIA
335.10-14531	2.16	1.25	1.77	0.22	0.39
335.10-15531	2.83	1.25	2.16	0.42	0.47
335.10-17451	3.50	2.00	2.91	0.42	0.47

Drive ring to be ordered separately



Arbor hole type			
Designation	DCB	DCB1	D1
335.10-03.00-04.00	1.00	-	-
335.10-05.00	1.25	1.77	0.24
335.10-06.00	1.25	2.16	0.43
335.10-08.00-12.00	2.00	2.91	0.43

Spare parts (key included in delivery)	
For cutter	Insert removal key
R335.10-..	150.10-150



Square shoulder and slot milling cutters
Helical milling cutters
Face milling cutters
Disc milling cutters
High feed milling cutters
Copy milling cutters
Plunge milling cutters
Chamfer milling cutters
Spot facing cutters
Inserts

Assembly components/Standard parts – inch



Weldon type cutters

Designation	Cutter body Part No.	Holder Part No.	Assembly screw	Insert key	Torque in/lbs
					
R335.10-02.50-3-2	R335.10-02.50-2	335.10-01.00-3-A	335.10-0516-T15P(3X)	T15P-3	57.5 in.lbs
R335.10-02.50-3-3	R335.10-02.50-3	335.10-01.00-3-A	335.10-0516-T15P(3X)	T15P-3	57.5 in.lbs
R335.10-03.00-3-2	R335.10-03.00-2	335.10-01.25-3-A	335.10-0516-T15P(3X)	T15P-3	57.5 in.lbs
R335.10-03.00-3-3	R335.10-03.00-3	335.10-01.25-3-A	335.10-0516-T15P(3X)	T15P-3	57.5 in.lbs

Arbor type cutters

Designation	Cutter body Part No.	Holder Part No.	Assembly screw	Insert key	Torque in/lbs	Arbor screw
						
R335.10-02.50-2B	R335.10-02.50-2	335.10-00.75-1.25B-A	335.10-0516-T15P(3X)	T15P-3	57.5 in.lbs	220.17-695
R335.10-02.50-3B	R335.10-02.50-3	335.10-00.75-1.25B-A	335.10-0516-T15P(3X)	T15P-3	57.5 in.lbs	220.17-695
R335.10-03.00-2B	R335.10-03.00-2	335.10-00.75-1.50B-A	335.10-0516-T15P(3X)	T15P-3	57.5 in.lbs	220.17-695
R335.10-03.00-3B	R335.10-03.00-3	335.10-00.75-1.50B-A	335.10-0516-T15P(3X)	T15P-3	57.5 in.lbs	220.17-695

Arbor type cutters

Designation	Cutter body Part No.	Holder Part No.	Assembly screw	Insert key	Torque in/lbs	Arbor screw
						
R335.10-04.00-2B	R335.10-04.00-2	335.10-01.00-1.89B-A	335.10-0516-T15P(4X)	T15P-3	57.5 in.lbs	UC6S1/2UNFX1-1/2
R335.10-04.00-3B	R335.10-04.00-3	335.10-01.00-1.89B-A	335.10-0516-T15P(4X)	T15P-3	57.5 in.lbs	UC6S1/2UNFX1-1/2
R335.10-05.00-2B	R335.10-05.00-2	335.10-01.25-2.28B-A	335.10-0516-T15P(4X)	T15P-3	57.5 in.lbs	UC6S5/8UNFX11/2
R335.10-05.00-3B	R335.10-05.00-3	335.10-01.25-2.28B-A	335.10-0516-T15P(4X)	T15P-3	57.5 in.lbs	UC6S5/8UNFX11/2
R335.10-06.00-2B	R335.10-06.00-2	335.10-01.50-3-15B-A	335.10-1030-T30P(4X)	T30P-4	70.8 in.lbs	UC6S3/4UNFX1-1/4
R335.10-06.00-3B	R335.10-06.00-3	335.10-01.50-3-15B-A	335.10-1030-T30P(4X)	T30P-4	70.8 in.lbs	UC6S3/4UNFX1-1/4

Square shoulder and slot milling cutters
Helical milling cutters
Face milling cutters
Disc milling cutters
High feed milling cutters
Copy milling cutters
Plunge milling cutters
Chamfer milling cutters
Spot facing cutters
Inserts

335.10– Insert selection – mm/Inch

SMG					f _z			
					30%	20%	10%	5%
P1	150.10-2.25N-14 CP600	150.10-2.5N-14 CP600	150.10-3N-14 CP600	150.10-4N-14 CP600	0,10	0,11	0,15	0,20
					0,0040	0,0044	0,0060	0,0080
P2	150.10-2.25N-14 CP600	150.10-2.5N-14 CP600	150.10-3N-14 CP600	150.10-4N-14 CP600	0,10	0,11	0,15	0,22
					0,0040	0,0044	0,0060	0,0085
P3	150.10-2.25N-14 CP600	150.10-2.5N-14 CP600	150.10-3N-14 CP600	150.10-4N-14 CP600	0,095	0,11	0,14	0,20
					0,0038	0,0044	0,0055	0,0080
P4	150.10-2.25N-14 CP600	150.10-2.5N-14 CP600	150.10-3N-14 CP600	150.10-4N-14 CP600	0,090	0,11	0,14	0,19
					0,0036	0,0044	0,0055	0,0075
P5	150.10-2.25N-14 CP600	150.10-2.5N-14 CP600	150.10-3N-14 CP600	150.10-4N-14 CP600	0,090	0,10	0,14	0,19
					0,0036	0,0040	0,0055	0,0075
P6	150.10-2.25N-14 CP600	150.10-2.5N-14 CP600	150.10-3N-14 CP600	150.10-4N-14 CP600	0,090	0,10	0,14	0,19
					0,0036	0,0040	0,0055	0,0075
P7	150.10-2.25N-14 CP600	150.10-2.5N-14 CP600	150.10-3N-14 CP600	150.10-4N-14 CP600	0,090	0,10	0,14	0,19
					0,0036	0,0040	0,0055	0,0075
P8	150.10-2.25N-14 CP500	150.10-2.5N-14 CP500	150.10-3N-14 CP500	150.10-4N-14 CP500	0,095	0,11	0,14	0,20
					0,0038	0,0044	0,0055	0,0080
P11	150.10-2.25N-14 CP600	150.10-2.5N-14 CP600	150.10-3N-14 CP600	150.10-4N-14 CP600	0,090	0,10	0,14	0,19
					0,0036	0,0040	0,0055	0,0075
P12	150.10-2.25N-14 CP600	150.10-2.5N-14 CP600	150.10-3N-14 CP600	150.10-4N-14 CP600	0,060	0,070	0,095	0,13
					0,0024	0,0028	0,0038	0,0050
M1	150.10-2.25N-14 CP600	150.10-2.5N-14 CP600	150.10-3N-14 CP600	150.10-4N-14 CP600	0,10	0,11	0,15	0,22
					0,0040	0,0044	0,0060	0,0085
M2	150.10-2.25N-14 CP600	150.10-2.5N-14 CP600	150.10-3N-14 CP600	150.10-4N-14 CP600	0,090	0,10	0,14	0,19
					0,0036	0,0040	0,0055	0,0075
M3	150.10-2.25N-14 CP600	150.10-2.5N-14 CP600	150.10-3N-14 CP600	150.10-4N-14 CP600	0,070	0,085	0,11	0,15
					0,0028	0,0034	0,0044	0,0060
M4	150.10-2.25N-14 CP600	150.10-2.5N-14 CP600	150.10-3N-14 CP600	150.10-4N-14 CP600	0,065	0,075	0,095	0,13
					0,0026	0,0030	0,0038	0,0050
M5	150.10-2.25N-14 CP600	150.10-2.5N-14 CP600	150.10-3N-14 CP600	150.10-4N-14 CP600	0,065	0,075	0,095	0,13
					0,0026	0,0030	0,0038	0,0050
K1	150.10-2.25N-14 TGP45	150.10-2.5N-14 TGP45	150.10-3N-14 TGP45	150.10-4N-14 TGP45	0,10	0,11	0,15	0,22
					0,0040	0,0044	0,0060	0,0085
K2	150.10-2.25N-14 TGP45	150.10-2.5N-14 TGP45	150.10-3N-14 TGP45	150.10-4N-14 TGP45	0,090	0,10	0,14	0,19
					0,0036	0,0040	0,0055	0,0075
K3	150.10-2.25N-14 TGP45	150.10-2.5N-14 TGP45	150.10-3N-14 TGP45	150.10-4N-14 TGP45	0,090	0,10	0,14	0,19
					0,0036	0,0040	0,0055	0,0075
K4	150.10-2.25N-14 TGP45	150.10-2.5N-14 TGP45	150.10-3N-14 TGP45	150.10-4N-14 TGP45	0,090	0,10	0,14	0,19
					0,0036	0,0040	0,0055	0,0075
K5	150.10-2.25N-14 TGP45	150.10-2.5N-14 TGP45	150.10-3N-14 TGP45	150.10-4N-14 TGP45	0,080	0,095	0,12	0,17
					0,0032	0,0038	0,0048	0,0065
K6	150.10-2.25N-14 TGP45	150.10-2.5N-14 TGP45	150.10-3N-14 TGP45	150.10-4N-14 TGP45	0,090	0,10	0,14	0,19
					0,0036	0,0040	0,0055	0,0075
K7	150.10-2.25N-14 TGP45	150.10-2.5N-14 TGP45	150.10-3N-14 TGP45	150.10-4N-14 TGP45	0,080	0,095	0,12	0,17
					0,0032	0,0038	0,0048	0,0065
N1	150.10-2.25N-14 CP500	150.10-2.5N-12 CP500	150.10-3N-12 CP500	150.10-4N-12 CP500	0,12	0,14	0,19	0,26
					0,0048	0,0055	0,0075	0,010
N2	150.10-2.25N-14 CP500	150.10-2.5N-12 CP500	150.10-3N-12 CP500	150.10-4N-12 CP500	0,12	0,14	0,19	0,26
					0,0048	0,0055	0,0075	0,010
N3	150.10-2.25N-14 CP500	150.10-2.5N-12 CP500	150.10-3N-12 CP500	150.10-4N-12 CP500	0,12	0,14	0,19	0,26
					0,0048	0,0055	0,0075	0,010
N11	150.10-2.25N-14 CP500	150.10-2.5N-12 CP500	150.10-3N-12 CP500	150.10-4N-12 CP500	0,12	0,14	0,19	0,26
					0,0048	0,0055	0,0075	0,010
S1	150.10-2.25N-14 CP600	150.10-2.5N-14 CP600	150.10-3N-14 CP600	150.10-4N-14 CP600	0,065	0,075	0,095	0,13
					0,0026	0,0030	0,0038	0,0050
S2	150.10-2.25N-14 CP600	150.10-2.5N-14 CP600	150.10-3N-14 CP600	150.10-4N-14 CP600	0,060	0,065	0,090	0,12
					0,0024	0,0026	0,0036	0,0048
S3	150.10-2.25N-14 CP600	150.10-2.5N-14 CP600	150.10-3N-14 CP600	150.10-4N-14 CP600	0,070	0,085	0,11	0,15
					0,0028	0,0034	0,0044	0,0060
S11	150.10-2.25N-14 CP600	150.10-2.5N-14 CP600	150.10-3N-14 CP600	150.10-4N-14 CP600	0,070	0,085	0,11	0,15
					0,0028	0,0034	0,0044	0,0060
S12	150.10-2.25N-14 CP600	150.10-2.5N-14 CP600	150.10-3N-14 CP600	150.10-4N-14 CP600	0,065	0,075	0,095	0,13
					0,0026	0,0030	0,0038	0,0050
S13	150.10-2.25N-14 CP600	150.10-2.5N-14 CP600	150.10-3N-14 CP600	150.10-4N-14 CP600	0,060	0,070	0,095	0,13
					0,0024	0,0028	0,0038	0,0050
H5	150.10-2.25N-14 TGP45	150.10-2.5N-14 TGP45	150.10-3N-14 TGP45	150.10-4N-14 TGP45	0,048	0,055	0,070	0,10
					0,0019	0,0022	0,0028	0,0040
H8	150.10-2.25N-14 TGP45	150.10-2.5N-14 TGP45	150.10-3N-14 TGP45	150.10-4N-14 TGP45	0,060	0,070	0,095	0,13
					0,0024	0,0028	0,0038	0,0050
H11	150.10-2.25N-14 TGP45	150.10-2.5N-14 TGP45	150.10-3N-14 TGP45	150.10-4N-14 TGP45	0,048	0,055	0,070	0,10
					0,0019	0,0022	0,0028	0,0040
H12	150.10-2.25N-14 TGP45	150.10-2.5N-14 TGP45	150.10-3N-14 TGP45	150.10-4N-14 TGP45	0,048	0,055	0,070	0,10
					0,0019	0,0022	0,0028	0,0040
H21	150.10-2.25N-14 TGP45	150.10-2.5N-14 TGP45	150.10-3N-14 TGP45	150.10-4N-14 TGP45	0,048	0,055	0,070	0,10
					0,0019	0,0022	0,0028	0,0040

SMG = Seco material group
f_z = mm/tooth (in/tooth), v_c = m/min (sf/min), a_p/DC = %
All cutting data are start values

Square shoulder and slot milling cutters
Helical milling cutters
Face milling cutters
Disc milling cutters
High feed milling cutters
Copy milling cutters
Plunge milling cutters
Chamfer milling cutters
Spot facing cutters
Inserts

335.10 – Cutting data $v_c = (m/min)/(sf/min)$

SMG	TGP45				T350M				CP500				CP600				HX			
	30%	20%	10%	5%	30%	20%	10%	5%	30%	20%	10%	5%	30%	20%	10%	5%	30%	20%	10%	5%
P1	250	270	295	325	215	235	260	280	195	210	230	250	185	200	220	240	—	—	—	—
	820	890	970	1075	710	770	850	920	640	690	750	820	610	660	720	790	—	—	—	—
P2	240	260	290	310	210	225	250	270	190	205	225	245	180	195	215	235	—	—	—	—
	790	850	950	1025	690	740	820	890	620	670	740	800	590	640	710	770	—	—	—	—
P3	215	225	250	270	185	195	220	235	165	180	200	215	155	170	190	205	—	—	—	—
	710	740	820	890	610	640	720	770	540	590	660	710	510	560	620	670	—	—	—	—
P4	185	200	220	240	165	175	195	210	150	160	175	190	140	150	165	180	—	—	—	—
	610	660	720	790	540	570	640	690	490	520	570	620	460	490	540	590	—	—	—	—
P5	180	195	215	235	155	170	185	205	140	150	165	180	135	145	160	170	—	—	—	—
	590	640	710	770	510	560	610	670	460	490	540	590	445	475	520	560	—	—	—	—
P6	200	215	240	260	175	190	210	230	160	170	190	205	150	160	180	195	—	—	—	—
	660	710	790	850	570	620	690	750	520	560	620	670	490	520	590	640	—	—	—	—
P7	190	205	225	245	165	180	200	215	150	160	175	190	145	150	170	180	—	—	—	—
	620	670	740	800	540	590	660	710	490	520	570	620	475	490	560	590	—	—	—	—
P8	180	190	210	230	155	165	185	200	140	150	165	180	130	145	160	170	—	—	—	—
	590	620	690	750	510	540	610	660	460	490	540	590	425	475	520	560	—	—	—	—
P11	185	200	220	240	160	175	190	210	145	155	170	185	140	150	165	175	—	—	—	—
	610	660	720	790	520	570	620	690	475	510	560	610	460	490	540	570	—	—	—	—
P12	120	125	140	155	105	110	125	135	95	100	110	120	90	95	105	115	—	—	—	—
	395	410	460	510	345	360	410	445	310	330	360	395	295	310	345	375	—	—	—	—
M1	175	185	205	225	165	175	195	210	155	165	180	200	145	155	175	190	105	110	120	130
	570	610	670	740	540	570	640	690	510	540	590	660	475	510	570	620	345	360	395	425
M2	145	155	170	185	135	145	160	175	125	135	150	165	120	130	145	155	85	90	100	105
	475	510	560	610	445	475	520	570	410	445	490	540	395	425	475	510	280	295	330	345
M3	115	125	140	150	110	115	130	140	105	110	120	130	100	105	115	125	70	75	80	85
	375	410	460	490	360	375	425	460	345	360	395	425	330	345	375	410	230	245	260	280
M4	90	95	105	115	85	90	100	105	80	85	95	100	75	80	90	95	55	55	60	65
	295	310	345	375	280	295	330	345	260	280	310	330	245	260	295	310	180	180	195	215
M5	75	80	90	95	70	75	85	90	65	70	80	85	65	70	75	80	45	47	50	55
	245	260	295	310	230	245	280	295	215	230	260	280	215	230	245	260	150	155	165	180
K1	190	205	230	245	165	180	200	215	150	165	180	195	145	155	170	185	95	100	110	120
	620	670	750	800	540	590	660	710	490	540	590	640	475	510	560	610	310	330	360	395
K2	170	185	205	220	150	160	175	190	135	145	160	170	130	135	150	165	85	90	100	105
	560	610	670	720	490	520	570	620	445	475	520	560	425	445	490	540	280	295	330	345
K3	145	155	170	185	125	135	150	165	115	120	135	145	110	115	130	140	75	80	85	90
	475	510	560	610	410	445	490	540	375	395	445	475	360	375	425	460	245	260	280	295
K4	135	150	165	180	120	130	145	155	110	115	130	140	105	110	120	130	70	75	80	85
	445	490	540	590	395	425	475	510	360	375	425	460	345	360	395	425	230	245	260	280
K5	85	90	100	110	75	80	85	95	65	70	80	85	65	70	75	80	43	45	49	55
	280	295	330	360	245	260	280	310	215	230	260	280	215	230	245	260	140	150	160	180
K6	120	130	145	155	105	115	125	135	95	100	115	120	90	95	105	115	60	65	70	75
	395	425	475	510	345	375	410	445	310	330	375	395	295	310	345	375	195	215	230	245
K7	110	115	125	140	95	100	110	120	85	90	100	110	80	85	95	105	55	60	60	65
	360	375	410	460	310	330	360	395	280	295	330	360	260	280	310	345	180	195	195	215
N1	—	—	—	—	—	—	—	—	900	970	1050	1150	850	920	1000	1100	580	610	670	710
	—	—	—	—	—	—	—	—	2950	3175	3450	3775	2800	3025	3275	3600	1900	2000	2200	2325
N2	—	—	—	—	—	—	—	—	450	490	530	580	430	465	510	550	230	245	270	285
	—	—	—	—	—	—	—	—	1475	1600	1750	1900	1400	1525	1675	1800	750	800	890	940
N3	—	—	—	—	—	—	—	—	300	325	355	390	285	310	340	370	155	165	180	190
	—	—	—	—	—	—	—	—	980	1075	1175	1275	940	1025	1125	1225	510	540	590	620
N11	—	—	—	—	—	—	—	—	345	370	405	445	330	355	390	425	175	190	205	215
	—	—	—	—	—	—	—	—	1125	1225	1325	1450	1075	1175	1275	1400	570	620	670	710
S1	—	—	—	—	39	42	47	50	37	40	44	48	35	38	42	45	20	22	24	25
	—	—	—	—	130	140	155	165	120	130	145	155	115	125	140	150	65	70	80	80
S2	—	—	—	—	32	34	38	40	30	32	35	38	28	31	34	37	16	17	19	20
	—	—	—	—	105	110	125	130	100	105	115	125	90	100	110	120	50	55	60	65
S3	—	—	—	—	28	29	32	35	26	28	31	33	25	27	29	32	14	15	16	17
	—	—	—	—	90	95	105	115	85	90	100	110	80	90	95	105	46	49	50	55
S11	—	—	—	—	55	60	65	70	50	55	60	65	45	48	55	60	—	—	—	—
	—	—	—	—	180	195	215	230	165	180	195	215	150	155	180	195	—	—	—	—
S12	—	—	—	—	46	49	55	60	37	39	43	47	42	44	49	55	—	—	—	—
	—	—	—	—	150	160	180	195	120	130	140	155	140	145	160	180	—	—	—	—
S13	—	—	—	—	27	29	32	34	21	23	25	27	24	26	28	31	—	—	—	—
	—	—	—	—	90	95	105	110	70	75	80	90	80	85	90	100	—	—	—	—
H5	36	38	43	46	34	37	41	44	31	34	37	40	30	32	35	38	32	33	36	39
	120	125	140	150	110	120	135	145	100	110	120	130	100	105	115	125	105	110	120	130
H8	38	41	45	48	37	39	43	46	33	36	39	43	31	34	38	41	—	—	—	—
	125	135	150	155	120	130	140	150	110	120	130	140	100	110	125	135	—	—	—	—
H11	46	49	55	60	44	47	50	55	40	43	47	50	38	41	45	48	—	—	—	—
	150	160	180	195	145	155	165	180	130	140	155	165	125	135	150	155	—	—	—	—
H12	44	47	50	55	65	70	75	85	38	42	46	50	37	40	44	47	—	—	—	—
	145	155	165	180																



335.19

Economical, precise and free-cutting disc milling cutter system dedicated for small width of cut slotting and cutting off operations

- Width of cut 4-12 mm (.157 - .500 inch) - Flat bottom slot with SNHQ inserts.
- Cutter range diameter 40-250 mm (1.5 - 8 inch)
- Available with Cylindrical, Arbor, Arbor hole and Combimaster connection, with through coolant and close pitch option
- High insert precision with built-in wiper flat and corner radii range 0.2-6 mm (.008 - 0.236 inch)
- Economical solution with up to 4 cutting edges per inserts
- Basic tolerance of the slot $-0.02 / +0.08\text{mm} - -0.001 / +0.003''$

Cutter 335.19 - Insert SNHQ – Metric

Width 4 mm - full side

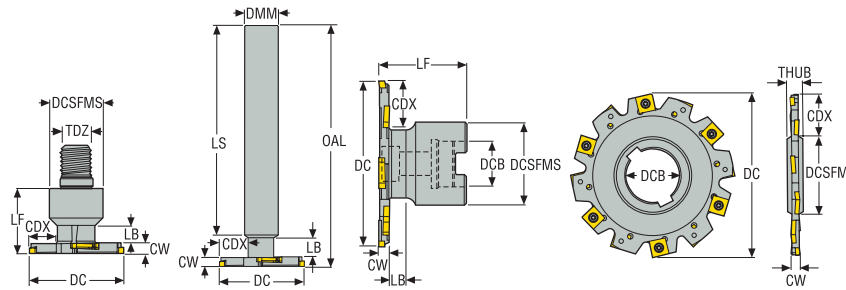

- For insert selection and cutting data recommendations, see page(s) 409-410
- For complete insert programme, see page(s) 848, 849, 855
- For spare parts and technical information, see page 405-406
- For ISO attribute explanation, see page 16

Designation	Item number	Type of mounting	DC	CW	CDX	ZEP	ZNP	DMM	TDZ	DCB	DCSFMS	OAL	THUB	LF	LS	LB	RPMX	Weight	SNHQ..R	SNHQ..L
R335.19-1040.RE-04.2NA	03277857	Combimaster	40,0	4,0	11,6	2	4	-	M10	-	18,5	-	-	23,0	-	8,26	21500	0,1	1102	1102
R335.19-2550.0-04.2	02565023	Cylindrical	50,0	4,0	13,9	2	4	25,0	-	-	-	150,0	-	-	132,2	11,0	19100	0,6	1102	1102
R335.19-1250.RE-04.3NA	03277859	Combimaster	50,0	4,0	14,9	3	6	-	M12	-	23,0	-	-	28,0	-	10,26	19100	0,2	1102	1102
R335.19-1663.RE-04.4NA	03277862	Combimaster	63,0	4,0	17,7	4	8	-	M16	-	30,0	-	-	35,0	-	11,26	17100	0,3	1102	1102
R335.19-3263.0-04.4	02565024	Cylindrical	63,0	4,0	13,9	4	8	32,0	-	-	-	170,0	-	-	148,6	0,0	17100	1,2	1102	1102
R335.19-063.04.22-3	75011447	Arbor	63,0	4,0	13,9	3	6	-	-	22,0	40,0	-	-	50,0	-	11,3	17100	0,4	1102	1102
R335.19-063.04.16-4	02565016	Arbor	63,0	4,0	13,9	4	8	-	-	16,0	33,0	-	-	35,0	-	-	17100	0,3	1102	1102
335.19-063.04.22-4	02565012	Arbor hole	63,0	4,0	13,6	4	8	-	-	22,0	33,0	-	8,0	6,0	-	-	17100	0,1	1102	1102
R335.19-080.04.22-4	75066088	Arbor	80,0	4,0	22,4	4	8	-	-	22,0	40,0	-	-	50,0	-	11,3	15200	0,4	1102	1102
R335.19-1680.RE-04.5NA	03277866	Combimaster	80,0	4,0	26,2	5	10	-	M16	-	30,0	-	-	35,0	-	11,26	15200	0,3	1102	1102
R335.19-080.04.22-5	02565017	Arbor	80,0	4,0	22,4	5	10	-	-	22,0	40,0	-	-	50,0	-	11,3	15200	0,5	1102	1102
R335.19-100.04.27-6	75011449	Arbor	100,0	4,0	22,1	6	12	-	-	27,0	48,0	-	-	50,0	-	-	13500	0,7	1102	1102
335.19-100.04.27-6	75090131	Arbor hole	100,0	4,0	24,6	6	12	-	-	27,0	41,0	-	12,0	8,0	-	-	13500	0,3	1102	1102
R335.19-20100.RE-04.7NA	03277870	Combimaster	100,0	4,0	32,7	7	14	-	M20	-	36,5	-	-	35,0	-	13,432	13500	0,5	1102	1102
R335.19-125.04.32-7	02565018	Arbor	125,0	4,0	29,6	7	14	-	-	32,0	58,0	-	-	50,0	-	-	12200	1,1	1102	1102
335.19-125.04.40-7	75090190	Arbor hole	125,0	4,0	30,1	7	14	-	-	40,0	55,0	-	12,0	8,0	-	-	12200	0,4	1102	1102
R335.19-20125.RE-04.8NA	03277873	Combimaster	125,0	4,0	45,2	8	16	-	M20	-	36,5	-	-	35,0	-	13,432	12200	0,6	1102	1102
R335.19-160.04.40-9	02565020	Arbor	160,0	4,0	41,1	9	18	-	-	40,0	70,0	-	-	50,0	-	-	10700	1,2	1102	1102
335.19-160.04.40-9	75090137	Arbor hole	160,0	4,0	42,6	9	18	-	-	40,0	65,0	-	12,0	8,0	-	-	10700	0,6	1102	1102

Spare Parts, included in delivery

Accessories

For cutter	Arbor screw	Insert key	Insert screw	Insert clamping torque	Torque key
335/R335.19 RE	-	H4B-T09P	C93504-T09P	2.0NM	T00-09P20
R335.19 DCB=22	MC6S10X40	H4B-T09P	C93504-T09P	2.0NM	T00-09P20
R335.19 DCB=16	TCEI0825	H4B-T09P	C93504-T09P	2.0NM	T00-09P20
R335.19 DCB=40	-	H4B-T09P	C93504-T09P	2.0NM	T00-09P20
R335.19 DCB=27	MC6S12X35	H4B-T09P	C93504-T09P	2.0NM	T00-09P20
R335.19 DCB=32	MC6S16X35	H4B-T09P	C93504-T09P	2.0NM	T00-09P20

Torque and fixed keys, see page 894

Width 5 mm - full side

Cutter 335.19 - Insert SNHQ

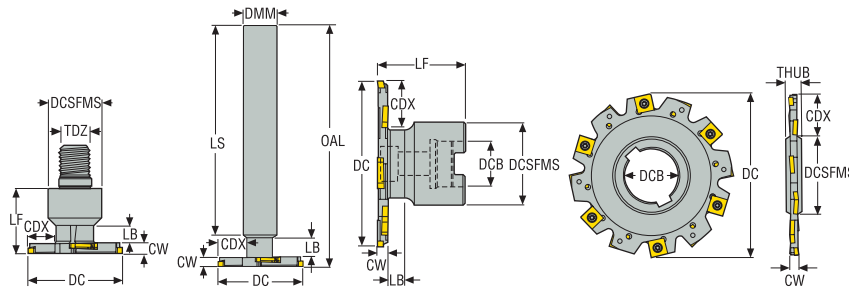

- For insert selection and cutting data recommendations, see page(s) 409-410
- For complete insert programme, see page(s) 848, 849, 855
- For spare parts and technical information, see page 405-406
- For ISO attribute explanation, see page 16

Designation	Item number	Type of mounting	DC	CW	CDX	ZEPF	ZNP	DMM	TDZ	DCB	DCSFMS	OAL	THUB	LF	LS	LB	RPMX	Weight	SNHQ..R	SNHQ..L
			mm	mm	mm		mm	mm	mm	mm	mm	mm	mm	mm	mm	mm	mm	mm	kg	
R335.19-1040.RE-05.2NA	03277858	Combimaster	40,0	5,0	11,6	2	4	-	M10	-	18,5	-	-	23,0	-	7,275	18700	0,1	1103	1103
R335.19-1250.RE-05.3NA	03277860	Combimaster	50,0	5,0	14,9	3	6	-	M12	-	23,0	-	-	28,0	-	9,275	16800	0,2	1103	1103
R335.19-2550.0-05.2	02565034	Cylindrical	50,0	5,0	13,9	2	4	25,0	-	-	-	150,0	-	-	132,2	10,0	16800	0,6	1103	1103
R335.19-1663.RE-05.4NA	03277863	Combimaster	63,0	5,0	17,6	4	8	-	M16	-	30,0	-	-	35,0	-	10,275	14900	0,3	1103	1103
R335.19-063.05.22-3	75011452	Arbor	63,0	5,0	13,9	3	6	-	-	22,0	40,0	-	-	50,0	-	10,3	14900	0,4	1103	1103
R335.19-1680.RE-05.5NA	03277867	Combimaster	80,0	5,0	26,1	5	10	-	M16	-	30,0	-	-	35,0	-	10,275	13200	0,3	1103	1103
R335.19-3280.0-05.5	02565036	Cylindrical	80,0	5,0	22,5	5	10	32,0	-	-	-	170,0	-	-	148,6	0,0	13200	1,2	1103	1103
R335.19-080.05.22-5	02565029	Arbor	80,0	5,0	22,4	5	10	-	-	22,0	40,0	-	-	50,0	-	10,3	13200	0,5	1103	1103
R335.19-080.05.22-4	75066089	Arbor	80,0	5,0	22,4	4	8	-	-	22,0	40,0	-	-	50,0	-	10,3	13200	0,5	1103	1103
335.19-080.05.22-5	02565027	Arbor hole	80,0	5,0	19,6	5	10	-	-	22,0	33,0	-	12,0	8,5	-	-	13200	0,2	1103	1103
R335.19-20100.RE-05.7NA	03277871	Combimaster	100,0	5,0	32,6	7	14	-	M20	-	36,5	-	-	35,0	-	12,447	11800	0,5	1103	1103
R335.19-100.05.27-6	75011453	Arbor	100,0	5,0	22,1	6	12	-	-	27,0	48,0	-	-	50,0	-	-	11800	0,7	1103	1103
335.19-100.05.27-6	75090132	Arbor hole	100,0	5,0	25,6	6	12	-	-	27,0	41,0	-	12,0	8,5	-	-	11800	0,3	1103	1103
R335.19-20125.RE-05.8NA	03277874	Combimaster	125,0	5,0	45,1	8	16	-	M20	-	36,5	-	-	35,0	-	12,447	10700	0,6	1103	1103
335.19-125.05.40-7	75090191	Arbor hole	125,0	5,0	31,1	7	14	-	-	40,0	55,0	-	12,0	8,5	-	-	10700	0,5	1103	1103
R335.19-125.05.32-7	02565031	Arbor	125,0	5,0	29,6	7	14	-	-	32,0	58,0	-	-	50,0	-	-	10700	1,1	1103	1103
335.19-160.05.40-9	75090138	Arbor hole	160,0	5,0	43,6	9	18	-	-	40,0	65,0	-	12,0	8,5	-	-	9300	0,7	1103	1103
R335.19-160.05.40-9	02565032	Arbor	160,0	5,0	41,1	9	18	-	-	40,0	70,0	-	-	50,0	-	-	9300	1,3	1103	1103

Spare Parts, included in delivery

Accessories

For cutter	Arbor screw	Insert key	Insert screw	Insert clamping torque	Torque key
335/R335.19 RE/Cyl	-	H4B-T09P	C93505-T09P	2.0NM	T00-09P20
R335.19 DCB=22	MC6S10X40	H4B-T09P	C93505-T09P	2.0NM	T00-09P20
R335.19 DCB=27	MC6S12X35	H4B-T09P	C93505-T09P	2.0NM	T00-09P20
R335.19 DCB=40	-	H4B-T09P	C93505-T09P	2.0NM	T00-09P20
R335.19 DCB=32	MC6S16X35	H4B-T09P	C93505-T09P	2.0NM	T00-09P20

Torque and fixed keys, see page 894

Cutter 335.19 - Insert SNHQ – Metric

Width 6 mm - full side

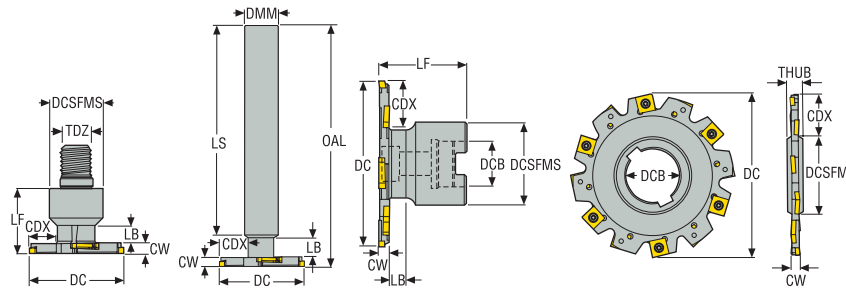

- For insert selection and cutting data recommendations, see page(s) 409-410
- For complete insert programme, see page(s) 848, 849, 855
- For spare parts and technical information, see page 405-406
- For ISO attribute explanation, see page 16

Designation	Item number	Type of mounting	DC	CW	CDX	ZEPF	ZNP	DMM	TDZ	DCB	DCSFMS	OAL	THUB	LF	LS	LB	RPMX	Weight	SNHQ..R	SNHQ..L
R335.19-1250.RE-06.2NA	03277861	Combimaster	50,0	6,0	14,9	2	4	-	M12	-	23,0	-	-	28,0	-	8,285	12300	0,2	1203	1203
R335.19-2550.0-06.2	02565041	Cylindrical	50,0	6,0	13,9	2	4	25,0	-	-	-	150,0	-	-	132,2	9,0	12300	0,6	1203	1203
R335.19-1663.RE-06.3NA	03277864	Combimaster	63,0	6,0	17,6	3	6	-	M16	-	30,0	-	-	35,0	-	9,285	10900	0,3	1203	1203
R335.19-3263.0-06.3	02565042	Cylindrical	63,0	6,0	14,0	3	6	32,0	-	-	-	170,0	-	-	148,6	0,0	10900	1,2	1203	1203
R335.19-063.06.16-3	02565038	Arbor	63,0	6,0	13,9	3	6	-	-	16,0	33,0	-	-	35,0	-	-	10900	0,3	1203	1203
R335.19-063.06.22-3	75011448	Arbor	63,0	6,0	13,9	3	6	-	-	22,0	40,0	-	-	50,0	-	9,3	10900	0,4	1203	1203
335.19-063.06.22-3	02565037	Arbor hole	63,0	6,0	13,6	3	6	-	-	22,0	33,0	-	12,0	9,0	-	-	10900	0,1	1203	1203
R335.19-1680.RE-06.4NA	03277868	Combimaster	80,0	6,0	26,3	4	8	-	M16	-	30,0	-	-	35,0	-	9,285	9700	0,3	1203	1203
R335.19-3280.0-06.4	02565043	Cylindrical	80,0	6,0	22,5	4	8	32,0	-	-	-	170,0	-	-	148,6	0,0	9700	1,2	1203	1203
R335.19-080.06.22-4	75066090	Arbor	80,0	6,0	22,4	4	8	-	-	22,0	40,0	-	-	50,0	-	9,3	9700	0,5	1203	1203
R335.19-20100.RE-06.6NA	03277872	Combimaster	100,0	6,0	32,8	6	12	-	M20	-	36,5	-	-	35,0	-	11,457	8700	0,5	1203	1203
R335.19-100.06.27-5	75011450	Arbor	100,0	6,0	22,0	5	10	-	-	27,0	48,0	-	-	50,0	-	-	8700	0,8	1203	1203
335.19-100.06.27-5	75011284	Arbor hole	100,0	6,0	25,6	5	10	-	-	27,0	41,0	-	12,0	9,0	-	-	8700	0,3	1203	1203
R335.19-125.06.32-6	02565039	Arbor	125,0	6,0	29,6	6	12	-	-	32,0	58,0	-	-	50,0	-	-	7700	1,1	1203	1203
335.19-125.06.40-6	75011289	Arbor hole	125,0	6,0	31,1	6	12	-	-	40,0	55,0	-	12,0	9,0	-	-	7700	0,5	1203	1203
R335.19-160.06.40-8	75012913	Arbor	160,0	6,0	41,1	8	16	-	-	40,0	70,0	-	-	50,0	-	-	6800	1,4	1203	1203
335.19-160.06.40-8	75011294	Arbor hole	160,0	6,0	43,6	8	16	-	-	40,0	65,0	-	12,0	9,0	-	-	6800	0,8	1203	1203
335.19-200.06.50-9	75090141	Arbor hole	200,0	6,0	61,6	9	18	-	-	50,0	69,0	-	12,0	9,0	-	-	6300	1,4	1203	1203
335.19-250.06.50-12	75012301	Arbor hole	250,0	6,0	86,6	12	24	-	-	50,0	69,0	-	12,0	9,0	-	-	5600	1,9	1203	1203

Spare Parts, included in delivery

Accessories

For cutter	Arbor screw	Insert key	Insert screw	Insert clamping torque	Torque key
335/R335.19 RE/Cyl	-	H4B-T15P	C94005-T15P	3.5NM	T00-15P35
R335.19 DCB=16	TCEI0825	H4B-T15P	C94005-T15P	3.5NM	T00-15P35
R335.19 DCB=22	MC6S10X40	H4B-T15P	C94005-T15P	3.5NM	T00-15P35
R335.19 DCB=27	MC6S12X35	H4B-T15P	C94005-T15P	3.5NM	T00-15P35
R335.19 DCB=32	MC6S16X35	H4B-T15P	C94005-T15P	3.5NM	T00-15P35
R335.19 DCB=40	-	H4B-T15P	C94005-T15P	3.5NM	T00-15P35

Torque and fixed keys, see page 894

Width 7/8/10 mm - full side

Cutter 335.19 - Insert SNHQ – Metric

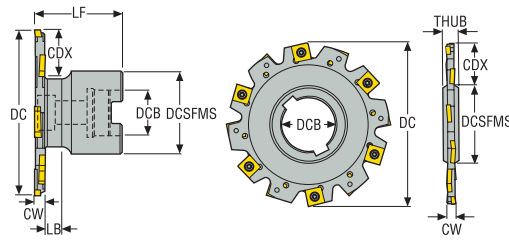

- For insert selection and cutting data recommendations, see page(s) 409-410
- For complete insert programme, see page(s) 848, 849, 855
- For spare parts and technical information, see page 405-406
- For ISO attribute explanation, see page 16

Designation	Item number	Type of mounting	DC	CW	CDX	ZEFP	ZNP	TDZ	DCB	DCSFMS	THUB	LF	LS	LB	RPMX	Weight	SNHQ..R	SNHQ..L
			mm	mm	mm							mm	mm	mm				
R335.19-1663.RE-07.3NA	03277865	Combimaster	63,0	7,0	17,6	3	6	M16	-	30,0	-	35,0	-	8,285	9400	0,3	1204/12045*	1204/12045*
R335.19-063.07.16-3	02565044	Arbor	63,0	7,0	13,8	3	6	-	16,0	33,0	-	35,0	-	-	9400	0,3	1204/12045*	1204/12045*
R335.19-063.07.22-3	75012680	Arbor	63,0	7,0	13,8	3	6	-	22,0	40,0	-	50,0	-	8,3	9400	0,4	1204/12045*	1204/12045*
R335.19-1680.RE-07.4NA	03277869	Combimaster	80,0	7,0	26,3	4	8	M16	-	30,0	-	35,0	-	8,285	8400	0,4	1204/12045*	1204/12045*
R335.19-080.07.22-4	75066091	Arbor	80,0	7,0	22,0	4	8	-	22,0	40,0	-	50,0	-	8,3	8400	0,5	1204/12045*	1204/12045*
335.19-080.07.22-4	00088988	Arbor hole	80,0	7,0	20,6	4	8	-	22,0	33,0	12,0	9,5	-	-	8400	0,2	1204/12045*	1204/12045*
R335.19-100.07.27-5	75012681	Arbor	100,0	7,0	22,0	5	10	-	27,0	48,0	-	50,0	-	-	7500	0,9	1204/12045*	1204/12045*
335.19-100.07.27-5	75012670	Arbor hole	100,0	7,0	26,6	5	10	-	27,0	41,0	12,0	9,5	-	-	7500	0,3	1204/12045*	1204/12045*
R335.19-125.07.32-6	02565045	Arbor	125,0	7,0	29,6	6	12	-	32,0	58,0	-	50,0	-	-	6700	1,2	1204/12045*	1204/12045*
335.19-125.07.40-6	75012672	Arbor hole	125,0	7,0	32,1	6	12	-	40,0	55,0	12,0	9,5	-	-	6700	0,5	1204/12045*	1204/12045*
R335.19-160.07.40-8	75012685	Arbor	160,0	7,0	41,1	8	16	-	40,0	70,0	-	50,0	-	-	5900	1,5	1204/12045*	1204/12045*
335.19-160.07.40-8	75012674	Arbor hole	160,0	7,0	44,6	8	16	-	40,0	65,0	12,0	9,5	-	-	5900	0,9	1204/12045*	1204/12045*
335.19-200.07.50-9	75012676	Arbor hole	200,0	7,0	62,6	9	18	-	50,0	69,0	12,0	9,5	-	-	5200	1,4	1204/12045*	1204/12045*
335.19-250.07.50-12	75012678	Arbor hole	250,0	7,0	87,6	12	24	-	50,0	69,0	12,0	9,5	-	-	4700	2,1	1204/12045*	1204/12045*
R335.19-100.10.27-5	75011451	Arbor	100,0	10,0	22,0	5	10	-	27,0	48,0	-	50,0	-	-	6600	0,9	1205	1205
335.19-100.10.27-5	75011288	Arbor hole	100,0	10,0	27,6	5	10	-	27,0	41,0	12,0	11,0	-	-	6600	0,4	1205	1205
R335.19-125.10.32-6	02565046	Arbor	125,0	10,0	29,6	6	12	-	32,0	58,0	-	50,0	-	-	6000	1,3	1205	1205
335.19-125.10.40-6	75011293	Arbor hole	125,0	10,0	33,1	6	12	-	40,0	55,0	12,0	11,0	-	-	6000	0,6	1205	1205
R335.19-160.10.40-8	75012914	Arbor	160,0	10,0	41,1	8	16	-	40,0	70,0	-	50,0	-	-	5200	1,8	1205	1205
335.19-160.10.40-8	75011298	Arbor hole	160,0	10,0	46,2	8	16	-	40,0	65,0	12,0	11,0	-	-	5200	1,2	1205	1205
335.19-200.10.50-9	75011373	Arbor hole	200,0	10,0	63,6	9	18	-	50,0	69,0	12,0	11,0	-	-	4700	1,9	1205	1205
335.19-250.10.50-12	75012210	Arbor hole	250,0	10,0	88,6	12	24	-	50,0	69,0	12,0	11,0	-	-	4200	3,0	1205	1205

*To generate CW=8mm use insert SNHQ12045..., LF=50,5mm and 35,5mm

Square shoulder and slot milling cutters

Helical milling cutters

Face milling cutters

Disc milling cutters

High feed milling cutters

Copy milling cutters

Plunge milling cutters

Chamfer milling cutters

Spot facing cutters

Inserts

Spare Parts, included in delivery

Accessories

For cutter	Arbor screw	Insert key	Insert screw	Insert clamping torque	Torque key
335/R335.19 RE CW7	-	H4B-T15P	C94006-T15P	3.5NM	T00-15P35
R335.19 DCB=16 CW7	TCEI0825	H4B-T15P	C94006-T15P	3.5NM	T00-15P35
R335.19 DCB=22 CW7	MC6S10X40	H4B-T15P	C94006-T15P	3.5NM	T00-15P35
R335.19 DCB=27 CW7	MC6S12X35	H4B-T15P	C94006-T15P	3.5NM	T00-15P35
R335.19 DCB=32 CW7	MC6S16X35	H4B-T15P	C94006-T15P	3.5NM	T00-15P35
R335.19 DCB=40 CW7	-	H4B-T15P	C94006-T15P	3.5NM	T00-15P35
R335.19 DCB=27 CW10	MC6S12X35	H4B-T15P	C94008-T15P	3.5NM	T00-15P35
335.19 CW10	-	H4B-T15P	C94008-T15P	3.5NM	T00-15P35
R335.19 DCB=32 CW10	MC6S16X35	H4B-T15P	C94008-T15P	3.5NM	T00-15P35
R335.19 DCB=40 CW10	-	H4B-T15P	C94008-T15P	3.5NM	T00-15P35

Torque and fixed keys, see page 894

- Square shoulder and slot milling cutters
- Helical milling cutters
- Face milling cutters
- Disc milling cutters
- High feed milling cutters
- Copy milling cutters
- Plunge milling cutters
- Chamfer milling cutters
- Spot facing cutters
- Inserts

Width 12 mm - full side

Cutter 335.19 - Insert SNHQ – Metric

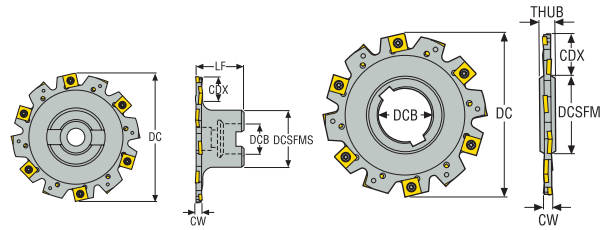

- For insert selection and cutting data recommendations, see page(s) 409-410
- For complete insert programme, see page(s) 848, 849, 855
- For spare parts and technical information, see page 405-406
- For ISO attribute explanation, see page 16

Designation	Item number	Type of mounting	DC	CW	CDX	ZEP	ZNP	DCB	DCSFMS	THUB	LF	RPMX	Weight	SNHQ..R	SNHQ..L
			mm	mm	mm	mm	mm	mm	mm	mm	mm	mm	mm	kg	
R335.19-100.12.27-5	75012682	Arbor	100,0	12,0	22,0	5	10	27,0	48,0	–	50,0	6000	0,9	1207	1207
335.19-100.12.27-5	75012671	Arbor hole	100,0	12,0	27,9	5	10	27,0	41,0	12,0	12,0	6000	0,5	1207	1207
R335.19-125.12.32-6	02565047	Arbor	125,0	12,0	29,6	6	12	32,0	58,0	–	50,0	5300	1,5	1207	1207
335.19-125.12.40-6	75012673	Arbor hole	125,0	12,0	33,9	6	12	40,0	55,0	12,0	12,0	5300	0,7	1207	1207
R335.19-160.12.40-8	75012686	Arbor	160,0	12,0	41,1	8	16	40,0	70,0	–	50,0	4700	1,9	1207	1207
335.19-160.12.40-8	75012339	Arbor hole	160,0	12,0	45,9	8	16	40,0	65,0	12,0	12,0	4700	1,3	1207	1207
335.19-200.12.50-9	75012677	Arbor hole	200,0	12,0	64,2	9	18	50,0	69,0	12,0	12,0	4200	2,2	1207	1207
335.19-250.12.50-11	75012679	Arbor hole	250,0	12,0	89,2	11	22	50,0	69,0	12,0	12,0	3700	3,7	1207	1207

Spare Parts, included in delivery

Accessories

For cutter	Arbor screw	Insert key	Insert screw	Insert clamping torque	Torque key
R335.19 DCB=27	MC6S12X35	H4B-T15P	C94010-T15P	3.5NM	T00-15P35
335.19	–	H4B-T15P	C94010-T15P	3.5NM	T00-15P35
R335.19 DCB=32	MC6S16X35	H4B-T15P	C94010-T15P	3.5NM	T00-15P35
R335.19 DCB=40	–	H4B-T15P	C94010-T15P	3.5NM	T00-15P35

Torque and fixed keys, see page 894

Square shoulder and slot milling cutters

Helical milling cutters

Face milling cutters

Disc milling cutters

High feed milling cutters

Copy milling cutters

Plunge milling cutters

Chamfer milling cutters

Spot facing cutters

Inserts

Cutter 335.19 - Insert SNHQ – inch

Width 0.156 / 0.187 / 0.250 inch – full side

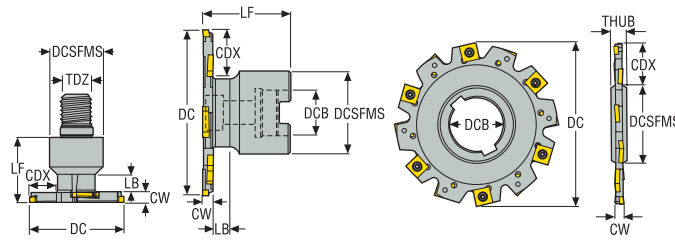

- For insert selection and cutting data recommendations, see page(s) 409-410
- For complete insert programme, see page(s) 848, 849, 855
- For spare parts and technical information, see page 405-406
- For ISO attribute explanation, see page 16

Designation	Item number	Type of mounting	DC	CW	CDX	ZFPP	ZNP	DCB	DCSFMS	THUB	LF	LB	RPMX	Weight	SNHQ..R	SNHQ..L
			inch	inch	inch			inch	inch	inch	inch	inch	inch	lbs		
R335.19-01.50-RE-0.15-2NA	03277875	Combimaster	1.500	0.156	0.445	2	4	–	0.728	–	0.906	0.326	22000	0.220	1102	1102
R335.19-02.00-RE-0.15-3NA	03277877	Combimaster	2.000	0.156	0.602	3	6	–	0.906	–	1.102	0.405	19100	0.440	1102	1102
R335.19-02.50-0.15-4	02881176	Arbor	2.500	0.156	0.559	4	8	0.750	1.575	–	2.000	0.445	17100	0.880	1102	1102
R335.19-02.50-RE-0.15-4NA	03277880	Combimaster	2.500	0.156	0.705	4	8	–	1.181	–	1.378	0.444	17100	0.660	1102	1102
R335.19-03.00-0.15-5	02881184	Arbor	3.000	0.156	0.807	5	10	0.750	1.575	–	2.000	0.445	15200	0.880	1102	1102
R335.19-03.00-RE-0.15-5NA	03277883	Combimaster	3.000	0.156	0.957	5	10	–	1.181	–	1.378	0.444	15200	0.880	1102	1102
R335.19-04.00-RE-0.15-7NA	03277886	Combimaster	4.000	0.156	1.319	7	14	–	1.437	–	1.378	0.444	13500	1.320	1102	1102
R335.19-01.50-RE-0.18-2NA	03277876	Combimaster	1.500	0.187	0.445	2	4	–	0.728	–	0.906	0.295	19100	0.220	1103	1103
R335.19-02.00-RE-0.18-3NA	03277878	Combimaster	2.000	0.187	0.602	3	6	–	0.906	–	1.102	0.374	16800	0.440	1103	1103
R335.19-02.50-0.18-4	02881177	Arbor	2.500	0.187	0.555	4	8	0.750	1.575	–	2.000	0.413	14900	0.880	1103	1103
R335.19-03.00-0.18-5	02881185	Arbor	3.000	0.187	0.807	5	10	0.750	1.575	–	2.000	0.413	13200	1.100	1103	1103
R335.19-03.00-RE-0.18-5NA	03277884	Combimaster	3.000	0.187	0.953	5	10	–	1.181	–	1.378	0.414	13200	0.880	1103	1103
335.19-04.00-0.18-6	02869718	Arbor hole	4.000	0.187	1.035	6	12	1.000	1.625	0.500	0.344	–	11800	0.660	1103	1103
R335.19-04.00-0.18-6	02869759	Arbor	4.000	0.187	0.906	6	12	1.000	1.880	–	2.000	–	11800	1.540	1103	1103
R335.19-04.00-RE-0.18-7NA	03277887	Combimaster	4.000	0.187	1.315	7	14	–	1.437	–	1.378	0.414	11800	1.320	1103	1103
335.19-05.00-0.18-7	02869719	Arbor hole	5.000	0.187	1.409	7	14	1.250	1.875	0.500	0.344	–	10700	0.880	1103	1103
335.19-06.00-0.18-9	02869720	Arbor hole	6.000	0.187	1.909	9	18	1.250	1.875	0.500	0.344	–	9300	1.320	1103	1103
R335.19-02.00-RE-0.25-2NA	03277879	Combimaster	2.000	0.250	0.602	2	4	–	0.906	–	1.102	0.312	12300	0.440	1204	1204
R335.19-02.50-0.25-3	02881178	Arbor	2.500	0.250	0.555	3	6	0.750	1.575	–	2.000	0.350	9400	0.880	1204	1204
R335.19-02.50-RE-0.25-3NA	03277882	Combimaster	2.500	0.250	0.705	3	6	–	1.181	–	1.378	0.352	9400	0.660	1204	1204
R335.19-03.00-0.25-4	02881186	Arbor	3.000	0.250	0.807	4	8	0.750	1.575	–	2.000	0.350	8400	1.100	1204	1204
R335.19-03.00-RE-0.25-4NA	03277885	Combimaster	3.000	0.250	0.961	4	8	–	1.181	–	1.378	0.352	8400	1.100	1204	1204
R335.19-04.00-RE-0.25-6NA	03277888	Combimaster	4.000	0.250	1.323	6	12	–	1.437	–	1.378	0.352	7500	1.540	1204	1204
R335.19-04.00-0.25-5	02869760	Arbor	4.000	0.250	0.906	5	10	1.000	1.880	–	2.000	–	7500	1.760	1204	1204
335.19-04.00-0.25-5	02869721	Arbor hole	4.000	0.250	1.075	5	10	1.000	1.625	0.500	0.375	–	7500	0.660	1204	1204
335.19-05.00-0.25-6	02869722	Arbor hole	5.000	0.250	1.449	6	12	1.250	1.875	0.500	0.375	–	6700	1.100	1204	1204
R335.19-05.00-0.25-6	02869761	Arbor	5.000	0.250	1.220	6	12	1.250	2.250	–	2.000	–	6700	2.430	1204	1204
335.19-06.00-0.25-7	02869723	Arbor hole	6.000	0.250	1.949	7	14	1.250	1.875	0.500	0.375	–	5900	1.540	1204	1204
R335.19-06.00-0.25-7	02869762	Arbor	6.000	0.250	1.220	7	14	1.500	2.750	–	2.000	–	5900	3.530	1204	1204
335.19-08.00-0.25-9	02869724	Arbor hole	8.000	0.250	2.512	9	18	1.500	2.750	0.500	0.375	–	5200	0.880	1204	1204

Spare Parts, included in delivery

Accessories

For cutter	Arbor screw	Insert key	Insert screw	Insert clamping torque	Torque key
R335.19RE CW=0.156	-	H4B-T09P	C93504-T09P	17.7IN.LBS	T00-09P20
R335.19 DCB=0.75 CW=0.156	UC6S3/8UNFX1-3/4	H4B-T09P	C93504-T09P	17.7IN.LBS	T00-09P20
335.19, R335.19RE CW=0.187	-	H4B-T09P	C93505-T09P	17.7IN.LBS	T00-09P20
R335.19 DCB=0.75 CW=0.187	UC6S3/8UNFX1-3/4	H4B-T09P	C93505-T09P	17.7IN.LBS	T00-09P20
R335.19 DCB=1.00CW=0.187	UC6S1/2UNFX1-1/2	H4B-T09P	C93505-T09P	17.7IN.LBS	T00-09P20
335.19, R335.19RE CW=0.25	-	H4B-T15P	C94055-T15P	31.0IN.LBS	T00-15P35
R335.19 DCB=0.75 CW=0.25	UC6S3/8UNFX1-3/4	H4B-T15P	C94055-T15P	31.0IN.LBS	T00-15P35
R335.19 DCB=1.00 CW=0.25	UC6S1/2UNFX1-1/2	H4B-T15P	C94055-T15P	31.0IN.LBS	T00-15P35
R335.19 DCB=1.25 CW=0.25	UC6S5/8UNFX11/2	H4B-T15P	C94055-T15P	31.0IN.LBS	T00-15P35
R335.19 DCB=1.5 CW=0.25	ULC6S3/4UNFX11/2	H4B-T15P	C94055-T15P	31.0IN.LBS	T00-15P35

Torque and fixed keys, see page 894

- Square shoulder and slot milling cutters
- Helical milling cutters
- Face milling cutters
- Disc milling cutters
- High feed milling cutters
- Copy milling cutters
- Plunge milling cutters
- Chamfer milling cutters
- Spot facing cutters
- Inserts

Cutter 335.19 - Insert SNHQ – inch

Width 0.313 / 0.375 / 0.5 inch – full side

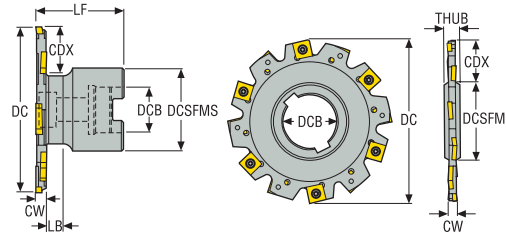

- For insert selection and cutting data recommendations, see page(s) 409-410
- For complete insert programme, see page(s) 848, 849, 855
- For spare parts and technical information, see page 405-406
- For ISO attribute explanation, see page 16

Designation	Item number	Type of mounting	DC	CW	CDX	ZFPP	ZNP	DCB	DCSFMS	THUB	LF	LB	RPMX	Weight	SNHQ..R	SNHQ..L
			inch	inch	inch		inch	inch	inch	inch	inch	inch	inch	lbs		
R335.19-02.50-0.31-3	02881179	Arbor	2.500	0.313	0.555	3	6	0.750	1.575	–	2.000	0.287	9400	1.100	12045	12045
R335.19-03.00-0.31-4	02881187	Arbor	3.000	0.313	0.807	4	8	0.750	1.575	–	2.000	0.287	8400	1.100	12045	12045
R335.19-04.00-0.31-5	02869763	Arbor	4.000	0.313	0.906	5	10	1.000	1.880	–	2.000	–	7500	1.760	12045	12045
335.19-05.00-0.31-6	02869727	Arbor hole	5.000	0.313	1.449	6	12	1.250	1.875	0.500	0.406	–	6700	1.320	12045	12045
335.19-06.00-0.31-7	02869728	Arbor hole	6.000	0.313	1.949	7	14	1.250	1.875	0.500	0.406	–	5900	1.980	12045	12045
R335.19-02.50-0.37-3	02881180	Arbor	2.500	0.375	0.555	3	6	0.750	1.575	–	2.000	0.224	8400	1.100	1205	1205
R335.19-03.00-0.37-4	02881188	Arbor	3.000	0.375	0.807	4	8	0.750	1.575	–	2.000	0.224	8400	1.100	1205	1205
R335.19-04.00-0.37-5	02869766	Arbor	4.000	0.375	0.906	5	10	1.000	1.880	–	2.000	–	6600	1.980	1205	1205
335.19-04.00-0.37-5	02869731	Arbor hole	4.000	0.375	1.114	5	10	1.000	1.625	0.500	0.437	–	6600	0.880	1205	1205
335.19-05.00-0.37-6	02869732	Arbor hole	5.000	0.375	1.488	6	12	1.250	1.875	0.500	0.437	–	6000	1.320	1205	1205
335.19-06.00-0.37-7	02869733	Arbor hole	6.000	0.375	2.020	7	14	1.250	1.875	0.500	0.437	–	5200	2.200	1205	1205
R335.19-04.00-0.50-5	02869769	Arbor	4.000	0.500	0.906	5	10	1.000	1.880	–	2.000	–	6000	2.200	1207	1207
335.19-04.00-0.50-5	02869736	Arbor hole	4.000	0.500	1.126	5	10	1.000	1.625	0.500	0.500	–	6000	1.100	1207	1207
R335.19-05.00-0.50-6	02869770	Arbor	5.000	0.500	1.220	6	12	1.250	2.250	–	2.000	–	5300	3.090	1207	1207
335.19-06.00-0.50-7	02869738	Arbor hole	6.000	0.500	2.000	7	14	1.250	1.875	0.500	0.500	–	4700	2.870	1207	1207

Spare Parts, included in delivery

Accessories

For cutter	Arbor screw	Insert key	Insert screw	Insert clamping torque	Torque key
R335.19 DCB=0.75 CW=0.313	UC6S3/8UNFX1-3/4	H4B-T15P	C94006-T15P	31.0IN.LBS	T00-15P35
R335.19 DCB=1.00 CW=0.313	UC6S1/2UNFX1-1/2	H4B-T15P	C94006-T15P	31.0IN.LBS	T00-15P35
335.19- CW=0.313	–	H4B-T15P	C94006-T15P	31.0IN.LBS	T00-15P35
R335.19 DCB=0.75 CW=0.375	UC6S3/8UNFX1-3/4	H4B-T15P	C94008-T15P	31.0IN.LBS	T00-15P35
R335.19 DCB=1.00 CW=0.375	UC6S1/2UNFX1-1/2	H4B-T15P	C94008-T15P	31.0IN.LBS	T00-15P35
335.19 CW=0.375	–	H4B-T15P	C94008-T15P	31.0IN.LBS	T00-15P35
R335.19 DCB=1.00 CW=0.5	UC6S1/2UNFX1-1/2	H4B-T15P	C94010-T15P	31.0IN.LBS	T00-15P35
335.19 CW=0.5	–	H4B-T15P	C94010-T15P	31.0IN.LBS	T00-15P35
R335.19 DCB=1.25 CW=0.5	UC6S5/8UNFX11/2	H4B-T15P	C94010-T15P	31.0IN.LBS	T00-15P35

Torque and fixed keys, see page 894

Disc milling cutter 335.19 – Technical information

Cutter side

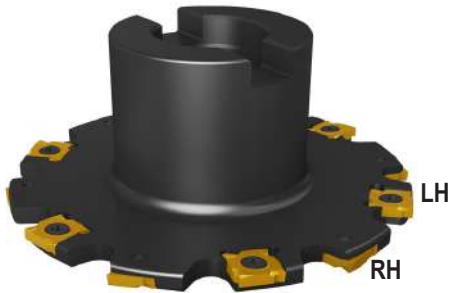

LH = Left hand insert
RH = Right hand insert

SNHQ insert choice: Width of cut and corner radius choice



Inserts	a_p	R 0,2	R 0,4	R 0,8	R 1,0	R 1,2	R 1,6	R 2,0	R 2,4	R 3,0	R 3,1	R 3,5	R 4,0	R 5,0	R 6,0
SNHQ 1102	4	■	■	■		■	■	■							
SNHQ 1103	5	■	■	■		■	■	■							
SNHQ 1203	6	■	■	■	■	■	■	■	x	o					
SNHQ 1204	7	■	■	■		■	■	■	x		x	o			
SNHQ 12045	8	■	■	■		■	■	■	x		x		o		
SNHQ 1205	10	■	■	■	■	■	■	■	x		x		x	o	
SNHQ 1207	12		■	■		■	■	■	x		x		x	x	o

Inserts	a_p	.008	.016	.031	.039	.047	.063	.079	.094	.118	.122	.138	.157	.197	.236
SNHQ 1102	.156	■	■	■		■	■	■							
SNHQ 1103	.187	■	■	■		■	■	■							
SNHQ 1204	.250	■	■	■		■	■	■	x		x				
SNHQ 12045	.313	■	■	■		■	■	■	x		x				
SNHQ 1205	.375	■	■	■	■	■	■	■	x		x		x		
SNHQ 1207	.500		■	■		■	■	■	x		x		x	x	x

■ = SNHQ 4 edges
x = SNHQ 2 edges
o = Full radius possibilities

Square shoulder and slot milling cutters
Helical milling cutters
Face milling cutters
Disc milling cutters
High feed milling cutters
Copy milling cutters
Plunge milling cutters
Chamfer milling cutters
Spot facing cutters
Inserts

Keyway for Arbor hole type and Arbor type cutter

- Square shoulder and slot milling cutters
- Helical milling cutters
- Face milling cutters
- Disc milling cutters
- High feed milling cutters
- Copy milling cutters
- Plunge milling cutters
- Chamfer milling cutters
- Spot facing cutters
- Inserts

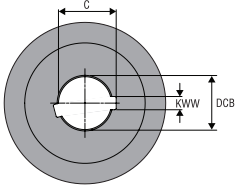

Dimensions in mm		
DCB	KWW	C
22	6	24,15
27	7	29,9
40	10	43,6
50	12	53,6

Dimensions in inch		
DCB	KWW	C
1.00	0.250	1.110
1.25	0.312	1.393
1.50	0.375	1.673
2.00	0.500	2.198

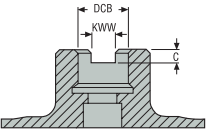

Dimensions in mm		
DCB	KWW	C
16	8,4	5,6
22	10,4	6,3
27	12,4	7
32	14,4	8
40	16,4	9

Dimensions in inch		
DCB	KWW	C
0.75	0.32	0.19
1.00	0.38	0.22
1.25	0.51	0.28
1.50	0.63	0.38

SNHQ– Insert selection – mm/Inch

SMG		f _z		
		30%	20%	10%
P1	SNHQ...-M07 F40M	0,12 0.0048	0,14 0.0055	0,19 0.0075
P2	SNHQ...-M07 F40M	0,13 0.0050	0,14 0.0055	0,19 0.0075
P3	SNHQ...-M07 F40M	0,12 0.0048	0,14 0.0055	0,18 0.0070
P4	SNHQ...-M07 F40M	0,12 0.0048	0,13 0.0050	0,18 0.0070
P5	SNHQ...-M07 F40M	0,11 0.0044	0,13 0.0050	0,17 0.0065
P6	SNHQ...-M07 F40M	0,11 0.0044	0,13 0.0050	0,17 0.0065
P7	SNHQ...-M07 F40M	0,11 0.0044	0,13 0.0050	0,17 0.0065
P8	SNHQ...-M07 F30M	0,12 0.0048	0,14 0.0055	0,18 0.0070
P11	SNHQ...-M07 F40M	0,11 0.0044	0,13 0.0050	0,17 0.0065
P12	SNHQ...-M07 F40M	0,075 0.0030	0,090 0.0036	0,12 0.0048
M1	SNHQ...-M07 F40M	0,13 0.0050	0,14 0.0055	0,19 0.0075
M2	SNHQ...-M07 F40M	0,11 0.0044	0,13 0.0050	0,17 0.0065
M3	SNHQ...-M07 F40M	0,090 0.0036	0,10 0.0040	0,14 0.0055
M4	SNHQ...-M07 F40M	0,080 0.0032	0,090 0.0036	0,12 0.0048
M5	SNHQ...-M07 F40M	0,080 0.0032	0,090 0.0036	0,12 0.0048
K1	SNHQ...-M07 MP2501	0,13 0.0050	0,14 0.0055	0,19 0.0075
K2	SNHQ...-M07 MP2501	0,11 0.0044	0,13 0.0050	0,17 0.0065
K3	SNHQ...-M07 MP2501	0,11 0.0044	0,13 0.0050	0,17 0.0065
K4	SNHQ...-M07 MP2501	0,11 0.0044	0,13 0.0050	0,17 0.0065
K5	SNHQ...-M07 MP2501	0,10 0.0040	0,12 0.0048	0,16 0.0065
K6	SNHQ...-M07 MP2501	0,11 0.0044	0,13 0.0050	0,17 0.0065
K7	SNHQ...-M07 MP2501	0,10 0.0040	0,12 0.0048	0,16 0.0065
N1	SNHQ...-E05 H25	0,14 0.0055	0,16 0.0065	0,22 0.0085
N2	SNHQ...-E05 H25	0,14 0.0055	0,16 0.0065	0,22 0.0085
N3	SNHQ...-E05 H25	0,14 0.0055	0,16 0.0065	0,22 0.0085
N11	SNHQ...-E05 H25	0,14 0.0055	0,16 0.0065	0,22 0.0085
S1	SNHQ...-M07 F40M	0,080 0.0032	0,090 0.0036	0,12 0.0048
S2	SNHQ...-M07 F40M	0,075 0.0030	0,085 0.0034	0,11 0.0044
S3	SNHQ...-M07 F40M	0,090 0.0036	0,10 0.0040	0,14 0.0055
S11	SNHQ...-M07 F40M	0,090 0.0036	0,10 0.0040	0,14 0.0055
S12	SNHQ...-M07 F40M	0,080 0.0032	0,090 0.0036	0,12 0.0048
S13	SNHQ...-M07 F40M	0,080 0.0032	0,090 0.0036	0,12 0.0048
H5	SNHQ...-M07 F30M	0,075 0.0030	0,090 0.0036	0,12 0.0048
H8	SNHQ...-M07 F30M	0,060 0.0024	0,070 0.0028	0,090 0.0036
H11	SNHQ...-M07 F40M	0,075 0.0030	0,090 0.0036	0,12 0.0048
H12	SNHQ...-M07 F40M	0,060 0.0024	0,070 0.0028	0,090 0.0036
H21	SNHQ...-M07 F30M	0,060 0.0024	0,070 0.0028	0,090 0.0036

SMG = Seco material group
 f_z = mm/tooth (in/tooth), v_c = m/min (sf/min), a_p/DC = %
 All cutting data are start values

Square shoulder and slot milling cutters
 Helical milling cutters
 Face milling cutters
 Disc milling cutters
 High feed milling cutters
 Copy milling cutters
 Plunge milling cutters
 Chamfer milling cutters
 Spot facing cutters
 Inserts

SNHQ – Cutting data $v_c = (m/min)/(sf/min)$

SMG	MP2501			F30M			F40M			H25		
	30%	20%	10%	30%	20%	10%	30%	20%	10%	30%	20%	10%
P1	245	260	285	195	205	230	185	195	215	—	—	—
	800	850	940	640	670	750	610	640	710	—	—	—
P2	235	255	280	185	200	220	175	190	210	—	—	—
	770	840	920	610	660	720	570	620	690	—	—	—
P3	205	220	245	165	175	195	155	165	185	—	—	—
	670	720	800	540	570	640	510	540	610	—	—	—
P4	180	195	215	145	155	170	135	150	165	—	—	—
	590	640	710	475	510	560	445	490	540	—	—	—
P5	175	185	210	140	150	165	135	140	155	—	—	—
	570	610	690	460	490	540	445	460	510	—	—	—
P6	200	210	235	155	165	185	150	160	175	—	—	—
	660	690	770	510	540	610	490	520	570	—	—	—
P7	185	200	220	150	160	175	140	150	165	—	—	—
	610	660	720	490	520	570	460	490	540	—	—	—
P8	170	185	205	135	145	165	130	140	155	—	—	—
	560	610	670	445	475	540	425	460	510	—	—	—
P11	180	190	215	145	155	170	135	145	160	—	—	—
	590	620	710	475	510	560	445	475	520	—	—	—
P12	115	125	135	95	100	110	90	95	105	—	—	—
	375	410	445	310	330	360	295	310	345	—	—	—
M1	170	185	200	150	165	180	140	155	170	—	—	—
	560	610	660	490	540	590	460	510	560	—	—	—
M2	140	150	165	125	135	150	120	125	140	—	—	—
	460	490	540	410	445	490	395	410	460	—	—	—
M3	115	120	135	100	110	120	95	105	115	—	—	—
	375	395	445	330	360	395	310	345	375	—	—	—
M4	85	95	105	80	85	90	75	80	90	—	—	—
	280	310	345	260	280	295	245	260	295	—	—	—
M5	75	80	85	65	70	75	60	65	75	—	—	—
	245	260	280	215	230	245	195	215	245	—	—	—
K1	185	200	220	145	160	175	140	150	170	—	—	—
	610	660	720	475	520	570	460	490	560	—	—	—
K2	165	175	195	135	140	155	125	135	150	—	—	—
	540	570	640	445	460	510	410	445	490	—	—	—
K3	140	150	165	115	120	135	105	115	125	—	—	—
	460	490	540	375	395	445	345	375	410	—	—	—
K4	135	145	160	105	115	125	100	110	120	—	—	—
	445	475	520	345	375	410	330	360	395	—	—	—
K5	80	85	95	65	70	75	60	65	75	—	—	—
	260	280	310	215	230	245	195	215	245	—	—	—
K6	120	125	140	95	100	110	90	95	105	—	—	—
	395	410	460	310	330	360	295	310	345	—	—	—
K7	105	110	125	85	90	100	80	85	95	—	—	—
	345	360	410	280	295	330	260	280	310	—	—	—
N1	—	—	—	1100	1175	1300	1050	1125	1250	1025	1100	1200
	—	—	—	3600	3850	4275	3450	3700	4100	3375	3600	3925
N2	—	—	—	445	480	530	425	455	500	415	440	485
	—	—	—	1450	1575	1750	1400	1500	1650	1350	1450	1600
N3	—	—	—	295	320	355	280	305	335	275	295	325
	—	—	—	970	1050	1175	920	1000	1100	900	970	1075
N11	—	—	—	340	365	405	320	345	385	315	335	370
	—	—	—	1125	1200	1325	1050	1125	1275	1025	1100	1225
S1	42	46	50	36	39	43	35	37	41	—	—	—
	140	150	165	120	130	140	115	120	135	—	—	—
S2	34	37	41	29	31	35	28	30	33	—	—	—
	110	120	135	95	100	115	90	100	110	—	—	—
S3	30	32	36	26	27	30	24	26	29	—	—	—
	100	105	120	85	90	100	80	85	95	—	—	—
S11	60	65	70	50	55	60	49	50	55	—	—	—
	195	215	230	165	180	195	160	165	180	—	—	—
S12	50	55	60	36	38	42	41	44	48	—	—	—
	165	180	195	120	125	140	135	145	155	—	—	—
S13	29	31	34	21	22	24	24	25	28	—	—	—
	95	100	110	70	70	80	80	80	90	—	—	—
H5	35	37	41	31	33	36	29	31	34	—	—	—
	115	120	135	100	110	120	95	100	110	—	—	—
H8	37	39	44	32	34	38	31	33	36	—	—	—
	120	130	145	105	110	125	100	110	120	—	—	—
H11	45	48	55	39	42	46	37	40	44	—	—	—
	150	155	180	130	140	150	120	130	145	—	—	—
H12	43	46	50	38	40	45	36	38	42	—	—	—
	140	150	165	125	130	150	120	125	140	—	—	—
H21	37	39	44	32	34	38	31	33	36	—	—	—
	120	130	145	105	110	125	100	110	120	—	—	—

335.19 – Insert selection – mm/Inch

SMG		f _z		
		30%	20%	10%
P1	335.19-...-M08 F40M	0,12 0.0048	0,14 0.0055	0,19 0.0075
P2	335.19-...-M08 F40M	0,12 0.0048	0,14 0.0055	0,19 0.0075
P3	335.19-...-M08 F40M	0,12 0.0048	0,14 0.0055	0,18 0.0070
P4	335.19-...-M08 F40M	0,12 0.0048	0,13 0.0050	0,18 0.0070
P5	335.19-...-M08 F40M	0,11 0.0044	0,13 0.0050	0,17 0.0065
P6	335.19-...-M08 F40M	0,11 0.0044	0,13 0.0050	0,17 0.0065
P7	335.19-...-M08 F40M	0,11 0.0044	0,13 0.0050	0,17 0.0065
P8	335.19-...-MD09 F40M	0,13 0.0050	0,15 0.0060	0,20 0.0080
P11	335.19-...-M08 F40M	0,11 0.0044	0,13 0.0050	0,17 0.0065
P12	335.19-...-M08 F40M	0,075 0.0030	0,090 0.0036	0,12 0.0048
M1	335.19-...-M08 F40M	0,12 0.0048	0,14 0.0055	0,19 0.0075
M2	335.19-...-M08 F40M	0,11 0.0044	0,13 0.0050	0,17 0.0065
M3	335.19-...-M08 F40M	0,090 0.0036	0,10 0.0040	0,14 0.0055
M4	335.19-...-M08 F40M	0,080 0.0032	0,090 0.0036	0,12 0.0048
M5	335.19-...-M08 F40M	0,080 0.0032	0,090 0.0036	0,12 0.0048
K1	335.19-...-MD09 F40M	0,14 0.0055	0,16 0.0065	0,22 0.0085
K2	335.19-...-MD09 F40M	0,13 0.0050	0,15 0.0060	0,20 0.0080
K3	335.19-...-MD09 F40M	0,13 0.0050	0,15 0.0060	0,20 0.0080
K4	335.19-...-MD09 F40M	0,13 0.0050	0,15 0.0060	0,20 0.0080
K5	335.19-...-MD09 F40M	0,11 0.0044	0,13 0.0050	0,18 0.0070
K6	335.19-...-MD09 F40M	0,13 0.0050	0,15 0.0060	0,20 0.0080
K7	335.19-...-MD09 F40M	0,11 0.0044	0,13 0.0050	0,18 0.0070
S1	335.19-...-M08 F40M	0,080 0.0032	0,090 0.0036	0,12 0.0048
S2	335.19-...-M08 F40M	0,080 0.0032	0,090 0.0036	0,12 0.0048
S3	335.19-...-M08 F40M	0,075 0.0030	0,085 0.0034	0,11 0.0044
S11	335.19-...-M08 F40M	0,090 0.0036	0,10 0.0040	0,14 0.0055
S12	335.19-...-M08 F40M	0,090 0.0036	0,10 0.0040	0,14 0.0055
S13	335.19-...-M08 F40M	0,080 0.0032	0,090 0.0036	0,12 0.0048
H5	335.19-...-MD09 F40M	0,085 0.0034	0,10 0.0040	0,13 0.0050
H8	335.19-...-MD09 F40M	0,065 0.0026	0,075 0.0030	0,10 0.0040
H11	335.19-...-MD09 F40M	0,085 0.0034	0,10 0.0040	0,13 0.0050
H12	335.19-...-MD09 F40M	0,065 0.0026	0,075 0.0030	0,10 0.0040
H21	335.19-...-MD09 F40M	0,065 0.0026	0,075 0.0030	0,10 0.0040

SMG = Seco material group
 f_z = mm/tooth (in/tooth), v_c = m/min (sf/min), a_p/DC = %
 All cutting data are start values

Square shoulder and slot milling cutters
 Helical milling cutters
 Face milling cutters
 Disc milling cutters
 High feed milling cutters
 Copy milling cutters
 Plunge milling cutters
 Chamfer milling cutters
 Spot facing cutters
 Inserts

335.19 – Cutting data $v_c = (m/min)/(sf/min)$

	SMG	MP2501			F40M		
		30%	20%	10%	30%	20%	10%
Square shoulder and slot milling cutters	P1	220	240	260	175	185	205
		720	790	850	570	610	670
Helical milling cutters	P2	215	230	255	170	180	200
		710	750	840	560	590	660
Face milling cutters	P3	190	205	225	145	155	175
		620	670	740	475	510	570
Face milling cutters	P4	165	180	200	130	140	155
		540	590	660	425	460	510
Face milling cutters	P5	160	170	190	125	135	150
		520	560	620	410	445	490
Face milling cutters	P6	180	195	215	140	150	165
		590	640	710	460	490	540
Face milling cutters	P7	170	185	205	135	140	160
		560	610	670	445	460	520
Face milling cutters	P8	160	170	190	125	130	145
		520	560	620	410	425	475
Face milling cutters	P11	165	180	195	130	140	155
		540	590	640	425	460	510
Face milling cutters	P12	110	115	125	85	90	100
		360	375	410	280	295	330
Disc milling cutters	M1	155	165	185	135	145	160
		510	540	610	445	475	520
Disc milling cutters	M2	130	135	150	115	120	135
		425	445	490	375	395	445
Disc milling cutters	M3	105	110	120	90	100	105
		345	360	395	295	330	345
Disc milling cutters	M4	80	85	95	70	75	85
		260	280	310	230	245	280
Disc milling cutters	M5	65	70	80	60	65	70
		215	230	260	195	215	230
High feed milling cutters	K1	170	185	200	135	145	160
		560	610	660	445	475	520
High feed milling cutters	K2	150	160	180	120	125	140
		490	520	590	395	410	460
High feed milling cutters	K3	130	135	150	100	110	120
		425	445	490	330	360	395
High feed milling cutters	K4	120	130	145	95	105	115
		395	425	475	310	345	375
High feed milling cutters	K5	75	80	90	60	60	70
		245	260	295	195	195	230
High feed milling cutters	K6	110	115	125	85	90	100
		360	375	410	280	295	330
High feed milling cutters	K7	95	105	115	75	80	90
		310	345	375	245	260	295
Plunge milling cutters	N1	—	—	—	990	1075	1175
		—	—	—	3250	3525	3850
Plunge milling cutters	N2	—	—	—	400	430	475
		—	—	—	1300	1400	1550
Plunge milling cutters	N3	—	—	—	265	285	315
		—	—	—	870	940	1025
Plunge milling cutters	N11	—	—	—	305	325	365
		—	—	—	1000	1075	1200
Chamfer milling cutters	S1	—	—	—	33	35	39
		—	—	—	110	115	130
Chamfer milling cutters	S2	—	—	—	26	28	31
		—	—	—	85	90	100
Chamfer milling cutters	S3	—	—	—	23	25	27
		—	—	—	75	80	90
Chamfer milling cutters	S11	—	—	—	46	50	55
		—	—	—	150	165	180
Chamfer milling cutters	S12	—	—	—	39	42	46
		—	—	—	130	140	150
Chamfer milling cutters	S13	—	—	—	22	24	27
		—	—	—	70	80	90
Spot facing cutters	H5	—	—	—	28	30	33
		—	—	—	90	100	110
Spot facing cutters	H8	—	—	—	29	31	35
		—	—	—	95	100	115
Inserts	H11	—	—	—	36	38	42
		—	—	—	120	125	140
Inserts	H12	—	—	—	34	36	40
		—	—	—	110	120	130
Inserts	H21	—	—	—	29	31	35
		—	—	—	95	100	115



335.18

Highly economical, versatile and free-cutting disc milling cutter system dedicated for medium width of cut slotting, or half side and face cutting operations

- Width of cut 8-20 mm (.312 - .7500 inch) - slot with flat bottom
- Cutter range diameter 32-315 mm (1.25 - 12 inch)
- Fixed or adjustable cutting width with replaceable cassettes
- Available with Cylindrical, Arbor, Arbor hole and Combimaster connection, with through coolant and close pitch option
- Corner radii range 0.4-4 mm (.016 - 0.16 inch), and possibility to apply round insert dia 8/10/12mm in adjustable system
- Economical solution with up to 4 cutting edges per insert
- Basic tolerance of the slot:
 - Fixed pocket cutters: $\pm 0.08\text{mm}$ ($\pm 0.003''$)
 - Adjustable cutters: $\pm 0.07\text{mm}$ ($\pm 0.0025''$)

Cutter 335.18 - Insert LNK. – Metric

Width 8/10 mm - full side - Fixed pocket

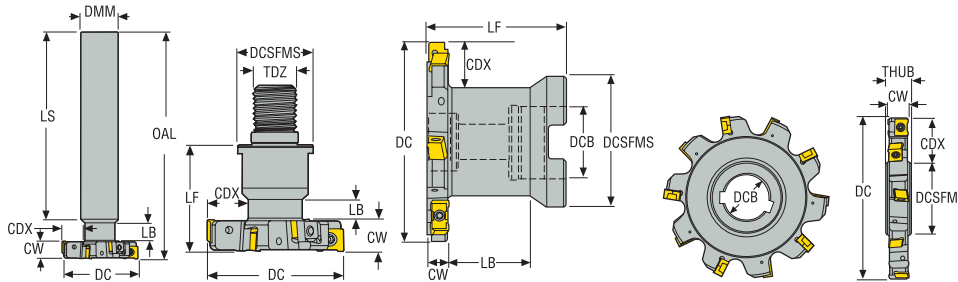

- For insert selection and cutting data recommendations, see page(s) 469-470
- For complete insert programme, see page(s) 833-834
- For spare parts and technical information, see page 462-468
- For ISO attribute explanation, see page 16

Designation	Item number	Type of mounting	DC	CW	CDX	ZEFP	ZNP	DMM	TDZ	DCB	DCSFMS	OAL	THUB	LF	LS	LB	RPMX	Weight	Insert
			mm	mm	mm			mm		mm	mm	mm	mm	mm	mm	mm		kg	
R335.18-1632.0-08.1N	02541821	Cylindrical	32,0	8,0	9,0	1	2	16,0	-	-	-	140,0	-	-	108,0	23,0	17300	0,3	LNK.05..
R335.18-1032.RE-08.2NA	03277891	Combimaster	32,0	8,0	8,4	2	4	-	M10	-	18,5	-	-	28,0	-	8,89	17300	0,1	LNK.05..
R335.18-2040.0-08.2N	02541822	Cylindrical	40,0	8,0	12,0	2	4	20,0	-	-	-	140,0	-	-	108,0	22,0	15400	0,4	LNK.05..
R335.18-1240.RE-08.2NA	03277893	Combimaster	40,0	8,0	11,2	2	4	-	M12	-	23,0	-	-	30,0	-	8,39	15400	0,2	LNK.05..
R335.18-1650.RE-08.3NA	03277895	Combimaster	50,0	8,0	14,2	3	6	-	M16	-	30,0	-	-	35,0	-	10,59	13800	0,2	LNK.05..
R335.18-2550.0-08.3N	02541829	Cylindrical	50,0	8,0	15,0	3	6	25,0	-	-	-	150,0	-	-	110,0	29,5	13800	0,6	LNK.05..
R335.18-2063.RE-08.4NA	03277897	Combimaster	63,0	8,0	15,0	4	8	-	M20	-	36,5	-	-	40,0	-	14,89	12300	0,4	LNK.05..
R335.18-3263.0-08.3N	02541831	Cylindrical	63,0	8,0	15,5	3	6	32,0	-	-	-	170,0	-	-	155,0	0,0	12300	1,2	LNK.05..
R335.18-063.08.22-3N	02541815	Arbor	63,0	8,0	15,0	3	6	-	-	22,0	40,0	-	-	50,0	-	28,9	12300	0,4	LNK.05..
R335.18-080.08.22-4N	02541817	Arbor	80,0	8,0	23,5	4	8	-	-	22,0	40,0	-	-	50,0	-	28,9	10900	0,5	LNK.05..
R335.18-100.08.27-5N	02541818	Arbor	100,0	8,0	25,0	5	10	-	-	27,0	48,0	-	-	50,0	-	0,0	9700	0,8	LNK.05..
335.18-100.08.27-5N	02541812	Arbor hole	100,0	8,0	27,9	5	10	-	-	27,0	41,0	-	15,0	11,5	-	-	9700	0,4	LNK.05..
R335.18-125.08.32-6N	02541819	Arbor	125,0	8,0	34,0	6	12	-	-	32,0	58,0	-	-	50,0	-	0,0	8400	1,0	LNK.05..
R335.18-1032.RE-10.2NA	03277892	Combimaster	32,0	10,0	8,5	2	4	-	M10	-	18,5	-	-	28,0	-	6,89	17300	0,1	LNK.05..
R335.18-1632.0-10.1N-LN05	02541833	Cylindrical	32,0	10,0	9,0	1	2	16,0	-	-	-	140,0	-	-	108,0	21,0	17300	0,3	LNK.05..
R335.18-1240.RE-10.2NA	03277894	Combimaster	40,0	10,0	11,5	2	4	-	M12	-	23,0	-	-	30,0	-	6,39	15400	0,2	LNK.05..
R335.18-2040.0-10.2N-LN05	02541834	Cylindrical	40,0	10,0	12,0	2	4	20,0	-	-	-	140,0	-	-	108,0	20,0	15400	0,4	LNK.05..
R335.18-2040.0-10.2N	02449072	Cylindrical	40,0	10,0	12,0	2	4	20,0	-	-	-	140,0	-	-	108,0	20,0	14900	0,4	LNK.06..
R335.18-1650.RE-10.3NA	03279026	Combimaster	50,0	10,0	14,4	3	6	-	M16	-	30,0	-	-	35,0	-	8,59	13400	0,3	LNK.06..
R335.18-2550.0-10.3N	02449095	Cylindrical	50,0	10,0	15,0	3	6	25,0	-	-	-	150,0	-	-	110,0	27,5	13400	0,6	LNK.06..
R335.18-2063.RE-10.4NA	03277898	Combimaster	63,0	10,0	15,1	4	8	-	M20	-	36,5	-	-	40,0	-	12,89	11900	0,4	LNK.06..
R335.18-3263.0-10.3N	02449097	Cylindrical	63,0	10,0	15,5	3	6	32,0	-	-	-	170,0	-	-	155,0	0,0	11900	1,2	LNK.06..
R335.18-063.10.22-3N	00039922	Arbor	63,0	10,0	15,0	3	6	-	-	22,0	40,0	-	-	50,0	-	27,0	11900	0,4	LNK.06..
R335.18-3280.0-10.4N	02449098	Cylindrical	80,0	10,0	24,0	4	8	32,0	-	-	-	170,0	-	-	155,0	0,0	10500	1,3	LNK.06..
R335.18-080.10.22-4N	00039923	Arbor	80,0	10,0	23,5	4	8	-	-	22,0	40,0	-	-	50,0	-	27,0	10500	0,5	LNK.06..
335.18-080.10.27-4N	02449039	Arbor hole	80,0	10,0	19,0	4	8	-	-	27,0	41,0	-	15,0	12,5	-	-	10500	0,3	LNK.06..
R335.18-100.10.27-5N	00039924	Arbor	100,0	10,0	26,0	5	10	-	-	27,0	48,0	-	-	50,0	-	-	9400	0,9	LNK.06..
335.18-100.10.27-5N	02449040	Arbor hole	100,0	10,0	28,0	5	10	-	-	27,0	41,0	-	15,0	12,5	-	-	9400	0,4	LNK.06..
R335.18-125.10.32-6N	02448768	Arbor	125,0	10,0	34,0	6	12	-	-	32,0	58,0	-	-	50,0	-	0,0	8400	1,1	LNK.06..

Spare Parts, included in delivery

Accessories

For cutter	Arbor screw	Insert key	Insert screw	Insert clamping torque	Torque key
335.18 / R335.18 .RE / R335.18 .0 CW=8	-	H4B-T08P	C02508-T08P	1.2NM	T00-08P12
R335.18 DCB=22 CW=08	MC6S10X40	H4B-T08P	C02508-T08P	1.2NM	T00-08P12
R335.18 DCB=27 CW=08	MC6S12X40	H4B-T08P	C02508-T08P	1.2NM	T00-08P12
R335.18 DCB=32 CW=08	-	H4B-T08P	C02508-T08P	1.2NM	T00-08P12
R335.18 .RE / R335.18 .0 CW=10 LN..05	-	H4B-T08P	C02508-T08P	1.2NM	T00-08P12
335.18 / R335.18 .RE / R335.18 .0 CW=10 LN..06	-	H4B-T09P	C73007-T09P	2.0NM	T00-09P20
R335.18 DCB=22 CW=10	MC6S10X40	H4B-T09P	C73007-T09P	2.0NM	T00-09P20
R335.18 DCB=27 CW=10	MC6S12X40	H4B-T09P	C73007-T09P	2.0NM	T00-09P20
R335.18 DCB=32 CW=10	-	H4B-T09P	C73007-T09P	2.0NM	T00-09P20

Square shoulder and slot milling cutters

Helical milling cutters

Face milling cutters

Disc milling cutters

High feed milling cutters

Copy milling cutters

Plunge milling cutters

Chamfer milling cutters

Spot facing cutters

Inserts

Cutter 335.18 - Insert LNK. – Metric

Width 12/14 mm - full side - Fixed pocket

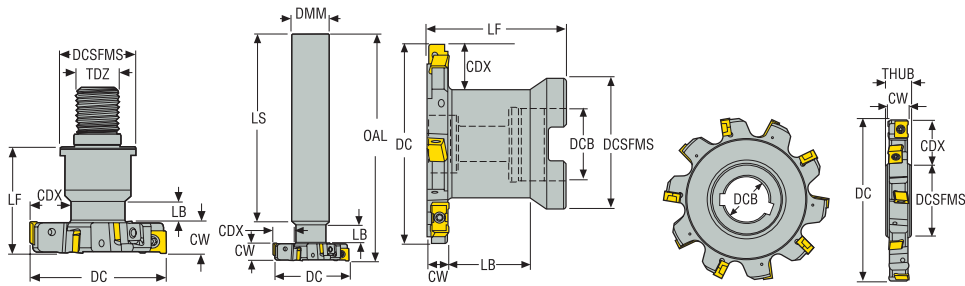

- For insert selection and cutting data recommendations, see page(s) 469-470
- For complete insert programme, see page(s) 833-834
- For spare parts and technical information, see page 462-468
- For ISO attribute explanation, see page 16

Designation	Item number	Type of mounting	DC	CW	CDX	ZFP	ZNP	DMM	TDZ	DCB	DCSFMS	OAL	THUB	LF	LS	LB	RPMX	Weight	Insert
			mm	mm	mm		mm	mm	mm	mm	mm	mm	mm	mm	mm	mm	mm	mm	kg
R335.18-2550.0-12.3N	02449125	Cylindrical	50,0	12,0	15,0	3	6	25,0	-	-	-	150,0	-	-	110,0	25,5	13400	0,6	LNK.06..
R335.18-1650.RE-12.3NA	03277896	Combimaster	50,0	12,0	14,5	3	6	-	M16	-	30,0	-	-	35,0	-	6,59	13400	0,3	LNK.06..
R335.18-3263.0-12.3N	02449176	Cylindrical	63,0	12,0	15,5	3	6	32,0	-	-	-	170,0	-	-	155,0	0,0	11900	1,2	LNK.06..
R335.18-063.12.22-3N	00039925	Arbor	63,0	12,0	15,0	3	6	-	-	22,0	40,0	-	-	50,0	-	25,0	11900	0,4	LNK.06..
R335.18-2063.RE-12.4NA	03277899	Combimaster	63,0	12,0	14,9	4	8	-	M20	-	36,5	-	-	40,0	-	10,47	11900	0,4	LNK.06..
R335.18-3280.0-12.4N	02449178	Cylindrical	80,0	12,0	24,0	4	8	32,0	-	-	-	170,0	-	-	155,0	0,0	10500	1,3	LNK.06..
R335.18-080.12.22-4N	00039926	Arbor	80,0	12,0	23,5	4	8	-	-	22,0	40,0	-	-	50,0	-	25,0	10500	0,8	LNK.06..
335.18-080.12.27-4N	02449043	Arbor hole	80,0	12,0	19,0	4	8	-	-	27,0	41,0	-	15,0	13,5	-	-	10500	0,3	LNK.06..
R335.18-100.12.27-5N	00039927	Arbor	100,0	12,0	26,0	5	10	-	-	27,0	48,0	-	-	50,0	-	0,0	9400	0,9	LNK.06..
335.18-100.12.27-5N	02449044	Arbor hole	100,0	12,0	28,0	5	10	-	-	27,0	41,0	-	15,0	13,5	-	-	9400	0,5	LNK.06..
R335.18-125.12.32-6N	02448769	Arbor	125,0	12,0	34,0	6	12	-	-	32,0	58,0	-	-	50,0	-	0,0	8400	1,1	LNK.06..
335.18-125.12.40-6N	02449045	Arbor hole	125,0	12,0	33,0	6	12	-	-	40,0	55,0	-	15,0	13,5	-	-	8400	0,8	LNK.06..
R335.18-063.14.22-3N	00039928	Arbor	63,0	14,0	15,0	3	6	-	-	22,0	40,0	-	-	50,0	-	23,0	11900	0,4	LNK.08..
R335.18-080.14.22-4N	00039929	Arbor	80,0	14,0	23,5	4	8	-	-	22,0	40,0	-	-	50,0	-	23,0	10500	0,6	LNK.08..
R335.18-100.14.27-5N	00039930	Arbor	100,0	14,0	26,0	5	10	-	-	27,0	48,0	-	-	50,0	-	0,0	9400	1,0	LNK.08..
R335.18-125.14.32-6N	02448771	Arbor	125,0	14,0	34,0	6	12	-	-	32,0	58,0	-	-	50,0	-	0,0	8400	1,3	LNK.08..
335.18-160.14.40-7N	02449047	Arbor hole	160,0	14,0	51,0	7	14	-	-	40,0	55,0	-	15,0	14,5	-	-	7500	1,6	LNK.08..

Spare Parts, included in delivery

Accessories

For cutter	Arbor screw	Insert key	Insert screw	Insert clamping torque	Torque key
335.18 / R335.18 .RE/R335.18 .0	-	H4B-T09P	C73007-T09P	2.0NM	T00-09P20
R335.18 DCB=22	MC6S10X40	H4B-T09P	C73007-T09P	2.0NM	T00-09P20
R335.18 DCB=27	MC6S12X40	H4B-T09P	C73007-T09P	2.0NM	T00-09P20
R335.18 DCB=32	-	H4B-T09P	C73007-T09P	2.0NM	T00-09P20

Width 17/20 mm - full side - Fixed pocket

Cutter 335.18 - Insert LNK. – Metric

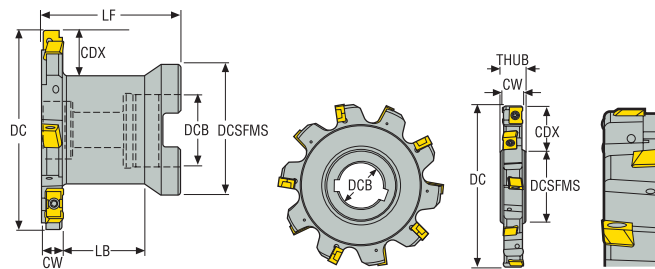

- For insert selection and cutting data recommendations, see page(s) 469-470
- For complete insert programme, see page(s) 833-834
- For spare parts and technical information, see page 462-468
- For ISO attribute explanation, see page 16

Designation	Item number	Type of mounting	DC	CW	CDX	ZFP	ZNP	DCB	DCSFMS	THUB	LF	LB	RPMX	Weight	Insert
			mm	mm	mm			mm	mm	mm	mm	mm		kg	
R335.18-080.17.22-3N	02469590	Arbor	80,0	17,0	24,0	3	9	22,0	40,0	–	50,0	20,0	10500	0,6	LNK.06..
R335.18-125.17.32-4N	02469592	Arbor	125,0	17,0	33,5	4	12	32,0	58,0	–	50,0	0,0	8400	1,4	LNK.06..
335.18-125.17.40-4N	02469602	Arbor hole	125,0	17,0	33,0	4	12	40,0	55,0	20,0	18,5	–	8400	1,1	LNK.06..
R335.18-160.17.40-5N	02469593	Arbor	160,0	17,0	45,0	5	15	40,0	70,0	–	50,0	0,0	7500	2,4	LNK.06..
335.18-160.17.40-5N	02469603	Arbor hole	160,0	17,0	50,7	5	15	40,0	55,0	20,0	18,5	–	7500	1,9	LNK.06..
R335.18-080.20.22-4N	02469597	Arbor	80,0	20,0	24,0	4	12	22,0	40,0	–	50,0	16,9	10500	0,7	LNK.08..
R335.18-100.20.27-5N	02469598	Arbor	100,0	20,0	26,0	5	15	27,0	48,0	–	50,0	0,0	9400	1,2	LNK.08..
R335.18-125.20.32-6N	02469599	Arbor	125,0	20,0	33,5	6	18	32,0	58,0	–	50,0	0,0	8400	1,6	LNK.08..
335.18-125.20.40-6N	02469604	Arbor hole	125,0	20,0	34,0	6	18	40,0	55,0	20,0	20,0	–	8400	1,2	LNK.08..
R335.18-160.20.40-7N	02469600	Arbor	160,0	20,0	45,0	7	21	40,0	70,0	–	50,0	0,0	7500	2,7	LNK.08..

Spare Parts, included in delivery

Accessories

For cutter	Arbor screw	Insert key	Insert screw	Insert clamping torque	Torque key
R335.18 DCB=22	MC6S10X40	H4B-T09P	C73007-T09P	2.0NM	T00-09P20
335.18 DCB=40 / R335.18 DCB=32/40	–	H4B-T09P	C73007-T09P	2.0NM	T00-09P20
R335.18 DCB=27	MC6S12X40	H4B-T09P	C73007-T09P	2.0NM	T00-09P20

Square shoulder and slot milling cutters

Helical milling cutters

Face milling cutters

Disc milling cutters

High feed milling cutters

Copy milling cutters

Plunge milling cutters

Chamfer milling cutters

Spot facing cutters

Inserts

Cutter 335.18 - Insert LNK. – inch

Width 0.312-0.375" - full side - Fixed pocket

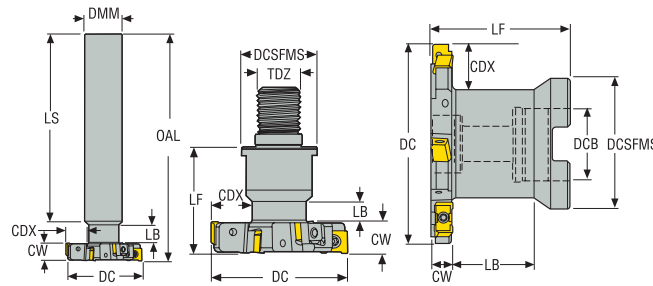

- For insert selection and cutting data recommendations, see page(s) 469-470
- For complete insert programme, see page(s) 833-834
- For spare parts and technical information, see page 462-468
- For ISO attribute explanation, see page 16

Designation	Item number	Type of mounting	DC	CW	CDX	ZEFP	ZNP	DMM	TDZ	DCB	DCSFMS	OAL	THUB	LF	LS	LB	RPMX	Weight	Insert
			inch	inch	inch		inch	inch	inch	inch	inch	inch	inch	inch	inch	inch	inch	inch	lbs
R335.18-01.25-RE-0.31F-2NA	03277900	Combimaster	1.250	0.312	0.323	2	4	–	M10	–	0.728	–	–	1.102	–	0.353	17300	0.440	LNK.05..
R335.18-1.25-0-0.31F-1N	02541852	Cylindrical	1.250	0.312	0.350	1	2	0.625	–	–	–	5.500	–	–	4.398	0.748	17300	0.660	LNK.05
R335.18-01.50-RE-0.31F-2NA	03277902	Combimaster	1.500	0.312	0.406	2	4	–	M12	–	0.906	–	–	1.181	–	0.333	15400	0.440	LNK.05..
R335.18-1.50-0-0.31F-2N	02541853	Cylindrical	1.500	0.312	0.409	2	4	0.750	–	–	–	5.500	–	–	4.398	0.748	15400	0.880	LNK.05
R335.18-02.00-RE-0.31F-3NA	03277904	Combimaster	2.000	0.312	0.575	3	6	–	M16	–	1.181	–	–	1.378	–	0.420	13800	0.660	LNK.05..
R335.18-2.00-0-0.31F-3N	02541854	Cylindrical	2.000	0.312	0.591	3	6	1.000	–	–	–	6.000	–	–	4.398	1.197	13800	1.540	LNK.05
R335.18-02.50-0-0.31F-3N	02541842	Arbor	2.500	0.312	0.598	3	6	–	–	0.750	1.580	–	–	2.000	–	1.209	12300	0.880	LNK.05
R335.18-2.50-0-0.31F-3N	02541856	Cylindrical	2.500	0.312	0.626	3	6	1.250	–	–	–	6.750	–	–	6.437	–	12300	2.650	LNK.05
R335.18-03.00-0-0.31F-4N	02541843	Arbor	3.000	0.312	0.713	4	8	–	–	1.000	1.880	–	–	2.000	–	1.150	10900	1.320	LNK.05
R335.18-04.00-0-0.31F-5N	02541844	Arbor	4.000	0.312	1.059	5	10	–	–	1.000	1.880	–	–	2.000	–	–	9700	1.980	LNK.05
R335.18-05.00-0-0.31F-6N	02541845	Arbor	5.000	0.312	1.378	6	12	–	–	1.250	2.250	–	–	2.000	–	–	8400	2.200	LNK.05
R335.18-1.25-0-0.37F-1N	02541858	Cylindrical	1.250	0.375	0.350	1	2	0.625	–	–	–	5.500	–	–	4.398	0.685	17300	0.660	LNK.05
R335.18-01.50-RE-0.37F-2NA	03277903	Combimaster	1.500	0.375	0.413	2	4	–	M12	–	0.906	–	–	1.181	–	0.270	15400	0.440	LNK.05..
R335.18-1.50-0-0.37F-2N	02541859	Cylindrical	1.500	0.375	0.413	2	4	0.750	–	–	–	5.500	–	–	4.398	0.685	15400	0.880	LNK.05
R335.18-02.00-RE-0.37F-3NA	03277905	Combimaster	2.000	0.375	0.587	3	6	–	M16	–	1.181	–	–	1.378	–	0.357	13800	0.660	LNK.05..
R335.18-2.00-0-0.37F-3N	02541860	Cylindrical	2.000	0.375	0.591	3	6	1.000	–	–	–	6.000	–	–	4.398	1.134	13800	1.540	LNK.05
R335.18-02.50-0-0.37F-3N	02541846	Arbor	2.500	0.375	0.598	3	6	–	–	0.750	1.580	–	–	2.000	–	1.146	12300	0.880	LNK.05
R335.18-2.50-0-0.37F-3N	02541861	Cylindrical	2.500	0.375	0.626	3	6	1.250	–	–	–	6.750	–	–	6.437	–	12300	2.650	LNK.05
R335.18-03.00-0-0.37F-4N	02541847	Arbor	3.000	0.375	0.713	4	8	–	–	1.000	1.880	–	–	2.000	–	1.087	10900	1.320	LNK.05
R335.18-04.00-0-0.37F-5N	02541848	Arbor	4.000	0.375	1.059	5	10	–	–	1.000	1.880	–	–	2.000	–	–	9700	2.200	LNK.05
R335.18-05.00-0-0.37F-6N	02541849	Arbor	5.000	0.375	1.378	6	12	–	–	1.250	2.250	–	–	2.000	–	–	8400	2.200	LNK.05

Spare Parts, included in delivery

Accessories

For cutter	Arbor screw	Insert key	Insert screw	Insert clamping torque	Torque key
R335 -RE- / R335.18 -0-	–	H4B-T08P	C02508-T08P	10.6IN.LBS	T00-08P12
R335.18 DCB=0.750	UC6S3/8UNFX1-3/4	H4B-T08P	C02508-T08P	10.6IN.LBS	T00-08P12
R335.18 DCB=1.000	UC6S1/2UNFX1-1/2	H4B-T08P	C02508-T08P	10.6IN.LBS	T00-08P12
R335.18 DCB=1.250	–	H4B-T08P	C02508-T08P	10.6IN.LBS	T00-08P12

Width 0.500/0.625/ 0.750" - full side - Fixed pocket

Cutter 335.18 - Insert LNK. – inch

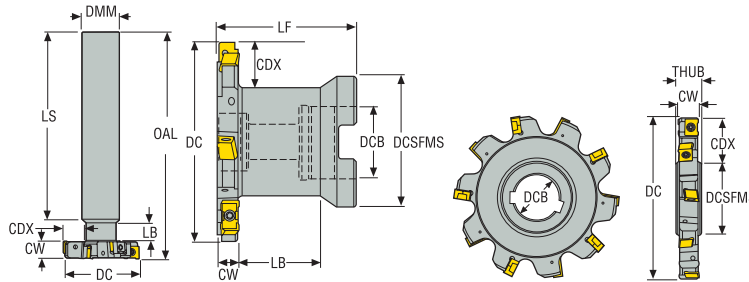

- For insert selection and cutting data recommendations, see page(s) 469-470
- For complete insert programme, see page(s) 833-834
- For spare parts and technical information, see page 462-468
- For ISO attribute explanation, see page 16

Designation	Item number	Type of mounting	DC	CW	CDX	ZEPF	ZNP	DMM	DCB	DCSFMS	OAL	THUB	LF	LS	LB	RPMX	Weight	Insert
			inch	inch	inch		inch	inch	inch	inch	inch	inch	inch	inch	inch	inch	inch	
R335.18-02.00-0-0.50F-3N	02479049	Cylindrical	2.000	0.500	0.591	3	6	1.000	-	-	6.000	-	-	4.402	1.008	13400	1.540	LNK.08
R335.18-02.00-RE-0.5F-3NA	03277906	Combimaster	2.000	0.500	0.587	3	6	-	-	1.181	-	-	1.378	-	0.232	13400	0.660	LNK.08..
R335.18-02.50-0-0.50F-3N	02479056	Cylindrical	2.500	0.500	0.626	3	6	1.250	-	-	6.750	-	-	6.142	-	11900	2.870	LNK.08
R335.18-02.50-0.50F-3N	02478983	Arbor	2.500	0.500	0.598	3	6	-	0.750	1.580	-	-	2.000	-	1.024	12300	1.100	LNK.08
R335.18-03.00-0-0.50F-4N	02479063	Cylindrical	3.000	0.500	0.874	4	8	1.250	-	-	6.750	-	-	6.142	-	10500	2.870	LNK.08
R335.18-03.00-0.50F-4N	02478988	Arbor	3.000	0.500	0.713	4	8	-	1.000	1.880	-	-	2.000	-	0.961	10500	1.540	LNK.08
335.18-03.00-0.50F-4N	02478872	Arbor hole	3.000	0.500	0.709	4	8	-	1.000	1.630	-	0.625	0.563	-	-	10900	0.660	LNK.08
R335.18-04.00-0.50F-5N	02478994	Arbor	4.000	0.500	1.059	5	10	-	1.000	1.880	-	-	2.000	-	-	9400	2.200	LNK.08
335.18-04.00-0.50F-5N	02478880	Arbor hole	4.000	0.500	1.142	5	10	-	1.000	1.630	-	0.625	0.563	-	-	9400	1.320	LNK.08
R335.18-05.00-0.50F-6N	02478999	Arbor	5.000	0.500	1.378	6	12	-	1.250	2.250	-	-	2.000	-	-	8400	2.650	LNK.08
335.18-06.00-0.50F-7N	02478901	Arbor hole	6.000	0.500	1.811	7	14	-	1.500	2.252	-	0.625	0.563	-	-	7500	2.870	LNK.08
R335.18-03.00-0.62F-3N	02479006	Arbor	3.000	0.625	0.709	3	9	-	1.000	1.880	-	-	2.000	-	0.827	10500	1.540	LNK.06
R335.18-04.00-0.62F-3N	02479012	Arbor	4.000	0.625	1.059	3	9	-	1.000	1.880	-	-	2.000	-	-	9400	2.650	LNK.06
R335.18-03.00-0.75F-3N	02479024	Arbor	3.000	0.750	0.709	3	9	-	1.000	1.880	-	-	2.000	-	0.709	10500	1.760	LNK.08
R335.18-04.00-0.75F-3N	02479032	Arbor	4.000	0.750	1.059	3	9	-	1.000	1.880	-	-	2.000	-	-	9400	2.870	LNK.08
R335.18-05.00-0.75F-4N	02479041	Arbor	5.000	0.750	1.378	4	12	-	1.250	2.250	-	-	2.000	-	-	8400	3.530	LNK.08

Spare Parts, included in delivery

Accessories

For cutter	Arbor screw	Insert key	Insert screw	Insert clamping torque	Torque key
335.18 / R335 -RE- / R335.18 -0-	-	H4B-T09P	C73007-T09P	17.7IN.LBS	T00-09P20
R335.18 DCB=0.750	UC6S3/8UNFX1-3/4	H4B-T09P	C73007-T09P	17.7IN.LBS	T00-09P20
R335.18 DCB=1.000	UC6S1/2UNFX1-1/2	H4B-T09P	C73007-T09P	17.7IN.LBS	T00-09P20
R335.18 DCB=1.250/1.500	-	H4B-T09P	C73007-T09P	17.7IN.LBS	T00-09P20

Square shoulder and slot milling cutters

Helical milling cutters

Face milling cutters

Disc milling cutters

High feed milling cutters

Copy milling cutters

Plunge milling cutters

Chamfer milling cutters

Spot facing cutters

Inserts

Cutter 335.18 - Insert LNK. – Metric

Width 8-12 mm - full side - Adjustable design

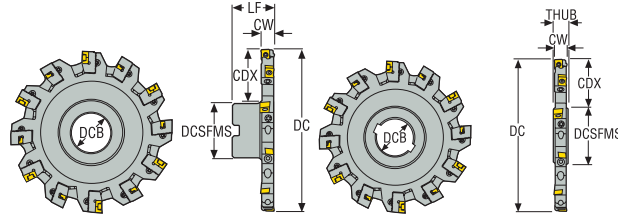

- For insert selection and cutting data recommendations, see page(s) 469-470
- For complete insert programme, see page(s) 833-834
- For spare parts and technical information, see page 462-468
- For ISO attribute explanation, see page 16

Designation	Item number	Type of mounting	DC	CWN	CWX	CDX	ZFP	ZNP	DCB	DCSFMS	THUB	LF	RPMX	Weight	Insert
			mm	mm	mm	mm			mm	mm	mm	mm		kg	
R335.18-080.0810.27-3N	02611694	Arbor	80,0	8,0	10,0	14,8	3	6	27,0	48,0	–	50,0	10900	0,7	LNK.05..
R335.18-100.0810.27-4N	02576013	Arbor	100,0	8,0	10,0	24,8	4	8	27,0	48,0	–	50,0	9400	0,8	LNK.05..
335.18-100.0810.27-4N	02575751	Arbor hole	100,0	8,0	10,0	27,2	4	8	27,0	41,0	15,0	11,5	9400	0,4	LNK.05..
R335.18-125.0810.32-5N	02576014	Arbor	125,0	8,0	10,0	32,3	5	10	32,0	58,0	–	50,0	8400	1,0	LNK.05..
335.18-125.0810.40-5N	02575752	Arbor hole	125,0	8,0	10,0	32,7	5	10	40,0	55,0	15,0	11,5	8400	0,6	LNK.05..
R335.18-160.0810.40-6N	02576015	Arbor	160,0	8,0	10,0	43,8	6	12	40,0	70,0	–	50,0	7500	1,6	LNK.05..
335.18-160.0810.40-6N	02575753	Arbor hole	160,0	8,0	10,0	50,2	6	12	40,0	55,0	15,0	11,5	7500	1,0	LNK.05..
R335.18-200.0810XL.40-7N	02713370	Arbor	200,0	8,0	10,0	53,5	7	14	40,0	90,0	–	50,0	6700	2,6	LNK.05..
335.18-200.0810XL.50-7N	02712923	Arbor hole	200,0	8,0	10,0	63,5	7	14	50,0	69,0	15,0	11,5	6700	1,4	LNK.05..
R335.18-250.0810XL.40-9N	02713381	Arbor	250,0	8,0	10,0	78,0	18	18	40,0	90,0	–	50,0	6000	4,4	LNK.05..
335.18-250.0810XL.50-9N	02712939	Arbor hole	250,0	8,0	10,0	88,5	9	18	50,0	69,0	15,0	11,5	6000	2,3	LNK.05..
335.18-315.0810XL.50-12N	02712948	Arbor hole	315,0	8,0	10,0	121,0	12	24	50,0	69,0	15,0	11,5	5300	2,4	LNK.05..
R335.18-080.1012.27-3N	00018581	Arbor	80,0	10,0	12,0	14,8	3	6	27,0	48,0	–	50,0	10500	0,7	LNK.06..
R335.18-100.1012.27-4N	00018597	Arbor	100,0	10,0	12,0	24,8	4	8	27,0	48,0	–	50,0	9400	0,9	LNK.06..
335.18-100.1012.27-4N	00018408	Arbor hole	100,0	10,0	12,0	27,2	4	8	27,0	41,0	15,0	12,5	9400	0,4	LNK.06..
R335.18-125.1012.32-5N	00018613	Arbor	125,0	10,0	12,0	32,3	5	10	32,0	58,0	–	50,0	8400	1,1	LNK.06..
335.18-125.1012.40-5N	00018417	Arbor hole	125,0	10,0	12,0	32,7	5	10	40,0	55,0	15,0	12,5	8400	0,7	LNK.06..
R335.18-160.1012.40-6N	00018641	Arbor	160,0	10,0	12,0	43,8	6	12	40,0	70,0	–	50,0	7500	1,7	LNK.06..
335.18-160.1012.40-6N	00018427	Arbor hole	160,0	10,0	12,0	50,2	6	12	40,0	55,0	15,0	12,5	7500	1,2	LNK.06..
R335.18-200.1012XL.40-7N	02713374	Arbor	200,0	10,0	12,0	53,5	7	14	40,0	90,0	–	50,0	6700	2,1	LNK.06..
335.18-200.1012XL.50-7N	02712930	Arbor hole	200,0	10,0	12,0	63,5	7	14	50,0	69,0	15,0	12,5	6700	1,5	LNK.06..
R335.18-250.1012XL.40-9N	02713382	Arbor	250,0	10,0	12,0	78,0	9	18	40,0	90,0	–	50,0	6000	2,3	LNK.06..
335.18-250.1012XL.50-9N	02712940	Arbor hole	250,0	10,0	12,0	88,5	9	18	50,0	69,0	15,0	12,5	6000	2,8	LNK.06..
335.18-315.1012XL.50-12N	02712950	Arbor hole	315,0	10,0	12,0	121,0	12	24	50,0	69,0	15,0	12,5	5300	4,5	LNK.06..

All listed adjustable cutters are set to the minimum cutter width CWN (factory setting).
Adjustable cutter may be ordered with the cutting width set to any value within its range (CWN - CWX), see technical data for more info at page 462

Width 12-15 mm - full side - Adjustable design

Cutter 335.18 - Insert LNK. – Metric

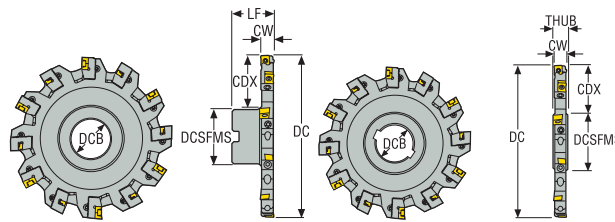

- For insert selection and cutting data recommendations, see page(s) 469-470
- For complete insert programme, see page(s) 833-834
- For spare parts and technical information, see page 462-468
- For ISO attribute explanation, see page 16

Designation	Item number	Type of mounting	DC	CWN	CWX	CDX	ZEP	ZNP	DCB	DCSFMS	THUB	LF	RPMX	Weight	Insert
			mm	mm	mm	mm			mm	mm	mm	mm		kg	
R335.18-080.1215.27-3N	00018712	Arbor	80,0	12,0	15,0	14,8	3	6	27,0	48,0	–	50,0	10500	0,7	LNK.08..
R335.18-100.1215.27-4N	00018734	Arbor	100,0	12,0	15,0	24,8	4	8	27,0	48,0	–	50,0	9400	0,9	LNK.08..
335.18-100.1215.27-4N	00018513	Arbor hole	100,0	12,0	15,0	27,2	4	8	27,0	41,0	15,0	13,5	9400	0,6	LNK.08..
R335.18-125.1215.32-5N	00018763	Arbor	125,0	12,0	15,0	32,3	5	10	32,0	58,0	–	50,0	8400	1,2	LNK.08..
335.18-125.1215.40-5N	00018535	Arbor hole	125,0	12,0	15,0	32,7	5	10	40,0	55,0	15,0	13,5	8400	0,8	LNK.08..
R335.18-160.1215.40-6N	00018782	Arbor	160,0	12,0	15,0	43,8	6	12	40,0	70,0	–	50,0	7500	1,9	LNK.08..
335.18-160.1215.40-6N	00018543	Arbor hole	160,0	12,0	15,0	50,2	6	12	40,0	55,0	15,0	13,5	7500	1,4	LNK.08..
R335.18-200.1215XL.40-7N	02713376	Arbor	200,0	12,0	15,0	53,5	7	14	40,0	90,0	–	50,0	6700	3,1	LNK.08..
335.18-200.1215XL.50-7N	02712932	Arbor hole	200,0	12,0	15,0	63,5	7	14	50,0	69,0	15,0	13,5	6700	2,0	LNK.08..
R335.18-250.1215XL.40-9N	02713383	Arbor	250,0	12,0	15,0	78,0	9	18	40,0	90,0	–	50,0	6000	4,4	LNK.08..
335.18-250.1215XL.50-9N	02712941	Arbor hole	250,0	12,0	15,0	88,5	9	18	50,0	69,0	15,0	13,5	6000	3,3	LNK.08..
335.18-315.1215XL.50-12N	02712951	Arbor hole	315,0	12,0	15,0	121,0	12	24	50,0	69,0	15,0	13,5	5300	5,5	LNK.08..

All listed adjustable cutters are set to the minimum cutter width CWN (factory setting).

Adjustable cutter may be ordered with the cutting width set to any value within its range (CWN - CWX), see technical data for more info at page 462

Square shoulder and slot milling cutters

Helical milling cutters

Face milling cutters

Disc milling cutters

High feed milling cutters

Copy milling cutters

Plunge milling cutters

Chamfer milling cutters

Spot facing cutters

Inserts

Cutter 335.18 - Insert LNK. – inch

Width 0.313-0.591" - full side - Adjustable design

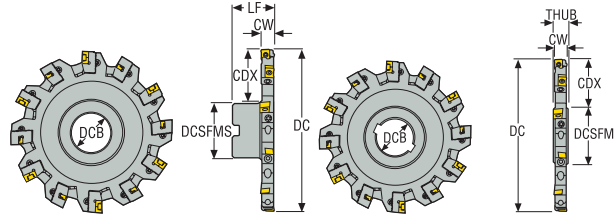

- For insert selection and cutting data recommendations, see page(s) 469-470
- For complete insert programme, see page(s) 833-834
- For spare parts and technical information, see page 462-468
- For ISO attribute explanation, see page 16

Designation	Item number	Type of mounting	DC	CWN	CWX	CDX	ZEP	ZNP	DCB	DCSFMS	THUB	LF	LB	RPMX	Weight	Insert
			inch	inch	inch	inch	inch	inch	inch	inch	inch	inch	inch			
R335.18-04.00-0506N	02834763	Arbor	4.000	0.312	0.394	1.024	4	8	1.000	1.880	–	2.000	–	9400	1.760	LNK.05
335.18-04.00-0506N	02834805	Arbor hole	4.000	0.315	0.394	1.102	4	8	1.000	1.551	0.625	0.470	–	9400	0.880	LNK.05
R335.18-05.00-0506N	02834764	Arbor	5.000	0.312	0.394	1.339	5	10	1.250	2.250	–	2.000	–	8400	2.650	LNK.05
335.18-05.00-0506N	02834810	Arbor hole	5.000	0.315	0.394	1.299	5	10	1.500	2.252	0.625	0.470	–	8400	1.320	LNK.05
R335.18-06.00-0506N	02834765	Arbor	6.000	0.312	0.394	1.575	6	12	1.500	2.750	–	2.000	–	7500	3.310	LNK.05
335.18-06.00-0506N	02834762	Arbor hole	6.000	0.315	0.394	1.772	6	12	1.500	2.252	0.625	0.470	–	7500	1.980	LNK.05
R335.18-08.00-XL0506N	02740895	Arbor	8.000	0.312	0.394	2.224	7	14	1.500	3.500	–	2.000	–	6700	6.170	LNK.05
335.18-08.00-XL0506N	02740202	Arbor hole	8.000	0.312	0.394	2.421	7	14	2.000	3.000	0.625	0.469	–	6700	3.310	LNK.05
R335.18-10.00-XL0506N	02741525	Arbor	10.000	0.312	0.394	3.209	9	18	1.500	3.500	–	2.000	–	6000	17.640	LNK.05
335.18-10.00-XL0506N	02740460	Arbor hole	10.000	0.312	0.394	3.386	9	18	2.000	3.000	0.625	0.469	–	6000	8.160	LNK.05
335.18-12.00-XL0506N	02740860	Arbor hole	12.000	0.312	0.394	4.390	11	22	2.000	3.000	0.625	0.469	–	5300	7.940	LNK.05
R335.18-04.00-0708N	00079782	Arbor	4.000	0.394	0.472	1.014	4	8	1.000	1.880	–	2.000	–	9400	2.200	LNK.06
R335.18-05.00-0708N	00079783	Arbor	5.000	0.394	0.472	1.329	5	10	1.250	2.250	–	2.000	–	8400	3.090	LNK.06
335.18-05.00-0708N	00079701	Arbor hole	5.000	0.394	0.472	1.258	5	10	1.500	2.252	0.625	0.509	–	8400	1.760	LNK.06
R335.18-06.00-0708N	00079784	Arbor	6.000	0.394	0.472	1.534	6	12	1.500	2.750	–	2.000	–	7500	3.750	LNK.06
335.18-06.00-0708N	00079702	Arbor hole	6.000	0.394	0.472	1.766	6	12	1.500	2.252	0.625	0.509	–	7500	2.430	LNK.06
R335.18-08.00-XL0708N	02740896	Arbor	8.000	0.394	0.472	2.224	7	14	1.500	3.500	–	2.000	–	6700	2.870	LNK.06
335.18-08.00-XL0708N	02740235	Arbor hole	8.000	0.394	0.472	2.421	7	14	2.000	3.000	0.625	0.509	–	6700	3.970	LNK.06
R335.18-10.00-XL0708N	02741541	Arbor	10.000	0.394	0.472	3.209	9	18	1.500	3.500	–	2.000	–	6000	18.960	LNK.06
335.18-10.00-XL0708N	02740497	Arbor hole	10.000	0.394	0.472	3.386	9	18	2.000	3.000	0.625	0.509	–	6000	9.260	LNK.06
335.18-12.00-XL0708N	02740866	Arbor hole	12.000	0.394	0.472	4.390	11	22	2.000	3.000	0.625	0.509	–	5300	9.700	LNK.06
R335.18-04.00-0809N	00079963	Arbor	4.000	0.472	0.591	1.014	4	8	1.000	1.880	–	2.000	–	9400	2.430	LNK.08
R335.18-05.00-0809N	00079964	Arbor	5.000	0.472	0.591	1.329	5	10	1.250	2.250	–	2.000	–	8400	3.530	LNK.08
335.18-05.00-0809N	00079932	Arbor hole	5.000	0.472	0.591	1.285	5	10	1.500	2.252	0.625	0.549	–	8400	1.980	LNK.08
R335.18-06.00-0809N	00079965	Arbor	6.000	0.472	0.591	1.585	6	12	1.500	2.750	–	2.000	–	7500	4.190	LNK.08
335.18-06.00-0809N	00079933	Arbor hole	6.000	0.472	0.591	1.790	6	12	1.500	2.252	0.625	0.549	–	7500	2.870	LNK.08
R335.18-08.00-XL0809N	02740897	Arbor	8.000	0.472	0.591	2.224	7	14	1.500	3.500	–	2.000	–	6700	8.600	LNK.08
335.18-08.00-XL0809N	02740236	Arbor hole	8.000	0.472	0.591	2.421	7	14	2.000	3.000	0.625	0.549	–	6700	7.280	LNK.08
R335.18-10.00-XL0809N	02741544	Arbor	10.000	0.472	0.591	3.209	9	18	1.500	3.500	–	2.000	–	6000	2.870	LNK.08
335.18-10.00-XL0809N	02740498	Arbor hole	10.000	0.472	0.591	3.386	9	18	2.000	3.000	0.625	0.549	–	6000	7.940	LNK.08
335.18-12.00-XL0809N	02740867	Arbor hole	12.000	0.472	0.591	4.390	11	22	2.000	3.000	0.625	0.549	–	5300	15.430	LNK.08

All listed adjustable cutters are set to the minimum cutter width CWN (factory setting).
Adjustable cutter may be ordered with the cutting width set to any value within its range (CWN - CWX), see technical data for more info at page 462

Width 8-12 mm - full side - radius profile - Adjustable design

Cutter 335.18 - Insert RD..08/RD..10T3 – Metric

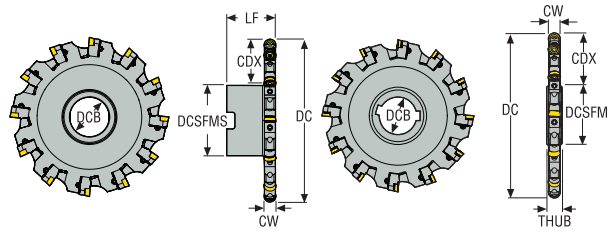

- For insert selection and cutting data recommendations, see page(s) 485-490
- For complete insert programme, see page(s) 839
- For spare parts and technical information, see page 462-468
- For ISO attribute explanation, see page 16

Designation	Item number	Type of mounting	DC	CWN	CWX	CDX	ZEFP	DCB	DCSFMS	THUB	LF	RPMX	Weight	Insert
			mm	mm	mm	mm		mm	mm	mm	mm		kg	
R335.18-080.0810.27-6N-R4	02611700	Arbor	82,0	8,0	10,0	15,8	6	27,0	48,0	-	50,0	10500	0,7	RD..08..
R335.18-100.0810.27-8N-R4	02576017	Arbor	102,0	8,0	10,0	25,8	8	27,0	48,0	-	50,0	9400	0,8	RD..08..
335.18-100.0810.27-8N-R4	02575800	Arbor hole	102,0	8,0	10,0	28,2	8	27,0	41,0	15,0	11,5	9400	0,4	RD..08..
R335.18-125.0810.32-10N-R4	02576018	Arbor	127,0	8,0	10,0	32,3	10	32,0	58,0	-	50,0	8400	1,0	RD..08..
335.18-125.0810.40-10N-R4	02575801	Arbor hole	127,0	8,0	10,0	33,7	10	40,0	55,0	15,0	11,5	8400	0,6	RD..08..
R335.18-160.0810.40-12N-R4	02576020	Arbor	162,0	8,0	10,0	44,8	12	40,0	70,0	-	50,0	7500	1,6	RD..08..
335.18-160.0810.40-12N-R4	02575802	Arbor hole	162,0	8,0	10,0	51,2	12	40,0	55,0	15,0	11,5	7500	1,0	RD..08..
R335.18-200.0810XL.40-14N-R4	02713377	Arbor	200,0	8,0	10,0	53,5	14	40,0	90,0	-	50,0	6700	2,6	RD..08..
335.18-200.0810XL.50-14N-R4	02712934	Arbor hole	200,0	8,0	10,0	63,5	14	50,0	69,0	15,0	11,5	6700	1,4	RD..08..
R335.18-250.0810XL.40-18N-R4	02713384	Arbor	250,0	8,0	10,0	78,0	18	40,0	90,0	-	50,0	6000	3,5	RD..08..
335.18-250.0810XL.50-18N-R4	02712943	Arbor hole	250,0	8,0	10,0	88,5	18	50,0	69,0	15,0	11,5	6000	2,3	RD..08..
335.18-315.0810XL.50-24N-R4	02712952	Arbor hole	315,0	8,0	10,0	121,0	24	50,0	69,0	15,0	11,5	5300	3,7	RD..08..
R335.18-080.1012.27-3N-R5	00030352	Arbor	82,0	10,0	12,0	15,8	3	27,0	48,0	-	50,0	10500	0,7	RD..10T3
R335.18-100.1012.27-4N-R5	00030355	Arbor	102,0	10,0	12,0	25,8	4	27,0	48,0	-	50,0	9400	0,9	RD..10T3
335.18-100.1012.27-4N-R5	00030328	Arbor hole	102,0	10,0	12,0	28,2	4	27,0	41,0	15,0	12,5	9400	0,6	RD..10T3
R335.18-125.1012.32-5N-R5	00030359	Arbor	127,0	10,0	12,0	33,3	5	32,0	58,0	-	50,0	8400	1,1	RD..10T3
335.18-125.1012.40-5N-R5	00030340	Arbor hole	127,0	10,0	12,0	33,7	5	40,0	55,0	15,0	12,5	8400	0,7	RD..10T3
R335.18-160.1012.40-6N-R5	00030362	Arbor	162,0	10,0	12,0	44,8	6	40,0	70,0	-	50,0	7500	1,7	RD..10T3
335.18-160.1012.40-6N-R5	00030343	Arbor hole	162,0	10,0	12,0	51,2	6	40,0	55,0	15,0	12,5	7500	1,3	RD..10T3
R335.18-200.1012XL.40-7N-R5	02713379	Arbor	200,0	10,0	12,0	53,5	7	40,0	90,0	-	50,0	6700	2,2	RD..10T3
335.18-200.1012XL.50-7N-R5	02712935	Arbor hole	200,0	10,0	12,0	63,5	7	50,0	69,0	15,0	12,5	6700	1,7	RD..10T3
R335.18-250.1012XL.40-9N-R5	02713386	Arbor	250,0	10,0	12,0	78,0	9	40,0	90,0	-	50,0	6000	4,0	RD..10T3
335.18-250.1012XL.50-9N-R5	02712946	Arbor hole	250,0	10,0	12,0	88,5	9	50,0	69,0	15,0	12,5	6000	1,7	RD..10T3
335.18-315.1012XL.50-12N-R5	02712954	Arbor hole	315,0	10,0	12,0	121,0	12	50,0	69,0	15,0	12,5	5300	4,6	RD..10T3

All listed adjustable cutters are set to the minimum cutter width CWN (factory setting).

Adjustable cutter may be ordered with the cutting width set to any value within its range (CWN - CWX), see technical data for more info at page 462

Square shoulder and slot milling cutters

Helical milling cutters

Face milling cutters

Disc milling cutters

High feed milling cutters

Copy milling cutters

Plunge milling cutters

Chamfer milling cutters

Spot facing cutters

Inserts

Cutter 335.18 - Insert RP..1204 – Metric

Width 12-15 mm - full side - radius profile - Adjustable design

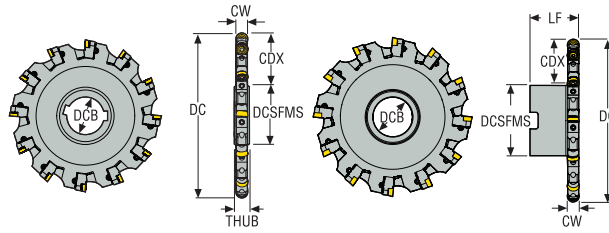

- For insert selection and cutting data recommendations, see page(s) 491-493
- For complete insert programme, see page(s) 841
- For spare parts and technical information, see page 462-468
- For ISO attribute explanation, see page 16

Designation	Item number	Type of mounting	DC	CWN	CWX	CDX	ZEFP	DCB	DCSFMS	THUB	LF	RPMX	Weight	Insert
			mm	mm	mm	mm		mm	mm	mm	mm		kg	
R335.18-080.1215.27-3N-R6	00030404	Arbor	82,0	12,0	15,0	15,8	3	27,0	48,0	–	50,0	10000	0,7	RP..1204
R335.18-100.1215.27-4N-R6	00030412	Arbor	102,0	12,0	15,0	25,8	4	27,0	48,0	–	50,0	9400	0,9	RP..1204
335.18-100.1215.27-4N-R6	00030370	Arbor hole	102,0	12,0	15,0	28,2	4	27,0	41,0	15,0	13,5	9400	0,8	RP..1204
R335.18-125.1215.32-5N-R6	00030417	Arbor	127,0	12,0	15,0	33,3	5	32,0	58,0	–	50,0	8400	1,2	RP..1204
335.18-125.1215.40-5N-R6	00030374	Arbor hole	127,0	12,0	15,0	33,7	5	40,0	55,0	15,0	13,5	8400	0,9	RP..1204
R335.18-160.1215.40-6N-R6	00030420	Arbor	162,0	12,0	15,0	44,8	6	40,0	70,0	–	50,0	7500	1,9	RP..1204
335.18-160.1215.40-6N-R6	00030377	Arbor hole	162,0	12,0	15,0	51,2	6	40,0	55,0	15,0	13,5	7500	1,5	RP..1204
R335.18-200.1215XL.40-7N-R6	02713380	Arbor	200,0	12,0	15,0	53,5	7	40,0	90,0	–	50,0	6700	3,2	RP..1204
335.18-200.1215XL.50-7N-R6	02712937	Arbor hole	200,0	12,0	15,0	63,5	7	50,0	69,0	15,0	13,5	6700	2,0	RP..1204
R335.18-250.1215XL.40-9N-R6	02713387	Arbor	250,0	12,0	15,0	78,0	9	40,0	90,0	–	50,0	6000	4,5	RP..1204
335.18-250.1215XL.50-9N-R6	02712947	Arbor hole	250,0	12,0	15,0	88,5	9	50,0	69,0	15,0	13,5	6000	3,4	RP..1204
335.18-315.1215XL.50-12N-R6	02712955	Arbor hole	315,0	12,0	15,0	121,0	12	50,0	69,0	15,0	13,5	5300	5,5	RP..1204

All listed adjustable cutters are set to the minimum cutter width CWN (factory setting).
Adjustable cutter may be ordered with the cutting width set to any value within its range (CWN - CWX), see technical data for more info at page 462

Width 0.315-0.472" - full side - radius profile - Adjustable design

Cutter 335.18 - Insert RD..08/RD..10/RP..12 – inch

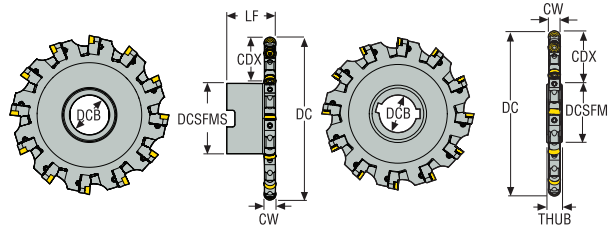

- For insert selection and cutting data recommendations, see page(s) 485-493
- For complete insert programme, see page(s) 839
- For spare parts and technical information, see page 462-468
- For ISO attribute explanation, see page 16

Designation	Item number	Type of mounting	DC	CWN	CWX	CDX	ZEFP	DCB	DCSFMS	THUB	LF	RPMX	Weight	Insert
			inch	inch	inch	inch		inch	inch	inch	inch		lbs	
R335.18-04.00-0506N-R4	02834713	Arbor	4.079	0.315	0.394	1.063	4	1.000	1.880	–	2.000	9400	1.760	RD..08
335.18-04.00-0506N-R4	02834707	Arbor hole	4.079	0.315	0.394	1.142	4	1.000	1.551	0.625	0.470	9400	0.880	RD..08
R335.18-05.00-0506N-R4	02834714	Arbor	5.079	0.315	0.394	1.378	5	1.250	2.250	–	2.000	8400	2.650	RD..08
335.18-05.00-0506N-R4	02834708	Arbor hole	5.079	0.315	0.394	1.299	5	1.500	2.252	0.625	0.470	8400	1.320	RD..08
R335.18-06.00-0506N-R4	02834715	Arbor	6.079	0.315	0.394	1.614	6	1.500	2.750	–	2.000	7500	3.310	RD..08
335.18-06.00-0506N-R4	02834709	Arbor hole	6.079	0.315	0.394	1.772	6	1.500	2.252	0.625	0.470	7500	1.980	RD..08
R335.18-08.00-XL0506N-R4	02740898	Arbor	8.000	0.315	0.394	2.224	7	1.500	3.500	–	2.000	6700	6.170	RD..08
335.18-08.00-XL0506N-R4	02740237	Arbor hole	8.000	0.315	0.394	2.421	14	2.000	3.000	0.625	0.470	6700	3.310	RD..08
R335.18-10.00-XL0506N-R4	02741547	Arbor	10.000	0.315	0.394	3.209	9	1.500	3.500	–	2.000	6000	8.160	RD..08
335.18-10.00-XL0506N-R4	02740500	Arbor hole	10.000	0.315	0.394	3.386	9	2.000	3.000	0.625	0.470	6000	5.510	RD..08
335.18-12.00-XL0506N-R4	02740869	Arbor hole	12.000	0.315	0.394	4.390	11	2.000	3.000	0.625	0.470	5300	7.940	RD..08
R335.18-04.00-0708N-R5	00079997	Arbor	4.079	0.394	0.472	1.063	4	1.000	1.880	–	2.000	9400	2.650	RD..10
R335.18-05.00-0708N-R5	00079998	Arbor	5.079	0.394	0.472	1.378	5	1.250	2.250	–	2.000	8400	3.090	RD..10
335.18-05.00-0708N-R5	00079978	Arbor hole	5.079	0.394	0.472	1.295	5	1.500	2.252	0.625	0.509	8400	1.760	RD..10
R335.18-06.00-0708N-R5	00079999	Arbor	6.079	0.394	0.472	1.614	6	1.500	2.750	–	2.000	7500	3.750	RD..10
335.18-06.00-0708N-R5	00079979	Arbor hole	6.079	0.394	0.472	1.811	6	1.500	2.252	0.625	0.509	7500	2.430	RD..10
R335.18-08.00-XL0708N-R5	02740899	Arbor	8.000	0.394	0.472	2.224	7	1.500	3.500	–	2.000	6700	6.830	RD..10
335.18-08.00-XL0708N-R5	02740238	Arbor hole	8.000	0.394	0.472	2.421	7	2.000	3.000	0.625	0.509	6700	6.830	RD..10
R335.18-10.00-XL0708N-R5	02741551	Arbor	10.000	0.394	0.472	3.209	9	1.500	3.500	–	2.000	6000	3.310	RD..10
335.18-10.00-XL0708N-R5	02740502	Arbor hole	10.000	0.394	0.472	3.386	9	2.000	3.000	0.625	0.509	6000	6.610	RD..10
335.18-12.00-XL0708N-R5	02740870	Arbor hole	12.000	0.394	0.472	4.390	11	2.000	3.000	0.625	0.509	5300	9.700	RD..10
R335.18-04.00-0809N-R6	00080158	Arbor	4.079	0.472	0.591	1.053	4	1.000	1.880	–	2.000	9400	2.430	RP..12
R335.18-05.00-0809N-R6	00080160	Arbor	5.079	0.472	0.591	1.368	5	1.250	2.250	–	2.000	8400	3.530	RP..12
335.18-05.00-0809N-R6	00080035	Arbor hole	5.079	0.472	0.591	1.339	5	1.500	2.252	0.625	0.549	8400	1.980	RP..12
R335.18-06.00-0809N-R6	00080181	Arbor	6.079	0.472	0.591	1.624	6	1.500	2.750	–	2.000	7500	5.070	RP..12
335.18-06.00-0809N-R6	00080045	Arbor hole	6.079	0.472	0.591	1.829	6	1.500	2.252	0.625	0.549	7500	2.870	RP..12
R335.18-08.00-XL0809N-R6	02740900	Arbor	8.000	0.472	0.591	2.224	7	1.500	3.500	–	2.000	6700	8.600	RP..12
335.18-08.00-XL0809N-R6	02740240	Arbor hole	8.000	0.472	0.591	2.421	7	2.000	3.000	0.625	0.549	6700	4.630	RP..12
R335.18-10.00-XL0809N-R6	02741552	Arbor	10.000	0.472	0.591	3.209	9	1.500	3.500	–	2.000	6000	10.800	RP..12
335.18-10.00-XL0809N-R6	02740503	Arbor hole	10.000	0.472	0.591	3.386	9	2.000	3.000	0.625	0.549	6000	7.940	RP..12
335.18-12.00-XL0809N-R6	02740872	Arbor hole	12.000	0.472	0.591	4.390	11	2.000	3.000	0.625	0.549	5300	15.430	RP..12

All listed adjustable cutters are set to the minimum cutter width CWN (factory setting).

Adjustable cutter may be ordered with the cutting width set to any value within its range (CWN - CWX), see technical data for more info at page 462

Square shoulder and slot milling cutters

Helical milling cutters

Face milling cutters

Disc milling cutters

High feed milling cutters

Copy milling cutters

Plunge milling cutters

Chamfer milling cutters

Spot facing cutters

Inserts

Cutter 335.18 - Insert LNK. – Metric

Width max 5-6 mm - Half side - Right hand with cassette

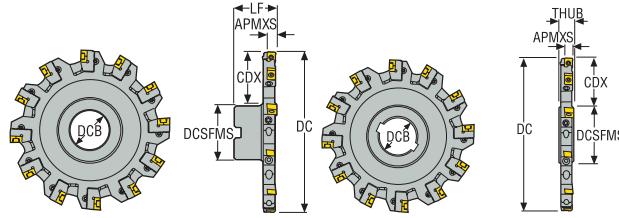

- For insert selection and cutting data recommendations, see page(s) 469-470
- For complete insert programme, see page(s) 833-834
- For spare parts and technical information, see page 462-468
- For ISO attribute explanation, see page 16

Designation	Item number	Type of mounting	DC	APMXS	CDX	ZEP	DCSFMS	DCB	THUB	LF	RPMX	Weight	Insert
			mm	mm	mm	mm	mm	mm	mm	mm	mm	kg	
R335.18-080.0810.27-6R	02611697	Arbor	80,0	5,0	14,8	6	48,0	27,0	–	50,0	10500	0,7	LNK.05..
R335.18-100.0810.27-8R	02576023	Arbor	100,0	5,0	24,8	8	48,0	27,0	–	50,0	9400	0,8	LNK.05..
335.18-100.0810.27-8R	02575757	Arbor hole	100,0	5,0	27,2	8	41,0	27,0	15,0	11,5	9400	0,4	LNK.05..
R335.18-125.0810.32-10R	02576025	Arbor	125,0	5,0	32,3	10	58,0	32,0	–	50,0	8400	1,0	LNK.05..
335.18-125.0810.40-10R	02575758	Arbor hole	125,0	5,0	32,7	10	55,0	40,0	15,0	11,5	8400	0,6	LNK.05..
R335.18-160.0810.40-12R	02576026	Arbor	160,0	5,0	43,8	12	70,0	40,0	–	50,0	7500	1,5	LNK.05..
335.18-160.0810.40-12R	02575759	Arbor	160,0	5,0	50,2	12	55,0	40,0	15,0	11,5	7500	1,0	LNK.05..
R335.18-200.0810XL.40-14R	02713422	Arbor	200,0	5,0	53,5	14	90,0	40,0	–	50,0	6700	2,6	LNK.05..
335.18-200.0810XL.50-14R	02713151	Arbor hole	200,0	5,0	63,5	14	69,0	50,0	15,0	11,5	6700	1,7	LNK.05..
R335.18-250.0810XL.40-18R	02713432	Arbor	250,0	5,0	78,0	18	90,0	40,0	–	50,0	6000	3,1	LNK.05..
335.18-250.0810XL.50-18R	02713163	Arbor hole	250,0	5,0	88,5	18	69,0	50,0	15,0	11,5	6000	2,3	LNK.05..
335.18-315.0810XL.50-24R	02713172	Arbor hole	315,0	5,0	121,0	24	69,0	50,0	15,0	11,5	5300	1,9	LNK.05..
R335.18-080.1012.27-6R	00018584	Arbor	80,0	6,0	14,8	6	48,0	27,0	–	50,0	10500	0,8	LNK.06..
R335.18-100.1012.27-8R	00018603	Arbor	100,0	6,0	24,8	8	48,0	27,0	–	50,0	9400	1,2	LNK.06..
335.18-100.1012.27-8R	00018409	Arbor hole	100,0	6,0	27,2	8	41,0	27,0	15,0	12,5	9400	0,4	LNK.06..
R335.18-125.1012.32-10R	00018618	Arbor	125,0	6,0	32,3	10	58,0	32,0	–	50,0	8400	1,0	LNK.06..
335.18-125.1012.40-10R	00018421	Arbor hole	125,0	6,0	32,7	10	55,0	40,0	15,0	12,5	8400	0,7	LNK.06..
R335.18-160.1012.40-12R	00018674	Arbor	160,0	6,0	43,8	12	70,0	40,0	–	50,0	7500	1,9	LNK.06..
335.18-160.1012.40-12R	00018431	Arbor hole	160,0	6,0	50,2	12	55,0	40,0	15,0	12,5	7500	1,5	LNK.06..
R335.18-200.1012XL.40-14R	02713423	Arbor	200,0	6,0	53,5	14	90,0	40,0	–	50,0	6700	2,9	LNK.06..
335.18-200.1012XL.50-14R	02713154	Arbor hole	200,0	6,0	63,5	14	69,0	50,0	15,0	12,5	6700	1,7	LNK.06..
R335.18-250.1012XL.40-18R	02713435	Arbor	250,0	6,0	78,0	18	90,0	40,0	–	50,0	6000	4,0	LNK.06..
335.18-250.1012XL.50-18R	02713165	Arbor hole	250,0	6,0	88,5	18	69,0	50,0	15,0	12,5	6000	2,8	LNK.06..
335.18-315.1012XL.50-24R	02713177	Arbor hole	315,0	6,0	121,0	24	69,0	50,0	15,0	12,5	5300	1,9	LNK.06..

Width max 7,5 mm - Half side - Right hand with cassette

Cutter 335.18 - Insert LNK. – Metric

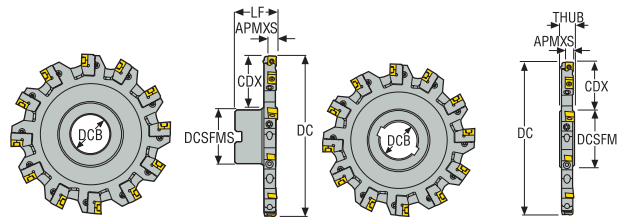

- For insert selection and cutting data recommendations, see page(s) 469-470
- For complete insert programme, see page(s) 833-834
- For spare parts and technical information, see page 462-468
- For ISO attribute explanation, see page 16

Designation	Item number	Type of mounting	DC	APMXS	CDX	ZEPF	DCSFMS	DCB	THUB	LF	RPMX	Weight	Insert
			mm	mm	mm		mm	mm	mm	mm		kg	
R335.18-080.1215.27-6R	00018723	Arbor	80,0	7,5	14,8	6	48,0	27,0	–	50,0	10500	1,1	LNK.08..
R335.18-100.1215.27-8R	00018754	Arbor	100,0	7,5	24,8	8	48,0	27,0	–	50,0	9400	0,9	LNK.08..
335.18-100.1215.27-8R	00018515	Arbor hole	100,0	7,5	27,2	8	41,0	27,0	15,0	13,5	9400	0,5	LNK.08..
R335.18-125.1215.32-10R	00018766	Arbor	125,0	7,5	32,3	10	58,0	32,0	–	50,0	8400	1,2	LNK.08..
335.18-125.1215.40-10R	00018540	Arbor hole	125,0	7,5	32,7	10	55,0	40,0	15,0	13,5	8400	0,9	LNK.08..
R335.18-160.1215.40-12R	00018784	Arbor	160,0	7,5	43,8	12	70,0	40,0	–	50,0	7500	2,7	LNK.08..
335.18-160.1215.40-12R	00018546	Arbor hole	160,0	7,5	50,2	12	55,0	40,0	15,0	13,5	7500	1,5	LNK.08..
R335.18-200.1215XL.40-14R	02713424	Arbor	200,0	7,5	53,5	14	90,0	40,0	–	50,0	6700	3,6	LNK.08..
335.18-200.1215XL.50-14R	02713155	Arbor hole	200,0	7,5	63,5	14	69,0	50,0	15,0	13,5	6700	1,7	LNK.08..
R335.18-250.1215XL.40-18R	02713437	Arbor	250,0	7,5	78,0	18	90,0	40,0	–	50,0	6000	4,5	LNK.08..
335.18-250.1215XL.50-18R	02713166	Arbor hole	250,0	7,5	88,5	18	69,0	50,0	15,0	13,5	6000	2,5	LNK.08..
335.18-315.1215XL.50-24R	02713178	Arbor hole	315,0	7,5	121,0	24	69,0	50,0	15,0	13,5	5300	2,2	LNK.08..

Square shoulder and slot milling cutters

Helical milling cutters

Face milling cutters

Disc milling cutters

High feed milling cutters

Copy milling cutters

Plunge milling cutters

Chamfer milling cutters

Spot facing cutters

Inserts

Cutter 335.18 - Insert LNK. – inch

Width max 0.197-0.236" - Half side - Right hand with cassette

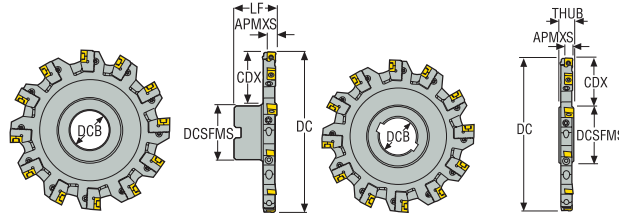

- For insert selection and cutting data recommendations, see page(s) 469-470
- For complete insert programme, see page(s) 833-834
- For spare parts and technical information, see page 462-468
- For ISO attribute explanation, see page 16

Designation	Item number	Type of mounting	DC	APMX	CDX	ZFP	DCSFMS	DCB	THUB	LF	RPMX	Weight	Insert
			inch	inch	inch		inch	inch	inch	inch	inch	lbs	
R335.18-04.00-0506R	02834790	Arbor	4.000	0.197	1.024	8	1.880	1.000	–	2.000	9400	1.760	LNK.05
335.18-04.00-0506R	02834787	Arbor hole	4.000	0.197	1.102	8	1.550	1.000	0.625	0.469	9400	0.880	LNK.05
R335.18-05.00-0506R	02834791	Arbor	5.000	0.197	1.339	10	2.250	1.250	–	2.000	8400	2.650	LNK.05
335.18-05.00-0506R	02834788	Arbor hole	5.000	0.197	1.299	10	2.252	1.500	0.625	0.469	8400	1.320	LNK.05
R335.18-06.00-0506R	02834792	Arbor	6.000	0.197	1.575	12	2.750	1.500	–	2.000	7500	3.310	LNK.05
335.18-06.00-0506R	02834789	Arbor hole	6.000	0.197	1.772	12	2.252	1.500	0.625	0.469	7500	1.980	LNK.05
R335.18-08.00-XL0506R	02740901	Arbor	8.000	0.197	2.224	14	3.500	1.500	–	2.000	6700	6.170	LNK.05
335.18-08.00-XL0506R	02740241	Arbor hole	8.000	0.197	2.421	14	3.000	2.000	0.625	0.469	6700	3.310	LNK.05
R335.18-10.00-XL0506R	02741554	Arbor	10.000	0.197	3.209	18	3.500	1.500	–	2.000	6000	8.160	LNK.05
335.18-10.00-XL0506R	02740505	Arbor hole	10.000	0.197	3.386	18	3.000	2.000	0.625	0.469	6000	5.510	LNK.05
335.18-12.00-XL0506R	02740874	Arbor hole	12.000	0.197	4.390	22	3.000	2.000	0.625	0.469	5300	7.940	LNK.05
R335.18-04.00-0708R	00079792	Arbor	4.000	0.236	1.014	8	1.880	1.000	–	2.000	9400	2.200	LNK.06
R335.18-05.00-0708R	00079832	Arbor	5.000	0.236	1.329	10	2.250	1.250	–	2.000	8400	3.090	LNK.06
335.18-05.00-0708R	00079766	Arbor hole	5.000	0.236	1.258	10	2.252	1.500	0.625	0.508	8400	1.760	LNK.06
R335.18-06.00-0708R	00079833	Arbor	6.000	0.236	1.534	12	2.750	1.500	–	2.000	7500	3.750	LNK.06
335.18-06.00-0708R	00079767	Arbor hole	6.000	0.236	1.766	12	2.252	1.500	0.625	0.508	7500	2.430	LNK.06
R335.18-08.00-XL0708R	02740902	Arbor	8.000	0.236	2.224	14	3.500	1.500	–	2.000	6700	6.830	LNK.06
335.18-08.00-XL0708R	02740242	Arbor hole	8.000	0.236	2.421	14	3.000	2.000	0.625	0.508	6700	3.970	LNK.06
R335.18-10.00-XL0708R	02741556	Arbor	10.000	0.236	3.209	18	3.500	1.500	–	2.000	6000	9.260	LNK.06
335.18-10.00-XL0708R	02740506	Arbor hole	10.000	0.236	3.386	18	3.000	2.000	0.625	0.508	6000	6.610	LNK.06
335.18-12.00-XL0708R	02740875	Arbor hole	12.000	0.236	4.390	22	3.000	2.000	0.625	0.508	5300	9.700	LNK.06

Width max 0.295" - Half side - Right hand with cassette

Cutter 335.18 - Insert LNK. – inch

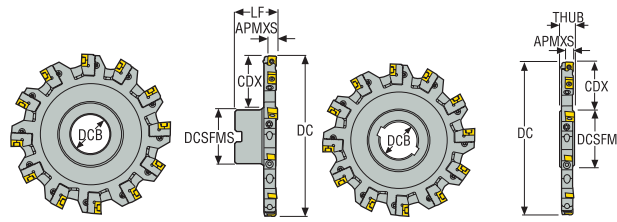

- For insert selection and cutting data recommendations, see page(s) 469-470
- For complete insert programme, see page(s) 833-834
- For spare parts and technical information, see page 462-468
- For ISO attribute explanation, see page 16

Designation	Item number	Type of mounting	DC	APMX	CDX	ZEFP	DCSFMS	DCB	THUB	LF	RPMX	Weight	Insert
			inch	inch	inch		inch	inch	inch	inch		lbs	
R335.18-04.00-0809R	00079968	Arbor	4.000	0.295	1.014	8	1.880	1.000	–	2.000	9400	2.430	LNK.08
R335.18-05.00-0809R	00079969	Arbor	5.000	0.295	1.329	10	2.250	1.250	–	2.000	8400	3.530	LNK.08
335.18-05.00-0809R	00079951	Arbor hole	5.000	0.295	1.285	10	2.252	1.500	0.625	0.547	8400	1.980	LNK.08
R335.18-06.00-0809R	00079970	Arbor	6.000	0.295	1.585	12	2.750	1.500	–	2.000	7500	4.190	LNK.08
335.18-06.00-0809R	00079952	Arbor hole	6.000	0.295	1.790	12	2.252	1.500	0.625	0.547	7500	2.870	LNK.08
R335.18-08.00-XL0809R	02740903	Arbor	8.000	0.295	2.224	14	3.500	1.500	–	2.000	6700	7.720	LNK.08
335.18-08.00-XL0809R	02740244	Arbor hole	8.000	0.295	2.421	14	3.000	2.000	0.625	0.547	6700	4.850	LNK.08
R335.18-10.00-XL0809R	02741557	Arbor	10.000	0.295	3.209	18	3.500	1.500	–	2.000	6000	10.800	LNK.08
335.18-10.00-XL0809R	02740507	Arbor hole	10.000	0.295	3.386	18	3.000	2.000	0.625	0.547	6000	7.940	LNK.08
335.18-12.00-XL0809R	02740876	Arbor hole	12.000	0.295	4.390	22	3.000	2.000	0.625	0.547	5300	11.900	LNK.08

Square shoulder and slot milling cutters

Helical milling cutters

Face milling cutters

Disc milling cutters

High feed milling cutters

Copy milling cutters

Plunge milling cutters

Chamfer milling cutters

Spot facing cutters

Inserts

Cutter 335.18 - Insert RD..10T3/RP..1204 – Metric

Half side - Right hand - Radius profile with cassette

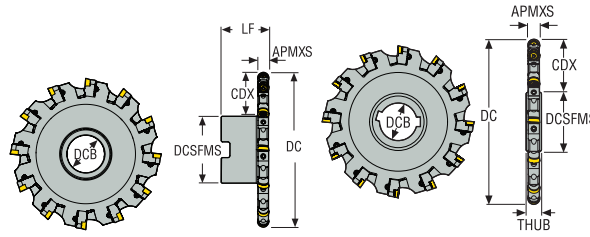

- For insert selection and cutting data recommendations, see page(s) 488-493
- For complete insert programme, see page(s) 839, 841
- For spare parts and technical information, see page 462-468
- For ISO attribute explanation, see page 16

Designation	Item number	Type of mounting	DC	APMXS	CDX	ZEFP	DCB	DCSFMS	THUB	LF	RPMX	Weight	Insert
			mm	mm	mm		mm	mm	mm	mm		kg	
R335.18-080.1012.27-6R-R5	00030353	Arbor	82,0	5,0	15,8	6	27,0	48,0	–	50,0	10500	0,8	RD..10T3
R335.18-100.1012.27-8R-R5	00030357	Arbor	102,0	5,0	25,8	8	27,0	48,0	–	50,0	9400	1,2	RD..10T3
335.18-100.1012.27-8R-R5	00030329	Arbor hole	102,0	5,0	28,2	8	27,0	41,0	15,0	12,5	9400	0,4	RD..10T3
R335.18-125.1012.32-10R-R5	00030360	Arbor	127,0	5,0	33,3	10	32,0	58,0	–	50,0	8400	1,2	RD..10T3
335.18-125.1012.40-10R-R5	00030341	Arbor hole	127,0	5,0	33,7	10	40,0	55,0	15,0	12,5	8400	0,7	RD..10T3
R335.18-160.1012.40-12R-R5	00030364	Arbor	162,0	5,0	44,8	12	40,0	70,0	–	50,0	7500	0,1	RD..10T3
335.18-160.1012.40-12R-R5	00030344	Arbor hole	162,0	5,0	51,2	12	40,0	55,0	15,0	12,5	7500	1,2	RD..10T3
R335.18-200.1012XL.40-14R-R5	02713429	Arbor	200,0	5,0	53,5	14	40,0	90,0	–	50,0	6700	2,9	RD..10T3
335.18-200.1012XL.50-14R-R5	02713159	Arbor hole	200,0	5,0	63,5	14	50,0	69,0	15,0	12,5	6700	1,7	RD..10T3
R335.18-250.1012XL.40-18R-R5	02713438	Arbor	250,0	5,0	78,0	18	40,0	90,0	–	50,0	6000	4,0	RD..10T3
335.18-250.1012XL.50-18R-R5	02713169	Arbor hole	250,0	5,0	88,5	18	50,0	69,0	15,0	12,5	6000	3,8	RD..10T3
335.18-315.1012XL.50-24R-R5	02713180	Arbor hole	315,0	5,0	121,0	24	50,0	69,0	15,0	12,5	5300	4,6	RD..10T3
R335.18-080.1215.27-6R-R6	00030407	Arbor	82,0	6,0	14,8	6	27,0	48,0	–	50,0	10500	0,7	RP..1204
R335.18-100.1215.27-8R-R6	00030414	Arbor	102,0	6,0	25,8	8	27,0	48,0	–	50,0	9400	1,1	RP..1204
335.18-100.1215.27-8R-R6	00030372	Arbor hole	102,0	6,0	28,2	8	27,0	41,0	15,0	13,5	9400	0,7	RP..1204
R335.18-125.1215.32-10R-R6	00030418	Arbor	127,0	6,0	33,3	10	32,0	58,0	–	50,0	8400	1,4	RP..1204
335.18-125.1215.40-10R-R6	00030375	Arbor hole	127,0	6,0	33,7	10	40,0	55,0	15,0	13,5	8400	0,9	RP..1204
R335.18-160.1215.40-12R-R6	00030421	Arbor	162,0	6,0	44,8	12	40,0	70,0	–	50,0	7500	1,9	RP..1204
335.18-160.1215.40-12R-R6	00030378	Arbor hole	162,0	6,0	51,2	12	40,0	55,0	15,0	13,5	7500	1,5	RP..1204
R335.18-200.1215XL.40-14R-R6	02713431	Arbor	200,0	6,0	53,5	14	40,0	90,0	–	50,0	6700	4,3	RP..1204
335.18-200.1215XL.50-14R-R6	02713162	Arbor hole	200,0	6,0	63,5	14	50,0	69,0	15,0	13,5	6700	2,0	RP..1204
R335.18-250.1215XL.40-18R-R6	02713441	Arbor	250,0	6,0	78,0	18	40,0	90,0	–	50,0	6000	4,5	RP..1204
335.18-250.1215XL.50-18R-R6	02713170	Arbor hole	250,0	6,0	88,5	18	50,0	69,0	15,0	13,5	6000	4,7	RP..1204
335.18-315.1215XL.50-24R-R6	02713182	Arbor hole	315,0	6,0	121,0	24	50,0	69,0	15,0	13,5	5300	7,0	RP..1204

Half side - Right hand - Radius profile with cassette

Cutter 335.18 - Insert RD..10T3/RP..1204 – inch

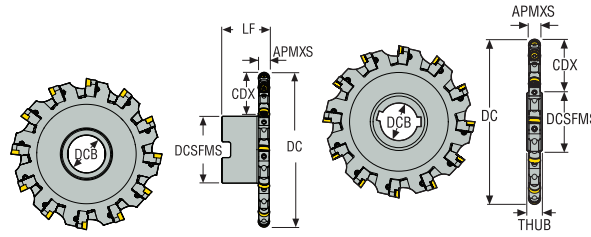

- For insert selection and cutting data recommendations, see page(s) 488-493
- For complete insert programme, see page(s) 839, 841
- For spare parts and technical information, see page 462-468
- For ISO attribute explanation, see page 16

Designation	Item number	Type of mounting	DC	APMXS	CDX	ZEFP	DCB	DCSFMS	THUB	LF	RPMX	Weight	Insert
			inch	inch	inch		inch	inch	inch	inch		lbs	
R335.18-08.00-XL0708R-R5	02740905	Arbor	8.000	0.197	2.264	14	1.500	3.500	–	2.000	6700	6.830	RD..10
335.18-08.00-XL0708R-R5	02740245	Arbor hole	8.000	0.197	2.421	14	2.000	3.000	0.625	0.509	6700	3.970	RD..10
R335.18-10.00-XL0708R-R5	02741559	Arbor	10.000	0.197	3.248	18	1.500	3.500	–	2.000	6000	9.260	RD..10
335.18-10.00-XL0708R-R5	02740508	Arbor hole	10.000	0.197	3.386	18	2.000	3.000	0.625	0.509	6000	6.610	RD..10
335.18-12.00-XL0708R-R5	02740883	Arbor hole	12.000	0.197	4.390	22	2.000	3.000	0.625	0.509	5300	9.700	RD..10
R335.18-04.00-0809R-R6	02599486	Arbor	4.079	0.236	1.053	8	1.000	1.880	–	2.000	9400	2.650	RP..12
R335.18-05.00-0809R-R6	02599487	Arbor	5.079	0.236	1.368	10	1.250	2.250	–	2.000	8400	3.530	RP..12
335.18-05.00-0809R-R6	02599495	Arbor hole	5.079	0.236	1.324	10	1.500	2.252	0.625	0.548	8400	1.980	RP..12
R335.18-06.00-0809R-R6	02599488	Arbor	6.079	0.236	1.624	12	1.500	2.750	–	2.000	7500	4.190	RP..12
335.18-06.00-0809R-R6	02599496	Arbor hole	6.079	0.236	1.829	12	1.500	2.252	0.625	0.548	7500	2.870	RP..12
R335.18-08.00-XL0809R-R6	02740906	Arbor	8.000	0.236	2.264	14	1.500	3.500	–	2.000	6700	8.600	RP..12
335.18-08.00-XL0809R-R6	02740246	Arbor hole	8.000	0.236	2.421	14	2.000	3.000	0.625	0.548	6700	4.850	RP..12
R335.18-10.00-XL0809R-R6	02741561	Arbor	10.000	0.236	3.248	18	1.500	3.500	–	2.000	6000	10.800	RP..12
335.18-10.00-XL0809R-R6	02740527	Arbor hole	10.000	0.236	3.386	18	2.000	3.000	0.625	0.548	6000	7.940	RP..12
335.18-12.00-XL0809R-R6	02740884	Arbor hole	12.000	0.236	4.390	22	2.000	3.000	0.625	0.548	5300	11.900	RP..12

Square shoulder and slot milling cutters

Helical milling cutters

Face milling cutters

Disc milling cutters

High feed milling cutters

Copy milling cutters

Plunge milling cutters

Chamfer milling cutters

Spot facing cutters

Inserts

Cutter 335.18 - Insert LNK. – Metric

Width max 5-6 mm - Half side - Left hand with cassette

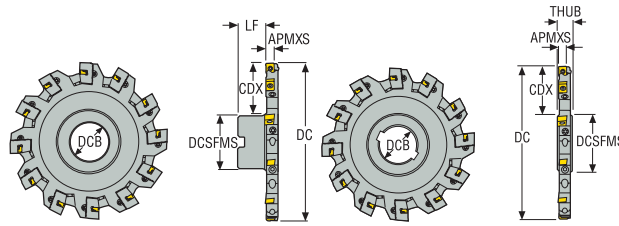

- For insert selection and cutting data recommendations, see page(s) 469-470
- For complete insert programme, see page(s) 833-834
- For spare parts and technical information, see page 462-468
- For ISO attribute explanation, see page 16

Designation	Item number	Type of mounting	DC	APMXS	CDX	ZEP	DCSFMS	DCB	THUB	LF	RPMX	Weight	Insert
			mm	mm	mm	mm	mm	mm	mm	mm	mm	kg	
R335.18-080.0810.27-6L	02611696	Arbor	80,0	5,0	14,8	6	48,0	27,0	–	42,0	10500	0,7	LNK.05..
R335.18-100.0810.27-8L	02576028	Arbor	100,0	5,0	24,8	8	48,0	27,0	–	42,0	9400	0,8	LNK.05..
335.18-100.0810.27-8L	02575778	Arbor hole	100,0	5,0	27,2	8	41,0	27,0	15,0	3,5	9400	0,4	LNK.05..
R335.18-125.0810.32-10L	02576029	Arbor	125,0	5,0	32,3	10	58,0	32,0	–	42,0	8400	1,0	LNK.05..
335.18-125.0810.40-10L	02575787	Arbor hole	125,0	5,0	32,7	10	55,0	40,0	15,0	3,5	8400	0,6	LNK.05..
R335.18-160.0810.40-12L	02576030	Arbor	160,0	5,0	43,8	12	70,0	40,0	–	42,0	7500	1,6	LNK.05..
335.18-160.0810.40-12L	02575796	Arbor hole	160,0	5,0	50,2	12	55,0	40,0	15,0	3,5	7500	1,0	LNK.05..
R335.18-200.0810XL.40-14L	02713444	Arbor	200,0	5,0	53,5	14	90,0	40,0	–	42,0	6700	2,7	LNK.05..
335.18-200.0810XL.50-14L	02713344	Arbor hole	200,0	5,0	63,5	14	69,0	50,0	15,0	3,5	6700	1,7	LNK.05..
R335.18-250.0810XL.40-18L	02713466	Arbor	250,0	5,0	78,0	18	90,0	40,0	–	42,0	6000	3,5	LNK.05..
335.18-250.0810XL.50-18L	02713355	Arbor hole	250,0	5,0	88,5	18	69,0	50,0	15,0	3,5	6000	1,7	LNK.05..
335.18-315.0810XL.50-24L	02713361	Arbor hole	315,0	5,0	121,0	24	69,0	50,0	15,0	3,5	5300	1,9	LNK.05..
R335.18-080.1012.27-6L	00018592	Arbor	80,0	6,0	14,8	6	48,0	27,0	–	40,0	10500	1,0	LNK.06..
R335.18-100.1012.27-8L	00018612	Arbor	100,0	6,0	24,8	8	48,0	27,0	–	40,0	9400	0,9	LNK.06..
335.18-100.1012.27-8L	00018412	Arbor hole	100,0	6,0	27,2	8	41,0	27,0	15,0	2,5	9400	0,4	LNK.06..
R335.18-125.1012.32-10L	00018624	Arbor	125,0	6,0	32,3	10	58,0	32,0	–	40,0	8400	1,0	LNK.06..
335.18-125.1012.40-10L	00018426	Arbor hole	125,0	6,0	32,7	10	55,0	40,0	15,0	2,5	8400	0,8	LNK.06..
R335.18-160.1012.40-12L	00018687	Arbor	160,0	6,0	43,8	12	70,0	40,0	–	40,0	7500	1,3	LNK.06..
335.18-160.1012.40-12L	00018439	Arbor hole	160,0	6,0	50,2	12	55,0	40,0	15,0	2,5	7500	1,5	LNK.06..
R335.18-200.1012XL.40-14L	02713459	Arbor	200,0	6,0	53,5	14	90,0	40,0	–	40,0	6700	2,9	LNK.06..
335.18-200.1012XL.50-14L	02713348	Arbor hole	200,0	6,0	63,5	14	69,0	50,0	15,0	2,5	6700	1,7	LNK.06..
R335.18-250.1012XL.40-18L	02713467	Arbor	250,0	6,0	78,0	18	90,0	40,0	–	40,0	6000	3,9	LNK.06..
335.18-250.1012XL.50-18L	02713356	Arbor hole	250,0	6,0	88,5	18	69,0	50,0	15,0	2,5	6000	1,8	LNK.06..
335.18-315.1012XL.50-24L	02713363	Arbor hole	315,0	6,0	121,0	24	69,0	50,0	15,0	2,5	5300	4,5	LNK.06..

Width max 7,5 mm - Half side - Left hand with cassette

Cutter 335.18 - Insert LNK. – Metric

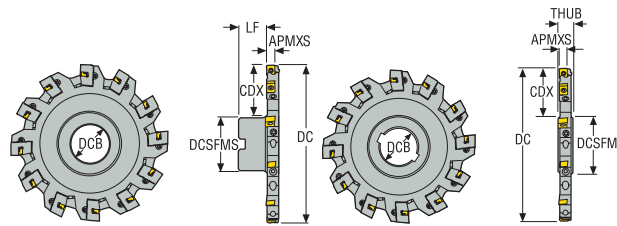

- For insert selection and cutting data recommendations, see page(s) 469-470
- For complete insert programme, see page(s) 834
- For spare parts and technical information, see page 462-468
- For ISO attribute explanation, see page 16

Designation	Item number	Type of mounting	DC	APMXS	CDX	ZEFP	DCSFMS	DCB	THUB	LF	RPMX	Weight	Insert
			mm	mm	mm		mm	mm	mm	mm		kg	
R335.18-080.1215.27-6L	00018729	Arbor	80,0	7,5	14,8	6	48,0	27,0	–	38,0	10500	0,8	LNK.08..
R335.18-100.1215.27-8L	00018756	Arbor	100,0	7,5	24,8	8	48,0	27,0	–	38,0	9400	1,1	LNK.08..
335.18-100.1215.27-8L	00018530	Arbor hole	100,0	7,5	27,2	8	41,0	27,0	15,0	1,5	9400	0,6	LNK.08..
R335.18-125.1215.32-10L	00018777	Arbor	125,0	7,5	33,3	10	58,0	32,0	–	38,0	8400	1,0	LNK.08..
335.18-125.1215.40-10L	00018542	Arbor hole	125,0	7,5	32,7	10	55,0	40,0	15,0	1,5	8400	0,9	LNK.08..
R335.18-160.1215.40-12L	00018788	Arbor	160,0	7,5	43,8	12	70,0	40,0	–	38,0	7500	2,1	LNK.08..
335.18-160.1215.40-12L	00018548	Arbor hole	160,0	7,5	50,2	12	55,0	40,0	15,0	1,5	7500	1,4	LNK.08..
R335.18-200.1215XL.40-14L	02713461	Arbor	200,0	7,5	53,5	14	90,0	40,0	–	38,0	6700	3,5	LNK.08..
335.18-200.1215XL.50-14L	02713349	Arbor hole	200,0	7,5	63,5	14	69,0	50,0	15,0	1,5	6700	2,0	LNK.08..
R335.18-250.1215XL.40-18L	02713470	Arbor	250,0	7,5	78,0	18	90,0	40,0	–	90,0	6000	4,5	LNK.08..
335.18-250.1215XL.50-18L	02713357	Arbor hole	250,0	7,5	88,5	18	69,0	50,0	15,0	1,5	6000	3,2	LNK.08..
335.18-315.1215XL.50-24L	02713364	Arbor hole	315,0	7,5	121,0	24	69,0	50,0	15,0	1,5	5300	5,6	LNK.08..

Square shoulder and slot milling cutters

Helical milling cutters

Face milling cutters

Disc milling cutters

High feed milling cutters

Copy milling cutters

Plunge milling cutters

Chamfer milling cutters

Spot facing cutters

Inserts

Cutter 335.18 - Insert LNK. – inch

Width max 0.197-0.236" - Half side - Left hand with cassette

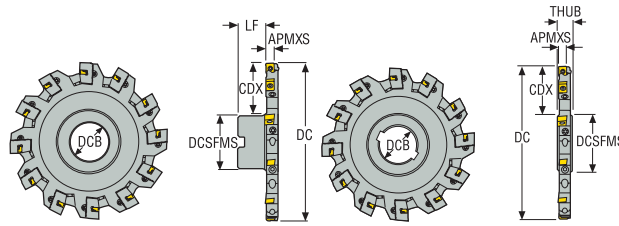

- For insert selection and cutting data recommendations, see page(s) 469-470
- For complete insert programme, see page(s) 833-834
- For spare parts and technical information, see page 462-468
- For ISO attribute explanation, see page 16

Designation	Item number	Type of mounting	DC	APMX	CDX	ZFP	DCSFMS	DCB	THUB	LF	RPM	Weight	Insert
			inch	inch	inch		inch	inch	inch	inch	inch	lbs	
R335.18-04.00-0506L	02834741	Arbor	4.000	0.236	1.024	8	1.880	1.000	–	1.685	9400	1.760	LNK.05
335.18-04.00-0506L	02834738	Arbor hole	4.000	0.197	1.102	8	1.550	1.000	0.625	0.154	9400	0.880	LNK.05
R335.18-05.00-0506L	02834742	Arbor	5.000	0.197	1.339	10	2.250	1.250	–	1.685	8400	2.650	LNK.05
335.18-05.00-0506L	02834739	Arbor hole	5.000	0.197	1.299	10	2.252	1.500	0.625	0.154	8400	1.320	LNK.05
R335.18-06.00-0506L	02834743	Arbor	6.000	0.197	1.575	12	2.750	1.500	–	1.685	7500	3.310	LNK.05
335.18-06.00-0506L	02834740	Arbor hole	6.000	0.197	1.772	12	2.252	1.500	0.625	0.154	7500	1.980	LNK.05
R335.18-08.00-XL0506L	02740907	Arbor	8.000	0.197	2.224	14	3.500	1.500	–	1.685	6700	6.170	LNK.05
335.18-08.00-XL0506L	02740247	Arbor hole	8.000	0.197	2.421	14	3.000	2.000	0.625	0.154	6700	3.310	LNK.05
R335.18-10.00-XL0506L	02741562	Arbor	10.000	0.197	3.209	18	3.500	1.500	–	1.685	6000	8.160	LNK.05
335.18-10.00-XL0506L	02740528	Arbor hole	10.000	0.197	3.386	18	3.000	2.000	0.625	0.154	6000	5.510	LNK.05
335.18-12.00-XL0506L	02740885	Arbor hole	12.000	0.197	4.390	22	3.000	2.000	0.625	0.154	5300	7.940	LNK.05
R335.18-04.00-0708L	00079837	Arbor	4.000	0.236	1.014	8	1.880	1.000	–	1.606	9400	2.200	LNK.06
R335.18-05.00-0708L	00079838	Arbor	5.000	0.236	1.329	10	2.250	1.250	–	1.606	8400	3.090	LNK.06
335.18-05.00-0708L	00079776	Arbor hole	5.000	0.236	1.258	10	2.252	1.500	0.625	0.117	8400	1.760	LNK.06
R335.18-06.00-0708L	00079839	Arbor	6.000	0.236	1.534	12	2.750	1.500	–	1.606	7500	3.750	LNK.06
335.18-06.00-0708L	00079777	Arbor hole	6.000	0.236	1.766	12	2.252	1.500	0.625	0.117	7500	2.430	LNK.06
R335.18-08.00-XL0708L	02740908	Arbor	8.000	0.236	2.224	14	3.500	1.500	–	1.606	6700	6.830	LNK.06
335.18-08.00-XL0708L	02740248	Arbor hole	8.000	0.236	2.421	14	3.000	2.000	0.625	0.117	6700	3.970	LNK.06
R335.18-10.00-XL0708L	02741564	Arbor	10.000	0.236	3.209	18	3.500	1.500	–	1.606	6000	9.260	LNK.06
335.18-10.00-XL0708L	02740530	Arbor hole	10.000	0.236	3.386	18	3.000	2.000	0.625	0.117	6000	6.610	LNK.06
335.18-12.00-XL0708L	02740887	Arbor hole	12.000	0.236	4.390	22	3.000	2.000	0.625	0.117	5300	9.700	LNK.06

Width max 0.295" - Half side - Half side - Left hand with cassette

Cutter 335.18 - Insert LNK. – inch

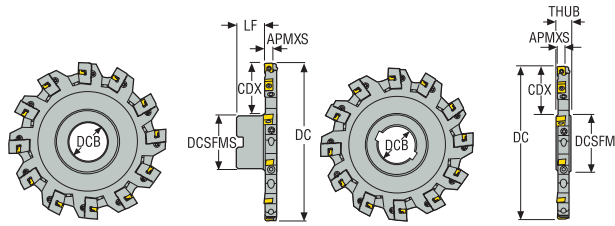

- For insert selection and cutting data recommendations, see page(s) 469-470
- For complete insert programme, see page(s) 834
- For spare parts and technical information, see page 462-468
- For ISO attribute explanation, see page 16

Designation	Item number	Type of mounting	DC	APMX	CDX	ZEFP	DCSFMS	DCB	THUB	LF	RPMX	Weight	Insert
			inch	inch	inch		inch	inch	inch	inch		lbs	
R335.18-04.00-0809L	00079973	Arbor	4.000	0.295	1.014	8	1.880	1.000	–	1.528	9400	2.430	LNK.08
R335.18-05.00-0809L	00079974	Arbor	5.000	0.295	1.329	10	2.250	1.250	–	1.528	8400	3.530	LNK.08
335.18-05.00-0809L	00079957	Arbor hole	5.000	0.295	1.285	10	2.252	1.500	0.625	0.077	8400	1.980	LNK.08
R335.18-06.00-0809L	00079975	Arbor	6.000	0.295	1.585	12	2.750	1.500	–	1.528	7500	4.190	LNK.08
335.18-06.00-0809L	00079958	Arbor hole	6.000	0.295	1.790	12	2.252	1.500	0.625	0.077	7500	2.870	LNK.08
R335.18-08.00-XL0809L	02740909	Arbor	8.000	0.295	2.224	14	3.500	1.500	–	1.528	6700	7.720	LNK.08
335.18-08.00-XL0809L	02740249	Arbor hole	8.000	0.295	2.421	14	3.000	2.000	0.625	0.077	6700	4.850	LNK.08
R335.18-10.00-XL0809L	02741566	Arbor	10.000	0.295	3.209	18	3.500	1.500	–	1.528	6000	10.800	LNK.08
335.18-10.00-XL0809L	02740531	Arbor hole	10.000	0.295	3.386	18	3.000	2.000	0.625	0.077	6000	7.940	LNK.08
335.18-12.00-XL0809L	02740888	Arbor hole	12.000	0.295	4.390	22	3.000	2.000	0.625	0.077	5300	11.900	LNK.08

Square shoulder and slot milling cutters

Helical milling cutters

Face milling cutters

Disc milling cutters

High feed milling cutters

Copy milling cutters

Plunge milling cutters

Chamfer milling cutters

Spot facing cutters

Inserts

Cutter 335.18 - Insert RD..10T3/RP..1204 – Metric

Half side - Left hand - Radius profile with cassette

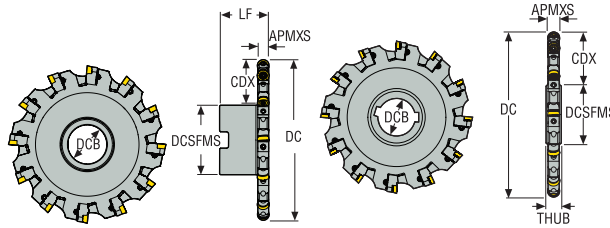

- For insert selection and cutting data recommendations, see page(s) 488-493
- For complete insert programme, see page(s) 839, 841
- For spare parts and technical information, see page 462-468
- For ISO attribute explanation, see page 16

Designation	Item number	Type of mounting	DC	APMXS	CDX	ZEP	DCB	DCSFMS	THUB	LF	RPMX	Weight	Insert
			mm	mm	mm		mm	mm	mm	mm		kg	
R335.18-080.1012.27-6L-R5	00030354	Arbor	82,0	5,0	15,8	6	27,0	48,0	–	40,0	10500	0,8	RD..10T3
R335.18-100.1012.27-8L-R5	00030358	Arbor	102,0	5,0	25,8	8	27,0	48,0	–	40,0	9400	1,0	RD..10T3
335.18-100.1012.27-8L-R5	00030339	Arbor hole	102,0	5,0	28,2	8	27,0	41,0	15,0	2,5	9400	0,4	RD..10T3
R335.18-125.1012.32-10L-R5	00030361	Arbor	127,0	5,0	33,3	10	32,0	58,0	–	42,0	8400	1,2	RD..10T3
335.18-125.1012.40-10L-R5	00030342	Arbor hole	127,0	5,0	33,7	10	40,0	55,0	15,0	2,5	8400	0,8	RD..10T3
R335.18-160.1012.40-12L-R5	00030366	Arbor	162,0	5,0	44,8	12	40,0	70,0	–	40,0	7500	2,3	RD..10T3
335.18-160.1012.40-12L-R5	00030345	Arbor hole	162,0	5,0	51,2	12	40,0	55,0	15,0	2,5	7500	11,0	RD..10T3
R335.18-200.1012XL.40-14L-R5	02713464	Arbor	200,0	5,0	53,5	14	40,0	90,0	–	40,0	6700	2,9	RD..10T3
335.18-200.1012XL.50-14L-R5	02713352	Arbor hole	200,0	5,0	63,5	14	50,0	69,0	15,0	2,5	6700	1,7	RD..10T3
R335.18-250.1012XL.40-18L-R5	02713476	Arbor	250,0	5,0	78,0	18	40,0	90,0	–	40,0	6000	9,5	RD..10T3
335.18-250.1012XL.50-18L-R5	02713359	Arbor hole	250,0	5,0	88,5	18	50,0	69,0	15,0	2,5	6000	1,8	RD..10T3
335.18-315.1012XL.50-24L-R5	02713367	Arbor hole	315,0	5,0	121,0	24	50,0	69,0	15,0	2,5	5300	2,0	RD..10T3
R335.18-080.1215.27-6L-R6	00030408	Arbor	82,0	6,0	15,8	6	27,0	48,0	–	38,0	10500	0,7	RP..1204
R335.18-100.1215.27-8L-R6	00030416	Arbor	102,0	6,0	25,8	8	27,0	48,0	–	38,0	9400	1,1	RP..1204
335.18-100.1215.27-8L-R6	00030373	Arbor hole	102,0	6,0	28,2	8	27,0	41,0	15,0	1,5	9400	0,6	RP..1204
R335.18-125.1215.32-10L-R6	00030419	Arbor	127,0	6,0	32,3	10	32,0	58,0	–	38,0	8400	1,1	RP..1204
335.18-125.1215.40-10L-R6	00030376	Arbor hole	127,0	6,0	33,7	10	40,0	55,0	15,0	1,5	8400	0,9	RP..1204
R335.18-160.1215.40-12L-R6	00030422	Arbor	162,0	6,0	44,8	12	40,0	70,0	–	38,0	7500	2,0	RP..1204
335.18-160.1215.40-12L-R6	00030380	Arbor hole	162,0	6,0	51,2	12	40,0	55,0	15,0	1,5	7500	1,5	RP..1204
R335.18-200.1215XL.40-14L-R6	02713465	Arbor	200,0	6,0	53,5	14	40,0	90,0	–	38,0	6700	3,4	RP..1204
335.18-200.1215XL.50-14L-R6	02713354	Arbor hole	200,0	6,0	63,5	14	50,0	69,0	15,0	1,5	6700	1,9	RP..1204
R335.18-250.1215XL.40-18L-R6	02713478	Arbor	250,0	6,0	78,0	18	40,0	90,0	–	38,0	6000	4,4	RP..1204
335.18-250.1215XL.50-18L-R6	02713360	Arbor hole	250,0	6,0	88,5	18	50,0	69,0	15,0	1,5	6000	2,0	RP..1204
335.18-315.1215XL.50-24L-R6	02713368	Arbor hole	315,0	6,0	121,0	24	50,0	69,0	15,0	1,5	5300	2,2	RP..1204

Half side - Left hand - Radius profile with cassette

Cutter 335.18 - Insert RD..10T3/RP..1204 – inch

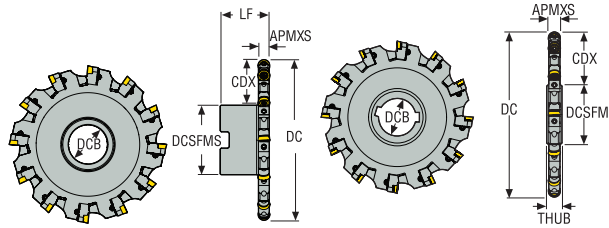

- For insert selection and cutting data recommendations, see page(s) 488-493
- For complete insert programme, see page(s) 839, 841
- For spare parts and technical information, see page 462-468
- For ISO attribute explanation, see page 16

Designation	Item number	Type of mounting	DC	APMXS	CDX	ZFP	DCB	DCSFMS	THUB	LF	RPMX	Weight	Insert
			inch	inch	inch		inch	inch	inch	inch		lbs	
335.18-08.00-XL0708L-R5	02740251	Arbor hole	8.000	0.197	2.421	14	2.000	3.000	0.625	0.115	6700	3.970	RD..10
335.18-10.00-XL0708L-R5	02740532	Arbor hole	10.000	0.197	3.386	18	2.000	3.000	0.625	0.115	6000	6.610	RD..10
335.18-12.00-XL0708L-R5	02740889	Arbor hole	12.000	0.197	4.390	22	2.000	3.000	0.625	0.115	5300	9.700	RD..10
R335.18-08.00-XL0708L-R5	02740910	Arbor	8.000	0.197	2.224	14	1.500	3.500	-	1.606	6700	6.830	RD..10
R335.18-10.00-XL0708L-R5	02741572	Arbor	10.000	0.197	3.248	18	1.500	3.500	-	1.606	6000	9.260	RD..10
335.18-05.00-0809L-R6	02599499	Arbor hole	5.079	0.236	1.324	10	1.500	2.252	0.625	0.078	8400	1.980	RP..12
335.18-06.00-0809L-R6	02599500	Arbor hole	6.079	0.236	1.829	12	1.500	2.252	0.625	0.078	7500	2.870	RP..12
335.18-08.00-XL0809L-R6	02740252	Arbor hole	8.000	0.236	2.421	14	2.000	3.000	0.625	0.078	6700	4.850	RP..12
335.18-10.00-XL0809L-R6	02740534	Arbor hole	10.000	0.236	3.386	18	2.000	3.000	0.625	0.078	6000	7.940	RP..12
335.18-12.00-XL0809L-R6	02740891	Arbor hole	12.000	0.236	4.390	22	2.000	3.000	0.625	0.078	5300	11.900	RP..12
R335.18-08.00-XL0809L-R6	02740911	Arbor	8.000	0.236	2.224	14	1.500	3.500	-	1.528	6700	7.720	RP..12
R335.18-10.00-XL0809L-R6	02741574	Arbor	10.000	0.236	3.248	18	1.500	3.500	-	1.528	6000	10.800	RP..12
R335.18-04.00-0809L-R6	02599491	Arbor	4.079	0.236	1.063	4	1.000	1.880	-	1.528	9400	2.430	RP..12
R335.18-05.00-0809L-R6	02599492	Arbor	5.079	0.236	1.368	10	1.250	2.250	-	1.528	8400	3.530	RP..12
R335.18-06.00-0809L-R6	02599493	Arbor	6.079	0.236	1.624	12	1.500	2.750	-	1.528	7500	4.190	RP..12

Square shoulder and slot milling cutters

Helical milling cutters

Face milling cutters

Disc milling cutters

High feed milling cutters

Copy milling cutters

Plunge milling cutters

Chamfer milling cutters

Spot facing cutters

Inserts



335.25

Easy to use, strong and free-cutting disc milling cutter system dedicated for large width of cut slotting, or half side and face cutting operations

- Width of cut 13.5-32 mm (.512 - 1.25 inch) - slot with flat bottom
- Cutter range diameter 80-315 mm (4.0 - 12 inch)
- Fixed or adjustable cutting width with replaceable cassettes
- Available with Arbor or Arbor hole connection , with through coolant option up to diameter 160mm
- Corner radii range 0.4-6 mm (.016 - 0.236 inch), and possibility to apply round insert dia 16/20 mm on adjustable system
- Economical solution with 4 cutting edges per insert
- Basic tolerance of the slot: Fixed pocket cutters: $\pm 0.08\text{mm}$ ($\pm 0.003''$), Adjustable cutter: $\pm 0.07\text{mm}$ ($\pm 0.0025''$)

Width 15/20/25 mm - Full side and face - Fixed pocket

Cutter 335.25 - Insert XNHQ/LNHQ – Metric

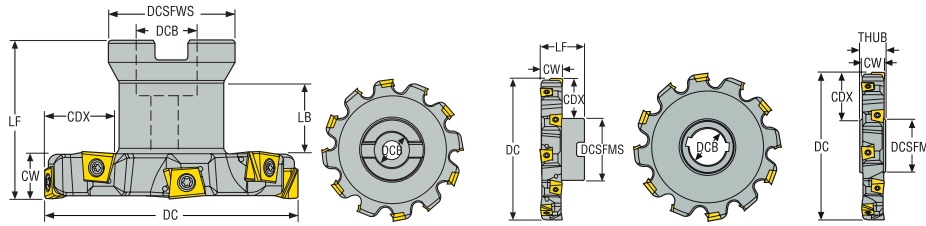





- For insert selection and cutting data recommendations, see page(s) 471-478
- For complete insert programme, see page(s) 864, 865
- For spare parts and technical information, see page 462-468
- For ISO attribute explanation, see page 16

Designation	Item number	Type of mounting	DC	CW	CDX	ZEFP	ZNP	DCB	DCSFMS	THUB	LF	LB	Through coolant	RPMX	Weight	Insert:	
																First choice	Alternative choice
R335.25-080.15.22-4NA	02989533	Arbor	80,0	15,0	22,7	4	8	22,0	40,0	–	50,0	21,4	✓	10200	0,6	XNHQ09...	–
R335.25-100.15.27-5NA	02989535	Arbor	100,0	15,0	25,3	5	10	27,0	48,0	–	50,0	–	✓	9200	1,0	XNHQ09...	–
R335.25-125.15.32-6NA	02989541	Arbor	125,0	15,0	32,8	6	12	32,0	58,0	–	50,0	–	✓	8200	1,5	XNHQ09...	–
R335.25-160.15.40-7NA	02989542	Arbor	160,0	15,0	44,3	7	14	40,0	70,0	–	50,0	–	✓	7200	2,4	XNHQ09...	–
335.25-160.15.40-7N	02989544	Arbor hole	160,0	15,0	52,0	7	14	40,0	55,0	15,0	15,0	–	–	7200	1,7	XNHQ09...	–
R335.25-200.15.40-8N	02989543	Arbor	200,0	15,0	54,3	8	16	40,0	90,0	–	50,0	–	–	6500	3,6	XNHQ09...	–
335.25-200.15.50-8N	02989545	Arbor hole	200,0	15,0	64,5	8	16	50,0	69,0	15,0	15,0	–	–	6500	2,6	XNHQ09...	–
R335.25-100.20.27-4NA	02953594	Arbor	100,0	20,0	25,3	4	8	27,0	48,0	–	50,0	–	✓	7200	1,2	XNHQ12...	–
R335.25-125.20.32-5NA	02953595	Arbor	125,0	20,0	32,8	5	10	32,0	58,0	–	50,0	–	✓	6500	1,8	XNHQ12...	–
R335.25-160.20.40-6NA	02953596	Arbor	160,0	20,0	44,3	6	12	40,0	70,0	–	50,0	–	✓	5700	2,9	XNHQ12...	–
335.25-160.20.40-6N	02961517	Arbor hole	160,0	20,0	51,5	6	12	40,0	55,0	20,0	20,0	–	–	5600	2,2	XNHQ12...	–
R335.25-200.20.40-7N	02953597	Arbor	200,0	20,0	54,3	7	14	40,0	90,0	–	50,0	–	–	5100	5,1	XNHQ12...	–
335.25-200.20.50-7N	02961518	Arbor hole	200,0	20,0	64,3	7	14	50,0	69,0	20,0	20,0	–	–	5100	3,5	XNHQ12...	–
R335.25-250.20.60-9N	02953598	Arbor	250,0	20,0	59,3	9	18	60,0	130,0	–	50,0	–	–	4600	7,2	XNHQ12...	–
335.25-250.20.50-9N	02961519	Arbor hole	250,0	20,0	88,5	9	18	50,0	71,0	20,0	20,0	–	–	4600	5,8	XNHQ12...	–
R335.25-125.25.32-5NA	02788023	Arbor	125,0	25,0	33,0	5	10	32,0	58,0	–	50,0	–	✓	4900	1,9	XNHQ1407... LNHQ1407...	–
R335.25-160.25.40-6NA	02788024	Arbor	160,0	25,0	44,4	6	12	40,0	70,0	–	50,0	–	✓	4400	3,1	XNHQ1407... LNHQ1407...	–
335.25-160.25.40-6N	02788027	Arbor hole	160,0	25,0	50,7	6	12	40,0	55,0	32,0	25,0	–	–	4400	2,7	XNHQ1407... LNHQ1407...	–
R335.25-200.25.40-7N	02788025	Arbor	200,0	25,0	54,5	7	14	40,0	90,0	–	50,0	–	–	3900	5,0	XNHQ1407... LNHQ1407...	–
335.25-200.25.50-7N	02788028	Arbor hole	200,0	25,0	62,7	7	14	50,0	71,0	32,0	25,0	–	–	3900	4,3	XNHQ1407... LNHQ1407...	–
335.25-250.25.50-9N	02788029	Arbor hole	250,0	25,0	87,7	9	18	50,0	71,0	32,0	25,0	–	–	3500	7,3	XNHQ1407... LNHQ1407...	–
R335.25-250.25.60-9N	02788026	Arbor	250,0	25,0	59,5	9	18	60,0	130,0	–	50,0	–	–	3500	8,3	XNHQ1407... LNHQ1407...	–

Square shoulder and slot milling cutters
Helical milling cutters
Face milling cutters
Disc milling cutters
High feed milling cutters
Copy milling cutters
Plunge milling cutters
Chamfer milling cutters
Spot facing cutters
Inserts

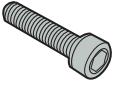
Spare Parts, included in delivery

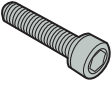
Accessories

	Spare Parts, included in delivery			Accessories			
	For cutter	Arbor screw	Insert key	Insert screw	Arbor screw	Insert clamping torque	Torque key
Square shoulder and slot milling cutters							
Helical milling cutters	R335.25 CW=15 DC=80	MLC6S10X45	H4B-T10P	C03509-T10P	-	3.0NM	T00-10P30
	R335.25 CW=15 DC=100	MLC6S12X50	H4B-T10P	C03509-T10P	-	3.0NM	T00-10P30
	R335.25 CW=15 DC=125	950E1645	H4B-T10P	C03509-T10P	-	3.0NM	T00-10P30
	R335.25 CW=15 DC=160	MLC6S20X40	H4B-T10P	C03509-T10P	-	3.0NM	T00-10P30
	335.25 CW=15	-	H4B-T10P	C03509-T10P	-	3.0NM	T00-10P30
Face milling cutters	R335.25 CW=15 DC=200	-	-	C03509-T10P	MC6S12X50	3.0NM	T00-10P30
	R335.25 CW=20 DC=100	MLC6S12X50	H4B-T10P	C03511-T10P	-	3.0NM	T00-10P30
	R335.25 CW=20 DC=125	950E1645	H4B-T10P	C03511-T10P	-	3.0NM	T00-10P30
	R335.25 CW=20 DC=160	MLC6S20X40	H4B-T10P	C03511-T10P	-	3.0NM	T00-10P30
	335.25 CW=20	-	H4B-T10P	C03511-T10P	-	3.0NM	T00-10P30
Disc milling cutters	R335.25 CW=20 DC=200	-	H4B-T10P	C03511-T10P	MC6S12X50	3.0NM	T00-10P30
	R335.25 CW=20 DC=250	-	H4B-T10P	C03511-T10P	MC6S16X50	3.0NM	T00-10P30
	R335.25 CW=25 DC=125	MLC6S16X35	H4B-T15PL	C04013-T15P	-	5.0NM	T00-15P50
	R335.25 CW=25 DC=160	MLC6S20X40	H4B-T15PL	C04013-T15P	-	5.0NM	T00-15P50
	335.25 CW=25	-	H4B-T15PL	C04013-T15P	-	5.0NM	T00-15P50
	R335.25 CW=25 DC=200	-	H4B-T15PL	C04013-T15P	MC6S12X50	5.0NM	T00-15P50
High feed milling cutters	R335.25 CW=25 DC=250	-	H4B-T15PL	C04013-T15P	MC6S16X50	5.0NM	T00-15P50
Copy milling cutters							
Plunge milling cutters							
Chamfer milling cutters							
Spot facing cutters							
Inserts							

Width 0.750/1.000" - Full side and face - Fixed pocket

Cutter 335.25 - Insert XNHQ/LNHQ - inch

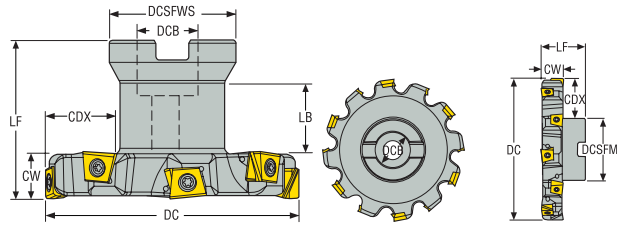









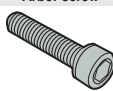









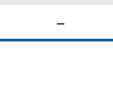









- For insert selection and cutting data recommendations, see page(s) 473-478
- For complete insert programme, see page(s) 864, 865
- For spare parts and technical information, see page 462-468
- For ISO attribute explanation, see page 16

Designation	Item number	Type of mounting	DC	CW	CDX	ZFP	ZNP	DCB	DCSFMS	THUB	LF	LB	Through coolant	RPMX	Weight	Insert:	
																First choice	Alternative choice
R335.25-05.00-0.75-5NA	02989512	Arbor	5.000	0.750	1.331	5	10	1.250	2.283	-	2.000	-	✓	6500	4.190	XNHQ12	-
R335.25-06.00-0.75-6NA	02989513	Arbor	6.000	0.750	1.595	6	12	1.500	2.756	-	2.000	-	✓	5700	5.950	XNHQ12	-
R335.25-05.00-1.000-5NA	02788030	Arbor	5.000	1.000	1.350	5	10	1.250	2.250	-	2.000	-	✓	4900	4.190	XNHQ14	LNHQ14
R335.25-06.00-1.000-6NA	02788031	Arbor	6.000	1.000	1.598	6	12	1.500	2.750	-	2.000	-	✓	4400	6.390	XNHQ14	LNHQ14
335.25-06.00-1.000-6N	02788034	Arbor hole	6.000	1.000	1.846	6	12	1.500	2.252	1.250	1.000	-	-	4400	6.390	XNHQ14	LNHQ14
R335.25-08.00-1.000-7N	02788032	Arbor	8.000	1.000	2.224	7	14	1.500	3.500	-	2.000	-	-	3900	11.680	XNHQ14	LNHQ14
335.25-10.00-1.000-9N	02788036	Arbor hole	10.000	1.000	3.429	9	18	2.000	3.000	1.250	1.000	-	-	3500	16.530	XNHQ14	LNHQ14

Spare Parts, included in delivery

Accessories

For cutter	Arbor screw	Insert key	Insert screw	Insert clamping torque	Torque key
R335.25 CW 0.750 DC=5.000	 ULC6S5/8UNFX11/2	 H4B-T10P	 C03511-T10P	 26.6IN.LBS	 T00-10P30
R335.25 CW 0.750 DC=6.000	 ULC6S3/4UNFX11/2	 H4B-T10P	 C03511-T10P	 26.6IN.LBS	 T00-10P30
R335.25 CW 1.000 DC=5.000	 ULC6S5/8UNFX11/2	 H4B-T15PL	 C04013-T15P	 44.3IN.LBS	 T00-15P50
R335.25 CW 1.000 DC=6.000	 ULC6S5/8UNFX11/2	 H4B-T15PL	 C04013-T15P	 44.3IN.LBS	 T00-15P50
335.25 CW 1.000	-	 H4B-T15PL	 C04013-T15P	 44.3IN.LBS	 T00-15P50
R335.25 CW 1.000 DC=8.000	-	 H4B-T15PL	 C04013-T15P	 44.3IN.LBS	 T00-15P50

Square shoulder and slot milling cutters

Helical milling cutters

Face milling cutters

Disc milling cutters

High feed milling cutters

Copy milling cutters

Plunge milling cutters

Chamfer milling cutters

Spot facing cutters

Inserts

Cutter 335.25 - Insert XNHQ – Metric

Width 13,5 - 21 mm - Full side and face - Adjustable design

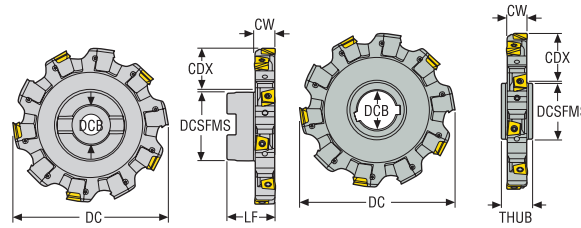

- For insert selection and cutting data recommendations, see page(s) 471-478
- For complete insert programme, see page(s) 864, 865
- For spare parts and technical information, see page 462-468
- For ISO attribute explanation, see page 16

Designation	Item number	Type of mounting	DC	CWN	CWX	CDX	ZEFP	ZNP	DCB	DCSFMS	THUB	LF	RPMX	Weight	Insert
			mm	mm	mm	mm			mm	mm	mm	mm		kg	
R335.25-100.1317.27-3N	02993725	Arbor	100,0	13,5	17,0	24,8	3	6	27,0	48,0	–	50,0	9200	1,0	XNHQ09..
R335.25-125.1317.32-4N	02993726	Arbor	125,0	13,5	17,0	32,3	4	8	32,0	58,0	–	50,0	8200	1,4	XNHQ09..
335.25-125.1317.40-4N	02993731	Arbor hole	125,0	13,5	17,0	32,9	4	8	40,0	55,0	17,0	15,25	8200	0,9	XNHQ09..
R335.25-160.1317.40-6N	02993727	Arbor	160,0	13,5	17,0	43,8	6	12	40,0	70,0	–	50,0	7200	2,3	XNHQ09..
335.25-160.1317.40-6N	02993732	Arbor hole	160,0	13,5	17,0	50,5	6	12	40,0	55,0	17,0	15,25	7200	1,5	XNHQ09..
R335.25-200.1317.40-7N	02993728	Arbor	200,0	13,5	17,0	54,0	7	14	40,0	90,0	–	50,0	6500	3,6	XNHQ09..
335.25-200.1317.50-7N	02993733	Arbor hole	200,0	13,5	17,0	63,5	7	14	50,0	69,0	17,0	15,25	6500	2,5	XNHQ09..
R335.25-250.1317XL.60-8N	02993729	Arbor	250,0	13,5	17,0	59,0	8	16	60,0	130,0	–	50,0	5800	6,0	XNHQ09..
335.25-250.1317XL.50-8N	02993734	Arbor hole	250,0	13,5	17,0	88,5	8	16	50,0	69,0	17,0	15,25	5800	3,9	XNHQ09..
R335.25-315.1317XL.60-10N	02993730	Arbor	315,0	13,5	17,0	91,5	10	20	60,0	130,0	–	50,0	5200	8,6	XNHQ09..
335.25-315.1317XL.50-10N	02993735	Arbor hole	315,0	13,5	17,0	121,0	10	20	50,0	69,0	17,0	15,25	5200	6,5	XNHQ09..
R335.25-100.1721.27-3N	02993714	Arbor	100,0	17,0	21,0	24,8	3	6	27,0	48,0	–	50,0	7200	1,1	XNHQ12..
R335.25-125.1721.32-4N	02993715	Arbor	125,0	17,0	21,0	32,3	4	8	32,0	58,0	–	50,0	6500	1,6	XNHQ12..
335.25-125.1721.40-4N	02993720	Arbor hole	125,0	17,0	21,0	32,9	4	8	40,0	55,0	21,0	19,0	8200	1,1	XNHQ12..
R335.25-160.1721.40-5N	02993716	Arbor	160,0	17,0	21,0	43,8	5	10	40,0	70,0	–	50,0	5700	2,7	XNHQ12..
335.25-160.1721.40-5N	02993721	Arbor hole	160,0	17,0	21,0	50,5	5	10	40,0	55,0	21,0	19,0	7200	1,9	XNHQ12..
R335.25-200.1721.40-6N	02993717	Arbor	200,0	17,0	21,0	54,0	6	12	40,0	90,0	–	50,0	5100	4,1	XNHQ12..
335.25-200.1721.50-6N	02993722	Arbor hole	200,0	17,0	21,0	63,5	6	12	50,0	69,0	21,0	19,0	5100	3,2	XNHQ12..
R335.25-250.1721XL.60-8N	02993718	Arbor	250,0	17,0	21,0	59,0	8	16	60,0	130,0	–	50,0	4600	6,7	XNHQ12..
335.25-250.1721XL.50-8N	02993723	Arbor hole	250,0	17,0	21,0	88,5	8	16	50,0	69,0	21,0	19,0	5800	4,9	XNHQ12..
R335.25-315.1721XL.60-10N	02993719	Arbor	315,0	17,0	21,0	91,5	10	20	60,0	130,0	–	50,0	4100	10,0	XNHQ12..
335.25-315.1721XL.50-10N	02993724	Arbor hole	315,0	17,0	21,0	121,0	10	20	50,0	69,0	21,0	19,0	5200	8,2	XNHQ12..

All listed adjustable cutters are set to the minimum cutter width CWN (factory setting).
Adjustable cutter may be ordered with the cutting width set to any value within its range (CWN - CWX), see technical data for more info at page 462

Width 21 - 32 mm - Full side and face - Adjustable design

Cutter 335.25 - Insert XNHQ/LNHQ – Metric

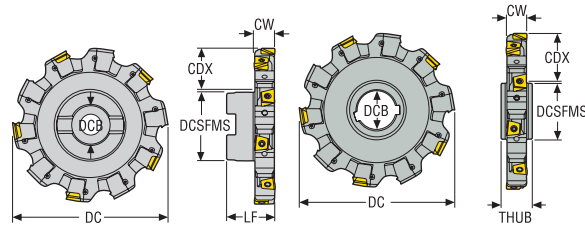

- For insert selection and cutting data recommendations, see page(s) 475-478
- For complete insert programme, see page(s) 864, 865
- For spare parts and technical information, see page 462-468
- For ISO attribute explanation, see page 16

Designation	Item number	Type of mounting	DC	CWN	CWX	CDX	ZEFP	ZNP	DCB	DCSFMS	THUB	LF	RPMX	Weight	Insert:	
															First choice	Alternative choice
R335.25-125.2126.32-4N	02814578	Arbor	125,0	21,0	26,0	32,3	4	8	32,0	58,0	-	50,0	4900	1,7	XNHQ1407...	LNHQ1407...
335.25-125.2126.40-4N	02814599	Arbor hole	125,0	21,0	26,0	32,7	4	8	40,0	55,0	32,0	26,5	4900	1,3	XNHQ1407...	LNHQ1407...
R335.25-160.2126.40-5N	02814582	Arbor	160,0	21,0	26,0	43,8	5	10	40,0	70,0	-	50,0	4400	2,9	XNHQ1407...	LNHQ1407...
335.25-160.2126.40-5N	02814603	Arbor hole	160,0	21,0	26,0	50,3	5	10	40,0	55,0	32,0	26,5	4400	2,3	XNHQ1407...	LNHQ1407...
R335.25-200.2126.40-6N	02814586	Arbor	200,0	21,0	26,0	54,0	6	12	40,0	90,0	-	50,0	3900	4,6	XNHQ1407...	LNHQ1407...
335.25-200.2126.50-6N	02814607	Arbor hole	200,0	21,0	26,0	63,3	6	12	50,0	69,0	32,0	26,5	3900	3,9	XNHQ1407...	LNHQ1407...
R335.25-250.2126XL.60-7N	02814590	Arbor	250,0	21,0	26,0	59,0	7	14	60,0	130,0	-	50,0	3500	7,3	XNHQ1407...	LNHQ1407...
335.25-250.2126XL.50-7N	02814611	Arbor hole	250,0	21,0	26,0	88,3	7	14	50,0	69,0	32,0	26,5	3500	6,0	XNHQ1407...	LNHQ1407...
R335.25-315.2126XL.60-9N	02814594	Arbor	315,0	21,0	26,0	91,5	9	18	60,0	130,0	-	50,0	3100	11,3	XNHQ1407...	LNHQ1407...
335.25-315.2126XL.60-9N	02814615	Arbor hole	315,0	21,0	26,0	113,3	9	18	60,0	84,0	32,0	26,5	3100	10,0	XNHQ1407...	LNHQ1407...
R335.25-160.2632.40-5N	02827411	Arbor	160,0	26,0	32,0	43,8	5	10	40,0	70,0	-	50,0	4600	3,4	XNHQ1707...	LNHQ1707...
335.25-160.2632.40-5N	02829065	Arbor hole	160,0	26,0	32,0	50,3	5	10	40,0	55,0	32,0	29,0	4600	2,9	XNHQ1707...	LNHQ1707...
R335.25-200.2632.40-6N	02827415	Arbor	200,0	26,0	32,0	54,0	6	12	40,0	90,0	-	50,0	4100	5,3	XNHQ1707...	LNHQ1707...
335.25-200.2632.50-6N	02827441	Arbor hole	200,0	26,0	32,0	63,3	6	12	50,0	69,0	32,0	29,0	4100	4,8	XNHQ1707...	LNHQ1707...
R335.25-250.2632XL.60-7N	02827419	Arbor	250,0	26,0	32,0	59,0	7	14	60,0	130,0	-	50,0	3700	8,4	XNHQ1707...	LNHQ1707...
335.25-250.2632XL.50-7N	02827445	Arbor hole	250,0	26,0	32,0	88,3	7	14	50,0	69,0	32,0	29,0	3700	7,4	XNHQ1707...	LNHQ1707...
R335.25-315.2632XL.60-9N	02827423	Arbor	315,0	26,0	32,0	91,5	9	18	60,0	130,0	-	50,0	3300	13,4	XNHQ1707...	LNHQ1707...
335.25-315.2632XL.60-9N	02827449	Arbor hole	315,0	26,0	32,0	113,3	9	18	60,0	84,0	32,0	29,0	3300	12,3	XNHQ1707...	LNHQ1707...

All listed adjustable cutters are set to the minimum cutter width CWN (factory setting).

Adjustable cutter may be ordered with the cutting width set to any value within its range (CWN - CWX), see technical data for more info at page 462

Square shoulder and slot milling cutters

Helical milling cutters

Face milling cutters

Disc milling cutters

High feed milling cutters

Copy milling cutters

Plunge milling cutters

Chamfer milling cutters

Spot facing cutters

Inserts

Cutter 335.25 - Insert XNHQ – inch

Width 0.53-0.83" - Full side and face - Adjustable design

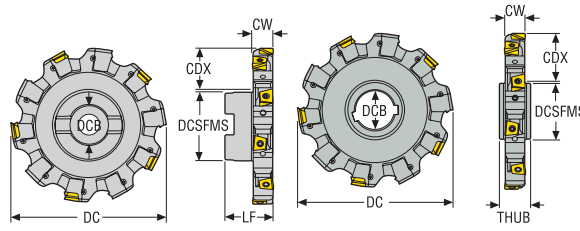

- For insert selection and cutting data recommendations, see page(s) 471-474
- For complete insert programme, see page(s) 864, 865
- For spare parts and technical information, see page 462-468
- For ISO attribute explanation, see page 16

Designation	Item number	Type of mounting	DC	CWN	CWX	CDX	ZEFP	ZNP	DCB	DCSFMS	THUB	LF	RPMX	Weight	Insert
			inch	inch	inch	inch			inch	inch	inch	inch		lbs	
R335.25-04.00-0911N	02993907	Arbor	4.000	0.531	0.669	1.014	3	6	1.000	1.880	–	2.000	9200	2.870	XNHQ09
R335.25-05.00-0911N	02993911	Arbor	5.000	0.531	0.669	1.329	4	8	1.250	2.250	–	2.000	8200	18.740	XNHQ09
335.25-05.00-0911N	02993931	Arbor hole	5.000	0.531	0.669	1.289	4	8	1.500	2.250	0.750	0.641	8200	1.980	XNHQ09
R335.25-06.00-0911N	02993915	Arbor	6.000	0.531	0.669	1.579	5	10	1.500	2.750	–	2.000	7200	4.850	XNHQ09
335.25-06.00-0911N	02993935	Arbor hole	6.000	0.531	0.669	1.795	5	10	1.500	2.250	0.750	0.641	7200	3.750	XNHQ09
R335.25-08.00-0911N	02993919	Arbor	8.000	0.531	0.669	2.210	7	14	1.500	3.500	–	2.000	6500	9.260	XNHQ09
335.25-08.00-0911N	02993939	Arbor hole	8.000	0.531	0.669	2.420	7	14	2.000	3.000	0.750	0.641	6500	5.730	XNHQ09
R335.25-10.00-XL0911N	02993923	Arbor	10.000	0.531	0.669	2.400	8	16	2.500	5.120	–	2.000	5800	13.450	XNHQ09
335.25-10.00-XL0911N	02993943	Arbor hole	10.000	0.531	0.669	3.420	8	16	2.000	3.000	0.750	0.641	5800	9.040	XNHQ09
R335.25-12.00-XL0911N	02993927	Arbor	12.000	0.531	0.669	3.400	10	20	2.500	5.120	–	2.000	5200	17.860	XNHQ09
335.25-12.00-XL0911N	02993947	Arbor hole	12.000	0.531	0.669	4.460	10	20	2.000	3.000	0.750	0.641	5200	13.450	XNHQ09
R335.25-04.00-1113N	02993850	Arbor	4.000	0.669	0.827	1.014	3	6	1.000	1.880	–	2.000	7200	2.430	XNHQ12
R335.25-05.00-1113N	02993854	Arbor	5.000	0.669	0.827	1.329	4	8	1.250	2.250	–	2.000	6500	3.750	XNHQ12
335.25-05.00-1113N	02993881	Arbor hole	5.000	0.669	0.827	1.289	4	8	1.500	2.250	1.000	0.835	6500	2.650	XNHQ12
R335.25-06.00-1113N	02993858	Arbor	6.000	0.669	0.827	1.579	5	10	1.500	2.750	–	2.000	5700	5.510	XNHQ12
335.25-06.00-1113N	02993885	Arbor hole	6.000	0.669	0.827	1.795	5	10	1.500	2.250	1.000	0.835	5700	4.630	XNHQ12
R335.25-08.00-1113N	02993862	Arbor	8.000	0.669	0.827	2.210	6	12	1.500	3.500	–	2.000	5100	10.800	XNHQ12
335.25-08.00-1113N	02993889	Arbor hole	8.000	0.669	0.827	2.420	6	12	2.000	3.000	1.000	0.835	5100	9.920	XNHQ12
R335.25-10.00-XL1113N	02993866	Arbor	10.000	0.669	0.827	2.400	8	16	2.500	5.120	–	2.000	4600	15.210	XNHQ12
335.25-10.00-XL1113N	02993893	Arbor hole	10.000	0.669	0.827	3.420	8	16	2.000	3.000	1.000	0.835	4600	13.890	XNHQ12
R335.25-12.00-XL1113N	02993870	Arbor	12.000	0.669	0.827	3.400	10	20	2.500	5.120	–	2.000	4100	20.720	XNHQ12
335.25-12.00-XL1113N	02993897	Arbor hole	12.000	0.669	0.827	4.420	10	20	2.000	3.000	1.000	0.835	4100	16.980	XNHQ12

All listed adjustable cutters are set to the minimum cutter width CWN (factory setting).
Adjustable cutter may be ordered with the cutting width set to any value within its range (CWN - CWX), see technical data for more info at page 462

Width 0.83-1.26" - Full side and face - Adjustable design

Cutter 335.25 - Insert XNHQ/LNHQ - inch

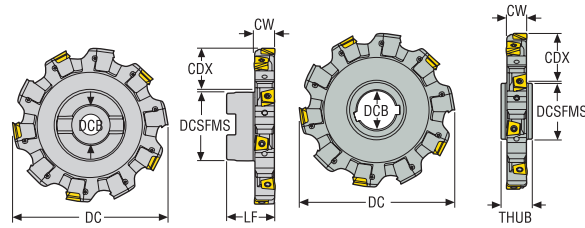

- For insert selection and cutting data recommendations, see page(s) 475-478
- For complete insert programme, see page(s) 864, 865
- For spare parts and technical information, see page 462-468
- For ISO attribute explanation, see page 16

Designation	Item number	Type of mounting	DC	CWN	CWX	CDX	ZEPF	ZNP	DCB	DCSFMS	THUB	LF	RPMX	Weight	Insert:		
															First choice	Alternative choice	
			inch	inch	inch	inch			inch	inch	inch	inch			lbs		
R335.25-05.00-1316N	02814619	Arbor	5.000	0.827	1.024	1.327	4	8	1.250	2.250	-	2.000	4900	3.970	XNHQ14	LNHQ14	
335.25-05.00-1316N	02814639	Arbor hole	5.000	0.827	1.024	1.291	4	8	1.500	2.250	1.250	1.038	4900	3.090	XNHQ14	LNHQ14	
R335.25-06.00-1316N	02814623	Arbor	6.000	0.827	1.024	1.579	5	10	1.500	2.750	-	2.000	4500	5.950	XNHQ14	LNHQ14	
335.25-06.00-1316N	02814643	Arbor hole	6.000	0.827	1.024	1.791	5	10	1.500	2.250	1.250	1.038	4500	4.630	XNHQ14	LNHQ14	
R335.25-08.00-1316N	02814627	Arbor	8.000	0.827	1.024	2.209	6	12	1.500	3.500	-	2.000	3900	10.800	XNHQ14	LNHQ14	
335.25-08.00-1316N	02814647	Arbor hole	8.000	0.827	1.024	2.413	6	12	2.000	3.000	1.250	1.038	3900	9.040	XNHQ14	LNHQ14	
R335.25-10.00-XL1316N	02814631	Arbor	10.000	0.827	1.024	2.402	7	14	2.500	5.118	-	2.000	3500	16.530	XNHQ14	LNHQ14	
335.25-10.00-XL1316N	02814651	Arbor hole	10.000	0.827	1.024	3.413	7	14	2.000	3.000	1.250	1.038	3500	13.890	XNHQ14	LNHQ14	
R335.25-12.00-XL1316N	02814635	Arbor	12.000	0.827	1.024	3.402	9	18	2.500	5.118	-	2.000	3200	23.150	XNHQ14	LNHQ14	
335.25-12.00-XL1316N	02814655	Arbor hole	12.000	0.827	1.024	4.413	9	18	2.000	3.000	1.250	1.038	3200	20.500	XNHQ14	LNHQ14	
R335.25-06.00-1620N	02827713	Arbor	6.000	1.024	1.260	1.579	5	10	1.500	2.750	-	2.000	4700	6.830	XNHQ17	LNHQ17	
335.25-06.00-1620N	02827735	Arbor hole	6.000	1.024	1.260	1.791	5	10	1.500	2.250	1.250	1.137	4700	5.730	XNHQ17	LNHQ17	
R335.25-08.00-1620N	02827717	Arbor	8.000	1.024	1.260	2.209	6	12	1.500	3.500	-	2.000	4100	12.570	XNHQ17	LNHQ17	
335.25-08.00-1620N	02827740	Arbor hole	8.000	1.024	1.260	2.413	6	12	2.000	3.000	1.250	1.137	4100	11.020	XNHQ17	LNHQ17	
R335.25-10.00-XL1620N	02827721	Arbor	10.000	1.024	1.260	2.402	7	14	2.500	5.118	-	2.000	3600	18.960	XNHQ17	LNHQ17	
335.25-10.00-XL1620N	02827744	Arbor hole	10.000	1.024	1.260	3.413	7	14	2.000	3.000	1.250	1.137	3600	16.980	XNHQ17	LNHQ17	
R335.25-12.00-XL1620N	02827725	Arbor	12.000	1.024	1.260	3.402	9	18	2.500	5.118	-	2.000	3300	27.120	XNHQ17	LNHQ17	
335.25-12.00-XL1620N	02827748	Arbor hole	12.000	1.024	1.260	4.413	9	18	2.000	3.000	1.250	1.137	3300	25.350	XNHQ17	LNHQ17	

All listed adjustable cutters are set to the minimum cutter width CWN (factory setting).

Adjustable cutter may be ordered with the cutting width set to any value within its range (CWN - CWX), see technical data for more info at page 462

Square shoulder and slot milling cutters

Helical milling cutters

Face milling cutters

Disc milling cutters

High feed milling cutters

Copy milling cutters

Plunge milling cutters

Chamfer milling cutters

Spot facing cutters

Inserts

Cutter 335.25 - Insert RP..1605/RP..2006 – Metric

Width 16-21 mm - full side - radius profile - Adjustable design

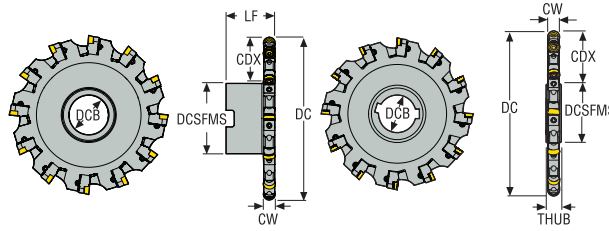

- For insert selection and cutting data recommendations, see page(s) 494-499
- For complete insert programme, see page(s) 842
- For spare parts and technical information, see page 462-468
- For ISO attribute explanation, see page 16

Designation	Item number	Type of mounting	DC	CWN	CWX	CDX	ZEFP	ZNP	DCB	DCSFMS	THUB	LF	RPMX	Weight	Insert
			mm	mm	mm	mm			mm	mm	mm	mm		kg	
R335.25-100.1317.27-3N-R8	02993815	Arbor	105,0	16,03	17,0	28,0	3	6	27,0	48,0	–	51,265	9200	1,0	RP..1605
R335.25-125.1317.32-4N-R8	02993818	Arbor	130,0	16,03	17,0	35,5	4	8	32,0	58,0	–	51,265	8200	1,4	RP..1605
335.25-125.1317.40-4N-R8	02993833	Arbor hole	130,0	16,03	17,0	36,0	4	8	40,0	55,0	17,0	16,52	8200	1,0	RP..1605
R335.25-160.1317.40-6N-R8	02993821	Arbor	165,0	16,03	17,0	47,0	6	12	40,0	70,0	–	51,265	7200	2,3	RP..1605
335.25-160.1317.40-6N-R8	02993836	Arbor hole	165,0	16,03	17,0	53,5	6	12	40,0	55,0	17,0	16,52	7200	1,5	RP..1605
R335.25-200.1317.40-7N-R8	02993824	Arbor	205,0	16,03	17,0	57,0	7	14	40,0	90,0	–	51,265	6500	3,8	RP..1605
335.25-200.1317.50-7N-R8	02993839	Arbor hole	205,0	16,03	17,0	66,5	7	14	50,0	69,0	17,0	16,52	6500	2,4	RP..1605
R335.25-250.1317XL.60-8N-R8	02993827	Arbor	255,0	16,03	17,0	62,0	8	16	60,0	130,0	–	51,265	5800	10,3	RP..1605
335.25-250.1317XL.50-8N-R8	02993842	Arbor hole	255,0	16,03	17,0	91,5	8	16	50,0	69,0	17,0	16,52	5800	3,9	RP..1605
R335.25-315.1317XL.60-10N-R8	02993830	Arbor	320,0	16,03	17,0	94,5	10	20	60,0	130,0	–	51,265	5200	8,6	RP..1605
335.25-315.1317XL.50-10N-R8	02993845	Arbor hole	320,0	16,03	17,0	124,0	10	20	50,0	69,0	17,0	16,52	5200	6,5	RP..1605
R335.25-250.1721XL.60-8N-R10	02993754	Arbor	255,0	20,03	21,0	62,0	8	16	60,0	130,0	–	51,515	4600	6,6	RP..2006
335.25-250.1721XL.50-8N-R10	02993775	Arbor hole	255,0	20,03	21,0	91,5	8	16	50,0	69,0	21,0	20,52	4600	4,9	RP..2006
R335.25-315.1721XL.60-10N-R10	02993757	Arbor	320,0	20,03	21,0	94,5	10	20	60,0	130,0	–	51,515	4100	9,9	RP..2006
335.25-315.1721XL.50-10N-R10	02993778	Arbor hole	320,0	20,03	21,0	124,1	10	20	50,0	69,0	21,0	20,52	4100	10,0	RP..2006

All listed adjustable cutters are set to the minimum cutter width CWN (factory setting).
Adjustable cutter may be ordered with the cutting width set to any value within its range (CWN - CWX), see technical data for more info at page 462

Square shoulder and slot milling cutters
Helical milling cutters
Face milling cutters
Disc milling cutters
High feed milling cutters
Copy milling cutters
Plunge milling cutters
Chamfer milling cutters
Spot facing cutters
Inserts

Width 0.631-0.827" - full side - radius profile - Adjustable design

Cutter 335.25 - Insert RP..1605/RP..2006 – inch

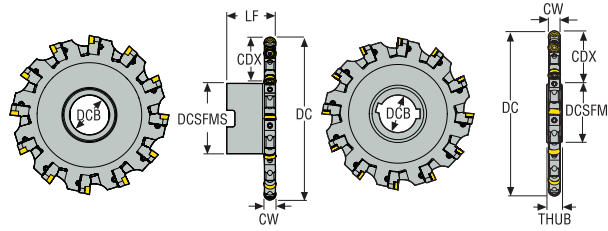

- For insert selection and cutting data recommendations, see page(s) 494-499
- For complete insert programme, see page(s) 842
- For spare parts and technical information, see page 462-468
- For ISO attribute explanation, see page 16

Designation	Item number	Type of mounting	DC	CWN	CWX	CDX	ZEP	ZNP	DCB	DCSFMS	THUB	LF	RPMX	Weight	Insert
			inch	inch	inch	inch			inch	inch	inch	inch		lbs	
335.25-05.00-0911N-R8	02993969	Arbor hole	5.197	0.631	0.669	1.415	4	8	1.500	2.250	0.750	0.691	8200	2.200	RP..1605
335.25-06.00-0911N-R8	02993972	Arbor hole	6.197	0.631	0.669	1.914	5	10	1.500	2.250	0.750	0.691	7200	3.090	RP..1605
335.25-08.00-0911N-R8	02993975	Arbor hole	8.197	0.631	0.669	2.539	7	14	2.000	3.000	0.750	0.691	6500	5.730	RP..1605
335.25-10.00-XL0911N-R8	02993978	Arbor hole	10.197	0.631	0.669	3.539	8	16	2.000	3.000	0.750	0.691	5800	9.260	RP..1605
335.25-12.00-XL0911N-R8	02993981	Arbor hole	12.197	0.631	0.669	4.579	10	20	2.000	3.000	0.750	0.691	5200	31.310	RP..1605
R335.25-12.00-XL0911N-R8	02993966	Arbor	12.197	0.631	0.669	3.519	10	20	2.500	5.120	-	2.050	5200	31.530	RP..1605
R335.25-06.00-0911N-R8	02993957	Arbor	6.197	0.631	0.669	1.704	5	10	1.500	2.750	-	2.050	7200	4.850	RP..1605
R335.25-04.00-0911N-R8	02993951	Arbor	4.197	0.631	0.669	1.139	3	6	1.000	1.880	-	2.050	9200	2.200	RP..1605
R335.25-05.00-0911N-R8	02993954	Arbor	5.197	0.631	0.669	1.454	4	8	1.250	2.250	-	2.050	8200	3.310	RP..1605
R335.25-08.00-0911N-R8	02993960	Arbor	8.197	0.631	0.669	2.329	7	14	1.500	3.500	-	2.050	6500	8.160	RP..1605
R335.25-10.00-XL0911N-R8	02993963	Arbor	10.197	0.631	0.669	2.519	8	16	2.500	5.120	-	2.050	5800	13.670	RP..1605
335.25-10.00-XL1113N-R10	02993901	Arbor hole	10.197	0.789	0.827	3.539	8	16	2.000	3.000	1.000	0.894	4600	11.460	RP..1605
335.25-12.00-XL1113N-R10	02993904	Arbor hole	12.197	0.789	0.827	4.539	10	20	2.000	3.000	1.000	0.894	4100	17.200	RP..1605
R335.25-10.00-XL1113N-R10	02993874	Arbor	10.197	0.789	0.827	2.519	8	16	2.500	5.120	-	2.060	4600	15.210	RP..1605
R335.25-12.00-XL1113N-R10	02993878	Arbor	12.197	0.789	0.827	3.519	10	20	2.500	5.120	-	2.060	4100	20.720	RP..1605

All listed adjustable cutters are set to the minimum cutter width CWN (factory setting).

Adjustable cutter may be ordered with the cutting width set to any value within its range (CWN - CWX), see technical data for more info at page 462

Square shoulder and slot milling cutters

Helical milling cutters

Face milling cutters

Disc milling cutters

High feed milling cutters

Copy milling cutters

Plunge milling cutters

Chamfer milling cutters

Spot facing cutters

Inserts

Cutter 335.25 - Insert XNHQ – Metric

Max depth of cut 9-11,1 mm - Half side - Right hand with cassette

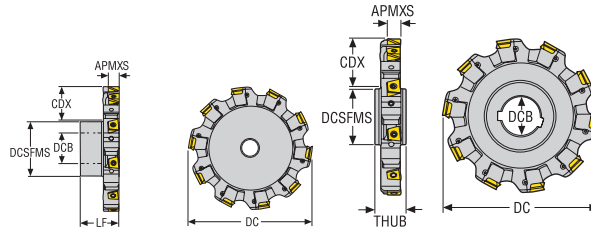

- For insert selection and cutting data recommendations, see page(s) 471-474
- For complete insert programme, see page(s) 864, 865
- For spare parts and technical information, see page 462-468
- For ISO attribute explanation, see page 16

Designation	Item number	Type of mounting	DC	APMXS	CDX	ZEFP	DCB	DCSFMS	THUB	LF	RPMX	Weight	Insert
			mm	mm	mm		mm	mm	mm	mm		kg	
R335.25-100.1317.27-6R	02993783	Arbor	100,0	9,0	24,8	6	27,0	48,0	–	50,0	9200	1,2	XNHQ09..
R335.25-125.1317.32-8R	02993786	Arbor	125,0	9,0	32,3	8	32,0	58,0	–	50,0	8200	1,4	XNHQ09..
335.25-125.1317.40-8R	02993801	Arbor hole	125,0	9,0	32,9	8	40,0	55,0	17,0	15,25	8200	0,9	XNHQ09..
R335.25-160.1317.40-12R	02993789	Arbor	160,0	9,0	43,8	12	40,0	70,0	–	50,0	7200	2,8	XNHQ09..
335.25-160.1317.40-12R	02993804	Arbor hole	160,0	8,5	50,5	12	40,0	55,0	17,0	15,25	7200	1,5	XNHQ09..
R335.25-200.1317.40-14R	02993792	Arbor	200,0	9,0	54,0	14	40,0	90,0	–	50,0	6500	3,6	XNHQ09..
335.25-200.1317.50-14R	02993807	Arbor hole	200,0	8,5	63,5	14	50,0	69,0	17,0	15,25	6500	3,1	XNHQ09..
R335.25-250.1317XL.60-16R	02993795	Arbor	250,0	9,0	59,0	16	60,0	130,0	–	50,0	5800	6,0	XNHQ09..
335.25-250.1317XL.50-16R	02993810	Arbor hole	250,0	9,0	88,5	16	50,0	69,0	17,0	15,25	5800	3,8	XNHQ09..
R335.25-315.1317XL.60-20R	02993798	Arbor	315,0	9,0	91,5	20	60,0	130,0	–	50,0	5200	8,5	XNHQ09..
335.25-315.1317XL.50-20R	02993813	Arbor hole	315,0	9,0	121,0	20	50,0	69,0	17,0	15,25	5200	6,4	XNHQ09..
R335.25-100.1721.27-6R	02993737	Arbor	100,0	11,1	24,8	6	27,0	48,0	–	50,0	7200	1,1	XNHQ12..
R335.25-125.1721.32-8R	02993740	Arbor	125,0	11,1	32,3	8	32,0	58,0	–	50,0	6500	1,6	XNHQ12..
335.25-125.1721.40-8R	02993761	Arbor hole	125,0	11,1	32,9	8	40,0	55,0	21,0	19,0	6500	1,0	XNHQ12..
R335.25-160.1721.40-10R	02993743	Arbor	160,0	11,1	43,8	10	40,0	70,0	–	50,0	5700	3,2	XNHQ12..
335.25-160.1721.40-10R	02993764	Arbor hole	160,0	11,1	50,5	10	40,0	55,0	21,0	19,0	5700	1,9	XNHQ12..
R335.25-200.1721.40-12R	02993746	Arbor	200,0	11,1	54,0	12	40,0	90,0	–	50,0	5100	4,1	XNHQ12..
335.25-200.1721.50-12R	02993767	Arbor hole	200,0	11,1	63,5	12	50,0	69,0	21,0	19,0	5100	3,1	XNHQ12..
R335.25-250.1721XL.60-16R	02993749	Arbor	250,0	11,1	59,0	16	60,0	130,0	–	50,0	4600	6,7	XNHQ12..
335.25-250.1721XL.50-16R	02993770	Arbor hole	250,0	11,1	88,5	16	50,0	69,0	21,0	19,0	4600	8,2	XNHQ12..
R335.25-315.1721XL.60-20R	02993752	Arbor	315,0	11,1	91,5	20	60,0	130,0	–	50,0	4100	9,9	XNHQ12..
335.25-315.1721XL.50-20R	02993773	Arbor hole	315,0	11,1	121,0	20	50,0	69,0	21,0	19,0	4100	8,1	XNHQ12..

Max depth of cut 13-16 mm - Half side - Right hand with cassette

Cutter 335.25 - Insert XNHQ/LNHQ – Metric

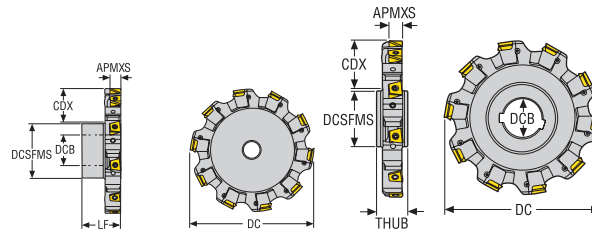

- For insert selection and cutting data recommendations, see page(s) 475-478
- For complete insert programme, see page(s) 864, 865
- For spare parts and technical information, see page 462-468
- For ISO attribute explanation, see page 16

Designation	Item number	Type of mounting	DC	APMXS	CDX	ZEFP	DCB	DCSFMS	THUB	LF	RPMX	Weight	Insert:	
													First choice	Alternative choice
R335.25-125.2126.32-8R	02814580	Arbor	125,0	13,0	32,3	8	32,0	58,0	–	50,0	4900	1,7	XNHQ1407...	LNHQ1407...
335.25-125.2126.40-8R	02814601	Arbor hole	125,0	13,0	32,7	8	40,0	55,0	32,0	26,5	4900	1,3	XNHQ1407...	LNHQ1407...
R335.25-160.2126.40-10R	02814584	Arbor	160,0	13,0	43,8	10	40,0	70,0	–	50,0	4400	2,9	XNHQ1407...	LNHQ1407...
335.25-160.2126.40-10R	02814605	Arbor hole	160,0	13,0	50,3	10	40,0	55,0	32,0	26,5	4400	2,3	XNHQ1407...	LNHQ1407...
R335.25-200.2126.40-12R	02814588	Arbor	200,0	13,0	54,0	12	40,0	90,0	–	50,0	3900	4,6	XNHQ1407...	LNHQ1407...
335.25-200.2126.50-12R	02814609	Arbor hole	200,0	13,0	63,3	12	50,0	69,0	32,0	26,5	3900	3,9	XNHQ1407...	LNHQ1407...
R335.25-250.2126XL.60-14R	02814592	Arbor	250,0	13,0	59,0	14	60,0	130,0	–	50,0	3500	7,3	XNHQ1407...	LNHQ1407...
335.25-250.2126XL.50-14R	02814613	Arbor hole	250,0	13,0	88,3	14	50,0	69,0	32,0	26,5	3500	6,0	XNHQ1407...	LNHQ1407...
R335.25-315.2126XL.60-18R	02814597	Arbor	315,0	13,0	91,5	18	60,0	130,0	–	50,0	3100	11,3	XNHQ1407...	LNHQ1407...
335.25-315.2126XL.60-18R	02814617	Arbor hole	315,0	13,0	113,3	18	60,0	84,0	32,0	26,5	3100	10,0	XNHQ1407...	LNHQ1407...
R335.25-160.2632.40-10R	02827413	Arbor	160,0	16,0	43,8	10	40,0	70,0	–	50,0	4600	3,4	XNHQ1707...	LNHQ1707...
335.25-160.2632.40-10R	02829067	Arbor hole	160,0	16,0	50,3	10	40,0	55,0	32,0	29,0	4600	2,9	XNHQ1707...	LNHQ1707...
R335.25-200.2632.40-12R	02827417	Arbor	200,0	16,0	54,0	12	40,0	90,0	–	50,0	4100	5,4	XNHQ1707...	LNHQ1707...
335.25-200.2632.50-12R	02827443	Arbor hole	200,0	16,0	63,3	12	50,0	69,0	32,0	29,0	4100	5,2	XNHQ1707...	LNHQ1707...
R335.25-250.2632XL.60-14R	02827421	Arbor	250,0	16,0	59,0	14	60,0	130,0	–	50,0	3700	8,4	XNHQ1707...	LNHQ1707...
335.25-250.2632XL.50-14R	02827447	Arbor hole	250,0	16,0	88,3	14	50,0	69,0	32,0	29,0	3700	7,4	XNHQ1707...	LNHQ1707...
R335.25-315.2632XL.60-18R	02827425	Arbor	315,0	16,0	91,5	18	60,0	130,0	–	50,0	3300	13,4	XNHQ1707...	LNHQ1707...
335.25-315.2632XL.60-18R	02827451	Arbor hole	315,0	16,0	113,3	18	60,0	84,0	32,0	29,0	3300	12,3	XNHQ1707...	LNHQ1707...

Square shoulder and slot milling cutters

Helical milling cutters

Face milling cutters

Disc milling cutters

High feed milling cutters

Copy milling cutters

Plunge milling cutters

Chamfer milling cutters

Spot facing cutters

Inserts

Cutter 335.25 - Insert XNHQ – inch

Max depth of cut 0.354 - 0.437" - Half side - Right hand with cassette

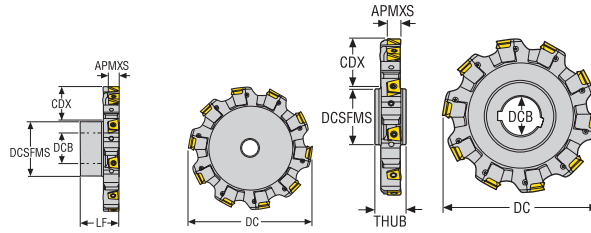

- For insert selection and cutting data recommendations, see page(s) 471-474
- For complete insert programme, see page(s) 864, 865
- For spare parts and technical information, see page 462-468
- For ISO attribute explanation, see page 16

Designation	Item number	Type of mounting	DC	APMXS	CDX	ZEFP	DCB	DCSFMS	THUB	LF	RPMX	Weight	Insert
			inch	inch	inch		inch	inch	inch	inch		lbs	
R335.25-04.00-0911R	02993909	Arbor	4.000	0.354	1.014	6	1.000	1.880	–	2.000	9200	2.200	XNHQ09
R335.25-05.00-0911R	02993913	Arbor	5.000	0.354	1.329	8	1.250	2.250	–	2.000	8200	3.310	XNHQ09
335.25-05.00-0911R	02993933	Arbor hole	5.000	0.354	1.289	8	1.500	2.250	0.750	0.641	8200	2.200	XNHQ09
R335.25-06.00-0911R	02993917	Arbor	6.000	0.354	1.579	10	1.500	2.750	–	2.000	7200	6.390	XNHQ09
335.25-06.00-0911R	02993937	Arbor hole	6.000	0.354	1.795	10	1.500	2.250	0.750	0.641	7200	3.090	XNHQ09
R335.25-08.00-0911R	02993921	Arbor	8.000	0.354	2.210	14	1.500	3.500	–	2.000	6500	8.160	XNHQ09
335.25-08.00-0911R	02993941	Arbor hole	8.000	0.354	2.420	14	2.000	3.000	0.750	0.641	6500	5.730	XNHQ09
R335.25-10.00-XL0911R	02993925	Arbor	10.000	0.354	2.400	16	2.500	5.120	–	2.000	5800	13.450	XNHQ09
335.25-10.00-XL0911R	02993945	Arbor hole	10.000	0.354	3.420	16	2.000	3.000	0.750	0.641	5800	9.040	XNHQ09
R335.25-12.00-XL0911R	02993929	Arbor	12.000	0.354	3.400	20	2.500	5.120	–	2.000	5200	17.860	XNHQ09
335.25-12.00-XL0911R	02993949	Arbor hole	12.000	0.354	4.460	20	2.000	3.000	0.750	0.641	5200	13.450	XNHQ09
R335.25-04.00-1113R	02993852	Arbor	4.000	0.437	1.014	6	1.000	1.880	–	2.000	7200	2.430	XNHQ12
R335.25-05.00-1113R	02993856	Arbor	5.000	0.437	1.329	8	1.250	2.250	–	2.000	6500	3.750	XNHQ12
335.25-05.00-1113R	02993883	Arbor hole	5.000	0.437	1.289	8	1.500	2.250	1.000	0.835	6500	2.650	XNHQ12
R335.25-06.00-1113R	02993860	Arbor	6.000	0.437	1.579	10	1.500	2.750	–	2.000	5700	5.510	XNHQ12
335.25-06.00-1113R	02993887	Arbor hole	6.000	0.437	1.795	10	1.500	2.250	1.000	0.835	5700	3.970	XNHQ12
R335.25-08.00-1113R	02993864	Arbor	8.000	0.437	2.210	12	1.500	3.500	–	2.000	5100	9.700	XNHQ12
335.25-08.00-1113R	02993891	Arbor hole	8.000	0.437	2.420	12	2.000	3.000	1.000	0.835	5100	7.500	XNHQ12
R335.25-10.00-XL1113R	02993868	Arbor	10.000	0.437	2.400	16	2.500	5.120	–	2.000	4600	15.210	XNHQ12
335.25-10.00-XL1113R	02993895	Arbor hole	10.000	0.437	3.420	16	2.000	3.000	1.000	0.835	4600	11.460	XNHQ12
R335.25-12.00-XL1113R	02993872	Arbor	12.000	0.437	3.400	20	2.500	5.120	–	2.000	4100	20.720	XNHQ12
335.25-12.00-XL1113R	02993899	Arbor hole	12.000	0.437	4.420	20	2.000	3.000	1.000	0.835	4100	16.980	XNHQ12

Max depth of cut 0.512 - 0.630" - Half side - Right hand with cassette

Cutter 335.25 - Insert XNHQ/LNHQ - inch

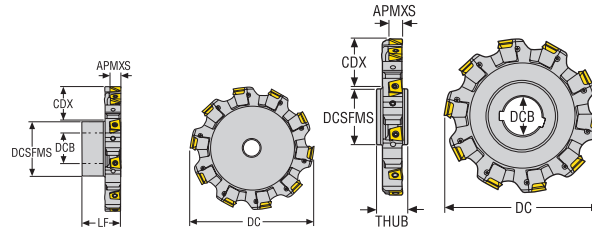

- For insert selection and cutting data recommendations, see page(s) 475-478
- For complete insert programme, see page(s) 864, 865
- For spare parts and technical information, see page 462-468
- For ISO attribute explanation, see page 16

Designation	Item number	Type of mounting	DC	APMXS	CDX	ZEFP	DCB	DCSFMS	THUB	LF	RPMX	Weight	Insert:	
													First choice	Alternative choice
			inch	inch	inch		inch	inch	inch	inch		lbs		
R335.25-05.00-1316R	02814621	Arbor	5.000	0.512	1.327	8	1.250	2.250	-	2.000	4900	3.970	XNHQ14	LNHQ14
335.25-05.00-1316R	02814641	Arbor hole	5.000	0.512	1.291	8	1.500	2.250	1.250	1.038	4900	3.090	XNHQ14	LNHQ14
R335.25-06.00-1316R	02814625	Arbor	6.000	0.512	1.579	10	1.500	2.750	-	2.000	4500	5.950	XNHQ14	LNHQ14
335.25-06.00-1316R	02814645	Arbor hole	6.000	0.512	1.791	10	1.500	2.250	1.250	1.038	4500	4.850	XNHQ14	LNHQ14
R335.25-08.00-1316R	02814629	Arbor	8.000	0.512	2.209	12	1.500	3.500	-	2.000	3900	12.130	XNHQ14	LNHQ14
335.25-08.00-1316R	02814649	Arbor hole	8.000	0.512	2.413	12	2.000	3.000	1.250	1.038	3900	9.040	XNHQ14	LNHQ14
R335.25-10.00-XL1316R	02814633	Arbor	10.000	0.512	2.402	14	2.500	5.118	-	2.000	3500	16.530	XNHQ14	LNHQ14
335.25-10.00-XL1316R	02814653	Arbor hole	10.000	0.512	3.413	14	2.000	3.000	1.250	1.038	3500	13.890	XNHQ14	LNHQ14
R335.25-12.00-XL1316R	02814637	Arbor	12.000	0.512	3.402	18	2.500	5.118	-	2.000	3200	23.150	XNHQ14	LNHQ14
335.25-12.00-XL1316R	02814657	Arbor hole	12.000	0.512	4.413	18	2.000	3.000	1.250	1.038	3200	20.720	XNHQ14	LNHQ14
R335.25-06.00-1620R	02827715	Arbor	6.000	0.630	1.579	10	1.500	2.750	-	2.000	4700	6.830	XNHQ17	LNHQ17
335.25-06.00-1620R	02827738	Arbor hole	6.000	0.630	1.791	10	1.500	2.250	1.250	1.137	4700	5.730	XNHQ17	LNHQ17
R335.25-08.00-1620R	02827719	Arbor	8.000	0.630	2.209	12	1.500	3.500	-	2.000	4100	12.570	XNHQ17	LNHQ17
335.25-08.00-1620R	02827742	Arbor hole	8.000	0.630	2.413	12	2.000	3.000	1.250	1.137	4100	11.020	XNHQ17	LNHQ17
R335.25-10.00-XL1620R	02827723	Arbor	10.000	0.630	2.402	14	2.500	5.118	-	2.000	3600	18.740	XNHQ17	LNHQ17
335.25-10.00-XL1620R	02827746	Arbor hole	10.000	0.630	3.413	14	2.000	3.000	1.250	1.137	3600	16.980	XNHQ17	LNHQ17
R335.25-12.00-XL1620R	02827727	Arbor	12.000	0.630	3.402	18	2.500	5.118	-	2.000	3300	27.340	XNHQ17	LNHQ17
335.25-12.00-XL1620R	02827750	Arbor hole	12.000	0.630	4.413	18	2.000	3.000	1.250	1.137	3300	25.350	XNHQ17	LNHQ17

Square shoulder and slot milling cutters

Helical milling cutters

Face milling cutters

Disc milling cutters

High feed milling cutters

Copy milling cutters

Plunge milling cutters

Chamfer milling cutters

Spot facing cutters

Inserts

Cutter 335.25 - Insert RP..1605/RP..2006 – Metric

Half side - Right hand - Radius profile with cassette

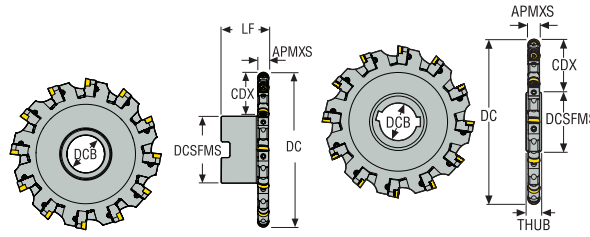

- For insert selection and cutting data recommendations, see page(s) 494-499
- For complete insert programme, see page(s) 842
- For spare parts and technical information, see page 462-468
- For ISO attribute explanation, see page 16

Designation	Item number	Type of mounting	DC	APMXS	CDX	ZEFP	ZNP	DCB	DCSFMS	THUB	LF	RPMX	Weight	Insert
			mm	mm	mm			mm	mm	mm	mm		kg	
R335.25-100.1317.27-6R-R8	02993816	Arbor	105,0	8,0	28,0	6	6	27,0	48,0	–	51,265	9200	1,0	RP..1605
R335.25-125.1317.32-8R-R8	02993819	Arbor	130,0	8,0	35,5	8	8	32,0	58,0	–	51,265	8200	1,4	RP..1605
335.25-125.1317.40-8R-R8	02993834	Arbor hole	130,0	8,0	36,1	8	8	40,0	55,0	17,0	16,52	8200	0,9	RP..1605
R335.25-160.1317.40-12R-R8	02993822	Arbor	165,0	8,0	47,0	12	12	40,0	70,0	–	51,265	7200	2,3	RP..1605
335.25-160.1317.40-12R-R8	02993837	Arbor hole	165,0	8,0	53,6	12	12	40,0	55,0	17,0	16,52	7200	1,5	RP..1605
R335.25-200.1317.40-14R-R8	02993825	Arbor	205,0	8,0	57,0	14	14	40,0	90,0	–	51,265	6500	3,5	RP..1605
335.25-200.1317.50-14R-R8	02993840	Arbor hole	205,0	8,0	66,6	14	14	50,0	69,0	17,0	16,52	6500	2,4	RP..1605
R335.25-250.1317XL.60-16R-R8	02993828	Arbor	255,0	8,0	62,0	16	16	60,0	130,0	–	51,265	5800	6,0	RP..1605
335.25-250.1317XL.50-16R-R8	02993843	Arbor hole	255,0	8,0	91,6	16	16	50,0	69,0	17,0	16,52	5800	4,0	RP..1605
R335.25-315.1317XL.60-20R-R8	02993831	Arbor	320,0	8,0	94,5	20	20	60,0	130,0	–	51,265	5200	8,6	RP..1605
335.25-315.1317XL.50-20R-R8	02993846	Arbor hole	320,0	8,0	124,1	20	20	50,0	69,0	17,0	16,52	5200	6,6	RP..1605
R335.25-250.1721XL.60-16R-R10	02993755	Arbor	255,0	10,0	62,0	16	16	60,0	130,0	–	51,515	4600	6,7	RP..2006
335.25-250.1721XL.50-16R-R10	02993776	Arbor hole	255,0	10,0	91,6	16	16	50,0	69,0	21,0	20,52	4600	5,0	RP..2006
R335.25-315.1721XL.60-20R-R10	02993758	Arbor	320,0	10,0	94,5	20	20	60,0	130,0	–	51,515	4100	10,0	RP..2006
335.25-315.1721XL.50-20R-R10	02993779	Arbor hole	320,0	10,0	124,1	20	20	50,0	69,0	21,0	20,52	4100	8,2	RP..2006

Half side - Right hand - Radius profile with cassette

Cutter 335.25 - Insert RP..1605/RP..2006 – inch

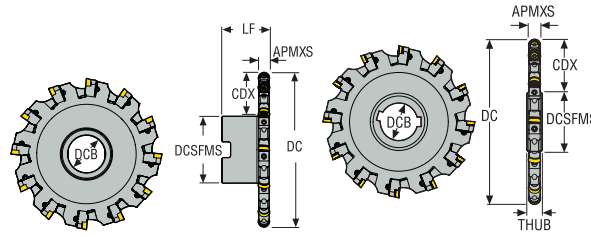

- For insert selection and cutting data recommendations, see page(s) 494-499
- For complete insert programme, see page(s) 842
- For spare parts and technical information, see page 462-468
- For ISO attribute explanation, see page 16

Designation	Item number	Type of mounting	DC	APMXS	CDX	ZEPF	ZNP	DCB	DCSFMS	THUB	LF	RPMX	Weight	Insert
			inch	inch	inch			inch	inch	inch	inch		lbs	
R335.25-04.00-0911R-R8	02993952	Arbor	4.197	0.315	1.138	6	6	1.000	1.880	-	2.050	9200	2.200	RP..1605
R335.25-05.00-0911R-R8	02993955	Arbor	5.197	0.315	1.453	8	8	1.250	2.250	-	2.050	8200	3.310	RP..1605
335.25-05.00-0911R-R8	02993970	Arbor hole	5.197	0.315	1.414	8	8	1.500	2.250	0.750	0.691	8200	2.200	RP..1605
R335.25-06.00-0911R-R8	02993958	Arbor	6.197	0.315	1.703	10	10	1.500	2.750	-	2.050	7200	6.170	RP..1605
335.25-06.00-0911R-R8	02993973	Arbor hole	6.197	0.315	1.914	10	10	1.500	2.250	0.750	0.691	7200	3.090	RP..1605
R335.25-08.00-0911R-R8	02993961	Arbor	8.197	0.315	2.329	14	14	1.500	3.500	-	2.050	6500	8.160	RP..1605
335.25-08.00-0911R-R8	02993976	Arbor hole	8.197	0.315	2.539	14	14	2.000	3.000	0.750	0.691	6500	5.730	RP..1605
R335.25-10.00-XL0911R-R8	02993964	Arbor	10.197	0.315	2.519	16	16	2.500	5.120	-	2.050	5800	13.670	RP..1605
335.25-10.00-XL0911R-R8	02993979	Arbor hole	10.197	0.315	3.539	16	16	2.000	3.000	0.750	0.691	5800	9.260	RP..1605
R335.25-12.00-XL0911R-R8	02993967	Arbor	12.197	0.315	3.519	20	20	2.500	5.120	-	2.050	5200	18.080	RP..1605
335.25-12.00-XL0911R-R8	02993982	Arbor hole	12.197	0.315	4.579	20	20	2.000	3.000	0.750	0.691	5200	13.450	RP..1605
R335.25-10.00-XL1113R-R10	02993875	Arbor	10.197	0.394	2.519	16	16	2.500	5.120	-	2.060	4600	15.210	RP..2006
335.25-10.00-XL1113R-R10	02993902	Arbor hole	10.197	0.394	3.539	16	16	2.000	3.000	1.000	0.894	4600	11.460	RP..2006
R335.25-12.00-XL1113R-R10	02993879	Arbor	12.197	0.394	3.519	20	20	2.500	5.120	-	2.060	4100	20.720	RP..2006
335.25-12.00-XL1113R-R10	02993905	Arbor hole	12.197	0.394	4.539	20	20	2.000	3.000	1.000	0.894	4100	17.200	RP..2006

Square shoulder and slot milling cutters

Helical milling cutters

Face milling cutters

Disc milling cutters

High feed milling cutters

Copy milling cutters

Plunge milling cutters

Chamfer milling cutters

Spot facing cutters

Inserts

Cutter 335.25 - Insert XNHQ – Metric

Max depth of cut 9-11,1 mm – Half side – Left hand with cassette

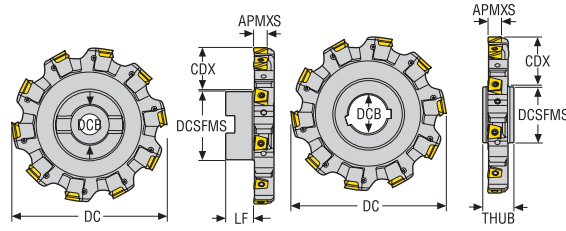

- For insert selection and cutting data recommendations, see page(s) 471-474
- For complete insert programme, see page(s) 864, 865
- For spare parts and technical information, see page 462-468
- For ISO attribute explanation, see page 16

Designation	Item number	Type of mounting	DC	APMXS	CDX	ZEFP	DCB	DCSFMS	THUB	LF	RPMX	Weight	Insert
			mm	mm	mm		mm	mm	mm	mm		kg	
R335.25-100.1317.27-6L	02993784	Arbor	100,0	9,0	24,8	6	27,0	48,0	–	50,0	9200	1,3	XNHQ09..
R335.25-125.1317.32-8L	02993787	Arbor	125,0	9,0	32,3	8	32,0	58,0	–	50,0	8200	1,4	XNHQ09..
335.25-125.1317.40-8L	02993802	Arbor hole	125,0	9,0	32,9	8	40,0	55,0	17,0	1,75	8200	0,9	XNHQ09..
R335.25-160.1317.40-12L	02993790	Arbor	160,0	9,0	43,8	12	40,0	70,0	–	50,0	7200	2,3	XNHQ09..
335.25-160.1317.40-12L	02993805	Arbor hole	160,0	9,0	50,5	12	40,0	55,0	17,0	1,75	7200	1,5	XNHQ09..
R335.25-200.1317.40-14L	02993793	Arbor	200,0	9,0	54,0	14	40,0	90,0	–	50,0	6500	3,5	XNHQ09..
335.25-200.1317.50-14L	02993808	Arbor hole	200,0	9,0	63,5	14	50,0	69,0	17,0	1,75	6500	3,1	XNHQ09..
R335.25-250.1317XL.60-16L	02993796	Arbor	250,0	9,0	59,0	16	60,0	130,0	–	50,0	5800	5,9	XNHQ09..
335.25-250.1317XL.50-16L	02993811	Arbor hole	250,0	9,0	88,5	16	50,0	69,0	17,0	1,75	5800	5,1	XNHQ09..
R335.25-315.1317XL.60-20L	02993799	Arbor	315,0	9,0	91,5	20	60,0	130,0	–	50,0	5200	8,5	XNHQ09..
335.25-315.1317XL.50-20L	02993814	Arbor hole	315,0	9,0	121,0	20	50,0	69,0	17,0	1,75	5200	6,5	XNHQ09..
R335.25-100.1721.27-6L	02993738	Arbor	100,0	11,1	24,8	6	27,0	48,0	–	50,0	7200	1,1	XNHQ12..
R335.25-125.1721.32-8L	02993741	Arbor	125,0	11,1	32,3	8	32,0	58,0	–	50,0	6500	1,9	XNHQ12..
335.25-125.1721.40-8L	02993762	Arbor hole	125,0	11,1	32,9	8	40,0	55,0	21,0	2,0	6500	1,1	XNHQ12..
R335.25-160.1721.40-10L	02993744	Arbor	160,0	11,1	43,8	10	40,0	70,0	–	50,0	5700	2,8	XNHQ12..
335.25-160.1721.40-10L	02993765	Arbor hole	160,0	11,1	50,5	10	40,0	55,0	21,0	2,0	5700	1,9	XNHQ12..
R335.25-200.1721.40-12L	02993747	Arbor	200,0	11,1	54,0	12	40,0	90,0	–	50,0	5100	4,5	XNHQ12..
335.25-200.1721.50-12L	02993768	Arbor hole	200,0	11,1	63,5	12	50,0	69,0	21,0	2,0	5100	4,5	XNHQ12..
R335.25-250.1721XL.60-16L	02993750	Arbor	250,0	11,1	59,0	16	60,0	130,0	–	50,0	4600	6,7	XNHQ12..
335.25-250.1721XL.50-16L	02993771	Arbor hole	250,0	11,1	88,5	16	50,0	69,0	21,0	2,0	4600	4,9	XNHQ12..
R335.25-315.1721XL.60-20L	02993753	Arbor	315,0	11,1	91,5	20	60,0	130,0	–	50,0	4100	10,0	XNHQ12..
335.25-315.1721XL.50-20L	02993774	Arbor hole	315,0	11,1	121,0	20	50,0	69,0	21,0	2,0	4100	8,1	XNHQ12..

Max depth of cut 13-16 mm – Half side – Left hand with cassette

Cutter 335.25 - Insert XNHQ/LNHQ – Metric

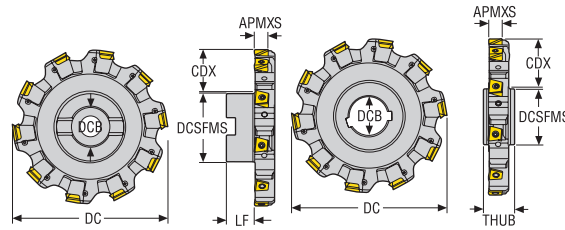

- For insert selection and cutting data recommendations, see page(s) 475-478
- For complete insert programme, see page(s) 864, 865
- For spare parts and technical information, see page 462-468
- For ISO attribute explanation, see page 16

Designation	Item number	Type of mounting	DC	APMXS	CDX	ZEFP	DCB	DCSFMS	THUB	LF	RPMX	Weight	Insert:	
													First choice	Alternative choice
R335.25-125.2126.32-8L	02814581	Arbor	125,0	13,0	32,3	8	32,0	58,0	–	29,0	4900	1,7	XNHQ1407...	LNHQ1407...
335.25-125.2126.40-8L	02814602	Arbor hole	125,0	13,0	32,7	8	40,0	55,0	32,0	5,5	4900	1,3	XNHQ1407...	LNHQ1407...
R335.25-160.2126.40-10L	02814585	Arbor	160,0	13,0	43,8	10	40,0	70,0	–	29,0	4400	2,9	XNHQ1407...	LNHQ1407...
335.25-160.2126.40-10L	02814606	Arbor hole	160,0	13,0	50,3	10	40,0	55,0	32,0	5,5	4400	2,3	XNHQ1407...	LNHQ1407...
R335.25-200.2126.40-12L	02814589	Arbor	200,0	13,0	54,0	12	40,0	90,0	–	29,0	3900	5,1	XNHQ1407...	LNHQ1407...
335.25-200.2126.50-12L	02814610	Arbor hole	200,0	13,0	63,3	12	50,0	69,0	32,0	5,5	3900	3,9	XNHQ1407...	LNHQ1407...
R335.25-250.2126XL.60-14L	02814593	Arbor	250,0	13,0	59,0	14	60,0	130,0	–	29,0	3500	7,3	XNHQ1407...	LNHQ1407...
335.25-250.2126XL.50-14L	02814614	Arbor hole	250,0	13,0	88,3	14	50,0	69,0	32,0	5,5	3500	6,0	XNHQ1407...	LNHQ1407...
R335.25-315.2126XL.60-18L	02814598	Arbor	315,0	13,0	91,5	18	60,0	130,0	–	29,0	3100	11,3	XNHQ1407...	LNHQ1407...
335.25-315.2126XL.60-18L	02814618	Arbor hole	315,0	13,0	113,3	18	60,0	84,0	32,0	5,5	3100	10,0	XNHQ1407...	LNHQ1407...
R335.25-160.2632.40-10L	02827414	Arbor	160,0	16,0	43,8	10	40,0	70,0	–	24,0	4600	3,4	XNHQ1707...	LNHQ1707...
335.25-160.2632.40-10L	02829068	Arbor hole	160,0	16,0	50,3	10	40,0	55,0	32,0	3,0	4600	2,9	XNHQ1707...	LNHQ1707...
R335.25-200.2632.40-12L	02827418	Arbor	200,0	16,0	54,0	12	40,0	90,0	–	24,0	4100	5,4	XNHQ1707...	LNHQ1707...
335.25-200.2632.50-12L	02827444	Arbor hole	200,0	16,0	63,3	12	50,0	69,0	32,0	3,0	4100	4,8	XNHQ1707...	LNHQ1707...
R335.25-250.2632XL.60-14L	02827422	Arbor	250,0	16,0	59,0	14	60,0	130,0	–	24,0	3700	8,4	XNHQ1707...	LNHQ1707...
335.25-250.2632XL.50-14L	02827448	Arbor hole	250,0	16,0	88,3	14	50,0	69,0	32,0	3,0	3700	8,5	XNHQ1707...	LNHQ1707...
R335.25-315.2632XL.60-18L	02827426	Arbor	315,0	16,0	91,5	18	60,0	130,0	–	24,0	3300	13,4	XNHQ1707...	LNHQ1707...
335.25-315.2632XL.60-18L	02827452	Arbor hole	315,0	16,0	113,3	18	60,0	84,0	32,0	3,0	3300	12,3	XNHQ1707...	LNHQ1707...

Square shoulder and slot milling cutters

Helical milling cutters

Face milling cutters

Disc milling cutters

High feed milling cutters

Copy milling cutters

Plunge milling cutters

Chamfer milling cutters

Spot facing cutters

Inserts

Cutter 335.25 - Insert XNHQ – inch

Max depth of cut 0.354-0.437” – Half side – Left hand with cassette

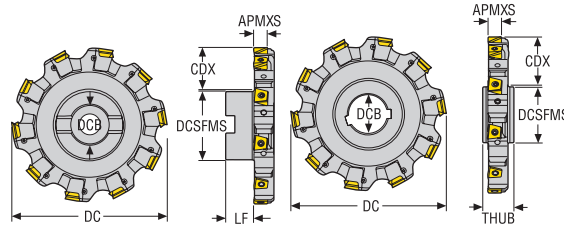

- For insert selection and cutting data recommendations, see page(s) 471-474
- For complete insert programme, see page(s) 864, 865
- For spare parts and technical information, see page 462-468
- For ISO attribute explanation, see page 16

Designation	Item number	Type of mounting	DC	APMXS	CDX	ZEFP	DCB	DCSFMS	THUB	LF	RPMX	Weight	Insert
			inch	inch	inch		inch	inch	inch	inch		lbs	
R335.25-04.00-0911L	02993910	Arbor	4.000	0.354	1.014	6	1.000	1.880	–	2.000	9200	2.200	XNHQ09
R335.25-05.00-0911L	02993914	Arbor	5.000	0.354	1.329	8	1.250	2.250	–	2.000	8200	3.310	XNHQ09
335.25-05.00-0911L	02993934	Arbor hole	5.000	0.354	1.289	8	1.500	2.250	0.750	0.109	8200	2.200	XNHQ09
R335.25-06.00-0911L	02993918	Arbor	6.000	0.354	1.579	10	1.500	2.750	–	2.000	7200	4.850	XNHQ09
335.25-06.00-0911L	02993938	Arbor hole	6.000	0.354	1.795	10	1.500	2.250	0.750	0.109	7200	3.090	XNHQ09
R335.25-08.00-0911L	02993922	Arbor	8.000	0.354	2.210	14	1.500	3.500	–	2.000	6500	8.160	XNHQ09
335.25-08.00-0911L	02993942	Arbor hole	8.000	0.354	2.420	14	2.000	3.000	0.750	0.109	6500	5.730	XNHQ09
R335.25-10.00-XL0911L	02993926	Arbor	10.000	0.354	2.400	16	2.500	5.120	–	2.000	5800	13.450	XNHQ09
335.25-10.00-XL0911L	02993946	Arbor hole	10.000	0.354	3.420	16	2.000	3.000	0.750	0.109	5800	9.040	XNHQ09
R335.25-12.00-XL0911L	02993930	Arbor	12.000	0.354	3.400	20	2.500	5.120	–	2.000	5200	17.860	XNHQ09
335.25-12.00-XL0911L	02993950	Arbor hole	12.000	0.354	4.460	20	2.000	3.000	0.750	0.109	5200	13.450	XNHQ09
R335.25-04.00-1113L	02993853	Arbor	4.000	0.437	1.014	6	1.000	1.880	–	2.000	7200	2.430	XNHQ12
R335.25-05.00-1113L	02993857	Arbor	5.000	0.437	1.329	8	1.250	2.250	–	2.000	6500	3.750	XNHQ12
335.25-05.00-1113L	02993884	Arbor hole	5.000	0.437	1.289	8	1.500	2.250	1.000	0.165	6500	2.650	XNHQ12
R335.25-06.00-1113L	02993861	Arbor	6.000	0.437	1.579	10	1.500	2.750	–	2.000	5700	5.510	XNHQ12
335.25-06.00-1113L	02993888	Arbor hole	6.000	0.437	1.795	10	1.500	2.250	1.000	0.165	5700	3.970	XNHQ12
R335.25-08.00-1113L	02993865	Arbor	8.000	0.437	2.210	12	1.500	3.500	–	2.000	5100	9.700	XNHQ12
335.25-08.00-1113L	02993892	Arbor hole	8.000	0.437	2.420	12	2.000	3.000	1.000	0.165	5100	7.500	XNHQ12
R335.25-10.00-XL1113L	02993869	Arbor	10.000	0.437	2.400	16	2.500	5.120	–	2.000	4600	15.210	XNHQ12
335.25-10.00-XL1113L	02993896	Arbor hole	10.000	0.437	3.420	16	2.000	3.000	1.000	0.165	4600	13.890	XNHQ12
R335.25-12.00-XL1113L	02993873	Arbor	12.000	0.437	3.400	20	2.500	5.120	–	2.000	4100	20.720	XNHQ12
335.25-12.00-XL1113L	02993900	Arbor hole	12.000	0.437	4.420	20	2.000	3.000	1.000	0.165	4100	16.980	XNHQ12

Max depth of cut 0.512-0.630" – Half side – Left hand with cassette

Cutter 335.25 - Insert XNHQ/LNHQ – inch

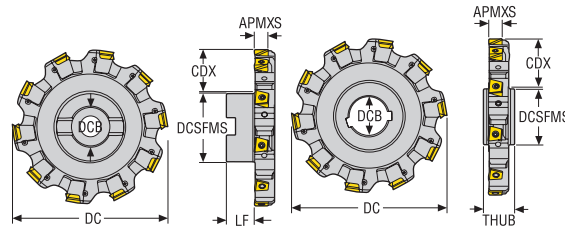

- For insert selection and cutting data recommendations, see page(s) 475-478
- For complete insert programme, see page(s) 864, 865
- For spare parts and technical information, see page 462-468
- For ISO attribute explanation, see page 16

Designation	Item number	Type of mounting	DC	APMXS	CDX	ZEFP	DCB	DCSFMS	THUB	LF	RPMX	Weight	Insert:	
													First choice	Alternative choice
R335.25-05.00-1316L	02814622	Arbor	5.000	0.512	1.327	8	1.250	2.250	–	1.173	4900	3.970	XNHQ14	LNHQ14
335.25-05.00-1316L	02814642	Arbor hole	5.000	0.512	1.291	8	1.500	2.250	1.250	0.212	4900	3.090	XNHQ14	LNHQ14
R335.25-06.00-1316L	02814626	Arbor	6.000	0.512	1.579	10	1.500	2.750	–	1.173	4500	5.950	XNHQ14	LNHQ14
335.25-06.00-1316L	02814646	Arbor hole	6.000	0.512	1.791	10	1.500	2.250	1.250	0.212	4500	4.850	XNHQ14	LNHQ14
R335.25-08.00-1316L	02814630	Arbor	8.000	0.512	2.209	12	1.500	3.500	–	1.173	3900	10.800	XNHQ14	LNHQ14
335.25-08.00-1316L	02814650	Arbor hole	8.000	0.512	2.413	12	2.000	3.000	1.250	0.212	3900	9.040	XNHQ14	LNHQ14
R335.25-10.00-XL1316L	02814634	Arbor	10.000	0.512	2.402	14	2.500	5.120	–	1.173	3500	16.530	XNHQ14	LNHQ14
335.25-10.00-XL1316L	02814654	Arbor hole	10.000	0.512	3.413	14	2.000	3.000	1.250	0.212	3500	13.890	XNHQ14	LNHQ14
R335.25-12.00-XL1316L	02814638	Arbor	12.000	0.512	3.402	18	2.500	5.120	–	1.173	3200	23.150	XNHQ14	LNHQ14
335.25-12.00-XL1316L	02814658	Arbor hole	12.000	0.512	4.413	18	2.000	3.000	1.250	0.212	3200	20.720	XNHQ14	LNHQ14
R335.25-06.00-1620L	02827716	Arbor	6.000	0.630	1.579	10	1.500	2.750	–	0.976	4700	6.830	XNHQ17	LNHQ17
335.25-06.00-1620L	02827739	Arbor hole	6.000	0.630	1.791	10	1.500	2.250	1.250	0.113	4700	5.730	XNHQ17	LNHQ17
R335.25-08.00-1620L	02827720	Arbor	8.000	0.630	2.209	12	1.500	3.500	–	0.976	4100	12.570	XNHQ17	LNHQ17
335.25-08.00-1620L	02827743	Arbor hole	8.000	0.630	2.413	12	2.000	3.000	1.250	0.113	4100	11.020	XNHQ17	LNHQ17
R335.25-10.00-XL1620L	02827724	Arbor	10.000	0.630	2.402	14	2.500	5.120	–	0.976	3600	18.740	XNHQ17	LNHQ17
335.25-10.00-XL1620L	02827747	Arbor hole	10.000	0.630	3.413	14	2.000	3.000	1.250	0.113	3600	19.400	XNHQ17	LNHQ17
R335.25-12.00-XL1620L	02827728	Arbor	12.000	0.630	3.402	18	2.500	5.120	–	0.976	3300	27.340	XNHQ17	LNHQ17
335.25-12.00-XL1620L	02827751	Arbor hole	12.000	0.630	4.413	18	2.000	3.000	1.250	0.113	3300	25.350	XNHQ17	LNHQ17

Square shoulder and slot milling cutters

Helical milling cutters

Face milling cutters

Disc milling cutters

High feed milling cutters

Copy milling cutters

Plunge milling cutters

Chamfer milling cutters

Spot facing cutters

Inserts

Cutter 335.25 - Insert RP..1605/RP..2006 – Metric

Half side - Left hand - Radius profile with cassette

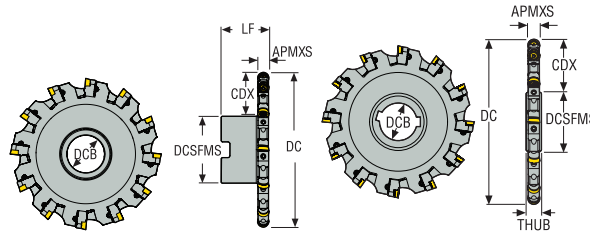

- For insert selection and cutting data recommendations, see page(s) 494-499
- For complete insert programme, see page(s) 842
- For spare parts and technical information, see page 462-468
- For ISO attribute explanation, see page 16

Designation	Item number	Type of mounting	DC	APMXS	CDX	ZEFP	ZNP	DCB	DCSFMS	THUB	LF	RPMX	Weight	Insert
			mm	mm	mm			mm	mm	mm	mm		kg	
R335.25-100.1317.27-6L-R8	02993817	Arbor	105,0	8,0	28,0	6	6	27,0	48,0	–	51,265	9200	1,0	RP..1605
R335.25-125.1317.32-8L-R8	02993820	Arbor	130,0	8,0	35,5	8	8	32,0	58,0	–	51,265	8200	1,8	RP..1605
335.25-125.1317.40-8L-R8	02993835	Arbor hole	130,0	8,0	36,1	8	8	40,0	55,0	17,0	0,48	8200	0,9	RP..1605
R335.25-160.1317.40-12L-R8	02993823	Arbor	165,0	8,0	47,0	12	12	40,0	70,0	–	51,265	7200	2,3	RP..1605
335.25-160.1317.40-12L-R8	02993838	Arbor hole	165,0	8,0	53,6	12	12	40,0	55,0	17,0	0,48	7200	1,5	RP..1605
R335.25-200.1317.40-14L-R8	02993826	Arbor	205,0	8,0	57,0	14	14	40,0	90,0	–	51,265	6500	3,5	RP..1605
335.25-200.1317.50-14L-R8	02993841	Arbor hole	205,0	8,0	66,6	14	14	50,0	69,0	17,0	0,48	6500	3,8	RP..1605
R335.25-250.1317XL.60-16L-R8	02993829	Arbor	255,0	8,0	62,0	16	16	60,0	130,0	–	51,265	5800	6,1	RP..1605
335.25-250.1317XL.50-16L-R8	02993844	Arbor hole	255,0	8,0	91,6	16	16	50,0	69,0	17,0	0,48	5800	5,3	RP..1605
R335.25-315.1317XL.60-20L-R8	02993832	Arbor	320,0	8,0	94,5	20	20	60,0	130,0	–	51,265	5200	8,6	RP..1605
335.25-315.1317XL.50-20L-R8	02993847	Arbor hole	320,0	8,0	124,1	20	20	50,0	69,0	17,0	0,48	5200	6,5	RP..1605
R335.25-250.1721XL.60-16L-R10	02993756	Arbor	255,0	10,0	62,0	16	16	60,0	130,0	–	51,515	4600	6,7	RP..2006
335.25-250.1721XL.50-16L-R10	02993777	Arbor hole	255,0	10,0	91,6	16	16	50,0	69,0	21,0	0,48	4600	5,0	RP..2006
R335.25-315.1721XL.60-20L-R10	02993759	Arbor	320,0	10,0	94,5	20	20	60,0	130,0	–	51,515	4100	9,9	RP..2006
335.25-315.1721XL.50-20L-R10	02993780	Arbor hole	320,0	10,0	124,1	20	20	50,0	69,0	21,0	0,48	4100	8,2	RP..2006

Half side - Left hand - Radius profile with cassette

Cutter 335.25 - Insert RP..1605/RP..2006 – inch

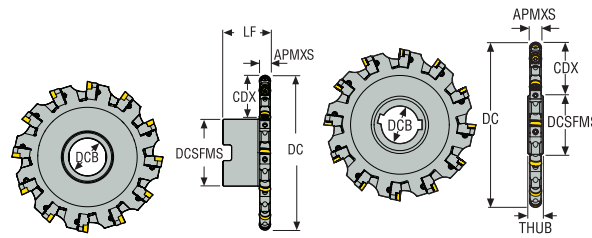

- For insert selection and cutting data recommendations, see page(s) 494-499
- For complete insert programme, see page(s) 842
- For spare parts and technical information, see page 462-468
- For ISO attribute explanation, see page 16

Designation	Item number	Type of mounting	DC	APMXS	CDX	ZEPF	ZNP	DCB	DCSFMS	THUB	LF	RPMX	Weight	Insert
			inch	inch	inch			inch	inch	inch	inch		lbs	
R335.25-04.00-0911L-R8	02993953	Arbor	4.197	0.315	1.138	6	6	1.000	1.880	–	2.050	9200	2.200	RP..1605
R335.25-05.00-0911L-R8	02993956	Arbor	5.197	0.315	1.453	8	8	1.250	2.250	–	2.050	8200	3.310	RP..1605
335.25-05.00-0911L-R8	02993971	Arbor hole	5.197	0.315	1.414	8	8	1.500	2.250	0.750	0.059	8200	2.200	RP..1605
R335.25-06.00-0911L-R8	02993959	Arbor	6.197	0.315	1.703	10	10	1.500	2.750	–	2.050	7200	4.850	RP..1605
335.25-06.00-0911L-R8	02993974	Arbor hole	6.197	0.315	1.914	10	10	1.500	2.250	0.750	0.059	7200	3.090	RP..1605
R335.25-08.00-0911L-R8	02993962	Arbor	8.197	0.315	2.329	14	14	1.500	3.500	–	2.050	6500	8.160	RP..1605
335.25-08.00-0911L-R8	02993977	Arbor hole	8.197	0.315	2.539	14	14	2.000	3.000	0.750	0.059	6500	18.080	RP..1605
R335.25-10.00-XL0911L-R8	02993965	Arbor	10.197	0.315	2.519	16	16	2.500	5.120	–	2.050	5800	13.670	RP..1605
335.25-10.00-XL0911L-R8	02993980	Arbor hole	10.197	0.315	3.539	16	16	2.000	3.000	0.750	0.059	5800	9.260	RP..1605
R335.25-12.00-XL0911L-R8	02993968	Arbor	12.197	0.315	3.519	20	20	2.500	5.120	–	2.050	5200	18.080	RP..1605
335.25-12.00-XL0911L-R8	02993983	Arbor hole	12.197	0.315	4.579	20	20	2.000	3.000	0.750	0.059	5200	13.670	RP..1605
R335.25-10.00-XL1113L-R10	02993877	Arbor	10.197	0.394	2.519	16	16	2.500	5.120	–	2.060	4600	15.210	RP..2006
335.25-10.00-XL1113L-R10	02993903	Arbor hole	10.197	0.394	3.539	16	16	2.000	3.000	1.000	0.106	4600	11.460	RP..2006
R335.25-12.00-XL1113L-R10	02993880	Arbor	12.197	0.394	3.519	20	20	2.500	5.120	–	2.060	4100	20.720	RP..2006
335.25-12.00-XL1113L-R10	02993906	Arbor hole	12.197	0.394	4.539	20	20	2.000	3.000	1.000	0.106	4100	17.200	RP..2006

Square shoulder and slot milling cutters

Helical milling cutters

Face milling cutters

Disc milling cutters

High feed milling cutters

Copy milling cutters

Plunge milling cutters

Chamfer milling cutters

Spot facing cutters

Inserts



335.29

Free-cutting disc milling cutter system equipped with round inserts dedicated for slotting with full radius or 3D profiling operation

- Width of cut 5-12 mm (.236 - .394 inch)
- Cutter range diameter 25-80 mm (1.5 - 3.0 inch)
- Available with Cylindrical, Arbor, and Combimaster connection, with through coolant capability
- Economical solution with 4 cutting edges per insert

Square shoulder and slot milling cutters
Helical milling cutters
Face milling cutters
Disc milling cutters
High feed milling cutters
Copy milling cutters
Plunge milling cutters
Chamfer milling cutters
Spot facing cutters
Inserts

Width 5/6/7/8/10/12 mm - full side - radius profile - Fixed pocket

Cutter 335.29 - Round insert – Metric

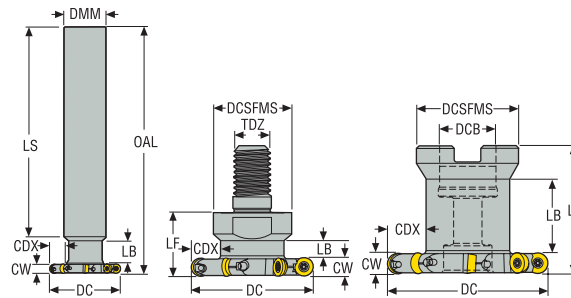

- For insert selection and cutting data recommendations, see page(s) 479-493
- For complete insert programme, see page(s) 839, 841
- For spare parts and technical information, see page 462-468
- For ISO attribute explanation, see page 16

Designation	Item number	Type of mounting	DC	CW	CDX	ZEFP	DMM	TDZ	DCB	DCSFMS	OAL	LF	LS	LB	RPMX	Weight	Insert
			mm	mm	mm		mm		mm	mm	mm	mm	mm	mm		kg	
R335.29-1225.0-05.4N-R25A	02628056	Cylindrical	25,0	5,0	6,9	4	12,0	-	-	-	110,0	-	94,0	10,0	44800	0,2	RD..0501
R335.29-1632.0-05.5N-R25A	02628063	Cylindrical	32,0	5,0	8,4	5	16,0	-	-	-	130,0	-	114,0	10,0	39600	0,3	RD..0501
R335.29-2040.0-05.6N-R25A	02628067	Cylindrical	40,0	5,0	10,4	6	20,0	-	-	-	140,0	-	124,0	10,0	35400	0,4	RD..0501
R335.29-2550.0-05.8N-R25A	02628071	Cylindrical	50,0	5,0	12,9	8	25,0	-	-	-	150,0	-	134,0	10,0	31700	0,6	RD..0501
R335.29-1225.0-06.4N-R3A	02628045	Cylindrical	25,0	6,0	6,9	4	12,0	-	-	-	110,0	-	93,0	10,0	20600	0,1	RD..06T1
R335.29-1632.0-06.5N-R3A	02628061	Cylindrical	32,0	6,0	8,4	5	16,0	-	-	-	130,0	-	113,0	10,0	18700	0,2	RD..06T1
R335.29-2040.0-06.6N-R3A	02628066	Cylindrical	40,0	6,0	10,4	6	20,0	-	-	-	140,0	-	123,0	10,0	16300	0,4	RD..06T1
R335.29-1240.RE-06.6N-R3A	02661227	Combimaster	40,0	6,0	10,0	6	-	M12	-	23,0	-	28,0	-	10,0	17600	0,2	RD..06T1
R335.29-2550.0-06.8N-R3A	02628069	Cylindrical	50,0	6,0	12,9	8	25,0	-	-	-	150,0	-	133,0	10,0	17300	0,6	RD..06T1
R335.29-1650.RE-06.8N-R3A	02661228	Combimaster	50,0	6,0	12,5	8	-	M16	-	30,0	-	28,0	-	9,0	17300	0,2	RD..06T1
R335.29-063.06.22-10N-R3A	02627922	Arbor	63,0	6,0	15,0	10	-	-	22,0	40,0	-	50,0	-	30,6	13900	0,4	RD..06T1
R335.29-1632.0-07.5N-R35A	02628060	Cylindrical	32,0	7,0	8,4	5	16,0	-	-	-	130,0	-	112,0	10,0	31600	0,2	RD..0702
R335.29-1240.RE-07.6N-R35A	02627979	Combimaster	40,0	7,0	10,0	6	-	M12	-	23,0	-	28,0	-	9,0	28200	0,2	RD..0702
R335.29-1650.RE-07.7N-R35A	02627984	Combimaster	50,0	7,0	12,5	7	-	M16	-	30,0	-	28,0	-	8,0	25300	0,2	RD..0702
R335.29-063.07.22-10N-R35A	02627950	Arbor	63,0	7,0	15,0	10	-	-	22,0	40,0	-	50,0	-	29,6	22500	0,4	RD..0702
R335.29-1632.0-08.4N-R4A	02628058	Cylindrical	32,0	8,0	8,4	4	16,0	-	-	-	130,0	-	111,0	10,0	23300	0,2	RD..08..
R335.29-2040.0-08.5N-R4A	02628064	Cylindrical	40,0	8,0	10,4	5	20,0	-	-	-	140,0	-	121,0	10,0	18800	0,4	RD..08..
R335.29-1240.RE-08.5N-R4A	02627978	Combimaster	40,0	8,0	10,0	5	-	M12	-	23,0	-	28,0	-	8,0	18800	0,2	RD..08..
R335.29-2550.0-08.6N-R4A	02628068	Cylindrical	50,0	8,0	12,9	6	25,0	-	-	-	150,0	-	131,0	10,0	17300	0,6	RD..08..
R335.29-1650.RE-08.6N-R4A	02661229	Combimaster	50,0	8,0	12,5	6	-	M16	-	30,0	-	28,0	-	7,0	17300	0,2	RD..08..
R335.29-063.08.22-8N-R4A	02661224	Arbor	63,0	8,0	15,0	8	-	-	22,0	40,0	-	50,0	-	28,6	15600	0,4	RD..08..
R335.29-080.08.27-10N-R4A	02627974	Arbor	80,0	8,0	20,0	10	-	-	27,0	48,0	-	50,0	-	26,8	13700	0,5	RD..08..
R335.29I-1650.RE-10.6N-R5A	03278721	Combimaster	50,0	10,0	12,34	3	-	M16	-	30,0	-	28,0	-	4,3	15800	0,2	RD..10T3
R335.29I-063.10.22-6N-R5A	03278719	Arbor	63,0	10,0	14,67	6	-	-	22,0	38,0	-	50,0	-	26,61	13500	0,4	RD..10T3
R335.29I-080.10.27-8N-R5A	03278720	Arbor	80,0	10,0	19,67	8	-	-	27,0	46,0	-	50,0	-	24,74	12000	0,5	RD..10T3
R335.29I-1650.RE-12.4N-R6A	02988077	Combimaster	50,0	12,0	12,5	2	-	M16	-	30,0	-	28,0	-	4,3	11200	0,2	RP..1204
R335.29I-063.12.22-6N-R6A	02988078	Arbor	63,0	12,0	15,0	6	-	-	22,0	40,0	-	50,0	-	24,6	10200	0,4	RP..1204
R335.29I-080.12.27-8N-R6A	02988079	Arbor	80,0	12,0	20,0	4	-	-	27,0	48,0	-	50,0	-	22,7	10000	0,5	RP..1204

R335.29I Disc Milling cutters offer indexing possibility - Indexing screw SX2035-T05P included in the delivery

Note: All cutters are equipped with central coolant channels, Arbor type are delivered with a lid kit to get central coolant capability

Square shoulder and slot milling cutters

Helical milling cutters

Face milling cutters

Disc milling cutters

High feed milling cutters

Copy milling cutters

Plunge milling cutters

Chamfer milling cutters

Spot facing cutters

Inserts

Spare Parts, included in delivery

Accessories

	For cutter	Arbor screw	Coolant kit	Insert key	Insert screw	Key	Screw	Insert clamping torque	Torque key
Square shoulder and slot milling cutters	R335.29 -R25A	-	-	H4B-T06P	C02053-T06P	-	-	0.5NM	T00-06P05
Helical milling cutters	R335.29 .RExxx-R3A / .0-xxx-R3A	-	-	H4B-T07P	C02205-T07P	-	-	0.9NM	T00-07P09
	R335.29 R3A DCB=22	MC6S10X40	LUBRICATION_SET_19	H4B-T07P	C02205-T07P	-	-	0.9NM	T00-07P09
	R335.29 .RExxx-R35A / .0-xxx-R35A	-	-	H4B-T07P	C02545-T07P	-	-	0.9NM	T00-07P09
	R335.29 R35A DCB=22	MC6S10X40	LUBRICATION_SET_19	H4B-T07P	C02545-T07P	-	-	0.9NM	T00-07P09
Face milling cutters	R335.29 .RExxx-R4A / .0-xxx-R4A	-	-	H4B-T08P	C02506-T08P	-	-	1.2NM	T00-08P12
	R335.29 R4A DCB=22	MC6S10X40	LUBRICATION_SET_19	H4B-T08P	C02506-T08P	-	-	1.2NM	T00-08P12
	R335.29 R4A DCB=27	MC6S12X35	LUBRICATION_SET_29	H4B-T08P	C02506-T08P	-	-	1.2NM	T00-08P12
	R335.29 .RExxx-R5A / .0-xxx-R5A	-	-	H4B-T09P	C03007-T09P	-	-	2.0NM	T00-09P20
Disc milling cutters	R335.29 R5A DCB=22	MC6S10X40	LUBRICATION_SET_19	H4B-T09P	C03007-T09P	-	-	2.0NM	T00-09P20
	R335.29 R5A DCB=27	MC6S12X35	LUBRICATION_SET_29	H4B-T09P	C03007-T09P	-	-	2.0NM	T00-09P20
	R335.29 .RExxx-R5A / .0-xxx-R5A	-	-	H4B-T15P	C03509-T15P	T05P-2	SX2035-T05P	3.0NM	T00-15P30
	R335.29 R6A DCB=22	MC6S10X40	LUBRICATION_SET_19	H4B-T15P	C03509-T15P	T05P-2	SX2035-T05P	3.0NM	T00-15P30
	R335.29 R6A DCB=27	MC6S12X35	LUBRICATION_SET_29	H4B-T15P	C03509-T15P	T05P-2	SX2035-T05P	3.0NM	T00-15P30

Width 0.236/0.315/0.394" - full side - radius profile - Fixed pocket

Cutter 335.29 - Round insert – inch

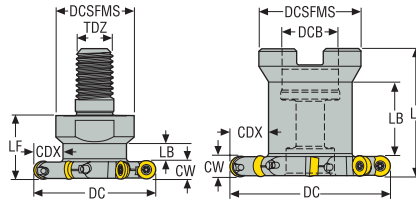

- For insert selection and cutting data recommendations, see page(s) 481-482, 485-490
- For complete insert programme, see page(s) 839
- For spare parts and technical information, see page 462-468
- For ISO attribute explanation, see page 16

Designation	Item number	Type of mounting	DC	CW	CDX	ZEPF	TDZ	DCB	DCSFMS	LF	LB	RPMX	Weight	Insert
			inch	inch	inch		inch	inch	inch	inch	inch	inch	lbs	
R335.29-1.50-12RE-6N-R3	02477694	Combimaster	1.500	0.236	0.297	6	M12	–	0.906	1.102	–	33700	0.220	RD..06T1
R335.29-2.00-16RE-8N-R3	02477702	Combimaster	2.000	0.236	0.409	8	M16	–	1.181	1.102	–	30200	0.660	RD..06T1
R335.29-2.00-16RE-6N-R4	02477709	Combimaster	2.000	0.315	0.409	6	M16	–	1.181	1.102	–	20200	0.660	RD..08
R335.29I-02.50-6N-R5A	03278722	Arbor	2.500	0.394	0.587	6	–	0.750	1.501	1.998	1.075	13500	1.100	RD..10T3
R335.29I-03.00-8N-R5A	03278723	Arbor	3.000	0.394	0.700	8	–	1.000	1.803	2.000	1.052	12000	1.320	RD..10T3

R335.29I Disc Milling cutters offer indexing possibility

Note: All cutters are equipped with central coolant channels, Arbor type are delivered with a lid kit to get central coolant capability

Spare Parts, included in delivery

Accessories

For cutter	Arbor screw	Coolant kit	Insert key	Insert screw	Insert clamping torque	Torque key
R335.29 RE- R3	–	–	H4B-T07P	C02205-T07P	8.0IN.LBS	T00-07P09
R335.29 RE- R4	–	–	H4B-T08P	C02506-T08P	10.6IN.LBS	T00-08P12
R335.29I -R5A DCB=0.750	UC6S3/6UNFX11/2	LUBRICATION_SET_19	H4B-T09P	C03007-T09P	17.7IN.LBS	T00-09P20
R335.29I -R5A DCB=1.000	UC6S1/2UNFX1-1/2	LUBRICATION_SET_29	H4B-T09P	C03007-T09P	17.7IN.LBS	T00-09P20

Square shoulder and slot milling cutters

Helical milling cutters

Face milling cutters

Disc milling cutters

High feed milling cutters

Copy milling cutters

Plunge milling cutters

Chamfer milling cutters

Spot facing cutters

Inserts

335.18 and 335.25 – Keyway for Arbor hole type and Arbor cutter

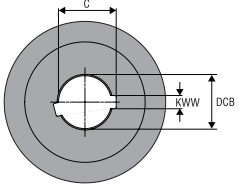

Dimensions in mm		
DCB	KWW	C
22	6	24,15
27	7	29,9
40	10	43,6
50	12	53,6
60	14	64,3

Dimensions in inch		
DCB	KWW	C
1.00	0.250	1.110
1.25	0.312	1.393
1.50	0.375	1.673
2.00	0.500	2.198

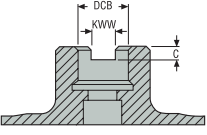

Dimensions in mm		
DCB	KWW	C
16	8,4	5,6
22	10,4	6,3
27	12,4	7
32	14,4	8
40	16,4	9

Dimensions in inch		
DCB	KWW	C
0.75	0.32	0.19
1.00	0.38	0.22
1.25	0.51	0.28
1.50	0.63	0.38

Retaining screw Arbor type cutter: R335.18 / R335.25 (supplied with the cutter in the delivery) - Metric/Inch

For cutter dia – metric	Cutter 335.18 adj. "0810", "1012", "1215" series – metric	Cutter 335.25 - adjustable – metric	For cutter dia – Inch	Cutter 335.25 - adjustable – Inch
63	MC6S 10x40	-	2.50	-
80	MC6S 12x40	-	3.00	MLC6S10X45
100	MC6S 12x40	MC6S12X40	4.00	UC6S1/2UNFX1-1/2
125	-	MC6S16X40	5.00	ULC6S5/8UNFX11/2
160	-	MLC6S20X40	6.00	ULC6S3/4UNFX1-1/2

Note: For disc cutter not mentioned in the tables, please use cross head retaining screw, supplied with the Seco Tooling System shell mill holder

To order a standard adjustable disc milling cutter set at a specific width:



To obtain an adjustable disc mill set to your required dimension add "/ADJ" at the end of the reference and specify your required width which will be set with a tolerance of +/- 0,03 mm (+/- .001"). Without specification the standard disc mill is set to the minimum cutting width.

Ordering example: R335.25-200.1317.40-7N/ADJ and specify on your order your width to any value within its range, for example specify a cutting width of 15.50mm in your order. The disc mill will be set to 15.50 +/- 0,03 mm (0.610" +/- .001").

The delivery time is approx. 3 days for a set adjustable disc mill.

(R)335.18 – LNK inserts



LNK.05
For width 8-10, .312"-.375"



LNK.06
For width 10-12, .625"

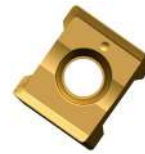

LNK.08
For width 12-15, .500"-.750"

LNK.06 and LNK.08 have the same size, but LNK.06 have a reduced cutting length (6mm, .250") to decrease cutting forces for width= 10-12 mm, .394"-.472". LNK.08 have a cutting length = 7,5 mm, .295" for width 12-15 mm, .500"-.750".

LNK.06 and LNK.08 have the same size, but LNK.06 have a reduced cutting length (6mm) to decrease cutting forces for width= 10-12 mm.

Radius possibilities/Number of cutting edges

	Insert	R	Fixed pocket version: CW =						Adjustable version: CW =				R	Fixed pocket version: CW inch =				Adjustable version: CW inch =						
			8	10	12	14	17	20	8	10	12	15		0.312/0.375	0.500	0.625	0.750	0.313	0.394	0.472	0.591			
4 cutting edges																								
	LNK.050404	0,4	x	x					x	x			.016	x					x	x				
	LNK.050408	0,8	x	x					x	x			.031	x					x	x				
	LNK.050416	1,6	x	x					x	x			.063	x					x	x				
	LNK.050420	2,0	x	x					x	x			.079	x					x	x				
	LNK.060504	0,4		x	x		x			x	x		.016			x				x	x			
	LNK.060508	0,8		x	x		x			x	x		.031			x				x	x			
	LNK.060516	1,6		x	x		x			x	x		.063			x				x	x			
	LNK.080504	0,4		o	o	x	o	x		o	o	x	.016		x	o	x			o	o	x		
	LNK.080508	0,8		o	o	x	o	x		o	o	x	.031		x	o	x			o	o	x		
	LNK.080516	1,6		o	o	x	o	x		o	o	x	.063		x	o	x			o	o	x		
	LNK.080520	2,0		x	x	x	x	x		x	x	x	.079		x	x	x			x	x	x		
	LNK.080524	2,4		x	x	x	x	x		x	x	x	.094		x	x	x			x	x	x		
2 cutting edges																								
	LNK.050424	2,4	x	x					x	x			.094	x					x	x				
	LNK.060531	3,1		x	x		x			x	x		.122			x				x	x			
	LNK.080531	3,1			o	x	o	x			o	x	.122		x	o	x				o	x		
1 cutting edge (L and R insert)																								
	LNK.050431...C*	3,1	x						x				.122	x					x	x				
	LNK.050431*	3,1		x						x			.157			x				x	x			
	LNK.060540	4,0		x	x		x			x	x		.157		x	o	x				o	x		
	LNK.080540	4,0			o	x	o	x			o	x												

*LNK.0504031...C is the first choice for CW = 8 to 9mm and LNK.0504031 is the first choice for CW= 9 to 10mm

x = First choice o = Alternative choice

Width and profile generated with LNK.06/08 radii R1,6/R2,0 and R2,4

	a _p (mm)	H (mm)		a _p (in)	H (in)	
		Radius 1,6	Radii 2 and 2,4		Radius .063	Radii .079 and .095
	13,4	–	0	.518	–	0
	14	–	0,03	.551	–	.001
	14,2	0	0,07	.559	0	.003
	14,5	0,01	0,13	.570	.0004	.005
	15	0,1	0,3	.591	.004	.012

Square shoulder and slot milling cutters
Helical milling cutters
Face milling cutters
Disc milling cutters
High feed milling cutters
Copy milling cutters
Plunge milling cutters
Chamfer milling cutters
Spot facing cutters
Inserts

(R)335.25 – LNHQ/XNHQ inserts

Width and profile generated by XNHQ insert with fixed pocket cutter for $a_p = 15/20/25\text{mm}$, $a_p = 0.75''$, $1.00''$

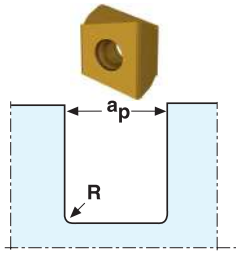

Insert corner radius	$a_p = 15\text{mm}$	$a_p = 20\text{mm}$	$a_p = 25\text{mm}$
0,4	15	20	25
0,8	15	20	25
1,2	15	20	25
1,6	15	20	25
2	15	20	25
2,4	15	20	25
3,1	14,86	20	25
4	14,6	19,78	25
5	-	19,46	24,73
6	-	-	24,46

Insert corner radius	$a_p = 0.75''$	$a_p = 1.00''$
0.016	0.75	1.00
0.032	0.75	1.00
0.047	0.75	1.00
0.063	0.75	1.00
0.079	0.75	1.00
0.094	0.75	1.00
0.122	0.75	1.00
0.157	0.741	1.00
0.197	0.729	0.989
0.236	-	0.979

Width and profile generated by LNHQ* insert with fixed pocket cutter for $a_p = 25\text{mm}$, $a_p = 1.00''$

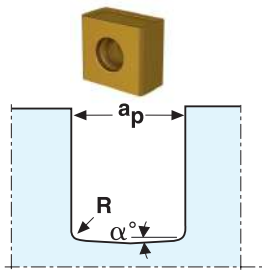

Insert corner radius mm	a_p mm generated	angle α°
0,8	25,17	2
3,1	25,02	2
4	24,92	2
5	24,78	2
6	24,64	2

Insert corner radius inch	a_p inch generated	angle α°
0.0315	1.007	2
0.122	1.001	2
0.157	0.997	2
0.197	0.992	2
0.236	0.986	2

*LNHQ is an insert intended for roughing in difficult conditions (this will not generate a flat bottom).

Width and profile generated with XNHQ 14 and 17 insert, radii 5 and 6 mm, radii 0.197'' and 0.236'' with adjustable cutter

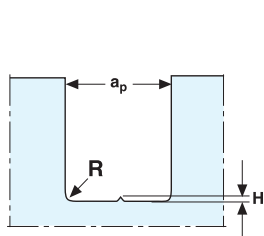

Width cutter	a_p mm	H (mm)	
		Radius 5	Radius 6
21-26	25,5	0	0
21-26	25,8	0	0,01
21-26	26,0	0,01	0,03
26-32	31,7	0	0
26-32	32,0	0	0,01

Width cutter	a_p inch	H (inch)	
		Radius 0.197''	Radius 0.236''
0.83-1.02	1.004	0	0
0.83-1.02	1.016	0	.0004
0.83-1.02	1.024	.0004	.0011
1.02-1.26	1.248	0	0
1.02-1.26	1.260	0	.0004

Profile machined with adjustable 335.18/335.25 cutter

335.18/335.25 cutter equipped with round inserts mm/inch

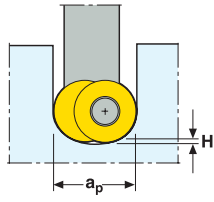
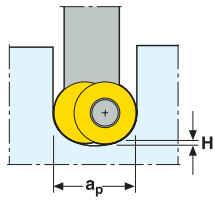
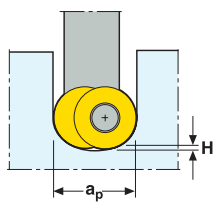
	a_p min a_p max	Round 8		Round 8		Round 10		Round 10	
		a_p mm	Profile height H mm	a_p inch	Profile height H inch	a_p mm	Profile height H mm	a_p inch	Profile height H inch
		8,03	0	.316	0	10,03	0	.406	0
		8,50	0	.335	0	10,50	0	.413	0
		9,00	0,03	.354	.001	11,00	0,025	.433	.001
		9,50	0,07	.374	.003	11,50	0,060	.453	.002
		Recom. min setting width is 8,03 mm		Recom. min setting width is .316 inch		Recom. min setting width is 10,03 mm		Recom. min setting width is .406 inch	
	a_p min a_p max	Round 12		Round 12		Round 16		Round 16	
		a_p mm	Profile height H mm	a_p mm	Profile height H mm	a_p mm	Profile height H mm	a_p inch	Profile height H inch
		12,03	0	.474	0	16,03	0	.631	0
		12,50	0,01	.492	.0004	16,50	0	.650	0
		13,00	0,02	.512	.001	17,00	0,02	.669	.001
		14,00	0,08	.551	.002			.709	.002
		Recom. min setting width is 12,03 mm		Recom. min setting width is .474 inch		Recom. min setting width is 16,03 mm		Recom. min setting width is .631 inch	
	a_p min a_p max	Round 20		Round 20		Round 20		Round 20	
		a_p mm	Profile height H mm	a_p mm	Profile height H mm	a_p mm	Profile height H mm	a_p mm	Profile height H mm
		20,03	0			0,789	0,0000		
		20,5	0,01			0,807	0,0004		
		21	0,02			0,827	0,0008		
				Recom. min setting width is 20,03 mm		Recom. min setting width is 0,789 inch			

Square shoulder and slot milling cutters

Helical milling cutters

Face milling cutters

Disc milling cutters

High feed milling cutters

Copy milling cutters

Plunge milling cutters

Chamfer milling cutters

Spot facing cutters

Inserts

Spare parts

(R)335.18 -LNK and round insert - Adjustable design - Metric

(R)335.18-xxx-	Insert type	Insert screw/Nm	Insert key	Wedge	Wedge screw	Key for wedge screw	Adjusting screw	Key for adjusting screw	Cassettes R335.18-...	Cassettes L335.18-...
0810	LN.K05...	C02508-T08P/1,2	H4B-T08P	335.18-607	LD5018F-T15P	H6B-T15PL	SH6004-T08P	H4B-T08P	...0810-05	...0810-05
0810XL	LN.K05...	C02508-T08P/1,2	H4B-T08P	335.18-XL607	LD5018F-T15P	H6B-T15PL	SH6004-T08P	H4B-T08P	...0810XL-05	...0810XL-05
0810	RD..08..	C02506-T08P/1,2	H4B-T08P	335.18-607	LD5018F-T15P	H6B-T15PL	SH6004-T08P	H4B-T08P	N335.18-08-R4	N335.18-08-R4
0810XL	RD..08..	C02506-T08P/1,2	H4B-T08P	335.18-XL607	LD5018F-T15P	H6B-T15PL	SH6004-T08P	H4B-T08P	N335.18-08XL-R4	N335.18-08XL-R4
1012	LNK.06..	C73007-T09P/2,0	H4B-T09P	335.18-609	LD6018F-T20P	H6B-T20PL	SH6005-T09P	H4B-T09P	...1012-06	...1012-06
1012XL	LNK.06..	C73007-T09P/2,0	H4B-T09P	335.18-XL609	LD6018F-T20P	H6B-T20PL	SH6005-T09P	H4B-T09P	...1012XL-06	...1012XL-06
1012	RD..10T3	C03007-T09P/2,0	H4B-T09P	335.18-609	LD6018F-T20P	H6B-T20PL	SH6005-T09P	H4B-T09P	...10-R5I	...10-R5I
1012XL	RD..10T3	C03007-T09P/2,0	H4B-T09P	335.18-XL609	LD6018F-T20P	H6B-T20PL	SH6005-T09P	H4B-T09P	...10XL-R5I	...10XL-R5I
1215	LNK08..	C73007-T09P/2,0	H4B-T09P	335.18-611	LD6018F-T20P	H6B-T20PL	SH6005-T09P	H4B-T09P	...1215-08	...1215-08
1215XL	LNK08..	C73007-T09P/2,0	H4B-T09P	335.18-XL611	LD6018F-T20P	H6B-T20PL	SH6005-T09P	H4B-T09P	...1215XL-08	...1215XL-08
1215	RP..12..	C03508-T15P/3,0	H6B-T15PL	335.18-611	LD6018F-T20P	H6B-T20PL	SH6005-T09P	H4B-T09P	...12-R6	...12-R6
1215XL	RP..12..	C03508-T15P/3,0	H6B-T15PL	335.18-XL611	LD6018F-T20P	H6B-T20PL	SH6005-T09P	H4B-T09P	...12XL-R6	...12XL-R6

Torque and fixed keys, see page 894

(R)335.18 -LNK and round insert - Adjustable design - Inch

(R)335.18-xxx-	Insert type	Insert screw/ in.lbs	Insert key	Wedge	Wedge screw	Key for wedge screw	Adjusting screw	Key for adjusting screw	Cassettes R335.18-...	Cassettes L335.18-...
0506	LN.K05...	C02508-T08P 10.6	H4B-T08P	335.18-607	LD5018F-T15P	H6B-T15PL	SH6004-T08P	H4B-T08P	...0810-05	...0810-05
XL0506	LN.K05...	C02508-T08P 10.6	H4B-T08P	335.18-XL607	LD5018F-T15P	H6B-T15PL	SH6004-T08P	H4B-T08P	...0810XL-05	...0810XL-05
0506	RD..08..	C02508-T08P 10.6	H4B-T08P	335.18-607	LD5018F-T15P	H6B-T15PL	SH6004-T08P	H4B-T08P	N335.18-08-R4	N335.18-08-R4
XL0506	RD..08..	C02508-T08P 10.6	H4B-T08P	335.18-XL607	LD5018F-T15P	H6B-T15PL	SH6004-T08P	H4B-T08P	N335.18-08XL-R4	N335.18-08XL-R4
0708	LNK.06..	C73007-T09P 17.7	H4B-T08P	335.18-609	LD6018F-T20P	H6B-T20PL	SH6005-T09P	H4B-T09P	...1012-06	...1012-06
XL0708	LNK.06..	C73007-T09P 17.7	H4B-T09P	335.18-XL609	LD6018F-T20P	H6B-T20PL	SH6005-T09P	H4B-T09P	...1012XL-06	...1012XL-06
0708	RD..10T3	C73007-T09P 17.7	H4B-T09P	335.18-609	LD6018F-T20P	H6B-T20PL	SH6005-T09P	H4B-T09P	...10-R5	...10-R5
XL0708	RD..10T3	C73007-T09P 17.7	H4B-T09P	335.18-XL609	LD6018F-T20P	H6B-T20PL	SH6005-T09P	H4B-T09P	...10XL-R5	...10XL-R5
0809	LNK08..	C73007-T09P 17.7	H4B-T09P	335.18-611	LD6018F-T20P	H6B-T20PL	SH6005-T09P	H4B-T09P	...1215-08	...1215-08
XL0809	LNK08..	C73007-T09P 17.7	H4B-T09P	335.18-XL611	LD6018F-T20P	H6B-T20PL	SH6005-T09P	H4B-T09P	...1215XL-08	...1215XL-08
0809	RP..12..	C03508-T15P 26.6	H4B-T09P	335.18-611	LD6018F-T20P	H6B-T20PL	SH6005-T09P	H4B-T09P	...12-R6	...12-R6
XL0809	RP..12..	C03508-T15P 26.6	H6B-T15PL	335.18-XL611	LD6018F-T20P	H6B-T20PL	SH6005-T09P	H4B-T09P	...12XL-R6	...12XL-R6

Torque and fixed keys, see page 894

Spare parts

For adjustable cutter (R)335.25 equipped with XHNQ/LNHQ inserts - Metric

(R)335.25-xxx-	Insert type	Insert screw/Nm	Insert key	Wedge	Wedge screw	Key for wedge screw	Adjusting screw	Key for adjusting screw	Cassettes R335.25-...	Cassettes L335.25-...
										
1317	XHNQ09	C03509-T10P/3	H4B-T10P	335.25-612	LD6018F-T20P	H6B-T20PL	SH6005-T09P	H4B-T09P	1317-09*	1317-09*
1317XL	XHNQ09	C03509-T10P/3	H4B-T10P	335.25-612	LD6018F-T20P	H6B-T20PL	SH6005-T09P	H4B-T09P	1317XL-09	1317XL-09
1721	XHNQ12	C03511-T10P/3	H4B-T10P	335.25-616	LD6018F-T20P	H6B-T20PL	SH6005-T09P	H4B-T09P	1721-12**	1721-12**
1721XL	XHNQ12	C03511-T10P/3	H4B-T10P	335.25-616	LD6018F-T20P	H6B-T20PL	SH6005-T09P	H4B-T09P	1721XL-12	1721XL-12
2126	XHNQ14 / LNHQ14	C04013-T15P/5	H4B-T15P	335.25-620	LD6018F-T20P	H6B-T20PL	SH6005-T09P	H4B-T09P	2126-14***	2126-14***
2126XL	XHNQ14 / LNHQ14	C04013-T15P/5	H4B-T15P	335.25-620	LD6018F-T20P	H6B-T20PL	SH6005-T09P	H4B-T09P	2126XL-14	2126XL-14
2632	XHNQ17 / LNHQ17	C05013-T20P/5	H6B-T20P	335.25-625	LD6018F-T20P	H6B-T20PL	SH6005-T09P	H4B-T09P	2632-17****	2632-17****
2632XL	XHNQ17 / LNHQ17	C05013-T20P/5	H6B-T20P	335.25-625	LD6018F-T20P	H6B-T20PL	SH6005-T09P	H4B-T09P	2632XL-17	2632XL-17







*Cassette compatible with adjustable disc milling cutter x335.18-xxx-1418 series to generate width of cut from 14 to 17 mm, generating nominal "DC" diameter

**Cassette compatible with adjustable disc milling cutter x335.18-xxx-1924 series to generate width of cut from 18.5 to 21 mm, generating nominal "DC" diameter

***Cassette compatible with adjustable disc milling cutter x335.18-xxx-2530 series to generate width of cut from 24,3 to 26 mm, generating nominal "DC" diameter

**** Cassette compatible with adjustable disc milling cutter x335.18-xxx-2530 series to generate width of cut from 26 to 30,5 mm, generating nominal "DC" diameter

For adjustable cutter (R)335.25 equipped with round insert dia 16 and 20mm - Metric

(R)335.25-xxx-	Insert type	Insert screw/Nm	Insert key	Wedge	Wedge screw	Key for wedge screw	Adjusting screw	Key for adjusting screw	Cassettes R335.25-...	Cassettes L335.25-...
										
1317	RP..1605	C05010-T20P / 5	H6B-T20P	335.25-612	LD6018F-T20P	H6B-T20PL	SH6005-T09P	H4B-T09P	...16-R8I-D5*	...16-R8I-D5*
1317XL	RP..1605	C05010-T20P / 5	H6B-T20P	335.25-612	LD6018F-T20P	H6B-T20PL	SH6005-T09P	H4B-T09P	...16XL-R8I-D5	...16XL-R8I-D5
1721XL	RP..2006	C05013-T20P / 5	H6B-T20P	335.25-616	LD6018F-T20P	H6B-T20PL	SH6005-T09P	H4B-T09P	...20XL-R10-D5	...20XL-R10-D5

*Cassette compatible with adjustable disc milling cutter x335.18-xxx-1418 series to generate width of cut from 16 to 18,5 mm, generating nominal "DC" diameter +5mm

Square shoulder and slot milling cutters
Helical milling cutters
Face milling cutters
Disc milling cutters
High feed milling cutters
Copy milling cutters
Plunge milling cutters
Chamfer milling cutters
Spot facing cutters
Inserts

Spare parts

Spare parts for adjustable cutter (R)335.25 equipped with XHNQ/LNHQ inserts - Inch

(R)335.25-xxx-	Insert type	Insert screw/in. lbs	Insert key	Wedge	Wedge screw	Key for wedge screw	Adjusting screw	Key for adjusting screw	Cassettes R335.25-...	Cassettes L335.25-...
0911	XNHQ09	C03509-T10P/26.5	H4B-T10P	335.25-612	LD6018F-T20P	H6B-T20PL	SH6005-T09P	H4B-T09P	1317-09*	1317-09*
XL0911	XNHQ09	C03509-T10P/26.5	H4B-T10P	335.25-612	LD6018F-T20P	H6B-T20PL	SH6005-T09P	H4B-T09P	1317XL-09	1317XL-09
1113	XNHQ12	C03511-T10P/26.5	H4B-T10P	335.25-616	LD6018F-T20P	H6B-T20PL	SH6005-T09P	H4B-T09P	1721-12**	1721-12**
XL1113	XNHQ12	C03511-T10P/26.5	H4B-T10P	335.25-616	LD6018F-T20P	H6B-T20PL	SH6005-T09P	H4B-T09P	1721XL-12	1721XL-12
1316	XNHQ14 / LNHQ14	C04013-T15P/44	H4B-T15P	335.25-620	LD6018F-T20P	H6B-T20PL	SH6005-T09P	H4B-T09P	2126-14***	2126-14***
XL1316	XNHQ14 / LNHQ14	C04013-T15P/44	H4B-T15P	335.25-620	LD6018F-T20P	H6B-T20PL	SH6005-T09P	H4B-T09P	2126XL-14	2126XL-14
1620	XNHQ17 / LNHQ17	C05013-T20P/44	H6B-T20P	335.25-625	LD6018F-T20P	H6B-T20PL	SH6005-T09P	H4B-T09P	2632-17****	2632-17****
XL1620	XNHQ17 / LNHQ17	C05013-T20P/44	H6B-T20P	335.25-625	LD6018F-T20P	H6B-T20PL	SH6005-T09P	H4B-T09P	2632XL-17	2632XL-17

*Cassette compatible with adjustable disc milling cutter x335.18-xxx-1418 series to generate width of cut from 14 to 17 mm, generating nominal "DC" diameter
 **Cassette compatible with adjustable disc milling cutter x335.18-xxx-1924 series to generate width of cut from 18,5 to 21 mm, generating nominal "DC" diameter
 ***Cassette compatible with adjustable disc milling cutter x335.18-xxx-2530 series to generate width of cut from 24,3 to 26 mm, generating nominal "DC" diameter
 **** Cassette compatible with adjustable disc milling cutter x335.18-xxx-2530 series to generate width of cut from 26 to 30,5 mm, generating nominal "DC" diameter

Spare parts for adjustable cutter (R)335.25 equipped with round insert dia 16 and 20mm - Inch

(R)335.25-xxx-	Insert type	Insert screw/in. lbs	Insert key	Wedge	Wedge screw	Key for wedge screw	Adjusting screw	Key for adjusting screw	Cassettes R335.25-...	Cassettes L335.25-...
0911	RP.1605	C05010-T20P/44.3	H6B-T20P	335.25-612	LD6018F-T20P	H6B-T20PL	SH6005-T09P	H4B-T09P	...16-R8I-D5*	...16-R8I-D5*
XL0911	RP.1605	C05010-T20P/44.3	H6B-T20P	335.25-612	LD6018F-T20P	H6B-T20PL	SH6005-T09P	H4B-T09P	...16XL-R8I-D5	...16XL-R8I-D5
XL1113	RP.2006	C05010-T20P/44.3	H6B-T20P	335.25-616	LD6018F-T20P	H6B-T20PL	SH6005-T09P	H4B-T09P	...20XL-R10-D5	...20XL-R10-D5

*Cassette compatible with adjustable disc milling cutter x335.18-xxx-1418 series to generate width of cut from 16 to 18,5 mm, generating nominal "DC" diameter +5mm

Square shoulder and slot milling cutters
 Helical milling cutters
 Face milling cutters
 Disc milling cutters
 High feed milling cutters
 Copy milling cutters
 Plunge milling cutters
 Chamfer milling cutters
 Spot facing cutters
 Inserts

335.18-LNK – Insert selection – mm/Inch

SMG				f _z		
				30%	20%	10%
P1	LNKT05...-M06 F40M	LNKT06...-M06 F40M	LNKT08...-M06 F40M	0,12	0,14	0,19
				0,0048	0,0055	0,0075
P2	LNKT05...-M06 F40M	LNKT06...-M06 F40M	LNKT08...-M06 F40M	0,13	0,14	0,19
				0,0050	0,0055	0,0075
P3	LNKT05...-M06 F40M	LNKT06...-M06 F40M	LNKT08...-M06 F40M	0,12	0,14	0,18
				0,0048	0,0055	0,0070
P4	LNKT05...-M06 F40M	LNKT06...-M06 F40M	LNKT08...-M06 F40M	0,12	0,13	0,18
				0,0048	0,0050	0,0070
P5	LNKT05...-M06 F40M	LNKT06...-M06 F40M	LNKT08...-M06 F40M	0,11	0,13	0,17
				0,0044	0,0050	0,0065
P6	LNKT05...-M06 F40M	LNKT06...-M06 F40M	LNKT08...-M06 F40M	0,11	0,13	0,17
				0,0044	0,0050	0,0065
P7	LNKT05...-M06 F40M	LNKT06...-M06 F40M	LNKT08...-M06 F40M	0,11	0,13	0,17
				0,0044	0,0050	0,0065
P8	LNKT05...-M06 MP3000	LNKT06...-M06 MP3000	LNKT08...-M06 MP3000	0,12	0,14	0,18
				0,0048	0,0055	0,0070
P11	LNKT05...-M06 F40M	LNKT06...-M06 F40M	LNKT08...-M06 F40M	0,11	0,13	0,17
				0,0044	0,0050	0,0065
P12	LNKT05...-M06 F40M	LNKT06...-M06 F40M	LNKT08...-M06 F40M	0,075	0,090	0,12
				0,0030	0,0036	0,0048
M1	LNKT05...-M06 F40M	LNKT06...-M06 F40M	LNKT08...-M06 F40M	0,13	0,14	0,19
				0,0050	0,0055	0,0075
M2	LNKT05...-M06 F40M	LNKT06...-M06 F40M	LNKT08...-M06 F40M	0,11	0,13	0,17
				0,0044	0,0050	0,0065
M3	LNKT05...-M06 F40M	LNKT06...-M06 F40M	LNKT08...-M06 F40M	0,090	0,10	0,14
				0,0036	0,0040	0,0055
M4	LNKT05...-M06 F40M	LNKT06...-M06 F40M	LNKT08...-M06 F40M	0,080	0,090	0,12
				0,0032	0,0036	0,0048
M5	LNKT05...-M06 F40M	LNKT06...-M06 F40M	LNKT08...-M06 F40M	0,080	0,090	0,12
				0,0032	0,0036	0,0048
K1	LNKT05...-M06 MP3000	LNKT06...-M06 MK2050	LNKT08...-M06 MK2050	0,13	0,14	0,19
				0,0050	0,0055	0,0075
K2	LNKT05...-M06 MP3000	LNKT06...-M06 MK2050	LNKT08...-M06 MK2050	0,11	0,13	0,17
				0,0044	0,0050	0,0065
K3	LNKT05...-M06 MP3000	LNKT06...-M06 MK2050	LNKT08...-M06 MK2050	0,11	0,13	0,17
				0,0044	0,0050	0,0065
K4	LNKT05...-M06 MP3000	LNKT06...-M06 MK2050	LNKT08...-M06 MK2050	0,11	0,13	0,17
				0,0044	0,0050	0,0065
K5	LNKT05...-M06 MP3000	LNKT06...-M06 MK2050	LNKT08...-M06 MK2050	0,10	0,12	0,16
				0,0040	0,0048	0,0065
K6	LNKT05...-M06 MP3000	LNKT06...-M06 MK2050	LNKT08...-M06 MK2050	0,11	0,13	0,17
				0,0044	0,0050	0,0065
K7	LNKT05...-M06 MP3000	LNKT06...-M06 MK2050	LNKT08...-M06 MK2050	0,10	0,12	0,16
				0,0040	0,0048	0,0065
N1	LNKT05...-E05 H25	LNKT06...-E05 H25	LNKT08...-E05 H25	0,14	0,16	0,22
				0,0055	0,0065	0,0085
N2	LNKT05...-E05 H25	LNKT06...-E05 H25	LNKT08...-E05 H25	0,14	0,16	0,22
				0,0055	0,0065	0,0085
N3	LNKT05...-E05 H25	LNKT06...-E05 H25	LNKT08...-E05 H25	0,14	0,16	0,22
				0,0055	0,0065	0,0085
N11	LNKT05...-E05 H25	LNKT06...-E05 H25	LNKT08...-E05 H25	0,14	0,16	0,22
				0,0055	0,0065	0,0085
S1	LNKT05...-M06 F40M	LNKT06...-M06 F40M	LNKT08...-M06 F40M	0,080	0,090	0,12
				0,0032	0,0036	0,0048
S2	LNKT05...-M06 F40M	LNKT06...-M06 F40M	LNKT08...-M06 F40M	0,080	0,090	0,12
				0,0032	0,0036	0,0048
S3	LNKT05...-M06 F40M	LNKT06...-M06 F40M	LNKT08...-M06 F40M	0,075	0,085	0,11
				0,0030	0,0034	0,0044
S11	LNKT05...-M06 F40M	LNKT06...-M06 F40M	LNKT08...-M06 F40M	0,090	0,10	0,14
				0,0036	0,0040	0,0055
S12	LNKT05...-M06 F40M	LNKT06...-M06 F40M	LNKT08...-M06 F40M	0,090	0,10	0,14
				0,0036	0,0040	0,0055
S13	LNKT05...-M06 F40M	LNKT06...-M06 F40M	LNKT08...-M06 F40M	0,080	0,090	0,12
				0,0032	0,0036	0,0048
H5	LNKT05...-M06 MP3000	LNKT06...-M06 MP3000	LNKT08...-M06 MP3000	0,075	0,090	0,12
				0,0030	0,0036	0,0048
H8	LNKT05...-M06 MP3000	LNKT06...-M06 MP3000	LNKT08...-M06 MP3000	0,060	0,070	0,090
				0,0024	0,0028	0,0036
H11	LNKT05...-M06 F40M	LNKT06...-M06 F40M	LNKT08...-M06 F40M	0,075	0,090	0,12
				0,0030	0,0036	0,0048
H12	LNKT05...-M06 F40M	LNKT06...-M06 F40M	LNKT08...-M06 F40M	0,060	0,070	0,090
				0,0024	0,0028	0,0036
H21	LNKT05...-M06 MP3000	LNKT06...-M06 MP3000	LNKT08...-M06 MP3000	0,060	0,070	0,090
				0,0024	0,0028	0,0036

SMG = Seco material group
f_z = mm/tooth (in/tooth), v_c = m/min (sf/min), a_p/DC = %
All cutting data are start values

Square shoulder and slot milling cutters
Helical milling cutters
Face milling cutters
Disc milling cutters
High feed milling cutters
Copy milling cutters
Plunge milling cutters
Chamfer milling cutters
Spot facing cutters
Inserts

335.25-XN09 – Insert selection – mm/Inch

SMG		f _z		
		30%	20%	10%
P1	XNHQ090508TN4-M08 F40M	0,14	0,16	0,22
		0.0055	0.0065	0.0085
P2	XNHQ090508TN4-M08 F40M	0,14	0,16	0,22
		0.0055	0.0065	0.0085
P3	XNHQ090508TN4-M08 F40M	0,13	0,15	0,20
		0.0050	0.0060	0.0080
P4	XNHQ090508TN4-M08 F40M	0,13	0,15	0,20
		0.0050	0.0060	0.0080
P5	XNHQ090508TN4-M08 F40M	0,13	0,15	0,20
		0.0050	0.0060	0.0080
P6	XNHQ090508TN4-M08 F40M	0,13	0,15	0,19
		0.0050	0.0060	0.0075
P7	XNHQ090508TN4-M08 F40M	0,13	0,15	0,19
		0.0050	0.0060	0.0075
P8	XNHQ090508TN4-M08 MP2501	0,13	0,15	0,20
		0.0050	0.0060	0.0080
P11	XNHQ090508TN4-M08 F40M	0,13	0,15	0,19
		0.0050	0.0060	0.0075
P12	XNHQ090508TN4-M08 F40M	0,085	0,10	0,13
		0.0034	0.0040	0.0050
M1	XNHQ090508TN4-M08 F40M	0,14	0,16	0,22
		0.0055	0.0065	0.0085
M2	XNHQ090508TN4-M08 F40M	0,13	0,15	0,20
		0.0050	0.0060	0.0080
M3	XNHQ090508TN4-M08 F40M	0,10	0,12	0,16
		0.0040	0.0048	0.0065
M4	XNHQ090508TN4-M08 F40M	0,090	0,10	0,14
		0.0036	0.0040	0.0055
M5	XNHQ090508TN4-M08 F40M	0,090	0,10	0,14
		0.0036	0.0040	0.0055
K1	XNHQ090508TN4-M08 MK2050	0,14	0,16	0,22
		0.0055	0.0065	0.0085
K2	XNHQ090508TN4-M08 MK2050	0,13	0,15	0,20
		0.0050	0.0060	0.0080
K3	XNHQ090508TN4-M08 MK2050	0,13	0,15	0,20
		0.0050	0.0060	0.0080
K4	XNHQ090508TN4-M08 MK2050	0,13	0,15	0,20
		0.0050	0.0060	0.0080
K5	XNHQ090508TN4-M08 MK2050	0,12	0,13	0,18
		0.0048	0.0050	0.0070
K6	XNHQ090508TN4-M08 MK2050	0,13	0,15	0,20
		0.0050	0.0060	0.0080
K7	XNHQ090508TN4-M08 MK2050	0,12	0,13	0,18
		0.0048	0.0050	0.0070
N1	XNHQ090508EN4-E07 F40M	0,16	0,18	0,24
		0.0065	0.0070	0.0095
N2	XNHQ090508EN4-E07 F40M	0,16	0,18	0,24
		0.0065	0.0070	0.0095
N3	XNHQ090508EN4-E07 F40M	0,16	0,18	0,24
		0.0065	0.0070	0.0095
N11	XNHQ090508EN4-E07 F40M	0,16	0,18	0,24
		0.0065	0.0070	0.0095
S1	XNHQ090508TN4-M08 F40M	0,090	0,10	0,14
		0.0036	0.0040	0.0055
S2	XNHQ090508TN4-M08 F40M	0,090	0,10	0,14
		0.0036	0.0040	0.0055
S3	XNHQ090508TN4-M08 F40M	0,085	0,095	0,13
		0.0034	0.0038	0.0050
S11	XNHQ090508TN4-M08 F40M	0,10	0,12	0,16
		0.0040	0.0048	0.0065
S12	XNHQ090508TN4-M08 F40M	0,10	0,12	0,16
		0.0040	0.0048	0.0065
S13	XNHQ090508TN4-M08 F40M	0,090	0,10	0,14
		0.0036	0.0040	0.0055
H5	XNHQ090508TN4-M08 MP2501	0,085	0,10	0,13
		0.0034	0.0040	0.0050
H8	XNHQ090508TN4-M08 MP2501	0,065	0,075	0,10
		0.0026	0.0030	0.0040
H11	XNHQ090508TN4-M08 F40M	0,085	0,10	0,13
		0.0034	0.0040	0.0050
H12	XNHQ090508TN4-M08 F40M	0,065	0,075	0,10
		0.0026	0.0030	0.0040
H21	XNHQ090508TN4-M08 MP2501	0,065	0,075	0,10
		0.0026	0.0030	0.0040

SMG = Seco material group
f_z = mm/tooth (in/tooth), v_c = m/min (sf/min), a_p/DC = %
All cutting data are start values

Square shoulder and slot milling cutters
Helical milling cutters
Face milling cutters
Disc milling cutters
High feed milling cutters
Copy milling cutters
Plunge milling cutters
Chamfer milling cutters
Spot facing cutters
Inserts

335.25-XN09 – Cutting data $v_c = (m/min)/(sf/min)$

SMG	F40M			MP2501			MK2050		
	30%	20%	10%	30%	20%	10%	30%	20%	10%
P1	185	195	215	240	260	285	240	255	280
	610	640	710	790	850	940	790	840	920
P2	180	190	210	235	255	280	230	250	275
	590	620	690	770	840	920	750	820	900
P3	155	170	185	205	220	245	205	220	240
	510	560	610	670	720	800	670	720	790
P4	140	150	165	180	195	215	180	190	210
	460	490	540	590	640	710	590	620	690
P5	130	140	155	175	185	205	170	185	205
	425	460	510	570	610	670	560	610	670
P6	150	160	180	195	210	235	195	205	230
	490	520	590	640	690	770	640	670	750
P7	140	150	170	185	195	220	180	195	220
	460	490	560	610	640	720	590	640	720
P8	130	140	155	175	185	205	170	185	205
	425	460	510	570	610	670	560	610	670
P11	135	145	165	180	190	215	175	190	210
	445	475	540	590	620	710	570	620	690
P12	90	95	105	120	125	140	115	125	135
	295	310	345	395	410	460	375	410	445
M1	145	155	170	170	180	200	—	—	—
	475	510	560	560	590	660	—	—	—
M2	120	125	140	140	150	165	—	—	—
	395	410	460	460	490	540	—	—	—
M3	95	100	115	115	120	135	—	—	—
	310	330	375	375	395	445	—	—	—
M4	75	80	90	90	95	105	—	—	—
	245	260	295	295	310	345	—	—	—
M5	60	65	75	75	80	85	—	—	—
	195	215	245	245	260	280	—	—	—
K1	140	150	165	185	200	220	250	270	295
	460	490	540	610	660	720	820	890	970
K2	125	135	150	165	175	195	220	235	260
	410	445	490	540	570	640	720	770	850
K3	105	115	125	140	150	165	190	200	220
	345	375	410	460	490	540	620	660	720
K4	100	110	120	135	145	160	180	190	210
	330	360	395	445	475	520	590	620	690
K5	60	65	75	80	90	95	110	120	130
	195	215	245	260	295	310	360	395	425
K6	90	95	105	120	125	140	160	170	185
	295	310	345	395	410	460	520	560	610
K7	80	85	95	105	115	125	140	150	165
	260	280	310	345	375	410	460	490	540
N1	1050	1125	1225	—	—	—	—	—	—
	3450	3700	4025	—	—	—	—	—	—
N2	420	455	500	—	—	—	—	—	—
	1375	1500	1650	—	—	—	—	—	—
N3	280	305	330	—	—	—	—	—	—
	920	1000	1075	—	—	—	—	—	—
N11	320	345	380	—	—	—	—	—	—
	1050	1125	1250	—	—	—	—	—	—
S1	35	37	41	43	46	50	—	—	—
	115	120	135	140	150	165	—	—	—
S2	28	30	33	34	37	41	—	—	—
	90	100	110	110	120	135	—	—	—
S3	24	26	29	30	32	36	—	—	—
	80	85	95	100	105	120	—	—	—
S11	49	50	55	60	65	70	—	—	—
	160	165	180	195	215	230	—	—	—
S12	41	43	48	50	55	60	—	—	—
	135	140	155	165	180	195	—	—	—
S13	24	26	28	29	31	34	—	—	—
	80	85	90	95	100	110	—	—	—
H5	30	31	35	35	38	42	—	—	—
	100	100	115	115	125	140	—	—	—
H8	31	33	37	38	40	44	—	—	—
	100	110	120	125	130	145	—	—	—
H11	38	40	44	45	48	55	—	—	—
	125	130	145	150	155	180	—	—	—
H12	36	39	43	44	47	50	—	—	—
	120	130	140	145	155	165	—	—	—
H21	31	33	37	38	40	44	—	—	—
	100	110	120	125	130	145	—	—	—

335.25-XN12 – Insert selection – mm/Inch

SMG		f _z		
		30%	20%	10%
P1	XNHQ120608TN4-M10 F40M	0,17 0.0065	0,19 0.0075	0,26 0.010
P2	XNHQ120608TN4-M10 F40M	0,17 0.0065	0,20 0.0080	0,26 0.010
P3	XNHQ120608TN4-M10 F40M	0,16 0.0065	0,19 0.0075	0,25 0.010
P4	XNHQ120608TN4-M10 F40M	0,16 0.0065	0,18 0.0070	0,24 0.0095
P5	XNHQ120608TN4-M10 F40M	0,16 0.0065	0,18 0.0070	0,24 0.0095
P6	XNHQ120608TN4-M10 F40M	0,15 0.0060	0,18 0.0070	0,24 0.0095
P7	XNHQ120608TN4-M10 F40M	0,15 0.0060	0,18 0.0070	0,24 0.0095
P8	XNHQ120608TN4-M10 MP2501	0,16 0.0065	0,19 0.0075	0,25 0.010
P11	XNHQ120608TN4-M10 F40M	0,15 0.0060	0,18 0.0070	0,24 0.0095
P12	XNHQ120608TN4-M10 F40M	0,11 0.0044	0,12 0.0048	0,16 0.0065
M1	XNHQ120608TN4-M10 F40M	0,17 0.0065	0,20 0.0080	0,26 0.010
M2	XNHQ120608TN4-M10 F40M	0,16 0.0065	0,18 0.0070	0,24 0.0095
M3	XNHQ120608TN4-M10 F40M	0,12 0.0048	0,14 0.0055	0,19 0.0075
M4	XNHQ120608TN4-M10 F40M	0,11 0.0044	0,13 0.0050	0,17 0.0065
M5	XNHQ120608TN4-M10 F40M	0,11 0.0044	0,13 0.0050	0,17 0.0065
K1	XNHQ120608TN4-M10 MK2050	0,17 0.0065	0,20 0.0080	0,26 0.010
K2	XNHQ120608TN4-M10 MK2050	0,16 0.0065	0,18 0.0070	0,24 0.0095
K3	XNHQ120608TN4-M10 MK2050	0,16 0.0065	0,18 0.0070	0,24 0.0095
K4	XNHQ120608TN4-M10 MK2050	0,16 0.0065	0,18 0.0070	0,24 0.0095
K5	XNHQ120608TN4-M10 MK2050	0,14 0.0055	0,16 0.0065	0,22 0.0085
K6	XNHQ120608TN4-M10 MK2050	0,16 0.0065	0,18 0.0070	0,24 0.0095
K7	XNHQ120608TN4-M10 MK2050	0,14 0.0055	0,16 0.0065	0,22 0.0085
N1	XNHQ120608EN4-E09 F40M	0,20 0.0080	0,22 0.0085	0,30 0.012
N2	XNHQ120608EN4-E09 F40M	0,20 0.0080	0,22 0.0085	0,30 0.012
N3	XNHQ120608EN4-E09 F40M	0,20 0.0080	0,22 0.0085	0,30 0.012
N11	XNHQ120608EN4-E09 F40M	0,20 0.0080	0,22 0.0085	0,30 0.012
S1	XNHQ120608TN4-M10 F40M	0,11 0.0044	0,13 0.0050	0,17 0.0065
S2	XNHQ120608TN4-M10 F40M	0,11 0.0044	0,13 0.0050	0,17 0.0065
S3	XNHQ120608TN4-M10 F40M	0,10 0.0040	0,12 0.0048	0,16 0.0065
S11	XNHQ120608TN4-M10 F40M	0,12 0.0048	0,14 0.0055	0,19 0.0075
S12	XNHQ120608TN4-M10 F40M	0,12 0.0048	0,14 0.0055	0,19 0.0075
S13	XNHQ120608TN4-M10 F40M	0,11 0.0044	0,13 0.0050	0,17 0.0065
H5	XNHQ120608TN4-M10 MP2501	0,11 0.0044	0,12 0.0048	0,16 0.0065
H8	XNHQ120608TN4-M10 MP2501	0,080 0.0032	0,095 0.0038	0,12 0.0048
H11	XNHQ120608TN4-M10 F40M	0,11 0.0044	0,12 0.0048	0,16 0.0065
H12	XNHQ120608TN4-M10 F40M	0,080 0.0032	0,095 0.0038	0,12 0.0048
H21	XNHQ120608TN4-M10 MP2501	0,080 0.0032	0,095 0.0038	0,12 0.0048

SMG = Seco material group
f_z = mm/tooth (in/tooth), v_c = m/min (sf/min), a_p/DC = %
All cutting data are start values

Square shoulder and slot milling cutters
Helical milling cutters
Face milling cutters
Disc milling cutters
High feed milling cutters
Copy milling cutters
Plunge milling cutters
Chamfer milling cutters
Spot facing cutters
Inserts

335.25-XN12 – Cutting data $v_c = (m/min)/(sf/min)$

SMG	F40M			MP2501			MK2050		
	30%	20%	10%	30%	20%	10%	30%	20%	10%
P1	175	190	210	235	250	275	230	250	275
	570	620	690	770	820	900	750	820	900
P2	170	185	205	225	240	270	225	240	265
	560	610	670	740	790	890	740	790	870
P3	150	160	180	200	210	235	195	210	230
	490	520	590	660	690	770	640	690	750
P4	135	145	160	175	190	210	175	185	205
	445	475	520	570	620	690	570	610	670
P5	125	135	150	165	180	200	165	175	195
	410	445	490	540	590	660	540	570	640
P6	145	155	170	190	200	225	190	200	220
	475	510	560	620	660	740	620	660	720
P7	135	145	160	180	190	210	180	190	210
	445	475	520	590	620	690	590	620	690
P8	125	135	150	165	175	195	165	175	195
	410	445	490	540	570	640	540	570	640
P11	135	140	155	175	185	205	175	185	200
	445	460	510	570	610	670	570	610	660
P12	85	90	100	110	120	135	110	120	135
	280	295	330	360	395	445	360	395	445
M1	140	150	165	165	175	195	—	—	—
	460	490	540	540	570	640	—	—	—
M2	115	125	135	135	145	160	—	—	—
	375	410	445	445	475	520	—	—	—
M3	95	100	110	110	120	130	—	—	—
	310	330	360	360	395	425	—	—	—
M4	70	75	85	85	90	100	—	—	—
	230	245	280	280	295	330	—	—	—
M5	60	65	70	70	75	85	—	—	—
	195	215	230	230	245	280	—	—	—
K1	135	145	160	180	190	215	240	255	285
	445	475	520	590	620	710	790	840	940
K2	120	130	145	160	170	190	215	230	255
	395	425	475	520	560	620	710	750	840
K3	100	110	120	135	145	160	180	195	215
	330	360	395	445	475	520	590	640	710
K4	95	105	115	130	140	155	170	185	205
	310	345	375	425	460	510	560	610	670
K5	60	65	70	80	85	95	105	115	125
	195	215	230	260	280	310	345	375	410
K6	85	90	100	115	120	135	150	165	180
	280	295	330	375	395	445	490	540	590
K7	75	80	90	100	110	120	135	145	160
	245	260	295	330	360	395	445	475	520
N1	1000	1075	1175	—	—	—	—	—	—
	3275	3525	3850	—	—	—	—	—	—
N2	405	435	480	—	—	—	—	—	—
	1325	1425	1575	—	—	—	—	—	—
N3	270	290	320	—	—	—	—	—	—
	890	950	1050	—	—	—	—	—	—
N11	305	330	365	—	—	—	—	—	—
	1000	1075	1200	—	—	—	—	—	—
S1	34	36	40	41	44	49	—	—	—
	110	120	130	135	145	160	—	—	—
S2	27	29	32	33	35	39	—	—	—
	90	95	105	110	115	130	—	—	—
S3	24	25	28	29	31	34	—	—	—
	80	80	90	95	100	110	—	—	—
S11	48	50	55	60	60	70	—	—	—
	155	165	180	195	195	230	—	—	—
S12	40	43	47	49	50	60	—	—	—
	130	140	155	160	165	195	—	—	—
S13	23	24	27	28	30	33	—	—	—
	75	80	90	90	100	110	—	—	—
H5	28	31	34	34	37	41	—	—	—
	90	100	110	110	120	135	—	—	—
H8	31	32	36	37	39	43	—	—	—
	100	105	120	120	130	140	—	—	—
H11	36	39	43	43	47	50	—	—	—
	120	130	140	140	155	165	—	—	—
H12	36	38	42	43	45	50	—	—	—
	120	125	140	140	150	165	—	—	—
H21	31	32	36	37	39	43	—	—	—
	100	105	120	120	130	140	—	—	—

335.25-XN14/XN17 – Insert selection – mm/Inch

SMG			f _z		
			30%	20%	10%
P1	XNHQ140708TN4-M11 F40M	XNHQ170708TN4-M13 F40M	0,20	0,22	0,30
			0,0080	0,0085	0,012
P2	XNHQ140708TN4-M11 F40M	XNHQ170708TN4-M13 F40M	0,20	0,24	0,32
			0,0080	0,0095	0,013
P3	XNHQ140708TN4-M11 F40M	XNHQ170708TN4-M13 F40M	0,19	0,22	0,30
			0,0075	0,0085	0,012
P4	XNHQ140708TN4-M11 F40M	XNHQ170708TN4-M13 F40M	0,19	0,22	0,28
			0,0075	0,0085	0,011
P5	XNHQ140708TN4-M11 F40M	XNHQ170708TN4-M13 F40M	0,18	0,22	0,28
			0,0070	0,0085	0,011
P6	XNHQ140708TN4-M11 F40M	XNHQ170708TN4-M13 F40M	0,18	0,20	0,28
			0,0070	0,0080	0,011
P7	XNHQ140708TN4-M11 F40M	XNHQ170708TN4-M13 F40M	0,18	0,20	0,28
			0,0070	0,0080	0,011
P8	XNHQ140708TN4-M11 MP2501	XNHQ170708TN4-M13 MP2501	0,19	0,22	0,30
			0,0075	0,0085	0,012
P11	XNHQ140708TN4-M11 F40M	XNHQ170708TN4-M13 F40M	0,18	0,20	0,28
			0,0070	0,0080	0,011
P12	XNHQ140708TN4-M11 F40M	XNHQ170708TN4-M13 F40M	0,13	0,14	0,19
			0,0050	0,0055	0,0075
M1	XNHQ140708TN4-M11 F40M	XNHQ170708TN4-M13 F40M	0,20	0,24	0,32
			0,0080	0,0095	0,013
M2	XNHQ140708TN4-M11 F40M	XNHQ170708TN4-M13 F40M	0,18	0,22	0,28
			0,0070	0,0085	0,011
M3	XNHQ140708TN4-M11 F40M	XNHQ170708TN4-M13 F40M	0,15	0,17	0,22
			0,0060	0,0065	0,0085
M4	XNHQ140708TN4-M11 F40M	XNHQ170708TN4-M13 F40M	0,13	0,15	0,20
			0,0050	0,0060	0,0080
M5	XNHQ140708TN4-M11 F40M	XNHQ170708TN4-M13 F40M	0,13	0,15	0,20
			0,0050	0,0060	0,0080
K1	XNHQ140708TN4-M11 MK2050	XNHQ170708TN4-M13 MK2050	0,20	0,24	0,32
			0,0080	0,0095	0,013
K2	XNHQ140708TN4-M11 MK2050	XNHQ170708TN4-M13 MK2050	0,18	0,22	0,28
			0,0070	0,0085	0,011
K3	XNHQ140708TN4-M11 MK2050	XNHQ170708TN4-M13 MK2050	0,18	0,22	0,28
			0,0070	0,0085	0,011
K4	XNHQ140708TN4-M11 MK2050	XNHQ170708TN4-M13 MK2050	0,18	0,22	0,28
			0,0070	0,0085	0,011
K5	XNHQ140708TN4-M11 MK2050	XNHQ170708TN4-M13 MK2050	0,17	0,19	0,25
			0,0065	0,0075	0,010
K6	XNHQ140708TN4-M11 MK2050	XNHQ170708TN4-M13 MK2050	0,18	0,22	0,28
			0,0070	0,0085	0,011
K7	XNHQ140708TN4-M11 MK2050	XNHQ170708TN4-M13 MK2050	0,17	0,19	0,25
			0,0065	0,0075	0,010
N1	XNHQ140708EN4-E10 H25	XNHQ170708EN4-E12 F40M	0,24	0,28	0,36
			0,0095	0,011	0,014
N2	XNHQ140708EN4-E10 H25	XNHQ170708EN4-E12 F40M	0,24	0,28	0,36
			0,0095	0,011	0,014
N3	XNHQ140708EN4-E10 H25	XNHQ170708EN4-E12 F40M	0,24	0,28	0,36
			0,0095	0,011	0,014
N11	XNHQ140708EN4-E10 H25	XNHQ170708EN4-E12 F40M	0,24	0,28	0,36
			0,0095	0,011	0,014
S1	XNHQ140708TN4-M11 F40M	XNHQ170708TN4-M13 F40M	0,13	0,15	0,20
			0,0050	0,0060	0,0080
S2	XNHQ140708TN4-M11 F40M	XNHQ170708TN4-M13 F40M	0,13	0,15	0,20
			0,0050	0,0060	0,0080
S3	XNHQ140708TN4-M11 F40M	XNHQ170708TN4-M13 F40M	0,12	0,14	0,18
			0,0048	0,0055	0,0070
S11	XNHQ140708TN4-M11 F40M	XNHQ170708TN4-M13 F40M	0,15	0,17	0,22
			0,0060	0,0065	0,0085
S12	XNHQ140708TN4-M11 F40M	XNHQ170708TN4-M13 F40M	0,15	0,17	0,22
			0,0060	0,0065	0,0085
S13	XNHQ140708TN4-M11 F40M	XNHQ170708TN4-M13 F40M	0,13	0,15	0,20
			0,0050	0,0060	0,0080
H5	XNHQ140708TN4-M11 MP2501	XNHQ170708TN4-M13 MP2501	0,13	0,14	0,19
			0,0050	0,0055	0,0075
H8	XNHQ140708TN4-M11 MP2501	XNHQ170708TN4-M13 MP2501	0,095	0,11	0,15
			0,0038	0,0044	0,0060
H11	XNHQ140708TN4-M11 F40M	XNHQ170708TN4-M13 F40M	0,13	0,14	0,19
			0,0050	0,0055	0,0075
H12	XNHQ140708TN4-M11 F40M	XNHQ170708TN4-M13 F40M	0,095	0,11	0,15
			0,0038	0,0044	0,0060
H21	XNHQ140708TN4-M11 MP2501	XNHQ170708TN4-M13 MP2501	0,095	0,11	0,15
			0,0038	0,0044	0,0060

SMG = Seco material group
f_z = mm/tooth (in/tooth), v_c = m/min (sf/min), a_p/DC = %
All cutting data are start values

Square shoulder and slot milling cutters
Helical milling cutters
Face milling cutters
Disc milling cutters
High feed milling cutters
Copy milling cutters
Plunge milling cutters
Chamfer milling cutters
Spot facing cutters
Inserts

335.25-XN14/XN17 – Cutting data $v_c = (m/min)/(sf/min)$

SMG	MP2501			F40M			MK2050			H25		
	30%	20%	10%	30%	20%	10%	30%	20%	10%	30%	20%	10%
P1	225	245	270	170	185	205	225	240	265	—	—	—
	740	800	890	560	610	670	740	790	870	—	—	—
P2	220	235	260	165	175	195	215	230	255	—	—	—
	720	770	850	540	570	640	710	750	840	—	—	—
P3	195	205	225	145	155	170	190	205	225	—	—	—
	640	670	740	475	510	560	620	670	740	—	—	—
P4	170	180	205	130	135	155	165	180	200	—	—	—
	560	590	670	425	445	510	540	590	660	—	—	—
P5	165	175	195	125	130	145	160	170	190	—	—	—
	540	570	640	410	425	475	520	560	620	—	—	—
P6	185	200	220	140	150	165	180	195	215	—	—	—
	610	660	720	460	490	540	590	640	710	—	—	—
P7	175	190	205	130	145	155	170	185	205	—	—	—
	570	620	670	425	475	510	560	610	670	—	—	—
P8	160	175	190	125	130	145	160	170	190	—	—	—
	520	570	620	410	425	475	520	560	620	—	—	—
P11	170	185	200	130	140	150	165	180	195	—	—	—
	560	610	660	425	460	490	540	590	640	—	—	—
P12	110	120	130	85	90	100	110	120	130	—	—	—
	360	395	425	280	295	330	360	395	425	—	—	—
M1	160	170	185	135	140	160	—	—	—	—	—	—
	520	560	610	445	460	520	—	—	—	—	—	—
M2	130	140	155	110	120	135	—	—	—	—	—	—
	425	460	510	360	395	445	—	—	—	—	—	—
M3	105	115	130	90	95	110	—	—	—	—	—	—
	345	375	425	295	310	360	—	—	—	—	—	—
M4	85	90	100	70	75	85	—	—	—	—	—	—
	280	295	330	230	245	280	—	—	—	—	—	—
M5	70	75	80	60	65	70	—	—	—	—	—	—
	230	245	260	195	215	230	—	—	—	—	—	—
K1	175	185	205	130	140	155	235	250	275	—	—	—
	570	610	670	425	460	510	770	820	900	—	—	—
K2	155	165	185	120	125	140	210	220	250	—	—	—
	510	540	610	395	410	460	690	720	820	—	—	—
K3	130	140	155	100	105	120	175	185	210	—	—	—
	425	460	510	330	345	395	570	610	690	—	—	—
K4	125	135	150	95	100	115	170	180	200	—	—	—
	410	445	490	310	330	375	560	590	660	—	—	—
K5	75	80	90	60	60	70	100	110	125	—	—	—
	245	260	295	195	195	230	330	360	410	—	—	—
K6	110	115	130	85	90	100	150	155	175	—	—	—
	360	375	425	280	295	330	490	510	570	—	—	—
K7	100	105	115	75	80	90	130	140	160	—	—	—
	330	345	375	245	260	295	425	460	520	—	—	—
N1	—	—	—	960	1025	1150	—	—	—	970	1050	1175
	—	—	—	3150	3375	3775	—	—	—	3175	3450	3850
N2	—	—	—	390	415	460	—	—	—	395	420	470
	—	—	—	1275	1350	1500	—	—	—	1300	1375	1550
N3	—	—	—	260	280	310	—	—	—	260	280	315
	—	—	—	850	920	1025	—	—	—	850	920	1025
N11	—	—	—	295	315	350	—	—	—	300	320	360
	—	—	—	970	1025	1150	—	—	—	980	1050	1175
S1	40	43	48	33	35	39	—	—	—	—	—	—
	130	140	155	110	115	130	—	—	—	—	—	—
S2	33	35	39	26	28	31	—	—	—	—	—	—
	110	115	130	85	90	100	—	—	—	—	—	—
S3	29	31	34	23	25	28	—	—	—	—	—	—
	95	100	110	75	80	90	—	—	—	—	—	—
S11	55	60	65	46	49	55	—	—	—	—	—	—
	180	195	215	150	160	180	—	—	—	—	—	—
S12	47	50	55	38	41	46	—	—	—	—	—	—
	155	165	180	125	135	150	—	—	—	—	—	—
S13	28	29	33	22	24	27	—	—	—	—	—	—
	90	95	110	70	80	90	—	—	—	—	—	—
H5	33	36	40	28	30	33	—	—	—	—	—	—
	110	120	130	90	100	110	—	—	—	—	—	—
H8	36	38	42	30	32	35	—	—	—	—	—	—
	120	125	140	100	105	115	—	—	—	—	—	—
H11	42	46	50	35	38	42	—	—	—	—	—	—
	140	150	165	115	125	140	—	—	—	—	—	—
H12	42	45	49	35	37	41	—	—	—	—	—	—
	140	150	160	115	120	135	—	—	—	—	—	—
H21	36	38	42	30	32	35	—	—	—	—	—	—
	120	125	140	100	105	115	—	—	—	—	—	—

335.25-LN14/LN17 – Insert selection – mm/Inch

SMG			f _z		
			30%	20%	10%
P1	LNHQ140708TN4-M11 F40M	LNHQ170708TN4-M13 F40M	0,20	0,22	0,30
			0,0080	0,0085	0,012
P2	LNHQ140708TN4-M11 F40M	LNHQ170708TN4-M13 F40M	0,20	0,24	0,32
			0,0080	0,0095	0,013
P3	LNHQ140708TN4-M11 F40M	LNHQ170708TN4-M13 F40M	0,19	0,22	0,30
			0,0075	0,0085	0,012
P4	LNHQ140708TN4-M11 F40M	LNHQ170708TN4-M13 F40M	0,19	0,22	0,28
			0,0075	0,0085	0,011
P5	LNHQ140708TN4-M11 F40M	LNHQ170708TN4-M13 F40M	0,18	0,22	0,28
			0,0070	0,0085	0,011
P6	LNHQ140708TN4-M11 F40M	LNHQ170708TN4-M13 F40M	0,18	0,20	0,28
			0,0070	0,0080	0,011
P7	LNHQ140708TN4-M11 F40M	LNHQ170708TN4-M13 F40M	0,18	0,20	0,28
			0,0070	0,0080	0,011
P8	LNHQ140708TN4-M11 MP2501	LNHQ170708TN4-M13 F40M	0,19	0,22	0,30
			0,0075	0,0085	0,012
P11	LNHQ140708TN4-M11 F40M	LNHQ170708TN4-M13 F40M	0,18	0,20	0,28
			0,0070	0,0080	0,011
P12	LNHQ140708TN4-M11 F40M	LNHQ170708TN4-M13 F40M	0,13	0,14	0,19
			0,0050	0,0055	0,0075
M1	LNHQ140708TN4-M11 F40M	LNHQ170708TN4-M13 F40M	0,20	0,24	0,32
			0,0080	0,0095	0,013
M2	LNHQ140708TN4-M11 F40M	LNHQ170708TN4-M13 F40M	0,18	0,22	0,28
			0,0070	0,0085	0,011
M3	LNHQ140708TN4-M11 F40M	LNHQ170708TN4-M13 F40M	0,15	0,17	0,22
			0,0060	0,0065	0,0085
M4	LNHQ140708TN4-M11 F40M	LNHQ170708TN4-M13 F40M	0,13	0,15	0,20
			0,0050	0,0060	0,0080
M5	LNHQ140708TN4-M11 F40M	LNHQ170708TN4-M13 F40M	0,13	0,15	0,20
			0,0050	0,0060	0,0080
K1	LNHQ140708TN4-M11 MP2501	LNHQ170708TN4-M13 F40M	0,20	0,24	0,32
			0,0080	0,0095	0,013
K2	LNHQ140708TN4-M11 MP2501	LNHQ170708TN4-M13 F40M	0,18	0,22	0,28
			0,0070	0,0085	0,011
K3	LNHQ140708TN4-M11 MP2501	LNHQ170708TN4-M13 F40M	0,18	0,22	0,28
			0,0070	0,0085	0,011
K4	LNHQ140708TN4-M11 MP2501	LNHQ170708TN4-M13 F40M	0,18	0,22	0,28
			0,0070	0,0085	0,011
K5	LNHQ140708TN4-M11 MP2501	LNHQ170708TN4-M13 F40M	0,17	0,19	0,25
			0,0065	0,0075	0,010
K6	LNHQ140708TN4-M11 MP2501	LNHQ170708TN4-M13 F40M	0,18	0,22	0,28
			0,0070	0,0085	0,011
K7	LNHQ140708TN4-M11 MP2501	LNHQ170708TN4-M13 F40M	0,17	0,19	0,25
			0,0065	0,0075	0,010
S1	LNHQ140708TN4-M11 F40M	LNHQ170708TN4-M13 F40M	0,13	0,15	0,20
			0,0050	0,0060	0,0080
S2	LNHQ140708TN4-M11 F40M	LNHQ170708TN4-M13 F40M	0,13	0,15	0,20
			0,0050	0,0060	0,0080
S3	LNHQ140708TN4-M11 F40M	LNHQ170708TN4-M13 F40M	0,12	0,14	0,18
			0,0048	0,0055	0,0070
S11	LNHQ140708TN4-M11 F40M	LNHQ170708TN4-M13 F40M	0,15	0,17	0,22
			0,0060	0,0065	0,0085
S12	LNHQ140708TN4-M11 F40M	LNHQ170708TN4-M13 F40M	0,15	0,17	0,22
			0,0060	0,0065	0,0085
S13	LNHQ140708TN4-M11 F40M	LNHQ170708TN4-M13 F40M	0,13	0,15	0,20
			0,0050	0,0060	0,0080
H5	LNHQ140708TN4-M11 MP2501	LNHQ170708TN4-M13 F40M	0,13	0,14	0,19
			0,0050	0,0055	0,0075
H8	LNHQ140708TN4-M11 MP2501	LNHQ170708TN4-M13 F40M	0,095	0,11	0,15
			0,0038	0,0044	0,0060
H11	LNHQ140708TN4-M11 F40M	LNHQ170708TN4-M13 F40M	0,13	0,14	0,19
			0,0050	0,0055	0,0075
H12	LNHQ140708TN4-M11 F40M	LNHQ170708TN4-M13 F40M	0,095	0,11	0,15
			0,0038	0,0044	0,0060
H21	LNHQ140708TN4-M11 MP2501	LNHQ170708TN4-M13 F40M	0,095	0,11	0,15
			0,0038	0,0044	0,0060

SMG = Seco material group
f_z = mm/tooth (in/tooth), v_c = m/min (sf/min), a_p/DC = %
All cutting data are start values

Square shoulder and slot milling cutters
Helical milling cutters
Face milling cutters
Disc milling cutters
High feed milling cutters
Copy milling cutters
Plunge milling cutters
Chamfer milling cutters
Spot facing cutters
Inserts

335.25-LN14/LN17 – Cutting data $v_c = (m/min)/(sf/min)$

	SMG	MP2501			F40M		
		30%	20%	10%	30%	20%	10%
Square shoulder and slot milling cutters	P1	225	245	270	170	185	205
		740	800	890	560	610	670
Helical milling cutters	P2	220	235	260	165	175	195
		720	770	850	540	570	640
Face milling cutters	P3	195	205	225	145	155	170
		640	670	740	475	510	560
Face milling cutters	P4	170	180	205	130	135	155
		560	590	670	425	445	510
Face milling cutters	P5	165	175	195	125	130	145
		540	570	640	410	425	475
Face milling cutters	P6	185	200	220	140	150	165
		610	660	720	460	490	540
Face milling cutters	P7	175	190	205	130	145	155
		570	620	670	425	475	510
Face milling cutters	P8	160	175	190	125	130	145
		520	570	620	410	425	475
Face milling cutters	P11	170	185	200	130	140	150
		560	610	660	425	460	490
Face milling cutters	P12	110	120	130	85	90	100
		360	395	425	280	295	330
Disc milling cutters	M1	160	170	185	135	140	160
		520	560	610	445	460	520
Disc milling cutters	M2	130	140	155	110	120	135
		425	460	510	360	395	445
Disc milling cutters	M3	105	115	130	90	95	110
		345	375	425	295	310	360
Disc milling cutters	M4	85	90	100	70	75	85
		280	295	330	230	245	280
Disc milling cutters	M5	70	75	80	60	65	70
		230	245	260	195	215	230
High feed milling cutters	K1	175	185	205	130	140	155
		570	610	670	425	460	510
High feed milling cutters	K2	155	165	185	120	125	140
		510	540	610	395	410	460
High feed milling cutters	K3	130	140	155	100	105	120
		425	460	510	330	345	395
High feed milling cutters	K4	125	135	150	95	100	115
		410	445	490	310	330	375
High feed milling cutters	K5	75	80	90	60	60	70
		245	260	295	195	195	230
High feed milling cutters	K6	110	115	130	85	90	100
		360	375	425	280	295	330
High feed milling cutters	K7	100	105	115	75	80	90
		330	345	375	245	260	295
Plunge milling cutters	N1	—	—	—	960	1025	1150
		—	—	—	3150	3375	3775
Plunge milling cutters	N2	—	—	—	390	415	460
		—	—	—	1275	1350	1500
Plunge milling cutters	N3	—	—	—	260	280	310
		—	—	—	850	920	1025
Plunge milling cutters	N11	—	—	—	295	315	350
		—	—	—	970	1025	1150
Chamfer milling cutters	S1	40	43	48	33	35	39
		130	140	155	110	115	130
Chamfer milling cutters	S2	33	35	39	26	28	31
		110	115	130	85	90	100
Chamfer milling cutters	S3	29	31	34	23	25	28
		95	100	110	75	80	90
Chamfer milling cutters	S11	55	60	65	46	49	55
		180	195	215	150	160	180
Chamfer milling cutters	S12	47	50	55	38	41	46
		155	165	180	125	135	150
Chamfer milling cutters	S13	28	29	33	22	24	27
		90	95	110	70	80	90
Spot facing cutters	H5	33	36	40	28	30	33
		110	120	130	90	100	110
Spot facing cutters	H8	36	38	42	30	32	35
		120	125	140	100	105	115
Inserts	H11	42	46	50	35	38	42
		140	150	165	115	125	140
Inserts	H12	42	45	49	35	37	41
		140	150	160	115	120	135
Inserts	H21	36	38	42	30	32	35
		120	125	140	100	105	115

335.29 Round 5 – Insert selection – mm/Inch

SMG		f _z		
		25%	10%	5%
P1	RDHW0501M0-MD01 F40M	0,055	0,080	0,11
		0.0022	0.0032	0.0044
P2	RDHW0501M0-MD01 F40M	0,055	0,080	0,11
		0.0022	0.0032	0.0044
P3	RDHW0501M0-MD01 F40M	0,050	0,075	0,10
		0.0020	0.0030	0.0040
P4	RDHW0501M0-MD01 F40M	0,050	0,075	0,10
		0.0020	0.0030	0.0040
P5	RDHW0501M0-MD01 F40M	0,050	0,075	0,10
		0.0020	0.0030	0.0040
P6	RDHW0501M0-MD01 F40M	0,050	0,070	0,10
		0.0020	0.0028	0.0040
P7	RDHW0501M0-MD01 F40M	0,050	0,070	0,10
		0.0020	0.0028	0.0040
P8	RDHW0501M0-MD01 MP3000	0,050	0,075	0,10
		0.0020	0.0030	0.0040
P11	RDHW0501M0-MD01 F40M	0,050	0,070	0,10
		0.0020	0.0028	0.0040
P12	RDHW0501M0-MD01 F40M	0,034	0,050	0,070
		0.0013	0.0020	0.0028
M1	RDHW0501M0-MD01 F40M	0,055	0,080	0,11
		0.0022	0.0032	0.0044
M2	RDHW0501M0-MD01 F40M	0,050	0,075	0,10
		0.0020	0.0030	0.0040
M3	RDHW0501M0-MD01 F40M	0,040	0,060	0,080
		0.0016	0.0024	0.0032
M4	RDHW0501M0-MD01 F40M	0,036	0,050	0,070
		0.0014	0.0020	0.0028
M5	RDHW0501M0-MD01 F40M	0,036	0,050	0,070
		0.0014	0.0020	0.0028
K1	RDHW0501M0-MD01 MP3000	0,055	0,080	0,11
		0.0022	0.0032	0.0044
K2	RDHW0501M0-MD01 MP3000	0,050	0,075	0,10
		0.0020	0.0030	0.0040
K3	RDHW0501M0-MD01 MP3000	0,050	0,075	0,10
		0.0020	0.0030	0.0040
K4	RDHW0501M0-MD01 MP3000	0,050	0,075	0,10
		0.0020	0.0030	0.0040
K5	RDHW0501M0-MD01 MP3000	0,046	0,065	0,090
		0.0018	0.0026	0.0036
K6	RDHW0501M0-MD01 MP3000	0,050	0,075	0,10
		0.0020	0.0030	0.0040
K7	RDHW0501M0-MD01 MP3000	0,046	0,065	0,090
		0.0018	0.0026	0.0036
N1	RDHW0501M0-MD01 MP3000	0,070	0,10	0,14
		0.0028	0.0040	0.0055
N2	RDHW0501M0-MD01 MP3000	0,070	0,10	0,14
		0.0028	0.0040	0.0055
N3	RDHW0501M0-MD01 MP3000	0,070	0,10	0,14
		0.0028	0.0040	0.0055
N11	RDHW0501M0-MD01 MP3000	0,070	0,10	0,14
		0.0028	0.0040	0.0055
S1	RDHW0501M0-MD01 F40M	0,036	0,050	0,070
		0.0014	0.0020	0.0028
S2	RDHW0501M0-MD01 F40M	0,032	0,048	0,065
		0.0013	0.0019	0.0026
S3	RDHW0501M0-MD01 F40M	0,040	0,060	0,080
		0.0016	0.0024	0.0032
S11	RDHW0501M0-MD01 F40M	0,040	0,060	0,080
		0.0016	0.0024	0.0032
S12	RDHW0501M0-MD01 F40M	0,036	0,050	0,070
		0.0014	0.0020	0.0028
S13	RDHW0501M0-MD01 F40M	0,034	0,050	0,070
		0.0013	0.0020	0.0028
H5	RDHW0501M0-MD01 MP3000	0,026	0,038	0,050
		0.0010	0.0015	0.0020
H8	RDHW0501M0-MD01 MP3000	0,034	0,050	0,070
		0.0013	0.0020	0.0028
H11	RDHW0501M0-MD01 MP3000	0,026	0,038	0,050
		0.0010	0.0015	0.0020
H12	RDHW0501M0-MD01 MP3000	0,026	0,038	0,050
		0.0010	0.0015	0.0020
H21	RDHW0501M0-MD01 MP3000	0,026	0,038	0,050
		0.0010	0.0015	0.0020

SMG = Seco material group
f_z = mm/tooth (in/tooth), v_c = m/min (sf/min), a_p/DC = %
All cutting data are start values

Square shoulder and slot milling cutters
Helical milling cutters
Face milling cutters
Disc milling cutters
High feed milling cutters
Copy milling cutters
Plunge milling cutters
Chamfer milling cutters
Spot facing cutters
Inserts

335.29 Round 5 – Cutting data $v_c = (m/min)/(sf/min)$

SMG	MP3000			F40M		
	25%	10%	5%	25%	10%	5%
P1	325	365	400	260	295	320
	1075	1200	1300	850	970	1050
P2	315	360	390	250	285	310
	1025	1175	1275	820	940	1025
P3	275	310	340	220	250	270
	900	1025	1125	720	820	890
P4	240	275	300	195	220	240
	790	900	980	640	720	790
P5	230	260	285	185	210	225
	750	850	940	610	690	740
P6	260	295	320	205	235	255
	850	970	1050	670	770	840
P7	245	280	300	195	225	240
	800	920	980	640	740	790
P8	230	260	285	185	210	225
	750	850	940	610	690	740
P11	235	270	295	190	215	235
	770	890	970	620	710	770
P12	145	165	180	120	135	145
	475	540	590	395	445	475
M1	235	270	290	200	230	250
	770	890	950	660	750	820
M2	195	220	240	165	190	205
	640	720	790	540	620	670
M3	150	170	185	130	150	160
	490	560	610	425	490	520
M4	115	130	140	100	115	120
	375	425	460	330	375	395
M5	95	110	120	80	95	100
	310	360	395	260	310	330
K1	210	240	260	200	225	245
	690	790	850	660	740	800
K2	185	210	225	175	200	215
	610	690	740	570	660	710
K3	155	175	190	150	170	185
	510	570	620	490	560	610
K4	150	170	185	140	160	175
	490	560	610	460	520	570
K5	90	100	110	85	95	105
	295	330	360	280	310	345
K6	130	150	160	125	140	155
	425	490	520	410	460	510
K7	115	130	140	110	125	135
	375	425	460	360	410	445
N1	1900	2175	2350	1525	1725	1875
	6225	7125	7700	5000	5650	6150
N2	760	870	950	610	700	760
	2500	2850	3125	2000	2300	2500
N3	510	580	630	410	465	500
	1675	1900	2075	1350	1525	1650
N11	580	670	720	465	530	580
	1900	2200	2350	1525	1750	1900
S1	55	60	65	46	55	55
	180	195	215	150	180	180
S2	43	49	55	37	42	46
	140	160	180	120	140	150
S3	38	43	46	32	37	40
	125	140	150	105	120	130
S11	75	85	95	65	75	80
	245	280	310	215	245	260
S12	65	75	80	55	65	70
	215	245	260	180	215	230
S13	37	42	45	32	36	39
	120	140	150	105	120	130
H5	41	47	50	39	44	48
	135	155	165	130	145	155
H8	42	48	50	40	45	49
	140	155	165	130	150	160
H11	50	60	65	50	55	60
	165	195	215	165	180	195
H12	49	55	60	47	55	55
	160	180	195	155	180	180
H21	42	48	50	40	45	49
	140	155	165	130	150	160

335.29 Round 6 – Insert selection – mm/Inch

SMG		f _z		
		20%	10%	5%
P1	RDHW06T1M0-MD02 F40M	0,060 0.0024	0,080 0.0032	0,11 0.0044
P2	RDHW06T1M0-MD02 F40M	0,060 0.0024	0,080 0.0032	0,11 0.0044
P3	RDHW06T1M0-MD02 F40M	0,055 0.0022	0,075 0.0030	0,10 0.0040
P4	RDHW06T1M0-MD02 F40M	0,055 0.0022	0,075 0.0030	0,10 0.0040
P5	RDHW06T1M0-MD02 F40M	0,055 0.0022	0,075 0.0030	0,10 0.0040
P6	RDHW06T1M0-MD02 F40M	0,055 0.0022	0,070 0.0028	0,10 0.0040
P7	RDHW06T1M0-MD02 F40M	0,055 0.0022	0,070 0.0028	0,10 0.0040
P8	RDHW06T1M0-MD02 MP3000	0,055 0.0022	0,075 0.0030	0,10 0.0040
P11	RDHW06T1M0-MD02 F40M	0,055 0.0022	0,070 0.0028	0,10 0.0040
P12	RDHW06T1M0-MD02 F40M	0,038 0.0015	0,050 0.0020	0,070 0.0028
M1	RDHW06T1M0-MD02 F40M	0,060 0.0024	0,080 0.0032	0,11 0.0044
M2	RDHW06T1M0-MD02 F40M	0,055 0.0022	0,075 0.0030	0,10 0.0040
M3	RDHW06T1M0-MD02 F40M	0,044 0.0017	0,060 0.0024	0,080 0.0032
M4	RDHW06T1M0-MD02 F40M	0,038 0.0015	0,050 0.0020	0,070 0.0028
M5	RDHW06T1M0-MD02 F40M	0,038 0.0015	0,050 0.0020	0,070 0.0028
K1	RDHW06T1M0-MD02 MK2050	0,060 0.0024	0,080 0.0032	0,11 0.0044
K2	RDHW06T1M0-MD02 MK2050	0,055 0.0022	0,075 0.0030	0,10 0.0040
K3	RDHW06T1M0-MD02 MK2050	0,055 0.0022	0,075 0.0030	0,10 0.0040
K4	RDHW06T1M0-MD02 MK2050	0,055 0.0022	0,075 0.0030	0,10 0.0040
K5	RDHW06T1M0-MD02 MK2050	0,050 0.0020	0,065 0.0026	0,090 0.0036
K6	RDHW06T1M0-MD02 MK2050	0,055 0.0022	0,075 0.0030	0,10 0.0040
K7	RDHW06T1M0-MD02 MK2050	0,050 0.0020	0,065 0.0026	0,090 0.0036
N1	RDHT06T1M0-E02 H25	0,050 0.0020	0,070 0.0028	0,095 0.0038
N2	RDHT06T1M0-E02 H25	0,050 0.0020	0,070 0.0028	0,095 0.0038
N3	RDHT06T1M0-E02 H25	0,050 0.0020	0,070 0.0028	0,095 0.0038
N11	RDHT06T1M0-E02 H25	0,050 0.0020	0,070 0.0028	0,095 0.0038
S1	RDHW06T1M0-MD02 F40M	0,038 0.0015	0,050 0.0020	0,070 0.0028
S2	RDHW06T1M0-MD02 F40M	0,038 0.0015	0,050 0.0020	0,070 0.0028
S3	RDHW06T1M0-MD02 F40M	0,036 0.0014	0,048 0.0019	0,065 0.0026
S11	RDHW06T1M0-MD02 F40M	0,044 0.0017	0,060 0.0024	0,080 0.0032
S12	RDHW06T1M0-MD02 F40M	0,044 0.0017	0,060 0.0024	0,080 0.0032
S13	RDHW06T1M0-MD02 F40M	0,038 0.0015	0,050 0.0020	0,070 0.0028
H5	RDHW06T1M0-MD02 F15M	0,038 0.0015	0,050 0.0020	0,070 0.0028
H8	RDHW06T1M0-MD02 F15M	0,028 0.0011	0,038 0.0015	0,050 0.0020
H11	RDHW06T1M0-MD02 F15M	0,038 0.0015	0,050 0.0020	0,070 0.0028
H12	RDHW06T1M0-MD02 F15M	0,028 0.0011	0,038 0.0015	0,050 0.0020
H21	RDHW06T1M0-MD02 F15M	0,028 0.0011	0,038 0.0015	0,050 0.0020

SMG = Seco material group
f_z = mm/tooth (in/tooth), v_c = m/min (sf/min), a_p/DC = %
All cutting data are start values

Square shoulder and slot milling cutters
Helical milling cutters
Face milling cutters
Disc milling cutters
High feed milling cutters
Copy milling cutters
Plunge milling cutters
Chamfer milling cutters
Spot facing cutters
Inserts

335.29 Round 6 – Cutting data $v_c = (m/min)/(sf/min)$

SMG	MP3000			F15M			F30M			F40M			MK2050			H25		
	20%	10%	5%	20%	10%	5%	20%	10%	5%	20%	10%	5%	20%	10%	5%	20%	10%	5%
P1	320	350	380	—	—	—	270	295	320	255	280	305	330	365	395	—	—	—
	1050	1150	1250	—	—	—	890	970	1050	840	920	1000	1075	1200	1300	—	—	—
P2	310	345	370	—	—	—	260	290	310	250	275	295	325	355	385	—	—	—
	1025	1125	1225	—	—	—	850	950	1025	820	900	970	1075	1175	1275	—	—	—
P3	270	300	325	—	—	—	230	250	270	215	240	260	280	310	335	—	—	—
	890	980	1075	—	—	—	750	820	890	710	790	850	920	1025	1100	—	—	—
P4	240	260	285	—	—	—	200	220	240	190	210	230	250	275	295	—	—	—
	790	850	940	—	—	—	660	720	790	620	690	750	820	900	970	—	—	—
P5	230	250	275	—	—	—	190	210	230	180	200	220	235	260	285	—	—	—
	750	820	900	—	—	—	620	690	750	590	660	720	770	850	940	—	—	—
P6	255	285	305	—	—	—	215	240	255	205	225	245	265	295	320	—	—	—
	840	940	1000	—	—	—	710	790	840	670	740	800	870	970	1050	—	—	—
P7	240	270	290	—	—	—	205	225	245	195	215	230	250	280	300	—	—	—
	790	890	950	—	—	—	670	740	800	640	710	750	820	920	980	—	—	—
P8	230	250	275	—	—	—	190	210	230	180	200	220	235	260	285	—	—	—
	750	820	900	—	—	—	620	690	750	590	660	720	770	850	940	—	—	—
P11	235	260	280	—	—	—	195	220	235	190	210	225	245	270	290	—	—	—
	770	850	920	—	—	—	640	720	770	620	690	740	800	890	950	—	—	—
M1	235	255	280	—	—	—	210	230	250	200	220	240	—	—	—	—	—	—
	770	840	920	—	—	—	690	750	820	660	720	790	—	—	—	—	—	—
M2	190	210	230	—	—	—	170	190	205	165	180	195	—	—	—	—	—	—
	620	690	750	—	—	—	560	620	670	540	590	640	—	—	—	—	—	—
M3	150	165	180	—	—	—	135	150	160	130	140	155	—	—	—	—	—	—
	490	540	590	—	—	—	445	490	520	425	460	510	—	—	—	—	—	—
M4	115	125	135	—	—	—	105	115	125	100	110	115	—	—	—	—	—	—
	375	410	445	—	—	—	345	375	410	330	360	375	—	—	—	—	—	—
M5	95	105	115	—	—	—	85	95	105	80	90	100	—	—	—	—	—	—
	310	345	375	—	—	—	280	310	345	260	295	330	—	—	—	—	—	—
K1	205	230	245	235	260	285	205	230	245	195	215	235	350	385	415	—	—	—
	670	750	800	770	850	940	670	750	800	640	710	770	1150	1275	1350	—	—	—
K2	180	200	215	210	230	250	180	200	215	175	190	205	305	335	365	—	—	—
	590	660	710	690	750	820	590	660	710	570	620	670	1000	1100	1200	—	—	—
K3	155	170	185	175	195	210	155	170	185	145	160	175	260	285	310	—	—	—
	510	560	610	570	640	690	510	560	610	475	520	570	850	940	1025	—	—	—
K4	145	160	175	170	185	200	145	160	175	140	155	165	250	270	295	—	—	—
	475	520	570	560	610	660	475	520	570	460	510	540	820	890	970	—	—	—
K5	90	100	105	100	110	120	90	100	105	85	95	100	150	165	180	—	—	—
	295	330	345	330	360	395	295	330	345	280	310	330	490	540	590	—	—	—
K6	130	140	155	150	160	175	130	140	155	125	135	145	220	240	260	—	—	—
	425	460	510	490	520	570	425	460	510	410	445	475	720	790	850	—	—	—
K7	115	125	135	130	145	155	115	125	135	110	120	130	190	210	230	—	—	—
	375	410	445	425	475	510	375	410	445	360	395	425	620	690	750	—	—	—
N1	1875	2075	2250	—	—	—	1575	1750	1875	1500	1650	1800	—	—	—	1725	1900	2050
	6150	6800	7375	—	—	—	5175	5750	6150	4925	5425	5900	—	—	—	5650	6225	6725
N2	760	840	910	—	—	—	640	700	760	610	670	730	—	—	—	700	770	830
	2500	2750	2975	—	—	—	2100	2300	2500	2000	2200	2400	—	—	—	2300	2525	2725
N3	510	560	600	—	—	—	425	470	510	405	445	485	—	—	—	465	510	560
	1675	1825	1975	—	—	—	1400	1550	1675	1325	1450	1600	—	—	—	1525	1675	1825
N11	580	640	690	—	—	—	485	540	580	465	510	550	—	—	—	530	580	630
	1900	2100	2275	—	—	—	1600	1775	1900	1525	1675	1800	—	—	—	1750	1900	2075
S1	55	60	65	—	—	—	48	55	55	46	50	55	—	—	—	—	—	—
	180	195	215	—	—	—	155	180	180	150	165	180	—	—	—	—	—	—
S2	43	47	50	—	—	—	39	43	46	37	41	44	—	—	—	—	—	—
	140	155	165	—	—	—	130	140	150	120	135	145	—	—	—	—	—	—
S3	37	41	44	—	—	—	34	37	40	32	35	38	—	—	—	—	—	—
	120	135	145	—	—	—	110	120	130	105	115	125	—	—	—	—	—	—
S11	75	85	90	—	—	—	70	75	80	65	70	80	—	—	—	—	—	—
	245	280	295	—	—	—	230	245	260	215	230	260	—	—	—	—	—	—
S12	65	70	75	—	—	—	48	55	55	55	60	65	—	—	—	—	—	—
	215	230	245	—	—	—	155	180	180	180	195	215	—	—	—	—	—	—
S13	36	40	43	—	—	—	27	30	33	31	35	37	—	—	—	—	—	—
	120	130	140	—	—	—	90	100	110	100	115	120	—	—	—	—	—	—
H5	40	45	48	46	50	55	40	45	48	39	43	46	—	—	—	—	—	—
	130	150	155	150	165	180	130	150	155	130	140	150	—	—	—	—	—	—
H8	42	46	50	48	50	55	42	46	50	40	44	47	—	—	—	—	—	—
	140	150	165	155	165	180	140	150	165	130	145	155	—	—	—	—	—	—
H11	50	55	60	60	65	70	50	55	60	49	55	60	—	—	—	—	—	—
	165	180	195	195	215	230	165	180	195	160	180	195	—	—	—	—	—	—
H12	49	55	60	55	60	65	49	55	60	46	50	55	—	—	—	—	—	—
	160	180	195	180	195	215	160	180	195	150	165	180	—	—	—	—	—	—
H21	42	46	50	48	50	55	42	46	50	40	44	47	—	—	—	—	—	—
	140	150	165	155	165	180	140	150	165	130	145	155	—	—	—	—	—	—

335.29 Round 7 – Insert selection – mm/Inch

SMG		f _z		
		20%	10%	5%
P1	RDHW0702M0-MD03 F40M	0,080 0.0032	0,10 0.0040	0,14 0.0055
P2	RDHW0702M0-MD03 F40M	0,080 0.0032	0,11 0.0044	0,15 0.0060
P3	RDHW0702M0-MD03 F40M	0,075 0.0030	0,10 0.0040	0,14 0.0055
P4	RDHW0702M0-MD03 F40M	0,075 0.0030	0,10 0.0040	0,14 0.0055
P5	RDHW0702M0-MD03 F40M	0,075 0.0030	0,095 0.0038	0,13 0.0050
P6	RDHW0702M0-MD03 F40M	0,070 0.0028	0,095 0.0038	0,13 0.0050
P7	RDHW0702M0-MD03 F40M	0,070 0.0028	0,095 0.0038	0,13 0.0050
P8	RDHW0702M0-MD03 MP3000	0,075 0.0030	0,10 0.0040	0,14 0.0055
P11	RDHW0702M0-MD03 F40M	0,070 0.0028	0,095 0.0038	0,13 0.0050
P12	RDHW0702M0-MD03 F40M	0,050 0.0020	0,065 0.0026	0,090 0.0036
M1	RDHW0702M0-MD03 F40M	0,080 0.0032	0,11 0.0044	0,15 0.0060
M2	RDHW0702M0-MD03 F40M	0,075 0.0030	0,095 0.0038	0,13 0.0050
M3	RDHW0702M0-MD03 F40M	0,060 0.0024	0,080 0.0032	0,11 0.0044
M4	RDHW0702M0-MD03 F40M	0,050 0.0020	0,070 0.0028	0,095 0.0038
M5	RDHW0702M0-MD03 F40M	0,050 0.0020	0,070 0.0028	0,095 0.0038
K1	RDHW0702M0-MD03 MP3000	0,080 0.0032	0,11 0.0044	0,15 0.0060
K2	RDHW0702M0-MD03 MP3000	0,075 0.0030	0,095 0.0038	0,13 0.0050
K3	RDHW0702M0-MD03 MP3000	0,075 0.0030	0,095 0.0038	0,13 0.0050
K4	RDHW0702M0-MD03 MP3000	0,075 0.0030	0,095 0.0038	0,13 0.0050
K5	RDHW0702M0-MD03 MP3000	0,065 0.0026	0,085 0.0034	0,12 0.0048
K6	RDHW0702M0-MD03 MP3000	0,075 0.0030	0,095 0.0038	0,13 0.0050
K7	RDHW0702M0-MD03 MP3000	0,065 0.0026	0,085 0.0034	0,12 0.0048
N1	RDHW0702M0-MD03 MP3000	0,10 0.0040	0,14 0.0055	0,19 0.0075
N2	RDHW0702M0-MD03 MP3000	0,10 0.0040	0,14 0.0055	0,19 0.0075
N3	RDHW0702M0-MD03 MP3000	0,10 0.0040	0,14 0.0055	0,19 0.0075
N11	RDHW0702M0-MD03 MP3000	0,10 0.0040	0,14 0.0055	0,19 0.0075
S1	RDHW0702M0-MD03 F40M	0,050 0.0020	0,070 0.0028	0,095 0.0038
S2	RDHW0702M0-MD03 F40M	0,050 0.0020	0,070 0.0028	0,095 0.0038
S3	RDHW0702M0-MD03 F40M	0,048 0.0019	0,065 0.0026	0,085 0.0034
S11	RDHW0702M0-MD03 F40M	0,060 0.0024	0,080 0.0032	0,11 0.0044
S12	RDHW0702M0-MD03 F40M	0,060 0.0024	0,080 0.0032	0,11 0.0044
S13	RDHW0702M0-MD03 F40M	0,050 0.0020	0,070 0.0028	0,095 0.0038
H5	RDHW0702M0T-MD04 F15M	0,050 0.0020	0,065 0.0026	0,090 0.0036
H8	RDHW0702M0T-MD04 F15M	0,038 0.0015	0,050 0.0020	0,070 0.0028
H11	RDHW0702M0T-MD04 F15M	0,050 0.0020	0,065 0.0026	0,090 0.0036
H12	RDHW0702M0T-MD04 F15M	0,038 0.0015	0,050 0.0020	0,070 0.0028
H21	RDHW0702M0T-MD04 F15M	0,038 0.0015	0,050 0.0020	0,070 0.0028

SMG = Seco material group
f_z = mm/tooth (in/tooth), v_c = m/min (sf/min), a_p/DC = %
All cutting data are start values

Square shoulder and slot milling cutters
Helical milling cutters
Face milling cutters
Disc milling cutters
High feed milling cutters
Copy milling cutters
Plunge milling cutters
Chamfer milling cutters
Spot facing cutters
Inserts

335.29 Round 7 – Cutting data $v_c = (m/min)/(sf/min)$

SMG	MP3000			F15M			F40M		
	20%	10%	5%	20%	10%	5%	20%	10%	5%
P1	305	340	370	—	—	—	245	270	295
	1000	1125	1225	—	—	—	800	890	970
P2	295	325	355	—	—	—	235	260	285
	970	1075	1175	—	—	—	770	850	940
P3	260	285	310	—	—	—	205	230	245
	850	940	1025	—	—	—	670	750	800
P4	225	250	270	—	—	—	180	200	215
	740	820	890	—	—	—	590	660	710
P5	215	240	260	—	—	—	175	195	210
	710	790	850	—	—	—	570	640	690
P6	245	270	295	—	—	—	195	215	235
	800	890	970	—	—	—	640	710	770
P7	235	255	280	—	—	—	185	205	220
	770	840	920	—	—	—	610	670	720
P8	215	240	260	—	—	—	175	190	205
	710	790	850	—	—	—	570	620	670
P11	225	250	270	—	—	—	180	200	215
	740	820	890	—	—	—	590	660	710
P12	140	155	170	—	—	—	110	125	135
	460	510	560	—	—	—	360	410	445
M1	220	245	265	—	—	—	190	210	230
	720	800	870	—	—	—	620	690	750
M2	180	200	220	—	—	—	155	175	190
	590	660	720	—	—	—	510	570	620
M3	145	160	170	—	—	—	125	135	150
	475	520	560	—	—	—	410	445	490
M4	110	120	130	—	—	—	95	105	115
	360	395	425	—	—	—	310	345	375
M5	90	100	110	—	—	—	80	85	95
	295	330	360	—	—	—	260	280	310
K1	200	215	235	225	250	270	190	205	225
	660	710	770	740	820	890	620	670	740
K2	175	195	210	200	220	240	165	185	200
	570	640	690	660	720	790	540	610	660
K3	145	165	175	165	185	200	140	155	170
	475	540	570	540	610	660	460	510	560
K4	140	155	170	160	180	195	135	150	160
	460	510	560	520	590	640	445	490	520
K5	85	95	100	95	110	115	80	90	95
	280	310	330	310	360	375	260	295	310
K6	125	135	150	140	155	170	115	130	140
	410	445	490	460	510	560	375	425	460
K7	110	120	130	125	140	150	105	115	125
	360	395	425	410	460	490	345	375	410
N1	1775	1950	2125	—	—	—	1425	1550	1700
	5825	6400	6975	—	—	—	4675	5075	5575
N2	720	790	860	—	—	—	580	630	690
	2350	2600	2825	—	—	—	1900	2075	2275
N3	480	530	570	—	—	—	385	420	460
	1575	1750	1875	—	—	—	1275	1375	1500
N11	550	600	650	—	—	—	440	480	520
	1800	1975	2125	—	—	—	1450	1575	1700
S1	50	55	60	—	—	—	44	49	55
	165	180	195	—	—	—	145	160	180
S2	41	45	49	—	—	—	36	39	42
	135	150	160	—	—	—	120	130	140
S3	36	39	43	—	—	—	31	34	37
	120	130	140	—	—	—	100	110	120
S11	70	80	85	—	—	—	60	70	75
	230	260	280	—	—	—	195	230	245
S12	60	65	75	—	—	—	50	60	65
	195	215	245	—	—	—	165	195	215
S13	35	38	42	—	—	—	30	33	36
	115	125	140	—	—	—	100	110	120
H5	39	43	47	45	49	55	37	41	45
	130	140	155	150	160	180	120	135	150
H8	40	45	48	46	50	55	39	43	46
	130	150	155	150	165	180	130	140	150
H11	50	55	60	55	65	70	47	50	55
	165	180	195	180	215	230	155	165	180
H12	47	50	55	55	60	65	45	49	55
	155	165	180	180	195	215	150	160	180
H21	40	45	48	46	50	55	39	43	46
	130	150	155	150	165	180	130	140	150

335.18/29 Round 8 – Insert selection – mm/Inch

SMG		f _z		
		30%	20%	10%
P1	RDHW0803M0-MD03 F40M	0,065	0,075	0,10
		0.0026	0.0030	0.0040
P2	RDHW0803M0-MD03 F40M	0,065	0,075	0,10
		0.0026	0.0030	0.0040
P3	RDHW0803M0-MD03 F40M	0,065	0,075	0,095
		0.0026	0.0030	0.0038
P4	RDKW0803M0T-MD05 F40M	0,080	0,090	0,12
		0.0032	0.0036	0.0048
P5	RDKW0803M0T-MD05 F40M	0,075	0,090	0,12
		0.0030	0.0036	0.0048
P6	RDKW0803M0T-MD05 F40M	0,075	0,085	0,12
		0.0030	0.0034	0.0048
P7	RDKW0803M0T-MD05 F40M	0,075	0,085	0,12
		0.0030	0.0034	0.0048
P8	RDKW0803M0T-MD05 MP2501	0,080	0,090	0,12
		0.0032	0.0036	0.0048
P11	RDKW0803M0T-MD05 F40M	0,075	0,085	0,12
		0.0030	0.0034	0.0048
P12	RDKW0803M0T-MD05 F40M	0,050	0,060	0,080
		0.0020	0.0024	0.0032
M1	RDHW0803M0-MD03 F40M	0,065	0,075	0,10
		0.0026	0.0030	0.0040
M2	RDHW0803M0-MD03 F40M	0,060	0,070	0,095
		0.0024	0.0028	0.0038
M3	RDHW0803M0-MD03 F40M	0,048	0,055	0,075
		0.0019	0.0022	0.0030
M4	RDHW0803M0-MD03 F40M	0,042	0,050	0,065
		0.0017	0.0020	0.0026
M5	RDHW0803M0-MD03 F40M	0,042	0,050	0,065
		0.0017	0.0020	0.0026
K1	RDKW0803M0T-MD05 MK2050	0,085	0,095	0,13
		0.0034	0.0038	0.0050
K2	RDKW0803M0T-MD05 MK2050	0,075	0,090	0,12
		0.0030	0.0036	0.0048
K3	RDKW0803M0T-MD05 MK2050	0,075	0,090	0,12
		0.0030	0.0036	0.0048
K4	RDKW0803M0T-MD05 MK2050	0,075	0,090	0,12
		0.0030	0.0036	0.0048
K5	RDKW0803M0T-MD05 MK2050	0,070	0,080	0,11
		0.0028	0.0032	0.0044
K6	RDKW0803M0T-MD05 MK2050	0,075	0,090	0,12
		0.0030	0.0036	0.0048
K7	RDKW0803M0T-MD05 MK2050	0,070	0,080	0,11
		0.0028	0.0032	0.0044
N1	RDHT0803M0-E03 H25	0,065	0,075	0,10
		0.0026	0.0030	0.0040
N2	RDHT0803M0-E03 H25	0,065	0,075	0,10
		0.0026	0.0030	0.0040
N3	RDHT0803M0-E03 H25	0,065	0,075	0,10
		0.0026	0.0030	0.0040
N11	RDHT0803M0-E03 H25	0,065	0,075	0,10
		0.0026	0.0030	0.0040
S1	RDHW0803M0-MD03 F40M	0,042	0,050	0,065
		0.0017	0.0020	0.0026
S2	RDHW0803M0-MD03 F40M	0,042	0,050	0,065
		0.0017	0.0020	0.0026
S3	RDHW0803M0-MD03 F40M	0,040	0,046	0,060
		0.0016	0.0018	0.0024
S11	RDHW0803M0-MD03 F40M	0,048	0,055	0,075
		0.0019	0.0022	0.0030
S12	RDHW0803M0-MD03 F40M	0,048	0,055	0,075
		0.0019	0.0022	0.0030
S13	RDHW0803M0-MD03 F40M	0,042	0,050	0,065
		0.0017	0.0020	0.0026
H5	RDKW0803M0T-MD05 F15M	0,050	0,060	0,080
		0.0020	0.0024	0.0032
H8	RDKW0803M0T-MD05 F15M	0,040	0,046	0,060
		0.0016	0.0018	0.0024
H11	RDKW0803M0T-MD05 F15M	0,050	0,060	0,080
		0.0020	0.0024	0.0032
H12	RDKW0803M0T-MD05 F15M	0,040	0,046	0,060
		0.0016	0.0018	0.0024
H21	RDKW0803M0T-MD05 F15M	0,040	0,046	0,060
		0.0016	0.0018	0.0024

SMG = Seco material group
f_z = mm/tooth (in/tooth), v_c = m/min (sf/min), a_p/DC = %
All cutting data are start values

Square shoulder and slot milling cutters
Helical milling cutters
Face milling cutters
Disc milling cutters
High feed milling cutters
Copy milling cutters
Plunge milling cutters
Chamfer milling cutters
Spot facing cutters
Inserts

335.18/29 Round 8 – Cutting data $v_c = (m/min)/(sf/min)$

SMG	MP2501			MP3000			T350M			F15M			F25M			F30M		
	30%	20%	10%	30%	20%	10%	30%	20%	10%	30%	20%	10%	30%	20%	10%	30%	20%	10%
P1	285	305	335	280	300	335	315	335	370	260	275	305	240	255	280	235	250	280
	940	1000	1100	920	980	1100	1025	1100	1225	850	900	1000	790	840	920	770	820	920
P2	280	295	330	275	290	320	305	325	360	255	270	300	230	245	275	230	245	270
	920	970	1075	900	950	1050	1000	1075	1175	840	890	980	750	800	900	750	800	890
P3	245	255	285	240	255	280	265	285	310	220	235	255	200	215	235	200	215	235
	800	840	940	790	840	920	870	940	1025	720	770	840	660	710	770	660	710	770
P4	215	225	255	210	225	245	235	250	275	195	205	230	180	190	210	175	190	205
	710	740	840	690	740	800	770	820	900	640	670	750	590	620	690	570	620	670
P5	205	220	240	200	215	240	225	240	260	185	200	220	170	180	200	170	180	200
	670	720	790	660	710	790	740	790	850	610	660	720	560	590	660	560	590	660
P6	230	245	270	225	245	265	250	265	295	210	225	245	190	205	225	190	205	225
	750	800	890	740	800	870	820	870	970	690	740	800	620	670	740	620	670	740
P7	215	230	255	215	230	250	235	250	280	195	210	230	180	195	215	180	190	210
	710	750	840	710	750	820	770	820	920	640	690	750	590	640	710	590	620	690
P8	205	215	240	200	215	235	220	240	260	185	195	215	170	180	200	170	180	200
	670	710	790	660	710	770	720	790	850	610	640	710	560	590	660	560	590	660
P11	210	225	250	205	225	245	230	245	270	190	205	225	175	185	205	175	185	205
	690	740	820	670	740	800	750	800	890	620	670	740	570	610	670	570	610	670
P12	130	140	155	130	140	155	145	150	165	—	—	—	110	120	130	110	115	130
	425	460	510	425	460	510	475	490	540	—	—	—	360	395	425	360	375	425
M1	200	215	235	205	220	240	235	250	275	—	—	—	—	—	—	185	200	215
	660	710	770	670	720	790	770	820	900	—	—	—	—	—	—	610	660	710
M2	165	175	195	170	180	200	190	205	225	—	—	—	—	—	—	150	160	180
	540	570	640	560	590	660	620	670	740	—	—	—	—	—	—	490	520	590
M3	130	140	155	135	140	155	150	160	175	—	—	—	—	—	—	120	130	140
	425	460	510	445	460	510	490	520	570	—	—	—	—	—	—	395	425	460
M4	100	105	120	100	110	120	115	125	135	—	—	—	—	—	—	90	100	110
	330	345	395	330	360	395	375	410	445	—	—	—	—	—	—	295	330	360
M5	85	90	100	85	90	100	95	100	115	—	—	—	—	—	—	75	80	90
	280	295	330	280	295	330	310	330	375	—	—	—	—	—	—	245	260	295
K1	220	235	260	180	195	215	—	—	—	200	215	235	185	195	215	180	195	215
	720	770	850	590	640	710	—	—	—	660	710	770	610	640	710	590	640	710
K2	195	205	230	160	170	190	—	—	—	175	190	210	160	175	190	160	170	190
	640	670	750	520	560	620	—	—	—	570	620	690	520	570	620	520	560	620
K3	165	175	195	135	145	160	—	—	—	150	160	175	135	145	160	135	145	160
	540	570	640	445	475	520	—	—	—	490	520	570	445	475	520	445	475	520
K4	155	170	185	130	140	155	—	—	—	140	150	170	130	140	155	130	140	155
	510	560	610	425	460	510	—	—	—	460	490	560	425	460	510	425	460	510
K5	95	100	110	80	85	95	—	—	—	85	95	100	80	85	95	80	85	95
	310	330	360	260	280	310	—	—	—	280	310	330	260	280	310	260	280	310
K6	140	150	165	115	120	135	—	—	—	125	135	150	115	125	135	115	120	135
	460	490	540	375	395	445	—	—	—	410	445	490	375	410	445	375	395	445
K7	120	130	145	100	105	120	—	—	—	110	120	130	100	110	120	100	105	120
	395	425	475	330	345	395	—	—	—	360	395	425	330	360	395	330	345	395
N1	—	—	—	1625	1750	1925	—	—	—	—	—	—	—	—	—	1375	1475	1625
	—	—	—	5325	5750	6325	—	—	—	—	—	—	—	—	—	4500	4850	5325
N2	—	—	—	660	710	780	—	—	—	—	—	—	—	—	—	560	600	650
	—	—	—	2175	2325	2550	—	—	—	—	—	—	—	—	—	1825	1975	2125
N3	—	—	—	440	475	520	—	—	—	—	—	—	—	—	—	370	395	435
	—	—	—	1450	1550	1700	—	—	—	—	—	—	—	—	—	1225	1300	1425
N11	—	—	—	500	540	590	—	—	—	—	—	—	—	—	—	425	455	495
	—	—	—	1650	1775	1925	—	—	—	—	—	—	—	—	—	1400	1500	1625
S1	—	—	—	48	50	55	55	55	65	—	—	—	—	—	—	43	46	50
	—	—	—	155	165	180	180	180	215	—	—	—	—	—	—	140	150	165
S2	—	—	—	38	41	45	43	46	50	—	—	—	—	—	—	35	37	40
	—	—	—	125	135	150	140	150	165	—	—	—	—	—	—	115	120	130
S3	—	—	—	33	35	39	38	40	44	—	—	—	—	—	—	30	32	35
	—	—	—	110	115	130	125	130	145	—	—	—	—	—	—	100	105	115
S11	—	—	—	65	70	80	75	80	90	—	—	—	—	—	—	60	65	70
	—	—	—	215	230	260	245	260	295	—	—	—	—	—	—	195	215	230
S12	—	—	—	55	60	65	65	70	75	—	—	—	—	—	—	43	45	50
	—	—	—	180	195	215	215	230	245	—	—	—	—	—	—	140	150	165
S13	—	—	—	32	35	38	37	39	43	—	—	—	—	—	—	25	26	29
	—	—	—	105	115	125	120	130	140	—	—	—	—	—	—	80	85	95
H5	—	—	—	36	39	43	48	50	55	40	43	47	—	—	—	36	39	43
	—	—	—	120	130	140	155	165	180	130	140	155	—	—	—	120	130	140
H8	—	—	—	38	40	44	49	50	55	42	44	49	—	—	—	38	40	44
	—	—	—	125	130	145	160	165	180	140	145	160	—	—	—	125	130	145
H11	—	—	—	46	49	55	60	65	70	50	55	60	—	—	—	46	49	55
	—	—	—	150	160	180	195	215	230	165	180	195	—	—	—	150	160	180
H12	—	—	—	44	46	50	55	60	65	48	50	55	—	—	—	44	46	50
	—	—	—	145	150	165	180	195	215	155	165	180	—	—	—	145	150	165
H21	—	—	—	38	40	44	49	50	55	42	44	49	—	—	—	38	40	44
	—	—	—	125	130	145	160	165	180	140	145	160	—	—	—	125	130	145

335.18/29 Round 8 – Cutting data $v_c = (m/min)/(sf/min)$

SMG	F40M			MK2050			MS2050			MS2500			H25		
	30%	20%	10%	30%	20%	10%	30%	20%	10%	30%	20%	10%	30%	20%	10%
P1	230	245	270	280	305	330	—	—	—	315	335	370	—	—	—
	750	800	890	920	1000	1075	—	—	—	1025	1100	1225	—	—	—
P2	220	235	260	275	295	325	—	—	—	305	325	360	—	—	—
	720	770	850	900	970	1075	—	—	—	1000	1075	1175	—	—	—
P3	190	205	225	240	255	285	—	—	—	265	285	315	—	—	—
	620	670	740	790	840	940	—	—	—	870	940	1025	—	—	—
P4	170	180	200	210	225	250	—	—	—	235	250	275	—	—	—
	560	590	660	690	740	820	—	—	—	770	820	900	—	—	—
P5	165	175	190	205	215	240	—	—	—	225	240	265	—	—	—
	540	570	620	670	710	790	—	—	—	740	790	870	—	—	—
P6	185	195	215	230	245	265	—	—	—	255	270	295	—	—	—
	610	640	710	750	800	870	—	—	—	840	890	970	—	—	—
P7	175	185	205	215	230	250	—	—	—	240	255	280	—	—	—
	570	610	670	710	750	820	—	—	—	790	840	920	—	—	—
P8	160	170	190	200	215	240	—	—	—	225	240	265	—	—	—
	520	560	620	660	710	790	—	—	—	740	790	870	—	—	—
P11	170	180	200	210	225	245	—	—	—	230	250	270	—	—	—
	560	590	660	690	740	800	—	—	—	750	820	890	—	—	—
P12	105	110	120	130	140	155	—	—	—	145	155	170	—	—	—
	345	360	395	425	460	510	—	—	—	475	510	560	—	—	—
M1	180	190	210	—	—	—	—	—	—	220	235	255	—	—	—
	590	620	690	—	—	—	—	—	—	720	770	840	—	—	—
M2	145	155	170	—	—	—	—	—	—	180	190	210	—	—	—
	475	510	560	—	—	—	—	—	—	590	620	690	—	—	—
M3	115	125	135	—	—	—	—	—	—	145	150	165	—	—	—
	375	410	445	—	—	—	—	—	—	475	490	540	—	—	—
M4	90	95	105	—	—	—	—	—	—	110	115	130	—	—	—
	295	310	345	—	—	—	—	—	—	360	375	425	—	—	—
M5	75	80	85	—	—	—	—	—	—	90	95	105	—	—	—
	245	260	280	—	—	—	—	—	—	295	310	345	—	—	—
K1	175	185	205	295	320	350	—	—	—	—	—	—	—	—	—
	570	610	670	970	1050	1150	—	—	—	—	—	—	—	—	—
K2	155	165	180	265	280	305	—	—	—	—	—	—	—	—	—
	510	540	590	870	920	1000	—	—	—	—	—	—	—	—	—
K3	130	140	155	225	235	260	—	—	—	—	—	—	—	—	—
	425	460	510	740	770	850	—	—	—	—	—	—	—	—	—
K4	125	135	145	215	225	250	—	—	—	—	—	—	—	—	—
	410	445	475	710	740	820	—	—	—	—	—	—	—	—	—
K5	75	80	90	130	135	150	—	—	—	—	—	—	—	—	—
	245	260	295	425	445	490	—	—	—	—	—	—	—	—	—
K6	110	115	130	185	200	220	—	—	—	—	—	—	—	—	—
	360	375	425	610	660	720	—	—	—	—	—	—	—	—	—
K7	95	100	115	165	175	190	—	—	—	—	—	—	—	—	—
	310	330	375	540	570	620	—	—	—	—	—	—	—	—	—
N1	1325	1400	1550	—	—	—	—	—	—	—	—	—	1525	1625	1800
	4350	4600	5075	—	—	—	—	—	—	—	—	—	5000	5325	5900
N2	530	570	630	—	—	—	—	—	—	—	—	—	620	660	720
	1750	1875	2075	—	—	—	—	—	—	—	—	—	2025	2175	2350
N3	355	380	420	—	—	—	—	—	—	—	—	—	410	435	480
	1175	1250	1375	—	—	—	—	—	—	—	—	—	1350	1425	1575
N11	410	435	480	—	—	—	—	—	—	—	—	—	470	500	550
	1350	1425	1575	—	—	—	—	—	—	—	—	—	1550	1650	1800
S1	41	44	48	—	—	—	45	48	55	55	55	65	—	—	—
	135	145	155	—	—	—	150	155	180	180	180	215	—	—	—
S2	33	35	39	—	—	—	37	39	43	43	46	50	—	—	—
	110	115	130	—	—	—	120	130	140	140	150	165	—	—	—
S3	29	31	34	—	—	—	32	34	37	37	40	44	—	—	—
	95	100	110	—	—	—	105	110	120	120	130	145	—	—	—
S11	60	60	70	—	—	—	65	70	75	75	80	90	—	—	—
	195	195	230	—	—	—	215	230	245	245	260	295	—	—	—
S12	49	50	60	—	—	—	55	60	65	65	70	75	—	—	—
	160	165	195	—	—	—	180	195	215	215	230	245	—	—	—
S13	28	30	33	—	—	—	31	33	36	36	39	43	—	—	—
	90	100	110	—	—	—	100	110	120	120	130	140	—	—	—
H5	35	37	41	—	—	—	—	—	—	—	—	—	—	—	—
	115	120	135	—	—	—	—	—	—	—	—	—	—	—	—
H8	36	38	42	—	—	—	—	—	—	—	—	—	—	—	—
	120	125	140	—	—	—	—	—	—	—	—	—	—	—	—
H11	44	47	50	—	—	—	—	—	—	—	—	—	—	—	—
	145	155	165	—	—	—	—	—	—	—	—	—	—	—	—
H12	42	44	49	—	—	—	—	—	—	—	—	—	—	—	—
	140	145	160	—	—	—	—	—	—	—	—	—	—	—	—
H21	36	38	42	—	—	—	—	—	—	—	—	—	—	—	—
	120	125	140	—	—	—	—	—	—	—	—	—	—	—	—

Square shoulder and slot milling cutters
Helical milling cutters
Face milling cutters
Disc milling cutters
High feed milling cutters
Copy milling cutters
Plunge milling cutters
Chamfer milling cutters
Spot facing cutters
Inserts

335.18/29 Round 10 – Insert selection – mm/Inch

SMG		f _z		
		30%	20%	10%
P1	RDKT10T3M0T-8-M05 F40M	0,085	0,095	0,13
		0.0034	0.0038	0.0050
P2	RDKT10T3M0T-8-M05 F40M	0,085	0,095	0,13
		0.0034	0.0038	0.0050
P3	RDKT10T3M0T-8-M05 F40M	0,080	0,090	0,12
		0.0032	0.0036	0.0048
P4	RDKT10T3M0T-8-M05 F40M	0,080	0,090	0,12
		0.0032	0.0036	0.0048
P5	RDKT10T3M0T-8-M05 F40M	0,075	0,090	0,12
		0.0030	0.0036	0.0048
P6	RDKT10T3M0T-8-M05 F40M	0,075	0,085	0,12
		0.0030	0.0034	0.0048
P7	RDKW10T3M0T-8-MD06 F40M	0,090	0,10	0,14
		0.0036	0.0040	0.0055
P8	RDKW10T3M0T-8-MD06 MP2501	0,095	0,11	0,15
		0.0038	0.0044	0.0060
P11	RDKT10T3M0T-8-M07 F40M	0,11	0,12	0,16
		0.0044	0.0048	0.0065
P12	RDKT10T3M0T-8-M07 F40M	0,075	0,085	0,11
		0.0030	0.0034	0.0044
M1	RDKT10T3M0T-8-M05 F40M	0,085	0,095	0,13
		0.0034	0.0038	0.0050
M2	RDKT10T3M0T-8-M05 F40M	0,075	0,090	0,12
		0.0030	0.0036	0.0048
M3	RDKT10T3M0T-8-M05 F40M	0,060	0,070	0,095
		0.0024	0.0028	0.0038
M4	RDKT10T3M0T-8-M05 F40M	0,055	0,060	0,080
		0.0022	0.0024	0.0032
M5	RDKT10T3M0T-8-M05 F40M	0,055	0,060	0,080
		0.0022	0.0024	0.0032
K1	RDKW10T3M0T-8-MD06 MK2050	0,10	0,12	0,16
		0.0040	0.0048	0.0065
K2	RDKW10T3M0T-8-MD06 MK2050	0,090	0,11	0,14
		0.0036	0.0044	0.0055
K3	RDKW10T3M0T-8-MD06 MK2050	0,090	0,11	0,14
		0.0036	0.0044	0.0055
K4	RDKW10T3M0T-8-MD06 MK2050	0,090	0,11	0,14
		0.0036	0.0044	0.0055
K5	RDKW10T3M0T-8-MD06 MK2050	0,085	0,095	0,13
		0.0034	0.0038	0.0050
K6	RDKW10T3M0T-8-MD06 MK2050	0,090	0,11	0,14
		0.0036	0.0044	0.0055
K7	RDKW10T3M0T-8-MD06 MK2050	0,085	0,095	0,13
		0.0034	0.0038	0.0050
N1	RDHT10T3M0-8-E04 H25	0,085	0,10	0,13
		0.0034	0.0040	0.0050
N2	RDHT10T3M0-8-E04 H25	0,085	0,10	0,13
		0.0034	0.0040	0.0050
N3	RDHT10T3M0-8-E04 H25	0,085	0,10	0,13
		0.0034	0.0040	0.0050
N11	RDHT10T3M0-8-E04 H25	0,085	0,10	0,13
		0.0034	0.0040	0.0050
S1	RDKT10T3M0T-8-M05 F40M	0,055	0,060	0,080
		0.0022	0.0024	0.0032
S2	RDKT10T3M0T-8-M05 F40M	0,050	0,055	0,075
		0.0020	0.0022	0.0030
S3	RDKT10T3M0T-8-M05 F40M	0,060	0,070	0,095
		0.0024	0.0028	0.0038
S11	RDKT10T3M0T-8-M05 F40M	0,060	0,070	0,095
		0.0024	0.0028	0.0038
S12	RDKT10T3M0T-8-M05 F40M	0,055	0,060	0,080
		0.0022	0.0024	0.0032
S13	RDKT10T3M0T-8-M05 F40M	0,065	0,070	0,095
		0.0026	0.0028	0.0038
H5	RDKW10T3M0T-8-MD06 F15M	0,048	0,055	0,075
		0.0019	0.0022	0.0030
H8	RDKW10T3M0T-8-MD06 F15M	0,065	0,070	0,095
		0.0026	0.0028	0.0038
H11	RDKW10T3M0T-8-MD06 F15M	0,048	0,055	0,075
		0.0019	0.0022	0.0030
H12	RDKW10T3M0T-8-MD06 F15M	0,065	0,070	0,095
		0.0026	0.0028	0.0038
H21	RDKW10T3M0T-8-MD06 F15M	0,048	0,055	0,075
		0.0019	0.0022	0.0030

SMG = Seco material group
f_z = mm/tooth (in/tooth), v_c = m/min (sf/min), a_p/DC = %
All cutting data are start values

335.18/29 Round 10 – Cutting data $v_c = (m/min)/(sf/min)$

SMG	MP1501			MP2501			T350M			F15M			F40M		
	30%	20%	10%	30%	20%	10%	30%	20%	10%	30%	20%	10%	30%	20%	10%
P1	315	335	370	290	310	345	280	300	330	255	270	295	245	260	290
	1025	1100	1225	950	1025	1125	920	980	1075	840	890	970	800	850	950
P2	305	325	360	285	300	330	275	290	325	245	260	290	240	255	280
	1000	1075	1175	940	980	1075	900	950	1075	800	850	950	790	840	920
P3	265	285	310	245	265	290	240	255	280	210	230	250	210	220	240
	870	940	1025	800	870	950	790	840	920	690	750	820	690	720	790
P4	235	250	275	220	230	255	210	225	250	190	200	220	185	195	215
	770	820	900	720	750	840	690	740	820	620	660	720	610	640	710
P5	225	240	265	210	220	245	200	215	235	180	190	210	175	185	205
	740	790	870	690	720	800	660	710	770	590	620	690	570	610	670
P6	250	270	300	235	250	275	225	240	265	205	215	240	195	210	230
	820	890	980	770	820	900	740	790	870	670	710	790	640	690	750
P7	235	255	280	220	235	260	215	230	250	190	205	225	185	200	220
	770	840	920	720	770	850	710	750	820	620	670	740	610	660	720
P8	220	240	265	205	220	240	200	215	235	180	190	210	175	185	205
	720	790	870	670	720	790	660	710	770	590	620	690	570	610	670
P11	230	245	275	215	230	255	205	220	245	185	200	220	180	190	210
	750	800	900	710	750	840	670	720	800	610	660	720	590	620	690
P12	145	155	170	135	145	160	130	140	155	—	—	—	115	120	135
	475	510	560	445	475	520	425	460	510	—	—	—	375	395	445
M1	—	—	—	205	215	240	210	225	250	—	—	—	190	205	225
	—	—	—	670	710	790	690	740	820	—	—	—	620	670	740
M2	—	—	—	170	180	195	175	185	205	—	—	—	155	170	185
	—	—	—	560	590	640	570	610	670	—	—	—	510	560	610
M3	—	—	—	135	145	155	135	145	160	—	—	—	125	130	145
	—	—	—	445	475	510	445	475	520	—	—	—	410	425	475
M4	—	—	—	100	110	120	105	110	125	—	—	—	95	100	110
	—	—	—	330	360	395	345	360	410	—	—	—	310	330	360
M5	—	—	—	85	90	100	90	95	105	—	—	—	80	85	95
	—	—	—	280	295	330	295	310	345	—	—	—	260	280	310
K1	245	255	285	225	240	260	215	230	255	195	205	230	190	200	220
	800	840	940	740	790	850	710	750	840	640	670	750	620	660	720
K2	215	225	250	200	210	235	190	205	225	170	185	200	165	175	195
	710	740	820	660	690	770	620	670	740	560	610	660	540	570	640
K3	180	190	210	165	180	195	160	170	190	145	155	170	140	150	165
	590	620	690	540	590	640	520	560	620	475	510	560	460	490	540
K4	170	185	200	160	170	190	155	165	180	140	145	160	135	145	160
	560	610	660	520	560	620	510	540	590	460	475	520	445	475	520
K5	105	110	125	95	105	115	95	100	110	85	90	100	80	85	95
	345	360	410	310	345	375	310	330	360	280	295	330	260	280	310
K6	150	160	175	140	150	165	135	145	160	120	130	145	120	125	140
	490	520	570	460	490	540	445	475	520	395	425	475	395	410	460
K7	135	140	160	125	135	145	120	130	140	110	115	125	105	110	120
	445	460	520	410	445	475	395	425	460	360	375	410	345	360	395
N1	—	—	—	—	—	—	—	—	—	—	—	—	1425	1500	1675
	—	—	—	—	—	—	—	—	—	—	—	—	4675	4925	5500
N2	—	—	—	—	—	—	—	—	—	—	—	—	570	610	670
	—	—	—	—	—	—	—	—	—	—	—	—	1875	2000	2200
N3	—	—	—	—	—	—	—	—	—	—	—	—	380	405	450
	—	—	—	—	—	—	—	—	—	—	—	—	1250	1325	1475
N11	—	—	—	—	—	—	—	—	—	—	—	—	435	460	510
	—	—	—	—	—	—	—	—	—	—	—	—	1425	1500	1675
S1	—	—	—	50	55	60	49	50	60	—	—	—	45	47	50
	—	—	—	165	180	195	160	165	195	—	—	—	150	155	165
S2	—	—	—	40	43	47	40	42	46	—	—	—	36	38	42
	—	—	—	130	140	155	130	140	150	—	—	—	120	125	140
S3	—	—	—	35	37	41	35	37	40	—	—	—	32	33	37
	—	—	—	115	120	135	115	120	130	—	—	—	105	110	120
S11	—	—	—	70	75	80	70	75	80	—	—	—	65	65	75
	—	—	—	230	245	260	230	245	260	—	—	—	215	215	245
S12	—	—	—	60	65	70	60	60	70	—	—	—	55	55	65
	—	—	—	195	215	230	195	195	230	—	—	—	180	180	215
S13	—	—	—	34	36	40	34	36	39	—	—	—	31	32	36
	—	—	—	110	120	130	110	120	130	—	—	—	100	105	120
H5	49	50	55	41	44	48	43	46	50	39	42	46	38	40	44
	160	165	180	135	145	155	140	150	165	130	140	150	125	130	145
H8	50	55	60	43	46	50	45	48	55	41	44	48	39	42	46
	165	180	195	140	150	165	150	155	180	135	145	155	130	140	150
H11	60	65	75	55	55	60	55	60	65	50	55	60	48	50	55
	195	215	245	180	180	195	180	195	215	165	180	195	155	165	180
H12	60	65	70	50	55	60	50	55	60	47	50	55	45	48	55
	195	215	230	165	180	195	165	180	195	155	165	180	150	155	180
H21	50	55	60	43	46	50	45	48	55	41	44	48	39	42	46
	165	180	195	140	150	165	150	155	180	135	145	155	130	140	150

Square shoulder and slot milling cutters
Helical milling cutters
Face milling cutters
Disc milling cutters
High feed milling cutters
Copy milling cutters
Plunge milling cutters
Chamfer milling cutters
Spot facing cutters
Inserts

335.18/29 Round 10 – Cutting data $v_c = (m/min)/(sf/min)$

	SMG	MK2050			MM4500			MS2050			MS2500			MH1000			H25		
		30%	20%	10%	30%	20%	10%	30%	20%	10%	30%	20%	10%	30%	20%	10%	30%	20%	10%
Square shoulder and slot milling cutters	P1	275	295	325	200	215	235	270	290	315	350	380	415	—	—	—	—	—	—
		900	970	1075	660	710	770	890	950	1025	1150	1250	1350	—	—	—	—	—	—
Helical milling cutters	P2	265	285	310	195	205	225	260	280	310	345	370	405	—	—	—	—	—	—
		870	940	1025	640	670	740	850	920	1025	1125	1225	1325	—	—	—	—	—	—
Face milling cutters	P3	230	250	270	170	180	200	230	245	270	300	320	355	—	—	—	—	—	—
		750	820	890	560	590	660	750	800	890	980	1050	1175	—	—	—	—	—	—
Face milling cutters	P4	205	220	245	150	160	175	200	215	235	265	280	310	—	—	—	—	—	—
		670	720	800	490	520	570	660	710	770	870	920	1025	—	—	—	—	—	—
Face milling cutters	P5	200	210	230	145	150	165	195	205	225	255	270	295	—	—	—	—	—	—
		660	690	750	475	490	540	640	670	740	840	890	970	—	—	—	—	—	—
Face milling cutters	P6	220	240	260	160	170	185	220	235	255	285	305	335	—	—	—	—	—	—
		720	790	850	520	560	610	720	770	840	940	1000	1100	—	—	—	—	—	—
Face milling cutters	P7	210	225	245	150	160	175	205	220	240	270	290	315	—	—	—	—	—	—
		690	740	800	490	520	570	670	720	790	890	950	1025	—	—	—	—	—	—
Face milling cutters	P8	195	210	230	140	150	165	190	205	225	250	270	295	—	—	—	—	—	—
		640	690	750	460	490	540	620	670	740	820	890	970	—	—	—	—	—	—
Face milling cutters	P11	205	220	240	145	155	170	200	215	235	260	280	305	—	—	—	—	—	—
		670	720	790	475	510	560	660	710	770	850	920	1000	—	—	—	—	—	—
Face milling cutters	P12	130	135	150	95	100	110	125	135	145	165	175	195	—	—	—	—	—	—
		425	445	490	310	330	360	410	445	475	540	570	640	—	—	—	—	—	—
Disc milling cutters	M1	—	—	—	165	180	195	210	225	250	245	265	290	—	—	—	—	—	—
	M2	—	—	—	135	145	160	175	185	205	205	215	235	—	—	—	—	—	—
	M3	—	—	—	110	115	125	140	145	160	160	170	190	—	—	—	—	—	—
	M4	—	—	—	85	90	100	105	115	125	125	130	145	—	—	—	—	—	—
	M5	—	—	—	280	295	330	345	375	410	410	425	475	—	—	—	—	—	—
High feed milling cutters	K1	290	305	335	—	—	—	—	—	—	—	—	—	235	250	275	—	—	—
		950	1000	1100	—	—	—	—	—	—	—	—	—	770	820	900	—	—	—
	K2	255	270	300	—	—	—	—	—	—	—	—	—	210	220	245	—	—	—
		840	890	980	—	—	—	—	—	—	—	—	—	690	720	800	—	—	—
	K3	215	230	255	—	—	—	—	—	—	—	—	—	175	185	210	—	—	—
		710	750	840	—	—	—	—	—	—	—	—	—	570	610	690	—	—	—
	K4	205	215	240	—	—	—	—	—	—	—	—	—	170	180	200	—	—	—
670		710	790	—	—	—	—	—	—	—	—	—	560	590	660	—	—	—	
K5	125	135	145	—	—	—	—	—	—	—	—	—	100	110	120	—	—	—	
	410	445	475	—	—	—	—	—	—	—	—	—	330	360	395	—	—	—	
K6	180	190	215	—	—	—	—	—	—	—	—	—	150	155	175	—	—	—	
	590	620	710	—	—	—	—	—	—	—	—	—	490	510	570	—	—	—	
K7	160	170	185	—	—	—	—	—	—	—	—	—	130	140	155	—	—	—	
	520	560	610	—	—	—	—	—	—	—	—	—	425	460	510	—	—	—	
Plunge milling cutters	N1	—	—	—	—	—	—	—	—	—	—	—	—	—	—	—	1450	1550	1725
		—	—	—	—	—	—	—	—	—	—	—	—	—	—	—	4750	5075	5650
	N2	—	—	—	—	—	—	—	—	—	—	—	—	—	—	—	590	620	690
		—	—	—	—	—	—	—	—	—	—	—	—	—	—	—	1925	2025	2275
N3	—	—	—	—	—	—	—	—	—	—	—	—	—	—	—	390	415	460	
	—	—	—	—	—	—	—	—	—	—	—	—	—	—	—	1275	1350	1500	
N11	—	—	—	—	—	—	—	—	—	—	—	—	—	—	—	450	475	530	
	—	—	—	—	—	—	—	—	—	—	—	—	—	—	—	1475	1550	1750	
Chamfer milling cutters	S1	—	—	—	25	27	30	49	55	60	60	65	70	—	—	—	—	—	—
		—	—	—	80	90	100	160	180	195	195	215	230	—	—	—	—	—	—
	S2	—	—	—	20	22	24	40	43	47	48	50	55	—	—	—	—	—	—
		—	—	—	65	70	80	130	140	155	155	165	180	—	—	—	—	—	—
	S3	—	—	—	18	19	21	35	37	41	42	45	50	—	—	—	—	—	—
		—	—	—	60	60	70	115	120	135	140	150	165	—	—	—	—	—	—
S11	—	—	—	36	38	42	70	75	80	85	90	100	—	—	—	—	—	—	
	—	—	—	120	125	140	230	245	260	280	295	330	—	—	—	—	—	—	
S12	—	—	—	33	35	39	60	65	70	70	75	85	—	—	—	—	—	—	
	—	—	—	110	115	130	195	215	230	230	245	280	—	—	—	—	—	—	
S13	—	—	—	19	20	22	34	36	40	41	44	48	—	—	—	—	—	—	
	—	—	—	60	65	70	110	120	130	135	145	155	—	—	—	—	—	—	
Spot facing cutters	H5	—	—	—	—	—	—	—	—	—	—	—	—	47	50	55	—	—	—
		—	—	—	—	—	—	—	—	—	—	—	—	155	165	180	—	—	—
	H8	—	—	—	—	—	—	—	—	—	—	—	—	50	55	60	—	—	—
Inserts	H11	—	—	—	—	—	—	—	—	—	—	—	—	60	65	70	—	—	—
		—	—	—	—	—	—	—	—	—	—	—	—	195	215	230	—	—	—
	H12	—	—	—	—	—	—	—	—	—	—	—	—	60	60	65	—	—	—
		—	—	—	—	—	—	—	—	—	—	—	—	195	195	215	—	—	—
H21	—	—	—	—	—	—	—	—	—	—	—	—	50	55	60	—	—	—	
—	—	—	—	—	—	—	—	—	—	—	—	165	180	195	—	—	—		

335.18/29 Round 12 – Insert selection – mm/Inch

SMG		f _z		
		30%	20%	10%
P1	RPHT1204M0T-6-ME07 F40M	0,12 0.0048	0,13 0.0050	0,18 0.0070
P2	RPHT1204M0T-6-ME07 F40M	0,12 0.0048	0,13 0.0050	0,18 0.0070
P3	RPHT1204M0T-6-M08 F40M	0,13 0.0050	0,15 0.0060	0,19 0.0075
P4	RPHT1204M0T-6-M08 F40M	0,12 0.0048	0,14 0.0055	0,19 0.0075
P5	RPHT1204M0T-6-M08 F40M	0,12 0.0048	0,14 0.0055	0,19 0.0075
P6	RPHT1204M0T-6-M08 F40M	0,12 0.0048	0,14 0.0055	0,19 0.0075
P7	RPHT1204M0T-6-M08 F40M	0,12 0.0048	0,14 0.0055	0,19 0.0075
P8	RPHT1204M0T-6-M08 MP2501	0,13 0.0050	0,15 0.0060	0,19 0.0075
P11	RPHT1204M0T-6-M08 F40M	0,12 0.0048	0,14 0.0055	0,19 0.0075
P12	RPHT1204M0T-6-M08 F40M	0,085 0.0034	0,095 0.0038	0,13 0.0050
M1	RPHT1204M0T-6-ME07 F40M	0,12 0.0048	0,13 0.0050	0,18 0.0070
M2	RPHT1204M0T-6-ME07 F40M	0,11 0.0044	0,12 0.0048	0,16 0.0065
M3	RPHT1204M0T-6-M08 F40M	0,10 0.0040	0,11 0.0044	0,15 0.0060
M4	RPHT1204M0T-6-M08 F40M	0,085 0.0034	0,10 0.0040	0,13 0.0050
M5	RPHT1204M0T-6-M08 F40M	0,085 0.0034	0,10 0.0040	0,13 0.0050
K1	RPKW1204M0T-6-MD10 MK2050	0,17 0.0065	0,19 0.0075	0,26 0.010
K2	RPKW1204M0T-6-MD10 MK2050	0,15 0.0060	0,18 0.0070	0,24 0.0095
K3	RPKW1204M0T-6-MD10 MK2050	0,15 0.0060	0,18 0.0070	0,24 0.0095
K4	RPKW1204M0T-6-MD10 MK2050	0,15 0.0060	0,18 0.0070	0,24 0.0095
K5	RPKW1204M0T-6-MD10 MK2050	0,14 0.0055	0,16 0.0065	0,22 0.0085
K6	RPKW1204M0T-6-MD10 MK2050	0,15 0.0060	0,18 0.0070	0,24 0.0095
K7	RPKW1204M0T-6-MD10 MK2050	0,14 0.0055	0,16 0.0065	0,22 0.0085
N1	RPHT1204M0-6-E05 H25	0,11 0.0044	0,12 0.0048	0,16 0.0065
N2	RPHT1204M0-6-E05 H25	0,11 0.0044	0,12 0.0048	0,16 0.0065
N3	RPHT1204M0-6-E05 H25	0,11 0.0044	0,12 0.0048	0,16 0.0065
N11	RPHT1204M0-6-E05 H25	0,11 0.0044	0,12 0.0048	0,16 0.0065
S1	RPHT1204M0T-6-M08 F40M	0,085 0.0034	0,10 0.0040	0,13 0.0050
S2	RPHT1204M0T-6-M08 F40M	0,085 0.0034	0,10 0.0040	0,13 0.0050
S3	RPHT1204M0T-6-M08 F40M	0,080 0.0032	0,090 0.0036	0,12 0.0048
S11	RPHT1204M0T-6-ME07 F40M	0,085 0.0034	0,10 0.0040	0,13 0.0050
S12	RPHT1204M0T-6-ME07 F40M	0,085 0.0034	0,10 0.0040	0,13 0.0050
S13	RPHT1204M0T-6-M08 F40M	0,085 0.0034	0,10 0.0040	0,13 0.0050
H5	RPHW1204M0T-6-MD12 MH1000	0,12 0.0048	0,14 0.0055	0,19 0.0075
H8	RPHW1204M0T-6-MD12 MH1000	0,095 0.0038	0,11 0.0044	0,15 0.0060
H11	RPHT1204M0T-6-M13 F40M	0,14 0.0055	0,15 0.0060	0,20 0.0080
H12	RPHT1204M0T-6-M13 F40M	0,10 0.0040	0,12 0.0048	0,16 0.0065
H21	RPHW1204M0T-6-MD12 MH1000	0,095 0.0038	0,11 0.0044	0,15 0.0060

SMG = Seco material group
f_z = mm/tooth (in/tooth), v_c = m/min (sf/min), a_p/DC = %
All cutting data are start values

Square shoulder and slot milling cutters
Helical milling cutters
Face milling cutters
Disc milling cutters
High feed milling cutters
Copy milling cutters
Plunge milling cutters
Chamfer milling cutters
Spot facing cutters
Inserts

335.18/29 Round 12 – Cutting data $v_c = (m/min)/(sf/min)$

SMG	MP2501			MP3000			T350M			F40M		
	30%	20%	10%	30%	20%	10%	30%	20%	10%	30%	20%	10%
P1	290	310	345	270	285	320	250	270	300	220	235	260
	950	1025	1125	890	940	1050	820	890	980	720	770	850
P2	280	300	330	265	280	310	245	260	285	210	225	250
	920	980	1075	870	920	1025	800	850	940	690	740	820
P3	245	260	290	230	245	265	215	230	250	185	200	220
	800	850	950	750	800	870	710	750	820	610	660	720
P4	215	230	255	200	215	240	190	200	220	165	175	195
	710	750	840	660	710	790	620	660	720	540	570	640
P5	205	220	245	195	205	230	180	190	215	155	165	185
	670	720	800	640	670	750	590	620	710	510	540	610
P6	230	250	275	215	230	255	200	220	240	175	190	210
	750	820	900	710	750	840	660	720	790	570	620	690
P7	220	235	260	205	220	240	190	205	225	165	180	200
	720	770	850	670	720	790	620	670	740	540	590	660
P8	205	220	245	195	205	225	180	190	210	155	165	185
	670	720	800	640	670	740	590	620	690	510	540	610
P11	210	230	255	200	210	235	185	200	220	160	175	190
	690	750	840	660	690	770	610	660	720	520	570	620
P12	135	145	160	125	135	150	120	125	140	105	110	125
	445	475	520	410	445	490	395	410	460	345	360	410
M1	200	215	235	195	210	230	190	200	220	170	185	200
	660	710	770	640	690	750	620	660	720	560	610	660
M2	165	175	200	160	175	190	155	165	185	140	150	170
	540	570	660	520	570	620	510	540	610	460	490	560
M3	135	140	155	130	135	150	125	130	145	115	120	135
	445	460	510	425	445	490	410	425	475	375	395	445
M4	105	110	120	100	105	115	95	105	115	85	95	100
	345	360	395	330	345	375	310	345	375	280	310	330
M5	85	90	100	80	85	95	80	85	95	75	80	85
	280	295	330	260	280	310	260	280	310	245	260	280
K1	220	240	260	175	185	205	195	205	225	170	180	200
	720	790	850	610	670	740	640	670	740	560	590	660
K2	195	210	235	155	165	180	170	180	205	150	160	175
	640	690	770	510	540	590	560	590	670	490	520	570
K3	165	175	200	130	140	155	145	155	170	125	135	150
	540	570	660	425	460	510	475	510	560	410	445	490
K4	160	170	190	125	135	145	140	145	165	120	130	145
	520	560	620	410	445	475	460	475	540	395	425	475
K5	100	105	115	75	80	90	85	90	100	75	80	85
	330	345	375	245	260	295	280	295	330	245	260	280
K6	140	150	165	110	115	130	120	130	145	105	115	125
	460	490	540	360	375	425	395	425	475	345	375	410
K7	125	135	145	95	105	115	110	115	130	95	100	110
	410	445	475	310	345	375	360	375	425	310	330	360
N1	—	—	—	1575	1650	1850	—	—	—	1250	1350	1475
	—	—	—	5175	5425	6075	—	—	—	4100	4425	4850
N2	—	—	—	630	670	740	—	—	—	500	540	600
	—	—	—	2075	2200	2425	—	—	—	1650	1775	1975
N3	—	—	—	420	445	495	—	—	—	335	365	395
	—	—	—	1375	1450	1625	—	—	—	1100	1200	1300
N11	—	—	—	480	510	570	—	—	—	385	415	455
	—	—	—	1575	1675	1875	—	—	—	1275	1350	1500
S1	50	55	60	46	49	55	45	48	55	41	44	48
	165	180	195	150	160	180	150	155	180	135	145	155
S2	40	43	47	37	39	43	36	39	42	33	35	38
	130	140	155	120	130	140	120	130	140	110	115	125
S3	36	38	41	32	34	38	32	34	37	29	31	34
	120	125	135	105	110	125	105	110	120	95	100	110
S11	70	75	85	65	70	75	65	65	75	55	60	65
	230	245	280	215	230	245	215	215	245	180	195	215
S12	60	65	70	55	60	65	55	55	60	48	50	55
	195	215	230	180	195	215	180	180	195	155	165	180
S13	34	37	40	31	33	37	31	33	36	28	30	33
	110	120	130	100	110	120	100	110	120	90	100	110
H5	41	44	49	35	37	41	40	42	47	35	37	41
	135	145	160	115	120	135	130	140	155	115	120	135
H8	44	46	50	36	39	42	42	44	49	36	39	43
	145	150	165	120	130	140	140	145	160	120	130	140
H11	55	55	60	44	48	55	50	55	60	44	47	50
	180	180	195	145	155	180	165	180	195	145	155	165
H12	50	55	60	42	45	49	49	50	55	42	45	50
	165	180	195	140	150	160	160	165	180	140	150	165
H21	44	46	50	36	39	42	42	44	49	36	39	43
	145	150	165	120	130	140	140	145	160	120	130	140

335.18/29 Round 12 – Cutting data $v_c = (m/min)/(sf/min)$

SMG	MK2050			MM4500			MS2050			H25		
	30%	20%	10%	30%	20%	10%	30%	20%	10%	30%	20%	10%
P1	240	260	290	180	190	210	245	260	290	—	—	—
	790	850	950	590	620	690	800	850	950	—	—	—
P2	235	250	275	175	185	205	235	255	280	—	—	—
	770	820	900	570	610	670	770	840	920	—	—	—
P3	205	220	245	150	160	180	205	220	245	—	—	—
	670	720	800	490	520	590	670	720	800	—	—	—
P4	180	195	215	135	145	160	185	195	215	—	—	—
	590	640	710	445	475	520	610	640	710	—	—	—
P5	175	185	205	130	135	150	175	185	205	—	—	—
	570	610	670	425	445	490	570	610	670	—	—	—
P6	195	210	230	145	155	170	195	210	230	—	—	—
	640	690	750	475	510	560	640	690	750	—	—	—
P7	185	200	215	135	145	160	185	195	215	—	—	—
	610	660	710	445	475	520	610	640	710	—	—	—
P8	170	185	205	125	135	150	170	185	205	—	—	—
	560	610	670	410	445	490	560	610	670	—	—	—
P11	180	195	210	135	140	155	180	190	210	—	—	—
	590	640	690	445	460	510	590	620	690	—	—	—
P12	115	125	135	85	90	100	115	125	135	—	—	—
	375	410	445	280	295	330	375	410	445	—	—	—
M1	—	—	—	150	160	175	190	205	225	—	—	—
	—	—	—	490	520	570	620	670	740	—	—	—
M2	—	—	—	125	130	145	155	170	185	—	—	—
	—	—	—	410	425	475	510	560	610	—	—	—
M3	—	—	—	100	105	115	125	135	150	—	—	—
	—	—	—	330	345	375	410	445	490	—	—	—
M4	—	—	—	75	80	90	95	105	115	—	—	—
	—	—	—	245	260	295	310	345	375	—	—	—
M5	—	—	—	65	65	75	80	85	95	—	—	—
	—	—	—	215	215	245	260	280	310	—	—	—
K1	255	270	300	—	—	—	—	—	—	—	—	—
	840	890	980	—	—	—	—	—	—	—	—	—
K2	225	240	265	—	—	—	—	—	—	—	—	—
	740	790	870	—	—	—	—	—	—	—	—	—
K3	190	200	225	—	—	—	—	—	—	—	—	—
	620	660	740	—	—	—	—	—	—	—	—	—
K4	185	195	215	—	—	—	—	—	—	—	—	—
	610	640	710	—	—	—	—	—	—	—	—	—
K5	110	120	130	—	—	—	—	—	—	—	—	—
	360	395	425	—	—	—	—	—	—	—	—	—
K6	160	170	190	—	—	—	—	—	—	—	—	—
	520	560	620	—	—	—	—	—	—	—	—	—
K7	140	150	165	—	—	—	—	—	—	—	—	—
	460	490	540	—	—	—	—	—	—	—	—	—
N1	—	—	—	—	—	—	—	—	—	1375	1475	1625
	—	—	—	—	—	—	—	—	—	4500	4850	5325
N2	—	—	—	—	—	—	—	—	—	550	600	660
	—	—	—	—	—	—	—	—	—	1800	1975	2175
N3	—	—	—	—	—	—	—	—	—	370	400	440
	—	—	—	—	—	—	—	—	—	1225	1300	1450
N11	—	—	—	—	—	—	—	—	—	420	455	500
	—	—	—	—	—	—	—	—	—	1375	1500	1650
S1	—	—	—	23	25	27	45	48	55	—	—	—
	—	—	—	75	80	90	150	155	180	—	—	—
S2	—	—	—	19	20	22	36	39	43	—	—	—
	—	—	—	60	65	70	120	130	140	—	—	—
S3	—	—	—	16	17	19	32	34	38	—	—	—
	—	—	—	50	55	60	105	110	125	—	—	—
S11	—	—	—	32	35	38	65	70	75	—	—	—
	—	—	—	105	115	125	215	230	245	—	—	—
S12	—	—	—	30	32	35	55	55	65	—	—	—
	—	—	—	100	105	115	180	180	215	—	—	—
S13	—	—	—	17	18	21	31	33	36	—	—	—
	—	—	—	55	60	70	100	110	120	—	—	—
H5	—	—	—	—	—	—	—	—	—	—	—	—
H8	—	—	—	—	—	—	—	—	—	—	—	—
H11	—	—	—	—	—	—	—	—	—	—	—	—
H12	—	—	—	—	—	—	—	—	—	—	—	—
H21	—	—	—	—	—	—	—	—	—	—	—	—

Square shoulder and slot milling cutters
Helical milling cutters
Face milling cutters
Disc milling cutters
High feed milling cutters
Copy milling cutters
Plunge milling cutters
Chamfer milling cutters
Spot facing cutters
Inserts

335.25 Round 16 – Insert selection – mm/Inch

SMG		f _z		
		30%	20%	10%
P1	RPHT1605M0T-8-ME11 F40M	0,19	0,22	0,28
		0,0075	0,0085	0,011
P2	RPHT1605M0T-8-ME11 F40M	0,19	0,22	0,30
		0,0075	0,0085	0,012
P3	RPHT1605M0T-8-ME11 F40M	0,18	0,20	0,28
		0,0070	0,0080	0,011
P4	RPHT1605M0T-8-M12 F40M	0,19	0,22	0,30
		0,0075	0,0085	0,012
P5	RPHT1605M0T-8-M12 F40M	0,19	0,22	0,28
		0,0075	0,0085	0,011
P6	RPHT1605M0T-8-M12 F40M	0,19	0,22	0,28
		0,0075	0,0085	0,011
P7	RPHT1605M0T-8-M12 F40M	0,19	0,22	0,28
		0,0075	0,0085	0,011
P8	RPKT1605M0T-8-M12 MP2501	0,20	0,22	0,30
		0,0080	0,0085	0,012
P11	RPHT1605M0T-8-M12 F40M	0,19	0,22	0,28
		0,0075	0,0085	0,011
P12	RPHT1605M0T-8-M12 F40M	0,13	0,15	0,20
		0,0050	0,0060	0,0080
M1	RPHT1605M0T-8-ME11 F40M	0,19	0,22	0,30
		0,0075	0,0085	0,012
M2	RPHT1605M0T-8-ME11 F40M	0,17	0,20	0,26
		0,0065	0,0080	0,010
M3	RPHT1605M0T-8-M12 F40M	0,15	0,17	0,24
		0,0060	0,0065	0,0095
M4	RPHT1605M0T-8-M12 F40M	0,13	0,15	0,20
		0,0050	0,0060	0,0080
M5	RPHT1605M0T-8-M12 F40M	0,13	0,15	0,20
		0,0050	0,0060	0,0080
K1	RPKT1605M0T-8-M18 MK2050	0,32	0,36	0,48
		0,013	0,014	0,019
K2	RPKT1605M0T-8-M18 MK2050	0,28	0,32	0,44
		0,011	0,013	0,017
K3	RPKT1605M0T-8-M18 MK2050	0,28	0,32	0,44
		0,011	0,013	0,017
K4	RPKT1605M0T-8-M18 MK2050	0,28	0,32	0,44
		0,011	0,013	0,017
K5	RPKT1605M0T-8-M18 MK2050	0,25	0,30	0,38
		0,010	0,012	0,015
K6	RPKT1605M0T-8-M18 MK2050	0,28	0,32	0,44
		0,011	0,013	0,017
K7	RPKT1605M0T-8-M18 MK2050	0,25	0,30	0,38
		0,010	0,012	0,015
N1	RPHT1605M0T-8-ME11 F40M	0,24	0,28	0,36
		0,0095	0,011	0,014
N2	RPHT1605M0T-8-ME11 F40M	0,24	0,28	0,36
		0,0095	0,011	0,014
N3	RPHT1605M0T-8-ME11 F40M	0,24	0,28	0,36
		0,0095	0,011	0,014
N11	RPHT1605M0T-8-ME11 F40M	0,24	0,28	0,36
		0,0095	0,011	0,014
S1	RPHT1605M0T-8-M12 F40M	0,13	0,15	0,20
		0,0050	0,0060	0,0080
S2	RPHT1605M0T-8-M12 F40M	0,13	0,15	0,20
		0,0050	0,0060	0,0080
S3	RPHT1605M0T-8-M12 F40M	0,12	0,14	0,19
		0,0048	0,0055	0,0075
S11	RPHT1605M0T-8-ME11 F40M	0,14	0,16	0,22
		0,0055	0,0065	0,0085
S12	RPHT1605M0T-8-ME11 F40M	0,14	0,16	0,22
		0,0055	0,0065	0,0085
H5	RPKW1605M0T-8-MD20 F15M	0,22	0,24	0,32
		0,0085	0,0095	0,013
H8	RPKW1605M0T-8-MD20 F15M	0,16	0,19	0,25
		0,0065	0,0075	0,010
H11	RPKW1605M0T-8-MD20 F15M	0,22	0,24	0,32
		0,0085	0,0095	0,013
H12	RPKW1605M0T-8-MD20 F15M	0,16	0,19	0,25
		0,0065	0,0075	0,010
H21	RPKW1605M0T-8-MD20 F15M	0,16	0,19	0,25
		0,0065	0,0075	0,010

SMG = Seco material group
f_z = mm/tooth (in/tooth), v_c = m/min (sf/min), a_p/DC = %
All cutting data are start values

335.25 Round 16 – Cutting data $v_c = (m/min)/(sf/min)$

SMG	MP1501			MP2501			T350M			F15M			F40M		
	30%	20%	10%	30%	20%	10%	30%	20%	10%	30%	20%	10%	30%	20%	10%
P1	245	260	290	245	260	290	215	225	250	170	180	205	185	195	220
	800	850	950	800	850	950	710	740	820	560	590	670	610	640	720
P2	235	255	280	240	255	280	210	220	245	165	175	195	180	190	210
	770	840	920	790	840	920	690	720	800	540	570	640	590	620	690
P3	205	220	245	205	225	245	180	195	215	145	155	170	155	170	185
	670	720	800	670	740	800	590	640	710	475	510	560	510	560	610
P4	180	195	220	185	195	215	160	170	190	130	135	150	140	150	165
	590	640	720	610	640	710	520	560	620	425	445	490	460	490	540
P5	180	190	210	175	185	205	155	165	180	125	130	145	135	140	155
	590	620	690	570	610	670	510	540	590	410	425	475	445	460	510
P6	200	215	235	195	210	235	170	185	205	140	150	165	150	160	180
	660	710	770	640	690	770	560	610	670	460	490	540	490	520	590
P7	190	200	220	185	200	220	160	175	195	130	140	155	140	150	170
	620	660	720	610	660	720	520	570	640	425	460	510	460	490	560
P8	175	185	205	175	185	205	150	165	180	125	130	145	130	140	155
	570	610	670	570	610	670	490	540	590	410	425	475	425	460	510
P11	185	195	215	180	195	215	155	170	190	125	135	150	135	145	165
	610	640	710	590	640	710	510	560	620	410	445	490	445	475	540
P12	120	130	140	115	125	140	100	110	120	—	—	—	90	95	105
	395	425	460	375	410	460	330	360	395	—	—	—	295	310	345
M1	—	—	—	170	180	200	160	170	190	—	—	—	145	155	170
	—	—	—	560	590	660	520	560	620	—	—	—	475	510	560
M2	—	—	—	140	150	165	130	140	155	—	—	—	120	130	140
	—	—	—	460	490	540	425	460	510	—	—	—	395	425	460
M3	—	—	—	115	125	135	105	115	125	—	—	—	95	105	115
	—	—	—	375	410	445	345	375	410	—	—	—	310	345	375
M4	—	—	—	90	95	105	85	90	100	—	—	—	75	80	90
	—	—	—	295	310	345	280	295	330	—	—	—	245	260	295
M5	—	—	—	75	80	85	70	75	80	—	—	—	65	65	75
	—	—	—	245	260	280	230	245	260	—	—	—	215	215	245
K1	185	200	225	190	200	220	165	175	195	130	140	155	145	150	170
	610	660	740	620	660	720	540	570	640	425	460	510	475	490	560
K2	170	180	200	165	180	195	145	155	170	115	125	140	125	135	150
	560	590	660	540	590	640	475	510	560	375	410	460	410	445	490
K3	145	155	170	140	150	165	125	130	145	100	105	120	105	115	125
	475	510	560	460	490	540	410	425	475	330	345	395	345	375	410
K4	135	145	160	135	145	160	115	125	140	95	100	115	100	110	120
	445	475	520	445	475	520	375	410	460	310	330	375	330	360	395
K5	85	90	100	80	90	100	70	75	85	60	65	70	60	65	75
	280	295	330	260	295	330	230	245	280	195	215	230	195	215	245
K6	120	130	140	120	125	140	105	110	120	85	90	100	90	95	105
	395	425	460	395	410	460	345	360	395	280	295	330	295	310	345
K7	105	115	125	105	110	125	90	100	110	75	80	90	80	85	95
	345	375	410	345	360	410	295	330	360	245	260	295	260	280	310
N1	—	—	—	—	—	—	—	—	—	—	—	—	1050	1125	1250
	—	—	—	—	—	—	—	—	—	—	—	—	3450	3700	4100
N2	—	—	—	—	—	—	—	—	—	—	—	—	425	455	510
	—	—	—	—	—	—	—	—	—	—	—	—	1400	1500	1675
N3	—	—	—	—	—	—	—	—	—	—	—	—	285	305	335
	—	—	—	—	—	—	—	—	—	—	—	—	940	1000	1100
N11	—	—	—	—	—	—	—	—	—	—	—	—	325	345	385
	—	—	—	—	—	—	—	—	—	—	—	—	1075	1125	1275
S1	—	—	—	43	46	50	39	41	46	—	—	—	35	37	41
	—	—	—	140	150	165	130	135	150	—	—	—	115	120	135
S2	—	—	—	35	37	41	31	33	37	—	—	—	28	30	33
	—	—	—	115	120	135	100	110	120	—	—	—	90	100	110
S3	—	—	—	31	32	36	27	29	32	—	—	—	25	26	29
	—	—	—	100	105	120	90	95	105	—	—	—	80	85	95
S11	—	—	—	60	65	70	55	60	65	—	—	—	49	55	55
	—	—	—	195	215	230	180	195	215	—	—	—	160	180	180
S12	—	—	—	50	55	60	45	49	55	—	—	—	41	44	48
	—	—	—	165	180	195	150	160	180	—	—	—	135	145	155
S13	—	—	—	29	31	35	26	28	31	—	—	—	24	26	28
	—	—	—	95	100	115	85	90	100	—	—	—	80	85	90
H5	40	43	47	35	38	42	34	36	40	28	30	33	29	31	35
	130	140	155	115	125	140	110	120	130	90	100	110	95	100	115
H8	42	46	50	38	40	44	36	39	43	30	32	35	31	34	37
	140	150	165	125	130	145	120	130	140	100	105	115	100	110	120
H11	50	55	60	45	48	55	43	46	50	35	38	42	38	40	44
	165	180	195	150	155	180	140	150	165	115	125	140	125	130	145
H12	49	55	60	44	47	50	42	45	50	35	37	41	36	39	43
	160	180	195	145	155	165	140	150	165	115	120	135	120	130	140
H21	42	46	50	38	40	44	36	39	43	30	32	35	31	34	37
	140	150	165	125	130	145	120	130	140	100	105	115	100	110	120

Square shoulder and slot milling cutters
Helical milling cutters
Face milling cutters
Disc milling cutters
High feed milling cutters
Copy milling cutters
Plunge milling cutters
Chamfer milling cutters
Spot facing cutters
Inserts

335.25 Round 16 – Cutting data $v_c = (m/min)/(sf/min)$

SMG	MK2050			MM4500			MS2050			MS2500		
	30%	20%	10%	30%	20%	10%	30%	20%	10%	30%	20%	10%
P1	215	230	255	150	160	175	215	230	260	270	285	315
	710	750	840	490	520	570	710	750	850	890	940	1025
P2	205	220	245	145	155	170	210	225	245	260	275	305
	670	720	800	475	510	560	690	740	800	850	900	1000
P3	180	195	215	125	135	150	185	200	215	225	245	265
	590	640	710	410	445	490	610	660	710	740	800	870
P4	160	175	190	115	120	130	160	175	195	200	215	235
	520	570	620	375	395	425	520	570	640	660	710	770
P5	155	165	180	110	115	130	155	165	185	190	205	230
	510	540	590	360	375	425	510	540	610	620	670	750
P6	175	185	210	120	130	145	175	185	210	215	230	255
	570	610	690	395	425	475	570	610	690	710	750	840
P7	165	175	195	115	120	135	165	175	195	205	215	240
	540	570	640	375	395	445	540	570	640	670	710	790
P8	150	165	180	105	115	125	155	165	180	190	205	225
	490	540	590	345	375	410	510	540	590	620	670	740
P11	160	170	190	110	120	135	160	170	190	195	210	235
	520	560	620	360	395	445	520	560	620	640	690	770
P12	105	110	125	70	75	85	105	110	125	130	135	150
	345	360	410	230	245	280	345	360	410	425	445	490
M1	—	—	—	125	135	145	170	180	200	185	200	220
	—	—	—	410	445	475	560	590	660	610	660	720
M2	—	—	—	105	110	125	140	150	165	155	165	185
	—	—	—	345	360	410	460	490	540	510	540	610
M3	—	—	—	85	90	100	115	120	135	125	135	145
	—	—	—	280	295	330	375	395	445	410	445	475
M4	—	—	—	65	70	75	90	95	105	95	105	115
	—	—	—	215	230	245	295	310	345	310	345	375
M5	—	—	—	55	60	65	75	80	85	80	85	95
	—	—	—	180	195	215	245	260	280	260	280	310
K1	220	240	265	—	—	—	—	—	—	—	—	—
	720	790	870	—	—	—	—	—	—	—	—	—
K2	200	215	235	—	—	—	—	—	—	—	—	—
	660	710	770	—	—	—	—	—	—	—	—	—
K3	170	180	200	—	—	—	—	—	—	—	—	—
	560	590	660	—	—	—	—	—	—	—	—	—
K4	160	175	190	—	—	—	—	—	—	—	—	—
	520	570	620	—	—	—	—	—	—	—	—	—
K5	100	105	120	—	—	—	—	—	—	—	—	—
	330	345	395	—	—	—	—	—	—	—	—	—
K6	140	155	170	—	—	—	—	—	—	—	—	—
	460	510	560	—	—	—	—	—	—	—	—	—
K7	125	135	150	—	—	—	—	—	—	—	—	—
	410	445	490	—	—	—	—	—	—	—	—	—
N1	—	—	—	—	—	—	—	—	—	—	—	—
	—	—	—	—	—	—	—	—	—	—	—	—
N2	—	—	—	—	—	—	—	—	—	—	—	—
	—	—	—	—	—	—	—	—	—	—	—	—
N3	—	—	—	—	—	—	—	—	—	—	—	—
	—	—	—	—	—	—	—	—	—	—	—	—
N11	—	—	—	—	—	—	—	—	—	—	—	—
	—	—	—	—	—	—	—	—	—	—	—	—
S1	—	—	—	20	21	23	41	44	49	47	50	55
	—	—	—	65	70	75	135	145	160	155	165	180
S2	—	—	—	16	17	19	33	35	39	38	40	45
	—	—	—	50	55	60	110	115	130	125	130	150
S3	—	—	—	14	15	16	29	31	34	33	35	39
	—	—	—	46	49	50	95	100	110	110	115	130
S11	—	—	—	28	30	32	55	60	65	65	70	75
	—	—	—	90	100	105	180	195	215	215	230	245
S12	—	—	—	26	27	30	48	50	55	55	60	65
	—	—	—	85	90	100	155	165	180	180	195	215
S13	—	—	—	15	16	18	28	30	33	32	34	38
	—	—	—	49	50	60	90	100	110	105	110	125
H5	—	—	—	—	—	—	—	—	—	—	—	—
	—	—	—	—	—	—	—	—	—	—	—	—
H8	—	—	—	—	—	—	—	—	—	—	—	—
	—	—	—	—	—	—	—	—	—	—	—	—
H11	—	—	—	—	—	—	—	—	—	—	—	—
	—	—	—	—	—	—	—	—	—	—	—	—
H12	—	—	—	—	—	—	—	—	—	—	—	—
	—	—	—	—	—	—	—	—	—	—	—	—
H21	—	—	—	—	—	—	—	—	—	—	—	—
	—	—	—	—	—	—	—	—	—	—	—	—

335.25 Round 20 – Insert selection – mm/Inch

SMG		f _z		
		30%	20%	10%
P1	RPHT2006M0T-ME12 F40M	0,20 0.0080	0,24 0.0095	0,32 0.013
P2	RPHT2006M0T-ME12 F40M	0,20 0.0080	0,24 0.0095	0,32 0.013
P3	RPHT2006M0T-ME12 F40M	0,20 0.0080	0,22 0.0085	0,30 0.012
P4	RPHT2006M0T-ME12 F40M	0,19 0.0075	0,22 0.0085	0,30 0.012
P5	RPKT2006M0T-M15 F40M	0,24 0.0095	0,28 0.011	0,36 0.014
P6	RPKT2006M0T-M15 F40M	0,24 0.0095	0,26 0.010	0,36 0.014
P7	RPKT2006M0T-M15 F40M	0,24 0.0095	0,26 0.010	0,36 0.014
P8	RPKT2006M0T-M15 MP2501	0,25 0.010	0,28 0.011	0,38 0.015
P11	RPHT2006M0T-ME12 F40M	0,19 0.0075	0,22 0.0085	0,28 0.011
P12	RPHT2006M0T-ME12 F40M	0,13 0.0050	0,15 0.0060	0,20 0.0080
M1	RPHT2006M0T-ME12 F40M	0,20 0.0080	0,24 0.0095	0,32 0.013
M2	RPHT2006M0T-ME12 F40M	0,19 0.0075	0,22 0.0085	0,28 0.011
M3	RPHT2006M0T-ME12 F40M	0,15 0.0060	0,17 0.0065	0,24 0.0095
M4	RPHT2006M0T-ME12 F40M	0,13 0.0050	0,15 0.0060	0,20 0.0080
M5	RPHT2006M0T-ME12 F40M	0,13 0.0050	0,15 0.0060	0,20 0.0080
K1	RPKT2006M0T-M20 MK2050	0,26 0.010	0,30 0.012	0,40 0.016
K2	RPKT2006M0T-M20 MK2050	0,24 0.0095	0,28 0.011	0,36 0.014
K3	RPKT2006M0T-M20 MK2050	0,24 0.0095	0,28 0.011	0,36 0.014
K4	RPKT2006M0T-M20 MK2050	0,24 0.0095	0,28 0.011	0,36 0.014
K5	RPKT2006M0T-M20 MK2050	0,22 0.0085	0,24 0.0095	0,32 0.013
K6	RPKT2006M0T-M20 MK2050	0,24 0.0095	0,28 0.011	0,36 0.014
K7	RPKT2006M0T-M20 MK2050	0,22 0.0085	0,24 0.0095	0,32 0.013
N1	RPHT2006M0T-ME12 F40M	0,26 0.010	0,30 0.012	0,40 0.016
N2	RPHT2006M0T-ME12 F40M	0,26 0.010	0,30 0.012	0,40 0.016
N3	RPHT2006M0T-ME12 F40M	0,26 0.010	0,30 0.012	0,40 0.016
N11	RPHT2006M0T-ME12 F40M	0,26 0.010	0,30 0.012	0,40 0.016
S1	RPHT2006M0T-ME12 F40M	0,13 0.0050	0,15 0.0060	0,20 0.0080
S2	RPHT2006M0T-ME12 F40M	0,13 0.0050	0,15 0.0060	0,20 0.0080
S3	RPHT2006M0T-ME12 F40M	0,12 0.0048	0,14 0.0055	0,19 0.0075
S11	RPHT2006M0T-ME12 F40M	0,15 0.0060	0,17 0.0065	0,24 0.0095
S12	RPHT2006M0T-ME12 F40M	0,15 0.0060	0,17 0.0065	0,24 0.0095
H5	RPKW2006M0T-MD22 F15M	0,24 0.0095	0,26 0.010	0,36 0.014
H8	RPKW2006M0T-MD22 F15M	0,18 0.0070	0,20 0.0080	0,28 0.011
H11	RPKW2006M0T-MD22 F15M	0,24 0.0095	0,26 0.010	0,36 0.014
H12	RPKW2006M0T-MD22 F15M	0,18 0.0070	0,20 0.0080	0,28 0.011
H21	RPKW2006M0T-MD22 F15M	0,18 0.0070	0,20 0.0080	0,28 0.011

SMG = Seco material group
f_z = mm/tooth (in/tooth), v_c = m/min (sf/min), a_e/DC = %
All cutting data are start values

Square shoulder and slot milling cutters
Helical milling cutters
Face milling cutters
Disc milling cutters
High feed milling cutters
Copy milling cutters
Plunge milling cutters
Chamfer milling cutters
Spot facing cutters
Inserts

335.25 Round 20 – Cutting data $v_c = (m/min)/(sf/min)$

SMG	MP1501			MP2501			T350M			F15M			F25M			F30M		
	30%	20%	10%	30%	20%	10%	30%	20%	10%	30%	20%	10%	30%	20%	10%	30%	20%	10%
P1	235	255	285	230	245	270	200	215	235	165	175	195	190	205	225	180	195	215
	770	840	940	750	800	890	660	710	770	540	570	640	620	670	740	590	640	710
P2	230	245	270	220	240	265	195	205	230	160	170	190	185	200	220	180	190	210
	750	800	890	720	790	870	640	670	750	520	560	620	610	660	720	590	620	690
P3	205	215	240	195	210	230	170	180	200	140	150	165	160	175	190	155	165	185
	670	710	790	640	690	750	560	590	660	460	490	540	520	570	620	510	540	610
P4	180	190	210	170	185	200	150	160	175	125	135	145	145	155	170	135	145	160
	590	620	690	560	610	660	490	520	570	410	445	475	475	510	560	445	475	520
P5	170	185	205	165	175	195	145	155	170	120	130	140	135	145	165	130	140	155
	560	610	670	540	570	640	475	510	560	395	425	460	445	475	540	425	460	510
P6	190	205	230	185	200	220	160	175	190	135	145	160	155	165	185	145	155	175
	620	670	750	610	660	720	520	570	620	445	475	520	510	540	610	475	510	570
P7	180	195	215	175	190	210	150	165	180	125	135	150	145	160	175	140	150	165
	590	640	710	570	620	690	490	540	590	410	445	490	475	520	570	460	490	540
P8	170	180	200	165	175	195	140	155	170	120	125	140	135	145	160	130	140	155
	560	590	660	540	570	640	460	510	560	395	410	460	445	475	520	425	460	510
P11	175	190	210	170	185	200	150	160	175	125	130	145	140	155	170	135	145	160
	570	620	690	560	610	660	490	520	570	410	425	475	460	510	560	445	475	520
P12	115	125	140	110	120	130	95	105	115	—	—	—	95	100	110	85	95	105
	375	410	460	360	395	425	310	345	375	—	—	—	310	330	360	280	310	345
M1	—	—	—	160	170	190	150	160	175	—	—	—	—	—	—	145	150	170
	—	—	—	520	560	620	490	520	570	—	—	—	—	—	—	475	490	560
M2	—	—	—	130	140	160	125	130	145	—	—	—	—	—	—	115	125	140
	—	—	—	425	460	520	410	425	475	—	—	—	—	—	—	375	410	460
M3	—	—	—	110	115	125	100	105	120	—	—	—	—	—	—	95	100	110
	—	—	—	360	375	410	330	345	395	—	—	—	—	—	—	310	330	360
M4	—	—	—	85	90	100	75	85	95	—	—	—	—	—	—	75	80	85
	—	—	—	280	295	330	245	280	310	—	—	—	—	—	—	245	260	280
M5	—	—	—	70	75	85	65	70	75	—	—	—	—	—	—	60	65	70
	—	—	—	230	245	280	215	230	245	—	—	—	—	—	—	195	215	230
K1	185	195	215	175	190	210	155	165	180	125	135	150	145	155	175	140	150	165
	610	640	710	570	620	690	510	540	590	410	445	490	475	510	570	460	490	540
K2	160	175	195	155	165	185	135	145	160	115	120	135	130	140	155	125	135	145
	520	570	640	510	540	610	445	475	520	375	395	445	425	460	510	410	445	475
K3	135	150	165	130	140	160	115	125	135	95	105	115	110	115	130	105	115	125
	445	490	540	425	460	520	375	410	445	310	345	375	360	375	425	345	375	410
K4	130	140	155	125	135	150	110	115	130	90	100	110	105	110	125	100	105	120
	425	460	510	410	445	490	360	375	425	295	330	360	345	360	410	330	345	395
K5	80	85	95	75	85	95	65	70	80	55	60	65	65	70	75	60	65	70
	260	280	310	245	280	310	215	230	260	180	195	215	215	230	245	195	215	230
K6	115	125	140	110	120	135	95	105	115	80	85	95	95	100	110	90	95	105
	375	410	460	360	395	445	310	345	375	260	280	310	310	330	360	295	310	345
K7	105	110	120	100	105	120	85	90	105	70	75	85	80	90	100	80	85	95
	345	360	395	330	345	395	280	295	345	230	245	280	260	295	330	260	280	310
N1	—	—	—	—	—	—	—	—	—	—	—	—	—	—	—	1050	1125	1225
	—	—	—	—	—	—	—	—	—	—	—	—	—	—	—	3450	3700	4025
N2	—	—	—	—	—	—	—	—	—	—	—	—	—	—	—	420	450	495
	—	—	—	—	—	—	—	—	—	—	—	—	—	—	—	1375	1475	1625
N3	—	—	—	—	—	—	—	—	—	—	—	—	—	—	—	280	300	330
	—	—	—	—	—	—	—	—	—	—	—	—	—	—	—	920	980	1075
N11	—	—	—	—	—	—	—	—	—	—	—	—	—	—	—	320	345	380
	—	—	—	—	—	—	—	—	—	—	—	—	—	—	—	1050	1125	1250
S1	—	—	—	40	44	48	36	39	43	—	—	—	36	39	43	34	36	40
	—	—	—	130	145	155	120	130	140	—	—	—	120	130	140	110	120	130
S2	—	—	—	33	35	39	29	31	35	—	—	—	29	31	35	28	29	32
	—	—	—	110	115	130	95	100	115	—	—	—	95	100	115	90	95	105
S3	—	—	—	29	31	34	26	27	30	—	—	—	26	27	30	24	26	28
	—	—	—	95	100	110	85	90	100	—	—	—	85	90	100	80	85	90
S11	—	—	—	55	60	65	50	55	60	—	—	—	50	55	60	48	50	55
	—	—	—	180	195	215	165	180	195	—	—	—	165	180	195	155	165	180
S12	—	—	—	48	50	55	43	45	50	—	—	—	43	45	50	33	36	40
	—	—	—	155	165	180	140	150	165	—	—	—	140	150	165	110	120	130
S13	—	—	—	28	30	33	25	27	30	—	—	—	25	27	30	19	21	23
	—	—	—	90	100	110	80	90	100	—	—	—	80	90	100	60	70	75
H5	38	41	46	34	36	40	32	34	38	27	29	32	31	33	36	29	31	34
	125	135	150	110	120	130	105	110	125	90	95	105	100	110	120	95	100	110
H8	42	44	49	36	38	42	35	37	40	29	31	34	33	35	39	31	33	36
	140	145	160	120	125	140	115	120	130	95	100	110	110	115	130	100	110	120
H11	49	50	60	43	45	50	41	44	48	34	37	41	39	42	46	37	40	44
	160	165	195	140	150	165	135	145	155	110	120	135	130	140	150	120	130	145
H12	49	50	55	42	45	49	40	43	47	34	37	40	38	41	45	36	38	42
	160	165	180	140	150	160	130	140	155	110	120	130	125	135	150	120	125	140
H21	42	44	49	36	38	42	35	37	40	29	31	34	33	35	39	31	33	36
	140	145	160	120	125	140	115	120	130	95	100	110	110	115	130	100	110	120

335.25 Round 20 – Cutting data $v_c = (m/min)/(sf/min)$

SMG	F40M			MK2050			MM4500			MS2050			MS2500			T25M		
	30%	20%	10%	30%	20%	10%	30%	20%	10%	30%	20%	10%	30%	20%	10%	30%	20%	10%
P1	195	205	225	225	240	270	155	165	185	210	225	250	250	265	300	210	225	250
	640	670	740	740	790	890	510	540	610	690	740	820	820	870	980	690	740	820
P2	190	200	220	220	235	260	150	160	180	205	220	240	240	260	285	205	220	240
	620	660	720	720	770	850	490	520	590	670	720	790	790	850	940	670	720	790
P3	160	175	190	190	205	225	130	140	155	175	190	210	210	225	250	175	190	210
	520	570	620	620	670	740	425	460	510	570	620	690	690	740	820	570	620	690
P4	145	155	170	170	180	200	115	125	135	160	170	185	190	200	225	160	170	185
	475	510	560	560	590	660	375	410	445	520	560	610	620	660	740	520	560	610
P5	140	145	165	160	175	195	110	120	135	150	160	180	180	190	215	150	160	180
	460	475	540	520	570	640	360	395	445	490	520	590	590	620	710	490	520	590
P6	155	165	185	180	200	215	125	135	150	170	180	205	200	220	240	170	180	205
	510	540	610	590	660	710	410	445	490	560	590	670	660	720	790	560	590	670
P7	145	155	175	170	185	205	120	125	140	160	170	190	190	205	225	160	170	190
	475	510	570	560	610	670	395	410	460	520	560	620	620	670	740	520	560	620
P8	135	145	160	160	175	190	110	120	130	150	160	180	175	190	210	150	160	180
	445	475	520	520	570	620	360	395	425	490	520	590	570	620	690	490	520	590
P11	140	150	170	165	180	200	115	120	135	155	165	185	185	200	220	155	165	185
	460	490	560	540	590	660	375	395	445	510	540	610	610	660	720	510	540	610
P12	90	100	110	110	120	130	75	80	90	100	110	120	120	130	145	100	110	120
	295	330	360	360	395	425	245	260	295	330	360	395	395	425	475	330	360	395
M1	150	160	175	—	—	—	130	140	155	165	175	195	175	185	205	165	175	195
	490	520	570	—	—	—	425	460	510	540	570	640	570	610	670	540	570	640
M2	125	130	150	—	—	—	105	115	130	135	145	165	145	155	170	135	145	165
	410	425	490	—	—	—	345	375	425	445	475	540	475	510	560	445	475	540
M3	100	105	115	—	—	—	85	95	100	110	120	130	115	125	140	110	120	130
	330	345	375	—	—	—	280	310	330	360	395	425	375	410	460	360	395	425
M4	80	85	90	—	—	—	65	70	80	85	90	100	90	95	110	85	90	100
	260	280	295	—	—	—	215	230	260	280	295	330	295	310	360	280	295	330
M5	65	70	75	—	—	—	55	60	65	70	75	85	75	80	90	70	75	85
	215	230	245	—	—	—	180	195	215	230	245	280	245	260	295	230	245	280
K1	150	155	175	235	250	280	—	—	—	—	—	—	—	—	—	—	—	—
	490	510	570	770	820	920	—	—	—	—	—	—	—	—	—	—	—	—
K2	130	140	155	210	225	250	—	—	—	—	—	—	—	—	—	—	—	—
	425	460	510	690	740	820	—	—	—	—	—	—	—	—	—	—	—	—
K3	110	120	130	175	190	210	—	—	—	—	—	—	—	—	—	—	—	—
	360	395	425	570	620	690	—	—	—	—	—	—	—	—	—	—	—	—
K4	105	115	125	170	180	200	—	—	—	—	—	—	—	—	—	—	—	—
	345	375	410	560	590	660	—	—	—	—	—	—	—	—	—	—	—	—
K5	65	70	75	105	110	125	—	—	—	—	—	—	—	—	—	—	—	—
	215	230	245	345	360	410	—	—	—	—	—	—	—	—	—	—	—	—
K6	95	100	110	150	160	180	—	—	—	—	—	—	—	—	—	—	—	—
	310	330	360	490	520	590	—	—	—	—	—	—	—	—	—	—	—	—
K7	85	90	100	130	145	160	—	—	—	—	—	—	—	—	—	—	—	—
	280	295	330	425	475	520	—	—	—	—	—	—	—	—	—	—	—	—
N1	1100	1175	1300	—	—	—	—	—	—	—	—	—	—	—	—	—	—	—
	3600	3850	4275	—	—	—	—	—	—	—	—	—	—	—	—	—	—	—
N2	440	470	520	—	—	—	—	—	—	—	—	—	—	—	—	—	—	—
	1450	1550	1700	—	—	—	—	—	—	—	—	—	—	—	—	—	—	—
N3	295	315	350	—	—	—	—	—	—	—	—	—	—	—	—	—	—	—
	970	1025	1150	—	—	—	—	—	—	—	—	—	—	—	—	—	—	—
N11	335	360	400	—	—	—	—	—	—	—	—	—	—	—	—	—	—	—
	1100	1175	1300	—	—	—	—	—	—	—	—	—	—	—	—	—	—	—
S1	36	39	43	—	—	—	21	22	24	40	43	47	45	47	55	—	—	—
	120	130	140	—	—	—	70	70	80	130	140	155	150	155	180	—	—	—
S2	29	31	35	—	—	—	17	18	20	32	34	38	36	38	42	—	—	—
	95	100	115	—	—	—	55	60	65	105	110	125	120	125	140	—	—	—
S3	26	27	30	—	—	—	15	15	17	28	30	33	32	33	37	—	—	—
	85	90	100	—	—	—	49	49	55	90	100	110	105	110	120	—	—	—
S11	50	55	60	—	—	—	29	31	34	55	60	65	60	65	75	—	—	—
	165	180	195	—	—	—	95	100	110	180	195	215	195	215	245	—	—	—
S12	43	46	50	—	—	—	26	28	31	47	50	55	50	55	60	—	—	—
	140	150	165	—	—	—	85	90	100	155	165	180	165	180	195	—	—	—
S13	25	26	29	—	—	—	15	16	18	27	29	32	31	32	36	—	—	—
	80	85	95	—	—	—	49	50	60	90	95	105	100	105	120	—	—	—
H5	31	33	36	—	—	—	—	—	—	—	—	—	—	—	—	—	—	—
	100	110	120	—	—	—	—	—	—	—	—	—	—	—	—	—	—	—
H8	32	35	38	—	—	—	—	—	—	—	—	—	—	—	—	—	—	—
	105	115	125	—	—	—	—	—	—	—	—	—	—	—	—	—	—	—
H11	39	41	46	—	—	—	—	—	—	—	—	—	—	—	—	—	—	—
	130	135	150	—	—	—	—	—	—	—	—	—	—	—	—	—	—	—
H12	38	40	45	—	—	—	—	—	—	—	—	—	—	—	—	—	—	—
	125	130	150	—	—	—	—	—	—	—	—	—	—	—	—	—	—	—
H21	32	35	38	—	—	—	—	—	—	—	—	—	—	—	—	—	—	—
	105	115	125	—	—	—	—	—	—	—	—	—	—	—	—	—	—	—

Square shoulder and slot milling cutters
Helical milling cutters
Face milling cutters
Disc milling cutters
High feed milling cutters
Copy milling cutters
Plunge milling cutters
Chamfer milling cutters
Spot facing cutters
Inserts

Square shoulder and
slot milling cutters

Helical milling cutters

Face milling cutters

Disc milling cutters

High feed milling
cutters

Copy milling cutters

Plunge milling cutters

Chamfer milling cutters

Spot facing cutters

Inserts



335.16

Free-cutting and reliable disc milling cutter system dedicated for T-shape slotting

- Width of cut 10.91 -21 mm (.387 - .823 inch)
- Cutter range diameter 25-50 mm (0.969 - 1.844 inch)
- Weldon connection, with through coolant capability for reliable chips evacuation
- Economical solution with 4 cutting edges per insert

R335.16 – Metric

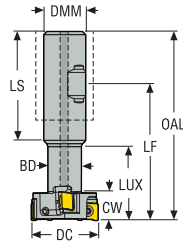

- For insert selection and cutting data recommendations, see page(s) 503-508
- For complete insert programme, see page(s) 834, 861
- For ISO attribute explanation, see page 16

Designation	Item number	Type of mounting	DC	CW	ZNP	ZEFP	DMM	LS	LF	LUX	BD	OAL	RPMX	Weight	Insert
			mm	mm			mm	mm	mm	mm	mm	mm		kg	
R335.16-1625.3-11.2NA	02980627	Weldon	25,0	10,91	4	2	16,0	49,0	56,0	28.38	12,0	80,0	24500	0,2	SPMX07..
R335.16-2032.3-14.2NA	02980628	Weldon	32,0	13,91	4	2	20,0	52,0	65,0	35.38	16,0	90,0	17600	0,2	LNK.08..
R335.16-2540.3-18.2NA	02980629	Weldon	40,0	17,91	5	2	25,0	58,0	73,0	43.67	20,0	105,0	14600	0,4	LNK.08..
R335.16-3250.3-21.2NA	02980630	Weldon	50,0	21,0	6	2	32,0	61,0	84,0	55.17	26,0	120,0	9800	0,7	LNK.08..

Spare Parts, included in delivery

Accessories

For cutter	Insert key	Insert screw	Insert clamping torque	Torque key
∅ 25	H4B-T07P	C02506-T07P	1.2NM	T00-07P12
∅ 32-50	H4B-T09P	C73007-T09P	2.0NM	T00-09P20

For best result it is recommended to let a stock allowance when machining the T-slot shank passage H = min 20% of the CW at the bottom of the T-slot. H = 0.2 x CW
Torque and fixed keys, see page 894

Square shoulder and slot milling cutters

Helical milling cutters

Face milling cutters

Disc milling cutters

High feed milling cutters

Copy milling cutters

Plunge milling cutters

Chamfer milling cutters

Spot facing cutters

Inserts

R335.16 – inch

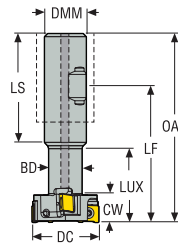









- For insert selection and cutting data recommendations, see page(s) 503-508
- For complete insert programme, see page(s) 834, 861
- For ISO attribute explanation, see page 16

Designation	Item number	Type of mounting	DC	CW	ZNP	ZEFP	DMM	LS	LF	LUX	BD	OAL	RPMX	Weight	Insert
			inch	inch			inch	inch	inch	inch	inch	inch		lbs	
R335.16-00.97-3-0.39-2NA	02980638	Weldon	0.969	0.387	4	2	0.750	2.307	2.528	1.063	0.453	3.543	24500	0.440	SPMX06..
R335.16-01.25-3-0.48-2NA	02980639	Weldon	1.249	0.477	4	2	1.000	2.539	2.796	1.256	0.656	3.937	17600	0.880	LNK.08..
R335.16-01.47-3-0.63-2NA	02980640	Weldon	1.469	0.626	5	2	1.000	2.539	3.190	1.633	0.748	4.331	14600	0.880	LNK.08..
R335.16-01.84-3-0.83-2NA	02980641	Weldon	1.844	0.823	6	2	1.250	2.697	3.978	2.264	1.000	5.118	9800	1.760	LNK.08..

Spare Parts, included in delivery

Accessories

For cutter	Insert key	Insert screw	Insert clamping torque	Torque key
∅ 0.97	 H4B-T07P	 C02205-T07P	 8.0IN.LBS	 T00-07P09
∅ 1.25-1.84	 H4B-T09P	 C73007-T09P	 17.7IN.LBS	 T00-09P20

For best result it is recommended to let a stock allowance when machining the T-slot shank passage $H = \min 20\%$ of the CW at the bottom of the T-slot. $H = 0.2 \times CW$
Torque and fixed keys, see page 894

335.16 - SP06 – Insert selection – mm/Inch

SMG		f _z		
		100%	20%	10%
P1	SPMX060204-75 F40M	0,070 0.0028	0,090 0.0036	0,12 0.0048
P2	SPMX060204-75 F40M	0,070 0.0028	0,090 0.0036	0,12 0.0048
P3	SPMX060204-75 F40M	0,070 0.0028	0,085 0.0034	0,11 0.0044
P4	SPMX060204-75 F40M	0,065 0.0026	0,085 0.0034	0,11 0.0044
P5	SPMX060204-75 F40M	0,065 0.0026	0,080 0.0032	0,11 0.0044
P6	SPMX060204-75 F40M	0,065 0.0026	0,080 0.0032	0,11 0.0044
P7	SPMX060204-75 F40M	0,065 0.0026	0,080 0.0032	0,11 0.0044
P8	SPMX060204-75 F40M	0,070 0.0028	0,085 0.0034	0,11 0.0044
P11	SPMX060204-75 F40M	0,065 0.0026	0,080 0.0032	0,11 0.0044
P12	SPMX060204-75 F40M	0,044 0.0017	0,055 0.0022	0,075 0.0030
M1	SPMX060204-75 F40M	0,070 0.0028	0,090 0.0036	0,12 0.0048
M2	SPMX060204-75 F40M	0,065 0.0026	0,080 0.0032	0,11 0.0044
M3	SPMX060204-75 F40M	0,050 0.0020	0,065 0.0026	0,085 0.0034
M4	SPMX060204-75 F40M	0,046 0.0018	0,055 0.0022	0,075 0.0030
M5	SPMX060204-75 F40M	0,046 0.0018	0,055 0.0022	0,075 0.0030
K1	SPMX060204-75 F40M	0,070 0.0028	0,090 0.0036	0,12 0.0048
K2	SPMX060204-75 F40M	0,065 0.0026	0,080 0.0032	0,11 0.0044
K3	SPMX060204-75 F40M	0,065 0.0026	0,080 0.0032	0,11 0.0044
K4	SPMX060204-75 F40M	0,065 0.0026	0,080 0.0032	0,11 0.0044
K5	SPMX060204-75 F40M	0,060 0.0024	0,075 0.0030	0,10 0.0040
K6	SPMX060204-75 F40M	0,065 0.0026	0,080 0.0032	0,11 0.0044
K7	SPMX060204-75 F40M	0,060 0.0024	0,075 0.0030	0,10 0.0040
N1	SPMX060204-75 F40M	0,090 0.0036	0,11 0.0044	0,15 0.0060
N2	SPMX060204-75 F40M	0,090 0.0036	0,11 0.0044	0,15 0.0060
N3	SPMX060204-75 F40M	0,090 0.0036	0,11 0.0044	0,15 0.0060
N11	SPMX060204-75 F40M	0,090 0.0036	0,11 0.0044	0,15 0.0060
S1	SPMX060204-75 F40M	0,046 0.0018	0,055 0.0022	0,075 0.0030
S2	SPMX060204-75 F40M	0,046 0.0018	0,055 0.0022	0,075 0.0030
S3	SPMX060204-75 F40M	0,042 0.0017	0,055 0.0022	0,070 0.0028
S11	SPMX060204-75 F40M	0,050 0.0020	0,065 0.0026	0,085 0.0034
S12	SPMX060204-75 F40M	0,050 0.0020	0,065 0.0026	0,085 0.0034
S13	SPMX060204-75 F40M	0,046 0.0018	0,055 0.0022	0,075 0.0030
H5	SPMX060204-75 F40M	0,044 0.0017	0,055 0.0022	0,075 0.0030
H8	SPMX060204-75 F40M	0,034 0.0013	0,042 0.0017	0,055 0.0022
H11	SPMX060204-75 F40M	0,044 0.0017	0,055 0.0022	0,075 0.0030
H12	SPMX060204-75 F40M	0,034 0.0013	0,042 0.0017	0,055 0.0022
H21	SPMX060204-75 F40M	0,034 0.0013	0,042 0.0017	0,055 0.0022

SMG = Seco material group
 f_z = mm/tooth (in/tooth), v_c = m/min (sf/min), a_p/DC = %
 All cutting data are start values

Square shoulder and slot milling cutters
 Helical milling cutters
 Face milling cutters
 Disc milling cutters
 High feed milling cutters
 Copy milling cutters
 Plunge milling cutters
 Chamfer milling cutters
 Spot facing cutters
 Inserts

335.16 - SP06 – Cutting data $v_c = (m/min)/(sf/min)$

	SMG	F40M			T25M		
		100%	20%	10%	100%	20%	10%
Square shoulder and slot milling cutters	P1	190	270	295	210	295	325
		620	890	970	690	970	1075
Helical milling cutters	P2	185	260	290	205	290	320
		610	850	950	670	950	1050
Face milling cutters	P3	160	230	255	175	250	280
		520	750	840	570	820	920
Disc milling cutters	P4	145	200	225	160	220	245
		475	660	740	520	720	800
High feed milling cutters	P5	140	195	215	150	215	235
		460	640	710	490	710	770
Copy milling cutters	P6	155	220	240	170	240	265
		510	720	790	560	790	870
Plunge milling cutters	P7	145	205	225	160	225	250
		475	670	740	520	740	820
Chamfer milling cutters	P8	135	190	215	150	210	235
		445	620	710	490	690	770
Spot facing cutters	P11	140	200	220	155	220	240
		460	660	720	510	720	790
Inserts	P12	90	125	140	100	140	155
		295	410	460	330	460	510
Face milling cutters	M1	150	210	235	165	230	255
		490	690	770	540	750	840
High feed milling cutters	M2	125	175	190	135	190	210
		410	570	620	445	620	690
Copy milling cutters	M3	100	140	155	110	155	170
		330	460	510	360	510	560
Disc milling cutters	M4	75	105	120	85	120	130
		245	345	395	280	395	425
Plunge milling cutters	M5	65	90	100	70	100	110
		215	295	330	230	330	360
Chamfer milling cutters	K1	150	205	230	165	230	250
		490	670	750	540	750	820
Spot facing cutters	K2	130	185	200	145	205	225
		425	610	660	475	670	740
Face milling cutters	K3	110	155	170	120	170	190
		360	510	560	395	560	620
Copy milling cutters	K4	105	150	165	115	165	180
		345	490	540	375	540	590
High feed milling cutters	K5	65	90	100	70	100	110
		215	295	330	230	330	360
Disc milling cutters	K6	95	130	145	100	145	160
		310	425	475	330	475	520
Chamfer milling cutters	K7	80	115	125	90	125	140
		260	375	410	295	410	460
Plunge milling cutters	N1	1100	1575	1725	—	—	—
		3600	5175	5650	—	—	—
Chamfer milling cutters	N2	445	630	700	—	—	—
		1450	2075	2300	—	—	—
Spot facing cutters	N3	295	420	465	—	—	—
		970	1375	1525	—	—	—
Face milling cutters	N11	340	480	530	—	—	—
		1125	1575	1750	—	—	—
Chamfer milling cutters	S1	36	50	55	—	—	—
		120	165	180	—	—	—
Spot facing cutters	S2	29	40	44	—	—	—
		95	130	145	—	—	—
Chamfer milling cutters	S3	25	35	39	—	—	—
		80	115	130	—	—	—
Face milling cutters	S11	50	70	80	—	—	—
		165	230	260	—	—	—
Spot facing cutters	S12	42	60	65	—	—	—
		140	195	215	—	—	—
Chamfer milling cutters	S13	24	34	38	—	—	—
		80	110	125	—	—	—
Spot facing cutters	H5	30	42	46	—	—	—
		100	140	150	—	—	—
Face milling cutters	H8	32	44	49	—	—	—
		105	145	160	—	—	—
Inserts	H11	38	55	60	—	—	—
		125	180	195	—	—	—
Spot facing cutters	H12	37	50	55	—	—	—
		120	165	180	—	—	—
Face milling cutters	H21	32	44	49	—	—	—
		105	145	160	—	—	—

335.16 - SP07 – Insert selection – mm/Inch

SMG		f _z		
		100%	20%	10%
P1	SPMX070304-75 F40M	0,085	0,11	0,14
		0.0034	0.0044	0.0055
P2	SPMX070304-75 F40M	0,085	0,11	0,14
		0.0034	0.0044	0.0055
P3	SPMX070304-75 F40M	0,080	0,10	0,14
		0.0032	0.0040	0.0055
P4	SPMX070304-75 F40M	0,080	0,10	0,13
		0.0032	0.0040	0.0050
P5	SPMX070304-75 F40M	0,080	0,10	0,13
		0.0032	0.0040	0.0050
P6	SPMX070304-75 F40M	0,075	0,095	0,13
		0.0030	0.0038	0.0050
P7	SPMX070304-75 F40M	0,075	0,095	0,13
		0.0030	0.0038	0.0050
P8	SPMX070304-75 F40M	0,080	0,10	0,14
		0.0032	0.0040	0.0055
P11	SPMX070304-75 F40M	0,075	0,095	0,13
		0.0030	0.0038	0.0050
P12	SPMX070304-75 F40M	0,055	0,065	0,090
		0.0022	0.0026	0.0036
M1	SPMX070304-75 F40M	0,085	0,11	0,14
		0.0034	0.0044	0.0055
M2	SPMX070304-75 F40M	0,080	0,10	0,13
		0.0032	0.0040	0.0050
M3	SPMX070304-75 F40M	0,060	0,080	0,10
		0.0024	0.0032	0.0040
M4	SPMX070304-75 F40M	0,055	0,070	0,090
		0.0022	0.0028	0.0036
M5	SPMX070304-75 F40M	0,055	0,070	0,090
		0.0022	0.0028	0.0036
K1	SPMX070304-75 F40M	0,085	0,11	0,14
		0.0034	0.0044	0.0055
K2	SPMX070304-75 F40M	0,080	0,10	0,13
		0.0032	0.0040	0.0050
K3	SPMX070304-75 F40M	0,080	0,10	0,13
		0.0032	0.0040	0.0050
K4	SPMX070304-75 F40M	0,080	0,10	0,13
		0.0032	0.0040	0.0050
K5	SPMX070304-75 F40M	0,070	0,090	0,12
		0.0028	0.0036	0.0048
K6	SPMX070304-75 F40M	0,080	0,10	0,13
		0.0032	0.0040	0.0050
K7	SPMX070304-75 F40M	0,070	0,090	0,12
		0.0028	0.0036	0.0048
N1	SPMX070304-75 F40M	0,11	0,14	0,18
		0.0044	0.0055	0.0070
N2	SPMX070304-75 F40M	0,11	0,14	0,18
		0.0044	0.0055	0.0070
N3	SPMX070304-75 F40M	0,11	0,14	0,18
		0.0044	0.0055	0.0070
N11	SPMX070304-75 F40M	0,11	0,14	0,18
		0.0044	0.0055	0.0070
S1	SPMX070304-75 F40M	0,055	0,070	0,090
		0.0022	0.0028	0.0036
S2	SPMX070304-75 F40M	0,050	0,065	0,085
		0.0020	0.0026	0.0034
S3	SPMX070304-75 F40M	0,060	0,080	0,10
		0.0024	0.0032	0.0040
S11	SPMX070304-75 F40M	0,060	0,080	0,10
		0.0024	0.0032	0.0040
S12	SPMX070304-75 F40M	0,055	0,070	0,090
		0.0022	0.0028	0.0036
S13	SPMX070304-75 F40M	0,055	0,065	0,090
		0.0022	0.0026	0.0036
H5	SPMX070304-75 F40M	0,040	0,050	0,070
		0.0016	0.0020	0.0028
H8	SPMX070304-75 F40M	0,055	0,065	0,090
		0.0022	0.0026	0.0036
H11	SPMX070304-75 F40M	0,040	0,050	0,070
		0.0016	0.0020	0.0028
H12	SPMX070304-75 F40M	0,040	0,050	0,070
		0.0016	0.0020	0.0028
H21	SPMX070304-75 F40M	0,040	0,050	0,070
		0.0016	0.0020	0.0028

SMG = Seco material group
 f_z = mm/tooth (in/tooth), v_c = m/min (sf/min), a_p/DC = %
 All cutting data are start values

Square shoulder and slot milling cutters
 Helical milling cutters
 Face milling cutters
 Disc milling cutters
 High feed milling cutters
 Copy milling cutters
 Plunge milling cutters
 Chamfer milling cutters
 Spot facing cutters
 Inserts

335.16 - SP07 – Cutting data $v_c = (m/min)/(sf/min)$

	SMG	F40M			T25M		
		100%	20%	10%	100%	20%	10%
Square shoulder and slot milling cutters	P1	175	250	275	195	275	305
		570	820	900	640	900	1000
Helical milling cutters	P2	170	240	270	190	265	295
		560	790	890	620	870	970
Face milling cutters	P3	150	210	230	165	235	255
		490	690	750	540	770	840
Face milling cutters	P4	130	185	210	145	205	230
		425	610	690	475	670	750
Face milling cutters	P5	125	180	200	140	195	220
		410	590	660	460	640	720
Face milling cutters	P6	145	205	225	160	225	245
		475	670	740	520	740	800
Face milling cutters	P7	135	190	210	150	210	230
		445	620	690	490	690	750
Face milling cutters	P8	125	180	195	140	195	215
		410	590	640	460	640	710
Face milling cutters	P11	130	185	205	145	205	225
		425	610	670	475	670	740
Face milling cutters	P12	85	120	130	90	130	145
		280	395	425	295	425	475
Disc milling cutters	M1	140	195	215	155	215	240
		460	640	710	510	710	790
Disc milling cutters	M2	115	160	180	125	175	195
		375	520	590	410	570	640
Disc milling cutters	M3	95	130	145	100	140	160
		310	425	475	330	460	520
Disc milling cutters	M4	70	100	110	80	110	120
		230	330	360	260	360	395
Disc milling cutters	M5	60	85	90	65	90	100
		195	280	295	215	295	330
High feed milling cutters	K1	135	190	215	150	210	235
		445	620	710	490	690	770
High feed milling cutters	K2	120	170	190	130	185	205
		395	560	620	425	610	670
High feed milling cutters	K3	100	145	160	110	160	175
		330	475	520	360	520	570
High feed milling cutters	K4	95	135	150	105	150	165
		310	445	490	345	490	540
High feed milling cutters	K5	60	85	90	65	90	100
		195	280	295	215	295	330
High feed milling cutters	K6	85	120	135	95	135	145
		280	395	445	310	445	475
High feed milling cutters	K7	75	105	120	85	115	130
		245	345	395	280	375	425
Plunge milling cutters	N1	1000	1425	1600	—	—	—
		3275	4675	5250	—	—	—
Plunge milling cutters	N2	405	570	640	—	—	—
		1325	1875	2100	—	—	—
Plunge milling cutters	N3	270	385	430	—	—	—
		890	1275	1400	—	—	—
Plunge milling cutters	N11	310	440	490	—	—	—
		1025	1450	1600	—	—	—
Chamfer milling cutters	S1	33	46	50	—	—	—
		110	150	165	—	—	—
Chamfer milling cutters	S2	27	37	41	—	—	—
		90	120	135	—	—	—
Chamfer milling cutters	S3	23	33	36	—	—	—
		75	110	120	—	—	—
Chamfer milling cutters	S11	47	65	75	—	—	—
		155	215	245	—	—	—
Chamfer milling cutters	S12	39	55	60	—	—	—
		130	180	195	—	—	—
Chamfer milling cutters	S13	23	32	35	—	—	—
		75	105	115	—	—	—
Spot facing cutters	H5	28	39	43	—	—	—
		90	130	140	—	—	—
Spot facing cutters	H8	30	41	45	—	—	—
		100	135	150	—	—	—
Inserts	H11	35	50	55	—	—	—
		115	165	180	—	—	—
Inserts	H12	34	48	55	—	—	—
		110	155	180	—	—	—
Inserts	H21	30	41	45	—	—	—
		100	135	150	—	—	—

335.16 -LNK – Insert selection – mm/Inch

SMG		f _z		
		100%	20%	10%
P1	LNKT080508PPTN-M06 F40M	0,11 0.0044	0,14 0.0055	0,19 0.0075
P2	LNKT080508PPTN-M06 F40M	0,11 0.0044	0,14 0.0055	0,19 0.0075
P3	LNKT080508PPTN-M06 F40M	0,11 0.0044	0,14 0.0055	0,18 0.0070
P4	LNKT080508PPTN-M06 F40M	0,11 0.0044	0,13 0.0050	0,18 0.0070
P5	LNKT080508PPTN-M06 F40M	0,10 0.0040	0,13 0.0050	0,17 0.0065
P6	LNKT080508PPTN-M06 F40M	0,10 0.0040	0,13 0.0050	0,17 0.0065
P7	LNKT080508PPTN-M06 F40M	0,10 0.0040	0,13 0.0050	0,17 0.0065
P8	LNKT080508PPTN-M06 MP3000	0,11 0.0044	0,14 0.0055	0,18 0.0070
P11	LNKT080508PPTN-M06 F40M	0,10 0.0040	0,13 0.0050	0,17 0.0065
P12	LNKT080508PPTN-M06 F40M	0,070 0.0028	0,090 0.0036	0,12 0.0048
M1	LNKT080508PPTN-M06 F40M	0,11 0.0044	0,14 0.0055	0,19 0.0075
M2	LNKT080508PPTN-M06 F40M	0,10 0.0040	0,13 0.0050	0,17 0.0065
M3	LNKT080508PPTN-M06 F40M	0,085 0.0034	0,10 0.0040	0,14 0.0055
M4	LNKT080508PPTN-M06 F40M	0,075 0.0030	0,090 0.0036	0,12 0.0048
M5	LNKT080508PPTN-M06 F40M	0,075 0.0030	0,090 0.0036	0,12 0.0048
K1	LNKT080508PPTN-M06 MK2050	0,11 0.0044	0,14 0.0055	0,19 0.0075
K2	LNKT080508PPTN-M06 MK2050	0,10 0.0040	0,13 0.0050	0,17 0.0065
K3	LNKT080508PPTN-M06 MK2050	0,10 0.0040	0,13 0.0050	0,17 0.0065
K4	LNKT080508PPTN-M06 MK2050	0,10 0.0040	0,13 0.0050	0,17 0.0065
K5	LNKT080508PPTN-M06 MK2050	0,095 0.0038	0,12 0.0048	0,16 0.0065
K6	LNKT080508PPTN-M06 MK2050	0,10 0.0040	0,13 0.0050	0,17 0.0065
K7	LNKT080508PPTN-M06 MK2050	0,095 0.0038	0,12 0.0048	0,16 0.0065
N1	LNKT080508PPN-E05 H25	0,13 0.0050	0,16 0.0065	0,22 0.0085
N2	LNKT080508PPN-E05 H25	0,13 0.0050	0,16 0.0065	0,22 0.0085
N3	LNKT080508PPN-E05 H25	0,13 0.0050	0,16 0.0065	0,22 0.0085
N11	LNKT080508PPN-E05 H25	0,13 0.0050	0,16 0.0065	0,22 0.0085
S1	LNKT080508PPTN-M06 F40M	0,075 0.0030	0,090 0.0036	0,12 0.0048
S2	LNKT080508PPTN-M06 F40M	0,075 0.0030	0,090 0.0036	0,12 0.0048
S3	LNKT080508PPTN-M06 F40M	0,070 0.0028	0,085 0.0034	0,11 0.0044
S11	LNKT080508PPTN-M06 F40M	0,085 0.0034	0,10 0.0040	0,14 0.0055
S12	LNKT080508PPTN-M06 F40M	0,085 0.0034	0,10 0.0040	0,14 0.0055
S13	LNKT080508PPTN-M06 F40M	0,075 0.0030	0,090 0.0036	0,12 0.0048
H5	LNKT080508PPTN-M06 MP3000	0,070 0.0028	0,090 0.0036	0,12 0.0048
H8	LNKT080508PPTN-M06 MP3000	0,055 0.0022	0,070 0.0028	0,090 0.0036
H11	LNKT080508PPTN-M06 F40M	0,070 0.0028	0,090 0.0036	0,12 0.0048
H12	LNKT080508PPTN-M06 F40M	0,055 0.0022	0,070 0.0028	0,090 0.0036
H21	LNKT080508PPTN-M06 MP3000	0,055 0.0022	0,070 0.0028	0,090 0.0036

SMG = Seco material group
 f_z = mm/tooth (in/tooth), v_c = m/min (sf/min), a_p/DC = %
 All cutting data are start values

Square shoulder and slot milling cutters
 Helical milling cutters
 Face milling cutters
 Disc milling cutters
 High feed milling cutters
 Copy milling cutters
 Plunge milling cutters
 Chamfer milling cutters
 Spot facing cutters
 Inserts

335.16 -LNK – Cutting data $v_c = (m/min)/(sf/min)$

SMG	MP2501			MP3000			T350M			F40M			MK1500			MK2050			H25		
	100%	20%	10%	100%	20%	10%	100%	20%	10%	100%	20%	10%	100%	20%	10%	100%	20%	10%	100%	20%	10%
P1	200	285	315	190	270	300	175	250	275	155	215	240	—	—	—	200	280	310	—	—	—
	660	940	1025	620	890	980	570	820	900	510	710	790	—	—	—	660	920	1025	—	—	—
P2	195	275	305	185	265	290	170	240	265	150	210	230	—	—	—	195	275	300	—	—	—
	640	900	1000	610	870	950	560	790	870	490	690	750	—	—	—	640	900	980	—	—	—
P3	170	240	265	160	225	255	150	210	235	130	180	205	—	—	—	165	235	265	—	—	—
	560	790	870	520	740	840	490	690	770	425	590	670	—	—	—	540	770	870	—	—	—
P4	150	215	235	140	205	225	130	185	205	115	165	180	—	—	—	145	210	230	—	—	—
	490	710	770	460	670	740	425	610	670	375	540	590	—	—	—	475	690	750	—	—	—
P5	145	205	225	140	195	215	125	180	200	110	155	175	—	—	—	145	200	225	—	—	—
	475	670	740	460	640	710	410	590	660	360	510	570	—	—	—	475	660	740	—	—	—
P6	165	230	255	155	220	245	145	200	225	125	175	195	—	—	—	160	225	250	—	—	—
	540	750	840	510	720	800	475	660	740	410	570	640	—	—	—	520	740	820	—	—	—
P7	155	215	240	145	205	230	135	190	210	115	165	185	—	—	—	155	215	240	—	—	—
	510	710	790	475	670	750	445	620	690	375	540	610	—	—	—	510	710	790	—	—	—
P8	140	200	225	135	190	215	125	175	195	110	150	170	—	—	—	140	200	220	—	—	—
	460	660	740	445	620	710	410	570	640	360	490	560	—	—	—	460	660	720	—	—	—
P11	150	210	235	145	200	220	130	185	205	115	160	180	—	—	—	150	210	230	—	—	—
	490	690	770	475	660	720	425	610	670	375	520	590	—	—	—	490	690	750	—	—	—
P12	95	135	150	90	130	140	85	120	130	75	105	115	—	—	—	95	135	150	—	—	—
	310	445	490	295	425	460	280	395	425	245	345	375	—	—	—	310	445	490	—	—	—
M1	140	200	220	140	195	215	130	185	205	120	170	185	—	—	—	—	—	—	—	—	—
	460	660	720	460	640	710	425	610	670	395	560	610	—	—	—	—	—	—	—	—	—
M2	115	165	180	115	160	180	110	155	170	100	140	155	—	—	—	—	—	—	—	—	—
	375	540	590	375	520	590	360	510	560	330	460	510	—	—	—	—	—	—	—	—	—
M3	95	135	145	90	130	145	85	125	135	80	115	125	—	—	—	—	—	—	—	—	—
	310	445	475	295	425	475	280	410	445	260	375	410	—	—	—	—	—	—	—	—	—
M4	70	100	115	70	100	110	65	95	105	60	85	95	—	—	—	—	—	—	—	—	—
	230	330	375	230	330	360	215	310	345	195	280	310	—	—	—	—	—	—	—	—	—
M5	60	85	95	60	85	95	55	80	90	50	75	80	—	—	—	—	—	—	—	—	—
	195	280	310	195	280	310	180	260	295	165	245	260	—	—	—	—	—	—	—	—	—
K1	155	220	240	125	175	195	135	190	210	120	165	185	220	310	345	210	295	325	—	—	—
	510	720	790	410	570	640	445	620	690	395	540	610	720	1025	1125	690	970	1075	—	—	—
K2	140	195	215	110	155	170	120	170	190	105	150	165	195	275	305	185	260	290	—	—	—
	460	640	710	360	510	560	395	560	620	345	490	540	640	900	1000	610	850	950	—	—	—
K3	115	165	180	95	130	145	100	145	160	90	125	140	165	235	260	160	220	245	—	—	—
	375	540	590	310	425	475	330	475	520	295	410	460	540	770	850	520	720	800	—	—	—
K4	110	155	175	90	125	140	100	135	150	85	120	135	160	225	250	150	210	235	—	—	—
	360	510	570	295	410	460	330	445	490	280	395	445	520	740	820	490	690	770	—	—	—
K5	65	95	105	55	75	85	60	85	90	50	70	80	95	135	150	90	130	140	—	—	—
	215	310	345	180	245	280	195	280	295	165	230	260	310	445	490	295	425	460	—	—	—
K6	100	140	155	80	110	125	85	120	135	75	105	115	140	195	220	135	185	205	—	—	—
	330	460	510	260	360	410	280	395	445	245	345	375	460	640	720	445	610	670	—	—	—
K7	85	120	135	70	95	110	75	105	120	65	95	100	125	175	190	115	165	180	—	—	—
	280	395	445	230	310	360	245	345	395	215	310	330	410	570	620	375	540	590	—	—	—
N1	—	—	—	1075	1550	1700	—	—	—	860	1225	1375	—	—	—	—	—	—	900	1275	1400
	—	—	—	3525	5075	5575	—	—	—	2825	4025	4500	—	—	—	—	—	—	2950	4175	4600
N2	—	—	—	430	620	690	—	—	—	345	500	550	—	—	—	—	—	—	365	520	570
	—	—	—	1400	2025	2275	—	—	—	1125	1650	1800	—	—	—	—	—	—	1200	1700	1875
N3	—	—	—	290	415	460	—	—	—	230	330	370	—	—	—	—	—	—	240	345	380
	—	—	—	950	1350	1500	—	—	—	750	1075	1225	—	—	—	—	—	—	790	1125	1250
N11	—	—	—	330	475	530	—	—	—	265	380	420	—	—	—	—	—	—	275	395	435
	—	—	—	1075	1550	1750	—	—	—	870	1250	1375	—	—	—	—	—	—	900	1300	1425
S1	35	50	55	33	47	50	31	45	50	29	41	45	—	—	—	—	—	—	—	—	—
	115	165	180	110	155	165	100	150	165	95	135	150	—	—	—	—	—	—	—	—	—
S2	28	40	44	27	38	42	25	36	40	23	33	36	—	—	—	—	—	—	—	—	—
	90	130	145	90	125	140	80	120	130	75	110	120	—	—	—	—	—	—	—	—	—
S3	25	35	39	23	33	37	22	31	35	20	29	32	—	—	—	—	—	—	—	—	—
	80	115	130	75	110	120	70	100	115	65	95	105	—	—	—	—	—	—	—	—	—
S11	49	70	75	46	65	75	44	65	70	40	55	65	—	—	—	—	—	—	—	—	—
	160	230	245	150	215	245	145	215	230	130	180	215	—	—	—	—	—	—	—	—	—
S12	41	60	65	39	55	60	37	55	60	34	48	55	—	—	—	—	—	—	—	—	—
	135	195	215	130	180	195	120	180	195	110	155	180	—	—	—	—	—	—	—	—	—
S13	24	34	38	23	32	36	21	31	34	20	28	31	—	—	—	—	—	—	—	—	—
	80	110	125	75	105	120	70	100	110	65	90	100	—	—	—	—	—	—	—	—	—
H5	29	41	45	26	36	40	28	39	43	24	34	38	—	—	—	—	—	—	—	—	—
	95	135	150	85	120	130	90	130	140	80	110	125	—	—	—	—	—	—	—	—	—
H8	31	43	48	27	38	42	30	41	46	26	36	40	—	—	—	—	—	—	—	—	—
	100	140	155	90	125	140	100	135	150	85	120	130	—	—	—	—	—	—	—	—	—
H11	37	50	55	33	46	50	36	50	55	31	44	48	—	—	—	—	—	—	—	—	—
	120	165	180	110	150	165	120	165	180	100	145	155	—	—	—	—	—	—	—	—	—
H12	36	50	55	31	44	49	34	48	55	30	42	47	—	—	—	—	—	—	—	—	—
	120	165	180	100	145	160	110	155	180	100	140	155	—	—	—	—	—	—	—	—	—
H21	31	43	4																		

Code keys metric and inch

R	217	21	12	25	RE	LP06	4	A
1	2	3	4	5	6	7	8	9

R	217	21	01.00	0	LP06	3	A
1	2	3	5	6	7	8	9

1.	2.	3.
R = Right hand rotation Cx = For Seco-Capto	217 = With shank 220 = For arbor	Cutter system
4. (Not for inch designation)	5.	6.
Connecting diameter	Cutter diameter	Shank type .RE for Combimaster .0 for Cylindrical .3 for Weldon .3S for Seco Weldon
7.	8.	9.
Insert type and size	No. of teeth	A = Through coolant supply E = Solid carbide shank

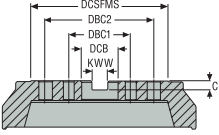

Dimensions in mm					
DCB	DCSFMS	DBC1	DBC2	KWW	C
16	30-35	-	-	8,4	5,6
22	42-47	-	-	10,4	6,3
27	48-62	-	-	12,4	7
32	60-90	-	-	14,4	8
40	90-130	66,7	-	16,4	9
60	130-270	101,6	177,8	25,7	14

Dimensions in inch					
DCB	DCSFMS	DBC1	DBC2	KWW	C
0.500	1.181 - 1.378	-	-	0.258	0.165
0.750	1.378 - 1.850	-	-	0.321	0.193
1.000	1.803 - 2.441	-	-	0.382	0.224
1.250	2.250 - 3.031	-	-	0.508	0.287
1.500	2.750 - 3.543	-	-	0.630	0.382
2.000	4.331	-	-	0.756	0.445
2.500	5.118 - 6.299 (8.858)	4.000	(7.000)	1.000	0.551

For a more exact DCSFMS and DCB measurement, see each product table.

Square shoulder and slot milling cutters

Helical milling cutters

Face milling cutters

Disc milling cutters

High feed milling cutters

Copy milling cutters

Plunge milling cutters

Chamfer milling cutters

Spot facing cutters

Inserts

Selection – Metric

Insert	a _p max	Material suitability									
		P	M	K	N	S	H				
SPKT10 	1,1	■	■	■	□	■	▣	■	▣	■	■
SPKT14 	1,8	■	■	■	□	■	▣	▣	■	■	■
SPKT18 	2,5	■	■	■	□	■	▣	□	■	■	■

1st choice	■	High speed machine with low power/torque Strong stable machine with rigid connection Not recommended	Unstable condition suitability	
Alternative choice	▣		Ramping ability	
Possible choice	□		Plunging ability	

- Square shoulder and slot milling cutters
- Helical milling cutters
- Face milling cutters
- Disc milling cutters
- High feed milling cutters
- Copy milling cutters
- Plunge milling cutters
- Chamfer milling cutters
- Spot facing cutters
- Inserts

Selection – Inch

Insert	a _p max	Material suitability									
		P	M	K	N	S	H				
SPKT10 	0.043	■	■	■	□	■	▣	■	▣	■	■
SPKT14 	0.071	■	■	■	□	■	▣	▣	■	■	■
SPKT18 	0.098	■	■	■	□	■	▣	□	■	■	■

1st choice	■	High speed machine with low power/torque Strong stable machine with rigid connection Not recommended	Unstable condition suitability	
Alternative choice	▣		Ramping ability	
Possible choice	□		Plunging ability	

Square shoulder and slot milling cutters
Helical milling cutters
Face milling cutters
Disc milling cutters
High feed milling cutters
Copy milling cutters
Plunge milling cutters
Chamfer milling cutters
Spot facing cutters
Inserts

Selection – Inch

Insert	No. of cutting edges	Application	Cutter diameter available (inch)/number of teeth													See page	
			0.50	0.625	0.75	1.00	1.25	1.50	2.00	2.50	3.00	3.50	4.00	5.00	6.00		
SPKT10	4						3	4	5	6							519
									6	7							
SPKT14	4								4	5	6		8			524, 525	
									5	6	7						
SPKT18	4										5	5		7	8	10	530
												6					

x	x indicates number of teeth (first choice)
x	x indicates number of teeth



Troubleshooter for unstable fixturing and/or unstable conditions



Basic choice

- Square shoulder and slot milling cutters
- Helical milling cutters
- Face milling cutters
- Disc milling cutters
- High feed milling cutters
- Copy milling cutters
- Plunge milling cutters
- Chamfer milling cutters
- Spot facing cutters
- Inserts

Selection – Metric

Insert	a _p max	Material suitability									
		P	M	K	N	S	H				
LP05 	0,65	■	■	■	□	■	■	■	□	■	■
LP06 	0,8	■	■	■	■	■	■	■	□	■	■
LP09 	1,8	■	■	■	□	■	□	■	■	■	■
LO06 	0,9	■	▣	■	-	■	■	■	▣	▣	▣
218.19-080 	0,6	■	▣	■	■	▣	■	■	▣	■	■
218.19-100 	0,7	■	▣	■	■	▣	■	■	▣	■	■
218.19-125 	1,0	■	▣	■	■	▣	■	▣	■	■	■
218.19-160 	1,8	■	▣	■	■	▣	□	-	■	■	■
218.21-230 	1,8	■	■	■	-	▣	▣	-	■	□	■
SCET 	1,5	■	■	■	-	■	-	-	■	□	■
ON09 	2,0	■	-	■	-	-	-	-	■	-	-

1st choice	■
Alternative choice	▣
Possible choice	□

High speed machine with low power/torque	
Strong stable machine with rigid connection	
Not recommended	

Unstable condition suitability	
Ramping ability	
Plunging ability	

Square shoulder and slot milling cutters
 Helical milling cutters
 Face milling cutters
 Disc milling cutters
 High feed milling cutters
 Copy milling cutters
 Plunge milling cutters
 Chamfer milling cutters
 Spot facing cutters
 Inserts

Selection – Metric

Insert	No. of cutting edges	Application	Cutter diameter (mm) available with effective number of teeth																		See page							
			12	14	16	18	20	25	27	32	35	40	42	50	52	63	66	80	84	88		100	108	125	133	160	168	208
LP05	2				2		3																					
			2	2	3	3	4																					
LP06	2										4																	
						2	3	3	4	5	6																	
LP09	2				2	2	3	4			5	6	7															
									2		4	4	4	4	6	5	6	6	7									
LO06	4												5															
						2	3	3	4	5	6																	
218.19-080	3				2																							
218.19-100	3							2																				
						2	3																					
218.19-125	3										2																	
							2		3	3	4																	
218.19-160	3												3		4													
												2	3	5	5	6	6	7					9					
218.21-230	6												4		5		6	6	7	8		9		10				
												3	3	5	5	6	6	7	8			9						
SCET	4														4	4	5	5		6	6	7	6	7				
																5	5	6	6	7		8						
ON09	16																		6			7	8	10				

x indicates number of teeth (first choice)

x indicates number of teeth

Troubleshooter for unstable fixturing and/or unstable conditions

Basic choice

Square shoulder and slot milling cutters

Helical milling cutters

Face milling cutters

Disc milling cutters

High feed milling cutters

Copy milling cutters

Plunge milling cutters

Chamfer milling cutters

Spot facing cutters

Inserts

Selection – Inch





















Insert	a _p max	Material suitability									
		P	M	K	N	S	H				
LP05 	0.020	■	■	■	□	■	■	■	□	■	■
LP06 	0.031	■	■	■	■	■	■	■	□	■	■
LP09 	0.071	■	■	■	□	■	□	■	■	■	■
LO06 	0.031	■	▣	■	-	■	■	■	▣	▣	▣
218.19-080 	0.025	■	▣	■	■	▣	■	■	▣	■	■
218.19-100 	0.028	■	▣	■	■	▣	■	■	▣	■	■
218.19-125 	0.039	■	▣	■	■	▣	■	▣	■	■	■
218.19-160 	0.071	■	▣	■	■	▣	□	-	■	■	■
218.21-230 	0.071	■	■	■	-	▣	▣	-	■	□	■
SCET 	0.059	■	■	■	-	■	-	-	■	□	■
ON09 	0.079	■	-	■	-	-	-	-	■	-	-

1st choice	■
Alternative choice	▣
Possible choice	□

High speed machine with low power/torque	
Strong stable machine with rigid connection	
Not recommended	

Unstable condition suitability	
Ramping ability	
Plunging ability	

Selection – Inch

Insert	No. of cutting edges	Application	Cutter diameter available (inch)/number of teeth													See page	
			0.50	0.625	0.75	1.00	1.25	1.50	2.00	2.50	3.00	3.50	4.00	5.00	6.00		
LP05	2			2	3											537	
			2	3	4												
LP06	2				2	3	4	6								544	
				2	3	4	5	7									
LP09	2						4	5	6	6	6	8	9		551		
									7	8	8		10				
LO06	4					3	4	5							559		
						4	5	6	8	9							
218.19-080	3			2											579		
218.19-100	3				2	3											
																	
218.19-125	3					2	3	4									
																	
218.19-160	3						2	3	3	5	6		7				
									4	6	7		9				
218.21-230	6							3	4	5	5		7				
									5	6	6	8	9				
SCET	4									4	5		5				
									4	6	6		8				
ON09	16											6		7	8	10	597, 598
																	

x indicates number of teeth (first choice)

x indicates number of teeth

 Troubleshooter for unstable fixturing and/or unstable conditions

 Basic choice

- Square shoulder and slot milling cutters
- Helical milling cutters
- Face milling cutters
- Disc milling cutters
- High feed milling cutters
- Copy milling cutters
- Plunge milling cutters
- Chamfer milling cutters
- Spot facing cutters
- Inserts



HIGH FEED SP

For challenging ISO P, M and S materials, the Seco High Feed SP features a combination of dedicated cutting geometries and insert grades, as well as optimized lead angles, that combine to boost material removal rates, maximize chip evacuation and extend tool life. Packed with versatility, one High Feed SP tool optimizes copy milling, ramping, pocketing, face milling and plunging operations to reduce tooling inventory further. Designed for ease of use, the milling tools provide simple foolproof insert indexing that prevents operator mistakes, unexpected machine downtime and scrapped parts.

- 3 insert sizes, with IC = 10, 14 & 18mm
- 30 items in metric version, Ø32 to Ø160mm
- 19 items in inch version, Ø01.25 to Ø06.00
- Standard and close pitch
- Well proven SPKT inserts with a range of premium Seco grades optimized for tough materials.

R217/220.21-SP10 – Metric

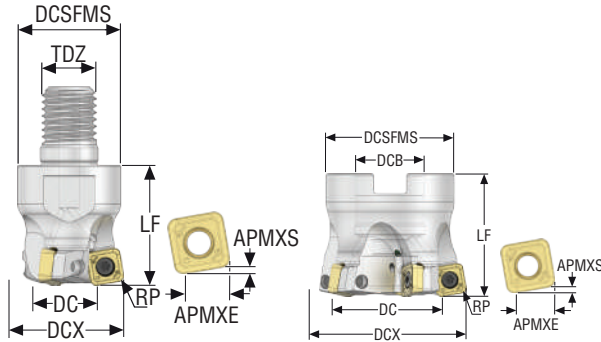



- For insert selection and cutting data recommendations, see page(s) 521-523
- For complete insert programme, see page(s) 860
- For ISO attribute explanation, see page 16

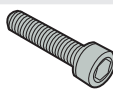

Designation	Item number	Type of mounting	DC	DCX	ZFPP	APMXS	APMXE	DCB	DCSFMS	LF	RP	RMPX°	Cmin	Cmax	Weight	RPMX	Insert
			mm	mm		mm	mm	mm	mm	mm	mm		mm	mm	kg		
R217.21-1632.RE-SP10.3A	10097555	Combimaster	15,7	32,0	3	1,1	7,0	–	30,0	35,0	2,83	4,3	47,7	62,0	0,3	21600	SPKT10T317
R217.21-1635.RE-SP10.3A	10097557	Combimaster	18,7	35,0	3	1,1	7,0	–	30,0	35,0	2,8	3,5	53,7	68,0	0,2	20700	SPKT10T317
R217.21-1635.RE-SP10.4A	10097558	Combimaster	18,7	35,0	4	1,1	7,0	–	30,0	35,0	2,8	3,5	53,7	68,0	0,3	20700	SPKT10T317
R217.21-2040.RE-SP10.4A	10097559	Combimaster	23,7	40,0	4	1,1	7,0	–	36,5	40,0	2,79	2,7	63,7	78,0	0,4	19300	SPKT10T317
R217.21-2040.RE-SP10.5A	10097560	Combimaster	23,7	40,0	5	1,1	7,0	–	36,5	40,0	2,79	2,7	63,7	78,0	0,3	19300	SPKT10T317
R217.21-2042.RE-SP10.4A	10097561	Combimaster	25,7	42,0	4	1,1	7,0	–	36,5	40,0	2,8	2,5	67,7	82,0	0,6	18800	SPKT10T317
R217.21-2042.RE-SP10.5A	10097562	Combimaster	25,7	42,0	5	1,1	7,0	–	36,5	40,0	2,8	2,5	67,7	82,0	0,4	18800	SPKT10T317
R220.21-0050-SP10.5A	10097563	Arbor	33,7	50,0	5	1,1	7,0	22,0	41,0	40,0	2,8	1,9	83,7	98,0	0,4	17300	SPKT10T317
R220.21-0050-SP10.6A	10097564	Arbor	33,7	50,0	6	1,1	7,0	22,0	41,0	40,0	2,8	1,9	83,7	98,0	0,4	17300	SPKT10T317
R220.21-0052-SP10.5A	10097565	Arbor	35,7	52,0	5	1,1	7,0	22,0	49,0	40,0	2,8	1,8	87,7	102,0	0,4	17000	SPKT10T317
R220.21-0052-SP10.6A	10097566	Arbor	35,7	52,0	6	1,1	7,0	22,0	49,0	40,0	2,8	1,8	87,7	102,0	0,6	17000	SPKT10T317
R220.21-0063-SP10.6A	10097567	Arbor	46,7	63,0	6	1,1	7,0	22,0	49,0	40,0	2,8	1,3	109,7	124,0	1,0	15800	SPKT10T317
R220.21-0063-SP10.7A	10097568	Arbor	46,7	63,0	7	1,1	7,0	22,0	49,0	40,0	2,8	1,3	109,7	124,0	1,0	15800	SPKT10T317

For Combimaster Shanks, see Machining Navigator Tooling System

Spare Parts, included in delivery

For cutter	Arbor screw	Insert key	Insert screw
			
R217.21-..	–	H4B-T10P	C03508-T10P
R217.21-2040-2042-4A	–	H4B-T10P	C03509-T10P
R220.21-0050-0063	220.17-692	H4B-T10P	C03509-T10P
R220.21-0050-0052-6A	220.17-692	H4B-T10P	C03508-T10P

Accessories

For cutter	Insert clamping torque	Torque key
		
R217/220.21-..	3.0NM	T00-10P30

Torque and fixed keys, see page 894

R217/220.21-SP10 – Inch

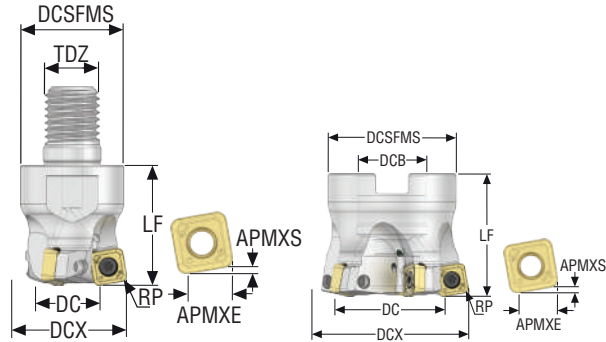
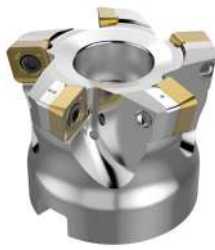

- For insert selection and cutting data recommendations, see page(s) 521-523
- For complete insert programme, see page(s) 860
- For ISO attribute explanation, see page 16

Designation	Item number	Type of mounting	DC	DCX	ZEFP	APMXS	APMXE	DCB	DCSFMS	LF	RP	RMPX°	C min	C max	Weight	RPMX	Insert
			inch	inch		inch	inch	inch	inch	inch	inch		inch	inch	lbs		
R217.21-01.25.16RE-SP10.3A	10097569	Combimaster	0.606	1.250	3	0.043	0.276	-	1.181	1.378	0.111	5,6	1.856	2.421	1.100	21600	SPKT10T317
R217.21-01.50.20RE-SP10.4A	10097571	Combimaster	0.858	1.500	4	0.043	0.276	-	1.437	1.575	0.110	3,0	2.358	2.921	1.100	19300	SPKT10T317
R220.21-02.00-SP10.5A	10128666	Arbor	1.358	2.000	5	0.043	0.276	0.750	1.789	1.500	0.110	1,9	3.358	3.921	0.880	17300	SPKT10T317
R220.21-02.00-SP10.6A	10097573	Arbor	1.358	2.000	6	0.043	0.276	0.750	1.789	1.500	0.110	1,9	3.358	3.921	1.320	17300	SPKT10T317
R220.21-02.50-SP10.6A	10128667	Arbor	1.858	2.500	6	0.043	0.276	0.750	1.789	1.500	0.110	1,3	4.358	4.921	1.100	15800	SPKT10T317
R220.21-02.50-SP10.7A	10097574	Arbor	1.858	2.500	7	0.043	0.276	0.750	1.789	1.500	0.110	1,3	4.358	4.921	1.320	15800	SPKT10T317

For Combimaster Shanks, see Machining Navigator Tooling System

Spare Parts, included in delivery

For cutter	Arbor screw	Insert key	Insert screw
R217.21-..	-	H4B-T10P	C03508-T10P
R220.21-02.00	UC6S3/8UNFX1-1/4	H4B-T10P	C03508-T10P
R220.21-02.50	UC6S3/8UNFX1-1/4	H4B-T10P	C03509-T10P

Accessories

For cutter	Insert clamping torque	Torque key
R217/220.21-..	26.6IN.LBS	T00-10P30

Torque and fixed keys, see page 894

R220.21-SP10 – Insert selection – mm/Inch

SMG		a _p	f _z		
			100%	70%	30%
P1	SPKT10T317TN-M10 MP2501	1,1	0,80	0,80	0,95
		0,044	0,032	0,032	0,038
P2	SPKT10T317TN-M10 MP2501	1,1	0,80	0,80	0,95
		0,044	0,032	0,032	0,038
P3	SPKT10T317TN-M10 MP2501	1,1	0,80	0,80	0,90
		0,044	0,032	0,032	0,036
P4	SPKT10T317TN-M10 MP2501	1,1	0,75	0,75	0,90
		0,044	0,030	0,030	0,036
P5	SPKT10T317TN-M10 MP2501	1,1	0,75	0,75	0,90
		0,044	0,030	0,030	0,036
P6	SPKT10T317TN-M10 MP2501	1,1	0,75	0,75	0,90
		0,044	0,030	0,030	0,036
P7	SPKT10T317TN-MD12 MP2501	1,1	0,90	0,90	1,1
		0,044	0,036	0,036	0,044
P8	SPKT10T317TN-MD12 MP2501	1,1	0,95	0,95	1,1
		0,044	0,038	0,038	0,044
P11	SPKT10T317TN-MD12 MP2501	1,1	0,90	0,90	1,1
		0,044	0,036	0,036	0,044
P12	SPKT10T317TN-M10 MS2500	0,85	0,50	0,50	0,60
		0,034	0,020	0,020	0,024
M1	SPKT10T317TN-M10 MS2050	1,1	0,80	0,80	0,95
		0,044	0,032	0,032	0,038
M2	SPKT10T317TN-M10 MS2050	1,1	0,75	0,75	0,90
		0,044	0,030	0,030	0,036
M3	SPKT10T317TN-M10 MS2050	0,85	0,60	0,60	0,70
		0,034	0,024	0,024	0,028
M4	SPKT10T317TN-M10 F40M	0,85	0,50	0,50	0,60
		0,034	0,020	0,020	0,024
M5	SPKT10T317TN-M10 F40M	0,85	0,50	0,50	0,60
		0,034	0,020	0,020	0,024
K1	SPKT10T317TN-MD12 MK2050	1,1	1,0	1,0	1,2
		0,044	0,040	0,040	0,048
K2	SPKT10T317TN-MD12 MK2050	1,1	0,90	0,90	1,1
		0,044	0,036	0,036	0,044
K3	SPKT10T317TN-MD12 MK2050	1,1	0,90	0,90	1,1
		0,044	0,036	0,036	0,044
K4	SPKT10T317TN-MD12 MK2050	1,1	0,90	0,90	1,1
		0,044	0,036	0,036	0,044
K5	SPKT10T317TN-MD12 MK2050	1,1	0,80	0,80	0,95
		0,044	0,032	0,032	0,038
K6	SPKT10T317TN-MD12 MK2050	1,1	0,90	0,90	1,1
		0,044	0,036	0,036	0,044
K7	SPKT10T317TN-MD12 MK2050	1,1	0,80	0,80	0,95
		0,044	0,032	0,032	0,038
S1	SPKT10T317TN-M10 MS2500	0,85	0,50	0,50	0,60
		0,034	0,020	0,020	0,024
S2	SPKT10T317TN-M10 MS2500	0,85	0,50	0,50	0,60
		0,034	0,020	0,020	0,024
S3	SPKT10T317TN-M10 MS2500	0,85	0,48	0,48	0,55
		0,034	0,019	0,019	0,022
S11	SPKT10T317TN-M10 MS2050	0,85	0,60	0,60	0,70
		0,034	0,024	0,024	0,028
S12	SPKT10T317TN-M10 MS2050	0,85	0,60	0,60	0,70
		0,034	0,024	0,024	0,028
S13	SPKT10T317TN-M10 MS2050	0,85	0,50	0,50	0,60
		0,034	0,020	0,020	0,024
H5	SPKT10T317TN-MD12 MP1501	0,85	0,60	0,60	0,70
		0,034	0,024	0,024	0,028
H8	SPKT10T317TN-MD12 MP1501	0,85	0,46	0,46	0,55
		0,034	0,018	0,018	0,022
H11	SPKT10T317TN-MD12 MP1501	0,85	0,60	0,60	0,70
		0,034	0,024	0,024	0,028
H12	SPKT10T317TN-M10 MS2500	0,85	0,38	0,38	0,46
		0,034	0,015	0,015	0,018

SMG = Seco material group
f_z = mm/tooth (in/tooth), v_c = m/min (sf/min), a_p/DC = %
All cutting data are start values

Square shoulder and slot milling cutters
Helical milling cutters
Face milling cutters
Disc milling cutters
High feed milling cutters
Copy milling cutters
Plunge milling cutters
Chamfer milling cutters
Spot facing cutters
Inserts

R220.21-SP10 – Cutting data $v_c = (m/min)/(sf/min)$

SMG	MP1501			MP2501			MP3000			T350M			F40M		
	100%	70%	30%	100%	70%	30%	100%	70%	30%	100%	70%	30%	100%	70%	30%
P1	325	375	450	320	370	440	270	315	375	280	320	380	240	280	335
	1075	1225	1475	1050	1225	1450	890	1025	1225	920	1050	1250	790	920	1100
P2	310	360	425	310	360	425	260	300	360	270	315	370	235	270	325
	1025	1175	1400	1025	1175	1400	850	980	1175	890	1025	1225	770	890	1075
P3	270	315	375	270	310	375	230	265	315	235	270	325	205	235	285
	890	1025	1225	890	1025	1225	750	870	1025	770	890	1075	670	770	940
P4	245	280	330	240	275	330	205	235	280	210	240	285	180	210	250
	800	920	1075	790	900	1075	670	770	920	690	790	940	590	690	820
P5	230	270	315	230	265	315	195	225	265	200	230	275	175	200	240
	750	890	1025	750	870	1025	640	740	870	660	750	900	570	660	790
P6	260	300	365	255	295	360	220	250	305	225	260	310	195	225	270
	850	980	1200	840	970	1175	720	820	1000	740	850	1025	640	740	890
P7	245	285	345	245	280	335	205	240	290	210	245	295	185	210	255
	800	940	1125	800	920	1100	670	790	950	690	800	970	610	690	840
P8	230	265	315	225	260	315	190	220	265	195	225	275	170	195	240
	750	870	1025	740	850	1025	620	720	870	640	740	900	560	640	790
P11	240	275	335	235	270	330	200	230	280	205	235	285	180	205	250
	790	900	1100	770	890	1075	660	750	920	670	770	940	590	670	820
P12	155	180	215	155	175	210	130	150	180	135	155	185	115	135	160
	510	590	710	510	570	690	425	490	590	445	510	610	375	445	520
M1	—	—	—	225	260	310	195	225	270	210	240	285	190	220	260
	—	—	—	740	850	1025	640	740	890	690	790	940	620	720	850
M2	—	—	—	185	215	250	165	190	220	170	200	235	155	180	215
	—	—	—	610	710	820	540	620	720	560	660	770	510	590	710
M3	—	—	—	145	170	205	130	150	180	135	160	190	125	145	175
	—	—	—	475	560	670	425	490	590	445	520	620	410	475	570
M4	—	—	—	115	135	160	100	115	140	110	125	150	100	115	135
	—	—	—	375	445	520	330	375	460	360	410	490	330	375	445
M5	—	—	—	95	110	135	85	95	115	90	105	125	80	95	115
	—	—	—	310	360	445	280	310	375	295	345	410	260	310	375
K1	245	285	340	245	285	340	205	240	285	215	250	295	185	215	255
	800	940	1125	800	940	1125	670	790	940	710	820	970	610	710	840
K2	220	255	300	220	250	300	185	215	250	190	220	260	165	190	225
	720	840	980	720	820	980	610	710	820	620	720	850	540	620	740
K3	185	215	255	185	210	250	155	180	215	160	185	220	140	160	190
	610	710	840	610	690	820	510	590	710	520	610	720	460	520	620
K4	180	205	240	175	205	240	150	170	205	155	175	210	135	155	180
	590	670	790	570	670	790	490	560	670	510	570	690	445	510	590
K5	110	125	150	110	125	150	90	105	125	95	110	130	80	95	110
	360	410	490	360	410	490	295	345	410	310	360	425	260	310	360
K6	155	180	215	155	180	210	130	150	180	135	155	185	115	135	160
	510	590	710	510	590	690	425	490	590	445	510	610	375	445	520
K7	140	160	190	140	160	190	120	135	160	120	140	165	105	120	145
	460	520	620	460	520	620	395	445	520	395	460	540	345	395	475
S1	—	—	—	55	65	80	47	55	65	50	60	70	46	55	65
	—	—	—	180	215	260	155	180	215	165	195	230	150	180	215
S2	—	—	—	45	50	65	38	43	55	41	47	55	37	43	50
	—	—	—	150	165	215	125	140	180	135	155	180	120	140	165
S3	—	—	—	39	46	55	33	38	46	35	41	49	32	37	45
	—	—	—	130	150	180	110	125	150	115	135	160	105	120	150
S11	—	—	—	80	90	110	65	75	90	70	80	95	65	75	90
	—	—	—	260	295	360	215	245	295	230	260	310	215	245	295
S12	—	—	—	55	60	75	46	55	65	48	55	65	44	50	60
	—	—	—	180	195	245	150	180	215	155	180	215	145	165	195
S13	—	—	—	32	37	44	26	30	37	28	33	39	26	30	36
	—	—	—	105	120	145	85	100	120	90	110	130	85	100	120
H5	50	60	70	46	55	65	41	47	55	44	50	60	38	44	55
	165	195	230	150	180	215	135	155	180	145	165	195	125	145	180
H8	55	65	75	49	55	70	43	50	60	47	55	65	41	47	55
	180	215	245	160	180	230	140	165	195	155	180	215	135	155	180
H11	65	75	90	60	70	80	50	60	70	55	65	80	49	55	70
	215	245	295	195	230	260	165	195	230	180	215	260	160	180	230
H12	100	115	135	95	110	135	85	95	115	85	100	115	75	85	100
	330	375	445	310	360	445	280	310	375	280	330	375	245	280	330
H21	55	65	75	49	55	70	43	50	60	47	55	65	41	47	55
	180	215	245	160	180	230	140	165	195	155	180	215	135	155	180

R220.21-SP10 – Cutting data $v_c = (m/min)/(sf/min)$

SMG	MM4500			MK2050			MS2050			MS2500			MP2050		
	100%	70%	30%	100%	70%	30%	100%	70%	30%	100%	70%	30%	100%	70%	30%
P1	195	230	270	285	330	395	265	310	370	350	405	485	315	365	435
	640	750	890	940	1075	1300	870	1025	1225	1150	1325	1600	1025	1200	1425
P2	190	220	265	270	315	375	260	300	360	340	395	470	305	355	425
	620	720	870	890	1025	1225	850	980	1175	1125	1300	1550	1000	1175	1400
P3	165	190	230	240	275	330	225	260	315	295	340	410	265	305	370
	540	620	750	790	900	1075	740	850	1025	970	1125	1350	870	1000	1225
P4	150	170	205	215	245	290	200	235	275	265	305	360	235	275	325
	490	560	670	710	800	950	660	770	900	870	1000	1175	770	900	1075
P5	140	165	195	205	235	280	190	220	265	250	290	345	225	260	310
	460	540	640	670	770	920	620	720	870	820	950	1125	740	850	1025
P6	160	185	220	230	265	310	215	250	295	280	325	385	255	295	350
	520	610	720	750	870	1025	710	820	970	920	1075	1275	840	970	1150
P7	150	175	205	215	250	295	205	235	280	265	310	365	240	280	330
	490	570	670	710	820	970	670	770	920	870	1025	1200	790	920	1075
P8	140	160	195	200	230	280	190	220	265	245	285	345	220	255	310
	460	520	640	660	750	920	620	720	870	800	940	1125	720	840	1025
P11	145	170	200	210	240	285	195	230	270	260	300	355	235	270	320
	475	560	660	690	790	940	640	750	890	850	980	1175	770	890	1050
P12	95	110	125	135	155	185	130	145	175	165	190	225	150	175	205
	310	360	410	445	510	610	425	475	570	540	620	740	490	570	670
M1	165	190	225	—	—	—	210	245	290	245	285	335	220	255	305
	540	620	740	—	—	—	690	800	950	800	940	1100	720	840	1000
M2	135	155	185	—	—	—	175	200	235	200	235	275	180	210	250
	445	510	610	—	—	—	570	660	770	660	770	900	590	690	820
M3	110	125	145	—	—	—	140	160	190	160	185	220	145	165	195
	360	410	475	—	—	—	460	520	620	520	610	720	475	540	640
M4	85	95	115	—	—	—	110	125	145	125	145	170	115	130	155
	280	310	375	—	—	—	360	410	475	410	475	560	375	425	510
M5	70	80	95	—	—	—	90	105	120	105	120	140	95	110	130
	230	260	310	—	—	—	295	345	395	345	395	460	310	360	425
K1	—	—	—	295	340	405	—	—	—	—	—	—	—	—	—
	—	—	—	970	1125	1325	—	—	—	—	—	—	—	—	—
K2	—	—	—	265	305	360	—	—	—	—	—	—	—	—	—
	—	—	—	870	1000	1175	—	—	—	—	—	—	—	—	—
K3	—	—	—	220	260	305	—	—	—	—	—	—	—	—	—
	—	—	—	720	850	1000	—	—	—	—	—	—	—	—	—
K4	—	—	—	210	245	290	—	—	—	—	—	—	—	—	—
	—	—	—	690	800	950	—	—	—	—	—	—	—	—	—
K5	—	—	—	130	150	180	—	—	—	—	—	—	—	—	—
	—	—	—	425	490	590	—	—	—	—	—	—	—	—	—
K6	—	—	—	185	215	255	—	—	—	—	—	—	—	—	—
	—	—	—	610	710	840	—	—	—	—	—	—	—	—	—
K7	—	—	—	165	195	230	—	—	—	—	—	—	—	—	—
	—	—	—	540	640	750	—	—	—	—	—	—	—	—	—
S1	26	30	35	—	—	—	50	60	70	60	70	85	55	65	75
	85	100	115	—	—	—	165	195	230	195	230	280	180	215	245
S2	21	24	28	—	—	—	41	47	55	50	55	65	45	50	60
	70	80	90	—	—	—	135	155	180	165	180	215	150	165	195
S3	18	21	25	—	—	—	35	41	48	43	49	60	39	45	55
	60	70	80	—	—	—	115	135	155	140	160	195	130	150	180
S11	36	41	49	—	—	—	70	80	95	85	95	115	75	85	105
	120	135	160	—	—	—	230	260	310	280	310	375	245	280	345
S12	33	38	45	—	—	—	48	55	65	60	65	80	55	60	70
	110	125	150	—	—	—	155	180	215	195	215	260	180	195	230
S13	19	22	26	—	—	—	28	33	38	35	40	47	31	36	42
	60	70	85	—	—	—	90	110	125	115	130	155	100	120	140
H5	—	—	—	—	—	—	—	—	—	—	—	—	—	—	—
	—	—	—	—	—	—	—	—	—	—	—	—	—	—	—
H8	—	—	—	—	—	—	—	—	—	—	—	—	—	—	—
	—	—	—	—	—	—	—	—	—	—	—	—	—	—	—
H11	—	—	—	—	—	—	—	—	—	—	—	—	55	65	80
	—	—	—	—	—	—	—	—	—	—	—	—	180	215	260
H12	—	—	—	—	—	—	—	—	—	105	120	145	95	110	130
	—	—	—	—	—	—	—	—	—	345	395	475	310	360	425
H21	—	—	—	—	—	—	—	—	—	—	—	—	—	—	—
	—	—	—	—	—	—	—	—	—	—	—	—	—	—	—

Square shoulder and slot milling cutters
Helical milling cutters
Face milling cutters
Disc milling cutters
High feed milling cutters
Copy milling cutters
Plunge milling cutters
Chamfer milling cutters
Spot facing cutters
Inserts

R217/220.21-SP14 – Metric

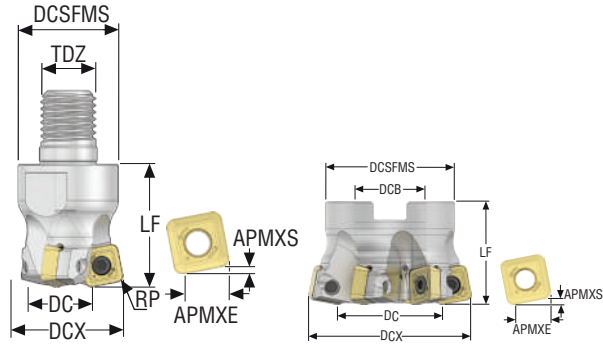



- For insert selection and cutting data recommendations, see page(s) 527-529
- For complete insert programme, see page(s) 860
- For ISO attribute explanation, see page 16

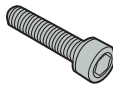
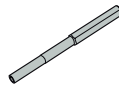

Designation	Item number	Type of mounting	DC	DCX	ZEFP	APMXS	APMXE	DCB	DCSFMS	LF	RP	RMPX°	Cmin	Cmax	Weight	RPMX	Insert
			mm	mm		mm	mm	mm	mm	mm	mm		mm	mm	kg		
R217.21-2040.RE-SP14.3A	10135958	Combimaster	17,0	40,0	3	1,8	10,0	–	36,5	45,0	4,06	2,9	57,0	78,0	0,4	11900	SPKT140523
R220.21-0050-SP14.4A	10068147	Arbor	27,1	50,0	4	1,8	10,0	22,0	41,0	40,0	4,02	3,5	77,1	98,0	0,3	10700	SPKT140523
R220.21-0050-SP14.5A	10068148	Arbor	27,1	50,0	5	1,8	10,0	22,0	41,0	40,0	4,04	1,8	77,1	98,0	0,5	10700	SPKT140523
R220.21-0052-SP14.4A	10068149	Arbor	29,1	52,0	4	1,8	10,0	22,0	49,0	40,0	4,02	3,2	81,1	102,0	0,3	10500	SPKT140523
R220.21-0052-SP14.5A	10101535	Arbor	29,1	52,0	5	1,8	10,0	22,0	49,0	40,0	4,02	3,2	81,1	102,0	0,7	10500	SPKT140523
R220.21-0063-SP14.5A	10068150	Arbor	40,1	63,0	5	1,8	10,0	27,0	49,0	50,0	4,01	2,3	103,1	124,0	0,4	9600	SPKT140523
R220.21-0063-SP14.6A	10068151	Arbor	40,1	63,0	6	1,8	10,0	27,0	49,0	50,0	4,01	2,3	103,1	124,0	0,5	9600	SPKT140523
R220.21-0066-SP14.5A	10068152	Arbor	43,0	66,0	5	1,8	10,0	27,0	61,0	50,0	4,02	2,1	109,0	130,0	0,7	9400	SPKT140523
R220.21-0066-SP14.6A	10101540	Arbor	43,0	66,0	6	1,8	10,0	27,0	61,0	50,0	4,02	2,1	109,0	130,0	0,5	9400	SPKT140523
R220.21-0080-SP14.6A	10068154	Arbor	57,0	80,0	6	1,8	10,0	27,0	61,0	50,0	4,01	1,6	137,0	158,0	0,5	8500	SPKT140523
R220.21-0080-SP14.7A	10068155	Arbor	57,0	80,0	7	1,8	10,0	27,0	61,0	50,0	4,01	1,6	137,0	158,0	0,6	8500	SPKT140523
R220.21-0084-SP14.6A	10068156	Arbor	61,0	84,0	6	1,8	10,0	32,0	79,0	50,0	4,01	1,5	145,0	166,0	0,9	8300	SPKT140523
R220.21-0100-SP14.8A	10068157	Arbor	77,0	100,0	8	1,8	10,0	32,0	79,0	50,0	4,01	1,2	177,0	198,0	0,5	7600	SPKT140523
R220.21-0125-SP14.9A	10132522	Arbor	102,0	125,0	9	1,8	10,0	40,0	90,0	63,0	4,0	0,9	227,0	248,0	3,2	6800	SPKT140523

For Combimaster Shanks, see Machining Navigator Tooling System

Spare Parts, included in delivery

For cutter	Arbor screw	Insert key	Insert screw
			
R217.21-..	-	H6B-T20P	C45011-T20P
R220.21-0050-0052	220.17-692M	H6B-T20P	C45011-T20P
R220.21-0063	MLC6S12X30	H6B-T20P	C45011-T20P
R220.21-0066	MC6S12X40	H6B-T20P	C45011-T20P
R220.21-0080	MC6S12X40	H6B-T20PL	C45011-T20P
R220.21-0084-0100	MLC6S16X35	H6B-T20PL	C45011-T20P
R220.21-0125	MC6S20X50	H6B-T20PL	C45011-T20P

Accessories

For cutter	Insert clamping torque	Torque key
		
R217/220.21-..	5.0NM	T00-20P50

Torque and fixed keys, see page 894

Square shoulder and slot milling cutters
Helical milling cutters
Face milling cutters
Disc milling cutters
High feed milling cutters
Copy milling cutters
Plunge milling cutters
Chamfer milling cutters
Spot facing cutters
Inserts

R220.21-SP14 – inch

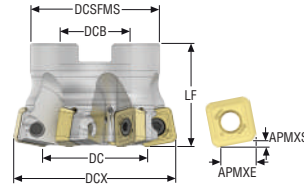

- For insert selection and cutting data recommendations, see page(s) 527-529
- For complete insert programme, see page(s) 860
- For ISO attribute explanation, see page 16

Designation	Item number	Type of mounting	DC	DCX	ZFP	APMXS	APMXE	DCB	DCSFMS	LF	RP	RMPX°	C min	C max	Weight	RPMX	Insert
			inch	inch		inch	inch	inch	inch	inch	inch		inch	inch	lbs		
R220.21-02.00-SP14.4A	10068158	Arbor	1.098	2.000	4	0.071	0.394	0.750	1.789	1.500	0.158	3,3	3.098	3.921	1.540	10700	SPKT140523
R220.21-02.00-SP14.5A	10068159	Arbor	1.098	2.000	5	0.071	0.394	0.750	1.789	1.500	0.158	3,3	3.098	3.921	1.100	10700	SPKT140523
R220.21-02.50-SP14.5A	10068160	Arbor	1.594	2.500	5	0.071	0.394	0.750	1.789	1.500	0.158	2,2	4.094	4.921	1.100	9600	SPKT140523
R220.21-02.50-SP14.6A	10068161	Arbor	1.594	2.500	6	0.071	0.394	0.750	1.789	1.500	0.158	2,2	4.094	4.921	1.100	9600	SPKT140523
R220.21-03.00-SP14.6A	10068162	Arbor	2.094	3.000	6	0.071	0.394	1.000	2.289	2.000	0.158	1,7	4.583	5.921	1.320	8500	SPKT140523
R220.21-03.00-SP14.7A	10068163	Arbor	2.094	3.000	7	0.071	0.394	1.000	2.289	2.000	0.158	1,7	4.583	5.921	1.100	8500	SPKT140523
R220.21-04.00-SP14.8A	10068164	Arbor	3.094	4.000	8	0.071	0.394	1.500	3.539	2.000	0.158	1,2	7.094	7.921	1.100	7600	SPKT140523

Spare Parts, included in delivery

For cutter	Arbor screw	Insert key	Insert screw
R220.21-02.00-02.50	UC6S3/8UNFX1-1/4	H6B-T20P	C45011-T20P
R220.21-03.00	UC6S1/2UNFX1-1/2	H6B-T20PL	C45011-T20P
R220.21-04.00	ULC6S3/4UNFX11/2	H6B-T20PL	C45011-T20P

Accessories

For cutter	Insert clamping torque	Torque key
R220.21-..	44.3IN.LBS	T00-20P50

Torque and fixed keys, see page 894

R220.21-SP14 – Insert selection – mm/Inch

SMG		a _p	f _z		
			100%	70%	30%
P1	SPKT140523TN-M14 MP2501	1,8	1,1	1,1	1,3
		0,070	0,044	0,044	0,050
P2	SPKT140523TN-M14 MP2501	1,8	1,1	1,1	1,3
		0,070	0,044	0,044	0,050
P3	SPKT140523TN-M14 MP2501	1,8	1,0	1,0	1,2
		0,070	0,040	0,040	0,048
P4	SPKT140523TN-M14 MP2501	1,8	1,0	1,0	1,2
		0,070	0,040	0,040	0,048
P5	SPKT140523TN-M14 MP2501	1,8	1,0	1,0	1,2
		0,070	0,040	0,040	0,048
P6	SPKT140523TN-M14 MP2501	1,8	1,0	1,0	1,2
		0,070	0,040	0,040	0,048
P7	SPKT140523TN-MD16 MP2501	1,8	1,1	1,1	1,4
		0,070	0,044	0,044	0,055
P8	SPKT140523TN-MD16 MP2501	1,8	1,2	1,2	1,4
		0,070	0,048	0,048	0,055
P11	SPKT140523TN-MD16 MP2501	1,8	1,1	1,1	1,4
		0,070	0,044	0,044	0,055
P12	SPKT140523TN-M14 MS2500	1,4	0,70	0,70	0,80
		0,055	0,028	0,028	0,032
M1	SPKT140523TN-M14 MS2050	1,8	1,1	1,1	1,3
		0,070	0,044	0,044	0,050
M2	SPKT140523TN-M14 MS2050	1,8	1,0	1,0	1,2
		0,070	0,040	0,040	0,048
M3	SPKT140523TN-M14 MS2050	1,4	0,80	0,80	0,95
		0,055	0,032	0,032	0,038
M4	SPKT140523TN-M14 F40M	1,4	0,70	0,70	0,85
		0,055	0,028	0,028	0,034
M5	SPKT140523TN-M14 F40M	1,4	0,70	0,70	0,85
		0,055	0,028	0,028	0,034
K1	SPKT140523TN-MD16 MK2050	1,8	1,2	1,2	1,5
		0,070	0,048	0,048	0,060
K2	SPKT140523TN-MD16 MK2050	1,8	1,1	1,1	1,4
		0,070	0,044	0,044	0,055
K3	SPKT140523TN-MD16 MK2050	1,8	1,1	1,1	1,4
		0,070	0,044	0,044	0,055
K4	SPKT140523TN-MD16 MK2050	1,8	1,1	1,1	1,4
		0,070	0,044	0,044	0,055
K5	SPKT140523TN-MD16 MK2050	1,8	1,0	1,0	1,2
		0,070	0,040	0,040	0,048
K6	SPKT140523TN-MD16 MK2050	1,8	1,1	1,1	1,4
		0,070	0,044	0,044	0,055
K7	SPKT140523TN-MD16 MK2050	1,8	1,0	1,0	1,2
		0,070	0,040	0,040	0,048
S1	SPKT140523TN-M14 MS2500	1,4	0,70	0,70	0,85
		0,055	0,028	0,028	0,034
S2	SPKT140523TN-M14 MS2500	1,4	0,70	0,70	0,85
		0,055	0,028	0,028	0,034
S3	SPKT140523TN-M14 MS2500	1,4	0,65	0,65	0,75
		0,055	0,026	0,026	0,030
S11	SPKT140523TN-M14 MS2050	1,4	0,80	0,80	0,95
		0,055	0,032	0,032	0,038
S12	SPKT140523TN-M14 MS2050	1,4	0,80	0,80	0,95
		0,055	0,032	0,032	0,038
S13	SPKT140523TN-M14 MS2050	1,4	0,70	0,70	0,85
		0,055	0,028	0,028	0,034
H5	SPKT140523TN-MD16 MP1501	1,4	0,75	0,75	0,90
		0,055	0,030	0,030	0,036
H8	SPKT140523TN-MD16 MP1501	1,4	0,60	0,60	0,70
		0,055	0,024	0,024	0,028
H11	SPKT140523TN-MD16 MP1501	1,4	0,75	0,75	0,90
		0,055	0,030	0,030	0,036
H12	SPKT140523TN-M14 MS2500	1,4	0,50	0,50	0,60
		0,055	0,020	0,020	0,024

SMG = Seco material group
f_z = mm/tooth (in/tooth), v_c = m/min (sf/min), a_p/DC = %
All cutting data are start values

Square shoulder and slot milling cutters
Helical milling cutters
Face milling cutters
Disc milling cutters
High feed milling cutters
Copy milling cutters
Plunge milling cutters
Chamfer milling cutters
Spot facing cutters
Inserts

R220.21-SP14 – Cutting data $v_c = (m/min)/(sf/min)$

SMG	MP1501			MP2501			MP3000			T350M			F40M		
	100%	70%	30%	100%	70%	30%	100%	70%	30%	100%	70%	30%	100%	70%	30%
P1	300	350	420	285	335	400	250	290	350	250	290	350	220	255	305
	980	1150	1375	940	1100	1300	820	950	1150	820	950	1150	720	840	1000
P2	290	340	400	280	325	390	245	285	335	245	285	340	210	245	295
	950	1125	1300	920	1075	1275	800	940	1100	800	940	1125	690	800	970
P3	250	290	350	250	290	345	210	245	295	215	250	300	190	220	260
	820	950	1150	820	950	1125	690	800	970	710	820	980	620	720	850
P4	225	265	310	220	255	305	190	220	260	190	220	265	165	195	230
	740	870	1025	720	840	1000	620	720	850	620	720	870	540	640	750
P5	215	250	300	210	245	290	180	210	255	180	210	255	160	185	220
	710	820	980	690	800	950	590	690	840	590	690	840	520	610	720
P6	240	285	340	240	280	325	205	235	285	205	240	285	180	210	245
	790	940	1125	790	920	1075	670	770	940	670	790	940	590	690	800
P7	230	265	320	225	260	310	190	225	270	195	230	270	170	200	235
	750	870	1050	740	850	1025	620	740	890	640	750	890	560	660	770
P8	210	245	295	210	245	290	175	205	250	180	210	255	160	185	220
	690	800	970	690	800	950	570	670	820	590	690	840	520	610	720
P11	220	260	310	220	255	300	185	215	260	190	220	260	165	195	225
	720	850	1025	720	840	980	610	710	850	620	720	850	540	640	740
P12	145	170	205	140	165	200	120	140	170	125	145	170	105	125	150
	475	560	670	460	540	660	395	460	560	410	475	560	345	410	490
M1	—	—	—	200	235	280	180	210	250	190	220	265	170	200	240
	—	—	—	660	770	920	590	690	820	620	720	870	560	660	790
M2	—	—	—	170	195	235	150	175	210	155	185	220	140	165	200
	—	—	—	560	640	770	490	570	690	510	610	720	460	540	660
M3	—	—	—	135	155	190	120	140	170	125	145	180	115	135	160
	—	—	—	445	510	620	395	460	560	410	475	590	375	445	520
M4	—	—	—	105	125	150	95	110	130	100	115	140	90	105	125
	—	—	—	345	410	490	310	360	425	330	375	460	295	345	410
M5	—	—	—	85	100	125	80	90	110	80	95	115	75	85	105
	—	—	—	280	330	410	260	295	360	260	310	375	245	280	345
K1	230	270	315	220	260	310	195	225	265	195	225	270	170	195	235
	750	890	1025	720	850	1025	640	740	870	640	740	890	560	640	770
K2	205	240	285	200	230	275	170	200	240	170	200	240	150	175	210
	670	790	940	660	750	900	560	660	790	560	660	790	490	570	690
K3	175	200	245	165	195	235	145	170	205	145	170	205	125	150	175
	570	660	800	540	640	770	475	560	670	475	560	670	410	490	570
K4	165	195	230	160	185	225	140	160	195	140	165	195	120	140	170
	540	640	750	520	610	740	460	520	640	460	540	640	395	460	560
K5	100	120	140	100	115	135	85	100	120	85	100	120	75	85	105
	330	395	460	330	375	445	280	330	395	280	330	395	245	280	345
K6	145	170	205	140	165	195	120	145	170	125	145	170	105	125	150
	475	560	670	460	540	640	395	475	560	410	475	560	345	410	490
K7	130	150	180	125	145	175	110	125	150	110	130	150	95	110	130
	425	490	590	410	475	570	360	410	490	360	425	490	310	360	425
S1	—	—	—	50	60	75	44	50	60	46	55	65	42	49	60
	—	—	—	165	195	245	145	165	195	150	180	215	140	160	195
S2	—	—	—	41	48	60	35	41	49	37	43	50	33	39	48
	—	—	—	135	155	195	115	135	160	120	140	165	110	130	155
S3	—	—	—	36	42	50	31	36	44	32	38	46	29	34	42
	—	—	—	120	140	165	100	120	145	105	125	150	95	110	140
S11	—	—	—	70	85	100	60	70	85	65	75	90	60	65	80
	—	—	—	230	280	330	195	230	280	215	245	295	195	215	260
S12	—	—	—	49	55	70	42	49	60	44	50	60	40	47	55
	—	—	—	160	180	230	140	160	195	145	165	195	130	155	180
S13	—	—	—	29	34	41	25	29	35	26	30	37	23	27	33
	—	—	—	95	110	135	80	95	115	85	100	120	75	90	110
H5	48	55	65	43	50	60	38	44	55	41	48	55	36	42	50
	155	180	215	140	165	195	125	145	180	135	155	180	120	140	165
H8	50	60	70	46	55	65	40	47	55	44	50	60	38	45	55
	165	195	230	150	180	215	130	155	180	145	165	195	125	150	180
H11	60	70	85	55	65	75	48	55	65	50	60	75	45	55	65
	195	230	280	180	215	245	155	180	215	165	195	245	150	180	215
H12	90	105	130	90	105	125	75	90	110	80	90	110	70	80	95
	295	345	425	295	345	410	245	295	360	260	295	360	230	260	310
H21	50	60	70	46	55	65	40	47	55	44	50	60	38	45	55
	165	195	230	150	180	215	130	155	180	145	165	195	125	150	180

R220.21-SP14 – Cutting data $v_c = (m/min)/(sf/min)$

SMG	MM4500			MK2050			MS2050			MS2500			MP2050		
	100%	70%	30%	100%	70%	30%	100%	70%	30%	100%	70%	30%	100%	70%	30%
P1	175	205	250	285	330	400	240	280	335	315	365	440	280	330	395
	570	670	820	940	1075	1300	790	920	1100	1025	1200	1450	920	1075	1300
P2	170	200	240	275	325	385	235	275	330	305	360	430	275	320	385
	560	660	790	900	1075	1275	770	900	1075	1000	1175	1400	900	1050	1275
P3	150	180	215	245	285	340	205	240	290	270	315	380	245	285	340
	490	590	710	800	940	1125	670	790	950	890	1025	1250	800	940	1125
P4	135	155	185	215	250	300	180	215	255	240	280	335	215	250	300
	445	510	610	710	820	980	590	710	840	790	920	1100	710	820	980
P5	130	150	180	205	240	285	175	205	245	230	265	320	205	240	285
	425	490	590	670	790	940	570	670	800	750	870	1050	670	790	940
P6	145	170	200	230	270	320	195	230	275	255	300	355	230	270	320
	475	560	660	750	890	1050	640	750	900	840	980	1175	750	890	1050
P7	135	160	190	220	255	305	185	215	255	240	280	335	215	255	305
	445	520	620	720	840	1000	610	710	840	790	920	1100	710	840	1000
P8	130	150	180	205	240	285	175	205	245	230	265	320	205	240	285
	425	490	590	670	790	940	570	670	800	750	870	1050	670	790	940
P11	130	155	185	210	250	295	180	210	250	235	275	325	210	245	295
	425	510	610	690	820	970	590	690	820	770	900	1075	690	800	970
P12	85	100	120	135	160	195	115	135	165	150	175	215	135	155	195
	280	330	395	445	520	640	375	445	540	490	570	710	445	510	640
M1	145	175	205	—	—	—	190	220	265	220	255	305	195	230	275
	475	570	670	—	—	—	620	720	870	720	840	1000	640	750	900
M2	125	145	170	—	—	—	155	185	220	180	215	255	165	190	230
	410	475	560	—	—	—	510	610	720	590	710	840	540	620	750
M3	100	115	140	—	—	—	125	145	180	145	170	205	130	150	185
	330	375	460	—	—	—	410	475	590	475	560	670	425	490	610
M4	75	90	110	—	—	—	100	115	140	115	130	160	105	120	145
	245	295	360	—	—	—	330	375	460	375	425	520	345	395	475
M5	65	75	90	—	—	—	80	95	115	95	110	135	85	100	120
	215	245	295	—	—	—	260	310	375	310	360	445	280	330	395
K1	—	—	—	295	350	420	—	—	—	—	—	—	220	255	305
	—	—	—	970	1150	1375	—	—	—	—	—	—	720	840	1000
K2	—	—	—	265	310	370	—	—	—	—	—	—	195	230	270
	—	—	—	870	1025	1225	—	—	—	—	—	—	640	750	890
K3	—	—	—	225	265	315	—	—	—	—	—	—	165	195	230
	—	—	—	740	870	1025	—	—	—	—	—	—	540	640	750
K4	—	—	—	215	250	300	—	—	—	—	—	—	155	185	220
	—	—	—	710	820	980	—	—	—	—	—	—	510	610	720
K5	—	—	—	130	155	185	—	—	—	—	—	—	95	115	135
	—	—	—	425	510	610	—	—	—	—	—	—	310	375	445
K6	—	—	—	190	220	265	—	—	—	—	—	—	140	160	195
	—	—	—	620	720	870	—	—	—	—	—	—	460	520	640
K7	—	—	—	170	200	235	—	—	—	—	—	—	125	145	170
	—	—	—	560	660	770	—	—	—	—	—	—	410	475	560
S1	23	27	33	—	—	—	46	55	65	55	65	80	50	60	70
	75	90	110	—	—	—	150	180	215	180	215	260	165	195	230
S2	19	22	27	—	—	—	37	43	50	45	50	65	40	47	55
	60	70	90	—	—	—	120	140	165	150	165	215	130	155	180
S3	17	19	24	—	—	—	32	37	46	39	46	55	36	41	50
	55	60	80	—	—	—	105	120	150	130	150	180	120	135	165
S11	33	38	46	—	—	—	65	75	90	75	90	110	70	80	100
	110	125	150	—	—	—	215	245	295	245	295	360	230	260	330
S12	30	35	43	—	—	—	44	50	60	55	60	75	48	55	70
	100	115	140	—	—	—	145	165	195	180	195	245	155	180	230
S13	18	20	25	—	—	—	26	30	36	31	36	44	28	33	40
	60	65	80	—	—	—	85	100	120	100	120	145	90	110	130
H5	—	—	—	—	—	—	—	—	—	—	—	—	41	47	60
	—	—	—	—	—	—	—	—	—	—	—	—	135	155	195
H8	—	—	—	—	—	—	—	—	—	—	—	—	45	50	65
	—	—	—	—	—	—	—	—	—	—	—	—	150	165	215
H11	—	—	—	—	—	—	—	—	—	—	—	—	50	60	75
	—	—	—	—	—	—	—	—	—	—	—	—	165	195	245
H12	—	—	—	—	—	—	—	—	—	100	115	140	90	105	125
	—	—	—	—	—	—	—	—	—	330	375	460	295	345	410
H21	—	—	—	—	—	—	—	—	—	—	—	—	45	50	65
	—	—	—	—	—	—	—	—	—	—	—	—	150	165	215

Square shoulder and slot milling cutters
Helical milling cutters
Face milling cutters
Disc milling cutters
High feed milling cutters
Copy milling cutters
Plunge milling cutters
Chamfer milling cutters
Spot facing cutters
Inserts

R220.21-SP18 – Metric

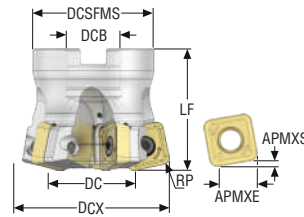

- For insert selection and cutting data recommendations, see page(s) 533-535
- For complete insert programme, see page(s) 860
- For ISO attribute explanation, see page 16

Designation	Item number	Type of mounting	DC	DCX	ZEFP	APMXS	APMXE	DCB	DCSFMS	LF	RP	RMPX°	Cmin	Cmax	Weight	RPMX	Insert
			mm	mm		mm	mm	mm	mm	mm	mm		mm	mm	kg		
R220.21-0063-SP18.5A	10097579	Arbor	33,7	63,0	5	2,5	14,0	22,0	49,0	50,0	5,41	2,4	96,7	124,0	1,0	5800	SPKT180630
R220.21-0066-SP18.5A	10097580	Arbor	36,7	66,0	5	2,5	14,0	27,0	61,0	55,0	5,4	3,4	102,7	130,0	0,9	5700	SPKT180630
R220.21-0080-SP18.5A	10097581	Arbor	50,7	80,0	5	2,5	14,0	27,0	61,0	50,0	5,4	2,4	130,7	158,0	0,5	5100	SPKT180630
R220.21-0080-SP18.6A	10097582	Arbor	50,7	80,0	6	2,5	14,0	27,0	61,0	50,0	5,4	2,4	130,7	158,0	1,4	5100	SPKT180630
R220.21-0100-SP18.7A	10097583	Arbor	70,7	100,0	7	2,5	14,0	32,0	79,0	50,0	5,39	1,7	170,7	198,0	0,5	4500	SPKT180630
R220.21-0125-SP18.8A	10097584	Arbor	95,6	125,0	8	2,5	14,0	40,0	90,0	63,0	5,39	1,2	220,6	248,0	2,0	4000	SPKT180630
R220.21-8160-SP18.10A	10097585	Arbor	130,6	160,0	10	2,5	14,0	40,0	90,0	63,0	5,39	0,9	290,6	318,0	1,4	3600	SPKT180630

Spare Parts, included in delivery

For cutter	Arbor screw	Insert key	Insert screw	Lid	Lid screw
R220.21-0063					
R220.21-0066					
R220.21-0080					
R220.21-0100					
R220.21-0125					
R220.21-8160					

Accessories

For cutter	Arbor screw	Insert clamping torque	Torque key
R220.21-0063-0125			
R220.21-8160			

Torque and fixed keys, see page 894

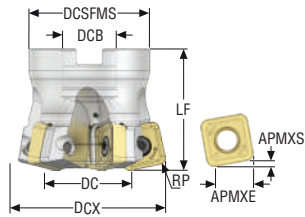

R220.21-SP18 – inch





- For insert selection and cutting data recommendations, see page(s) 533-535
- For complete insert programme, see page(s) 860
- For ISO attribute explanation, see page 16

Designation	Item number	Type of mounting	DC	DCX	ZEFP	APMXS	APMXE	DCB	DCSFMS	LF	RP	RMPX°	C min	C max	Weight	RPMX	Insert
			inch	inch		inch	inch	inch	inch	inch	inch		inch	inch	lbs		
R220.21-02.50-SP18.5A	10097586	Arbor	1.346	2.500	5	0.098	0.551	0.750	1.789	2.000	0.213	3,7	3.846	4.921	1.320	5800	SPKT180630
R220.21-03.00-SP18.5A	10128670	Arbor	1.846	3.000	5	0.098	0.551	1.000	2.289	2.000	0.213	2,6	4.846	5.921	1.980	5100	SPKT180630
R220.21-03.00-SP18.6A	10097587	Arbor	1.846	3.000	6	0.098	0.551	1.000	2.289	2.000	0.213	2,6	4.846	5.921	1.980	5100	SPKT180630
R220.21-04.00-SP18.7A	10097588	Arbor	2.846	4.000	7	0.098	0.551	1.500	3.539	2.000	0.212	1,7	6.846	7.921	1.320	4500	SPKT180630
R220.21-05.00-SP18.8A	10097589	Arbor	3.843	5.000	8	0.098	0.551	1.500	3.539	2.500	0.212	1,2	8.843	9.921	6.610	4000	SPKT180630
R220.21-06.00-SP18.10A	10097590	Arbor	4.843	6.000	10	0.098	0.551	2.000	4.909	2.500	0.212	1,0	10.843	11.921	8.160	3700	SPKT180630

Spare Parts, included in delivery

For cutter	Arbor screw	Insert screw
		
R220.21-02.50	UC6S3/8UNFX11/2	C05013-T20P
R220.21-03.00	UC6S1/2UNFX1-1/2	C05013-T20P
R220.21-04.00	ULC6S3/4UNFX11/2	C05013-T20P
R220.21-05.00	UC6S3/4UNFX2	C05013-T20P
R220.21-06.00	-	C05013-T20P

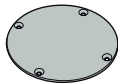
Accessories

For cutter	Insert clamping torque	Lid	Lid Screw	Torque key
				
R220.21-02.50-05.00	44.3IN.LBS	-	-	T00-20P50
R220.21-06.00	44.3IN.LBS	SC-160-90	MF6S4X10	T00-20P50

Torque and fixed keys, see page 894

Square shoulder and slot milling cutters

Helical milling cutters

Face milling cutters

Disc milling cutters

High feed milling cutters

Copy milling cutters

Plunge milling cutters

Chamfer milling cutters

Spot facing cutters

Inserts

R220.21-SP18 – Metric

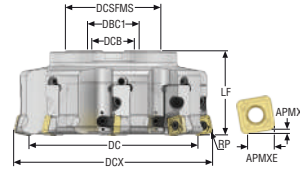

- For insert selection and cutting data recommendations, see page(s) 533-535
- For complete insert programme, see page(s) 860
- For ISO attribute explanation, see page 16

Designation	Item number	Type of mounting	DC	DCX	ZEFP	APMXS	APMXE	DCB	DCSFMS	LF	RP	RMPX°	Cmin	Cmax	Weight	RPMX	Insert
			mm	mm		mm	mm	mm	mm	mm	mm		mm	mm	kg		
R220.21-0153-SP18HF-6CA	10135928	Arbor	123,8	153,0	6	2,9	14,0	40,0	90,0	80,0	5,79	0,8	276,8	304,0	6,1	3700	SPKT180630
R220.21-0153-SP18MF-6CA	10135931	Arbor	124,5	153,0	6	4,1	14,0	40,0	90,0	80,0	6,99	0,7	277,5	304,0	6,1	3700	SPKT180630
R220.21-8188-SP18HF-8CA	10135929	Arbor	158,8	188,0	8	2,9	14,0	40,0	90,0	80,0	5,79	0,6	346,8	374,0	8,2	3300	SPKT180630
R220.21-8188-SP18MF-8CA	10135932	Arbor	159,5	188,0	8	4,1	14,0	40,0	90,0	80,0	6,99	0,5	347,5	374,0	8,2	3300	SPKT180630
R220.21-8228-SP18HF-10CA	10135930	Arbor	198,7	228,0	10	2,9	14,0	60,0	130,0	80,0	5,79	0,5	426,7	454,0	11,5	3000	SPKT180630
R220.21-8228-SP18MF-10CA	10135933	Arbor	199,5	228,0	10	4,1	14,0	60,0	130,0	80,0	6,99	0,4	427,5	454,0	11,5	3000	SPKT180630

Spare Parts, included in delivery

For cutter	Adjustment unit	Arbor screw	Basic body	Cassette	Cassette screw	Insert screw	Lid	Lid screw	Wedge clamp	Wedge screw
R220.21-0153HF	AU1114T-T15P	MC6S20X70	B-R220.21/291-0153-6CA	SP18HF-R	FS98030	C05013-T20P	-	-	CW0810	LD8020-T25P
R220.21-0153MF	AU1114T-T15P	MC6S20X70	B-R220.21/291-0153-6CA	SP18MF-R	FS98030	C05013-T20P	-	-	CW0810	LD8020-T25P
R220.21-8188HF	AU1114T-T15P	-	B-R220.21/291-8188-8CA	SP18HF-R	FS98030	C05013-T20P	SC-160-90	MF6S4X10	CW0810	LD8020-T25P
R220.21-8188MF	AU1114T-T15P	-	B-R220.21/291-8188-8CA	SP18MF-R	FS98030	C05013-T20P	SC-160-90	MF6S4X10	CW0810	LD8020-T25P
R220.21-8228HF	AU1114T-T15P	-	B-R220.21/291-8228-10CA	SP18HF-R	FS98030	C05013-T20P	SC-200-90	MF6S4X10	CW0810	LD8020-T25P
R220.21-8228MF	AU1114T-T15P	-	B-R220.21/291-8228-10CA	SP18MF-R	FS98030	C05013-T20P	SC-200-90	MF6S4X10	CW0810	LD8020-T25P

Accessories

For cutter	Arbor screw	Setting key	Torque key	Wedge key
R220.21-0153	-	1/4HEX-T15PX50	1/4HEX-T-HANDLE-5.0-14.0NM	1/4HEX-T25PX50
R220.21-8188	MC6S12X40	1/4HEX-T15PX50	1/4HEX-T-HANDLE-5.0-14.0NM	1/4HEX-T25PX50
R220.21-8228	MC6S16X50	1/4HEX-T15PX50	1/4HEX-T-HANDLE-5.0-14.0NM	1/4HEX-T25PX50

Torque and fixed keys, see page 894

R220.21-SP18 – Insert selection – mm/Inch

SMG		a _p	f _z		
			100%	70%	30%
P1	SPKT180630TN-M14 MP2501	2,5	1,0	1,0	1,2
		0.10	0.040	0.040	0.048
P2	SPKT180630TN-M14 MP2501	2,5	1,0	1,0	1,2
		0.10	0.040	0.040	0.048
P3	SPKT180630TN-M14 MP2501	2,5	0,95	0,95	1,1
		0.10	0.038	0.038	0.044
P4	SPKT180630TN-M14 MP2501	2,5	0,95	0,95	1,1
		0.10	0.038	0.038	0.044
P5	SPKT180630TN-M14 MP2501	2,5	0,90	0,90	1,1
		0.10	0.036	0.036	0.044
P6	SPKT180630TN-M14 MP2501	2,5	0,90	0,90	1,1
		0.10	0.036	0.036	0.044
P7	SPKT180630TN-MD16 MP2501	2,5	1,0	1,0	1,2
		0.10	0.040	0.040	0.048
P8	SPKT180630TN-MD16 MP2501	2,5	1,1	1,1	1,3
		0.10	0.044	0.044	0.050
P11	SPKT180630TN-MD16 MP2501	2,5	1,0	1,0	1,2
		0.10	0.040	0.040	0.048
P12	SPKT180630TN-M14 MS2500	2,0	0,65	0,65	0,70
		0.075	0.026	0.026	0.028
M1	SPKT180630TN-M14 MS2050	2,5	1,0	1,0	1,2
		0.10	0.040	0.040	0.048
M2	SPKT180630TN-M14 MS2050	2,5	0,90	0,90	1,1
		0.10	0.036	0.036	0.044
M3	SPKT180630TN-M14 MS2050	2,0	0,75	0,75	0,85
		0.075	0.030	0.030	0.034
M4	SPKT180630TN-M14 F40M	2,0	0,65	0,65	0,75
		0.075	0.026	0.026	0.030
M5	SPKT180630TN-M14 F40M	2,0	0,65	0,65	0,75
		0.075	0.026	0.026	0.030
K1	SPKT180630TN-MD16 MK2050	2,5	1,2	1,2	1,3
		0.10	0.048	0.048	0.050
K2	SPKT180630TN-MD16 MK2050	2,5	1,0	1,0	1,2
		0.10	0.040	0.040	0.048
K3	SPKT180630TN-MD16 MK2050	2,5	1,0	1,0	1,2
		0.10	0.040	0.040	0.048
K4	SPKT180630TN-MD16 MK2050	2,5	1,0	1,0	1,2
		0.10	0.040	0.040	0.048
K5	SPKT180630TN-MD16 MK2050	2,5	0,95	0,95	1,1
		0.10	0.038	0.038	0.044
K6	SPKT180630TN-MD16 MK2050	2,5	1,0	1,0	1,2
		0.10	0.040	0.040	0.048
K7	SPKT180630TN-MD16 MK2050	2,5	0,95	0,95	1,1
		0.10	0.038	0.038	0.044
S1	SPKT180630TN-M14 MS2500	2,0	0,65	0,65	0,75
		0.075	0.026	0.026	0.030
S2	SPKT180630TN-M14 MS2500	2,0	0,65	0,65	0,75
		0.075	0.026	0.026	0.030
S3	SPKT180630TN-M14 MS2500	2,0	0,60	0,60	0,70
		0.075	0.024	0.024	0.028
S11	SPKT180630TN-M14 MS2050	2,0	0,75	0,75	0,85
		0.075	0.030	0.030	0.034
S12	SPKT180630TN-M14 MS2050	2,0	0,75	0,75	0,85
		0.075	0.030	0.030	0.034
S13	SPKT180630TN-M14 MS2050	2,0	0,65	0,65	0,75
		0.075	0.026	0.026	0.030
H5	SPKT180630TN-MD16 MP1501	2,0	0,70	0,70	0,85
		0.075	0.028	0.028	0.034
H8	SPKT180630TN-MD16 MP1501	2,0	0,55	0,55	0,65
		0.075	0.022	0.022	0.026
H11	SPKT180630TN-MD16 MP1501	2,0	0,70	0,70	0,85
		0.075	0.028	0.028	0.034
H12	SPKT180630TN-M14 MS2500	2,0	0,48	0,48	0,55
		0.075	0.019	0.019	0.022

SMG = Seco material group
f_z = mm/tooth (in/tooth), v_c = m/min (sf/min), a_p/DC = %
All cutting data are start values

Square shoulder and slot milling cutters
Helical milling cutters
Face milling cutters
Disc milling cutters
High feed milling cutters
Copy milling cutters
Plunge milling cutters
Chamfer milling cutters
Spot facing cutters
Inserts

R220.21-SP18 – Cutting data $v_c = (m/min)/(sf/min)$

SMG	MP1501			MP2501			MP3000			T350M			F40M		
	100%	70%	30%	100%	70%	30%	100%	70%	30%	100%	70%	30%	100%	70%	30%
P1	285	325	390	280	320	385	240	275	330	240	275	335	210	240	290
	940	1075	1275	920	1050	1275	790	900	1075	790	900	1100	690	790	950
P2	275	315	380	265	305	365	230	265	320	230	265	315	200	230	275
	900	1025	1250	870	1000	1200	750	870	1050	750	870	1025	660	750	900
P3	240	275	335	235	265	320	200	230	280	205	230	280	175	200	245
	790	900	1100	770	870	1050	660	750	920	670	750	920	570	660	800
P4	215	250	295	210	240	285	180	210	250	180	210	245	160	180	215
	710	820	970	690	790	940	590	690	820	590	690	800	520	590	710
P5	205	235	280	200	230	280	175	200	235	175	200	240	150	175	210
	670	770	920	660	750	920	570	660	770	570	660	790	490	570	690
P6	230	265	315	225	255	310	195	225	265	195	225	270	170	195	235
	750	870	1025	740	840	1025	640	740	870	640	740	890	560	640	770
P7	220	250	300	210	240	295	185	210	250	185	210	255	160	185	225
	720	820	980	690	790	970	610	690	820	610	690	840	520	610	740
P8	200	230	280	195	225	270	170	190	235	170	195	235	150	170	205
	660	750	920	640	740	890	560	620	770	560	640	770	490	560	670
P11	215	245	290	205	235	285	180	205	245	180	205	250	155	180	215
	710	800	950	670	770	940	590	670	800	590	670	820	510	590	710
P12	140	155	195	135	155	185	115	130	160	115	135	165	100	115	140
	460	510	640	445	510	610	375	425	520	375	445	540	330	375	460
M1	—	—	—	190	220	260	175	200	240	180	205	245	160	185	220
	—	—	—	620	720	850	570	660	790	590	670	800	520	610	720
M2	—	—	—	160	185	225	145	165	200	150	170	210	135	155	190
	—	—	—	520	610	740	475	540	660	490	560	690	445	510	620
M3	—	—	—	130	150	180	115	130	160	120	140	165	110	125	150
	—	—	—	425	490	590	375	425	520	395	460	540	360	410	490
M4	—	—	—	100	115	140	90	105	125	95	105	130	85	95	120
	—	—	—	330	375	460	295	345	410	310	345	425	280	310	395
M5	—	—	—	85	95	115	75	85	105	75	90	110	70	80	100
	—	—	—	280	310	375	245	280	345	245	295	360	230	260	330
K1	220	250	300	210	240	290	185	210	255	185	210	250	160	185	220
	720	820	980	690	790	950	610	690	840	610	690	820	520	610	720
K2	195	225	270	190	215	265	165	190	225	165	190	230	145	165	200
	640	740	890	620	710	870	540	620	740	540	620	750	475	540	660
K3	165	190	225	160	185	225	140	160	190	140	160	195	120	140	170
	540	620	740	520	610	740	460	520	620	460	520	640	395	460	560
K4	160	180	215	150	175	215	135	150	180	135	150	185	115	130	160
	520	590	710	490	570	710	445	490	590	445	490	610	375	425	520
K5	95	110	130	95	110	130	80	95	110	80	95	110	70	80	100
	310	360	425	310	360	425	260	310	360	260	310	360	230	260	330
K6	140	160	190	135	155	190	115	135	160	115	135	165	100	115	140
	460	520	620	445	510	620	375	445	520	375	445	540	330	375	460
K7	125	145	170	120	140	165	105	120	140	105	120	145	90	105	125
	410	475	560	395	460	540	345	395	460	345	395	475	295	345	410
S1	—	—	—	48	55	70	43	48	60	43	49	60	39	45	55
	—	—	—	155	180	230	140	155	195	140	160	195	130	150	180
S2	—	—	—	39	44	55	34	39	47	35	40	49	32	36	44
	—	—	—	130	145	180	110	130	155	115	130	160	105	120	145
S3	—	—	—	34	39	48	30	34	41	31	35	43	28	32	39
	—	—	—	110	130	155	100	110	135	100	115	140	90	105	130
S11	—	—	—	70	80	95	60	65	80	60	70	85	55	65	75
	—	—	—	230	260	310	195	215	260	195	230	280	180	215	245
S12	—	—	—	47	55	65	40	46	55	42	48	60	39	44	55
	—	—	—	155	180	215	130	150	180	140	155	195	130	145	180
S13	—	—	—	27	31	38	24	27	33	24	28	34	22	25	31
	—	—	—	90	100	125	80	90	110	80	90	110	70	80	100
H5	46	50	65	41	46	55	36	41	50	39	44	55	34	39	47
	150	165	215	135	150	180	120	135	165	130	145	180	110	130	155
H8	49	55	70	43	50	60	39	44	55	41	48	60	36	41	50
	160	180	230	140	165	195	130	145	180	135	155	195	120	135	165
H11	60	65	80	50	60	70	46	50	65	50	55	70	43	49	60
	195	215	260	165	195	230	150	165	215	165	180	230	140	160	195
H12	90	100	125	85	100	120	75	85	105	75	85	105	65	75	90
	295	330	410	280	330	395	245	280	345	245	280	345	215	245	295
H21	49	55	70	43	50	60	39	44	55	41	48	60	36	41	50
	160	180	230	140	165	195	130	145	180	135	155	195	120	135	165

R220.21-SP18 – Cutting data $v_c = (m/min)/(sf/min)$

SMG	MK2050			MS2050			MS2500			MP2050		
	100%	70%	30%	100%	70%	30%	100%	70%	30%	100%	70%	30%
P1	270	310	370	230	260	315	300	345	410	270	310	370
	890	1025	1225	750	850	1025	980	1125	1350	890	1025	1225
P2	260	300	360	220	255	305	290	335	400	260	300	360
	850	980	1175	720	840	1000	950	1100	1300	850	980	1175
P3	230	265	320	195	225	270	255	290	350	230	265	315
	750	870	1050	640	740	890	840	950	1150	750	870	1025
P4	200	230	280	170	195	235	225	255	310	200	230	280
	660	750	920	560	640	770	740	840	1025	660	750	920
P5	195	225	265	165	190	225	215	250	295	195	225	265
	640	740	870	540	620	740	710	820	970	640	740	870
P6	220	255	300	185	215	255	245	280	330	220	250	300
	720	840	980	610	710	840	800	920	1075	720	820	980
P7	210	240	285	175	200	240	230	265	315	205	240	280
	690	790	940	570	660	790	750	870	1025	670	790	920
P8	195	220	265	165	185	225	215	245	295	190	220	265
	640	720	870	540	610	740	710	800	970	620	720	870
P11	200	230	275	170	195	235	225	255	305	200	230	275
	660	750	900	560	640	770	740	840	1000	660	750	900
P12	130	150	180	110	125	155	145	165	200	130	145	180
	425	490	590	360	410	510	475	540	660	425	475	590
M1	—	—	—	180	205	245	210	240	285	185	215	255
	—	—	—	590	670	800	690	790	940	610	710	840
M2	—	—	—	150	170	205	175	200	235	155	180	215
	—	—	—	490	560	670	570	660	770	510	590	710
M3	—	—	—	120	135	165	140	155	190	125	140	170
	—	—	—	395	445	540	460	510	620	410	460	560
M4	—	—	—	95	105	125	110	125	150	95	110	135
	—	—	—	310	345	410	360	410	490	310	360	445
M5	—	—	—	75	90	105	90	105	125	80	90	110
	—	—	—	245	295	345	295	345	410	260	295	360
K1	285	325	390	—	—	—	—	—	—	—	—	—
	940	1075	1275	—	—	—	—	—	—	—	—	—
K2	255	290	345	—	—	—	—	—	—	—	—	—
	840	950	1125	—	—	—	—	—	—	—	—	—
K3	215	245	290	—	—	—	—	—	—	—	—	—
	710	800	950	—	—	—	—	—	—	—	—	—
K4	205	235	280	—	—	—	—	—	—	—	—	—
	670	770	920	—	—	—	—	—	—	—	—	—
K5	125	145	175	—	—	—	—	—	—	—	—	—
	410	475	570	—	—	—	—	—	—	—	—	—
K6	180	205	245	—	—	—	—	—	—	—	—	—
	590	670	800	—	—	—	—	—	—	—	—	—
K7	160	185	220	—	—	—	—	—	—	—	—	—
	520	610	720	—	—	—	—	—	—	—	—	—
S1	—	—	—	43	49	60	55	60	70	48	55	65
	—	—	—	140	160	195	180	195	230	155	180	215
S2	—	—	—	35	40	48	43	48	60	38	44	50
	—	—	—	115	130	155	140	155	195	125	145	165
S3	—	—	—	31	35	42	38	43	50	34	38	46
	—	—	—	100	115	140	125	140	165	110	125	150
S11	—	—	—	60	70	85	75	85	100	65	75	90
	—	—	—	195	230	280	245	280	330	215	245	295
S12	—	—	—	42	47	55	50	60	70	46	50	65
	—	—	—	140	155	180	165	195	230	150	165	215
S13	—	—	—	24	28	33	30	34	41	27	30	37
	—	—	—	80	90	110	100	110	135	90	100	120
H5	—	—	—	—	—	—	—	—	—	—	—	—
	—	—	—	—	—	—	—	—	—	—	—	—
H8	—	—	—	—	—	—	—	—	—	—	—	—
	—	—	—	—	—	—	—	—	—	—	—	—
H11	—	—	—	—	—	—	—	—	—	49	55	70
	—	—	—	—	—	—	—	—	—	160	180	230
H12	—	—	—	—	—	—	95	105	125	85	95	115
	—	—	—	—	—	—	310	345	410	280	310	375
H21	—	—	—	—	—	—	—	—	—	—	—	—
	—	—	—	—	—	—	—	—	—	—	—	—

Square shoulder and slot milling cutters
Helical milling cutters
Face milling cutters
Disc milling cutters
High feed milling cutters
Copy milling cutters
Plunge milling cutters
Chamfer milling cutters
Spot facing cutters
Inserts



R217/220.21 HIGH FEED 2

Highfeed 2 for LP05/06/09 insert types, 2-cutting edge, single sided positive inserts.

The inserts have modern geometries that provide the lowest possible cutting forces in all materials. These low forces lead to superior tool life.

- Cutter range 12-100 mm (.5 - 4 inch)
- Max depths of cut by insert type: LP05/0.65 mm, LP06/0.8 mm, LP09/1.8 mm
- First choice for ISO M & S materials in small-to-medium size machines
- Excellent solution for plunge milling

R217.21-LP05 – Metric

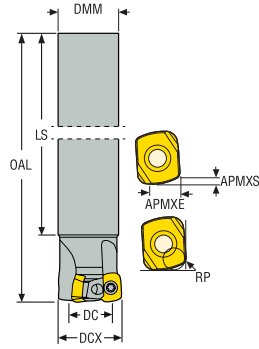

- For insert selection and cutting data recommendations, see page(s) 541-543
- For complete insert programme, see page(s) 835
- For ISO attribute explanation, see page 16

Designation	Item number	Type of mounting	DC	DCX	ZEFP	APMXS	APMXE	DMM	LS	OAL	RP	RMPX°	Cmin	Cmax	RPMX	Weight	Insert
			mm	mm		mm	mm	mm	mm	mm	mm		mm	mm		kg	
R217.21-1012.0-LP05.2A	02952509	Cylindrical	5,4	12,0	2	0,65	3,5	10,0	84,0	100,0	1,5	3,9	17,4	22,0	45000	0,1	LP..05
R217.21-1214.0-LP05.2A	02881032	Cylindrical	7,4	14,0	2	0,65	3,5	12,0	104,0	120,0	1,5	3,5	21,4	26,0	42000	0,1	LP..05
R217.21-1416.0-LP05.2A	02881033	Cylindrical	9,4	16,0	2	0,65	3,5	14,0	132,0	150,0	1,5	3,0	25,4	30,0	39000	0,2	LP..05
R217.21-1618.0-LP05.3A	02881034	Cylindrical	11,4	18,0	3	0,65	3,5	16,0	142,0	160,0	1,5	2,2	29,4	34,0	37000	0,3	LP..05
R217.21-1820.0-LP05.3A	02881035	Cylindrical	13,4	20,0	3	0,65	3,5	18,0	142,0	160,0	1,5	1,9	33,4	38,0	35000	0,3	LP..05

Spare Parts, included in delivery

For cutter	Insert key	Insert screw
R217.21-1012	H4B-T06P	C02005-T06P
R217.21-1214-1820	H4B-T06P	C02053-T06P

Accessories

For cutter	Insert clamping torque	Torque key
R217.21-..	0.5NM	T00-06P05

Torque and fixed keys, see page 894

Square shoulder and slot milling cutters

Helical milling cutters

Face milling cutters

Disc milling cutters

High feed milling cutters

Copy milling cutters

Plunge milling cutters

Chamfer milling cutters

Spot facing cutters

Inserts

R217.21-LP05 – inch

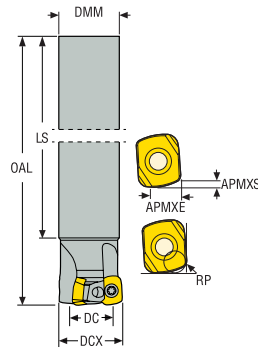

- For insert selection and cutting data recommendations, see page(s) 541-543
- For complete insert programme, see page(s) 835
- For ISO attribute explanation, see page 16

Designation	Item number	Type of mounting	DC	DCX	ZEFP	APMXS	APMXE	DMM	LS	OAL	RP	RMPX°	C min	C max	RPMX	Weight	Insert
			inch	inch		inch	inch	inch	inch	inch	inch		inch	inch		lbs	
R217.21-00.500-0-LP05-2A	02881043	Cylindrical	0.240	0.500	2	0.026	0.138	0.500	4.370	5.000	0.059	5,4	0.740	0.921	45000	0.440	LP..05
R217.21-00.625-0-LP05-2A	02881044	Cylindrical	0.362	0.625	2	0.026	0.138	0.625	5.000	6.000	0.059	3,0	0.987	1.171	39000	0.440	LP..05
R217.21-00.750-0-LP05-3A	02881045	Cylindrical	0.488	0.750	3	0.026	0.138	0.750	5.520	6.500	0.059	1,9	1.238	1.421	35000	0.880	LP..05

Spare Parts, included in delivery

For cutter	Insert key	Insert screw
R217.21-0.500	H4B-T06P	C02005-T06P
R217.21-0.625-0.750	H4B-T06P	C02053-T06P

Accessories

For cutter	Insert clamping torque	Torque key
R217.21-0.500	4.4IN.LBS	T00-06P05
R217.21-0.625-0.750	4.4IN.LBS	T00-06P05

Torque and fixed keys, see page 894

R217.21-LP05 – Metric

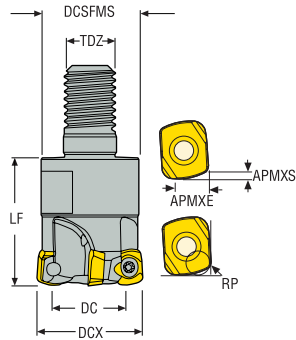

- For insert selection and cutting data recommendations, see page(s) 541-543
- For complete insert programme, see page(s) 835
- For ISO attribute explanation, see page 16

Designation	Item number	Type of mounting	DC	DCX	ZEP	APMXS	APMXE	TDZ	DCSFMS	LF	RP	RMPX°	Cmin	Cmax	Weight	RPMX	Insert
			mm	mm		mm	mm		mm	mm	mm		mm	mm	kg		
R217.21-0612.RE-LP05.2A	02952506	Combimaster	5,4	12,0	2	0,65	3,5	M6	11,0	18,0	1,5	3,9	17,4	22,0	0,1	45000	LP.05
R217.21-0812.RE-LP05.2A	02952507	Combimaster	5,4	12,0	2	0,65	3,5	M8	13,5	20,0	1,5	3,9	17,4	22,0	0,1	45000	LP.05
R217.21-0614.RE-LP05.2A	02881029	Combimaster	7,4	14,0	2	0,65	3,5	M6	11,0	18,0	1,5	3,5	21,4	26,0	0,1	42000	LP.05
R217.21-0814.RE-LP05.2A	02952508	Combimaster	7,4	14,0	2	0,65	3,5	M8	13,5	20,0	1,5	3,5	21,4	26,0	0,1	42000	LP.05
R217.21-0816.RE-LP05.3A	02881030	Combimaster	9,4	16,0	3	0,65	3,5	M8	13,5	20,0	1,5	3,0	25,4	30,0	0,1	39000	LP.05
R217.21-1020.RE-LP05.4A	02881031	Combimaster	13,4	20,0	4	0,65	3,5	M10	18,5	23,0	1,5	1,9	33,4	38,0	0,1	35000	LP.05

For Combimaster Shanks, see Machining Navigator Tooling System

Spare Parts, included in delivery

For cutter	Insert key	Insert screw
R217.21-... Ø12	H4B-T06P	C02005-T06P
R217.21-... Ø14-20	H4B-T06P	C02053-T06P

Accessories

For cutter	Insert clamping torque	Torque key
R217.21-...	0.5NM	T00-06P05

Torque and fixed keys, see page 894

Square shoulder and slot milling cutters

Helical milling cutters

Face milling cutters

Disc milling cutters

High feed milling cutters

Copy milling cutters

Plunge milling cutters

Chamfer milling cutters

Spot facing cutters

Inserts

R217.21-LP05 – inch

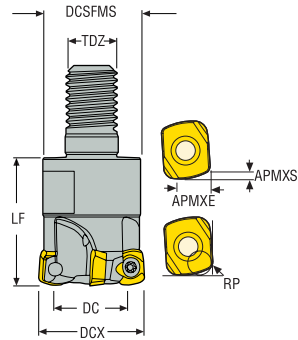

- For insert selection and cutting data recommendations, see page(s) 541-543
- For complete insert programme, see page(s) 835
- For ISO attribute explanation, see page 16

Designation	Item number	Type of mounting	DC	DCX	ZFP	APMXS	APMXE	TDZ	DCSFMS	LF	RP	RMPX°	C min	C max	Weight	RPMX	Insert
			inch	inch		inch	inch		inch	inch	inch		inch	inch	lbs		
R217.21-00.500-06RE-LP05-2A	02881039	Combimaster	0.240	0.500	2	0.026	0.138	M6	0.433	0.709	0.059	3,9	0.740	0.921	0.220	45000	LP.05
R217.21-00.625-08RE-LP05-3A	02881040	Combimaster	0.362	0.625	3	0.026	0.138	M8	0.531	0.787	0.059	3,0	0.987	1.171	0.220	39000	LP.05

For Combimaster Shanks, see Machining Navigator Tooling System

Spare Parts, included in delivery

For cutter	Insert key	Insert screw
R217.21-0.500-00.625	H4B-T06P	C02005-T06P

Accessories

For cutter	Insert clamping torque	Torque key
R217.21-..	4.4IN.LBS	T00-06P05

Torque and fixed keys, see page 894

Square shoulder and slot milling cutters
Helical milling cutters
Face milling cutters
Disc milling cutters
High feed milling cutters
Copy milling cutters
Plunge milling cutters
Chamfer milling cutters
Spot facing cutters
Inserts

R217.21-LP05 – Insert selection – mm/Inch

SMG		a_p	f_z		
			100%	70%	30%
P1	LPHT05T210TR-ME04 T350M	0,60	0,44	0,44	0,55
		0,024	0,017	0,017	0,022
P2	LPHT05T210TR-ME04 T350M	0,60	0,44	0,44	0,55
		0,024	0,017	0,017	0,022
P3	LPHT05T210TR-ME04 T350M	0,60	0,42	0,42	0,50
		0,024	0,017	0,017	0,020
P4	LPKT05T210TR-M05 MP2501	0,60	0,50	0,50	0,65
		0,024	0,020	0,020	0,026
P5	LPKT05T210TR-M05 MP2501	0,60	0,50	0,50	0,65
		0,024	0,020	0,020	0,026
P6	LPKT05T210TR-M05 MP2501	0,60	0,50	0,50	0,60
		0,024	0,020	0,020	0,024
P7	LPKT05T210TR-M05 MP2501	0,60	0,50	0,50	0,60
		0,024	0,020	0,020	0,024
P8	LPKT05T210TR-M05 MS2500	0,60	0,55	0,55	0,65
		0,024	0,022	0,022	0,026
P11	LPKT05T210TR-M05 MS2500	0,60	0,50	0,50	0,60
		0,024	0,020	0,020	0,024
P12	LPKT05T210TR-M05 MS2500	0,46	0,40	0,40	0,48
		0,018	0,016	0,016	0,019
M1	LPKT05T210TR-M05 MS2050	0,60	0,55	0,55	0,70
		0,024	0,022	0,022	0,028
M2	LPKT05T210TR-M05 MS2050	0,60	0,50	0,50	0,65
		0,024	0,020	0,020	0,026
M3	LPKT05T210TR-M05 MS2050	0,46	0,46	0,46	0,55
		0,018	0,018	0,018	0,022
M4	LPHT05T210TR-ME04 T350M	0,36	0,36	0,36	0,42
		0,014	0,014	0,014	0,017
M5	LPHT05T210TR-ME04 T350M	0,36	0,36	0,36	0,42
		0,014	0,014	0,014	0,017
K1	LPKW05T210TR-MD05 MP2501	0,60	0,55	0,55	0,70
		0,024	0,022	0,022	0,028
K2	LPKW05T210TR-MD05 MP2501	0,60	0,50	0,50	0,65
		0,024	0,020	0,020	0,026
K3	LPKW05T210TR-MD05 MP2501	0,60	0,50	0,50	0,65
		0,024	0,020	0,020	0,026
K4	LPKW05T210TR-MD05 MP2501	0,60	0,50	0,50	0,65
		0,024	0,020	0,020	0,026
K5	LPKW05T210TR-MD05 MP2501	0,60	0,46	0,46	0,55
		0,024	0,018	0,018	0,022
K6	LPKW05T210TR-MD05 MP2501	0,60	0,50	0,50	0,65
		0,024	0,020	0,020	0,026
K7	LPKW05T210TR-MD05 MP2501	0,60	0,46	0,46	0,55
		0,024	0,018	0,018	0,022
N1	LPHT05T210TR-ME04 F40M	0,60	0,55	0,55	0,70
		0,024	0,022	0,022	0,028
N2	LPHT05T210TR-ME04 F40M	0,60	0,55	0,55	0,70
		0,024	0,022	0,022	0,028
N3	LPHT05T210TR-ME04 F40M	0,60	0,55	0,55	0,70
		0,024	0,022	0,022	0,028
N11	LPHT05T210TR-ME04 F40M	0,60	0,55	0,55	0,70
		0,024	0,022	0,022	0,028
S1	LPHT05T210TR-ME04 F40M	0,36	0,36	0,36	0,42
		0,014	0,014	0,014	0,017
S2	LPHT05T210TR-ME04 F40M	0,36	0,36	0,36	0,42
		0,014	0,014	0,014	0,017
S3	LPKT05T210TR-M05 F40M	0,36	0,42	0,42	0,50
		0,014	0,017	0,017	0,020
S11	LPHT05T210TR-ME04 MS2050	0,40	0,40	0,40	0,48
		0,016	0,016	0,016	0,019
S12	LPHT05T210TR-ME04 MS2050	0,40	0,40	0,40	0,48
		0,016	0,016	0,016	0,019
S13	LPHT05T210TR-ME04 MS2050	0,36	0,36	0,36	0,42
		0,014	0,014	0,014	0,017
H5	LPHW05T210TR-MD05 MH1000	0,36	0,38	0,38	0,44
		0,014	0,015	0,015	0,017
H8	LPHW05T210TR-MD05 MH1000	0,32	0,28	0,28	0,34
		0,013	0,011	0,011	0,013
H11	LPKT05T210TR-M05 MP2501	0,36	0,38	0,38	0,44
		0,014	0,015	0,015	0,017
H12	LPKT05T210TR-M05 MP2501	0,32	0,28	0,28	0,34
		0,013	0,011	0,011	0,013
H21	LPHW05T210TR-MD05 MH1000	0,32	0,28	0,28	0,34
		0,013	0,011	0,011	0,013

SMG = Seco material group
 f_z = mm/tooth (in/tooth), v_c = m/min (sf/min), a_p/DC = %
 All cutting data are start values

Square shoulder and slot milling cutters
 Helical milling cutters
 Face milling cutters
 Disc milling cutters
 High feed milling cutters
 Copy milling cutters
 Plunge milling cutters
 Chamfer milling cutters
 Spot facing cutters
 Inserts

R217.21-LP05 – Cutting data $v_c = (m/min)/(sf/min)$

SMG	MP2050			MP2501			MP3000			T350M			F40M		
	100%	70%	30%	100%	70%	30%	100%	70%	30%	100%	70%	30%	100%	70%	30%
P1	325	385	450	330	395	460	315	375	435	315	375	440	250	300	350
	1075	1275	1475	1075	1300	1500	1025	1225	1425	1025	1225	1450	820	980	1150
P2	320	375	440	325	385	445	305	365	425	310	365	425	245	290	340
	1050	1225	1450	1075	1275	1450	1000	1200	1400	1025	1200	1400	800	950	1125
P3	275	325	385	280	330	390	265	310	370	270	320	375	210	250	295
	900	1075	1275	920	1075	1275	870	1025	1225	890	1050	1225	690	820	970
P4	245	290	340	250	300	345	240	280	325	235	280	330	190	225	260
	800	950	1125	820	980	1125	790	920	1075	770	920	1075	620	740	850
P5	235	280	325	240	285	330	225	270	310	230	270	315	180	215	250
	770	920	1075	790	940	1075	740	890	1025	750	890	1025	590	710	820
P6	265	315	370	270	320	375	255	300	355	255	305	355	205	240	285
	870	1025	1225	890	1050	1225	840	980	1175	840	1000	1175	670	790	940
P7	250	295	350	255	300	355	240	285	335	240	285	335	195	230	270
	820	970	1150	840	980	1175	790	940	1100	790	940	1100	640	750	890
P8	230	270	325	235	275	330	220	265	310	225	270	315	175	210	250
	750	890	1075	770	900	1075	720	870	1025	740	890	1025	570	690	820
P11	240	285	340	245	295	345	235	275	325	235	280	325	185	220	260
	790	940	1125	800	970	1125	770	900	1075	770	920	1075	610	720	850
P12	155	185	215	160	190	220	150	180	210	150	180	210	120	140	165
	510	610	710	520	620	720	490	590	690	490	590	690	395	460	540
M1	230	270	315	235	275	320	230	270	315	240	280	330	200	235	275
	750	890	1025	770	900	1050	750	890	1025	790	920	1075	660	770	900
M2	190	225	260	195	230	265	190	225	260	195	235	270	165	195	225
	620	740	850	640	750	870	620	740	850	640	770	890	540	640	740
M3	150	180	210	155	185	215	155	180	215	160	185	215	130	155	185
	490	590	690	510	610	710	510	590	710	520	610	710	425	510	610
M4	120	135	160	120	140	165	120	140	160	120	140	165	100	120	140
	395	445	520	395	460	540	395	460	520	395	460	540	330	395	460
M5	100	115	135	100	115	140	100	115	135	100	120	140	85	100	115
	330	375	445	330	375	460	330	375	445	330	395	460	280	330	375
K1	—	—	—	255	305	355	245	290	335	—	—	—	195	230	270
	—	—	—	840	1000	1175	800	950	1100	—	—	—	640	750	890
K2	—	—	—	230	270	310	215	255	295	—	—	—	170	205	235
	—	—	—	750	890	1025	710	840	970	—	—	—	560	670	770
K3	—	—	—	195	230	265	180	215	250	—	—	—	145	175	200
	—	—	—	640	750	870	590	710	820	—	—	—	475	570	660
K4	—	—	—	185	220	250	175	205	240	—	—	—	140	165	190
	—	—	—	610	720	820	570	670	790	—	—	—	460	540	620
K5	—	—	—	110	130	155	105	125	150	—	—	—	85	100	120
	—	—	—	360	425	510	345	410	490	—	—	—	280	330	395
K6	—	—	—	160	190	220	155	180	210	—	—	—	125	145	170
	—	—	—	520	620	720	510	590	690	—	—	—	410	475	560
K7	—	—	—	145	170	200	135	160	190	—	—	—	110	130	150
	—	—	—	475	560	660	445	520	620	—	—	—	360	425	490
N1	—	—	—	—	—	—	1800	2125	2475	—	—	—	1450	1700	1975
	—	—	—	—	—	—	5900	6975	8125	—	—	—	4750	5575	6475
N2	—	—	—	—	—	—	730	860	1000	—	—	—	580	690	800
	—	—	—	—	—	—	2400	2825	3275	—	—	—	1900	2275	2625
N3	—	—	—	—	—	—	485	570	670	—	—	—	390	460	530
	—	—	—	—	—	—	1600	1875	2200	—	—	—	1275	1500	1750
N11	—	—	—	—	—	—	550	660	760	—	—	—	445	530	610
	—	—	—	—	—	—	1800	2175	2500	—	—	—	1450	1750	2000
S1	60	65	80	60	70	80	55	65	75	55	65	80	48	55	65
	195	215	260	195	230	260	180	215	245	180	215	260	155	180	215
S2	46	55	65	47	55	65	45	50	60	46	55	65	39	45	55
	150	180	215	155	180	215	150	165	195	150	180	215	130	150	180
S3	40	47	55	41	48	55	39	45	55	40	47	55	34	39	46
	130	155	180	135	155	180	130	150	180	130	155	180	110	130	150
S11	80	95	110	80	95	110	75	90	105	80	95	110	65	80	90
	260	310	360	260	310	360	245	295	345	260	310	360	215	260	295
S12	55	65	75	55	65	80	55	65	75	55	65	75	46	55	65
	180	215	245	180	215	260	180	215	245	180	215	245	150	180	215
S13	32	38	44	33	39	45	31	36	43	32	37	44	27	31	37
	105	125	145	110	130	150	100	120	140	105	120	145	90	100	120
H5	—	—	—	50	60	70	49	55	65	50	60	70	41	48	55
	—	—	—	165	195	230	160	180	215	165	195	230	135	155	180
H8	—	—	—	55	60	70	50	60	70	55	65	75	45	50	60
	—	—	—	180	195	230	165	195	230	180	215	245	150	165	195
H11	60	70	85	65	75	85	60	70	85	65	75	90	55	60	75
	195	230	280	215	245	280	195	230	280	215	245	295	180	195	245
H12	105	120	140	105	125	145	100	115	135	100	115	135	80	95	110
	345	395	460	345	410	475	330	375	445	330	375	445	260	310	360
H21	—	—	—	55	60	70	50	60	70	55	65	75	45	50	60
	—	—	—	180	195	230	165	195	230	180	215	245	150	165	195

R217.21-LP05 – Cutting data $v_c = (m/min)/(sf/min)$

SMG	MM4500			MS2050			MS2500			MH1000		
	100%	70%	30%	100%	70%	30%	100%	70%	30%	100%	70%	30%
P1	225	265	310	275	330	380	365	430	500	—	—	—
	740	870	1025	900	1075	1250	1200	1400	1650	—	—	—
P2	220	260	300	270	320	370	355	420	485	—	—	—
	720	850	980	890	1050	1225	1175	1375	1600	—	—	—
P3	190	225	265	230	275	325	305	360	425	—	—	—
	620	740	870	750	900	1075	1000	1175	1400	—	—	—
P4	165	200	235	210	250	285	275	325	375	—	—	—
	540	660	770	690	820	940	900	1075	1225	—	—	—
P5	160	190	225	200	235	275	260	310	360	—	—	—
	520	620	740	660	770	900	850	1025	1175	—	—	—
P6	180	215	250	225	265	315	295	350	410	—	—	—
	590	710	820	740	870	1025	970	1150	1350	—	—	—
P7	170	200	235	210	250	295	275	330	390	—	—	—
	560	660	770	690	820	970	900	1075	1275	—	—	—
P8	160	190	225	195	230	275	255	305	360	—	—	—
	520	620	740	640	750	900	840	1000	1175	—	—	—
P11	165	195	230	205	245	290	270	320	375	—	—	—
	540	640	750	670	800	950	890	1050	1225	—	—	—
P12	105	125	145	130	155	185	175	205	240	—	—	—
	345	410	475	425	510	610	570	670	790	—	—	—
M1	185	220	260	215	260	300	255	300	350	—	—	—
	610	720	850	710	850	980	840	980	1150	—	—	—
M2	155	185	215	180	215	245	210	250	285	—	—	—
	510	610	710	590	710	800	690	820	940	—	—	—
M3	125	145	170	145	170	200	170	200	235	—	—	—
	410	475	560	475	560	660	560	660	770	—	—	—
M4	95	110	130	115	130	155	130	155	180	—	—	—
	310	360	425	375	425	510	425	510	590	—	—	—
M5	80	95	110	95	110	130	110	130	150	—	—	—
	260	310	360	310	360	425	360	425	490	—	—	—
K1	—	—	—	—	—	—	—	—	—	260	310	360
	—	—	—	—	—	—	—	—	—	850	1025	1175
K2	—	—	—	—	—	—	—	—	—	230	275	315
	—	—	—	—	—	—	—	—	—	750	900	1025
K3	—	—	—	—	—	—	—	—	—	195	230	270
	—	—	—	—	—	—	—	—	—	640	750	890
K4	—	—	—	—	—	—	—	—	—	185	220	255
	—	—	—	—	—	—	—	—	—	610	720	840
K5	—	—	—	—	—	—	—	—	—	115	135	160
	—	—	—	—	—	—	—	—	—	375	445	520
K6	—	—	—	—	—	—	—	—	—	165	195	225
	—	—	—	—	—	—	—	—	—	540	640	740
K7	—	—	—	—	—	—	—	—	—	145	170	205
	—	—	—	—	—	—	—	—	—	475	560	670
N1	—	—	—	—	—	—	—	—	—	—	—	—
	—	—	—	—	—	—	—	—	—	—	—	—
N2	—	—	—	—	—	—	—	—	—	—	—	—
	—	—	—	—	—	—	—	—	—	—	—	—
N3	—	—	—	—	—	—	—	—	—	—	—	—
	—	—	—	—	—	—	—	—	—	—	—	—
N11	—	—	—	—	—	—	—	—	—	—	—	—
	—	—	—	—	—	—	—	—	—	—	—	—
S1	29	34	40	55	60	70	65	75	85	—	—	—
	95	110	130	180	195	230	215	245	280	—	—	—
S2	24	27	32	42	49	60	50	60	70	—	—	—
	80	90	105	140	160	195	165	195	230	—	—	—
S3	21	24	28	37	43	50	45	50	60	—	—	—
	70	80	90	120	140	165	150	165	195	—	—	—
S11	41	48	55	75	85	100	90	105	120	—	—	—
	135	155	180	245	280	330	295	345	395	—	—	—
S12	38	44	50	50	60	70	60	70	85	—	—	—
	125	145	165	165	195	230	195	230	280	—	—	—
S13	22	26	30	30	35	40	36	42	49	—	—	—
	70	85	100	100	115	130	120	140	160	—	—	—
H5	—	—	—	—	—	—	—	—	—	55	65	75
	—	—	—	—	—	—	—	—	—	180	215	245
H8	—	—	—	—	—	—	—	—	—	60	70	80
	—	—	—	—	—	—	—	—	—	195	230	260
H11	—	—	—	—	—	—	—	—	—	70	85	100
	—	—	—	—	—	—	—	—	—	230	280	330
H12	—	—	—	—	—	—	—	—	—	105	125	145
	—	—	—	—	—	—	—	—	—	345	410	475
H21	—	—	—	—	—	—	—	—	—	60	70	80
	—	—	—	—	—	—	—	—	—	195	230	260

Square shoulder and slot milling cutters
Helical milling cutters
Face milling cutters
Disc milling cutters
High feed milling cutters
Copy milling cutters
Plunge milling cutters
Chamfer milling cutters
Spot facing cutters
Inserts

R217.21-LP06 – Metric

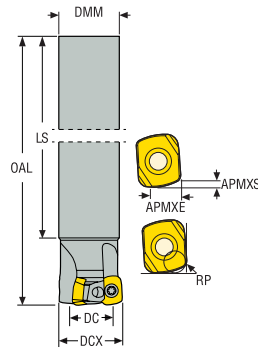

- For insert selection and cutting data recommendations, see page(s) 548-550
- For complete insert programme, see page(s) 835
- For ISO attribute explanation, see page 16

Designation	Item number	Type of mounting	DC	DCX	ZEFP	APMXS	APMXE	DMM	LS	OAL	RP	RMPX°	Cmin	Cmax	RPMX	Weight	Insert
			mm	mm		mm	mm	mm	mm	mm	mm		mm	mm		kg	
R217.21-1416.0-LP06.2A	02789713	Cylindrical	7,5	16,0	2	0,8	4,5	14,0	132,0	150,0	1,8	5,0	23,5	30,0	39000	0,2	LP..06
R217.21-1618.0-LP06.2A	02789715	Cylindrical	9,5	18,0	2	0,8	4,5	16,0	142,0	160,0	1,8	3,5	27,5	34,0	37000	0,3	LP..06
R217.21-1820.0-LP06.2A	02789717	Cylindrical	11,6	20,0	2	0,8	4,5	18,0	142,0	160,0	1,8	3,0	31,6	38,0	35000	0,4	LP..06
R217.21-2525.0-LP06.3A	02789720	Cylindrical	16,5	25,0	3	0,8	4,5	25,0	140,0	180,0	1,8	2,0	41,5	48,0	30000	0,7	LP..06
R217.21-2527.0-LP06.3A	02789722	Cylindrical	18,5	27,0	3	0,8	4,5	25,0	228,0	250,0	1,8	1,5	45,5	52,0	30000	0,4	LP..06
R217.21-3232.0-LP06.4A	02789725	Cylindrical	23,5	32,0	4	0,8	4,5	32,0	160,0	200,0	1,8	1,5	55,5	62,0	27000	0,4	LP..06
R217.21-3235.0-LP06.4A	02789729	Cylindrical	26,5	35,0	4	0,8	4,5	32,0	228,0	250,0	1,8	1,2	61,5	68,0	26000	0,4	LP..06

Spare Parts, included in delivery

For cutter	Insert key	Insert screw
R217.21-1416-1820	H4B-T08P	C02555-T08P
R217.21-2525-3235	H4B-T08P	C02506-T08P

Accessories

For cutter	Insert clamping torque	Torque key
R217.21-..	1.2NM	T00-08P12

Torque and fixed keys, see page 894

R217.21-LP06 – inch

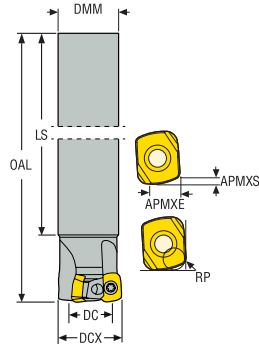

- For insert selection and cutting data recommendations, see page(s) 548-550
- For complete insert programme, see page(s) 835
- For ISO attribute explanation, see page 16

Designation	Item number	Type of mounting	DC	DCX	ZFP	APMXS	APMXE	DMM	LS	OAL	RP	RMPX°	C min	C max	RPMX	Weight	Insert
			inch	inch		inch	inch	inch	inch	inch	inch		inch	inch		lbs	
R217.21-00.625-0-LP06-2A	02789777	Cylindrical	0.290	0.625	2	0.030	0.177	0.625	5.000	6.000	0.071	5,0	0.915	1.171	39000	0.440	LP.06
R217.21-00.750-0-LP06-2A	02789778	Cylindrical	0.410	0.750	2	0.030	0.177	0.750	5.591	6.500	0.071	3,0	1.160	1.421	35000	0.660	LP.06
R217.21-01.00-0-LP06-3A	02789782	Cylindrical	0.660	1.000	3	0.030	0.177	1.000	5.512	7.000	0.071	2,0	1.660	1.921	30000	1.540	LP.06
R217.21-01.25-0-LP06-4A	02789785	Cylindrical	0.659	1.250	4	0.030	0.177	1.250	6.299	8.000	0.071	1,5	1.909	2.421	27000	2.200	LP.06

Spare Parts, included in delivery

For cutter	Insert key	Insert screw
R217.21-0.625-0.750	H4B-T08P	C02555-T08P
R217.21-1.00-1.50	H4B-T08P	C02506-T08P

Accessories

For cutter	Insert clamping torque	Torque key
R217.21-..	10.6IN.LBS	T00-08P12

Torque and fixed keys, see page 894

Square shoulder and slot milling cutters
Helical milling cutters
Face milling cutters
Disc milling cutters
High feed milling cutters
Copy milling cutters
Plunge milling cutters
Chamfer milling cutters
Spot facing cutters
Inserts

R217/220.21-LP06 – Metric

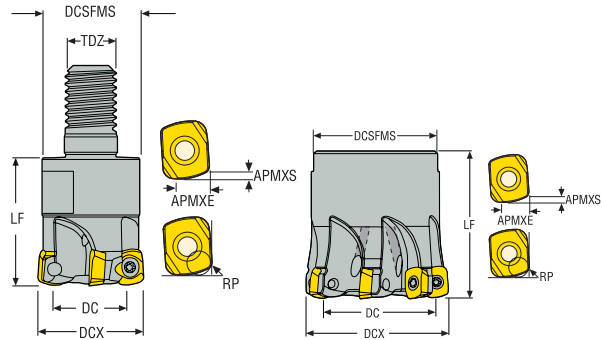

- For insert selection and cutting data recommendations, see page(s) 548-550
- For complete insert programme, see page(s) 835
- For ISO attribute explanation, see page 16

Designation	Item number	Type of mounting	DC	DCX	ZEFP	APMXS	APMXE	DCB	TDZ	DCSFMS	LF	RP	RMPX°	Cmin	Cmax	Weight	RPMX	Insert
			mm	mm		mm	mm	mm		mm	mm	mm		mm	mm	kg		
R217.21-0816.RE-LP06.2A	02789697	Combimaster	7,5	16,0	2	0,8	4,5	–	M8	13,5	20,0	1,8	5,0	23,5	30,0	0,1	39000	LP..06
R217.21-1020.RE-LP06.2A	02789700	Combimaster	11,5	20,0	2	0,8	4,5	–	M10	18,5	28,0	1,8	3,0	31,5	38,0	0,1	35000	LP..06
R217.21-1020.RE-LP06.3A	02789701	Combimaster	11,5	20,0	3	0,8	4,5	–	M10	18,5	28,0	1,8	3,0	31,5	38,0	0,1	35000	LP..06
R217.21-1225.RE-LP06.3A	02789702	Combimaster	16,5	25,0	3	0,8	4,5	–	M12	23,0	30,0	1,8	2,0	41,5	48,0	0,3	30000	LP..06
R217.21-1225.RE-LP06.4A	02789705	Combimaster	16,5	25,0	4	0,8	4,5	–	M12	23,0	30,0	1,8	2,0	41,5	48,0	0,2	30000	LP..06
R217.21-1632.RE-LP06.5A	02789708	Combimaster	23,5	32,0	5	0,8	4,5	–	M16	30,0	35,0	1,8	1,5	55,5	62,0	0,3	27000	LP..06
R217.21-1635.RE-LP06.5A	02789711	Combimaster	26,5	35,0	5	0,8	4,5	–	M16	30,0	35,0	1,8	1,5	61,5	68,0	0,3	26000	LP..06
R217.21-2040.RE-LP06.7A	02928084	Combimaster	31,5	40,0	7	0,8	4,5	–	M20	36,5	40,0	1,8	0,9	71,5	78,0	0,4	24000	LP..06
R220.21-0035-LP06.6A	02789734	Arbor	26,5	35,0	6	0,8	4,5	16,0	–	32,0	35,0	1,8	1,29	61,5	68,0	0,2	26000	LP..06
R220.21-0040-LP06.6A	02892228	Arbor	31,5	40,0	6	0,8	4,5	16,0	–	32,0	40,0	1,8	0,9	71,5	78,0	0,3	24000	LP..06

For Combimaster Shanks, see Machining Navigator Tooling System

Spare Parts, included in delivery

For cutter	Arbor screw	Insert key	Insert screw
R217.21-0816-1020	–	H4B-T08P	C02555-T08P
R217.21-1225-2040	–	H4B-T08P	C02506-T08P
R220.21-..	220.17-689	H4B-T08P	C02506-T08P

Accessories

For cutter	Insert clamping torque	Torque key
R217/220.21-..	1.2NM	T00-08P12

Torque and fixed keys, see page 894

R217/220.21-LP06 – inch

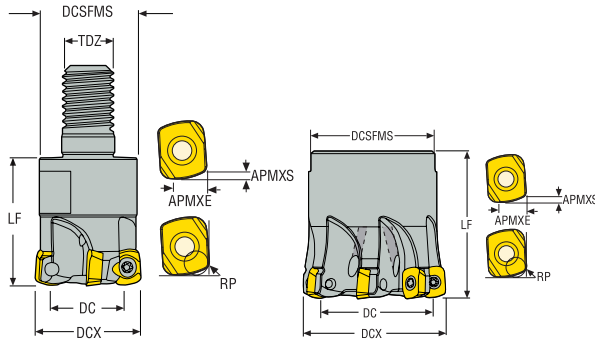

- For insert selection and cutting data recommendations, see page(s) 548-550
- For complete insert programme, see page(s) 835
- For ISO attribute explanation, see page 16

Designation	Item number	Type of mounting	DC	DCX	ZEFP	APMXS	APMXE	DCB	TDZ	DCSFMS	LF	RP	RMPX°	C min	C max	Weight	RPMX	Insert
			inch	inch		inch	inch	inch		inch	inch	inch		inch	inch	lbs		
R217.21-00.625-08RE-LP06-2A	02789772	Combimaster	0.290	0.625	2	0.031	0.177	-	M8	0.531	0.787	0.071	5,0	0.915	1.171	0.040	39000	LP.06
R217.21-00.750-10RE-LP06-3A	02789773	Combimaster	0.409	0.750	3	0.031	0.177	-	M10	0.728	1.102	0.071	3,0	1.159	1.421	0.110	35000	LP.06
R217.21-01.00-12RE-LP06-3A	02789774	Combimaster	0.660	1.000	3	0.031	0.177	-	M12	0.906	1.181	0.071	2,0	1.660	1.921	0.440	30000	LP.06
R217.21-01.00-12RE-LP06-4A	02789775	Combimaster	0.660	1.000	4	0.031	0.177	-	M12	0.906	1.181	0.071	2,0	1.660	1.921	0.440	30000	LP.06
R217.21-01.25-16RE-LP06-5A	02789776	Combimaster	0.909	1.250	5	0.031	0.177	-	M16	1.181	1.378	0.071	1,2	2.159	2.421	0.660	27000	LP.06
R217.21-01.50-20RE-LP06.7A	02928069	Combimaster	1.181	1.500	7	0.031	0.177	-	M20	1.437	1.575	0.071	0,9	2.681	2.921	0.660	24000	LP.06
R220.21-01.50-LP06-6A	02892229	Arbor	1.165	1.500	6	0.031	0.177	0.500	-	1.260	1.500	0.071	1,0	2.665	2.921	0.440	25000	LP.06

For Combimaster Shanks, see Machining Navigator Tooling System

Spare Parts, included in delivery

For cutter	Arbor screw	Insert key	Insert screw
R217.21-0.625-0.750	-	H4B-T08P	C02555-T08P
R217.21-1.00-1.50	-	H4B-T08P	C02506-T08P
R220.21-..	UC6S1/4UNFX1	H4B-T08P	C02506-T08P

Accessories

For cutter	Insert clamping torque	Torque key
R217/220.21-..	10.6IN.LBS	T00-08P12

Torque and fixed keys, see page 894

Square shoulder and slot milling cutters

Helical milling cutters

Face milling cutters

Disc milling cutters

High feed milling cutters

Copy milling cutters

Plunge milling cutters

Chamfer milling cutters

Spot facing cutters

Inserts

R217/220.21-LP06 – Insert selection – mm/Inch

SMG		a_p		f_z		
				100%	70%	30%
P1	LPHT060310TR-M06 MP2501	0,70	0,70	0,70	0,70	0,85
		0,028	0,028	0,028	0,028	0,034
P2	LPHT060310TR-M06 MP2501	0,70	0,70	0,70	0,70	0,85
		0,028	0,028	0,028	0,028	0,034
P3	LPHT060310TR-M06 MP2501	0,70	0,65	0,65	0,65	0,80
		0,028	0,026	0,026	0,026	0,032
P4	LPHT060310TR-M06 MP2501	0,70	0,65	0,65	0,65	0,80
		0,028	0,026	0,026	0,026	0,032
P5	LPHT060310TR-M06 MP2501	0,70	0,65	0,65	0,65	0,75
		0,028	0,026	0,026	0,026	0,030
P6	LPHT060310TR-M06 MP2501	0,70	0,65	0,65	0,65	0,75
		0,028	0,026	0,026	0,026	0,030
P7	LPHW060310TR-MD07 MP2501	0,70	0,75	0,75	0,75	0,90
		0,028	0,030	0,030	0,030	0,036
P8	LPHW060310TR-MD07 MS2500	0,70	0,75	0,75	0,75	0,95
		0,028	0,030	0,030	0,030	0,038
P11	LPHW060310TR-MD07 MS2500	0,70	0,75	0,75	0,75	0,90
		0,028	0,030	0,030	0,030	0,036
P12	LPHW060310TR-MD07 MS2500	0,60	0,55	0,55	0,55	0,65
		0,024	0,022	0,022	0,022	0,026
M1	LPHT060310TR-ME05 MS2050	0,70	0,60	0,60	0,60	0,70
		0,028	0,024	0,024	0,024	0,028
M2	LPHT060310TR-ME05 MS2050	0,70	0,55	0,55	0,55	0,65
		0,028	0,022	0,022	0,022	0,026
M3	LPHT060310TR-ME05 MS2050	0,60	0,46	0,46	0,46	0,55
		0,024	0,018	0,018	0,018	0,022
M4	LPHT060310TR-M06 T350M	0,44	0,55	0,55	0,55	0,65
		0,017	0,022	0,022	0,022	0,026
M5	LPHT060310TR-M06 T350M	0,44	0,55	0,55	0,55	0,65
		0,017	0,022	0,022	0,022	0,026
K1	LPHW060310TR-D06 MP3000	0,70	0,70	0,70	0,70	0,85
		0,028	0,028	0,028	0,028	0,034
K2	LPHW060310TR-D06 MP3000	0,70	0,65	0,65	0,65	0,75
		0,028	0,026	0,026	0,026	0,030
K3	LPHW060310TR-D06 MP3000	0,70	0,65	0,65	0,65	0,75
		0,028	0,026	0,026	0,026	0,030
K4	LPHW060310TR-D06 MP3000	0,70	0,65	0,65	0,65	0,75
		0,028	0,026	0,026	0,026	0,030
K5	LPHW060310TR-D06 MP3000	0,70	0,55	0,55	0,55	0,70
		0,028	0,022	0,022	0,022	0,028
K6	LPHW060310TR-D06 MP3000	0,70	0,65	0,65	0,65	0,75
		0,028	0,026	0,026	0,026	0,030
K7	LPHW060310TR-D06 MP3000	0,70	0,55	0,55	0,55	0,70
		0,028	0,022	0,022	0,022	0,028
N1	LPHT060310ER-E05 H25	0,70	0,75	0,75	0,75	0,90
		0,028	0,030	0,030	0,030	0,036
N2	LPHT060310ER-E05 H25	0,70	0,75	0,75	0,75	0,90
		0,028	0,030	0,030	0,030	0,036
N3	LPHT060310ER-E05 H25	0,70	0,75	0,75	0,75	0,90
		0,028	0,030	0,030	0,030	0,036
N11	LPHT060310ER-E05 H25	0,70	0,75	0,75	0,75	0,90
		0,028	0,030	0,030	0,030	0,036
S1	LPHT060310TR-M06 MS2500	0,44	0,55	0,55	0,55	0,65
		0,017	0,022	0,022	0,022	0,026
S2	LPHT060310TR-M06 MS2500	0,44	0,55	0,55	0,55	0,65
		0,017	0,022	0,022	0,022	0,026
S3	LPHT060310TR-M06 MS2500	0,44	0,50	0,50	0,50	0,60
		0,017	0,020	0,020	0,020	0,024
S11	LPHT060310TR-M06 MS2050	0,50	0,60	0,60	0,60	0,70
		0,020	0,024	0,024	0,024	0,028
S12	LPHT060310TR-M06 MS2050	0,50	0,60	0,60	0,60	0,70
		0,020	0,024	0,024	0,024	0,028
S13	LPHT060310TR-M06 MS2050	0,44	0,55	0,55	0,55	0,65
		0,017	0,022	0,022	0,022	0,026
H5	LPHW060310TR-D06 MH1000	0,44	0,44	0,44	0,44	0,55
		0,017	0,017	0,017	0,017	0,022
H8	LPHW060310TR-D06 MH1000	0,40	0,34	0,34	0,34	0,40
		0,016	0,013	0,013	0,013	0,016
H11	LPHW060310TR-D06 MP3000	0,44	0,44	0,44	0,44	0,55
		0,017	0,017	0,017	0,017	0,022
H12	LPHW060310TR-D06 MH1000	0,40	0,34	0,34	0,34	0,40
		0,016	0,013	0,013	0,013	0,016
H21	LPHW060310TR-D06 MH1000	0,40	0,34	0,34	0,34	0,40
		0,016	0,013	0,013	0,013	0,016

SMG = Seco material group
 f_z = mm/tooth (in/tooth), v_c = m/min (sf/min), a_p/DC = %
 All cutting data are start values

R217/220.21-LP06 – Cutting data $v_c = (m/min)/(sf/min)$

SMG	MP2050			MP2501			MP3000			T350M			F40M		
	100%	70%	30%	100%	70%	30%	100%	70%	30%	100%	70%	30%	100%	70%	30%
P1	295	335	405	300	340	410	280	325	390	260	300	360	225	260	310
	970	1100	1325	980	1125	1350	920	1075	1275	850	980	1175	740	850	1025
P2	285	325	395	290	335	400	275	315	380	255	290	350	220	250	305
	940	1075	1300	950	1100	1300	900	1025	1250	840	950	1150	720	820	1000
P3	250	285	345	255	295	350	240	275	330	220	255	305	195	220	265
	820	940	1125	840	970	1150	790	900	1075	720	840	1000	640	720	870
P4	220	255	305	225	260	310	215	245	290	195	225	270	170	195	235
	720	840	1000	740	850	1025	710	800	950	640	740	890	560	640	770
P5	210	240	290	215	245	295	205	235	280	185	215	255	160	185	225
	690	790	950	710	800	970	670	770	920	610	710	840	520	610	740
P6	235	270	325	240	275	330	230	260	315	210	240	290	180	210	250
	770	890	1075	790	900	1075	750	850	1025	690	790	950	590	690	820
P7	225	255	305	225	260	310	215	245	295	200	225	270	170	195	235
	740	840	1000	740	850	1025	710	800	970	660	740	890	560	640	770
P8	210	240	290	215	245	295	205	235	280	185	215	255	160	185	225
	690	790	950	710	800	970	670	770	920	610	710	840	520	610	740
P11	215	250	300	220	255	305	210	240	285	190	220	265	165	190	230
	710	820	980	720	840	1000	690	790	940	620	720	870	540	620	750
P12	145	165	195	145	165	200	140	160	190	125	145	175	110	125	150
	475	540	640	475	540	660	460	520	620	410	475	570	360	410	490
M1	205	235	280	210	240	290	205	235	285	195	225	270	175	205	245
	670	770	920	690	790	950	670	770	940	640	740	890	570	670	800
M2	170	195	230	170	200	235	170	195	235	160	185	220	145	170	200
	560	640	750	560	660	770	560	640	770	520	610	720	475	560	660
M3	135	155	190	140	160	195	140	160	190	130	150	180	120	135	165
	445	510	620	460	520	640	460	520	620	425	490	590	395	445	540
M4	105	120	145	110	125	150	110	120	145	100	115	140	95	105	125
	345	395	475	360	410	490	360	395	475	330	375	460	310	345	410
M5	90	100	120	90	100	125	90	100	120	85	95	115	75	85	105
	295	330	395	295	330	410	295	330	395	280	310	375	245	280	345
K1	—	—	—	230	265	315	220	250	300	200	230	275	175	200	240
	—	—	—	750	870	1025	720	820	980	660	750	900	570	660	790
K2	—	—	—	205	235	280	195	220	265	175	205	245	155	175	210
	—	—	—	670	770	920	640	720	870	570	670	800	510	570	690
K3	—	—	—	170	200	235	165	185	225	150	170	205	130	150	180
	—	—	—	560	660	770	540	610	740	490	560	670	425	490	590
K4	—	—	—	165	190	225	155	180	215	145	165	195	125	145	170
	—	—	—	540	620	740	510	590	710	475	540	640	410	475	560
K5	—	—	—	100	115	140	95	110	130	90	100	120	75	90	105
	—	—	—	330	375	460	310	360	425	295	330	395	245	295	345
K6	—	—	—	145	165	200	135	155	190	125	145	175	110	125	150
	—	—	—	475	540	660	445	510	620	410	475	570	360	410	490
K7	—	—	—	130	150	180	125	140	170	115	130	155	100	115	135
	—	—	—	425	490	590	410	460	560	375	425	510	330	375	445
N1	—	—	—	—	—	—	1600	1850	2225	—	—	—	1275	1475	1775
	—	—	—	—	—	—	5250	6075	7300	—	—	—	4175	4850	5825
N2	—	—	—	—	—	—	650	740	900	—	—	—	520	590	720
	—	—	—	—	—	—	2125	2425	2950	—	—	—	1700	1925	2350
N3	—	—	—	—	—	—	430	495	600	—	—	—	345	395	480
	—	—	—	—	—	—	1400	1625	1975	—	—	—	1125	1300	1575
N11	—	—	—	—	—	—	495	570	690	—	—	—	395	455	550
	—	—	—	—	—	—	1625	1875	2275	—	—	—	1300	1500	1800
S1	50	60	70	55	60	70	50	55	70	48	55	65	43	49	60
	165	195	230	180	195	230	165	180	230	155	180	215	140	160	195
S2	42	47	55	43	48	60	40	45	55	38	43	50	35	39	47
	140	155	180	140	155	195	130	150	180	125	140	165	115	130	155
S3	37	42	50	38	43	50	36	41	48	34	38	46	31	35	42
	120	140	165	125	140	165	120	135	155	110	125	150	100	115	140
S11	75	85	100	75	85	100	70	80	95	65	75	90	60	70	85
	245	280	330	245	280	330	230	260	310	215	245	295	195	230	280
S12	50	60	70	50	60	70	48	55	65	46	55	65	42	48	55
	165	195	230	165	195	230	155	180	215	150	180	215	140	155	180
S13	29	33	40	30	34	41	28	32	38	27	30	36	24	27	33
	95	110	130	100	110	135	90	105	125	90	100	120	80	90	110
H5	—	—	—	46	50	60	45	50	60	44	50	60	38	44	50
	—	—	—	150	165	195	150	165	195	145	165	195	125	145	165
H8	—	—	—	49	55	65	48	55	65	47	55	65	41	47	55
	—	—	—	160	180	215	155	180	215	155	180	215	135	155	180
H11	55	65	75	60	65	80	55	65	75	55	65	75	49	55	65
	180	215	245	195	215	260	180	215	245	180	215	245	160	180	215
H12	95	110	125	95	110	130	90	105	125	85	95	115	75	85	100
	310	360	410	310	360	425	295	345	410	280	310	375	245	280	330
H21	—	—	—	49	55	65	48	55	65	47	55	65	41	47	55
	—	—	—	160	180	215	155	180	215	155	180	215	135	155	180

Square shoulder and slot milling cutters
Helical milling cutters
Face milling cutters
Disc milling cutters
High feed milling cutters
Copy milling cutters
Plunge milling cutters
Chamfer milling cutters
Spot facing cutters
Inserts

R217/220.21-LP06 – Cutting data $v_c = (m/min)/(sf/min)$

SMG	MM4500			MS2050			MS2500			MH1000			H25		
	100%	70%	30%	100%	70%	30%	100%	70%	30%	100%	70%	30%	100%	70%	30%
P1	200	230	275	250	285	345	325	375	450	—	—	—	—	—	—
	660	750	900	820	940	1125	1075	1225	1475	—	—	—	—	—	—
P2	190	220	265	240	280	335	315	365	435	—	—	—	—	—	—
	620	720	870	790	920	1100	1025	1200	1425	—	—	—	—	—	—
P3	170	195	230	210	245	290	280	320	380	—	—	—	—	—	—
	560	640	750	690	800	950	920	1050	1250	—	—	—	—	—	—
P4	150	170	205	185	215	255	245	280	335	—	—	—	—	—	—
	490	560	670	610	710	840	800	920	1100	—	—	—	—	—	—
P5	140	165	200	180	205	245	235	270	320	—	—	—	—	—	—
	460	540	660	590	670	800	770	890	1050	—	—	—	—	—	—
P6	165	190	220	200	230	275	260	300	360	—	—	—	—	—	—
	540	620	720	660	750	900	850	980	1175	—	—	—	—	—	—
P7	155	180	210	190	215	260	250	285	340	—	—	—	—	—	—
	510	590	690	620	710	850	820	940	1125	—	—	—	—	—	—
P8	140	165	195	180	205	245	235	270	320	—	—	—	—	—	—
	460	540	640	590	670	800	770	890	1050	—	—	—	—	—	—
P11	150	170	205	185	210	255	240	275	330	—	—	—	—	—	—
	490	560	670	610	690	840	790	900	1075	—	—	—	—	—	—
P12	95	110	130	120	140	165	160	180	215	—	—	—	—	—	—
	310	360	425	395	460	540	520	590	710	—	—	—	—	—	—
M1	165	190	225	195	225	270	225	260	315	—	—	—	—	—	—
	540	620	740	640	740	890	740	850	1025	—	—	—	—	—	—
M2	135	155	190	160	185	220	185	215	255	—	—	—	—	—	—
	445	510	620	520	610	720	610	710	840	—	—	—	—	—	—
M3	110	125	150	130	150	180	150	175	205	—	—	—	—	—	—
	360	410	490	425	490	590	490	570	670	—	—	—	—	—	—
M4	85	100	120	100	115	140	120	135	165	—	—	—	—	—	—
	280	330	395	330	375	460	395	445	540	—	—	—	—	—	—
M5	75	85	100	85	95	115	100	115	135	—	—	—	—	—	—
	245	280	330	280	310	375	330	375	445	—	—	—	—	—	—
K1	—	—	—	—	—	—	—	—	—	235	270	320	—	—	—
	—	—	—	—	—	—	—	—	—	770	890	1050	—	—	—
K2	—	—	—	—	—	—	—	—	—	205	235	285	—	—	—
	—	—	—	—	—	—	—	—	—	670	770	940	—	—	—
K3	—	—	—	—	—	—	—	—	—	175	200	240	—	—	—
	—	—	—	—	—	—	—	—	—	570	660	790	—	—	—
K4	—	—	—	—	—	—	—	—	—	165	190	230	—	—	—
	—	—	—	—	—	—	—	—	—	540	620	750	—	—	—
K5	—	—	—	—	—	—	—	—	—	105	120	140	—	—	—
	—	—	—	—	—	—	—	—	—	345	395	460	—	—	—
K6	—	—	—	—	—	—	—	—	—	145	170	200	—	—	—
	—	—	—	—	—	—	—	—	—	475	560	660	—	—	—
K7	—	—	—	—	—	—	—	—	—	135	155	180	—	—	—
	—	—	—	—	—	—	—	—	—	445	510	590	—	—	—
N1	—	—	—	—	—	—	—	—	—	—	—	—	1325	1525	1825
	—	—	—	—	—	—	—	—	—	—	—	—	4350	5000	6000
N2	—	—	—	—	—	—	—	—	—	—	—	—	540	620	740
	—	—	—	—	—	—	—	—	—	—	—	—	1775	2025	2425
N3	—	—	—	—	—	—	—	—	—	—	—	—	360	410	495
	—	—	—	—	—	—	—	—	—	—	—	—	1175	1350	1625
N11	—	—	—	—	—	—	—	—	—	—	—	—	410	470	570
	—	—	—	—	—	—	—	—	—	—	—	—	1350	1550	1875
S1	27	30	36	48	55	65	60	65	80	—	—	—	—	—	—
	90	100	120	155	180	215	195	215	260	—	—	—	—	—	—
S2	21	25	29	38	44	55	47	55	65	—	—	—	—	—	—
	70	80	95	125	145	180	155	180	215	—	—	—	—	—	—
S3	19	21	25	34	39	46	41	47	55	—	—	—	—	—	—
	60	70	80	110	130	150	135	155	180	—	—	—	—	—	—
S11	37	42	50	65	75	90	80	90	110	—	—	—	—	—	—
	120	140	165	215	245	295	260	295	360	—	—	—	—	—	—
S12	34	39	46	46	50	60	55	65	75	—	—	—	—	—	—
	110	130	150	150	165	195	180	215	245	—	—	—	—	—	—
S13	20	23	27	27	31	37	33	37	45	—	—	—	—	—	—
	65	75	90	90	100	120	110	120	150	—	—	—	—	—	—
H5	—	—	—	—	—	—	—	—	—	50	60	70	—	—	—
	—	—	—	—	—	—	—	—	—	165	195	230	—	—	—
H8	—	—	—	—	—	—	—	—	—	55	60	75	—	—	—
	—	—	—	—	—	—	—	—	—	180	195	245	—	—	—
H11	—	—	—	—	—	—	—	—	—	65	75	90	—	—	—
	—	—	—	—	—	—	—	—	—	215	245	295	—	—	—
H12	—	—	—	—	—	—	—	—	—	100	110	130	—	—	—
	—	—	—	—	—	—	—	—	—	330	360	425	—	—	—
H21	—	—	—	—	—	—	—	—	—	55	60	75	—	—	—
	—	—	—	—	—	—	—	—	—	180	195	245	—	—	—

R217.21-LP09 – inch

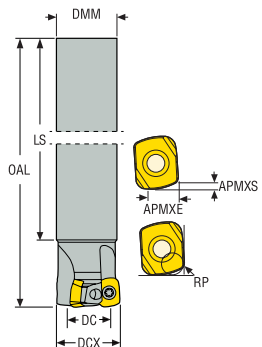

- For insert selection and cutting data recommendations, see page(s) 555-557
- For complete insert programme, see page(s) 835
- For ISO attribute explanation, see page 16

Designation	Item number	Type of mounting	DC	DCX	ZFP	APMXS	APMXE	DMM	LS	OAL	RP	RMPX°	C min	C max	RPMX	Weight	Insert
			inch	inch		inch	inch	inch	inch	inch	inch		inch	inch		lbs	
R217.21-01.25-0-LP09-4A	03212900	Cylindrical	0.744	1.250	4	0.071	0.287	1.250	6.102	8.000	0.137	4,9	1.994	2.421	31200	2.430	LP..09
R217.21-01.50-0-LP09-5A	03212901	Cylindrical	0.992	1.500	5	0.071	0.287	1.500	6.102	8.000	0.137	3,4	2.492	2.921	28500	3.530	LP..09

Spare Parts, included in delivery

For cutter	Insert key	Insert screw
R217.21-..	H4B-T15P	C04009-T15P

Accessories

For cutter	Insert clamping torque	Torque key
R217.21-..	31.0IN.LBS	T00-15P35

Torque and fixed keys, see page 894

Square shoulder and slot milling cutters

Helical milling cutters

Face milling cutters

Disc milling cutters

High feed milling cutters

Copy milling cutters

Plunge milling cutters

Chamfer milling cutters

Spot facing cutters

Inserts

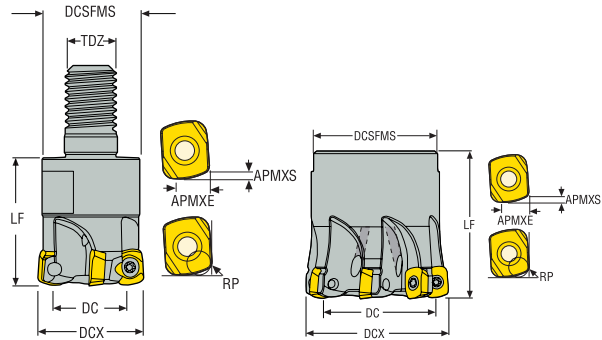

R220.21-LP09 – Metric



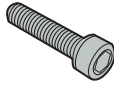

- For insert selection and cutting data recommendations, see page(s) 555-557
- For complete insert programme, see page(s) 835
- For ISO attribute explanation, see page 16

Designation	Item number	Type of mounting	DC	DCX	ZEFP	APMXS	APMXE	DCB	TDZ	DCSFMS	LF	RP	RMPX°	Cmin	Cmax	Weight	RPMX	Insert
			mm	mm		mm	mm	mm		mm	mm	mm		mm	mm	kg		
R217.21-1225.RE-LP09.2A	03212883	Combimaster	12,0	25,0	2	1,8	7,3	–	M12	23,0	35,0	3,49	8,8	37,0	48,0	0,2	35200	LP.09
R217.21-1632.RE-LP09.3A	03212884	Combimaster	19,1	32,0	3	1,8	7,3	–	M16	30,0	35,0	3,45	4,8	51,1	62,0	0,2	31100	LP.09
R217.21-1632.RE-LP09.4A	03212885	Combimaster	19,1	32,0	4	1,8	7,3	–	M16	30,0	35,0	3,47	4,8	51,1	62,0	0,2	31100	LP.09
R217.21-1635.RE-LP09.4A	03212886	Combimaster	22,1	35,0	4	1,8	7,3	–	M16	30,0	35,0	3,47	4,0	57,1	68,0	0,2	29700	LP.09
R217.21-2040.RE-LP09.5A	03212887	Combimaster	27,0	40,0	5	1,8	7,3	–	M20	36,5	40,0	3,48	3,2	67,0	78,0	0,3	27800	LP.09
R217.21-2042.RE-LP09.4A	03252421	Combimaster	29,0	42,0	4	1,8	7,3	–	M20	36,5	40,0	3,45	2,9	71,0	82,0	0,3	27100	LP.09
R217.21-2042.RE-LP09.5A	03212888	Combimaster	28,9	42,0	5	1,8	7,3	–	M20	36,5	40,0	3,48	2,9	70,9	82,0	0,3	27100	LP.09
R220.21-0040-LP09.4A	03212889	Arbor	27,5	40,0	4	1,8	7,3	16,0	–	32,0	40,0	3,46	3,2	67,5	78,0	0,3	27800	LP.09
R220.21-0050-LP09.5A	03212890	Arbor	37,0	50,0	5	1,8	7,3	22,0	–	40,0	40,0	3,45	2,2	87,0	98,0	0,3	24800	LP.09
R220.21-0050-LP09.6A	03212891	Arbor	37,0	50,0	6	1,8	7,3	22,0	–	40,0	40,0	3,45	2,2	87,0	98,0	0,3	24800	LP.09
R220.21-0050-LP09.7A	03212892	Arbor	37,1	50,0	7	1,8	7,3	22,0	–	40,0	40,0	3,47	2,2	87,1	98,0	0,4	24800	LP.09
R220.21-0052-LP09.5A	03252422	Arbor	39,0	51,98	5	1,8	7,3	22,0	–	49,0	40,0	3,45	2,1	90,98	101,96	0,4	24400	LP.09
R220.21-0052-LP09.7A	03212893	Arbor	39,1	51,98	7	1,8	7,3	22,0	–	48,0	40,0	3,47	2,1	91,08	101,96	0,4	24400	LP.09
R220.21-0063-LP09.6A	03212894	Arbor	50,0	63,0	6	1,8	7,3	22,0	–	48,0	40,0	3,45	2,7	113,0	124,0	0,5	22100	LP.09
R220.21-0063-LP09.6A-27	03317247	Arbor	50,0	63,0	6	1,8	7,3	27,0	–	61,0	50,0	3,45	2,7	113,0	124,0	0,7	22100	LP.09
R220.21-0063-LP09.8A	03212895	Arbor	50,1	63,0	8	1,8	7,3	22,0	–	48,0	40,0	3,47	1,6	113,1	124,0	0,5	22100	LP.09
R220.21-0063-LP09.8A-27	03317248	Arbor	50,1	63,0	8	1,8	7,3	27,0	–	61,0	50,0	3,47	1,6	113,1	124,0	0,7	22100	LP.09
R220.21-0066-LP09.6A	03252423	Arbor	53,1	66,0	6	1,8	7,3	27,0	–	61,0	50,0	3,47	1,5	119,1	130,0	0,8	21600	LP.09
R220.21-0066-LP09.8A	03212896	Arbor	53,1	66,0	8	1,8	7,3	27,0	–	60,0	50,0	3,47	1,5	119,1	130,0	0,8	21600	LP.09
R220.21-0080-LP09.7A	03212897	Arbor	67,0	80,0	7	1,8	7,3	27,0	–	60,0	50,0	3,45	1,1	147,0	158,0	0,9	19600	LP.09
R220.21-0080-LP09.9A	03212898	Arbor	67,0	80,0	9	1,8	7,3	27,0	–	60,0	50,0	3,45	1,1	147,0	158,0	0,9	19600	LP.09
R220.21-0084-LP09.7A	03252424	Arbor	71,0	84,0	7	1,8	7,3	32,0	–	79,0	50,0	3,44	1,1	155,0	166,0	1,3	18600	LP.09
R220.21-0100-LP09.10A	03212899	Arbor	87,0	100,0	10	1,8	7,3	32,0	–	78,0	50,0	3,44	0,8	187,0	198,0	1,5	17600	LP.09

Spare Parts, included in delivery

For cutter	Arbor screw	Insert key	Insert screw
			
R217.21-..	-	H4B-T15P	C04009-T15P
R220.21-0040	MC6S8X30	H4B-T15P	C04009-T15P
R220.21-0050-0063	220.17-692	H4B-T15P	C04009-T15P
R220.21-0063-6A	220.17-692	H4B-T15P	C04011-T15P
R220.21-0063-6A-27	MC6S12X40	H4B-T15P	C04011-T15P
R220.21-0063-8A-27	MC6S12X40	H4B-T15P	C04009-T15P
R220.21-0066	MC6S12X35	H4B-T15P	C04009-T15P
R220.21-0080	MC6S12X35	H4B-T15P	C04011-T15P
R220.21-0084	MLC6S16X35	H4B-T15P	C04009-T15P
R220.21-0100	MLC6S16X35	H4B-T15PL	C04011-T15P

Accessories

For cutter	Insert clamping torque	Torque key
		
R217/220.21-..	3.5NM	T00-15P35

Torque and fixed keys, see page 894

Square shoulder and slot milling cutters
Helical milling cutters
Face milling cutters
Disc milling cutters
High feed milling cutters
Copy milling cutters
Plunge milling cutters
Chamfer milling cutters
Spot facing cutters
Inserts

R220.21-LP09 – inch

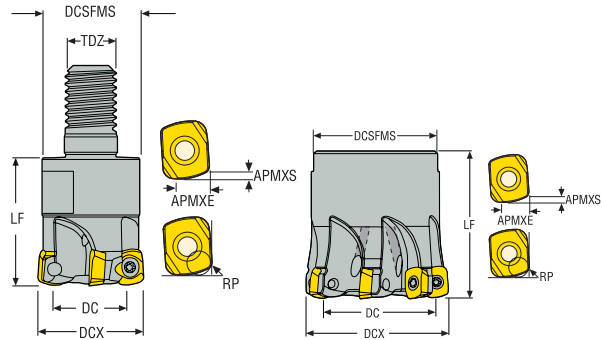

- For insert selection and cutting data recommendations, see page(s) 555-557
- For complete insert programme, see page(s) 835
- For ISO attribute explanation, see page 16

Designation	Item number	Type of mounting	DC	DCX	ZEPF	APMXS	APMXE	DCB	TDZ	DCSFMS	LF	RP	RMPX°	C min	C max	Weight	RPMX	Insert
			inch	inch		inch	inch	inch		inch	inch	inch		inch	inch	lbs		
R217.21-01.25-16RE-LP09-4A	03212902	Combimaster	0.744	1.250	4	0.071	0.287	-	M16	1.181	1.378	0.137	4,9	1.994	2.421	0.660	31100	LP.09
R220.21-02.00-LP09-6A	03212903	Arbor	1.488	2.000	6	0.071	0.287	0.750	-	1.750	1.500	0.136	2,2	3.488	3.921	0.660	24600	LP.09
R220.21-02.00-LP09-7A	03212904	Arbor	1.492	2.000	7	0.071	0.287	0.750	-	1.750	1.500	0.137	2,2	3.492	3.921	0.660	24600	LP.09
R220.21-02.50-LP09-6A	03212905	Arbor	1.988	2.500	6	0.071	0.287	0.750	-	1.750	1.500	0.136	1,6	4.488	4.921	1.100	22000	LP.09
R220.21-03.00-LP09-6A	03212907	Arbor	2.488	3.000	6	0.071	0.287	1.000	-	2.250	2.000	0.136	1,2	5.488	5.921	1.980	19600	LP.09
R220.21-03.00-LP09-8A	03212908	Arbor	2.488	3.000	8	0.071	0.287	1.000	-	2.250	2.000	0.136	1,2	5.488	5.921	2.200	20100	LP.09

Spare Parts, included in delivery

For cutter	Arbor screw	Insert key	Insert screw
R217.21-..	-	H4B-T15P	C04009-T15P
R220.21-02.00-02.50	UC6S3/8UNFX1-1/4	H4B-T15P	C04009-T15P
R220.21-03.00	UC6S1/2UNFX1-1/2	H4B-T15P	C04011-T15P

Accessories

For cutter	Insert clamping torque	Torque key
R217/220.21-..	31.0IN.LBS	T00-15P35

Torque and fixed keys, see page 894

R217/220.21-LP09 – Insert selection – mm/Inch

SMG		a _p	f _z		
			100%	70%	30%
P1	LPKT09T420TR-M13 MP2501	1,6	1,1	1,1	1,3
		0,065	0,044	0,044	0,050
P2	LPKT09T420TR-M13 MP2501	1,6	1,1	1,1	1,3
		0,065	0,044	0,044	0,050
P3	LPKT09T420TR-M13 MP2501	1,6	1,0	1,0	1,3
		0,065	0,040	0,040	0,050
P4	LPKT09T420TR-M13 MP2501	1,6	1,0	1,0	1,2
		0,065	0,040	0,040	0,048
P5	LPKT09T420TR-M13 MP2501	1,6	1,0	1,0	1,2
		0,065	0,040	0,040	0,048
P6	LPKT09T420TR-M13 MP2501	1,6	1,0	1,0	1,2
		0,065	0,040	0,040	0,048
P7	LPKW09T420TR-MD15 MP2501	1,6	1,1	1,1	1,4
		0,065	0,044	0,044	0,055
P8	LPKW09T420TR-MD15 MP2501	1,6	1,2	1,2	1,5
		0,065	0,048	0,048	0,060
P11	LPKW09T420TR-MD15 MP2501	1,6	1,1	1,1	1,4
		0,065	0,044	0,044	0,055
P12	LPKW09T420TR-MD15 MP2501	1,3	0,85	0,85	1,0
		0,050	0,034	0,034	0,040
M1	LPKT09T420TR-ME08 MS2050	1,6	0,70	0,70	0,80
		0,065	0,028	0,028	0,032
M2	LPKT09T420TR-ME08 MS2050	1,6	0,60	0,60	0,75
		0,065	0,024	0,024	0,030
M3	LPKT09T420TR-ME08 MS2050	1,3	0,55	0,55	0,65
		0,050	0,022	0,022	0,026
M4	LPKT09T420TR-M13 T350M	0,95	0,90	0,90	1,1
		0,038	0,036	0,036	0,044
M5	LPKT09T420TR-M13 T350M	0,95	0,90	0,90	1,1
		0,038	0,036	0,036	0,044
K1	LPKW09T420TR-D15 MK2050	1,6	1,3	1,3	1,5
		0,065	0,050	0,050	0,060
K2	LPKW09T420TR-D15 MK2050	1,6	1,2	1,2	1,4
		0,065	0,048	0,048	0,055
K3	LPKW09T420TR-D15 MK2050	1,6	1,2	1,2	1,4
		0,065	0,048	0,048	0,055
K4	LPKW09T420TR-D15 MK2050	1,6	1,2	1,2	1,4
		0,065	0,048	0,048	0,055
K5	LPKW09T420TR-D15 MK2050	1,6	1,0	1,0	1,3
		0,065	0,040	0,040	0,050
K6	LPKW09T420TR-D15 MK2050	1,6	1,2	1,2	1,4
		0,065	0,048	0,048	0,055
K7	LPKW09T420TR-D15 MK2050	1,6	1,0	1,0	1,3
		0,065	0,040	0,040	0,050
N1	LPHT09T420R-E08 H25	1,6	0,85	0,85	1,0
		0,065	0,034	0,034	0,040
N2	LPHT09T420R-E08 H25	1,6	0,85	0,85	1,0
		0,065	0,034	0,034	0,040
N3	LPHT09T420R-E08 H25	1,6	0,85	0,85	1,0
		0,065	0,034	0,034	0,040
N11	LPHT09T420R-E08 H25	1,6	0,85	0,85	1,0
		0,065	0,034	0,034	0,040
S1	LPKT09T420TR-M13 MS2500	0,95	0,90	0,90	1,1
		0,038	0,036	0,036	0,044
S2	LPKT09T420TR-M13 MS2500	0,95	0,90	0,90	1,1
		0,038	0,036	0,036	0,044
S3	LPKT09T420TR-M13 MS2500	0,95	0,85	0,85	1,0
		0,038	0,034	0,034	0,040
S11	LPKT09T420TR-ME08 MS2050	1,1	0,60	0,60	0,70
		0,044	0,024	0,024	0,028
S12	LPKT09T420TR-ME08 MS2050	1,1	0,60	0,60	0,70
		0,044	0,024	0,024	0,028
S13	LPKT09T420TR-ME08 MS2050	0,95	0,55	0,55	0,65
		0,038	0,022	0,022	0,026
H5	LPHW09T420TR-D12 MH1000	1,0	0,70	0,70	0,80
		0,040	0,028	0,028	0,032
H8	LPHW09T420TR-D12 MH1000	0,90	0,55	0,55	0,65
		0,036	0,022	0,022	0,026
H11	LPHW09T420TR-D12 MH1000	1,0	0,70	0,70	0,80
		0,040	0,028	0,028	0,032
H12	LPHW09T420TR-D12 MH1000	0,90	0,55	0,55	0,65
		0,036	0,022	0,022	0,026
H21	LPHW09T420TR-D12 MH1000	0,90	0,55	0,55	0,65
		0,036	0,022	0,022	0,026

SMG = Seco material group
f_z = mm/tooth (in/tooth), v_c = m/min (sf/min), a_p/DC = %
All cutting data are start values

Square shoulder and slot milling cutters
Helical milling cutters
Face milling cutters
Disc milling cutters
High feed milling cutters
Copy milling cutters
Plunge milling cutters
Chamfer milling cutters
Spot facing cutters
Inserts

R217/220.21-LP09 – Cutting data $v_c = (m/min)/(sf/min)$

SMG	MP2501			MP3000			T350M			F40M			MM4500			MK2050		
	100%	70%	30%	100%	70%	30%	100%	70%	30%	100%	70%	30%	100%	70%	30%	100%	70%	30%
P1	240	280	335	225	265	320	210	245	295	220	260	305	180	210	250	215	250	295
	790	920	1100	740	870	1050	690	800	970	720	850	1000	590	690	820	710	820	970
P2	235	270	325	220	255	310	205	235	285	210	245	300	170	200	240	200	235	285
	770	890	1075	720	840	1025	670	770	940	690	800	980	560	660	790	660	770	940
P3	205	240	280	195	230	265	180	210	245	185	215	260	150	175	210	180	210	245
	670	790	920	640	750	870	590	690	800	610	710	850	490	570	690	590	690	800
P4	180	210	255	170	200	240	160	185	220	165	190	230	135	155	185	155	185	220
	590	690	840	560	660	790	520	610	720	540	620	750	445	510	610	510	610	720
P5	175	205	245	165	190	230	150	175	210	160	185	220	130	150	180	150	175	210
	570	670	800	540	620	750	490	570	690	520	610	720	425	490	590	490	570	690
P6	195	230	275	185	215	260	170	200	235	180	210	245	145	170	200	175	200	235
	640	750	900	610	710	850	560	660	770	590	690	800	475	560	660	570	660	770
P7	185	215	255	175	205	245	160	185	225	170	200	235	140	160	190	165	190	225
	610	710	840	570	670	800	520	610	740	560	660	770	460	520	620	540	620	740
P8	175	205	235	165	190	225	150	175	205	155	185	220	125	150	180	150	175	205
	570	670	770	540	620	740	490	570	670	510	610	720	410	490	590	490	570	670
P11	180	210	250	170	200	235	155	180	220	165	195	225	135	155	185	160	185	220
	590	690	820	560	660	770	510	590	720	540	640	740	445	510	610	520	610	720
P12	120	140	165	115	130	155	105	120	145	110	125	150	90	100	120	105	120	145
	395	460	540	375	425	510	345	395	475	360	410	490	295	330	395	345	395	475
M1	170	195	235	165	190	230	155	180	220	170	200	240	145	170	210	—	—	—
	560	640	770	540	620	750	510	590	720	560	660	790	475	560	690	—	—	—
M2	140	165	195	135	160	190	130	150	180	145	170	200	125	145	170	—	—	—
	460	540	640	445	520	620	425	490	590	475	560	660	410	475	560	—	—	—
M3	115	135	160	110	130	155	105	125	150	115	135	160	100	115	140	—	—	—
	375	445	520	360	425	510	345	410	490	375	445	520	330	375	460	—	—	—
M4	90	105	125	90	100	120	85	95	115	90	105	125	80	90	110	—	—	—
	295	345	410	295	330	395	280	310	375	295	345	410	260	295	360	—	—	—
M5	75	85	105	75	85	100	70	80	95	75	90	105	65	75	90	—	—	—
	245	280	345	245	280	330	230	260	310	245	295	345	215	245	295	—	—	—
K1	185	215	260	175	205	245	160	185	225	170	195	235	—	—	—	215	255	310
	610	710	850	570	670	800	520	610	740	560	640	770	—	—	—	710	840	1025
K2	165	190	230	155	180	220	145	170	200	150	180	210	—	—	—	195	225	275
	540	620	750	510	590	720	475	560	660	490	590	690	—	—	—	640	740	900
K3	140	165	195	130	155	185	120	140	170	130	150	175	—	—	—	165	190	230
	460	540	640	425	510	610	395	460	560	425	490	570	—	—	—	540	620	750
K4	135	155	185	125	145	175	115	135	160	125	145	170	—	—	—	155	180	220
	445	510	610	410	475	570	375	445	520	410	475	560	—	—	—	510	590	720
K5	80	95	115	80	90	110	70	85	100	75	90	105	—	—	—	100	115	135
	260	310	375	260	295	360	230	280	330	245	295	345	—	—	—	330	375	445
K6	115	135	165	110	130	155	100	120	145	110	125	150	—	—	—	140	160	195
	375	445	540	360	425	510	330	395	475	360	410	490	—	—	—	460	520	640
K7	105	125	145	100	115	140	90	105	125	95	110	135	—	—	—	125	150	170
	345	410	475	330	375	460	295	345	410	310	360	445	—	—	—	410	490	560
N1	—	—	—	1275	1475	1775	—	—	—	1250	1450	1750	—	—	—	—	—	—
	—	—	—	4175	4850	5825	—	—	—	4100	4750	5750	—	—	—	—	—	—
N2	—	—	—	510	600	720	—	—	—	500	590	710	—	—	—	—	—	—
	—	—	—	1675	1975	2350	—	—	—	1650	1925	2325	—	—	—	—	—	—
N3	—	—	—	340	400	475	—	—	—	335	390	470	—	—	—	—	—	—
	—	—	—	1125	1300	1550	—	—	—	1100	1275	1550	—	—	—	—	—	—
N11	—	—	—	390	455	550	—	—	—	385	445	540	—	—	—	—	—	—
	—	—	—	1275	1500	1800	—	—	—	1275	1450	1775	—	—	—	—	—	—
S1	44	50	60	41	47	55	39	45	55	43	49	60	24	28	33	—	—	—
	145	165	195	135	155	180	130	150	180	140	160	195	80	90	110	—	—	—
S2	35	41	49	33	38	46	32	36	44	34	40	47	19	23	27	—	—	—
	115	135	160	110	125	150	105	120	145	110	130	155	60	75	90	—	—	—
S3	31	36	43	29	34	40	28	32	38	30	35	42	17	20	24	—	—	—
	100	120	140	95	110	130	90	105	125	100	115	140	55	65	80	—	—	—
S11	60	70	85	55	65	80	55	60	75	60	70	80	33	39	46	—	—	—
	195	230	280	180	215	260	180	195	245	195	230	260	110	130	150	—	—	—
S12	42	48	60	40	46	55	38	43	50	41	47	55	31	36	42	—	—	—
	140	155	195	130	150	180	125	140	165	135	155	180	100	120	140	—	—	—
S13	25	28	34	23	27	32	22	25	30	24	28	33	18	21	25	—	—	—
	80	90	110	75	90	105	70	80	100	80	90	110	60	70	80	—	—	—
H5	38	43	50	37	42	50	36	42	49	37	43	50	—	—	—	—	—	—
	125	140	165	120	140	165	120	140	160	120	140	165	—	—	—	—	—	—
H8	41	47	55	40	46	55	39	45	55	40	46	55	—	—	—	—	—	—
	135	155	180	130	150	180	130	150	180	130	150	180	—	—	—	—	—	—
H11	48	55	65	47	55	65	46	55	65	47	55	65	—	—	—	—	—	—
	155	180	215	155	180	215	150	180	215	155	180	215	—	—	—	—	—	—
H12	80	95	110	75	90	105	70	80	95	70	85	100	—	—	—	—	—	—
	260	310	360	245	295	345	230	260	310	230	280	330	—	—	—	—	—	—
H21	41	47	55	40	46	55	39	45	55	40	46	55	—	—	—	—	—	—
	135	155	180	130	150	180	130	150	180	130	150	180	—	—	—	—	—	—

R217/220.21-LP09 – Cutting data $v_c = (m/min)/(sf/min)$

SMG	MS2050			MS2500			MP2050			MH1000			H25		
	100%	70%	30%	100%	70%	30%	100%	70%	30%	100%	70%	30%	100%	70%	30%
P1	200	230	280	260	305	365	235	275	330	—	—	—	—	—	—
	660	750	920	850	1000	1200	770	900	1075	—	—	—	—	—	—
P2	195	225	270	255	295	355	230	265	320	—	—	—	—	—	—
	640	740	890	840	970	1175	750	870	1050	—	—	—	—	—	—
P3	170	200	235	225	265	305	205	235	275	—	—	—	—	—	—
	560	660	770	740	870	1000	670	770	900	—	—	—	—	—	—
P4	150	175	210	200	230	275	180	210	250	—	—	—	—	—	—
	490	570	690	660	750	900	590	690	820	—	—	—	—	—	—
P5	145	170	200	190	220	265	170	200	240	—	—	—	—	—	—
	475	560	660	620	720	870	560	660	790	—	—	—	—	—	—
P6	165	190	225	215	250	295	190	225	270	—	—	—	—	—	—
	540	620	740	710	820	970	620	740	890	—	—	—	—	—	—
P7	155	180	215	200	235	280	180	210	255	—	—	—	—	—	—
	510	590	710	660	770	920	590	690	840	—	—	—	—	—	—
P8	145	170	195	190	220	260	170	200	230	—	—	—	—	—	—
	475	560	640	620	720	850	560	660	750	—	—	—	—	—	—
P11	150	175	210	195	230	275	175	205	245	—	—	—	—	—	—
	490	570	690	640	750	900	570	670	800	—	—	—	—	—	—
P12	100	115	140	130	150	180	120	135	165	—	—	—	—	—	—
	330	375	460	425	490	590	395	445	540	—	—	—	—	—	—
M1	155	180	220	180	210	255	165	190	230	—	—	—	—	—	—
	510	590	720	590	690	840	540	620	750	—	—	—	—	—	—
M2	130	150	180	150	175	210	135	160	190	—	—	—	—	—	—
	425	490	590	490	570	690	445	520	620	—	—	—	—	—	—
M3	105	125	145	125	145	170	110	130	155	—	—	—	—	—	—
	345	410	475	410	475	560	360	425	510	—	—	—	—	—	—
M4	85	95	115	100	115	135	90	100	120	—	—	—	—	—	—
	280	310	375	330	375	445	295	330	395	—	—	—	—	—	—
M5	70	80	95	80	95	110	75	85	100	—	—	—	—	—	—
	230	260	310	260	310	360	245	280	330	—	—	—	—	—	—
K1	—	—	—	—	—	—	180	210	255	195	225	270	—	—	—
	—	—	—	—	—	—	590	690	840	640	740	890	—	—	—
K2	—	—	—	—	—	—	160	190	225	175	205	240	—	—	—
	—	—	—	—	—	—	520	620	740	570	670	790	—	—	—
K3	—	—	—	—	—	—	135	160	190	150	170	205	—	—	—
	—	—	—	—	—	—	445	520	620	490	560	670	—	—	—
K4	—	—	—	—	—	—	130	155	185	140	165	195	—	—	—
	—	—	—	—	—	—	425	510	610	460	540	640	—	—	—
K5	—	—	—	—	—	—	80	95	110	85	100	120	—	—	—
	—	—	—	—	—	—	260	310	360	280	330	395	—	—	—
K6	—	—	—	—	—	—	115	135	160	125	145	170	—	—	—
	—	—	—	—	—	—	375	445	520	410	475	560	—	—	—
K7	—	—	—	—	—	—	105	120	145	110	130	155	—	—	—
	—	—	—	—	—	—	345	395	475	360	425	510	—	—	—
N1	—	—	—	—	—	—	—	—	—	—	—	—	1225	1425	1725
	—	—	—	—	—	—	—	—	—	—	—	—	4025	4675	5650
N2	—	—	—	—	—	—	—	—	—	—	—	—	495	580	690
	—	—	—	—	—	—	—	—	—	—	—	—	1625	1900	2275
N3	—	—	—	—	—	—	—	—	—	—	—	—	330	385	460
	—	—	—	—	—	—	—	—	—	—	—	—	1075	1275	1500
N11	—	—	—	—	—	—	—	—	—	—	—	—	375	440	530
	—	—	—	—	—	—	—	—	—	—	—	—	1225	1450	1750
S1	39	45	55	48	55	65	43	49	60	—	—	—	—	—	—
	130	150	180	155	180	215	140	160	195	—	—	—	—	—	—
S2	32	36	43	39	44	50	35	40	47	—	—	—	—	—	—
	105	120	140	130	145	165	115	130	155	—	—	—	—	—	—
S3	28	32	38	34	39	46	30	35	42	—	—	—	—	—	—
	90	105	125	110	130	150	100	115	140	—	—	—	—	—	—
S11	55	65	75	65	75	90	60	70	85	—	—	—	—	—	—
	180	215	245	215	245	295	195	230	280	—	—	—	—	—	—
S12	38	44	50	46	55	65	41	48	55	—	—	—	—	—	—
	125	145	165	150	180	215	135	155	180	—	—	—	—	—	—
S13	22	25	30	27	31	37	24	28	33	—	—	—	—	—	—
	70	80	100	90	100	120	80	90	110	—	—	—	—	—	—
H5	—	—	—	—	—	—	37	42	50	43	50	60	—	—	—
	—	—	—	—	—	—	120	140	165	140	165	195	—	—	—
H8	—	—	—	—	—	—	40	46	55	47	55	65	—	—	—
	—	—	—	—	—	—	130	150	180	155	180	215	—	—	—
H11	—	—	—	—	—	—	47	55	65	55	65	75	—	—	—
	—	—	—	—	—	—	155	180	215	180	215	245	—	—	—
H12	—	—	—	—	—	—	80	90	110	85	95	115	—	—	—
	—	—	—	—	—	—	260	295	360	280	310	375	—	—	—
H21	—	—	—	—	—	—	40	46	55	47	55	65	—	—	—
	—	—	—	—	—	—	130	150	180	155	180	215	—	—	—

Square shoulder and slot milling cutters
Helical milling cutters
Face milling cutters
Disc milling cutters
High feed milling cutters
Copy milling cutters
Plunge milling cutters
Chamfer milling cutters
Spot facing cutters
Inserts



R217/220.21 HIGH FEED 4

Highfeed 4 for LO06 insert types, 4-cutting edge, double sided inserts.

The inserts is strong and reliable for applications with low demands on ramping capability. A wide selection of inserts and geometries make it easy to find the right combination for your application.

- Cutter range 20-63 mm (1 - 2.5 inch)
- Max depth of cut 0.9 mm
- First choice for ISO P & K materials in small-to-medium-size machines

Square shoulder and slot milling cutters

Helical milling cutters

Face milling cutters

Disc milling cutters

High feed milling cutters

Copy milling cutters

Plunge milling cutters

Chamfer milling cutters

Spot facing cutters

Inserts

R217.21-LO06 – Metric

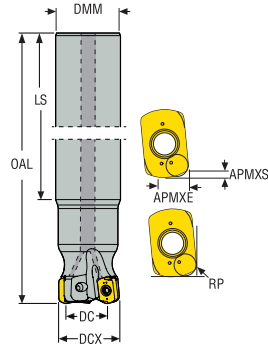

- For insert selection and cutting data recommendations, see page(s) 563-565
- For complete insert programme, see page(s) 830
- For ISO attribute explanation, see page 16

Designation	Item number	Type of mounting	DC	DCX	ZEFP	APMXS	APMXE	DMM	LS	OAL	RP	RMPX°	Cmin	Cmax	RPMX	Weight	Insert
			mm	mm		mm	mm	mm	mm	mm	mm		mm	mm		kg	
R217.21-1820.0-LO06.2A	02952673	Cylindrical	13,3	20,0	2	0,9	2,5	18,0	134,9	160,0	1,8	1,0	33,3	38,0	35000	0,4	LO..06
R217.21-2525.0-LO06.3A	02828469	Cylindrical	18,3	25,0	3	0,9	2,5	25,0	140,0	180,0	1,8	0,8	43,3	48,0	30000	0,7	LO..06
R217.21-2527.0-LO06.3A	02828470	Cylindrical	20,3	27,0	3	0,9	2,5	25,0	175,0	200,0	1,8	0,7	47,3	52,0	29000	0,8	LO..06
R217.21-3232.0-LO06.4A	02828474	Cylindrical	25,3	32,0	4	0,9	2,5	32,0	160,0	200,0	1,8	0,5	57,3	62,0	27000	1,2	LO..06

Spare Parts, included in delivery

For cutter	Insert key	Insert screw
R217.21-..	H4B-T08P	C02508-T08P

Accessories

For cutter	Insert clamping torque	Torque key
R217.21-..	1.2NM	T00-08P12

Torque and fixed keys, see page 894

Square shoulder and slot milling cutters

Helical milling cutters

Face milling cutters

Disc milling cutters

High feed milling cutters

Copy milling cutters

Plunge milling cutters

Chamfer milling cutters

Spot facing cutters

Inserts

R217.21-LO06 – inch

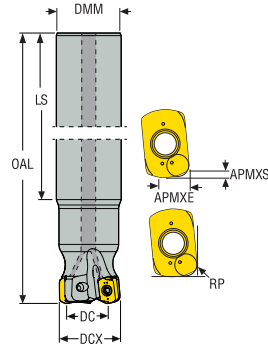

- For insert selection and cutting data recommendations, see page(s) 563-565
- For complete insert programme, see page(s) 830
- For ISO attribute explanation, see page 16

Designation	Item number	Type of mounting	DC	DCX	ZEFP	APMXS	APMXE	DMM	LS	OAL	RP	RMPX°	C min	C max	RPMX	Weight	Insert
			inch	inch		inch	inch	inch	inch	inch	inch		inch	inch		lbs	
R217.21-01.00-0-LO06-3A	02842018	Cylindrical	0.736	1.000	3	0.035	0.098	1.000	5.500	7.000	0.071	0,7	1.736	1.921	30000	1.540	LO..06
R217.21-01.25-0-LO06-4A	02842021	Cylindrical	0.984	1.250	4	0.035	0.098	1.250	6.500	8.000	0.071	0,5	2.234	2.421	27000	2.650	LO..06

Spare Parts, included in delivery

For cutter	Insert key	Insert screw
R217.21..	H4B-T08P	C02508-T08P

Accessories

For cutter	Insert clamping torque	Torque key
R217.21-..	10.6IN.LBS	T00-08P12

Torque and fixed keys, see page 894

Square shoulder and slot milling cutters
Helical milling cutters
Face milling cutters
Disc milling cutters
High feed milling cutters
Copy milling cutters
Plunge milling cutters
Chamfer milling cutters
Spot facing cutters
Inserts

R217/220.21-LO06 – Metric

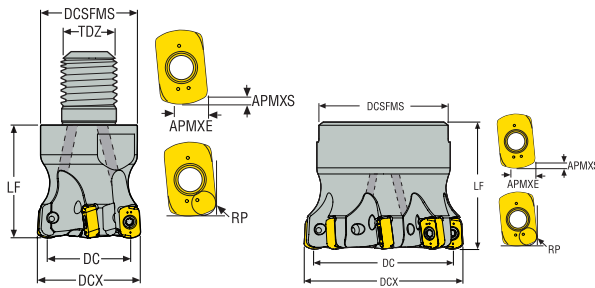

- For insert selection and cutting data recommendations, see page(s) 563-565
- For complete insert programme, see page(s) 830
- For ISO attribute explanation, see page 16

Designation	Item number	Type of mounting	DC	DCX	ZFP	APMXS	APMXE	DCB	TDZ	DCSFMS	LF	RP	RMPX°	Cmin	Cmax	Weight	RPMX	Insert
			mm	mm		mm	mm	mm		mm	mm	mm		mm	mm	kg		
R217.21-1020.RE-LO06.2A	03020137	Combimaster	13,3	20,0	2	0,9	2,5	-	M10	18,5	28,0	1,8	1,0	33,3	38,0	0,1	35000	LO..06
R217.21-1225.RE-LO06.3A	03020140	Combimaster	18,3	25,0	3	0,9	2,5	-	M12	23,0	30,0	1,8	0,8	43,3	48,0	0,1	30000	LO..06
R217.21-1225.RE-LO06.4A	02828468	Combimaster	18,3	25,0	4	0,9	2,5	-	M12	23,0	30,0	1,8	0,8	43,3	48,0	0,2	30000	LO..06
R217.21-1632.RE-LO06.4A	02927092	Combimaster	25,3	32,0	4	0,9	2,5	-	M16	30,0	35,0	1,8	0,5	57,3	62,0	0,2	27000	LO..06
R217.21-1632.RE-LO06.5A	02828471	Combimaster	25,3	32,0	5	0,9	2,5	-	M16	30,0	35,0	1,8	0,5	57,3	62,0	0,3	27000	LO..06
R217.21-1635.RE-LO06.5A	02828472	Combimaster	28,3	35,0	5	0,9	2,5	-	M16	30,0	35,0	1,8	0,5	63,3	68,0	0,2	26000	LO..06
R217.21-1640.RE-LO06.5A	02828478	Combimaster	33,3	40,0	5	0,9	2,5	-	M16	30,0	35,0	1,8	0,4	73,3	78,0	0,2	18000	LO..06
R217.21-2040.RE-LO06.6A	02991177	Combimaster	33,0	40,0	6	0,9	2,5	-	M20	36,5	40,0	1,8	0,4	73,3	78,0	0,4	18000	LO..06
R220.21-0035-LO06.6A	02952739	Arbor	28,3	35,0	6	0,9	2,5	16,0	-	32,0	35,0	1,8	0,5	63,3	68,0	0,2	24500	LO..06
R220.21-0040-LO06.7A	02927090	Arbor	33,3	40,0	7	0,9	2,5	16,0	-	35,0	40,0	1,8	0,4	73,3	78,0	0,3	18000	LO..06
R220.21-0042-LO06.7A	02828477	Arbor	35,3	42,0	7	0,9	2,5	16,0	-	35,0	40,0	1,8	0,4	77,3	82,0	0,2	18000	LO..06
R220.21-0050-LO06.8A	02927091	Arbor	43,3	50,0	8	0,9	2,5	22,0	-	42,0	40,0	1,8	0,3	93,3	98,0	0,3	16000	LO..06
R220.21-0052-LO06.8A	02952735	Arbor	45,3	52,0	8	0,9	2,5	22,0	-	42,0	40,0	1,8	0,3	97,3	102,0	0,4	16000	LO..06
R220.21-0063-LO06.9A	02952736	Arbor	56,3	63,0	9	0,9	2,5	22,0	-	47,0	40,0	1,8	0,25	119,3	124,0	0,5	15000	LO..06

For Combimaster Shanks, see Machining Navigator Tooling System

Spare Parts, included in delivery

For cutter	Arbor screw	Insert key	Insert screw
R217.21-..	-	H4B-T08P	C02508-T08P
R220.21- Ø35	MC6S8X25	H4B-T08P	C02508-T08P
R220.21- Ø40-42	220.17-689	H4B-T08P	C02508-T08P
R220.21- Ø50-63	220.17-692	H4B-T08P	C02508-T08P

Accessories

For cutter	Insert clamping torque	Torque key
R217/220.21-..	1.2NM	T00-08P12

Torque and fixed keys, see page 894

R217/220.21-LO06 – inch

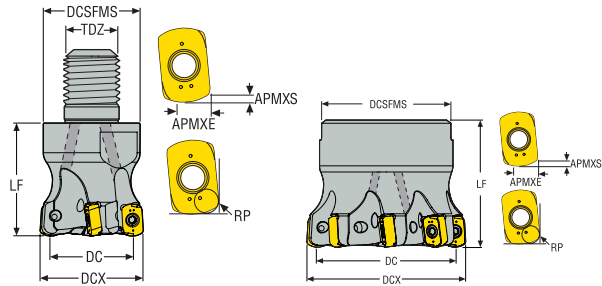

- For insert selection and cutting data recommendations, see page(s) 563-565
- For complete insert programme, see page(s) 830
- For ISO attribute explanation, see page 16

Designation	Item number	Type of mounting	DC	DCX	ZEPF	APMXS	APMXE	DCB	TDZ	DCSFMS	LF	RP	RMPX°	C min	C max	Weight	RPMX	Insert
			inch	inch		inch	inch	inch		inch	inch	inch		inch	inch	lbs		
R217.21-01.00-12RE-LO06-3A	02842016	Combimaster	0.736	1.000	3	0.035	0.098	–	M12	0.906	1.181	0.071	0,7	1.736	1.921	0.220	30000	LO..06
R217.21-01.00-12RE-LO06-4A	02842017	Combimaster	0.736	1.000	4	0.035	0.098	–	M12	0.906	1.181	0.071	0,7	1.736	1.921	0.220	30000	LO..06
R217.21-01.50-16RE-LO06-5A	02952695	Combimaster	1.236	1.500	5	0.035	0.098	–	M16	1.181	1.378	0.071	0,4	2.736	2.921	0.440	18000	LO..06
R217.21-01.50-20RE-LO06.6A	03002406	Combimaster	1.299	1.500	6	0.035	0.098	–	M20	1.437	1.575	0.071	0,4	2.736	2.921	0.660	18000	LO..06
R220.21-01.50-LO06-6A	02842022	Arbor	1.236	1.500	6	0.035	0.098	0.500	–	1.260	1.500	0.071	0,4	2.736	2.921	0.440	18000	LO..06
R220.21-02.00-LO06-8A	02952697	Arbor	1.736	2.000	8	0.035	0.098	0.750	–	1.654	1.500	0.071	0,3	3.736	3.921	0.880	16000	LO..06

For Combimaster Shanks, see Machining Navigator Tooling System

Spare Parts, included in delivery

For cutter	Arbor screw	Insert key	Insert screw
R217.21-..		H4B-T08P	C02508-T08P
R220.21-1.50	UC6S1/4UNFX1	H4B-T08P	C02508-T08P
R220.21-2.00-2.50	UC6S3/8UNFX1	H4B-T08P	C02508-T08P

Accessories

For cutter	Insert clamping torque	Torque key
R217/220.21-..	 10.6IN.LBS	T00-08P12

Torque and fixed keys, see page 894

R217/220.21-LO06 – Insert selection – mm/Inch

SMG		a _p	f _z		
			100%	70%	30%
P1	LOHT060310TR-ME06 T350M	0,80	0,55	0,55	0,60
		0,032	0,022	0,022	0,024
P2	LOHT060310TR-ME06 T350M	0,80	0,55	0,55	0,60
		0,032	0,022	0,022	0,024
P3	LOHT060310TR-ME06 T350M	0,80	0,50	0,50	0,60
		0,032	0,020	0,020	0,024
P4	LOHT060310TR-M07 MP2501	0,80	0,60	0,60	0,65
		0,032	0,024	0,024	0,026
P5	LOHT060310TR-M07 MP2501	0,80	0,55	0,55	0,65
		0,032	0,022	0,022	0,026
P6	LOHT060310TR-M07 MP2501	0,80	0,55	0,55	0,65
		0,032	0,022	0,022	0,026
P7	LOHT060310TR-M07 MP2501	0,80	0,55	0,55	0,65
		0,032	0,022	0,022	0,026
P8	LOHT060310TR-M07 MS2500	0,80	0,60	0,60	0,65
		0,032	0,024	0,024	0,026
P11	LOHT060310TR-M07 MS2500	0,80	0,55	0,55	0,65
		0,032	0,022	0,022	0,026
P12	LOHT060310TR-M07 MS2500	0,65	0,42	0,42	0,48
		0,026	0,017	0,017	0,019
M1	LOHT060310TR-ME06 MS2050	0,80	0,55	0,55	0,60
		0,032	0,022	0,022	0,024
M2	LOHT060310TR-ME06 MS2050	0,80	0,48	0,48	0,55
		0,032	0,019	0,019	0,022
M3	LOHT060310TR-ME06 MS2050	0,65	0,44	0,44	0,48
		0,026	0,017	0,017	0,019
M4	LOHT060310TR-ME06 T350M	0,48	0,44	0,44	0,50
		0,019	0,017	0,017	0,020
M5	LOHT060310TR-ME06 T350M	0,48	0,44	0,44	0,50
		0,019	0,017	0,017	0,020
K1	LOHT060310TR-MD07 MK2050	0,80	0,60	0,60	0,70
		0,032	0,024	0,024	0,028
K2	LOHT060310TR-MD07 MK2050	0,80	0,55	0,55	0,65
		0,032	0,022	0,022	0,026
K3	LOHT060310TR-MD07 MK2050	0,80	0,55	0,55	0,65
		0,032	0,022	0,022	0,026
K4	LOHW060310TR-D07 MP1500	0,80	0,55	0,55	0,65
		0,032	0,022	0,022	0,026
K5	LOHW060310TR-D07 MP1500	0,80	0,50	0,50	0,60
		0,032	0,020	0,020	0,024
K6	LOHT060310TR-MD07 MK2050	0,80	0,55	0,55	0,65
		0,032	0,022	0,022	0,026
K7	LOHT060310TR-MD07 MK2050	0,80	0,50	0,50	0,60
		0,032	0,020	0,020	0,024
S1	LOHT060310TR-M07 MS2500	0,48	0,50	0,50	0,60
		0,019	0,020	0,020	0,024
S2	LOHT060310TR-M07 MS2500	0,48	0,50	0,50	0,60
		0,019	0,020	0,020	0,024
S3	LOHT060310TR-M07 MS2500	0,48	0,48	0,48	0,55
		0,019	0,019	0,019	0,022
S11	LOHT060310TR-ME06 MS2050	0,55	0,46	0,46	0,55
		0,022	0,018	0,018	0,022
S12	LOHT060310TR-ME06 MS2050	0,55	0,46	0,46	0,55
		0,022	0,018	0,018	0,022
S13	LOHT060310TR-ME06 MS2050	0,48	0,44	0,44	0,50
		0,019	0,017	0,017	0,020
H5	LOHW060310TR-D07 MH1000	0,50	0,42	0,42	0,48
		0,020	0,017	0,017	0,019
H8	LOHW060310TR-D07 MH1000	0,44	0,34	0,34	0,38
		0,017	0,013	0,013	0,015
H11	LOHT060310TR-M07 T350M	0,50	0,42	0,42	0,48
		0,020	0,017	0,017	0,019
H12	LOHT060310TR-M07 T350M	0,44	0,34	0,34	0,38
		0,017	0,013	0,013	0,015
H21	LOHW060310TR-D07 MH1000	0,44	0,34	0,34	0,38
		0,017	0,013	0,013	0,015

SMG = Seco material group
f_z = mm/tooth (in/tooth), v_c = m/min (sf/min), a_p/DC = %
All cutting data are start values

Square shoulder and slot milling cutters
Helical milling cutters
Face milling cutters
Disc milling cutters
High feed milling cutters
Copy milling cutters
Plunge milling cutters
Chamfer milling cutters
Spot facing cutters
Inserts

R217/220.21-LO06 – Cutting data $v_c = (m/min)/(sf/min)$

SMG	MP1501			MP2050			MP2501			MP3000			T350M			F40M		
	100%	70%	30%	100%	70%	30%	100%	70%	30%	100%	70%	30%	100%	70%	30%	100%	70%	30%
P1	285	320	380	270	305	365	275	310	375	260	295	355	240	270	325	210	235	285
	940	1050	1250	890	1000	1200	900	1025	1225	850	970	1175	790	890	1075	690	770	940
P2	275	310	370	265	300	355	270	305	365	255	285	345	235	265	315	205	230	275
	900	1025	1225	870	980	1175	890	1000	1200	840	940	1125	770	870	1025	670	750	900
P3	240	270	325	230	255	315	230	260	320	220	245	300	200	225	280	175	200	240
	790	890	1075	750	840	1025	750	850	1050	720	800	980	660	740	920	570	660	790
P4	210	235	290	200	225	275	205	230	280	195	220	265	180	200	245	155	175	215
	690	770	950	660	740	900	670	750	920	640	720	870	590	660	800	510	570	710
P5	205	230	275	195	220	265	200	225	270	190	215	255	175	195	235	150	170	205
	670	750	900	640	720	870	660	740	890	620	710	840	570	640	770	490	560	670
P6	230	260	310	220	250	295	225	255	300	210	240	285	195	220	260	170	190	230
	750	850	1025	720	820	970	740	840	980	690	790	940	640	720	850	560	620	750
P7	215	245	290	210	235	280	210	240	285	200	225	270	185	210	250	160	180	215
	710	800	950	690	770	920	690	790	940	660	740	890	610	690	820	520	590	710
P8	200	225	275	190	215	265	195	220	270	185	210	255	170	190	235	150	165	205
	660	740	900	620	710	870	640	720	890	610	690	840	560	620	770	490	540	670
P11	210	235	285	200	225	270	205	230	275	195	220	260	180	200	240	155	175	210
	690	770	940	660	740	890	670	750	900	640	720	850	590	660	790	510	570	690
P12	140	155	185	130	145	175	135	150	180	125	140	170	115	130	155	100	115	135
	460	510	610	425	475	570	445	490	590	410	460	560	375	425	510	330	375	445
M1	—	—	—	190	215	255	195	220	260	190	215	255	180	205	245	165	185	220
	—	—	—	620	710	840	640	720	850	620	710	840	590	670	800	540	610	720
M2	—	—	—	155	175	210	160	180	215	160	180	210	150	170	200	135	155	185
	—	—	—	510	570	690	520	590	710	520	590	690	490	560	660	445	510	610
M3	—	—	—	125	140	170	130	145	175	130	145	170	120	135	160	110	125	145
	—	—	—	410	460	560	425	475	570	425	475	560	395	445	520	360	410	475
M4	—	—	—	100	110	130	100	115	135	100	110	135	95	105	125	85	95	115
	—	—	—	330	360	425	330	375	445	330	360	445	310	345	410	280	310	375
M5	—	—	—	85	90	110	85	95	115	85	95	110	80	90	105	70	80	95
	—	—	—	280	295	360	280	310	375	280	310	360	260	295	345	230	260	310
K1	220	245	295	—	—	—	215	240	290	200	230	270	185	210	250	160	180	220
	720	800	970	—	—	—	710	790	950	660	750	890	610	690	820	520	590	720
K2	195	220	260	—	—	—	190	215	255	180	200	240	165	185	220	145	160	195
	640	720	850	—	—	—	620	710	840	590	660	790	540	610	720	475	520	640
K3	165	185	220	—	—	—	160	180	215	150	170	205	140	155	190	120	135	165
	540	610	720	—	—	—	520	590	710	490	560	670	460	510	620	395	445	540
K4	155	175	210	—	—	—	155	175	205	145	165	195	135	150	180	115	130	155
	510	570	690	—	—	—	510	570	670	475	540	640	445	490	590	375	425	510
K5	95	110	130	—	—	—	95	105	125	90	100	120	80	90	110	70	80	95
	310	360	425	—	—	—	310	345	410	295	330	395	260	295	360	230	260	310
K6	140	155	185	—	—	—	135	150	180	130	145	170	120	130	160	100	115	135
	460	510	610	—	—	—	445	490	590	425	475	560	395	425	520	330	375	445
K7	125	140	165	—	—	—	120	135	160	115	130	150	105	120	140	90	100	120
	410	460	540	—	—	—	395	445	520	375	425	490	345	395	460	295	330	395
S1	—	—	—	48	55	65	49	55	65	47	50	60	44	49	60	40	45	55
	—	—	—	155	180	215	160	180	215	155	165	195	145	160	195	130	150	180
S2	—	—	—	39	43	50	40	44	55	38	42	50	36	40	47	32	36	43
	—	—	—	130	140	165	130	145	180	125	140	165	120	130	155	105	120	140
S3	—	—	—	34	38	46	35	39	47	33	37	44	31	35	42	28	32	38
	—	—	—	110	125	150	115	130	155	110	120	145	100	115	140	90	105	125
S11	—	—	—	65	75	90	70	80	90	65	75	85	60	70	80	55	65	75
	—	—	—	215	245	295	230	260	295	215	245	280	195	230	260	180	215	245
S12	—	—	—	46	55	65	47	55	65	45	50	60	42	48	55	38	44	50
	—	—	—	150	180	215	155	180	215	150	165	195	140	155	180	125	145	165
S13	—	—	—	27	30	36	28	31	37	26	29	35	25	28	33	23	25	30
	—	—	—	90	100	120	90	100	120	85	95	115	80	90	110	75	80	100
H5	47	55	65	—	—	—	42	47	55	41	46	55	40	45	55	35	39	47
	155	180	215	—	—	—	140	155	180	135	150	180	130	150	180	115	130	155
H8	50	55	65	—	—	—	45	50	60	44	49	60	43	48	55	37	42	50
	165	180	215	—	—	—	150	165	195	145	160	195	140	155	180	120	140	165
H11	60	70	80	50	60	70	55	60	70	50	60	70	50	60	70	45	50	60
	195	230	260	165	195	230	180	195	230	165	195	230	165	195	230	150	165	195
H12	90	100	120	85	95	115	90	100	120	85	95	110	75	85	100	65	75	90
	295	330	395	280	310	375	295	330	395	280	310	360	245	280	330	215	245	295
H21	50	55	65	—	—	—	45	50	60	44	49	60	43	48	55	37	42	50
	165	180	215	—	—	—	150	165	195	145	160	195	140	155	180	120	140	165

R217/220.21-L006 – Cutting data $v_c = (m/min)/(sf/min)$

SMG	MM4500			MK2050			MS2050			MS2500			MH1000		
	100%	70%	30%	100%	70%	30%	100%	70%	30%	100%	70%	30%	100%	70%	30%
P1	185	205	250	250	280	335	230	260	310	300	340	405	—	—	—
	610	670	820	820	920	1100	750	850	1025	980	1125	1325	—	—	—
P2	180	200	245	240	270	325	225	255	305	295	330	395	—	—	—
	590	660	800	790	890	1075	740	840	1000	970	1075	1300	—	—	—
P3	155	175	210	205	235	285	195	220	265	255	285	350	—	—	—
	510	570	690	670	770	940	640	720	870	840	940	1150	—	—	—
P4	140	155	190	185	205	250	170	190	235	225	250	305	—	—	—
	460	510	620	610	670	820	560	620	770	740	820	1000	—	—	—
P5	135	150	180	180	200	240	165	190	225	220	245	290	—	—	—
	445	490	590	590	660	790	540	620	740	720	800	950	—	—	—
P6	150	170	205	200	225	270	185	210	250	245	275	330	—	—	—
	490	560	670	660	740	890	610	690	820	800	900	1075	—	—	—
P7	140	160	190	190	215	255	175	200	235	230	260	310	—	—	—
	460	520	620	620	710	840	570	660	770	750	850	1025	—	—	—
P8	130	150	175	175	195	240	160	185	225	215	240	290	—	—	—
	425	490	570	570	640	790	520	610	740	710	790	950	—	—	—
P11	140	155	185	185	205	245	170	195	230	225	255	300	—	—	—
	460	510	610	610	670	800	560	640	750	740	840	980	—	—	—
P12	90	100	120	120	135	160	110	125	150	145	165	195	—	—	—
	295	330	395	395	445	520	360	410	490	475	540	640	—	—	—
M1	155	170	210	—	—	—	180	205	245	210	235	285	—	—	—
	510	560	690	—	—	—	590	670	800	690	770	940	—	—	—
M2	130	145	175	—	—	—	150	170	200	175	195	235	—	—	—
	425	475	570	—	—	—	490	560	660	570	640	770	—	—	—
M3	105	115	140	—	—	—	120	135	165	140	160	190	—	—	—
	345	375	460	—	—	—	395	445	540	460	520	620	—	—	—
M4	80	90	110	—	—	—	95	105	125	110	125	145	—	—	—
	260	295	360	—	—	—	310	345	410	360	410	475	—	—	—
M5	65	75	90	—	—	—	80	90	105	90	105	120	—	—	—
	215	245	295	—	—	—	260	295	345	295	345	395	—	—	—
K1	—	—	—	260	295	350	—	—	—	—	—	—	200	225	270
	—	—	—	850	970	1150	—	—	—	—	—	—	660	740	890
K2	—	—	—	230	260	310	—	—	—	—	—	—	180	200	240
	—	—	—	750	850	1025	—	—	—	—	—	—	590	660	790
K3	—	—	—	195	220	260	—	—	—	—	—	—	150	170	205
	—	—	—	640	720	850	—	—	—	—	—	—	490	560	670
K4	—	—	—	185	210	250	—	—	—	—	—	—	145	165	195
	—	—	—	610	690	820	—	—	—	—	—	—	475	540	640
K5	—	—	—	115	130	150	—	—	—	—	—	—	90	100	120
	—	—	—	375	425	490	—	—	—	—	—	—	295	330	395
K6	—	—	—	165	185	220	—	—	—	—	—	—	125	145	170
	—	—	—	540	610	720	—	—	—	—	—	—	410	475	560
K7	—	—	—	145	165	195	—	—	—	—	—	—	115	125	150
	—	—	—	475	540	640	—	—	—	—	—	—	375	410	490
N1	—	—	—	—	—	—	—	—	—	—	—	—	—	—	—
N2	—	—	—	—	—	—	—	—	—	—	—	—	—	—	—
N3	—	—	—	—	—	—	—	—	—	—	—	—	—	—	—
N11	—	—	—	—	—	—	—	—	—	—	—	—	—	—	—
S1	25	28	33	—	—	—	44	50	60	55	60	70	—	—	—
	80	90	110	—	—	—	145	165	195	180	195	230	—	—	—
S2	20	22	27	—	—	—	36	40	47	43	49	55	—	—	—
	65	70	90	—	—	—	120	130	155	140	160	180	—	—	—
S3	17	20	23	—	—	—	31	35	41	38	42	50	—	—	—
	55	65	75	—	—	—	100	115	135	125	140	165	—	—	—
S11	34	39	46	—	—	—	60	70	85	75	85	100	—	—	—
	110	130	150	—	—	—	195	230	280	245	280	330	—	—	—
S12	32	36	42	—	—	—	42	47	60	50	60	70	—	—	—
	105	120	140	—	—	—	140	155	195	165	195	230	—	—	—
S13	18	21	25	—	—	—	25	28	33	30	34	40	—	—	—
	60	70	80	—	—	—	80	90	110	100	110	130	—	—	—
H5	—	—	—	—	—	—	—	—	—	—	—	—	44	49	60
	—	—	—	—	—	—	—	—	—	—	—	—	145	160	195
H8	—	—	—	—	—	—	—	—	—	—	—	—	47	50	60
	—	—	—	—	—	—	—	—	—	—	—	—	155	165	195
H11	—	—	—	—	—	—	—	—	—	—	—	—	55	60	75
	—	—	—	—	—	—	—	—	—	—	—	—	180	195	245
H12	—	—	—	—	—	—	—	—	—	—	—	—	85	95	110
	—	—	—	—	—	—	—	—	—	—	—	—	280	310	360
H21	—	—	—	—	—	—	—	—	—	—	—	—	47	50	60
	—	—	—	—	—	—	—	—	—	—	—	—	155	165	195

Square shoulder and slot milling cutters
Helical milling cutters
Face milling cutters
Disc milling cutters
High feed milling cutters
Copy milling cutters
Plunge milling cutters
Chamfer milling cutters
Spot facing cutters
Inserts



R217/220.21 HIGH FEED 6

High feed 6, for 218.21 insert type, 6-cutting edge, double sided inserts.

This family consists of shell end mill bodies with fixed pockets and very strong negative inserts with six cutting edges.

- Cutter range 40-160 mm (1.5 - 6 inch)
- Max depth of cut 1.8 mm
- First choice for ISO P & K materials for medium-size machines

R220.21-R230 – Metric

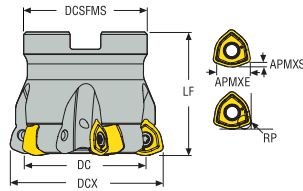

- For insert selection and cutting data recommendations, see page(s) 570-572
- For complete insert programme, see page(s) 880
- For ISO attribute explanation, see page 16

Designation	Item number	Type of mounting	DC	DCX	ZFP	APMXS	APMXE	DCB	TDZ	DCSFMS	LF	RP	RMPX°	Cmin	Cmax	Weight	RPMX	Insert
			mm	mm		mm	mm	mm		mm	mm	mm		mm	mm	kg		
R217.21-2040.RE-R230.3A	03136708	Combimaster	25,6	40,0	3	1,8	10,0	–	M20	36,5	45,0	3,32	1,4	65,6	78,0	0,4	12100	218.21-..
R217.21-2042.RE-R230.3A	03136709	Combimaster	27,6	42,0	3	1,8	10,0	–	M20	36,5	45,0	3,32	1,3	69,6	82,0	0,4	12100	218.21-..
R220.21-0050-R230.4A	02826551	Arbor	35,6	50,0	4	1,8	10,0	22,0	–	42,0	40,0	3,32	0,9	85,6	98,0	0,3	12100	218.21-..
R220.21-0050-R230.5A	02826550	Arbor	35,6	50,0	5	1,8	10,0	22,0	–	42,0	40,0	3,32	0,9	85,6	98,0	0,3	12100	218.21-..
R220.21-0052-R230.5A	02826552	Arbor	37,6	52,0	5	1,8	10,0	22,0	–	42,0	40,0	3,32	0,9	89,6	102,0	0,3	11900	218.21-..
R220.21-0063-R230.5A	02826553	Arbor	48,3	63,0	5	1,8	10,0	27,0	–	50,0	50,0	3,32	0,6	111,3	124,0	0,6	10800	218.21-..
R220.21-0063-R230.6A	02826554	Arbor	48,3	63,0	6	1,8	10,0	27,0	–	50,0	50,0	3,32	0,6	111,3	124,0	0,6	10800	218.21-..
R220.21-0066-R230.6A	02826555	Arbor	51,3	66,0	6	1,8	10,0	27,0	–	62,0	50,0	3,32	0,6	117,3	130,0	0,8	10600	218.21-..
R220.21-0080-R230.6A	02826556	Arbor	65,6	80,0	6	1,8	10,0	27,0	–	62,0	50,0	3,32	0,4	145,6	158,0	1,0	9600	218.21-..
R220.21-0080-R230.7A	02826557	Arbor	65,6	80,0	7	1,8	10,0	27,0	–	62,0	50,0	3,32	0,4	145,6	158,0	1,0	9600	218.21-..
R220.21-0084-R230.8A	02826558	Arbor	69,6	84,0	8	1,8	10,0	32,0	–	77,0	50,0	3,32	0,4	153,6	166,0	1,3	9400	218.21-..
R220.21-0100-R230.7A	02950391	Arbor	85,6	100,0	7	1,8	10,0	32,0	–	77,0	50,0	3,3	0,3	185,6	198,0	1,5	8600	218.21-..
R220.21-0100-R230.9A	02826559	Arbor	85,6	100,0	9	1,8	10,0	32,0	–	77,0	50,0	3,32	0,3	185,6	198,0	1,6	8600	218.21-..
R220.21-0125-R230.9A	02826560	Arbor	110,2	125,0	9	1,8	10,0	40,0	–	90,0	63,0	3,32	0,2	235,2	248,0	2,8	7700	218.21-..
R220.21-8160-R230.10A	02826561	Arbor	145,2	160,0	10	1,8	10,0	40,0	–	90,0	63,0	3,32	0,1	305,2	318,0	4,1	6800	218.21-..

Square shoulder and slot milling cutters

Helical milling cutters

Face milling cutters

Disc milling cutters

High feed milling cutters

Copy milling cutters

Plunge milling cutters

Chamfer milling cutters

Spot facing cutters

Inserts

Spare Parts, included in delivery

For cutter	Arbor screw	Insert key	Insert screw	Lid	Lid screw
R217.21-2040-2042	-	H4B-T15P	C04011-T15P	-	-
R220.21-0050	220.17-692	H4B-T15P	C04011-T15P	-	-
R220.21-0063-0066	MC6S12X35	H4B-T15P	C04011-T15P	-	-
R220.21-0080	MC6S12X35	H4B-T15PL	C04011-T15P	-	-
R220.21-0084-0100	MLC6S16X35	H4B-T15PL	C04011-T15P	-	-
R220.21-0125	MLC6S20X40	H4B-T15PL	C04011-T15P	-	-
R220.21-8160	-	H4B-T15PL	C04011-T15P	SC160-53	MF6S4X10

Accessories

For cutter	Arbor screw	Insert clamping torque	Torque key
R217/220.21-2040-0125	-	3.5NM	T00-15P35
R220.21-8160	MC6S12X40	3.5NM	T00-15P35

Torque and fixed keys, see page 894

Square shoulder and slot milling cutters
Helical milling cutters
Face milling cutters
Disc milling cutters
High feed milling cutters
Copy milling cutters
Plunge milling cutters
Chamfer milling cutters
Spot facing cutters
Inserts

R220.21-R230 – inch

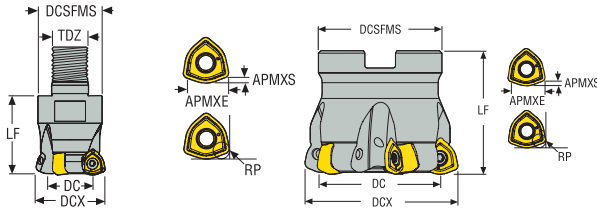

- For insert selection and cutting data recommendations, see page(s) 570-572
- For complete insert programme, see page(s) 880
- For ISO attribute explanation, see page 16

Designation	Item number	Type of mounting	DC	DCX	ZEFP	APMXS	APMXE	DCB	TDZ	DCSFMS	LF	RP	RMPX°	C min	C max	Weight	RPMX	Insert
			inch	inch		inch	inch	inch		inch	inch	inch		inch	inch	lbs		
R220.21-02.00-R230-4A	02842027	Arbor	1.421	2.000	4	0.071	0.394	0.750	–	1.654	1.575	0.131	0,9	3.421	3.921	0.660	12100	218.21-..
R220.21-02.00-R230-5A	02842026	Arbor	1.421	2.000	5	0.071	0.394	0.750	–	1.654	1.575	0.131	0,9	3.421	3.921	0.660	12100	218.21-..
R220.21-02.50-R230-5A	02842028	Arbor	1.921	2.500	5	0.071	0.394	0.750	–	1.850	1.575	0.131	0,6	4.421	4.921	1.100	9600	218.21-..
R220.21-02.50-R230-6A	02842029	Arbor	1.921	2.500	6	0.071	0.394	0.750	–	1.850	1.575	0.131	0,6	4.421	4.921	1.100	9600	218.21-..
R220.21-03.00-R230-5A	02842030	Arbor	2.429	2.996	5	0.071	0.394	1.000	–	2.441	1.969	0.131	0,5	5.425	5.913	1.980	9800	218.21-..
R220.21-03.00-R230-6A	02842031	Arbor	2.429	2.996	6	0.071	0.394	1.000	–	2.441	1.969	0.131	0,5	5.425	5.913	2.200	9800	218.21-..
R220.21-04.00-R230-7A	03067226	Arbor	3.433	4.000	7	0.071	0.394	1.500	–	3.543	1.969	0.130	0,3	7.433	7.921	3.970	8500	218.21-..

Spare Parts, included in delivery

For cutter	Arbor screw	Insert key	Insert screw
R220.21-02.00-02.50	UC6S3/8UNFX1-1/4	H4B-T15P	C04011-T15P
R220.21-03.00	UC6S1/2UNFX1-1/4	H4B-T15P	C04011-T15P
R220.21-04.00	ULC6S3/4UNFX11/2	H4B-T15PL	C04011-T15P

Accessories

For cutter	Insert clamping torque	Torque key
R220.21-..	31.0IN.LBS	T00-15P35

Torque and fixed keys, see page 894

Square shoulder and slot milling cutters

Helical milling cutters

Face milling cutters

Disc milling cutters

High feed milling cutters

Copy milling cutters

Plunge milling cutters

Chamfer milling cutters

Spot facing cutters

Inserts

R217/220.21-R230 – Insert selection – mm/Inch

SMG		a _p	f _z		
			100%	70%	30%
P1	218.21-230TR-06-ME13 T350M	1,6	1,0	1,0	1,2
		0,065	0,040	0,040	0,048
P2	218.21-230TR-06-ME13 T350M	1,6	1,0	1,0	1,2
		0,065	0,040	0,040	0,048
P3	218.21-230TR-06-ME13 T350M	1,6	0,95	0,95	1,1
		0,065	0,038	0,038	0,044
P4	218.21-230TR-06-M15 MP2501	1,6	1,1	1,1	1,3
		0,065	0,044	0,044	0,050
P5	218.21-230TR-06-M15 MP2501	1,6	1,1	1,1	1,2
		0,065	0,044	0,044	0,048
P6	218.21-230TR-06-M15 MP2501	1,6	1,0	1,0	1,2
		0,065	0,040	0,040	0,048
P7	218.21-230TR-06-M15 MP2501	1,6	1,0	1,0	1,2
		0,065	0,040	0,040	0,048
P8	218.21-230TR-06-M15 MS2500	1,6	1,1	1,1	1,3
		0,065	0,044	0,044	0,050
P11	218.21-230TR-06-M15 MS2500	1,6	1,0	1,0	1,2
		0,065	0,040	0,040	0,048
P12	218.21-230TR-06-M15 MS2500	1,3	0,80	0,80	0,95
		0,050	0,032	0,032	0,038
M1	218.21-230TR-06-ME13 MS2050	1,6	1,0	1,0	1,2
		0,065	0,040	0,040	0,048
M2	218.21-230TR-06-ME13 MS2050	1,6	0,90	0,90	1,1
		0,065	0,036	0,036	0,044
M3	218.21-230TR-06-ME13 MS2050	1,3	0,80	0,80	0,95
		0,050	0,032	0,032	0,038
M4	218.21-230TR-06-M15 MS2500	0,95	0,95	0,95	1,1
		0,038	0,038	0,038	0,044
M5	218.21-230TR-06-M15 MS2500	0,95	0,95	0,95	1,1
		0,038	0,038	0,038	0,044
K1	218.21-230TR-06-MD17 MK2050	1,8	1,2	1,2	1,5
		0,070	0,048	0,048	0,060
K2	218.21-230TR-06-MD17 MK2050	1,8	1,1	1,1	1,3
		0,070	0,044	0,044	0,050
K3	218.21-230TR-06-MD17 MK2050	1,8	1,1	1,1	1,3
		0,070	0,044	0,044	0,050
K4	218.21-230TR-06-MD17 MK2050	1,8	1,1	1,1	1,3
		0,070	0,044	0,044	0,050
K5	218.21-230TR-06-MD17 MK2050	1,8	1,0	1,0	1,2
		0,070	0,040	0,040	0,048
K6	218.21-230TR-06-MD17 MK2050	1,8	1,1	1,1	1,3
		0,070	0,044	0,044	0,050
K7	218.21-230TR-06-MD17 MK2050	1,8	1,0	1,0	1,2
		0,070	0,040	0,040	0,048
S1	218.21-230TR-06-M15 MS2500	0,95	0,95	0,95	1,1
		0,038	0,038	0,038	0,044
S2	218.21-230TR-06-M15 MS2500	0,95	0,95	0,95	1,1
		0,038	0,038	0,038	0,044
S3	218.21-230TR-06-M15 MS2500	0,95	0,90	0,90	1,0
		0,038	0,036	0,036	0,040
S11	218.21-230TR-06-ME13 MS2050	1,1	0,90	0,90	1,0
		0,044	0,036	0,036	0,040
S12	218.21-230TR-06-ME13 MS2050	1,1	0,90	0,90	1,0
		0,044	0,036	0,036	0,040
S13	218.21-230TR-06-ME13 MS2050	0,95	0,85	0,85	0,95
		0,038	0,034	0,034	0,038
H5	218.21-230TR-06-MD17 MP3000	1,1	0,85	0,85	1,0
		0,044	0,034	0,034	0,040
H8	218.21-230TR-06-MD17 MP3000	1,0	0,70	0,70	0,80
		0,040	0,028	0,028	0,032
H11	218.21-230TR-06-M15 T350M	1,0	0,80	0,80	0,90
		0,040	0,032	0,032	0,036
H12	218.21-230TR-06-M15 T350M	0,90	0,65	0,65	0,75
		0,036	0,026	0,026	0,030
H21	218.21-230TR-06-MD17 MP3000	1,0	0,70	0,70	0,80
		0,040	0,028	0,028	0,032

SMG = Seco material group
f_z = mm/tooth (in/tooth), v_c = m/min (sf/min), a_p/DC = %
All cutting data are start values

R217/220.21-R230 – Cutting data $v_c = (m/min)/(sf/min)$

SMG	MP1501			MP2050			MP2501			MP3000			T350M		
	100%	70%	30%	100%	70%	30%	100%	70%	30%	100%	70%	30%	100%	70%	30%
P1	—	—	—	215	240	295	215	245	300	205	235	285	190	215	260
	—	—	—	710	790	970	710	800	980	670	770	940	620	710	850
P2	—	—	—	205	235	285	210	240	290	200	225	275	185	210	255
	—	—	—	670	770	940	690	790	950	660	740	900	610	690	840
P3	—	—	—	185	210	250	185	210	255	175	200	245	165	185	225
	—	—	—	610	690	820	610	690	840	570	660	800	540	610	740
P4	—	—	—	160	185	220	165	185	225	155	175	215	145	165	195
	—	—	—	520	610	720	540	610	740	510	570	710	475	540	640
P5	—	—	—	155	175	210	155	180	215	150	170	205	135	155	190
	—	—	—	510	570	690	510	590	710	490	560	670	445	510	620
P6	—	—	—	175	195	240	175	200	240	165	190	230	155	175	210
	—	—	—	570	640	790	570	660	790	540	620	750	510	570	690
P7	—	—	—	165	185	225	165	190	230	160	180	215	145	165	200
	—	—	—	540	610	740	540	620	750	520	590	710	475	540	660
P8	—	—	—	155	175	210	155	180	215	150	170	205	135	155	190
	—	—	—	510	570	690	510	590	710	490	560	670	445	510	620
P11	—	—	—	160	180	220	160	185	220	155	175	210	140	160	195
	—	—	—	520	590	720	520	610	720	510	570	690	460	520	640
P12	—	—	—	105	120	145	110	120	150	105	115	140	95	105	130
	—	—	—	345	395	475	360	395	490	345	375	460	310	345	425
M1	—	—	—	150	170	205	150	175	210	150	170	205	140	160	195
	—	—	—	490	560	670	490	570	690	490	560	670	460	520	640
M2	—	—	—	125	140	170	125	145	175	125	140	170	120	135	160
	—	—	—	410	460	560	410	475	570	410	460	560	395	445	520
M3	—	—	—	100	115	140	105	115	145	100	115	140	95	110	135
	—	—	—	330	375	460	345	375	475	330	375	460	310	360	445
M4	—	—	—	80	90	110	80	90	110	80	90	110	75	85	105
	—	—	—	260	295	360	260	295	360	260	295	360	245	280	345
M5	—	—	—	65	75	90	65	75	95	65	75	90	65	70	85
	—	—	—	215	245	295	215	245	310	215	245	295	215	230	280
K1	—	—	—	—	—	—	165	190	230	160	180	220	145	165	200
	—	—	—	—	—	—	540	620	750	520	590	720	475	540	660
K2	—	—	—	—	—	—	150	170	205	140	160	195	130	145	180
	—	—	—	—	—	—	490	560	670	460	520	640	425	475	590
K3	—	—	—	—	—	—	125	145	175	120	135	165	110	125	150
	—	—	—	—	—	—	410	475	570	395	445	540	360	410	490
K4	—	—	—	—	—	—	120	135	165	115	130	155	105	120	145
	—	—	—	—	—	—	395	445	540	375	425	510	345	395	475
K5	—	—	—	—	—	—	75	85	105	70	80	100	65	75	90
	—	—	—	—	—	—	245	280	345	230	260	330	215	245	295
K6	—	—	—	—	—	—	105	120	145	100	115	140	90	105	125
	—	—	—	—	—	—	345	395	475	330	375	460	295	345	410
K7	—	—	—	—	—	—	95	105	135	90	100	125	80	95	115
	—	—	—	—	—	—	310	345	445	295	330	410	260	310	375
S1	—	—	—	38	43	55	39	44	55	37	42	50	35	40	48
	—	—	—	125	140	180	130	145	180	120	140	165	115	130	155
S2	—	—	—	31	35	43	32	36	44	30	34	41	28	32	39
	—	—	—	100	115	140	105	120	145	100	110	135	90	105	130
S3	—	—	—	28	31	37	28	32	38	27	30	36	25	28	34
	—	—	—	90	100	120	90	105	125	90	100	120	80	90	110
S11	—	—	—	55	60	75	55	60	75	50	60	70	48	55	70
	—	—	—	180	195	245	180	195	245	165	195	230	155	180	230
S12	—	—	—	37	42	50	37	43	55	35	41	50	33	39	47
	—	—	—	120	140	165	120	140	180	115	135	165	110	130	155
S13	—	—	—	22	24	30	22	25	30	21	23	29	20	22	27
	—	—	—	70	80	100	70	80	100	70	75	95	65	70	90
H5	—	—	—	—	—	—	34	39	46	33	38	45	33	37	44
	—	—	—	—	—	—	110	130	150	110	125	150	110	120	145
H8	—	—	—	—	—	—	37	41	50	36	40	49	35	40	48
	—	—	—	—	—	—	120	135	165	120	130	160	115	130	155
H11	—	—	—	43	48	55	44	49	60	43	48	55	42	47	55
	—	—	—	140	155	180	145	160	195	140	155	180	140	155	180
H12	—	—	—	70	80	100	75	80	100	70	80	95	65	70	85
	—	—	—	230	260	330	245	260	330	230	260	310	215	230	280
H21	—	—	—	—	—	—	37	41	50	36	40	49	35	40	48
	—	—	—	—	—	—	120	135	165	120	130	160	115	130	155

Square shoulder and slot milling cutters
Helical milling cutters
Face milling cutters
Disc milling cutters
High feed milling cutters
Copy milling cutters
Plunge milling cutters
Chamfer milling cutters
Spot facing cutters
Inserts

R217/220.21-R230 – Cutting data $v_c = (m/min)/(sf/min)$

SMG	F40M			MM4500			MK2050			MS2050			MS2500		
	100%	70%	30%	100%	70%	30%	100%	70%	30%	100%	70%	30%	100%	70%	30%
P1	165	190	225	140	160	195	185	215	260	180	205	250	235	270	325
	540	620	740	460	520	640	610	710	850	590	670	820	770	890	1075
P2	155	175	215	135	160	190	180	210	250	170	195	235	220	255	310
	510	570	710	445	520	620	590	690	820	560	640	770	720	840	1025
P3	135	155	190	120	140	165	155	180	220	150	175	210	195	225	275
	445	510	620	395	460	540	510	590	720	490	570	690	640	740	900
P4	120	140	165	105	120	145	140	160	190	135	150	185	175	200	240
	395	460	540	345	395	475	460	520	620	445	490	610	570	660	790
P5	115	130	165	105	120	140	135	155	190	125	145	180	165	190	235
	375	425	540	345	395	460	445	510	620	410	475	590	540	620	770
P6	135	155	185	115	135	160	150	175	210	145	170	200	190	220	265
	445	510	610	375	445	520	490	570	690	475	560	660	620	720	870
P7	125	145	175	110	125	150	145	165	200	140	160	190	180	210	250
	410	475	570	360	410	490	475	540	660	460	520	620	590	690	820
P8	115	130	160	100	115	140	130	150	185	125	145	175	165	190	230
	375	425	520	330	375	460	425	490	610	410	475	570	540	620	750
P11	120	140	170	105	120	145	140	160	195	135	155	185	175	200	245
	395	460	560	345	395	475	460	520	640	445	510	610	570	660	800
P12	80	90	110	70	80	95	95	110	130	90	100	120	115	135	160
	260	295	360	230	260	310	310	360	425	295	330	395	375	445	520
M1	125	145	175	120	135	160	—	—	—	135	155	190	160	185	220
	410	475	570	395	445	520	—	—	—	445	510	620	520	610	720
M2	105	120	145	100	115	135	—	—	—	115	130	160	135	150	190
	345	395	475	330	375	445	—	—	—	375	425	520	445	490	620
M3	85	100	120	80	95	110	—	—	—	95	110	130	110	125	155
	280	330	395	260	310	360	—	—	—	310	360	425	360	410	510
M4	70	80	95	65	70	85	—	—	—	75	85	105	90	100	120
	230	260	310	215	230	280	—	—	—	245	280	345	295	330	395
M5	55	65	80	50	60	75	—	—	—	65	70	85	75	85	100
	180	215	260	165	195	245	—	—	—	215	230	280	245	280	330
K1	120	140	170	—	—	—	195	225	265	—	—	—	—	—	—
	395	460	560	—	—	—	640	740	870	—	—	—	—	—	—
K2	110	125	155	—	—	—	175	200	245	—	—	—	—	—	—
	360	410	510	—	—	—	570	660	800	—	—	—	—	—	—
K3	95	105	130	—	—	—	150	170	205	—	—	—	—	—	—
	310	345	425	—	—	—	490	560	670	—	—	—	—	—	—
K4	90	100	125	—	—	—	140	165	195	—	—	—	—	—	—
	295	330	410	—	—	—	460	540	640	—	—	—	—	—	—
K5	55	65	75	—	—	—	85	100	120	—	—	—	—	—	—
	180	215	245	—	—	—	280	330	395	—	—	—	—	—	—
K6	80	90	110	—	—	—	125	145	175	—	—	—	—	—	—
	260	295	360	—	—	—	410	475	570	—	—	—	—	—	—
K7	70	80	100	—	—	—	110	130	155	—	—	—	—	—	—
	230	260	330	—	—	—	360	425	510	—	—	—	—	—	—
S1	32	36	44	19	22	27	—	—	—	35	40	48	43	49	60
	105	120	145	60	70	90	—	—	—	115	130	155	140	160	195
S2	26	29	35	15	18	21	—	—	—	28	32	39	34	39	47
	85	95	115	49	60	70	—	—	—	90	105	130	110	130	155
S3	23	26	31	14	16	19	—	—	—	25	28	34	30	34	42
	75	85	100	46	50	60	—	—	—	80	90	110	100	110	140
S11	44	50	60	27	30	37	—	—	—	49	55	65	60	70	80
	145	165	195	90	100	120	—	—	—	160	180	215	195	230	260
S12	31	35	42	25	28	34	—	—	—	34	38	46	41	47	55
	100	115	140	80	90	110	—	—	—	110	125	150	135	155	180
S13	18	20	25	14	16	20	—	—	—	20	23	27	24	27	33
	60	65	80	46	50	65	—	—	—	65	75	90	80	90	110
H5	28	32	39	—	—	—	—	—	—	—	—	—	—	—	—
	90	105	130	—	—	—	—	—	—	—	—	—	—	—	—
H8	30	35	42	—	—	—	—	—	—	—	—	—	—	—	—
	100	115	140	—	—	—	—	—	—	—	—	—	—	—	—
H11	36	41	49	—	—	—	—	—	—	—	—	—	—	—	—
	120	135	160	—	—	—	—	—	—	—	—	—	—	—	—
H12	55	60	75	—	—	—	—	—	—	—	—	—	—	—	—
	180	195	245	—	—	—	—	—	—	—	—	—	—	—	—
H21	30	35	42	—	—	—	—	—	—	—	—	—	—	—	—
	100	115	140	—	—	—	—	—	—	—	—	—	—	—	—



R220.21 (ON09) HIGH FEED

High feed double octomill insert cutters. ON09 inserts have 16 cutting edges, making them the most cost-effective choice for face milling applications using a high feed strategy.

HSS pins securely position inserts in the fixed pockets of the cutter and decrease the time required for indexing.

- Cutter range 80-160 mm (3 - 6 inch)
- Max depth of cut 2 mm (.078 inch)
- Facing applications only

R220.21-ON09 – Metric

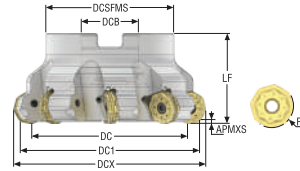

- For insert selection and cutting data recommendations, see page(s) 576-577
- For complete insert programme, see page(s) 838
- For ISO attribute explanation, see page 16

Designation	Item number	Type of mounting	DC	DC1	DCX	ZEFP	APMXS	APMXE	DCB	DCSFMS	LF	RP	Weight	RPMX	Insert
			mm	mm	mm		mm	mm	mm	mm	mm	mm	kg		
R220.21-0080-ON09-6A	02848781	Arbor	65,35	80,0	89,9	6	2,0	7,0	27,0	62,0	50,0	10,28	1,0	4400	ON..09
R220.21-0100-ON09-7A	02848782	Arbor	85,35	100,0	109,9	7	2,0	7,0	32,0	77,0	50,0	10,28	1,5	3900	ON..09
R220.21-0125-ON09-8A	02848783	Arbor	110,35	125,0	134,9	8	2,0	7,0	40,0	90,0	63,0	10,28	2,9	3500	ON..09
R220.21-8160-ON09-10	02848784	Arbor	145,35	160,0	169,9	10	2,0	7,0	40,0	90,0	63,0	10,28	4,1	3100	ON..09

Spare Parts, included in delivery

For cutter	Arbor screw	Insert key	Insert screw
R220.21-0080	MC6S12X35	H6B-T20PL	C05013-T20P
R220.21-0100-0125	-	H6B-T20PL	C05013-T20P
R220.21-8160	-	H6B-T20PL	C05013-T20P

Accessories

For cutter	Arbor screw	Insert clamping torque	Torque key
R220.21-0080-0125	-	5.0NM	T00-20P50
R220.21-8160	MC6S12X40	5.0NM	T00-20P50

Torque and fixed keys, see page 894

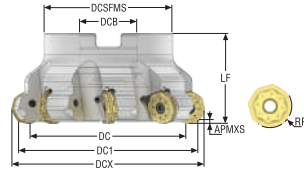

R220.21-ON09 – inch



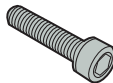
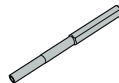

- For insert selection and cutting data recommendations, see page(s) 576-577
- For complete insert programme, see page(s) 838
- For ISO attribute explanation, see page 16

Designation	Item number	Type of mounting	DC	DC1	DCX	ZEFP	APMXS	APMXE	DCB	DCSFMS	LF	RP	Weight	RPMX	Insert
			inch	inch	inch		inch	inch	inch	inch	inch	inch	lbs		
R220.21-03.00-ON09-6A	02848785	Arbor	2.423	3.000	3.389	6	0.079	0.276	1.000	2.441	1.969	0.405	1.980	4400	ON..09
R220.21-06.00-ON09-10	02848788	Arbor	5.423	6.000	6.389	10	0.079	0.276	2.000	4.331	2.480	0.405	7.720	3200	ON..09

Spare Parts, included in delivery

For cutter	Arbor screw	Insert key	Insert screw
R220.21-03.00	 UC6S1/2UNFX1-1/4	 H6B-T20P	 C05013-T20P
R220.21-06.00	-	H6B-T20PL	C05013-T20P

Accessories

For cutter	Arbor screw	Insert clamping torque	Torque key
R220.21-03.00	 -	 44.3IN.LBS	 T00-20P50
R220.21-06.00	58215080	44.3IN.LBS	T00-20P50

Torque and fixed keys, see page 894

Square shoulder and slot milling cutters

Helical milling cutters

Face milling cutters

Disc milling cutters

High feed milling cutters

Copy milling cutters

Plunge milling cutters

Chamfer milling cutters

Spot facing cutters

Inserts

R220.21-ON09 – Insert selection – mm/Inch

SMG		a_p	f_z			
			70%	30%		
Square shoulder and slot milling cutters	P1	ONMU090510ANTN-ME16 T350M	2,0 0,080	0,85 0,034	0,95 0,038	
	P2	ONMU090510ANTN-ME16 T350M	2,0 0,080	0,85 0,034	1,0 0,040	
	Helical milling cutters	P3	ONMU090510ANTN-ME16 T350M	2,0 0,080	0,80 0,032	0,90 0,036
		P4	ONMU090510ANTN-ME16 MP2501	2,0 0,080	0,80 0,032	0,90 0,036
		P5	ONMU090510ANTN-ME16 MP2501	2,0 0,080	0,80 0,032	0,90 0,036
		P6	ONMU090510ANTN-ME16 MP2501	2,0 0,080	0,75 0,030	0,90 0,036
		P7	ONMU090510ANTN-ME16 MP2501	2,0 0,080	0,75 0,030	0,90 0,036
		P8	ONMU090510ANTN-ME16 MP2501	2,0 0,080	0,80 0,032	0,90 0,036
	Face milling cutters	P11	ONMU090512TN-ME16 MP2050	2,0 0,080	0,75 0,030	0,90 0,036
		P12	ONMU090512TN-ME16 MP2050	1,6 0,060	0,55 0,022	0,60 0,024
	Disc milling cutters	M1	ONMU090512TN-ME16 MS2050	2,0 0,080	0,85 0,034	1,0 0,040
		M2	ONMU090512TN-ME16 MS2050	2,0 0,080	0,80 0,032	0,90 0,036
M3		ONMU090512TN-ME16 MS2050	1,6 0,060	0,60 0,024	0,70 0,028	
M4		ONMU090512TN-ME16 MP2050	1,6 0,060	0,55 0,022	0,60 0,024	
M5		ONMU090512TN-ME16 MP2050	1,6 0,060	0,55 0,022	0,60 0,024	
High feed milling cutters	K1	ONMU090520ANTN-M14 MK2050	2,0 0,080	0,80 0,032	0,90 0,036	
	K2	ONMU090520ANTN-M14 MK2050	2,0 0,080	0,75 0,030	0,85 0,034	
	K3	ONMU090520ANTN-M14 MK2050	2,0 0,080	0,75 0,030	0,85 0,034	
	K4	ONMU090520ANTN-M14 MK2050	2,0 0,080	0,75 0,030	0,85 0,034	
	K5	ONMU090520ANTN-M14 MK2050	2,0 0,080	0,65 0,026	0,75 0,030	
	K6	ONMU090520ANTN-MD16 MK1500	2,0 0,080	0,90 0,036	1,0 0,040	
	K7	ONMU090520ANTN-MD16 MK1500	2,0 0,080	0,80 0,032	0,90 0,036	

SMG = Seco material group
 f_z = mm/tooth (in/tooth), v_c = m/min (sf/min), a_p/DC = %
 All cutting data are start values

R220.21-ON09 – Cutting data $v_c = (m/min)/(sf/min)$

SMG	MK1500			MP2501			T350M			MK2050			MS2050			MP2050		
	100%	70%	30%	100%	70%	30%	100%	70%	30%	100%	70%	30%	100%	70%	30%	100%	70%	30%
P1	—	—	—	275	310	375	240	270	325	255	285	345	230	260	315	270	305	370
	—	—	—	900	1025	1225	790	890	1075	840	940	1125	750	850	1025	890	1000	1225
P2	—	—	—	270	300	365	235	260	320	245	280	340	225	250	305	265	295	360
	—	—	—	890	980	1200	770	850	1050	800	920	1125	740	820	1000	870	970	1175
P3	—	—	—	235	265	320	205	230	280	215	245	295	195	220	270	230	260	315
	—	—	—	770	870	1050	670	750	920	710	800	970	640	720	890	750	850	1025
P4	—	—	—	205	235	280	180	205	245	190	215	260	175	195	235	205	230	280
	—	—	—	670	770	920	590	670	800	620	710	850	570	640	770	670	750	920
P5	—	—	—	205	230	275	175	200	240	185	205	250	165	185	230	195	220	270
	—	—	—	670	750	900	570	660	790	610	670	820	540	610	750	640	720	890
P6	—	—	—	225	255	310	200	225	270	205	230	285	190	215	255	225	250	305
	—	—	—	740	840	1025	660	740	890	670	750	940	620	710	840	740	820	1000
P7	—	—	—	215	240	290	185	210	255	195	220	270	180	200	245	210	240	285
	—	—	—	710	790	950	610	690	840	640	720	890	590	660	800	690	790	940
P8	—	—	—	200	225	270	170	195	235	185	205	250	165	185	225	195	220	265
	—	—	—	660	740	890	560	640	770	610	670	820	540	610	740	640	720	870
P11	—	—	—	210	235	285	180	205	245	190	210	260	175	195	235	205	230	280
	—	—	—	690	770	940	590	670	800	620	690	850	570	640	770	670	750	920
P12	—	—	—	135	150	185	120	130	165	125	140	170	115	125	155	135	150	185
	—	—	—	445	490	610	395	425	540	410	460	560	375	410	510	445	490	610
M1	—	—	—	195	215	265	180	200	245	—	—	—	180	205	245	190	210	260
	—	—	—	640	710	870	590	660	800	—	—	—	590	670	800	620	690	850
M2	—	—	—	165	185	220	150	170	205	—	—	—	150	165	205	155	175	215
	—	—	—	540	610	720	490	560	670	—	—	—	490	540	670	510	570	710
M3	—	—	—	130	145	180	120	135	165	—	—	—	120	135	165	125	140	175
	—	—	—	425	475	590	395	445	540	—	—	—	395	445	540	410	460	570
M4	—	—	—	100	115	140	95	105	130	—	—	—	95	105	130	100	110	135
	—	—	—	330	375	460	310	345	425	—	—	—	310	345	425	330	360	445
M5	—	—	—	85	95	115	80	90	105	—	—	—	80	90	105	80	95	110
	—	—	—	280	310	375	260	295	345	—	—	—	260	295	345	260	310	360
K1	240	270	325	210	240	290	—	—	—	265	300	365	—	—	—	—	—	—
	790	890	1075	690	790	950	—	—	—	870	980	1200	—	—	—	—	—	—
K2	215	240	290	190	215	260	—	—	—	235	265	320	—	—	—	—	—	—
	710	790	950	620	710	850	—	—	—	770	870	1050	—	—	—	—	—	—
K3	180	200	245	165	185	220	—	—	—	200	225	270	—	—	—	—	—	—
	590	660	800	540	610	720	—	—	—	660	740	890	—	—	—	—	—	—
K4	170	195	235	155	175	210	—	—	—	190	215	260	—	—	—	—	—	—
	560	640	770	510	570	690	—	—	—	620	710	850	—	—	—	—	—	—
K5	105	120	145	95	105	130	—	—	—	120	135	160	—	—	—	—	—	—
	345	395	475	310	345	425	—	—	—	395	445	520	—	—	—	—	—	—
K6	150	170	205	135	155	185	—	—	—	170	190	230	—	—	—	—	—	—
	490	560	670	445	510	610	—	—	—	560	620	750	—	—	—	—	—	—
K7	135	155	185	120	135	165	—	—	—	150	170	205	—	—	—	—	—	—
	445	510	610	395	445	540	—	—	—	490	560	670	—	—	—	—	—	—

Square shoulder and slot milling cutters
Helical milling cutters
Face milling cutters
Disc milling cutters
High feed milling cutters
Copy milling cutters
Plunge milling cutters
Chamfer milling cutters
Spot facing cutters
Inserts

- Square shoulder and slot milling cutters
- Helical milling cutters
- Face milling cutters
- Disc milling cutters
- High feed milling cutters
- Copy milling cutters
- Plunge milling cutters
- Chamfer milling cutters
- Spot facing cutters
- Inserts



R217/220.21 HIGH FEED

High feed mills for general purpose applications, 3-cutting edge, single sided inserts. 218.19 insert range include a wide selection of cutting geometries and grades for many different materials.

- Cutter range 16-100 mm (.625-4 inch)
- Suitable for long overhangs and/or unstable conditions
- Small-to-medium sized CNC machines with high rpms and high feed rates
- Also works for machines that run lower rpms and feed rates

R217.21 – Metric

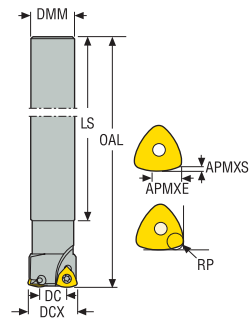

- For insert selection and cutting data recommendations, see page(s) 585-595
- For complete insert programme, see page(s) 878
- For ISO attribute explanation, see page 16

Designation	Item number	Type of mounting	DC	DCX	ZFP	APMXS	APMXE	DMM	LS	OAL	RP	RMPX°	Cmin	Cmax	RPMX	Weight	Insert
			mm	mm		mm	mm	mm	mm	mm	mm		mm	mm		kg	
R217.21-1416.0-R080.2A	02554443	Cylindrical	9,25	16,0	2	0,63	5,0	14,0	127,0	150,0	1,0	6,1	25,25	30,0	53400	0,2	218.19-080
R217.21-1820.0-R100.2A	02554439	Cylindrical	11,4	20,0	2	0,74	7,0	18,0	132,0	160,0	1,47	5,7	31,4	38,0	32600	0,4	218.19-100
R217.21-2025.0-R100.2A	02616308	Cylindrical	16,46	25,0	2	0,74	7,0	20,0	140,0	170,0	1,47	3,48	41,46	48,0	29100	0,5	218.19-100
R217.21-2525.0-R100.3A	02616320	Cylindrical	16,46	25,0	3	0,74	7,0	25,0	135,0	170,0	1,47	3,48	41,46	48,0	29100	0,6	218.19-100
R217.21-2532.0-R125.2A	02616323	Cylindrical	21,16	32,0	2	1,0	9,0	25,0	161,0	195,0	1,74	3,67	53,16	62,0	19700	0,8	218.19-125
R217.21-3232.0-R125.3A	02616325	Cylindrical	21,16	32,0	3	1,0	9,0	32,0	155,0	195,0	1,74	3,67	53,16	62,0	19700	1,1	218.19-125

Spare Parts, included in delivery

For cutter	Insert key	Insert screw
R217.21-R080	H4B-T07P	C02205-T07P
R217.21-R100	H4B-T08P	C02506-T08P
R217.21-R125	H4B-T09P	C03007-T09P

Accessories

For cutter	Insert clamping torque	Torque key
R217.21-R080	0.9NM	T00-07P09
R217.21-R100	1.2NM	T00-08P12
R217.21-R125	2.0NM	T00-09P20

Torque and fixed keys, see page 894

Square shoulder and slot milling cutters
Helical milling cutters
Face milling cutters
Disc milling cutters
High feed milling cutters
Copy milling cutters
Plunge milling cutters
Chamfer milling cutters
Spot facing cutters
Inserts

R217.21 – inch

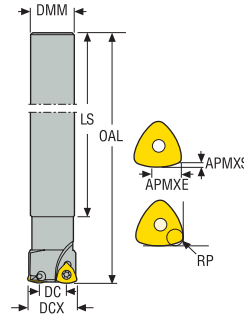

- For insert selection and cutting data recommendations, see page(s) 585-595
- For complete insert programme, see page(s) 878
- For ISO attribute explanation, see page 16

Designation	Item number	Type of mounting	DC	DCX	ZEFP	APMXS	APMXE	DMM	LS	OAL	RP	RMPX°	C min	C max	RPMX	Weight	Insert
			inch	inch		inch	inch	inch	inch	inch	inch		inch	inch		lbs	
R217.21-00.750-0-R100.2A	02559353	Cylindrical	0.410	0.750	2	0.029	0.276	0.750	5.250	6.500	0.058	6,45	1.160	1.421	32600	1.100	218.19-100
R217.21-00.750-0-R100.2HA	02548132	Cylindrical	0.357	0.750	2	0.043	0.276	0.750	5.250	6.500	0.071	4,5	1.107	1.421	32600	1.100	218.19-100
R217.21-01.00-0-R100.3A	02559354	Cylindrical	0.660	1.000	3	0.029	0.276	1.000	5.512	7.000	0.058	3,38	1.660	1.921	29100	1.320	218.19-100
R217.21-01.00-0-R125-2HA	02553724	Cylindrical	0.502	1.000	2	0.059	0.354	1.000	5.512	7.039	0.086	4,1	1.502	1.921	29100	1.540	218.19-125
R217.21-01.25-0-R125-3A	02553726	Cylindrical	0.823	1.250	3	0.039	0.354	1.250	5.906	7.500	0.069	3,73	2.073	2.421	19700	2.430	218.19-125
R217.21-01.25-0-R160-2HA	02553730	Cylindrical	0.583	1.250	2	0.080	0.433	1.250	5.906	7.500	0.121	3,37	1.833	2.421	16200	2.650	218.19-160
R217.21-01.50-0-R160-3HA	02553733	Cylindrical	0.591	1.500	3	0.080	0.433	1.500	5.906	8.000	0.120	3,09	2.091	2.921	17600	3.750	218.19-160

Spare Parts, included in delivery

For cutter	Insert key	Insert screw
R217.21-R100	H4B-T08P	C02506-T08P
R217.21-R125	H4B-T09P	C03007-T09P
R217.21-R160	H4B-T15P	C03510-T15P

Accessories

For cutter	Insert clamping torque	Torque key
R217.21-R100	10.6IN.LBS	T00-08P12
R217.21-R125	17.7IN.LBS	T00-09P20
R217.21-R160	26.6IN.LBS	T00-15P30

Torque and fixed keys, see page 894

R217.21 – Metric

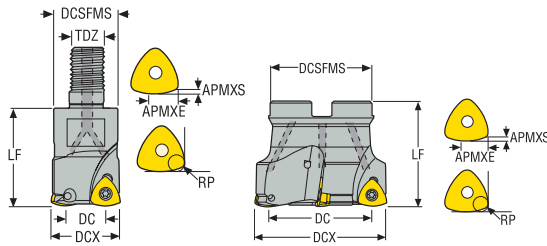

- For insert selection and cutting data recommendations, see page(s) 585-595
- For complete insert programme, see page(s) 878
- For ISO attribute explanation, see page 16

Designation	Item number	Type of mounting	DC	DCX	ZEFP	APMXS	APMXE	DCB	TDZ	DCSFMS	LF	RP	RMPX°	Cmin	Cmax	Weight	RPMX	Insert
			mm	mm		mm	mm	mm		mm	mm	mm		mm	mm	kg		
R217.21-0816.RE-R080.2	00030707	Combimaster	9,25	16,0	2	0,6	5,0	–	M8	13,5	23,0	1,0	6,1	25,25	30,0	0,1	53400	218.19-080
R217.21-1020.RE-R100.2A	00030708	Combimaster	11,45	20,0	2	0,7	7,0	–	M10	18,5	28,0	1,47	5,71	31,45	38,0	0,1	32600	218.19-100
R217.21-1020.RE-R100.2HA	02546332	Combimaster	10,44	20,0	2	1,0	7,0	–	M10	18,5	28,0	1,7	4,32	30,44	38,0	0,1	32600	218.19-100
R217.21-1225.RE-R100.3A	00030710	Combimaster	16,46	25,0	3	0,7	7,0	–	M12	23,0	35,0	1,47	3,48	41,46	48,0	0,2	29100	218.19-100
R217.21-1225.RE-R125.2HA	02502370	Combimaster	12,36	25,0	2	1,5	9,0	–	M12	23,0	35,0	2,18	4,25	37,36	48,0	0,1	29100	218.19-125
R217.21-1632.RE-R125.3A	00030714	Combimaster	21,21	32,0	3	1,0	9,0	–	M16	30,0	40,0	1,74	3,7	53,21	62,0	0,3	19700	218.19-125
R217.21-1632.RE-R160.2HA	02546333	Combimaster	16,09	32,0	2	1,8	11,0	–	M16	30,0	40,0	2,87	3,76	48,09	62,0	0,2	16200	218.19-160
R217.21-1635.RE-R125.3A	00030715	Combimaster	24,16	35,0	3	1,0	9,0	–	M16	30,0	40,0	1,74	3,1	59,16	68,0	0,2	18800	218.19-125
R217.21-1640.RE-R125.4A	00039503	Combimaster	29,25	40,0	4	1,0	9,0	–	M16	30,0	40,0	1,74	2,47	69,25	78,0	0,3	17600	218.19-125
R217.21-1640.RE-R160.3HA	02546335	Combimaster	23,99	40,0	3	1,8	11,0	–	M16	30,0	40,0	2,87	2,18	63,99	78,0	0,2	14500	218.19-160
R220.21-0040-R125.4A	00030717	Arbor	29,2	40,0	4	1,0	9,0	16,0	–	35,0	40,0	1,75	2,47	69,2	78,0	0,2	17600	218.19-125
R220.21-0042-R125.4A	00030720	Arbor	31,2	42,0	4	1,0	9,0	16,0	–	35,0	40,0	1,75	2,28	73,2	82,0	0,2	17200	218.19-125
R220.21-0050-R160.4A	00030723	Arbor	34,17	50,0	4	1,8	11,0	22,0	–	47,0	40,0	2,85	1,47	84,17	98,0	0,3	12900	218.19-160
R220.21-0050-R160.5A	03136664	Arbor	33,7	50,0	5	1,8	11,0	22,0	–	47,0	40,0	3,01	0,9	83,7	98,0	0,4	12900	218.19-160
R220.21-0052-R160.4A	02425827	Arbor	36,19	52,0	4	1,8	11,0	22,0	–	47,0	40,0	2,85	1,38	88,19	102,0	0,4	12700	218.19-160
R220.21-0052-R160.5A	03136665	Arbor	35,7	52,0	5	1,8	11,0	22,0	–	47,0	40,0	3,03	0,8	87,7	102,0	0,4	12700	218.19-160
R220.21-0063-R160.4A	00030724	Arbor	47,2	63,0	4	1,8	11,0	27,0	–	50,0	50,0	2,85	1,0	110,2	124,0	0,5	11500	218.19-160
R220.21-0063-R160.5A	00030726	Arbor	47,2	63,0	5	1,8	11,0	27,0	–	50,0	50,0	2,85	1,0	110,2	124,0	0,6	11500	218.19-160
R220.21-0063-R160.6A	03136666	Arbor	47,9	63,0	6	1,8	11,0	27,0	–	50,0	50,0	3,0	0,6	110,9	124,0	0,6	11500	218.19-160
R220.21-0066-R160.5A	02409011	Arbor	50,21	66,0	5	1,8	11,0	27,0	–	50,0	50,0	2,85	0,95	116,21	130,0	0,6	11200	218.19-160
R220.21-0066-R160.6A	03136667	Arbor	50,9	66,0	6	1,8	11,0	27,0	–	62,0	50,0	3,0	0,5	116,9	130,0	0,8	11200	218.19-160
R220.21-0080-R160.6A	02530950	Arbor	64,15	80,0	6	1,8	11,0	27,0	–	62,0	50,0	2,85	0,73	144,15	158,0	1,0	10200	218.19-160
R220.21-0080-R160.7A	03136668	Arbor	63,6	80,0	7	1,8	11,0	27,0	–	62,0	50,0	3,0	0,4	143,6	158,0	1,3	10200	218.19-160
R220.21-0084-R160.6A	02969095	Arbor	68,0	84,0	6	1,8	11,0	32,0	–	77,0	50,0	2,85	0,7	152,0	166,0	1,4	10000	218.19-160
R220.21-0100-R160.7A	02530946	Arbor	84,13	100,0	7	1,8	11,0	32,0	–	77,0	50,0	2,85	0,54	184,13	198,0	1,6	9700	218.19-160
R220.21-0100-R160.9A	03136671	Arbor	83,6	100,0	9	1,8	11,0	32,0	–	77,0	50,0	3,0	0,3	183,6	198,0	1,6	9700	218.19-160

For Combimaster Shanks, see Machining Navigator Tooling System

Square shoulder and slot milling cutters

Helical milling cutters

Face milling cutters

Disc milling cutters

High feed milling cutters

Copy milling cutters

Plunge milling cutters

Chamfer milling cutters

Spot facing cutters

Inserts

Spare Parts, included in delivery

For cutter	Arbor screw	Insert key	Insert screw
R217.21-R080	-	H4B-T07P	C02205-T07P
R217.21-R100	-	H4B-T08P	C02506-T08P
R217.21-R125	-	H4B-T09P	C03007-T09P
R217.21-R160	-	H4B-T15P	C03510-T15P
R220.21-0040-0042	220.17-689	H4B-T09P	C03007-T09P
R220.21-0050-0052	220.17-692	H4B-T15P	C03510-T15P
R220.21-0063	MC6S12X35	H4B-T15P	C03510-T15P
R220.21-0080	MC6S12X35	H4B-T15PL	C03510-T15P
R220.21-0084	950E1645	H4B-T15PL	C03510-T15P
R220.21-0100	MC6S16X35	H4B-T15PL	C03510-T15P
R220.21-0100.9A	950E1645	H4B-T15PL	C03510-T15P

Accessories

For cutter	Insert clamping torque	Torque key
R217.21-R080	0.9NM	T00-07P09
R217.21-R100	1.2NM	T00-08P12
R217.21-R125	2.0NM	T00-09P20
R217.21-R160	3.0NM	T00-15P30
R220.21-0040-0042	2.0NM	T00-09P20
R220.21-0050-0100	3.0NM	T00-15P30

Torque and fixed keys, see page 894

Square shoulder and slot milling cutters
Helical milling cutters
Face milling cutters
Disc milling cutters
High feed milling cutters
Copy milling cutters
Plunge milling cutters
Chamfer milling cutters
Spot facing cutters
Inserts

R217/220.21 – Inch

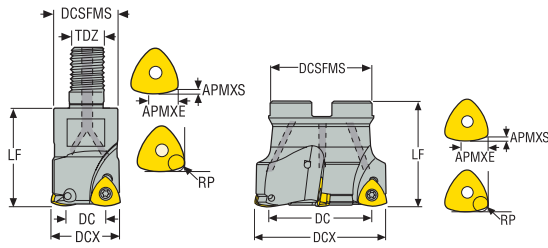

- For insert selection and cutting data recommendations, see page(s) 585-595
- For complete insert programme, see page(s) 878
- For ISO attribute explanation, see page 16

Designation	Item number	Type of mounting	DC	DCX	ZEP	APMXS	APMXE	DCB	TDZ	DCSFMS	Lf	RP	RMPX°	C min	C max	Weight	RPMX	Insert
			inch	inch		inch	inch	inch		inch	inch	inch		inch	inch	lbs		
R217.21-00.750-10RE-R100-2A	00098320	Combimaster	0.414	0.750	2	0.028	0.276	-	M10	0.728	1.100	0.058	6,45	1.164	1.421	0.440	32600	218.19-100
R217.21-00.750-10RE-R100-2HA	02548133	Combimaster	0.357	0.750	2	0.043	0.276	-	M10	0.728	1.100	0.071	4,5	1.107	1.421	0.440	32600	218.19-100
R217.21-01.00-12RE-R100-3A	00098330	Combimaster	0.663	1.000	3	0.028	0.276	-	M12	0.906	1.400	0.058	3,38	1.663	1.921	0.440	29100	218.19-100
R217.21-01.25-16RE-R160-2HA	02548129	Combimaster	0.543	1.250	2	0.079	0.433	-	M16	1.181	1.600	0.121	3,37	1.793	2.421	0.660	16200	218.19-160
R217.21-01.25-16RE-R125-3A	00098351	Combimaster	0.823	1.250	3	0.039	0.354	-	M16	1.181	1.600	0.069	3,73	2.073	2.421	0.660	19700	218.19-125
R217.21-01.50-16RE-R160-3HA	02548130	Combimaster	0.791	1.498	3	0.079	0.433	-	M16	1.181	1.600	0.121	1,96	2.289	2.917	0.880	14500	218.19-160
R217.21-01.50-16RE-R125-4A	02435615	Combimaster	1.002	1.500	4	0.059	0.354	-	M16	1.181	1.600	0.086	1,69	2.502	2.921	0.660	17600	218.19-125
R220.21-01.50-R125-4A	00098850	Arbor	1.002	1.500	4	0.060	0.354	0.500	-	1.378	1.600	0.087	1,69	2.502	2.921	0.660	17600	218.19-125
R220.21-02.00-R160-3A	00098930	Arbor	1.346	2.000	3	0.079	0.433	0.750	-	1.850	1.600	0.119	1,17	3.346	3.921	1.100	12900	218.19-160
R220.21-02.00-R160-4A	00098952	Arbor	1.346	2.000	4	0.079	0.433	0.750	-	1.850	1.600	0.119	1,17	3.346	3.921	1.100	12900	218.19-160
R220.21-02.00-R160-5A	02789050	Arbor	1.327	2.000	5	0.079	0.433	0.750	-	1.850	1.600	0.119	1,17	3.327	3.921	1.100	12900	218.19-160
R220.21-02.50-R160-5A	00099029	Arbor	1.843	2.500	5	0.079	0.433	0.750	-	2.350	2.000	0.119	0,83	4.343	4.921	1.540	11500	218.19-160
R220.21-02.50-R160-6A	02825654	Arbor	1.827	2.500	6	0.079	0.433	0.750	-	2.350	2.000	0.119	0,83	4.327	4.921	1.980	11500	218.19-160
R220.21-03.00-R160-6A	02427189	Arbor	2.280	3.000	6	0.098	0.433	1.000	-	2.441	2.000	0.138	0,39	5.280	5.921	2.200	10200	218.19-160
R220.21-03.00-R160-7A	02828389	Arbor	2.348	3.000	7	0.079	0.433	1.000	-	2.441	2.000	0.119	0,39	5.348	5.921	2.430	10200	218.19-160
R220.21-04.00-R160-7A	02427191	Arbor	3.286	4.000	7	0.098	0.433	1.500	-	3.543	2.000	0.138	0,27	7.286	7.921	4.630	9100	218.19-160
R220.21-04.00-R160-9A	02810684	Arbor	3.348	4.000	9	0.083	0.433	1.500	-	3.543	2.000	0.119	0,27	7.348	7.921	4.630	9100	218.19-160

For Combimaster Shanks, see Machining Navigator Tooling System

Square shoulder and slot milling cutters

Helical milling cutters

Face milling cutters

Disc milling cutters

High feed milling cutters

Copy milling cutters

Plunge milling cutters

Chamfer milling cutters

Spot facing cutters

Inserts

Spare Parts, included in delivery

For cutter	Arbor screw	Insert key	Insert screw
R217.21-0.75/1.00/0.75HA	-	H4B-T08P	C02506-T08P
R217.21-1.25HA/1.50HA	-	H4B-T15P	C03510-T15P
R217.21-1.25/1.50/1.00HA	-	H4B-T09P	C03007-T09P
R220.21-01.50	UC6S1/4UNFX1	H4B-T09P	C03007-T09P
R220.21-02.00	UC6S3/8UNFX1	H4B-T15P	C03510-T15P
R220.21-02.00.5A	UC6S3/8UNFX1	H4B-T15P	C03508-T15P
R220.21-02.50	UC6S3/8UNFX1/2	H4B-T15P	C03510-T15P
R220.21-02.50.5A	UC6S3/8UNFX1/2	H4B-T15P	C03508-T15P
R220.21-03.00	UC6S1/2UNFX1-1/4	H4B-T15P	C03510-T15P
R220.21-03.00.7A	UC6S1/2UNFX1-1/4	H4B-T15P	C03508-T15P
R220.21-04.00	UC6S3/4UNFX1-1/4	H4B-T15PL	C03510-T15P
R220.21-04.00.9A	UC6S3/4UNFX1-1/4	H4B-T15PL	C03508-T15P

Accessories

For cutter	Insert clamping torque	Torque key
R217.21-0.75 / 1.00 / 0.75HA	10.6IN.LBS	T00-08P12
R217.21-1.25HA-1.50HA	26.6IN.LBS	T00-15P30
R217.21-1.25-1.50	17.7IN.LBS	T00-09P20
R220.21-01.50	17.7IN.LBS	T00-09P20
R220.21-02.00-04.00	26.6IN.LBS	T00-15P30

Torque and fixed keys, see page 894

Square shoulder and slot milling cutters
Helical milling cutters
Face milling cutters
Disc milling cutters
High feed milling cutters
Copy milling cutters
Plunge milling cutters
Chamfer milling cutters
Spot facing cutters
Inserts

R217.21-080 – Insert selection – mm/Inch

SMG		a_p	f_z		
			100%	70%	30%
P1	218.19-080T-M04 MP2501	0,55	0,50	0,50	0,65
		0,022	0,020	0,020	0,026
P2	218.19-080T-M04 MP2501	0,55	0,50	0,55	0,70
		0,022	0,020	0,022	0,028
P3	218.19-080T-M04 MP2501	0,55	0,50	0,50	0,65
		0,022	0,020	0,020	0,026
P4	218.19-080T-M04 MP2501	0,55	0,48	0,48	0,65
		0,022	0,019	0,019	0,026
P5	218.19-080T-M04 MP2501	0,55	0,48	0,48	0,60
		0,022	0,019	0,019	0,024
P6	218.19-080T-MD04 MS2500	0,55	0,48	0,48	0,60
		0,022	0,019	0,019	0,024
P7	218.19-080T-MD04 MS2500	0,55	0,48	0,48	0,60
		0,022	0,019	0,019	0,024
P8	218.19-080T-MD04 MS2500	0,55	0,50	0,50	0,65
		0,022	0,020	0,020	0,026
P11	218.19-080T-MD04 MS2500	0,55	0,48	0,48	0,60
		0,022	0,019	0,019	0,024
P12	218.19-080T-MD04 MS2500	0,44	0,34	0,34	0,44
		0,017	0,013	0,013	0,017
M1	218.19-080T-M04 F40M	0,55	0,50	0,55	0,70
		0,022	0,020	0,022	0,028
M2	218.19-080T-M04 F40M	0,55	0,48	0,48	0,60
		0,022	0,019	0,019	0,024
M3	218.19-080T-M04 F40M	0,44	0,40	0,40	0,50
		0,017	0,016	0,016	0,020
M4	218.19-080T-M04 F40M	0,32	0,36	0,36	0,44
		0,013	0,014	0,014	0,017
M5	218.19-080T-M04 F40M	0,32	0,36	0,36	0,44
		0,013	0,014	0,014	0,017
S1	218.19-080T-M04 F40M	0,32	0,36	0,36	0,44
		0,013	0,014	0,014	0,017
S2	218.19-080T-M04 F40M	0,32	0,36	0,36	0,44
		0,013	0,014	0,014	0,017
S3	218.19-080T-M04 F40M	0,32	0,32	0,32	0,40
		0,013	0,013	0,013	0,016
S11	218.19-080T-M04 F40M	0,38	0,40	0,40	0,50
		0,015	0,016	0,016	0,020
S12	218.19-080T-M04 F40M	0,38	0,40	0,40	0,50
		0,015	0,016	0,016	0,020
S13	218.19-080T-M04 F40M	0,32	0,36	0,36	0,44
		0,013	0,014	0,014	0,017
H5	218.19-080T-MD04 F15M	0,34	0,30	0,30	0,38
		0,013	0,012	0,012	0,015
H8	218.19-080T-MD04 F15M	0,30	0,22	0,22	0,28
		0,012	0,0085	0,0085	0,011
H11	218.19-080T-MD04 F15M	0,34	0,30	0,30	0,38
		0,013	0,012	0,012	0,015
H12	218.19-080T-MD04 F15M	0,30	0,22	0,22	0,28
		0,012	0,0085	0,0085	0,011
H21	218.19-080T-MD04 F15M	0,30	0,22	0,22	0,28
		0,012	0,0085	0,0085	0,011

SMG = Seco material group
 f_z = mm/tooth (in/tooth), v_c = m/min (sf/min), a_e/DC = %
 All cutting data are start values

Square shoulder and slot milling cutters
 Helical milling cutters
 Face milling cutters
 Disc milling cutters
 High feed milling cutters
 Copy milling cutters
 Plunge milling cutters
 Chamfer milling cutters
 Spot facing cutters
 Inserts

R217.21-080 – Cutting data $v_c = (m/min)/(sf/min)$

SMG	MP2501			F15M			F30M			F40M			MS2500		
	100%	70%	30%	100%	70%	30%	100%	70%	30%	100%	70%	30%	100%	70%	30%
P1	360	440	510	—	—	—	285	350	405	270	330	385	375	455	520
	1175	1450	1675	—	—	—	940	1150	1325	890	1075	1275	1225	1500	1700
P2	350	415	485	—	—	—	280	330	385	265	315	365	365	430	500
	1150	1350	1600	—	—	—	920	1075	1275	870	1025	1200	1200	1400	1650
P3	300	365	425	—	—	—	240	290	335	230	280	320	310	380	440
	980	1200	1400	—	—	—	790	950	1100	750	920	1050	1025	1250	1450
P4	270	325	375	—	—	—	215	260	295	205	245	285	280	340	385
	890	1075	1225	—	—	—	710	850	970	670	800	940	920	1125	1275
P5	255	310	365	—	—	—	205	250	290	195	235	275	265	325	375
	840	1025	1200	—	—	—	670	820	950	640	770	900	870	1075	1225
P6	285	350	410	—	—	—	230	280	325	215	265	310	300	365	425
	940	1150	1350	—	—	—	750	920	1075	710	870	1025	980	1200	1400
P7	270	330	385	—	—	—	215	260	305	205	250	290	280	340	400
	890	1075	1275	—	—	—	710	850	1000	670	820	950	920	1125	1300
P8	255	310	355	—	—	—	200	245	285	190	235	270	265	320	370
	840	1025	1175	—	—	—	660	800	940	620	770	890	870	1050	1225
P11	265	320	375	—	—	—	210	255	295	200	245	285	275	330	390
	870	1050	1225	—	—	—	690	840	970	660	800	940	900	1075	1275
P12	170	205	240	—	—	—	135	165	190	130	155	180	180	215	250
	560	670	790	—	—	—	445	540	620	425	510	590	590	710	820
M1	250	300	350	—	—	—	225	265	310	215	255	295	260	310	360
	820	980	1150	—	—	—	740	870	1025	710	840	970	850	1025	1175
M2	205	250	290	—	—	—	185	225	260	175	210	245	210	260	300
	670	820	950	—	—	—	610	740	850	570	690	800	690	850	980
M3	165	200	235	—	—	—	150	180	210	140	170	200	175	210	240
	540	660	770	—	—	—	490	590	690	460	560	660	570	690	790
M4	130	160	185	—	—	—	120	140	165	110	135	155	135	165	190
	425	520	610	—	—	—	395	460	540	360	445	510	445	540	620
M5	110	130	155	—	—	—	100	115	135	95	110	130	115	135	160
	360	425	510	—	—	—	330	375	445	310	360	425	375	445	520
K1	275	330	385	240	285	330	220	260	305	210	250	290	—	—	—
	900	1075	1275	790	940	1075	720	850	1000	690	820	950	—	—	—
K2	245	295	345	210	255	300	195	235	275	185	225	260	—	—	—
	800	970	1125	690	840	980	640	770	900	610	740	850	—	—	—
K3	205	250	290	180	215	250	165	200	230	155	190	220	—	—	—
	670	820	950	590	710	820	540	660	750	510	620	720	—	—	—
K4	195	240	280	170	205	240	155	190	220	150	180	210	—	—	—
	640	790	920	560	670	790	510	620	720	490	590	690	—	—	—
K5	120	145	170	105	125	145	95	115	135	90	110	130	—	—	—
	395	475	560	345	410	475	310	375	445	295	360	425	—	—	—
K6	175	210	245	150	180	210	135	165	195	130	160	185	—	—	—
	570	690	800	490	590	690	445	540	640	425	520	610	—	—	—
K7	155	190	215	135	160	185	125	150	170	115	140	165	—	—	—
	510	620	710	445	520	610	410	490	560	375	460	540	—	—	—
N1	—	—	—	—	—	—	1625	2000	2300	1550	1900	2200	—	—	—
	—	—	—	—	—	—	5325	6550	7550	5075	6225	7225	—	—	—
N2	—	—	—	—	—	—	660	800	930	630	770	880	—	—	—
	—	—	—	—	—	—	2175	2625	3050	2075	2525	2875	—	—	—
N3	—	—	—	—	—	—	440	540	620	420	510	590	—	—	—
	—	—	—	—	—	—	1450	1775	2025	1375	1675	1925	—	—	—
N11	—	—	—	—	—	—	500	610	710	480	580	670	—	—	—
	—	—	—	—	—	—	1650	2000	2325	1575	1900	2200	—	—	—
S1	65	75	90	—	—	—	55	65	75	50	60	75	65	80	95
	215	245	295	—	—	—	180	215	245	165	195	245	215	260	310
S2	50	60	70	—	—	—	44	55	60	42	50	60	55	65	75
	165	195	230	—	—	—	145	180	195	140	165	195	180	215	245
S3	46	55	65	—	—	—	39	47	55	37	44	50	47	55	65
	150	180	215	—	—	—	130	155	180	120	145	165	155	180	215
S11	90	105	125	—	—	—	75	90	105	75	85	100	95	110	130
	295	345	410	—	—	—	245	295	345	245	280	330	310	360	425
S12	60	75	85	—	—	—	44	55	60	50	60	70	65	75	90
	195	245	280	—	—	—	145	180	195	165	195	230	215	245	295
S13	36	43	50	—	—	—	26	31	36	29	35	41	37	45	50
	120	140	165	—	—	—	85	100	120	95	115	135	120	150	165
H5	55	65	75	50	60	70	48	55	65	45	55	60	—	—	—
	180	215	245	165	195	230	155	180	215	150	180	195	—	—	—
H8	60	70	80	55	65	75	50	60	70	48	55	65	—	—	—
	195	230	260	180	215	245	165	195	230	155	180	215	—	—	—
H11	70	85	95	65	80	90	60	70	85	60	70	80	—	—	—
	230	280	310	215	260	295	195	230	280	195	230	260	—	—	—
H12	115	135	155	100	120	135	90	110	125	85	105	120	—	—	—
	375	445	510	330	395	445	295	360	410	280	345	395	—	—	—
H21	60	70	80	55	65	75	50	60	70	48	55	65	—	—	—
	195	230	260	180	215	245	165	195	230	155	180	215	—	—	—

R217.21-100 – Insert selection – mm/Inch

SMG		a _p	f _z		
			100%	70%	30%
P1	218.19-100T-M06 MP2501	0,65	0,80	0,80	1,0
		0,026	0,032	0,032	0,040
P2	218.19-100T-M06 MP2501	0,65	0,80	0,80	1,1
		0,026	0,032	0,032	0,044
P3	218.19-100T-M06 MP2501	0,65	0,75	0,75	1,0
		0,026	0,030	0,030	0,040
P4	218.19-100T-M06 MP2501	0,65	0,75	0,75	1,0
		0,026	0,030	0,030	0,040
P5	218.19-100T-M06 MP2501	0,65	0,75	0,75	0,95
		0,026	0,030	0,030	0,038
P6	218.19-100T-MD08 MS2500	0,65	0,95	1,0	1,3
		0,026	0,038	0,040	0,050
P7	218.19-100T-MD08 MS2500	0,65	0,95	1,0	1,3
		0,026	0,038	0,040	0,050
P8	218.19-100T-MD08 MS2500	0,65	1,0	1,0	1,3
		0,026	0,040	0,040	0,050
P11	218.19-100T-MD08 MS2500	0,65	0,95	1,0	1,3
		0,026	0,038	0,040	0,050
P12	218.19-100T-MD08 MS2500	0,50	0,70	0,70	0,90
		0,020	0,028	0,028	0,036
M1	218.19-100T-M06 F40M	0,65	0,80	0,80	1,1
		0,026	0,032	0,032	0,044
M2	218.19-100T-M06 F40M	0,65	0,75	0,75	0,95
		0,026	0,030	0,030	0,038
M3	218.19-100T-M06 F40M	0,50	0,60	0,60	0,75
		0,020	0,024	0,024	0,030
M4	218.19-100T-M06 F40M	0,38	0,55	0,55	0,65
		0,015	0,022	0,022	0,026
M5	218.19-100T-M06 F40M	0,38	0,55	0,55	0,65
		0,015	0,022	0,022	0,026
K1	218.19-100T-M06 MP3000	0,65	0,80	0,80	1,1
		0,026	0,032	0,032	0,044
K2	218.19-100T-M06 MP3000	0,65	0,75	0,75	0,95
		0,026	0,030	0,030	0,038
K3	218.19-100T-M06 MP3000	0,65	0,75	0,75	0,95
		0,026	0,030	0,030	0,038
K4	218.19-100T-M06 MP3000	0,65	0,75	0,75	0,95
		0,026	0,030	0,030	0,038
K5	218.19-100T-M06 MP3000	0,65	0,65	0,65	0,85
		0,026	0,026	0,026	0,034
K6	218.19-100T-M06 MP3000	0,65	0,75	0,75	0,95
		0,026	0,030	0,030	0,038
K7	218.19-100T-M06 MP3000	0,65	0,65	0,65	0,85
		0,026	0,026	0,026	0,034
S1	218.19-100T-M06 MS2500	0,38	0,55	0,55	0,65
		0,015	0,022	0,022	0,026
S2	218.19-100T-M06 MS2500	0,38	0,55	0,55	0,65
		0,015	0,022	0,022	0,026
S3	218.19-100T-M06 MS2500	0,38	0,50	0,50	0,60
		0,015	0,020	0,020	0,024
S11	218.19-100T-M06 MS2050	0,44	0,60	0,60	0,75
		0,017	0,024	0,024	0,030
S12	218.19-100T-M06 MS2050	0,44	0,60	0,60	0,75
		0,017	0,024	0,024	0,030
S13	218.19-100T-M06 MS2050	0,38	0,55	0,55	0,65
		0,015	0,022	0,022	0,026
H5	218.19-100T-MD08 MH1000	0,40	0,60	0,60	0,75
		0,016	0,024	0,024	0,030
H8	218.19-100T-MD08 MH1000	0,34	0,46	0,46	0,55
		0,013	0,018	0,018	0,022
H11	218.19-100T-MD08 MH1000	0,40	0,60	0,60	0,75
		0,016	0,024	0,024	0,030
H12	218.19-100T-M06 MP3000	0,34	0,34	0,34	0,42
		0,013	0,013	0,013	0,017
H21	218.19-100T-MD08 MH1000	0,34	0,46	0,46	0,55
		0,013	0,018	0,018	0,022

SMG = Seco material group
 f_z = mm/tooth (in/tooth), v_c = m/min (sf/min), a_p/DC = %
 All cutting data are start values

Square shoulder and slot milling cutters
 Helical milling cutters
 Face milling cutters
 Disc milling cutters
 High feed milling cutters
 Copy milling cutters
 Plunge milling cutters
 Chamfer milling cutters
 Spot facing cutters
 Inserts

R217.21-100 – Cutting data $v_c = (m/min)/(sf/min)$

SMG	MP2501			MP3000			T350M			F15M		
	100%	70%	30%	100%	70%	30%	100%	70%	30%	100%	70%	30%
P1	270	320	380	295	350	410	270	320	375	245	290	345
	890	1050	1250	970	1150	1350	890	1050	1225	800	950	1125
P2	265	310	370	285	340	395	265	310	365	240	285	340
	870	1025	1225	940	1125	1300	870	1025	1200	790	940	1125
P3	235	275	320	250	295	345	230	275	320	210	250	290
	770	900	1050	820	970	1125	750	900	1050	690	820	950
P4	205	240	290	220	260	310	205	240	285	185	220	260
	670	790	950	720	850	1025	670	790	940	610	720	850
P5	195	230	275	210	250	295	195	230	270	180	210	250
	640	750	900	690	820	970	640	750	890	590	690	820
P6	225	265	310	235	280	330	220	260	305	205	240	280
	740	870	1025	770	920	1075	720	850	1000	670	790	920
P7	210	250	290	225	265	315	205	245	290	190	225	265
	690	820	950	740	870	1025	670	800	950	620	740	870
P8	195	230	270	210	250	290	195	230	270	180	210	245
	640	750	890	690	820	950	640	750	890	590	690	800
P11	205	240	285	215	255	305	200	235	280	185	220	255
	670	790	940	710	840	1000	660	770	920	610	720	840
P12	135	160	185	145	170	195	135	155	180	—	—	—
	445	520	610	475	560	640	445	510	590	—	—	—
M1	190	225	270	215	255	295	205	240	280	—	—	—
	620	740	890	710	840	970	670	790	920	—	—	—
M2	160	185	220	175	210	245	165	200	235	—	—	—
	520	610	720	570	690	800	540	660	770	—	—	—
M3	130	155	180	145	170	200	140	160	190	—	—	—
	425	510	590	475	560	660	460	520	620	—	—	—
M4	105	120	140	115	135	155	110	125	145	—	—	—
	345	395	460	375	445	510	360	410	475	—	—	—
M5	90	100	115	95	110	130	90	105	125	—	—	—
	295	330	375	310	360	425	295	345	410	—	—	—
K1	210	245	295	225	270	315	210	245	290	190	225	265
	690	800	970	740	890	1025	690	800	950	620	740	870
K2	185	220	260	200	235	280	185	220	260	170	200	235
	610	720	850	660	770	920	610	720	850	560	660	770
K3	155	185	220	170	200	235	155	185	220	145	170	200
	510	610	720	560	660	770	510	610	720	475	560	660
K4	150	175	210	160	190	225	150	175	210	135	160	190
	490	570	690	520	620	740	490	570	690	445	520	620
K5	90	110	130	100	120	140	90	110	130	85	100	115
	295	360	425	330	395	460	295	360	425	280	330	375
K6	130	155	185	145	170	200	130	155	185	120	140	170
	425	510	610	475	560	660	425	510	610	395	460	560
K7	120	140	165	130	150	180	120	140	165	105	125	150
	395	460	540	425	490	590	395	460	540	345	410	490
N1	—	—	—	1700	2000	2325	—	—	—	—	—	—
	—	—	—	5575	6550	7625	—	—	—	—	—	—
N2	—	—	—	680	810	940	—	—	—	—	—	—
	—	—	—	2225	2650	3075	—	—	—	—	—	—
N3	—	—	—	455	540	620	—	—	—	—	—	—
	—	—	—	1500	1775	2025	—	—	—	—	—	—
N11	—	—	—	520	610	710	—	—	—	—	—	—
	—	—	—	1700	2000	2325	—	—	—	—	—	—
S1	—	—	—	55	60	70	50	60	70	—	—	—
	—	—	—	180	195	230	165	195	230	—	—	—
S2	—	—	—	44	50	60	41	47	55	—	—	—
	—	—	—	145	165	195	135	155	180	—	—	—
S3	—	—	—	39	44	50	37	42	49	—	—	—
	—	—	—	130	145	165	120	140	160	—	—	—
S11	—	—	—	75	85	100	70	85	95	—	—	—
	—	—	—	245	280	330	230	280	310	—	—	—
S12	—	—	—	50	60	70	50	55	65	—	—	—
	—	—	—	165	195	230	165	180	215	—	—	—
S13	—	—	—	31	35	41	29	33	39	—	—	—
	—	—	—	100	115	135	95	110	130	—	—	—
H5	—	—	—	48	55	65	47	55	65	44	50	60
	—	—	—	155	180	215	155	180	215	145	165	195
H8	—	—	—	50	60	70	50	60	70	47	55	65
	—	—	—	165	195	230	165	195	230	155	180	215
H11	—	—	—	60	70	85	60	70	80	55	65	75
	—	—	—	195	230	280	195	230	260	180	215	245
H12	—	—	—	100	115	135	90	105	125	85	100	115
	—	—	—	330	375	445	295	345	410	280	330	375
H21	—	—	—	50	60	70	50	60	70	47	55	65
	—	—	—	165	195	230	165	195	230	155	180	215

R217.21-100 – Cutting data $v_c = (m/min)/(sf/min)$

SMG	F40M			MS2050			MS2500			MH1000		
	100%	70%	30%	100%	70%	30%	100%	70%	30%	100%	70%	30%
P1	235	280	325	260	305	360	340	400	470	—	—	—
	770	920	1075	850	1000	1175	1125	1300	1550	—	—	—
P2	230	270	320	255	300	350	330	390	460	—	—	—
	750	890	1050	840	980	1150	1075	1275	1500	—	—	—
P3	200	240	275	220	260	305	290	340	400	—	—	—
	660	790	900	720	850	1000	950	1125	1300	—	—	—
P4	175	210	250	195	230	270	255	300	355	—	—	—
	570	690	820	640	750	890	840	980	1175	—	—	—
P5	170	200	235	185	220	260	245	290	340	—	—	—
	560	660	770	610	720	850	800	950	1125	—	—	—
P6	190	225	265	210	245	290	275	325	380	—	—	—
	620	740	870	690	800	950	900	1075	1250	—	—	—
P7	180	210	250	195	235	275	260	305	360	—	—	—
	590	690	820	640	770	900	850	1000	1175	—	—	—
P8	170	200	235	185	220	255	245	290	335	—	—	—
	560	660	770	610	720	840	800	950	1100	—	—	—
P11	175	205	245	190	225	270	250	295	350	—	—	—
	570	670	800	620	740	890	820	970	1150	—	—	—
P12	115	140	160	130	150	175	170	200	230	—	—	—
	375	460	520	425	490	570	560	660	750	—	—	—
M1	185	220	255	205	240	280	235	280	330	—	—	—
	610	720	840	670	790	920	770	920	1075	—	—	—
M2	150	180	215	165	200	235	195	230	270	—	—	—
	490	590	710	540	660	770	640	750	890	—	—	—
M3	125	150	175	140	165	190	160	190	220	—	—	—
	410	490	570	460	540	620	520	620	720	—	—	—
M4	100	115	140	110	130	150	130	150	175	—	—	—
	330	375	460	360	425	490	425	490	570	—	—	—
M5	85	95	115	90	105	125	105	125	145	—	—	—
	280	310	375	295	345	410	345	410	475	—	—	—
K1	180	215	250	—	—	—	—	—	—	230	270	325
	590	710	820	—	—	—	—	—	—	750	890	1075
K2	160	190	225	—	—	—	—	—	—	205	240	285
	520	620	740	—	—	—	—	—	—	670	790	940
K3	135	160	190	—	—	—	—	—	—	175	205	240
	445	520	620	—	—	—	—	—	—	570	670	790
K4	130	155	180	—	—	—	—	—	—	165	195	230
	425	510	590	—	—	—	—	—	—	540	640	750
K5	80	95	110	—	—	—	—	—	—	100	120	140
	260	310	360	—	—	—	—	—	—	330	395	460
K6	115	135	160	—	—	—	—	—	—	145	170	205
	375	445	520	—	—	—	—	—	—	475	560	670
K7	105	120	140	—	—	—	—	—	—	130	155	180
	345	395	460	—	—	—	—	—	—	425	510	590
N1	1350	1600	1850	—	—	—	—	—	—	—	—	—
	4425	5250	6075	—	—	—	—	—	—	—	—	—
N2	550	640	750	—	—	—	—	—	—	—	—	—
	1800	2100	2450	—	—	—	—	—	—	—	—	—
N3	365	430	500	—	—	—	—	—	—	—	—	—
	1200	1400	1650	—	—	—	—	—	—	—	—	—
N11	415	490	570	—	—	—	—	—	—	—	—	—
	1350	1600	1875	—	—	—	—	—	—	—	—	—
S1	47	55	65	50	60	70	65	75	85	—	—	—
	155	180	215	165	195	230	215	245	280	—	—	—
S2	38	44	50	41	48	55	50	60	70	—	—	—
	125	145	165	135	155	180	165	195	230	—	—	—
S3	33	39	45	37	43	50	44	50	60	—	—	—
	110	130	150	120	140	165	145	165	195	—	—	—
S11	65	75	90	70	85	100	85	100	120	—	—	—
	215	245	295	230	280	330	280	330	395	—	—	—
S12	45	55	60	50	60	70	60	70	80	—	—	—
	150	180	195	165	195	230	195	230	260	—	—	—
S13	26	31	36	29	34	40	35	41	48	—	—	—
	85	100	120	95	110	130	115	135	155	—	—	—
H5	41	48	55	—	—	—	—	—	—	55	60	75
	135	155	180	—	—	—	—	—	—	180	195	245
H8	44	50	60	—	—	—	—	—	—	55	65	80
	145	165	195	—	—	—	—	—	—	180	215	260
H11	50	60	70	—	—	—	—	—	—	65	80	95
	165	195	230	—	—	—	—	—	—	215	260	310
H12	80	90	105	—	—	—	—	—	—	100	120	140
	260	295	345	—	—	—	—	—	—	330	395	460
H21	44	50	60	—	—	—	—	—	—	55	65	80
	145	165	195	—	—	—	—	—	—	180	215	260

Square shoulder and slot milling cutters
Helical milling cutters
Face milling cutters
Disc milling cutters
High feed milling cutters
Copy milling cutters
Plunge milling cutters
Chamfer milling cutters
Spot facing cutters
Inserts

R217/220.21-125 – Insert selection – mm/Inch

SMG		a _p	f _z		
			100%	70%	30%
P1	218.19-125T-T3-M07 MP2501	0,90	0,90	0,90	1,1
		0,036	0,036	0,036	0,044
P2	218.19-125T-T3-M07 MP2501	0,90	0,90	0,90	1,1
		0,036	0,036	0,036	0,044
P3	218.19-125T-T3-M07 MP2501	0,90	0,85	0,85	1,0
		0,036	0,034	0,034	0,040
P4	218.19-125T-T3-M07 MP2501	0,90	0,85	0,85	1,0
		0,036	0,034	0,034	0,040
P5	218.19-125T-T3-M07 MP2501	0,90	0,80	0,80	1,0
		0,036	0,032	0,032	0,040
P6	218.19-125T-T3-M07 MP2501	0,90	0,80	0,80	1,0
		0,036	0,032	0,032	0,040
P7	218.19-125T-T3-MD10 MP2501	0,90	1,2	1,2	1,4
		0,036	0,048	0,048	0,055
P8	218.19-125T-T3-MD10 MS2500	0,90	1,2	1,2	1,5
		0,036	0,048	0,048	0,060
P11	218.19-125T-T3-MD10 MS2500	0,90	1,2	1,2	1,4
		0,036	0,048	0,048	0,055
P12	218.19-125T-T3-MD10 MS2500	0,70	0,85	0,85	1,0
		0,028	0,034	0,034	0,040
M1	218.19-125T-T3-M07 F40M	0,90	0,90	0,90	1,1
		0,036	0,036	0,036	0,044
M2	218.19-125T-T3-M07 F40M	0,90	0,80	0,80	1,0
		0,036	0,032	0,032	0,040
M3	218.19-125T-T3-M07 F40M	0,70	0,70	0,70	0,85
		0,028	0,028	0,028	0,034
M4	218.19-125T-T3-M07 F40M	0,55	0,60	0,60	0,75
		0,022	0,024	0,024	0,030
M5	218.19-125T-T3-M07 F40M	0,55	0,60	0,60	0,75
		0,022	0,024	0,024	0,030
K1	218.19-125T-T3-MD08 MP3000	0,90	1,0	1,0	1,3
		0,036	0,040	0,040	0,050
K2	218.19-125T-T3-MD08 MP3000	0,90	0,95	0,95	1,1
		0,036	0,038	0,038	0,044
K3	218.19-125T-T3-MD08 MP3000	0,90	0,95	0,95	1,1
		0,036	0,038	0,038	0,044
K4	218.19-125T-T3-MD08 MP3000	0,90	0,95	0,95	1,1
		0,036	0,038	0,038	0,044
K5	218.19-125T-T3-MD08 MP3000	0,90	0,85	0,85	1,0
		0,036	0,034	0,034	0,040
K6	218.19-125T-T3-MD08 MP3000	0,90	0,95	0,95	1,1
		0,036	0,038	0,038	0,044
K7	218.19-125T-T3-MD08 MP3000	0,90	0,85	0,85	1,0
		0,036	0,034	0,034	0,040
S1	218.19-125T-T3-M07 MS2500	0,55	0,60	0,60	0,75
		0,022	0,024	0,024	0,030
S2	218.19-125T-T3-M07 MS2500	0,55	0,60	0,60	0,75
		0,022	0,024	0,024	0,030
S3	218.19-125T-T3-M07 MS2500	0,55	0,60	0,60	0,70
		0,022	0,024	0,024	0,028
S11	218.19-125T-T3-M07 MS2050	0,65	0,70	0,70	0,85
		0,026	0,028	0,028	0,034
S12	218.19-125T-T3-M07 MS2050	0,65	0,70	0,70	0,85
		0,026	0,028	0,028	0,034
S13	218.19-125T-T3-M07 MS2050	0,55	0,60	0,60	0,75
		0,022	0,024	0,024	0,030
H5	218.19-125T-T3-MD10 MH1000	0,55	0,75	0,75	0,90
		0,022	0,030	0,030	0,036
H8	218.19-125T-T3-MD10 MH1000	0,50	0,55	0,55	0,70
		0,020	0,022	0,022	0,028
H11	218.19-125T-T3-MD08 MP3000	0,55	0,60	0,60	0,70
		0,022	0,024	0,024	0,028
H12	218.19-125T-T3-M07 T350M	0,50	0,40	0,40	0,48
		0,020	0,016	0,016	0,019
H21	218.19-125T-T3-MD10 MH1000	0,50	0,55	0,55	0,70
		0,020	0,022	0,022	0,028

SMG = Seco material group
 f_z = mm/tooth (in/tooth), v_c = m/min (sf/min), a_p/DC = %
 All cutting data are start values

R217/220.21-125 – Cutting data $v_c = (m/min)/(sf/min)$

SMG	MP1501			MP2501			MP3000			T350M			F40M		
	100%	70%	30%	100%	70%	30%	100%	70%	30%	100%	70%	30%	100%	70%	30%
P1	275	320	385	295	340	415	280	325	390	255	295	360	225	260	315
	900	1050	1275	970	1125	1350	920	1075	1275	840	970	1175	740	850	1025
P2	270	310	375	285	330	390	270	315	370	250	290	340	215	250	295
	890	1025	1225	940	1075	1275	890	1025	1225	820	950	1125	710	820	970
P3	240	275	330	250	290	345	235	275	330	220	255	300	190	220	265
	790	900	1075	820	950	1125	770	900	1075	720	840	980	620	720	870
P4	210	240	290	220	255	305	210	240	290	190	225	265	165	195	230
	690	790	950	720	840	1000	690	790	950	620	740	870	540	640	750
P5	200	230	280	215	250	295	205	235	280	185	215	260	165	190	225
	660	750	920	710	820	970	670	770	920	610	710	850	540	620	740
P6	225	260	310	240	280	330	230	265	315	210	245	290	180	210	250
	740	850	1025	790	920	1075	750	870	1025	690	800	950	590	690	820
P7	210	245	295	225	265	315	215	250	295	200	230	275	170	200	235
	690	800	970	740	870	1025	710	820	970	660	750	900	560	660	770
P8	200	230	280	210	245	290	200	230	275	185	215	255	160	185	220
	660	750	920	690	800	950	660	750	900	610	710	840	520	610	720
P11	205	240	285	220	255	305	210	240	290	190	225	265	165	195	230
	670	790	940	720	840	1000	690	790	950	620	740	870	540	640	750
P12	140	160	190	145	165	200	140	160	190	125	145	175	110	125	150
	460	520	620	475	540	660	460	520	620	410	475	570	360	410	490
M1	—	—	—	205	240	285	205	235	280	195	225	265	175	205	240
	—	—	—	670	790	940	670	770	920	640	740	870	570	670	790
M2	—	—	—	175	200	240	170	195	235	160	185	220	145	170	200
	—	—	—	570	660	790	560	640	770	520	610	720	475	560	660
M3	—	—	—	140	160	190	140	160	190	130	150	180	120	135	160
	—	—	—	460	520	620	460	520	620	425	490	590	395	445	520
M4	—	—	—	115	130	150	110	125	145	105	120	140	95	110	125
	—	—	—	375	425	490	360	410	475	345	395	460	310	360	410
M5	—	—	—	95	105	125	95	105	120	90	100	115	80	90	105
	—	—	—	310	345	410	310	345	395	295	330	375	260	295	345
K1	215	245	300	225	265	310	215	250	295	200	230	270	170	200	235
	710	800	980	740	870	1025	710	820	970	660	750	890	560	660	770
K2	190	220	265	205	235	280	195	225	265	175	205	245	155	180	215
	620	720	870	670	770	920	640	740	870	570	670	800	510	590	710
K3	160	185	225	170	200	235	165	190	225	150	175	205	130	150	180
	520	610	740	560	660	770	540	620	740	490	570	670	425	490	590
K4	155	175	215	165	190	225	155	180	215	145	165	195	125	145	170
	510	570	710	540	620	740	510	590	710	475	540	640	410	475	560
K5	95	110	135	100	115	140	95	110	130	85	100	120	75	85	105
	310	360	445	330	375	460	310	360	425	280	330	395	245	280	345
K6	135	155	190	145	170	200	135	160	190	125	145	175	110	125	150
	445	510	620	475	560	660	445	520	620	410	475	570	360	410	490
K7	125	145	170	130	150	180	120	140	170	110	130	155	95	110	135
	410	475	560	425	490	590	395	460	560	360	425	510	310	360	445
N1	—	—	—	—	—	—	1600	1850	2175	—	—	—	1275	1475	1725
	—	—	—	—	—	—	5250	6075	7125	—	—	—	4175	4850	5650
N2	—	—	—	—	—	—	650	750	880	—	—	—	520	600	700
	—	—	—	—	—	—	2125	2450	2875	—	—	—	1700	1975	2300
N3	—	—	—	—	—	—	430	500	580	—	—	—	345	400	465
	—	—	—	—	—	—	1400	1650	1900	—	—	—	1125	1300	1525
N11	—	—	—	—	—	—	495	570	670	—	—	—	395	455	530
	—	—	—	—	—	—	1625	1875	2200	—	—	—	1300	1500	1750
S1	—	—	—	55	60	70	50	60	70	49	55	65	45	50	60
	—	—	—	180	195	230	165	195	230	160	180	215	150	165	195
S2	—	—	—	44	50	60	42	47	55	40	45	50	36	41	47
	—	—	—	145	165	195	140	155	180	130	150	165	120	135	155
S3	—	—	—	38	43	50	36	41	48	34	39	45	31	35	41
	—	—	—	125	140	165	120	135	155	110	130	150	100	115	135
S11	—	—	—	75	85	100	70	80	95	65	75	90	60	70	80
	—	—	—	245	280	330	230	260	310	215	245	295	195	230	260
S12	—	—	—	50	60	70	49	55	65	47	55	65	42	48	55
	—	—	—	165	195	230	160	180	215	155	180	215	140	155	180
S13	—	—	—	31	35	40	29	33	38	28	31	36	25	28	33
	—	—	—	100	115	130	95	110	125	90	100	120	80	90	110
H5	50	55	70	47	55	65	46	55	60	45	50	60	39	45	55
	165	180	230	155	180	215	150	180	195	150	165	195	130	150	180
H8	55	60	70	50	55	65	49	55	65	48	55	65	42	48	55
	180	195	230	165	180	215	160	180	215	155	180	215	140	155	180
H11	65	70	85	60	70	80	60	65	80	60	65	80	50	60	70
	215	230	280	195	230	260	195	215	260	195	215	260	165	195	230
H12	95	110	130	100	115	135	95	105	125	85	100	115	75	85	100
	310	360	425	330	375	445	310	345	410	280	330	375	245	280	330
H21	55	60	70	50	55	65	49	55	65	48	55	65	42	48	55
	180	195	230	165	180	215	160	180	215	155	180	215	140	155	180

Square shoulder and slot milling cutters
Helical milling cutters
Face milling cutters
Disc milling cutters
High feed milling cutters
Copy milling cutters
Plunge milling cutters
Chamfer milling cutters
Spot facing cutters
Inserts

R217/220.21-125 – Cutting data $v_c = (m/min)/(sf/min)$

SMG	MM4500			MS2050			MS2500			MH1000		
	100%	70%	30%	100%	70%	30%	100%	70%	30%	100%	70%	30%
P1	180	210	255	245	285	345	320	370	450	—	—	—
	590	690	840	800	940	1125	1050	1225	1475	—	—	—
P2	175	205	240	240	275	325	315	360	430	—	—	—
	570	670	790	790	900	1075	1025	1175	1400	—	—	—
P3	155	180	215	210	240	290	275	315	380	—	—	—
	510	590	710	690	790	950	900	1025	1250	—	—	—
P4	135	155	185	185	215	255	240	280	335	—	—	—
	445	510	610	610	710	840	790	920	1100	—	—	—
P5	130	150	180	180	205	245	235	270	325	—	—	—
	425	490	590	590	670	800	770	890	1075	—	—	—
P6	150	170	205	200	230	275	265	305	360	—	—	—
	490	560	670	660	750	900	870	1000	1175	—	—	—
P7	140	160	190	190	220	260	250	285	340	—	—	—
	460	520	620	620	720	850	820	940	1125	—	—	—
P8	130	150	180	175	205	245	230	265	320	—	—	—
	425	490	590	570	670	800	750	870	1050	—	—	—
P11	135	155	185	185	215	255	240	280	330	—	—	—
	445	510	610	610	710	840	790	920	1075	—	—	—
P12	90	105	120	120	140	165	160	185	220	—	—	—
	295	345	395	395	460	540	520	610	720	—	—	—
M1	150	175	205	195	225	265	225	260	305	—	—	—
	490	570	670	640	740	870	740	850	1000	—	—	—
M2	125	145	175	160	185	220	185	215	260	—	—	—
	410	475	570	520	610	720	610	710	850	—	—	—
M3	105	120	140	130	150	180	155	175	210	—	—	—
	345	395	460	425	490	590	510	570	690	—	—	—
M4	85	95	110	105	120	140	125	140	165	—	—	—
	280	310	360	345	395	460	410	460	540	—	—	—
M5	70	80	95	90	100	120	105	120	135	—	—	—
	230	260	310	295	330	395	345	395	445	—	—	—
K1	—	—	—	—	—	—	—	—	—	210	240	290
	—	—	—	—	—	—	—	—	—	690	790	950
K2	—	—	—	—	—	—	—	—	—	185	215	255
	—	—	—	—	—	—	—	—	—	610	710	840
K3	—	—	—	—	—	—	—	—	—	155	180	215
	—	—	—	—	—	—	—	—	—	510	590	710
K4	—	—	—	—	—	—	—	—	—	150	175	205
	—	—	—	—	—	—	—	—	—	490	570	670
K5	—	—	—	—	—	—	—	—	—	95	110	130
	—	—	—	—	—	—	—	—	—	310	360	425
K6	—	—	—	—	—	—	—	—	—	130	150	185
	—	—	—	—	—	—	—	—	—	425	490	610
K7	—	—	—	—	—	—	—	—	—	120	140	165
	—	—	—	—	—	—	—	—	—	395	460	540
N1	—	—	—	—	—	—	—	—	—	—	—	—
	—	—	—	—	—	—	—	—	—	—	—	—
N2	—	—	—	—	—	—	—	—	—	—	—	—
	—	—	—	—	—	—	—	—	—	—	—	—
N3	—	—	—	—	—	—	—	—	—	—	—	—
	—	—	—	—	—	—	—	—	—	—	—	—
N11	—	—	—	—	—	—	—	—	—	—	—	—
	—	—	—	—	—	—	—	—	—	—	—	—
S1	25	29	34	49	55	65	60	70	80	—	—	—
	80	95	110	160	180	215	195	230	260	—	—	—
S2	20	23	27	40	46	55	48	55	65	—	—	—
	65	75	90	130	150	180	155	180	215	—	—	—
S3	18	20	24	34	39	47	42	48	60	—	—	—
	60	65	80	110	130	155	140	155	195	—	—	—
S11	35	40	47	65	75	90	80	95	110	—	—	—
	115	130	155	215	245	295	260	310	360	—	—	—
S12	32	37	43	47	55	65	55	65	75	—	—	—
	105	120	140	155	180	215	180	215	245	—	—	—
S13	19	22	25	28	32	37	34	39	45	—	—	—
	60	70	80	90	105	120	110	130	150	—	—	—
H5	—	—	—	—	—	—	—	—	—	48	55	65
	—	—	—	—	—	—	—	—	—	155	180	215
H8	—	—	—	—	—	—	—	—	—	55	60	70
	—	—	—	—	—	—	—	—	—	180	195	230
H11	—	—	—	—	—	—	—	—	—	60	70	85
	—	—	—	—	—	—	—	—	—	195	230	280
H12	—	—	—	—	—	—	—	—	—	95	110	130
	—	—	—	—	—	—	—	—	—	310	360	425
H21	—	—	—	—	—	—	—	—	—	55	60	70
	—	—	—	—	—	—	—	—	—	180	195	230

R217/220.21-160 – Insert selection – mm/Inch

SMG		a _p	f _z		
			100%	70%	30%
P1	218.19-160T-04-M08 MP2501	1,6	0,85	0,85	1,0
		0,065	0,034	0,034	0,040
P2	218.19-160T-04-M08 MP2501	1,6	0,85	0,85	1,0
		0,065	0,034	0,034	0,040
P3	218.19-160T-04-M08 MP2501	1,6	0,80	0,80	1,0
		0,065	0,032	0,032	0,040
P4	218.19-160T-04-M08 MP2501	1,6	0,80	0,80	0,95
		0,065	0,032	0,032	0,038
P5	218.19-160T-04-M11 MP2501	1,6	1,1	1,1	1,3
		0,065	0,044	0,044	0,050
P6	218.19-160T-04-M11 MP2501	1,6	1,1	1,1	1,3
		0,065	0,044	0,044	0,050
P7	218.19-160T-04-M11 MP2501	1,6	1,1	1,1	1,3
		0,065	0,044	0,044	0,050
P8	218.19-160T-04-MD11 MS2500	1,6	1,1	1,1	1,4
		0,065	0,044	0,044	0,055
P11	218.19-160T-04-MD11 MS2500	1,6	1,1	1,1	1,3
		0,065	0,044	0,044	0,050
P12	218.19-160T-04-MD11 MS2500	1,3	0,80	0,80	1,0
		0,050	0,032	0,032	0,040
M1	218.19-160T-04-M08 MS2050	1,6	0,85	0,85	1,0
		0,065	0,034	0,034	0,040
M2	218.19-160T-04-M08 MS2050	1,6	0,80	0,80	0,95
		0,065	0,032	0,032	0,038
M3	218.19-160T-04-M08 MS2050	1,3	0,70	0,70	0,85
		0,050	0,028	0,028	0,034
M4	218.19-160T-04-M08 T350M	0,95	0,70	0,70	0,85
		0,038	0,028	0,028	0,034
M5	218.19-160T-04-M08 T350M	0,95	0,70	0,70	0,85
		0,038	0,028	0,028	0,034
K1	218.19-160T-04-MD11 MK2050	1,6	1,2	1,2	1,4
		0,065	0,048	0,048	0,055
K2	218.19-160T-04-MD11 MK2050	1,6	1,1	1,1	1,3
		0,065	0,044	0,044	0,050
K3	218.19-160T-04-MD11 MK2050	1,6	1,1	1,1	1,3
		0,065	0,044	0,044	0,050
K4	218.19-160T-04-MD11 MK2050	1,6	1,1	1,1	1,3
		0,065	0,044	0,044	0,050
K5	218.19-160T-04-MD11 MK2050	1,6	1,0	1,0	1,2
		0,065	0,040	0,040	0,048
K6	218.19-160T-04-MD11 MK2050	1,6	1,1	1,1	1,3
		0,065	0,044	0,044	0,050
K7	218.19-160T-04-MD11 MK2050	1,6	1,0	1,0	1,2
		0,065	0,040	0,040	0,048
N1	218.19-160-04-E07 H25	1,6	0,95	0,95	1,2
		0,065	0,038	0,038	0,048
N2	218.19-160-04-E07 H25	1,6	0,95	0,95	1,2
		0,065	0,038	0,038	0,048
N3	218.19-160-04-E07 H25	1,6	0,95	0,95	1,2
		0,065	0,038	0,038	0,048
N11	218.19-160-04-E07 H25	1,6	0,95	0,95	1,2
		0,065	0,038	0,038	0,048
S1	218.19-160T-04-M08 MS2500	0,95	0,70	0,70	0,85
		0,038	0,028	0,028	0,034
S2	218.19-160T-04-M08 MS2500	0,95	0,70	0,70	0,85
		0,038	0,028	0,028	0,034
S3	218.19-160T-04-M08 MS2500	0,95	0,65	0,65	0,80
		0,038	0,026	0,026	0,032
S11	218.19-160T-04-M08 MS2050	1,1	0,75	0,75	0,90
		0,044	0,030	0,030	0,036
S12	218.19-160T-04-M08 MS2050	1,1	0,75	0,75	0,90
		0,044	0,030	0,030	0,036
S13	218.19-160T-04-M08 MS2050	0,95	0,70	0,70	0,85
		0,038	0,028	0,028	0,034
H5	218.19-160T-04-MD11 MH1000	1,0	0,80	0,80	0,95
		0,040	0,032	0,032	0,038
H8	218.19-160T-04-MD11 MH1000	0,90	0,65	0,65	0,75
		0,036	0,026	0,026	0,030
H11	218.19-160T-04-MD09 MP3000	1,0	0,65	0,65	0,80
		0,040	0,026	0,026	0,032
H12	218.19-160T-04-M08 T350M	0,90	0,46	0,46	0,55
		0,036	0,018	0,018	0,022
H21	218.19-160T-04-MD11 MH1000	0,90	0,65	0,65	0,75
		0,036	0,026	0,026	0,030

SMG = Seco material group
 f_z = mm/tooth (in/tooth), v_c = m/min (sf/min), a_p/DC = %
 All cutting data are start values

Square shoulder and slot milling cutters
 Helical milling cutters
 Face milling cutters
 Disc milling cutters
 High feed milling cutters
 Copy milling cutters
 Plunge milling cutters
 Chamfer milling cutters
 Spot facing cutters
 Inserts

R217/220.21-160 – Cutting data $v_c = (m/min)/(sf/min)$

SMG	MP1501			MP2050			MP2501			MP3000			T350M			F15M		
	100%	70%	30%	100%	70%	30%	100%	70%	30%	100%	70%	30%	100%	70%	30%	100%	70%	30%
P1	270	315	380	280	330	395	285	335	400	270	315	380	250	290	350	215	255	305
	890	1025	1250	920	1075	1300	940	1100	1300	890	1025	1250	820	950	1150	710	840	1000
P2	260	305	370	270	320	385	275	325	390	265	310	370	240	285	340	210	245	300
	850	1000	1225	890	1050	1275	900	1075	1275	870	1025	1225	790	940	1125	690	800	980
P3	230	270	320	240	280	330	245	285	335	230	270	320	210	250	290	185	220	255
	750	890	1050	790	920	1075	800	940	1100	750	890	1050	690	820	950	610	720	840
P4	205	240	285	210	245	295	215	250	300	205	240	285	185	220	260	165	190	230
	670	790	940	690	800	970	710	820	980	670	790	940	610	720	850	540	620	750
P5	195	230	275	200	235	280	205	240	285	195	225	270	180	210	250	155	185	220
	640	750	900	660	770	920	670	790	940	640	740	890	590	690	820	510	610	720
P6	220	255	305	225	265	315	230	270	320	215	255	305	200	235	280	175	205	245
	720	840	1000	740	870	1025	750	890	1050	710	840	1000	660	770	920	570	670	800
P7	205	240	290	215	250	300	215	255	305	205	240	285	190	220	265	165	195	235
	670	790	950	710	820	980	710	840	1000	670	790	940	620	720	870	540	640	770
P8	195	230	265	200	235	275	205	240	280	195	225	265	180	210	245	155	185	215
	640	750	870	660	770	900	670	790	920	640	740	870	590	690	800	510	610	710
P11	200	235	280	205	240	290	210	245	295	200	235	280	185	215	255	160	190	225
	660	770	920	670	790	950	690	800	970	660	770	920	610	710	840	520	620	740
P12	135	155	185	135	160	190	140	165	195	130	155	185	120	145	170	—	—	—
	445	510	610	445	520	620	460	540	640	425	510	610	395	475	560	—	—	—
M1	—	—	—	195	230	275	200	235	280	195	230	275	185	220	260	—	—	—
	—	—	—	640	750	900	660	770	920	640	750	900	610	720	850	—	—	—
M2	—	—	—	160	190	225	165	195	230	160	190	225	155	180	215	—	—	—
	—	—	—	520	620	740	540	640	750	520	620	740	510	590	710	—	—	—
M3	—	—	—	130	150	180	135	155	185	130	155	185	125	145	175	—	—	—
	—	—	—	425	490	590	445	510	610	425	510	610	410	475	570	—	—	—
M4	—	—	—	105	120	140	105	120	145	105	120	145	100	115	135	—	—	—
	—	—	—	345	395	460	345	395	475	345	395	475	330	375	445	—	—	—
M5	—	—	—	85	100	120	90	100	120	85	100	120	80	95	115	—	—	—
	—	—	—	280	330	395	295	330	395	280	330	395	260	310	375	—	—	—
K1	205	240	295	—	—	—	220	260	310	210	245	295	190	225	270	165	195	235
	670	790	970	—	—	—	720	850	1025	690	800	970	620	740	890	540	640	770
K2	185	215	260	—	—	—	195	230	270	185	215	255	170	200	235	150	175	210
	610	710	850	—	—	—	640	750	890	610	710	840	560	660	770	490	570	690
K3	155	185	220	—	—	—	165	195	230	155	180	220	145	170	200	125	145	175
	510	610	720	—	—	—	540	640	750	510	590	720	475	560	660	410	475	570
K4	150	175	210	—	—	—	155	185	220	150	175	210	135	160	190	120	140	170
	490	570	690	—	—	—	510	610	720	490	570	690	445	520	620	395	460	560
K5	90	105	130	—	—	—	95	115	135	90	110	130	85	100	120	75	85	105
	295	345	425	—	—	—	310	375	445	295	360	425	280	330	395	245	280	345
K6	130	155	185	—	—	—	140	160	195	130	155	185	120	140	170	105	125	150
	425	510	610	—	—	—	460	520	640	425	510	610	395	460	560	345	410	490
K7	115	135	165	—	—	—	125	145	175	120	140	165	110	125	150	95	110	130
	375	445	540	—	—	—	410	475	570	395	460	540	360	410	490	310	360	425
N1	—	—	—	—	—	—	—	—	—	1525	1775	2125	—	—	—	—	—	—
	—	—	—	—	—	—	—	—	—	5000	5825	6975	—	—	—	—	—	—
N2	—	—	—	—	—	—	—	—	—	610	720	860	—	—	—	—	—	—
	—	—	—	—	—	—	—	—	—	2000	2350	2825	—	—	—	—	—	—
N3	—	—	—	—	—	—	—	—	—	410	480	580	—	—	—	—	—	—
	—	—	—	—	—	—	—	—	—	1350	1575	1900	—	—	—	—	—	—
N11	—	—	—	—	—	—	—	—	—	465	550	660	—	—	—	—	—	—
	—	—	—	—	—	—	—	—	—	1525	1800	2175	—	—	—	—	—	—
S1	—	—	—	50	60	70	50	60	70	48	55	65	46	55	65	—	—	—
	—	—	—	165	195	230	165	195	230	155	180	215	150	180	215	—	—	—
S2	—	—	—	40	47	55	41	48	55	39	45	55	37	43	50	—	—	—
	—	—	—	130	155	180	135	155	180	130	150	180	120	140	165	—	—	—
S3	—	—	—	36	41	49	36	42	50	34	40	47	32	38	45	—	—	—
	—	—	—	120	135	160	120	140	165	110	130	155	105	125	150	—	—	—
S11	—	—	—	70	80	95	70	85	100	65	80	95	65	75	90	—	—	—
	—	—	—	230	260	310	230	280	330	215	260	310	215	245	295	—	—	—
S12	—	—	—	48	55	65	49	55	70	46	55	65	44	50	60	—	—	—
	—	—	—	155	180	215	160	180	230	150	180	215	145	165	195	—	—	—
S13	—	—	—	28	33	39	29	33	40	27	32	38	26	30	36	—	—	—
	—	—	—	90	110	130	95	110	130	90	105	125	85	100	120	—	—	—
H5	46	55	65	—	—	—	43	50	60	42	49	60	42	48	55	37	43	50
	150	180	215	—	—	—	140	165	195	140	160	195	140	155	180	120	140	165
H8	50	60	70	—	—	—	47	55	65	46	55	60	45	50	60	40	46	55
	165	195	230	—	—	—	155	180	215	150	180	195	150	165	195	130	150	180
H11	60	70	80	55	60	75	55	65	75	55	60	75	55	60	75	48	55	65
	195	230	260	180	195	245	180	215	245	180	195	245	180	195	245	155	180	215
H12	90	105	125	90	105	125	95	105	125	90	100	120	80	95	110	70	85	100
	295	345	410	295	345	410	310	345	410	295	330	395	260	310	360	230	280	330
H21	50	60	70	—	—	—	47	55	65	46	55	60	45	50	60	40	46	55
	165	195	230	—	—	—	155	180	215	150	180	195	150	165	195	130	150	180

R217/220.21-160 – Cutting data $v_c = (m/min)/(sf/min)$

SMG	F40M			MK2050			MS2050			MS2500			MH1000			H25		
	100%	70%	30%	100%	70%	30%	100%	70%	30%	100%	70%	30%	100%	70%	30%	100%	70%	30%
P1	220	255	305	235	275	335	240	280	335	315	370	440	—	—	—	—	—	—
	720	840	1000	770	900	1100	790	920	1100	1025	1225	1450	—	—	—	—	—	—
P2	210	250	300	230	270	325	235	275	330	305	360	430	—	—	—	—	—	—
	690	820	980	750	890	1075	770	900	1075	1000	1175	1400	—	—	—	—	—	—
P3	185	220	255	205	240	280	205	240	280	270	315	370	—	—	—	—	—	—
	610	720	840	670	790	920	670	790	920	890	1025	1225	—	—	—	—	—	—
P4	165	190	230	180	210	255	180	210	250	235	275	330	—	—	—	—	—	—
	540	620	750	590	690	840	590	690	820	770	900	1075	—	—	—	—	—	—
P5	155	185	220	170	200	240	170	200	240	225	265	315	—	—	—	—	—	—
	510	610	720	560	660	790	560	660	790	740	870	1025	—	—	—	—	—	—
P6	175	205	245	190	225	270	195	225	270	255	295	355	—	—	—	—	—	—
	570	670	800	620	740	890	640	740	890	840	970	1175	—	—	—	—	—	—
P7	165	195	230	180	215	255	180	215	255	240	280	335	—	—	—	—	—	—
	540	640	750	590	710	840	590	710	840	790	920	1100	—	—	—	—	—	—
P8	155	185	215	170	200	235	170	200	235	225	265	310	—	—	—	—	—	—
	510	610	710	560	660	770	560	660	770	740	870	1025	—	—	—	—	—	—
P11	160	190	225	175	205	250	175	210	250	230	270	325	—	—	—	—	—	—
	520	620	740	570	670	820	570	690	820	750	890	1075	—	—	—	—	—	—
P12	105	125	150	120	140	160	115	135	165	155	180	215	—	—	—	—	—	—
	345	410	490	395	460	520	375	445	540	510	590	710	—	—	—	—	—	—
M1	170	200	240	—	—	—	190	220	265	220	255	310	—	—	—	—	—	—
	560	660	790	—	—	—	620	720	870	720	840	1025	—	—	—	—	—	—
M2	140	165	195	—	—	—	155	180	215	180	210	250	—	—	—	—	—	—
	460	540	640	—	—	—	510	590	710	590	690	820	—	—	—	—	—	—
M3	115	135	160	—	—	—	125	145	175	145	170	205	—	—	—	—	—	—
	375	445	520	—	—	—	410	475	570	475	560	670	—	—	—	—	—	—
M4	90	105	125	—	—	—	100	115	135	115	135	155	—	—	—	—	—	—
	295	345	410	—	—	—	330	375	445	375	445	510	—	—	—	—	—	—
M5	75	85	100	—	—	—	80	95	115	95	110	130	—	—	—	—	—	—
	245	280	330	—	—	—	260	310	375	310	360	425	—	—	—	—	—	—
K1	170	195	235	250	290	350	—	—	—	—	—	—	205	240	290	—	—	—
	560	640	770	820	950	1150	—	—	—	—	—	—	670	790	950	—	—	—
K2	150	175	210	220	260	310	—	—	—	—	—	—	180	215	255	—	—	—
	490	570	690	720	850	1025	—	—	—	—	—	—	590	710	840	—	—	—
K3	125	145	175	185	220	265	—	—	—	—	—	—	155	180	215	—	—	—
	410	475	570	610	720	870	—	—	—	—	—	—	510	590	710	—	—	—
K4	120	140	170	180	210	250	—	—	—	—	—	—	145	170	205	—	—	—
	395	460	560	590	690	820	—	—	—	—	—	—	475	560	670	—	—	—
K5	75	85	105	110	130	155	—	—	—	—	—	—	90	105	125	—	—	—
	245	280	345	360	425	510	—	—	—	—	—	—	295	345	410	—	—	—
K6	105	125	150	155	185	220	—	—	—	—	—	—	130	150	180	—	—	—
	345	410	490	510	610	720	—	—	—	—	—	—	425	490	590	—	—	—
K7	95	110	130	140	165	195	—	—	—	—	—	—	115	135	160	—	—	—
	310	360	425	460	540	640	—	—	—	—	—	—	375	445	520	—	—	—
N1	1225	1425	1725	—	—	—	—	—	—	—	—	—	—	—	—	1300	1525	1800
	4025	4675	5650	—	—	—	—	—	—	—	—	—	—	—	—	4275	5000	5900
N2	495	580	700	—	—	—	—	—	—	—	—	—	—	—	—	530	620	730
	1625	1900	2300	—	—	—	—	—	—	—	—	—	—	—	—	1750	2025	2400
N3	330	385	465	—	—	—	—	—	—	—	—	—	—	—	—	350	410	485
	1075	1275	1525	—	—	—	—	—	—	—	—	—	—	—	—	1150	1350	1600
N11	375	440	530	—	—	—	—	—	—	—	—	—	—	—	—	400	470	550
	1225	1450	1750	—	—	—	—	—	—	—	—	—	—	—	—	1300	1550	1800
S1	42	49	55	—	—	—	46	55	65	55	65	75	—	—	—	—	—	—
	140	160	180	—	—	—	150	180	215	180	215	245	—	—	—	—	—	—
S2	34	39	46	—	—	—	37	43	50	45	50	60	—	—	—	—	—	—
	110	130	150	—	—	—	120	140	165	150	165	195	—	—	—	—	—	—
S3	30	34	40	—	—	—	33	38	44	40	46	55	—	—	—	—	—	—
	100	110	130	—	—	—	110	125	145	130	150	180	—	—	—	—	—	—
S11	60	70	80	—	—	—	65	75	90	80	90	110	—	—	—	—	—	—
	195	230	260	—	—	—	215	245	295	260	295	360	—	—	—	—	—	—
S12	40	47	55	—	—	—	44	50	60	55	65	75	—	—	—	—	—	—
	130	155	180	—	—	—	145	165	195	180	215	245	—	—	—	—	—	—
S13	24	27	32	—	—	—	26	30	35	32	37	43	—	—	—	—	—	—
	80	90	105	—	—	—	85	100	115	105	120	140	—	—	—	—	—	—
H5	37	42	50	—	—	—	—	—	—	—	—	—	46	55	65	—	—	—
	120	140	165	—	—	—	—	—	—	—	—	—	150	180	215	—	—	—
H8	40	46	55	—	—	—	—	—	—	—	—	—	49	55	70	—	—	—
	130	150	180	—	—	—	—	—	—	—	—	—	160	180	230	—	—	—
H11	46	55	65	—	—	—	—	—	—	—	—	—	60	65	80	—	—	—
	150	180	215	—	—	—	—	—	—	—	—	—	195	215	260	—	—	—
H12	70	80	95	—	—	—	—	—	—	—	—	—	90	100	120	—	—	—
	230	260	310	—	—	—	—	—	—	—	—	—	295	330	395	—	—	—
H21	40	46	55	—	—	—	—	—	—	—	—	—	49	55	70	—	—	—
	130	150	180	—	—	—	—	—	—	—	—	—	160	180	230	—	—	—

Square shoulder and slot milling cutters
Helical milling cutters
Face milling cutters
Disc milling cutters
High feed milling cutters
Copy milling cutters
Plunge milling cutters
Chamfer milling cutters
Spot facing cutters
Inserts

- Square shoulder and slot milling cutters
- Helical milling cutters
- Face milling cutters
- Disc milling cutters
- High feed milling cutters
- Copy milling cutters
- Plunge milling cutters
- Chamfer milling cutters
- Spot facing cutters
- Inserts



R220.21 (SC12) HIGH FEED

High feed mills for high-torque machines, for SCET12 inserts, 4-cutting edge, single sided. These cutter bodies with fixed pockets are optimised for strong horizontal machines. SCET120630T is our 6.35-mm thick insert range with a corner radius of 3.0 mm.

- Cutter range 50-160 mm (2 - 4 inch)
- Max depth of cut 1,5 mm (.059 inch)
- Heavy roughing operations
- Large, powerful machines

R220.21-SC – Metric

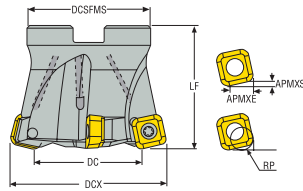

- For insert selection and cutting data recommendations, see page(s) 600-601
- For complete insert programme, see page(s) 843
- For ISO attribute explanation, see page 16

Designation	Item number	Type of mounting	DC	DCX	ZEFP	APMXS	APMXE	DCB	DCSFMS	LF	RP	RMPX°	Cmin	Cmax	Weight	RPMX	Insert
			mm	mm		mm	mm	mm	mm	mm	mm		mm	mm	kg		
R220.21-0050-SC12.4A	02600275	Arbor	31,0	50,0	4	1,5	9,0	22,0	42,0	40,0	4,4	2,3	81,0	98,0	0,3	10700	SC..12
R220.21-0050-SC12.5A	03136672	Arbor	31,0	50,0	5	1,5	9,0	22,0	42,0	40,0	4,4	2,1	81,0	98,0	0,4	10700	SC..12
R220.21-0052-SC12.4A	02585965	Arbor	33,0	52,0	4	1,5	9,0	22,0	42,0	40,0	4,4	2,2	85,0	102,0	0,3	10500	SC..12
R220.21-0052-SC12.5A	03138188	Arbor	33,0	52,0	5	1,5	9,0	22,0	47,0	40,0	4,5	2,0	85,0	102,0	0,4	10500	SC..12
R220.21-0063-SC12.4A	02585966	Arbor	44,0	63,0	4	1,5	9,0	27,0	50,0	50,0	4,4	0,9	107,0	124,0	0,6	9600	SC..12
R220.21-0063-SC12.5A	02682416	Arbor	44,0	63,0	5	1,5	9,0	27,0	50,0	50,0	4,4	0,9	107,0	124,0	0,6	9600	SC..12
R220.21-0063-SC12.6A	03136673	Arbor	44,0	63,0	6	1,5	9,0	27,0	50,0	50,0	4,4	0,6	107,0	124,0	0,7	9600	SC..12
R220.21-0066-SC12.4A	02585968	Arbor	47,0	66,0	4	1,5	9,0	27,0	60,0	50,0	4,4	0,85	113,0	130,0	0,6	9400	SC..12
R220.21-0066-SC12.6A	03138192	Arbor	47,1	66,0	6	1,5	9,0	27,0	62,0	50,0	4,4	0,7	113,1	130,0	0,9	9400	SC..12
R220.21-0080-SC12.5A	02585971	Arbor	61,0	80,0	5	1,5	9,0	27,0	62,0	50,0	4,4	0,8	141,0	158,0	1,0	8500	SC..12
R220.21-0080-SC12.6A	02682419	Arbor	61,0	80,0	6	1,5	9,0	27,0	62,0	50,0	4,4	0,8	141,0	158,0	1,0	8500	SC..12
R220.21-0080-SC12.7A	03136674	Arbor	61,1	80,0	7	1,5	9,0	27,0	62,0	50,0	4,4	0,8	141,1	158,0	1,0	8500	SC..12
R220.21-0084-SC12.5A	02600279	Arbor	65,0	84,0	5	1,5	9,0	32,0	77,0	55,0	4,4	0,8	149,0	166,0	1,2	8300	SC..12
R220.21-0084-SC12.6A	03136675	Arbor	65,1	84,0	6	1,5	9,0	32,0	77,0	55,0	4,4	0,8	149,1	166,0	1,4	8300	SC..12
R220.21-0100-SC12.5A	02585973	Arbor	81,0	100,0	5	1,5	9,0	32,0	77,0	50,0	4,4	0,75	181,0	198,0	1,3	7600	SC..12
R220.21-0100-SC12.7A	02682422	Arbor	81,0	100,0	7	1,5	9,0	32,0	77,0	50,0	4,4	0,75	181,0	198,0	1,5	7600	SC..12
R220.21-0100-SC12.8A	03136676	Arbor	81,0	100,0	8	1,5	9,0	32,0	77,0	50,0	4,4	0,6	181,0	198,0	1,5	7600	SC..12
R220.21-0125-SC12.6A	02585974	Arbor	106,0	125,0	6	1,5	9,0	40,0	90,0	63,0	4,4	0,7	231,0	248,0	2,4	6800	SC..12
R220.21-8160-SC12.7	02585975	Arbor	141,0	160,0	7	1,5	9,0	40,0	90,0	63,0	4,4	0,7	-	-	3,8	6000	SC..12

Square shoulder and slot milling cutters

Helical milling cutters

Face milling cutters

Disc milling cutters

High feed milling cutters

Copy milling cutters

Plunge milling cutters

Chamfer milling cutters

Spot facing cutters

Inserts

Spare Parts, included in delivery

For cutter	Arbor screw	Insert key	Insert screw
R220.21-0050-0052	220.17-692M	H6B-T20P	C45011-T20P
R220.21-0063-0066	MC6S12X35	H6B-T20P	C45011-T20P
R220.21-0080	MC6S12X35	H6B-T20PL	C45011-T20P
R220.21-0084	MC6S16X40	H6B-T20PL	C45011-T20P
R220.21-0100	MLC6S16X35	H6B-T20PL	C45011-T20P
R220.21-0125	-	H6B-T20PL	C45011-T20P
R220.21-8160	-	1/4HEX-T20PX90	C45011-T20P

Accessories

For cutter	Adjustable Torque key	Adjustable Torque key 2	Arbor screw	Insert clamping torque	Torque key
R220.21-0050-0125	-	-	-	5.0NM	T00-20P50
R220.21-8160	1/4HEX-S-HANDLE-0.8-5.0NM	1/4HEX-T-HANDLE-5.0-14.0NM	MC6S12X40	5.0NM	T00-20P50

Torque and fixed keys, see page 894

Square shoulder and slot milling cutters
Helical milling cutters
Face milling cutters
Disc milling cutters
High feed milling cutters
Copy milling cutters
Plunge milling cutters
Chamfer milling cutters
Spot facing cutters
Inserts

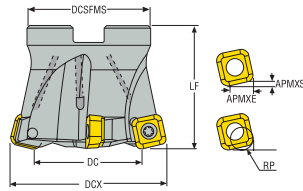

R220.21-SC – inch



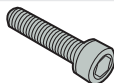
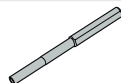

- For insert selection and cutting data recommendations, see page(s) 600-601
- For complete insert programme, see page(s) 843
- For ISO attribute explanation, see page 16

Designation	Item number	Type of mounting	DC	DCX	ZEFP	APMXS	APMXE	DCB	DCSFMS	LF	RP	RMPX°	C min	C max	Weight	RPMX	Insert
			inch	inch		inch	inch	inch	inch	inch	inch		inch	inch	lbs		
R220.21-02.00-SC12-4A	02589073	Arbor	1.250	2.000	4	0.059	0.354	0.750	1.750	1.600	0.173	2,3	3.250	3.921	0.880	10700	SC..12
R220.21-02.00-SC12-5A	03136677	Arbor	1.248	2.000	5	0.059	0.354	0.750	1.750	1.600	0.173	2,1	3.248	3.921	1.100	10700	SC..12
R220.21-02.50-SC12-4A	02589074	Arbor	1.750	2.500	4	0.059	0.354	0.750	1.750	2.000	0.173	0,9	4.250	4.921	1.320	9600	SC..12
R220.21-03.00-SC12-5A	02589075	Arbor	2.250	3.000	5	0.059	0.354	1.000	2.250	2.000	0.173	0,8	5.250	5.921	1.980	8500	SC..12
R220.21-03.00-SC12-6A	03136680	Arbor	2.256	3.000	6	0.059	0.354	1.000	2.250	2.000	0.173	0,6	5.256	5.921	2.200	8500	SC..12

Spare Parts, included in delivery

For cutter	Arbor screw	Insert key	Insert screw
R220.21-02.00	 UC6S3/8UNFX1	 H6B-T20P	 C45011-T20P
R220.21-02.00.5A	UC6S3/8UNFX1-1/4	H6B-T20P	C45011-T20P
R220.21-02.50	UC6S3/8UNFX11/2	H6B-T20P	C45011-T20P
R220.21-03.00	UC6S1/2UNFX1-1/4	H6B-T20P	C45011-T20P
R220.21-03.00.6A	UC6S1/2UNFX1-1/2	H6B-T20P	C45011-T20P

Accessories

For cutter	Insert clamping torque	Torque key
R220.21-..	 44.3IN.LBS	 T00-20P50

Torque and fixed keys, see page 894

Square shoulder and slot milling cutters

Helical milling cutters

Face milling cutters

Disc milling cutters

High feed milling cutters

Copy milling cutters

Plunge milling cutters

Chamfer milling cutters

Spot facing cutters

Inserts

R220.21-SC12 – Insert selection – mm/Inch

SMG		a _p	f _z		
			100%	70%	30%
P1	SCET120630T-M14 MP2501	1,5	1,0	1,0	1,1
		0,060	0,040	0,040	0,044
P2	SCET120630T-M14 MP2501	1,5	1,0	1,0	1,1
		0,060	0,040	0,040	0,044
P3	SCET120630T-M14 MP2501	1,5	0,95	0,95	1,1
		0,060	0,038	0,038	0,044
P4	SCET120630T-M14 MP2501	1,5	0,90	0,90	1,0
		0,060	0,036	0,036	0,040
P5	SCET120630T-M14 MP2501	1,5	0,90	0,90	1,0
		0,060	0,036	0,036	0,040
P6	SCET120630T-MD16 MS2500	1,5	1,0	1,0	1,1
		0,060	0,040	0,040	0,044
P7	SCET120630T-MD16 MS2500	1,5	1,0	1,0	1,1
		0,060	0,040	0,040	0,044
P8	SCET120630T-MD16 MP2501	1,5	1,1	1,1	1,2
		0,060	0,044	0,044	0,048
P11	SCET120630T-MD16 MS2500	1,5	1,0	1,0	1,1
		0,060	0,040	0,040	0,044
P12	SCET120630T-MD16 MS2500	1,2	0,70	0,70	0,80
		0,046	0,028	0,028	0,032
M1	SCET120630T-M14 F40M	1,5	1,0	1,0	1,1
		0,060	0,040	0,040	0,044
M2	SCET120630T-M14 F40M	1,5	0,90	0,90	1,0
		0,060	0,036	0,036	0,040
M3	SCET120630T-M14 F40M	1,2	0,75	0,75	0,80
		0,046	0,030	0,030	0,032
M4	SCET120630T-M14 F40M	1,2	0,65	0,65	0,70
		0,046	0,026	0,026	0,028
M5	SCET120630T-M14 F40M	1,2	0,65	0,65	0,70
		0,046	0,026	0,026	0,028
K1	SCET120630T-MD16 MP1501	1,5	1,1	1,1	1,3
		0,060	0,044	0,044	0,050
K2	SCET120630T-MD16 MP1501	1,5	1,0	1,0	1,2
		0,060	0,040	0,040	0,048
K3	SCET120630T-MD16 MP1501	1,5	1,0	1,0	1,2
		0,060	0,040	0,040	0,048
K4	SCET120630T-MD16 MP1501	1,5	1,0	1,0	1,2
		0,060	0,040	0,040	0,048
K5	SCET120630T-MD16 MP1501	1,5	0,95	0,95	1,0
		0,060	0,038	0,038	0,040
K6	SCET120630T-MD16 MP1501	1,5	1,0	1,0	1,2
		0,060	0,040	0,040	0,048
K7	SCET120630T-MD16 MP1501	1,5	0,95	0,95	1,0
		0,060	0,038	0,038	0,040
S1	SCET120630T-M14 MS2500	1,2	0,65	0,65	0,70
		0,046	0,026	0,026	0,028
S2	SCET120630T-M14 MS2500	1,2	0,65	0,65	0,70
		0,046	0,026	0,026	0,028
S3	SCET120630T-M14 MS2500	1,2	0,60	0,60	0,65
		0,046	0,024	0,024	0,026
S11	SCET120630T-M14 MS2500	1,2	0,75	0,75	0,80
		0,046	0,030	0,030	0,032
S12	SCET120630T-M14 MS2500	1,2	0,75	0,75	0,80
		0,046	0,030	0,030	0,032
S13	SCET120630T-M14 MS2500	1,2	0,65	0,65	0,70
		0,046	0,026	0,026	0,028
H5	SCET120630T-MD16 MP1501	1,2	0,70	0,70	0,80
		0,046	0,028	0,028	0,032
H8	SCET120630T-MD16 MP1501	1,2	0,55	0,55	0,60
		0,046	0,022	0,022	0,024
H11	SCET120630T-MD16 T350M	1,2	0,70	0,70	0,80
		0,046	0,028	0,028	0,032
H12	SCET120630T-MD16 T350M	1,2	0,55	0,55	0,60
		0,046	0,022	0,022	0,024
H21	SCET120630T-MD16 MP1501	1,2	0,55	0,55	0,60
		0,046	0,022	0,022	0,024

SMG = Seco material group
 f_z = mm/tooth (in/tooth), v_c = m/min (sf/min), a_p/DC = %
 All cutting data are start values

R220.21-SC12 – Cutting data $v_c = (m/min)/(sf/min)$

SMG	MP1501			MP2501			MP3000			T350M			F40M			MK2050			MS2500		
	100%	70%	30%	100%	70%	30%	100%	70%	30%	100%	70%	30%	100%	70%	30%	100%	70%	30%	100%	70%	30%
P1	305	350	425	270	310	380	265	305	375	245	280	345	215	245	300	275	320	390	305	355	435
	1000	1150	1400	890	1025	1250	870	1000	1225	800	920	1125	710	800	980	900	1050	1275	1000	1175	1425
P2	295	340	415	260	300	370	255	295	355	235	270	330	205	235	285	265	305	370	295	340	410
	970	1125	1350	850	980	1225	840	970	1175	770	890	1075	670	770	940	870	1000	1225	970	1125	1350
P3	255	290	365	225	260	325	225	255	315	205	235	290	180	205	250	230	265	330	255	295	365
	840	950	1200	740	850	1075	740	840	1025	670	770	950	590	670	820	750	870	1075	840	970	1200
P4	230	265	325	205	235	285	200	230	280	185	210	255	160	185	220	210	240	290	230	265	320
	750	870	1075	670	770	940	660	750	920	610	690	840	520	610	720	690	790	950	750	870	1050
P5	220	255	310	195	225	275	190	220	275	175	200	250	155	175	220	200	230	285	220	250	315
	720	840	1025	640	740	900	620	720	900	570	660	820	510	570	720	660	750	940	720	820	1025
P6	245	285	345	220	250	305	215	245	305	195	225	280	170	195	245	225	255	320	245	285	355
	800	940	1125	720	820	1000	710	800	1000	640	740	920	560	640	800	740	840	1050	800	940	1175
P7	235	270	325	205	235	290	200	230	290	185	215	265	160	185	230	210	240	300	235	265	335
	770	890	1075	670	770	950	660	750	950	610	710	870	520	610	730	690	790	980	770	870	1100
P8	215	245	310	190	215	275	190	215	265	175	200	245	150	170	210	195	225	275	215	250	305
	710	800	1025	620	710	900	620	710	870	570	660	800	490	560	690	640	740	900	710	820	1000
P11	225	260	315	200	230	280	195	225	280	180	205	260	155	180	225	205	235	290	225	260	325
	740	850	1025	660	750	920	640	740	920	590	670	850	510	590	740	670	770	950	740	850	1075
P12	150	170	210	130	150	185	130	145	180	120	135	165	105	120	145	135	155	190	150	170	210
	490	560	690	425	490	610	425	475	590	395	445	540	345	395	475	445	510	620	490	560	690
M1	—	—	—	190	215	265	190	220	265	180	210	255	165	190	230	—	—	—	210	240	295
	—	—	—	620	710	870	620	720	870	590	690	840	540	620	750	—	—	—	690	790	970
M2	—	—	—	155	180	220	160	185	230	150	175	215	135	160	195	—	—	—	175	200	250
	—	—	—	510	590	720	520	610	750	490	570	710	445	520	640	—	—	—	570	660	820
M3	—	—	—	125	140	180	130	145	180	120	135	170	110	125	155	—	—	—	140	160	200
	—	—	—	410	460	590	425	475	590	395	445	560	360	410	510	—	—	—	460	520	660
M4	—	—	—	95	110	140	100	115	140	95	105	135	85	95	120	—	—	—	110	125	155
	—	—	—	310	360	460	330	375	460	310	345	445	280	310	395	—	—	—	360	410	510
M5	—	—	—	80	90	115	85	95	115	80	90	110	70	80	100	—	—	—	90	105	130
	—	—	—	260	295	375	280	310	375	260	295	360	230	260	330	—	—	—	295	345	425
K1	235	270	330	210	240	290	200	230	285	185	215	260	160	185	225	285	330	400	—	—	—
	770	890	1075	690	790	950	660	750	940	610	710	850	520	610	740	940	1075	1300	—	—	—
K2	210	240	290	185	215	260	180	210	260	165	190	240	145	165	205	255	295	365	—	—	—
	690	790	950	610	710	850	590	690	850	540	620	790	475	540	670	840	970	1200	—	—	—
K3	175	205	245	155	180	220	155	175	220	140	160	200	125	140	175	215	250	310	—	—	—
	570	670	800	510	590	720	510	570	720	460	520	660	410	460	570	710	820	1025	—	—	—
K4	170	195	235	150	170	210	145	170	210	135	155	195	115	135	165	205	240	295	—	—	—
	560	640	770	490	560	690	475	560	690	445	510	640	375	445	540	670	790	970	—	—	—
K5	100	120	145	90	105	130	90	105	125	85	95	115	70	85	100	130	145	180	—	—	—
	330	395	475	295	345	425	295	345	410	280	310	375	230	280	330	425	475	590	—	—	—
K6	150	170	210	130	150	185	130	150	185	120	135	170	105	120	145	185	210	260	—	—	—
	490	560	690	425	490	610	425	490	610	395	445	560	345	395	475	610	690	850	—	—	—
K7	130	155	185	115	135	165	115	135	160	105	120	150	90	105	130	165	190	230	—	—	—
	425	510	610	375	445	540	375	445	520	345	395	490	295	345	425	540	620	750	—	—	—
N1	—	—	—	—	—	—	1475	1700	2100	—	—	—	1175	1350	1675	—	—	—	—	—	—
	—	—	—	—	—	—	4850	5575	6900	—	—	—	3850	4425	5500	—	—	—	—	—	—
N2	—	—	—	—	—	—	600	680	840	—	—	—	475	550	670	—	—	—	—	—	—
	—	—	—	—	—	—	1975	2225	2750	—	—	—	1550	1800	2200	—	—	—	—	—	—
N3	—	—	—	—	—	—	395	455	560	—	—	—	320	365	450	—	—	—	—	—	—
	—	—	—	—	—	—	1300	1500	1825	—	—	—	1050	1200	1475	—	—	—	—	—	—
N11	—	—	—	—	—	—	455	520	640	—	—	—	365	415	510	—	—	—	—	—	—
	—	—	—	—	—	—	1500	1700	2100	—	—	—	1200	1350	1675	—	—	—	—	—	—
S1	—	—	—	—	—	—	46	55	65	44	50	60	40	45	55	—	—	—	55	60	75
	—	—	—	—	—	—	150	180	215	145	165	195	130	150	180	—	—	—	180	195	245
S2	—	—	—	—	—	—	37	42	55	35	40	50	32	37	45	—	—	—	43	49	60
	—	—	—	—	—	—	120	140	180	115	130	165	105	120	150	—	—	—	140	160	195
S3	—	—	—	—	—	—	33	37	46	31	36	44	28	32	40	—	—	—	38	43	55
	—	—	—	—	—	—	110	120	150	100	120	145	90	105	130	—	—	—	125	140	180
S11	—	—	—	—	—	—	65	75	90	60	70	85	55	65	80	—	—	—	75	85	105
	—	—	—	—	—	—	215	245	295	195	230	280	180	215	260	—	—	—	245	280	345
S12	—	—	—	—	—	—	45	50	65	42	48	60	38	44	55	—	—	—	50	60	75
	—	—	—	—	—	—	150	165	215	140	155	195	125	145	180	—	—	—	165	195	245
S13	—	—	—	—	—	—	26	30	37	25	28	35	23	26	32	—	—	—	30	34	42
	—	—	—	—	—	—	85	100	120	80	90	115	75	85	105	—	—	—	100	110	140
H5	49	55	70	—	—	—	40	46	55	40	45	55	34	39	48	—	—	—	—	—	—
	160	180	230	—	—	—	130	150	180	130	150	180	110	130	155	—	—	—	—	—	—
H8	50	60	75	—	—	—	43	49	60	42	48	60	36	41	50	—	—	—	—	—	—
	165	195	245	—	—	—	140	160	195	140											

Square shoulder and slot milling cutters

Helical milling cutters

Face milling cutters

Disc milling cutters

High feed milling cutters

Copy milling cutters

Plunge milling cutters

Chamfer milling cutters

Spot facing cutters

Inserts



Code keys metric and inch

R	217	29	16	16	0	04	2	140	A
1	2	3	4	5	6	7	8	9	10

R	217	29I	01.00	0	06	2	A
1	2	3	4	6	7	8	9

1.	2.	3.
R = Right hand rotation Cx = For Seco-Capto	217 = With shank 220 = For arbor	Cutter system
4.	5. (Not for inch designation)	6.
Shank diameter (connecting thread diameter for Combimaster)	Outer cutting diameter/ball nose type = cutting diameter	Shank type RE = Combimaster 0. = Cylindrical 3. = Weldon
7.	8.	9.
Max. axial cutting depth	No. of teeth	Setting length (for the shank for combimaster)
10.		
A = Through coolant supply E = Solid carbide shank		

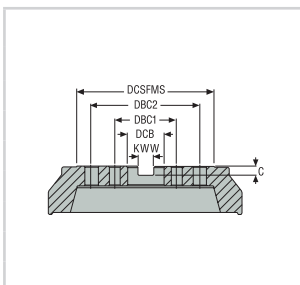

Dimensions in mm					
DCB	DCSFMS	DBC1	DBC2	KWW	C
16	30-35	-	-	8,4	5,6
22	42-47	-	-	10,4	6,3
27	48-62	-	-	12,4	7
32	60-90	-	-	14,4	8
40	90-130	66,7	-	16,4	9
60	130-270	101,6	177,8	25,7	14

Dimensions in inch					
DCB	DCSFMS	DBC1	DBC2	KWW	C
0.500	1.181 - 1.378	-	-	0.258	0.165
0.750	1.378 - 1.850	-	-	0.321	0.193
1.000	1.803 - 2.441	-	-	0.382	0.224
1.250	2.250 - 3.031	-	-	0.508	0.287
1.500	2.750 - 3.543	-	-	0.630	0.382
2.000	4.331	-	-	0.756	0.445
2.500	5.118 - 6.299 (8.858)	4.000	(7.000)	1.000	0.551

For a more exact DCSFMS and DCB measurement, see each product table.

Square shoulder and slot milling cutters
Helical milling cutters
Face milling cutters
Disc milling cutters
High feed milling cutters
Copy milling cutters
Plunge milling cutters
Chamfer milling cutters
Spot facing cutters
Inserts

Selection – Metric

	Cutter	Insert	Material suitability					Corner radius (mm)	 	No. of cutting edges	Diameters (mm) available and max depth of cut (mm)								See page			
			P	M	K	N	S				H	12	16	20	25	30	32	40		50		
R218.20	218.20-060		■	■	■	▣	■	-	6,0	■	□	▣	2	10								
	218.20-080		■	■	■	▣	■	▣	8,0	■	▣	▣	2		14							
	218.20-100		■	■	■	▣	■	▣	10,0	■	■	▣	2			18						
	218.20-125		■	■	■	▣	■	▣	12,5	■	■	▣	2				22					
	218.20-150		■	■	■	▣	■	▣	15,0	▣	■	▣	2					27				
	218.20-160		■	■	■	▣	■	▣	16,0	▣	■	▣	2						28			
	218.20-200		■	■	■	▣	■	-	20,0	□	■	▣	2								35	
	218.20-250		■	■	■	▣	■	-	25,0	□	■	▣	2									44
	R218.20 long cutting edge	218.20-150 / SPMT10		■	■	■	▣	■	▣	15,0	▣	■	▣	2/4					44			
218.20-160 / SPMT10			■	■	■	▣	■	▣	16,0	▣	■	▣	2/4						54			
218.20-200 / SC..12			■	■	■	▣	■	-	20,0	□	■	▣	2/4								60	
218.20-250 / SC..12			■	■	■	▣	■	-	25,0	□	■	▣	2/4									70

673, 674

1st choice	■	High speed machine with low power/torque		x indicates the maximum depth of cut	x
Alternative choice	▣	Strong stable machine with rigid connexion			
Possible choice	□	Unstable condition suitability			
Not recommended	-				

Selection – Metric

Cutter	Insert	Material suitability						Corner radius (mm)				No. of cutting edges	Diameters (mm) available and max depth of cut (mm)						See page
		P	M	K	N	S	H						16	20	25	30	32	40	
R218.19	218.19-080/SPMX06 	■	■	■	■	■	■	8,0	■	■	■	3/4	12						713
	218.19-100/SPMX07 	■	■	■	■	■	■	10,0	■	■	■	3/4		16					
	218.19-125/SPMX09 	■	■	■	■	■	■	16,0	■	■	■	3/4			26				
	218.19-160/SPMT10 	■	■	■	■	■	■	16,0	■	■	■	3/4				31			
R218.19 HFA	218.19-125 	■	■	■	■	■	■	12,5	■	■	■	3			12				715
	218.19-160 	■	■	■	■	■	■	16,0	■	■	■	3				16			
	218.19-200 	■	■	■	■	■	□	20,0	□	■	■	3					20		

1st choice	■	High speed machine with low power/torque		x indicates the maximum depth of cut	x
Alternative choice	■	Strong stable machine with rigid connection			
Possible choice	□	Unstable condition suitability			
Not recommended	-				

- Square shoulder and slot milling cutters
- Helical milling cutters
- Face milling cutters
- Disc milling cutters
- High feed milling cutters
- Copy milling cutters
- Plunge milling cutters
- Chamfer milling cutters
- Spot facing cutters
- Inserts

Selection – inch









Cutter	Insert	Material suitability						Corner radius (inch)				No. of cutting edges	Diameters (inch) available and max depth of cut (inch)						See page
		P	M	K	N	S	H						0.50	0.63	0.75	1.00	1.25	1.50	
R218.20	218.20-0.250 	■	■	■	▣	■	-	0.250	■	□	▣	2	0.433						
	218.20-080 	■	■	■	▣	■	▣	0.315	■	▣	▣	2		0.669					
	218.20-0.375 	■	■	■	▣	■	▣	0.375	■	■	▣	2				1.102			
	218.20-125 	■	■	■	▣	■	▣	0.492	■	■	▣	2							1.732
	218.20-160 	■	■	■	▣	■	▣	0.630	▣	■	▣	2				2.126			
	218.20-0.750 	■	■	■	▣	■	▣	0.750	▣	■	▣	2							2.756
	218.20-250 	■	■	■	▣	■	-		□	■	▣	2	0.551						
R218.20 long cutting edge	218.20-125 / SPMT10 	■	■	■	▣	■	▣	0.630	▣	■	▣	2/4			0.866				
	218.20-160 / SPMT10 	■	■	■	▣	■	▣		▣	■	▣	2/4				1.339			
	218.20-0.750 / SC..12 	■	■	■	▣	■	-	0.750	□	■	▣	2/4			1.772				
	218.20-250 / SC..12 	■	■	■	▣	■	-	0.984	□	■	▣	2/4					2.362		



673, 674

1st choice	■	High speed machine with low power/torque		x indicates the maximum depth of cut	x
Alternative choice	▣	Strong stable machine with rigid connection			
Possible choice	□	Unstable condition suitability			
Not recommended	-				

Square shoulder and slot milling cutters
Helical milling cutters
Face milling cutters
Disc milling cutters
High feed milling cutters
Copy milling cutters
Plunge milling cutters
Chamfer milling cutters
Spot facing cutters
Inserts

Selection – Inch

Cutter	Insert	Material suitability						Corner radius (inch)				No. of cutting edges	Diameters (inch) available and max depth of cut (inch)						See page		
		P	M	K	N	S	H						0.50	0.63	0.75	1.00	1.25	1.50		2.00	
R218.19	218.19-100/SPMX07 	■	▣	■	▣	■	▣	0.394	■	■	■	3/4			0.835						713
	218.19-125/SPMX09 	■	▣	■	▣	■	▣	0.492	■	■	■	3/4				1.063					
R218.19 HFA	218.19-125 	■	■	■	▣	■	▣		■	■	■	3									715
	218.19-160 	■	■	■	▣	■	▣		▣	■	■	3									
	218.19-200 	■	■	■	▣	■	□		□	■	■	3									

1st choice	■	High speed machine with low power/torque		x indicates the maximum depth of cut	x
Alternative choice	▣	Strong stable machine with rigid connection			
Possible choice	□	Unstable condition suitability			
Not recommended	-				

- Square shoulder and slot milling cutters
- Helical milling cutters
- Face milling cutters
- Disc milling cutters
- High feed milling cutters
- Copy milling cutters
- Plunge milling cutters
- Chamfer milling cutters
- Spot facing cutters
- Inserts

Selection – Metric

Insert	a _p max	a _p rec.	Material suitability									
			P	M	K	N	S	H				
Round 5 	2,5	1	■	▣	■	□	■	■	■	▣	■	□
Round 6 	3	1	■	■	■	■	▣	■	■	▣	■	□
Round 7 	3,5	1,5	■	▣	■	■	▣	■	■	▣	■	□
Round 8 	4	1,5	■	■	■	■	■	■	■	▣	■	▣
Round 10 	5	2	■	■	■	■	■	■	■	■	■	▣
Round 12 	6	3	■	■	■	■	■	■	■	□	■	▣
Round 16 	8	5	■	■	■	-	■	▣	-	■	■	▣
Round 20 	10	6	■	■	■	-	■	□	-	■	■	▣
Round 12 R217/220.28 	6	3	■	■	■	□	■	▣	□	■	□	▣

1st choice	■
Alternative choice	□
Possible choice	▣

High speed machine with low power/torque

Strong stable machine with rigid connection

Not recommended

Unstable condition suitability

Ramping ability

Plunging ability

a_p max = Maximum depth of cut possible
a_p rec. = Recommended depth of cut for optimal result

Square shoulder and slot milling cutters
Helical milling cutters
Face milling cutters
Disc milling cutters
High feed milling cutters
Copy milling cutters
Plunge milling cutters
Chamfer milling cutters
Spot facing cutters
Inserts

Selection – Metric

Insert	Applica-tion	Cutter diameter available (mm)/number of teeth																									See page		
		10	12	15	16	20	25	27	32	35	40	42	44	50	52	63	66	80	83	84	92	100	112	125	137	160		200	250
Round 5		2	3	4		5																							614
Round 6			2		3	4	5		6	7	8																		618
Round 7					3	4	5																						N/A
Round 8						2	3						5																626
					2	3	4		5		6		7																
Round 10										4		4		6															631
						2		4		5	5																		
					1	2	3	3	5	5	6	6		6	7	8													
Round 12										3	3		4	4	4	5		6		6		7		8					639
													5	5	6	6	7				7								
Round 16																				5		6		6		7			649, 650
											2		3		4	4	5/6	6	7			8		10		10			
Round 20																					4	4		5		5	6		658
Round 12														5	5	6	7	8											666
R217/220.28											3		4																

x x indicates number of teeth (first choice)
 Coarse pitch-troubleshooter for unstable conditions and long overhang
x x indicates number of teeth
 Normal pitch-alternative choice
 Close pitch-basic choice for productivity

- Square shoulder and slot milling cutters
- Helical milling cutters
- Face milling cutters
- Disc milling cutters
- High feed milling cutters
- Plunge milling cutters
- Chamfer milling cutters
- Spot facing cutters
- Inserts

Selection – Inch

Insert	a _p max	a _p rec.	Material suitability									
			P	M	K	N	S	H				
Round 5 	0.059	0.039	■	▣	■	□	■	■	■	▣	■	□
Round 6 	0.118	0.04	■	■	■	■	▣	■	■	▣	■	□
Round 7 	0.138	0.059	■	▣	■	■	▣	■	■	▣	■	□
Round 8 	0.158	0.059	■	■	■	■	■	■	■	▣	■	▣
Round 10 	0.197	0.079	■	■	■	■	■	■	■	■	■	▣
Round 12 	0.236	0.118	■	■	■	■	■	■	□	■	■	▣
Round 16 	0.315	0.197	■	■	■	-	■	▣	-	■	■	▣
Round 19 	0.374	0.160	■	■	■	-	■	□	-	■	■	▣
Round 20 	0.394	0.236	■	■	■	-	■	□	-	■	■	▣
Round 12 R217/220.28 			■	■	■	□	■	▣	□	■	□	▣

1st choice	■
Alternative choice	□
Possible choice	▣

High speed machine with low power/torque

Strong stable machine with rigid connection

Not recommended

Unstable condition suitability



















Ramping ability

Plunging ability

a_p max = Maximum depth of cut possible
a_p rec. = Recommended depth of cut for optimal result



Square shoulder and slot milling cutters
Helical milling cutters
Face milling cutters
Disc milling cutters
High feed milling cutters
Copy milling cutters
Plunge milling cutters
Chamfer milling cutters
Spot facing cutters
Inserts

Selection – Inch

Insert	Applica- tion	Cutter diameter available (inch)/number of teeth										See page
		0.75	1.00	1.25	1.50	2.00	2.50	3.00	4.00	5.00	6.00	
Round 5												614
Round 6		4	5	6								618
Round 7												N/A
Round 8												626
Round 10			3	4	5	6						631
												
												
Round 12			2	3	4	(4/5)	(6/7)	(6/7)	(7/9)		8	639
												
												
Round 16						4	5	6	7			649, 650
												
Round 19							4	6	5	7		658
									5	9		658
Round 20						3	4	4	5			658
												
Round 12												666
R217/220.28				3	4	(5/6)	7	8	(10/12)			

x x indicates number of teeth (first choice)

x x indicates number of teeth

-  Coarse pitch-troubleshooter for unstable conditions and long overhang
-  Normal pitch-alternative choice
-  Close pitch-basic choice for productivity

Square shoulder and slot milling cutters

Helical milling cutters

Face milling cutters

Disc milling cutters

High feed milling cutters

Copy milling cutters

Plunge milling cutters

Chamfer milling cutters

Spot facing cutters

Inserts

Selection – Metric

Cutter	Insert	Material suitability						Corner radius (mm)				No. of cutting edges	Diameters (mm) available and max depth of cut (mm)								See page	
		P	M	K	N	S	H						16	20	25	32	40	50	63	80		100
R217/220.97	R217/220.97-XP08 				■			0,4/0,8/ 1,6/2,0/ 2,4/3,1	■	■	■	2	2	2/3	3/4							736
	R217/220.97-XP12 				■			0,4/0,8/ 2,0/2,4/ 3,1/4,0	■	■	■	2		2	2/3	3	4					740
	R217/220.97-VP22 				■			0,5/0,8/ 1,6/2,0/ 2,4/3,1/ 4,0/4,8/6,3		■	■	2				2	2	2/3	3/4	4	5	744

1st choice	■	High speed machine with low power/torque		x indicates the maximum depth of cut	x
Alternative choice	▣	Strong stable machine with rigid connection			
Possible choice	□	Unstable condition suitability			
Not recommended	-				

Selection – inch

Cutter	Insert	Material suitability						Corner radius (inch)				No. of cutting edges	Diameters (inch) available and max depth of cut (inch)								See page	
		P	M	K	N	S	H						0.63	0.08	1.00	1.25	1.50	2.00	2.50	3.00		4.00
R217/220.97	R217/220.97-XP08 				■			0.016/0.031/ 0.063/0.079/ 0.094/0.122	■	■	■	2	2	2	3							736
	R217/220.97-XP12 				■			0.016/0.031/ 0.079/0.094/ 0.122/0.157	■	■	■	2			2	2	(2/3)	4	4	5		740
	R217/220.97-VP22 				■			0.020/0.031/ 0.063/0.079/ 0.094/0.122/		■	■	2			2	3	3	(3/4)				744

1st choice	■	High speed machine with low power/torque		x indicates the maximum depth of cut	x
Alternative choice	▣	Strong stable machine with rigid connection			
Possible choice	□	Unstable condition suitability			
Not recommended	-				



R217/220.29 ROUND INSERT CUTTERS

Our comprehensive range of round insert cutters, R217/220.29, is ideal for semi-finishing and roughing in all copy milling applications and materials.

- Insert size 05, cutter range 10-20mm
- Insert size 06, cutter range 12-40mm (0.75 - 1.25 inch)
- Insert size 07, cutter range 16-25mm
- Insert size 08, cutter range 16-50mm
- Insert size 3/4, cutter range (2.5 - 5 inch)
- Insert size 10, cutter range 16-63mm (1 - 2.0 inch)
- Insert size 12, cutter range 25-137mm (1 - 6 inch)
- Insert size 16, cutter range 32-160mm (2.0 - 4.0 inch)
- Insert size 20, cutter range 25-250mm (2 - 3 inch)

R217.29-025 – Metric

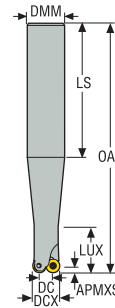

- For insert selection and cutting data recommendations, see page(s) 616-617
- For complete insert programme, see page(s) 839
- For ISO attribute explanation, see page 16

Designation	Item number	Type of mounting	DC	DCX	ZEFP	APMXS	DMM	LS	OAL	LUX	RMPX°	Cmin	Cmax	RPMX	Weight	Insert
			mm	mm		mm	mm	mm	mm	mm		mm	mm		kg	
R217.29-1010.0-025.2.090E	02495669	Cylindrical	5,0	10,0	2	2,5	10,0	100,0	130,0	30,0	90,0	15,0	18,0	75000	0,2	RDH.0501

Spare Parts, included in delivery

For cutter	Insert key	Insert screw
R217.29-..	H4B-T06P	C02035-T06P

Accessories

For cutter	Insert clamping torque	Torque key
R217.29-..	0.5NM	T00-06P05

Torque and fixed keys, see page 894

R217.29-025 – Metric

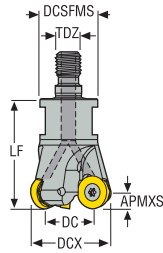



- For insert selection and cutting data recommendations, see page(s) 616-617
- For complete insert programme, see page(s) 839
- For ISO attribute explanation, see page 16



Designation	Item number	Type of mounting	DC	DCX	ZEFP	APMXS	TDZ	DCSFMS	LF	RMPX°	Cmin	Cmax	RPMX	Weight	Insert
			mm	mm		mm		mm	mm		mm	mm		kg	
R217.29-0612.RE-025.3A	02642920	Combimaster	7,0	12,0	3	2,5	M6	11,0	18,0	13,9	19,0	22,0	65000	0,1	RDH.0501
R217.29-0812.RE-025.3A	02495672	Combimaster	7,0	12,0	3	2,5	M8	13,5	20,0	13,9	19,0	22,0	65000	0,1	RDH.0501
R217.29-0815.RE-025.4A	02495675	Combimaster	10,0	15,0	4	2,5	M8	13,5	20,0	8,4	25,0	28,0	60000	0,1	RDH.0501
R217.29-1020.RE-025.5A	02643352	Combimaster	15,0	20,0	5	2,5	M10	18,0	23,0	5,0	35,0	38,0	50000	0,1	RDH.0501

For Combimaster Shanks, see Machining Navigator Tooling System

Spare Parts, included in delivery

For cutter	Insert key	Insert screw
		
R217.29-..	H4B-T06P	C02035-T06P

Accessories

For cutter	Insert clamping torque	Torque key
		
R217.29-..	0.5NM	T00-06P05

Torque and fixed keys, see page 894

Square shoulder and slot milling cutters

Helical milling cutters

Face milling cutters

Disc milling cutters

High feed milling cutters

Copy milling cutters

Plunge milling cutters

Chamfer milling cutters

Spot facing cutters

Inserts

R217.29-025 – Insert selection – mm/Inch

SMG		a_p		f_z			
				100%	70%	30%	10%
P1	RDHW0501M0-MD01 F40M	1,0	0,095	0,095	0,095	0,095	0,14
		0,040	0,0038	0,0038	0,0038	0,0038	0,0055
P2	RDHW0501M0-MD01 F40M	1,0	0,095	0,095	0,095	0,095	0,14
		0,040	0,0038	0,0038	0,0038	0,0038	0,0055
P3	RDHW0501M0-MD01 F40M	1,0	0,090	0,090	0,090	0,090	0,13
		0,040	0,0036	0,0036	0,0036	0,0036	0,0050
P4	RDHW0501M0-MD01 MP3000	1,0	0,090	0,090	0,090	0,090	0,13
		0,040	0,0036	0,0036	0,0036	0,0036	0,0050
P5	RDHW0501M0-MD01 MP3000	1,0	0,085	0,085	0,085	0,085	0,13
		0,040	0,0034	0,0034	0,0034	0,0034	0,0050
P6	RDHW0501M0-MD01 MP3000	1,0	0,085	0,085	0,085	0,085	0,12
		0,040	0,0034	0,0034	0,0034	0,0034	0,0048
P7	RDHW0501M0-MD01 MP3000	1,0	0,085	0,085	0,085	0,085	0,12
		0,040	0,0034	0,0034	0,0034	0,0034	0,0048
P8	RDHW0501M0-MD01 MP3000	1,0	0,090	0,090	0,090	0,090	0,13
		0,040	0,0036	0,0036	0,0036	0,0036	0,0050
P11	RDHW0501M0-MD01 MP3000	1,0	0,085	0,085	0,085	0,085	0,12
		0,040	0,0034	0,0034	0,0034	0,0034	0,0048
P12	RDHW0501M0-MD01 MP3000	0,80	0,065	0,065	0,065	0,065	0,085
		0,032	0,0026	0,0026	0,0026	0,0026	0,0034
M1	RDHW0501M0-MD01 F40M	1,0	0,095	0,095	0,095	0,095	0,14
		0,040	0,0038	0,0038	0,0038	0,0038	0,0055
M2	RDHW0501M0-MD01 F40M	1,0	0,085	0,085	0,085	0,085	0,13
		0,040	0,0034	0,0034	0,0034	0,0034	0,0050
M3	RDHW0501M0-MD01 F40M	0,80	0,080	0,080	0,080	0,080	0,10
		0,032	0,0032	0,0032	0,0032	0,0032	0,0040
M4	RDHW0501M0-MD01 F40M	0,60	0,080	0,080	0,075	0,075	0,090
		0,024	0,0032	0,0032	0,0030	0,0030	0,0036
M5	RDHW0501M0-MD01 F40M	0,60	0,080	0,080	0,075	0,075	0,090
		0,024	0,0032	0,0032	0,0030	0,0030	0,0036
K1	RDHW0501M0-MD01 MP3000	1,0	0,095	0,095	0,095	0,095	0,14
		0,040	0,0038	0,0038	0,0038	0,0038	0,0055
K2	RDHW0501M0-MD01 MP3000	1,0	0,085	0,085	0,085	0,085	0,13
		0,040	0,0034	0,0034	0,0034	0,0034	0,0050
K3	RDHW0501M0-MD01 MP3000	1,0	0,085	0,085	0,085	0,085	0,13
		0,040	0,0034	0,0034	0,0034	0,0034	0,0050
K4	RDHW0501M0-MD01 MP3000	1,0	0,085	0,085	0,085	0,085	0,13
		0,040	0,0034	0,0034	0,0034	0,0034	0,0050
K5	RDHW0501M0-MD01 MP3000	1,0	0,080	0,080	0,080	0,080	0,11
		0,040	0,0032	0,0032	0,0032	0,0032	0,0044
K6	RDHW0501M0-MD01 MP3000	1,0	0,085	0,085	0,085	0,085	0,13
		0,040	0,0034	0,0034	0,0034	0,0034	0,0050
K7	RDHW0501M0-MD01 MP3000	1,0	0,080	0,080	0,080	0,080	0,11
		0,040	0,0032	0,0032	0,0032	0,0032	0,0044
N1	RDHW0501M0-MD01 MP3000	1,0	0,12	0,12	0,12	0,12	0,18
		0,040	0,0048	0,0048	0,0048	0,0048	0,0070
N2	RDHW0501M0-MD01 MP3000	1,0	0,12	0,12	0,12	0,12	0,18
		0,040	0,0048	0,0048	0,0048	0,0048	0,0070
N3	RDHW0501M0-MD01 MP3000	1,0	0,12	0,12	0,12	0,12	0,18
		0,040	0,0048	0,0048	0,0048	0,0048	0,0070
N11	RDHW0501M0-MD01 MP3000	1,0	0,12	0,12	0,12	0,12	0,18
		0,040	0,0048	0,0048	0,0048	0,0048	0,0070
S1	RDHW0501M0-MD01 F40M	0,60	0,080	0,080	0,075	0,075	0,090
		0,024	0,0032	0,0032	0,0030	0,0030	0,0036
S2	RDHW0501M0-MD01 F40M	0,60	0,080	0,080	0,075	0,075	0,090
		0,024	0,0032	0,0032	0,0030	0,0030	0,0036
S3	RDHW0501M0-MD01 F40M	0,60	0,075	0,075	0,070	0,070	0,080
		0,024	0,0030	0,0030	0,0028	0,0028	0,0032
S11	RDHW0501M0-MD01 F40M	0,70	0,085	0,085	0,080	0,080	0,10
		0,028	0,0034	0,0034	0,0032	0,0032	0,0040
S12	RDHW0501M0-MD01 F40M	0,70	0,085	0,085	0,080	0,080	0,10
		0,028	0,0034	0,0034	0,0032	0,0032	0,0040
S13	RDHW0501M0-MD01 F40M	0,60	0,080	0,080	0,075	0,075	0,090
		0,024	0,0032	0,0032	0,0030	0,0030	0,0036
H5	RDHW0501M0-MD01 MP3000	0,80	0,065	0,065	0,065	0,065	0,085
		0,032	0,0026	0,0026	0,0026	0,0026	0,0034
H8	RDHW0501M0-MD01 MP3000	0,70	0,055	0,055	0,055	0,055	0,065
		0,028	0,0022	0,0022	0,0022	0,0022	0,0026
H11	RDHW0501M0-MD01 MP3000	0,80	0,065	0,065	0,065	0,065	0,085
		0,032	0,0026	0,0026	0,0026	0,0026	0,0034
H12	RDHW0501M0-MD01 F40M	0,70	0,055	0,055	0,055	0,055	0,065
		0,028	0,0022	0,0022	0,0022	0,0022	0,0026
H21	RDHW0501M0-MD01 MP3000	0,70	0,055	0,055	0,055	0,055	0,065
		0,028	0,0022	0,0022	0,0022	0,0022	0,0026

SMG = Seco material group
 f_z = mm/tooth (in/tooth), v_c = m/min (sf/min), a_p/DC = %
 All cutting data are start values

R217/220.29-025 – Cutting data $v_c = (m/min)/(sf/min)$

SMG	MP3000				F40M			
	100%	70%	30%	10%	100%	70%	30%	10%
P1	360	415	485	570	285	330	390	455
	1175	1350	1600	1875	940	1075	1275	1500
P2	350	400	475	550	280	320	380	440
	1150	1300	1550	1800	920	1050	1250	1450
P3	300	350	410	480	240	280	330	385
	980	1150	1350	1575	790	920	1075	1275
P4	265	305	360	420	215	245	290	340
	870	1000	1175	1375	710	800	950	1125
P5	255	295	350	405	205	235	280	325
	840	970	1150	1325	670	770	920	1075
P6	290	335	390	460	230	265	315	365
	950	1100	1275	1500	750	870	1025	1200
P7	270	315	370	435	220	250	295	345
	890	1025	1225	1425	720	820	970	1125
P8	255	295	345	405	205	235	275	325
	840	970	1125	1325	670	770	900	1075
P11	265	305	360	420	210	245	285	335
	870	1000	1175	1375	690	800	940	1100
P12	165	190	225	260	135	155	180	210
	540	620	740	850	445	510	590	690
M1	260	300	355	410	225	260	305	355
	850	980	1175	1350	740	850	1000	1175
M2	215	250	290	335	185	215	250	290
	710	820	950	1100	610	710	820	950
M3	170	195	230	265	145	165	195	230
	560	640	750	870	475	540	640	750
M4	130	150	175	205	110	125	150	175
	425	490	570	670	360	410	490	570
M5	105	125	145	170	95	105	125	145
	345	410	475	560	310	345	410	475
K1	275	320	375	435	220	255	300	350
	900	1050	1225	1425	720	840	980	1150
K2	245	280	330	385	195	225	265	305
	800	920	1075	1275	640	740	870	1000
K3	205	240	280	325	165	190	225	260
	670	790	920	1075	540	620	740	850
K4	195	225	265	310	160	180	215	245
	640	740	870	1025	520	590	710	800
K5	120	135	160	190	95	110	130	150
	395	445	520	620	310	360	425	490
K6	175	200	235	270	140	160	190	220
	570	660	770	890	460	520	620	720
K7	150	175	205	240	120	140	165	195
	490	570	670	790	395	460	540	640
N1	2075	2400	2850	3300	1675	1925	2275	2650
	6800	7875	9350	10825	5500	6325	7475	8700
N2	840	970	1150	1325	670	780	920	1075
	2750	3175	3775	4350	2200	2550	3025	3525
N3	560	650	760	890	450	520	610	710
	1825	2125	2500	2925	1475	1700	2000	2325
N11	640	740	870	1025	510	590	700	810
	2100	2425	2850	3375	1675	1925	2300	2650
S1	60	70	80	95	50	60	70	80
	195	230	260	310	165	195	230	260
S2	48	55	65	75	42	48	55	65
	155	180	215	245	140	155	180	215
S3	42	48	55	65	36	42	49	60
	140	155	180	215	120	140	160	195
S11	85	100	115	135	75	85	100	115
	280	330	375	445	245	280	330	375
S12	60	70	80	95	50	60	70	80
	195	230	260	310	165	195	230	260
S13	34	39	46	55	29	33	40	46
	110	130	150	180	95	110	130	150
H5	50	60	70	80	44	50	60	70
	165	195	230	260	145	165	195	230
H8	55	60	70	85	46	50	60	70
	180	195	230	280	150	165	195	230
H11	65	75	90	105	55	65	75	90
	215	245	295	345	180	215	245	295
H12	100	115	135	160	80	95	110	130
	330	375	445	520	260	310	360	425
H21	55	60	70	85	46	50	60	70
	180	195	230	280	150	165	195	230

Square shoulder and slot milling cutters
Helical milling cutters
Face milling cutters
Disc milling cutters
High feed milling cutters
Copy milling cutters
Plunge milling cutters
Chamfer milling cutters
Spot facing cutters
Inserts

R217.29-03 – Metric

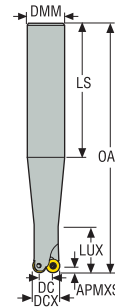

- For insert selection and cutting data recommendations, see page(s) 621-622
- For complete insert programme, see page(s) 839
- For ISO attribute explanation, see page 16

Designation	Item number	Type of mounting	DC	DCX	ZEFP	APMXS	DMM	LS	OAL	LUX	RMPX°	Cmin	Cmax	RPMX	Weight	Insert
			mm	mm		mm	mm	mm	mm	mm		mm	mm		kg	
R217.29-1612.0-03.2.050	02427364	Cylindrical	6,0	12,0	2	3,0	16,0	60,0	110,0	20,0	90,0	18,0	22,0	32000	0,2	RD.06T1
R217.29-1212.0-03.2.070E	02427368	Cylindrical	6,0	12,0	2	3,0	12,0	80,0	130,0	50,0	90,0	18,0	22,0	32000	0,3	RD.06T1
R217.29-2016.0-03.3.070	02427371	Cylindrical	10,0	16,0	3	3,0	20,0	60,0	130,0	30,0	15,62	26,0	30,0	28800	0,3	RD.06T1
R217.29-1616.0-03.3.100E	02427379	Cylindrical	10,0	16,0	3	3,0	16,0	140,0	160,0	50,0	15,62	26,0	30,0	28800	0,5	RD.06T1
R217.29-1620.0-03.4.100E	02427381	Cylindrical	14,0	20,0	4	3,0	16,0	140,0	160,0	100,0	9,84	34,0	38,0	25600	0,5	RD.06T1

Spare Parts, included in delivery

For cutter	Insert key	Insert screw
R217.29- ø12-16	H4B-T07P	C02204-T07P
R217.29- ø20-32	H4B-T07P	C02245-T07P

Accessories

For cutter	Insert clamping torque	Torque key
R217.29-..	0.9NM	T00-07P09

Torque and fixed keys, see page 894

R217/220.29-03 – Metric

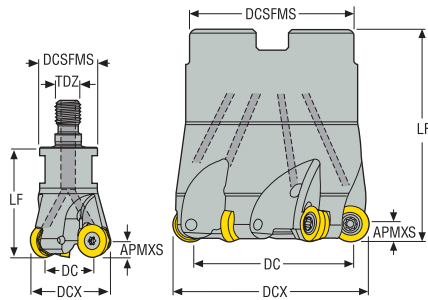

- For insert selection and cutting data recommendations, see page(s) 621-622
- For complete insert programme, see page(s) 839
- For ISO attribute explanation, see page 16

Designation	Item number	Type of mounting	DC	DCX	ZEPF	APMXS	TDZ	DCSFMS	LF	RMPX°	Cmin	Cmax	RPMX	Weight	Insert
			mm	mm		mm		mm	mm		mm	mm		kg	
R217.29-0816.RE-03.3	02435540	Combimaster	10,0	16,0	3	3,0	M8	13,5	23,0	15,62	26,0	30,0	28800	0,1	RD..06T1
R217.29-1020.RE-03.4A	02427383	Combimaster	14,0	20,0	4	3,0	M10	18,5	28,0	9,84	34,0	38,0	25600	0,1	RD..06T1
R217.29-1225.RE-03.5A	02427386	Combimaster	19,0	25,0	5	3,0	M12	23,0	28,0	6,76	44,0	48,0	23200	0,2	RD..06T1
R217.29-1632.RE-03.6A	02427388	Combimaster	26,0	32,0	6	3,0	M16	30,0	28,0	4,7	58,0	62,0	20000	0,2	RD..06T1
R217.29-1635.RE-03.7A	02427389	Combimaster	29,0	35,0	7	3,0	M16	30,0	28,0	4,16	64,0	68,0	19200	0,2	RD..06T1
R220.29-0040-03.8A	02427391	Arbor	34,0	40,0	8	3,0	–	35,0	35,0	3,49	74,0	78,0	17600	0,2	RD..06T1

For Combimaster Shanks, see Machining Navigator Tooling System

Spare Parts, included in delivery

For cutter	Arbor screw	Insert key	Insert screw
R217.29- ø16	–	H4B-T07P	C02204-T07P
R217.29- ø20-32	–	H4B-T07P	C02245-T07P
R220.29-0040	220.17-689	H4B-T07P	C02245-T07P

Accessories

For cutter	Insert clamping torque	Torque key
R217/220.29-..	0.9NM	T00-07P09

Torque and fixed keys, see page 894

R217/220.29-03 – inch

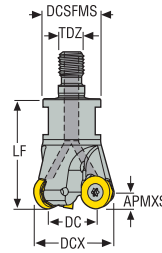

- For insert selection and cutting data recommendations, see page(s) 621-622
- For complete insert programme, see page(s) 839
- For ISO attribute explanation, see page 16

Designation	Item number	Type of mounting	DC	DCX	ZEPF	APMXS	TDZ	DCSFMS	LF	RMPX°	C min	C max	RPMX	Weight	Insert
			inch	inch		inch		inch	inch		inch	inch		lbs	
R217.29-0.75-10RE-03.4A	00096942	Combimaster	0.514	0.750	4	0.118	M10	0.728	1.100	9,84	1.264	1.421	25600	0.220	RD.06T1
R217.29-1.00-12RE-03.5A	00096943	Combimaster	0.764	1.000	5	0.118	M12	0.906	1.100	6,76	1.764	1.921	23200	0.220	RD.06T1
R217.29-1.25-16RE-03.6A	00096944	Combimaster	1.014	1.250	6	0.118	M16	1.181	1.100	4,7	2.264	2.421	20000	0.440	RD.06T1

For Combimaster Shanks, see Machining Navigator Tooling System

Spare Parts, included in delivery

For cutter	Insert key	Insert screw
R217.29-00.750	H4B-T07P	C02204-T07P
R217.29-01.00-01.25	H4B-T07P	C02245-T07P

Accessories

For cutter	Insert clamping torque	Torque key
R217.29-00.750	8.0IN.LBS	T00-07P09
R217.29-01.00-01.25	8.0IN.LBS	T00-07P09

Torque and fixed keys, see page 894

R217/220.29-03 – Insert selection – mm/Inch

SMG		a_p		f_z			
				100%	70%	30%	10%
P1	RDHT06T1M0-E02 F40M	1,2	0,065	0,065	0,065	0,060	0,095
		0,048	0,0026	0,0026	0,0026	0,0024	0,0038
P2	RDHT06T1M0-E02 F40M	1,2	0,065	0,065	0,065	0,065	0,095
		0,048	0,0026	0,0026	0,0026	0,0026	0,0038
P3	RDHT06T1M0-E02 F40M	1,2	0,060	0,060	0,060	0,060	0,090
		0,048	0,0024	0,0024	0,0024	0,0024	0,0036
P4	RDHW06T1M0-MD02 MP3000	1,2	0,090	0,090	0,090	0,085	0,13
		0,048	0,0036	0,0036	0,0036	0,0034	0,0050
P5	RDHW06T1M0-MD02 MP3000	1,2	0,085	0,085	0,085	0,085	0,13
		0,048	0,0034	0,0034	0,0034	0,0034	0,0050
P6	RDHW06T1M0-MD02 MP3000	1,2	0,085	0,085	0,085	0,085	0,13
		0,048	0,0034	0,0034	0,0034	0,0034	0,0050
P7	RDHW06T1M0-MD02 MP3000	1,2	0,085	0,085	0,085	0,085	0,13
		0,048	0,0034	0,0034	0,0034	0,0034	0,0050
P8	RDHW06T1M0-MD02 MP3000	1,2	0,090	0,090	0,090	0,090	0,14
		0,048	0,0036	0,0036	0,0036	0,0036	0,0055
P11	RDHW06T1M0-MD02 MP3000	1,2	0,085	0,085	0,085	0,085	0,13
		0,048	0,0034	0,0034	0,0034	0,0034	0,0050
P12	RDHW06T1M0-MD02 MP3000	0,95	0,065	0,065	0,065	0,065	0,090
		0,038	0,0026	0,0026	0,0026	0,0026	0,0036
M1	RDHT06T1M0-E02 F40M	1,2	0,065	0,065	0,065	0,065	0,095
		0,048	0,0026	0,0026	0,0026	0,0026	0,0038
M2	RDHT06T1M0-E02 F40M	1,2	0,060	0,060	0,060	0,055	0,085
		0,048	0,0024	0,0024	0,0024	0,0022	0,0034
M3	RDHT06T1M0-E02 F40M	0,95	0,050	0,050	0,050	0,050	0,070
		0,038	0,0020	0,0020	0,0020	0,0020	0,0028
M4	RDHW06T1M0-MD02 MP3000	0,70	0,080	0,080	0,080	0,075	0,090
		0,028	0,0032	0,0032	0,0032	0,0030	0,0036
M5	RDHW06T1M0-MD02 MP3000	0,70	0,080	0,080	0,080	0,075	0,090
		0,028	0,0032	0,0032	0,0032	0,0030	0,0036
K1	RDHW06T1M0-MD02 MK2050	1,2	0,095	0,095	0,095	0,095	0,14
		0,048	0,0038	0,0038	0,0038	0,0038	0,0055
K2	RDHW06T1M0-MD02 MK2050	1,2	0,085	0,085	0,085	0,085	0,13
		0,048	0,0034	0,0034	0,0034	0,0034	0,0050
K3	RDHW06T1M0-MD02 MK2050	1,2	0,085	0,085	0,085	0,085	0,13
		0,048	0,0034	0,0034	0,0034	0,0034	0,0050
K4	RDHW06T1M0-MD02 MK2050	1,2	0,085	0,085	0,085	0,085	0,13
		0,048	0,0034	0,0034	0,0034	0,0034	0,0050
K5	RDHW06T1M0-MD02 MK2050	1,2	0,080	0,080	0,080	0,075	0,12
		0,048	0,0032	0,0032	0,0032	0,0030	0,0048
K6	RDHW06T1M0-MD02 MK2050	1,2	0,085	0,085	0,085	0,085	0,13
		0,048	0,0034	0,0034	0,0034	0,0034	0,0050
K7	RDHW06T1M0-MD02 MK2050	1,2	0,080	0,080	0,080	0,075	0,12
		0,048	0,0032	0,0032	0,0032	0,0030	0,0048
N1	RDHT06T1M0-E02 H25	1,2	0,080	0,080	0,080	0,080	0,12
		0,048	0,0032	0,0032	0,0032	0,0032	0,0048
N2	RDHT06T1M0-E02 H25	1,2	0,080	0,080	0,080	0,080	0,12
		0,048	0,0032	0,0032	0,0032	0,0032	0,0048
N3	RDHT06T1M0-E02 H25	1,2	0,080	0,080	0,080	0,080	0,12
		0,048	0,0032	0,0032	0,0032	0,0032	0,0048
N11	RDHT06T1M0-E02 H25	1,2	0,080	0,080	0,080	0,080	0,12
		0,048	0,0032	0,0032	0,0032	0,0032	0,0048
S1	RDHW06T1M0-MD02 F40M	0,70	0,080	0,080	0,080	0,075	0,090
		0,028	0,0032	0,0032	0,0032	0,0030	0,0036
S2	RDHW06T1M0-MD02 F40M	0,70	0,080	0,080	0,080	0,075	0,090
		0,028	0,0032	0,0032	0,0032	0,0030	0,0036
S3	RDHW06T1M0-MD02 MP3000	0,70	0,075	0,075	0,075	0,070	0,085
		0,028	0,0030	0,0030	0,0030	0,0028	0,0034
S11	RDHW06T1M0-MD02 F40M	0,85	0,085	0,085	0,085	0,085	0,10
		0,034	0,0034	0,0034	0,0034	0,0034	0,0040
S12	RDHW06T1M0-MD02 F40M	0,85	0,085	0,085	0,085	0,085	0,10
		0,034	0,0034	0,0034	0,0034	0,0034	0,0040
S13	RDHW06T1M0-MD02 F40M	0,70	0,080	0,080	0,080	0,075	0,090
		0,028	0,0032	0,0032	0,0032	0,0030	0,0036
H5	RDHW06T1M0-MD02 F15M	0,95	0,065	0,065	0,065	0,065	0,090
		0,038	0,0026	0,0026	0,0026	0,0026	0,0036
H8	RDHW06T1M0-MD02 F15M	0,85	0,055	0,055	0,055	0,055	0,070
		0,034	0,0022	0,0022	0,0022	0,0022	0,0028
H11	RDHW06T1M0-MD02 F15M	0,95	0,065	0,065	0,065	0,065	0,090
		0,038	0,0026	0,0026	0,0026	0,0026	0,0036
H12	RDHW06T1M0-MD02 F40M	0,85	0,055	0,055	0,055	0,055	0,070
		0,034	0,0022	0,0022	0,0022	0,0022	0,0028
H21	RDHW06T1M0-MD02 F15M	0,85	0,055	0,055	0,055	0,055	0,070
		0,034	0,0022	0,0022	0,0022	0,0022	0,0028

SMG = Seco material group
 f_z = mm/tooth (in/tooth), v_c = m/min (sf/min), a_p/DC = %
 All cutting data are start values

Square shoulder and slot milling cutters
 Helical milling cutters
 Face milling cutters
 Disc milling cutters
 High feed milling cutters
 Copy milling cutters
 Plunge milling cutters
 Chamfer milling cutters
 Spot facing cutters
 Inserts

R217/220.29-03 – Cutting data $v_c = (m/min)/(sf/min)$

SMG	MP3000				F15M				F30M				F40M				MK2050				H25							
	100%	70%	30%	10%	100%	70%	30%	10%	100%	70%	30%	10%	100%	70%	30%	10%	100%	70%	30%	10%	100%	70%	30%	10%				
P1	345	395	465	550	—	—	—	—	290	330	390	460	275	315	375	440	360	410	485	570	—	—	—	—	—	—	—	—
	1125	1300	1525	1800	—	—	—	—	950	1075	1275	1500	900	1025	1225	1450	1175	1350	1600	1875	—	—	—	—	—	—	—	—
P2	335	385	455	530	—	—	—	—	285	320	380	450	270	305	365	430	350	400	470	560	—	—	—	—	—	—	—	—
	1100	1275	1500	1750	—	—	—	—	940	1050	1250	1475	890	1000	1200	1400	1150	1300	1550	1825	—	—	—	—	—	—	—	—
P3	295	335	395	460	—	—	—	—	245	280	330	385	235	265	315	370	305	345	410	480	—	—	—	—	—	—	—	—
	970	1100	1300	1500	—	—	—	—	800	920	1075	1275	770	870	1025	1225	1000	1125	1350	1575	—	—	—	—	—	—	—	—
P4	260	295	345	410	—	—	—	—	215	245	290	345	205	235	280	330	270	305	360	425	—	—	—	—	—	—	—	—
	850	970	1125	1350	—	—	—	—	710	800	950	1125	670	770	920	1075	890	1000	1175	1400	—	—	—	—	—	—	—	—
P5	250	285	335	390	—	—	—	—	210	240	280	330	200	225	270	315	260	295	350	405	—	—	—	—	—	—	—	—
	820	940	1100	1275	—	—	—	—	690	790	920	1075	660	740	890	1025	850	970	1150	1325	—	—	—	—	—	—	—	—
P6	280	320	375	440	—	—	—	—	235	265	315	370	225	255	300	350	290	330	390	455	—	—	—	—	—	—	—	—
	920	1050	1225	1450	—	—	—	—	770	870	1025	1225	740	840	980	1150	950	1075	1275	1500	—	—	—	—	—	—	—	—
P7	265	300	355	415	—	—	—	—	220	250	300	350	210	240	285	330	275	310	370	430	—	—	—	—	—	—	—	—
	870	980	1175	1350	—	—	—	—	720	820	980	1150	690	790	940	1075	900	1025	1225	1400	—	—	—	—	—	—	—	—
P8	245	280	330	385	—	—	—	—	205	235	280	325	195	225	265	310	255	290	345	400	—	—	—	—	—	—	—	—
	800	920	1075	1275	—	—	—	—	670	770	920	1075	640	740	870	1025	840	950	1125	1300	—	—	—	—	—	—	—	—
P11	255	290	345	405	—	—	—	—	215	245	290	340	205	235	275	325	265	305	360	420	—	—	—	—	—	—	—	—
	840	950	1125	1325	—	—	—	—	710	800	950	1125	670	770	900	1075	870	1000	1175	1375	—	—	—	—	—	—	—	—
P12	160	185	215	250	—	—	—	—	135	155	180	210	130	145	170	200	165	190	225	260	—	—	—	—	—	—	—	—
	520	610	710	820	—	—	—	—	445	510	590	690	425	475	560	660	540	620	740	850	—	—	—	—	—	—	—	—
M1	250	285	340	400	—	—	—	—	230	260	305	360	215	245	295	345	—	—	—	—	—	—	—	—	—	—	—	—
	820	940	1125	1300	—	—	—	—	750	850	1000	1175	710	800	970	1125	—	—	—	—	—	—	—	—	—	—	—	—
M2	210	235	280	325	—	—	—	—	190	215	255	295	180	205	240	280	—	—	—	—	—	—	—	—	—	—	—	—
	690	770	920	1075	—	—	—	—	620	710	840	970	590	670	790	920	—	—	—	—	—	—	—	—	—	—	—	—
M3	165	185	220	255	—	—	—	—	150	170	200	230	140	160	190	220	—	—	—	—	—	—	—	—	—	—	—	—
	540	610	720	840	—	—	—	—	490	560	660	750	460	520	620	720	—	—	—	—	—	—	—	—	—	—	—	—
M4	125	140	170	195	—	—	—	—	115	130	150	180	110	120	145	170	—	—	—	—	—	—	—	—	—	—	—	—
	410	460	560	640	—	—	—	—	375	425	490	590	360	395	475	560	—	—	—	—	—	—	—	—	—	—	—	—
M5	105	120	140	165	—	—	—	—	95	105	125	150	90	100	120	140	—	—	—	—	—	—	—	—	—	—	—	—
	345	395	460	540	—	—	—	—	310	345	410	490	295	330	395	460	—	—	—	—	—	—	—	—	—	—	—	—
K1	265	305	360	425	255	290	345	405	225	255	300	355	215	245	290	340	380	430	510	600	—	—	—	—	—	—	—	—
	870	1000	1175	1400	840	950	1125	1325	740	840	980	1175	710	800	950	1125	1250	1400	1675	1975	—	—	—	—	—	—	—	—
K2	235	270	320	370	225	260	305	355	200	225	265	310	190	215	255	295	335	380	450	530	—	—	—	—	—	—	—	—
	770	890	1050	1225	740	850	1000	1175	660	740	870	1025	620	710	840	970	1100	1250	1475	1750	—	—	—	—	—	—	—	—
K3	200	230	270	315	190	220	260	300	170	190	225	265	160	180	215	250	285	320	380	445	—	—	—	—	—	—	—	—
	660	750	890	1025	620	720	850	980	560	620	740	870	520	590	710	820	940	1050	1250	1450	—	—	—	—	—	—	—	—
K4	190	215	255	300	185	210	245	290	160	185	215	250	155	175	205	240	270	310	365	425	—	—	—	—	—	—	—	—
	620	710	840	980	610	690	800	950	520	610	710	820	510	570	670	790	890	1025	1200	1400	—	—	—	—	—	—	—	—
K5	115	130	155	180	110	125	150	175	95	110	130	150	90	105	125	145	165	185	220	255	—	—	—	—	—	—	—	—
	375	425	510	590	360	410	490	570	310	360	425	490	295	345	410	475	540	610	720	840	—	—	—	—	—	—	—	—
K6	170	190	225	265	160	185	215	255	140	160	190	220	135	155	180	210	240	270	320	375	—	—	—	—	—	—	—	—
	560	620	740	870	520	610	710	840	460	520	620	720	445	510	590	690	790	890	1050	1225	—	—	—	—	—	—	—	—
K7	145	165	195	230	140	160	190	225	125	140	165	195	120	135	160	185	210	235	280	330	—	—	—	—	—	—	—	—
	475	540	640	750	460	520	620	740	410	460	540	640	395	445	520	610	690	770	920	1075	—	—	—	—	—	—	—	—
N1	2025	2300	2725	3200	—	—	—	—	1700	1925	2275	2675	1625	1825	2175	2550	—	—	—	—	1875	2150	2525	2975	—	—	—	—
	6650	7550	8950	10500	—	—	—	—	5575	6325	7475	8775	5325	6000	7125	8375	—	—	—	—	6150	7050	8275	9750	—	—	—	—
N2	810	930	1100	1300	—	—	—	—	680	780	920	1075	650	740	880	1025	—	—	—	—	760	870	1025	1200	—	—	—	—
	2650	3050	3600	4275	—	—	—	—	2225	2550	3025	3525	2125	2425	2875	3375	—	—	—	—	2500	2850	3375	3925	—	—	—	—
N3	540	620	730	860	—	—	—	—	455	520	620	720	435	495	590	690	—	—	—	—	510	580	680	800	—	—	—	—
	1775	2025	2400	2825	—	—	—	—	1500	1700	2025	2350	1425	1625	1925	2275	—	—	—	—	1675	1900	2225	2625	—	—	—	—
N11	620	710	840	980	—	—	—	—	520	590	700	830	495	560	670	790	—	—	—	—	580	660	780	910	—	—	—	—
	2025	2325	2750	3225	—	—	—	—	1700	1925	2300	2725	1625	1825	2200	2600	—	—	—	—	1900	2175	2550	2975	—	—	—	—
S1	60	65	80	90	—	—	—	—	55	60	70	85	50	55	65	80	—	—	—	—	—	—	—	—	—	—	—	—
	195																											

R217.29-035 – Metric

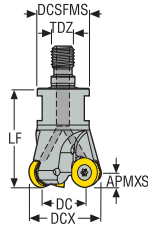



- For insert selection and cutting data recommendations, see page(s) [XXX]-[XXX]
- For complete insert programme, see page(s) [XXX]
- For ISO attribute explanation, see page 16



Designation	Item number	Type of mounting	DC	DCX	ZEFP	APMXS	TDZ	DCSFMS	LF	RMPX°	Cmin	Cmax	RPMX	Weight	Insert
			mm	mm		mm		mm	mm		mm	mm		kg	
R217.29-0816.RE-035.3A	02643410	Combimaster	9,0	16,0	3	3,5	M8	13,5	20,0	17,8	25,0	30,0	48000	0,1	RDH.0702
R217.29-1020.RE-035.4A	02495678	Combimaster	13,0	20,0	4	3,5	M10	18,5	23,0	10,4	33,0	38,0	44000	0,1	RDH.0702
R217.29-1225.RE-035.5A	02643411	Combimaster	18,0	25,0	5	3,5	M12	23,0	28,0	6,9	43,0	48,0	35000	0,1	RDH.0702

For Combimaster Shanks, see Machining Navigator Tooling System

Spare Parts, included in delivery

For cutter	Insert key	Insert screw
		
R217.29-..	H4B-T07P	C02545-T07P

Accessories

For cutter	Insert clamping torque	Torque key
		
R217.29-..	0.9NM	T00-07P09

Torque and fixed keys, see page [XXX]

Square shoulder and slot milling cutters

Helical milling cutters

Face milling cutters

Disc milling cutters

High feed milling cutters

Copy milling cutters

Plunge milling cutters

Chamfer milling cutters

Spot facing cutters

Inserts

R217.29-035 – Insert selection – mm/Inch

SMG		a _p	f _z			
			100%	70%	30%	10%
P1	RDHW0702M0-MD03 F40M	1,4	0,13	0,13	0,13	0,19
		0,055	0,0050	0,0050	0,0050	0,0075
P2	RDHW0702M0-MD03 F40M	1,4	0,13	0,13	0,13	0,19
		0,055	0,0050	0,0050	0,0050	0,0075
P3	RDHW0702M0-MD03 F40M	1,4	0,12	0,12	0,12	0,18
		0,055	0,0048	0,0048	0,0048	0,0070
P4	RDHW0702M0-MD03 MP3000	1,4	0,12	0,12	0,12	0,18
		0,055	0,0048	0,0048	0,0048	0,0070
P5	RDHW0702M0-MD03 MP3000	1,4	0,12	0,12	0,12	0,17
		0,055	0,0048	0,0048	0,0048	0,0065
P6	RDHW0702M0-MD03 MP3000	1,4	0,11	0,11	0,12	0,17
		0,055	0,0044	0,0044	0,0048	0,0065
P7	RDHW0702M0-MD03 MP3000	1,4	0,11	0,11	0,12	0,17
		0,055	0,0044	0,0044	0,0048	0,0065
P8	RDHW0702M0-MD03 MP3000	1,4	0,12	0,12	0,12	0,18
		0,055	0,0048	0,0048	0,0048	0,0070
P11	RDHW0702M0-MD03 MP3000	1,4	0,11	0,11	0,12	0,17
		0,055	0,0044	0,0044	0,0048	0,0065
P12	RDHW0702M0-MD03 MP3000	1,1	0,090	0,090	0,085	0,12
		0,044	0,0036	0,0036	0,0034	0,0048
M1	RDHW0702M0-MD03 F40M	1,4	0,13	0,13	0,13	0,19
		0,055	0,0050	0,0050	0,0050	0,0075
M2	RDHW0702M0-MD03 F40M	1,4	0,12	0,12	0,12	0,17
		0,055	0,0048	0,0048	0,0048	0,0065
M3	RDHW0702M0-MD03 F40M	1,1	0,10	0,10	0,10	0,14
		0,044	0,0040	0,0040	0,0040	0,0055
M4	RDHW0702M0-MD03 F40M	0,85	0,10	0,10	0,10	0,12
		0,034	0,0040	0,0040	0,0040	0,0048
M5	RDHW0702M0-MD03 F40M	0,85	0,10	0,10	0,10	0,12
		0,034	0,0040	0,0040	0,0040	0,0048
S1	RDHW0702M0-MD03 F40M	0,85	0,10	0,10	0,10	0,12
		0,034	0,0040	0,0040	0,0040	0,0048
S2	RDHW0702M0-MD03 F40M	0,85	0,10	0,10	0,10	0,12
		0,034	0,0040	0,0040	0,0040	0,0048
S3	RDHW0702M0-MD03 F40M	0,85	0,095	0,095	0,095	0,11
		0,034	0,0038	0,0038	0,0038	0,0044
S11	RDHW0702M0-MD03 F40M	1,0	0,11	0,11	0,11	0,14
		0,040	0,0044	0,0044	0,0044	0,0055
S12	RDHW0702M0-MD03 F40M	1,0	0,11	0,11	0,11	0,14
		0,040	0,0044	0,0044	0,0044	0,0055
S13	RDHW0702M0-MD03 F40M	0,85	0,10	0,10	0,10	0,12
		0,034	0,0040	0,0040	0,0040	0,0048
H5	RDHW0702M0T-MD04 F15M	1,1	0,090	0,090	0,085	0,12
		0,044	0,0036	0,0036	0,0034	0,0048
H8	RDHW0702M0T-MD04 F15M	1,0	0,070	0,070	0,070	0,090
		0,040	0,0028	0,0028	0,0028	0,0036
H11	RDHW0702M0T-MD04 F15M	1,1	0,090	0,090	0,085	0,12
		0,044	0,0036	0,0036	0,0034	0,0048
H12	RDHW0702M0T-MD04 F15M	1,0	0,070	0,070	0,070	0,090
		0,040	0,0028	0,0028	0,0028	0,0036
H21	RDHW0702M0T-MD04 F15M	1,0	0,070	0,070	0,070	0,090
		0,040	0,0028	0,0028	0,0028	0,0036

SMG = Seco material group
 f_z = mm/tooth (in/tooth), v_c = m/min (sf/min), a_p/DC = %
 All cutting data are start values

R217/220.29-035 – Cutting data $v_c = (m/min)/(sf/min)$

SMG	MP3000				F15M				F40M			
	100%	70%	30%	10%	100%	70%	30%	10%	100%	70%	30%	10%
P1	335	400	470	550	—	—	—	—	270	320	375	435
	1100	1300	1550	1800	—	—	—	—	890	1050	1225	1425
P2	330	385	455	530	—	—	—	—	260	310	365	425
	1075	1275	1500	1750	—	—	—	—	850	1025	1200	1400
P3	285	340	400	460	—	—	—	—	230	270	320	370
	940	1125	1300	1500	—	—	—	—	750	890	1050	1225
P4	250	300	350	405	—	—	—	—	200	240	280	325
	820	980	1150	1325	—	—	—	—	660	790	920	1075
P5	240	285	335	390	—	—	—	—	195	230	270	315
	790	940	1100	1275	—	—	—	—	640	750	890	1025
P6	275	325	375	440	—	—	—	—	220	260	300	350
	900	1075	1225	1450	—	—	—	—	720	850	980	1150
P7	260	305	355	415	—	—	—	—	210	245	285	335
	850	1000	1175	1350	—	—	—	—	690	800	940	1100
P8	240	285	335	390	—	—	—	—	195	230	270	310
	790	940	1100	1275	—	—	—	—	640	750	890	1025
P11	255	300	345	405	—	—	—	—	200	240	275	325
	840	980	1125	1325	—	—	—	—	660	790	900	1075
P12	160	185	220	255	—	—	—	—	125	150	175	200
	520	610	720	840	—	—	—	—	410	490	570	660
M1	245	290	340	395	—	—	—	—	210	250	295	340
	800	950	1125	1300	—	—	—	—	690	820	970	1125
M2	200	240	280	330	—	—	—	—	175	205	240	285
	660	790	920	1075	—	—	—	—	570	670	790	940
M3	165	190	225	260	—	—	—	—	140	165	195	225
	540	620	740	850	—	—	—	—	460	540	640	740
M4	125	145	170	200	—	—	—	—	110	125	145	170
	410	475	560	660	—	—	—	—	360	410	475	560
M5	105	120	140	165	—	—	—	—	90	105	125	145
	345	395	460	540	—	—	—	—	295	345	410	475
K1	260	305	360	420	250	295	350	405	210	245	290	335
	850	1000	1175	1375	820	970	1150	1325	690	800	950	1100
K2	230	270	320	370	220	260	305	360	185	215	255	300
	750	890	1050	1225	720	850	1000	1175	610	710	840	980
K3	195	230	270	315	185	220	260	305	155	185	215	250
	640	750	890	1025	610	720	850	1000	510	610	710	820
K4	185	220	260	300	175	210	245	290	150	175	205	240
	610	720	850	980	570	690	800	950	490	570	670	790
K5	115	135	155	180	110	130	150	175	90	110	125	145
	375	445	510	590	360	425	490	570	295	360	410	475
K6	165	195	225	265	155	185	220	255	130	155	180	210
	540	640	740	870	510	610	720	840	425	510	590	690
K7	145	175	200	230	140	165	190	225	115	140	160	185
	475	570	660	750	460	540	620	740	375	460	520	610
S1	60	70	80	95	—	—	—	—	50	60	70	80
	195	230	260	310	—	—	—	—	165	195	230	260
S2	47	55	65	75	—	—	—	—	40	47	55	65
	155	180	215	245	—	—	—	—	130	155	180	215
S3	41	48	55	65	—	—	—	—	35	41	48	55
	135	155	180	215	—	—	—	—	115	135	155	180
S11	80	95	110	130	—	—	—	—	70	85	95	115
	260	310	360	425	—	—	—	—	230	280	310	375
S12	55	65	80	90	—	—	—	—	49	55	65	80
	180	215	260	295	—	—	—	—	160	180	215	260
S13	33	38	45	50	—	—	—	—	28	33	39	45
	110	125	150	165	—	—	—	—	90	110	130	150
H5	49	60	70	80	50	60	70	80	42	49	60	65
	160	195	230	260	165	195	230	260	140	160	195	215
H8	50	60	70	80	55	60	75	85	44	50	60	70
	165	195	230	260	180	195	245	280	145	165	195	230
H11	65	75	85	100	65	75	90	105	55	65	75	85
	215	245	280	330	215	245	295	345	180	215	245	280
H12	100	115	135	155	95	110	130	150	80	95	110	125
	330	375	445	510	310	360	425	490	260	310	360	410
H21	50	60	70	80	55	60	75	85	44	50	60	70
	165	195	230	260	180	195	245	280	145	165	195	230

Square shoulder and slot milling cutters
Helical milling cutters
Face milling cutters
Disc milling cutters
High feed milling cutters
Copy milling cutters
Plunge milling cutters
Chamfer milling cutters
Spot facing cutters
Inserts

R217.29-04 – Metric

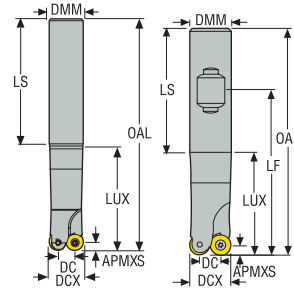

- For insert selection and cutting data recommendations, see page(s) 628-630
- For complete insert programme, see page(s) 839
- For ISO attribute explanation, see page 16

Designation	Item number	Type of mounting	DC	DCX	ZEPF	APMXS	DMM	LS	OAL	LUX	RMPX*	Cmin	Cmax	RPMX	Weight	Insert
			mm	mm		mm	mm	mm	mm	mm		mm	mm		kg	
R217.29-1616.0-04.2.050	00040299	Cylindrical	8,0	16,0	2	4,0	16,0	60,0	110,0	50,0	90,0	24,0	30,0	36200	0,2	RD..0803
R217.29-1616.0-04.2.100E	00040300	Cylindrical	8,0	16,0	2	4,0	16,0	95,0	160,0	100,0	90,0	24,0	30,0	36200	0,5	RD..0803
R217.29-1616.3-04.2.040	00040302	Weldon	8,0	16,0	2	4,0	16,0	48,0	88,0	38,0	90,0	24,0	30,0	36200	0,2	RD..0803

Spare Parts, included in delivery

For cutter	Insert key	Insert screw
R217.69-..Ø16	H4B-T08P	C02505-T08P

Accessories

For cutter	Insert clamping torque	Torque key
R217.29-..	1.2NM	T00-08P12

Torque and fixed keys, see page 894

R217/220.29-04 – Metric

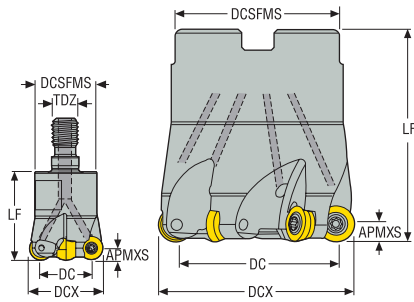

- For insert selection and cutting data recommendations, see page(s) 628-630
- For complete insert programme, see page(s) 839
- For ISO attribute explanation, see page 16

Designation	Item number	Type of mounting	DC	DCX	ZEFP	APMXS	DCB	TDZ	DCSFMS	LF	RMPX*	Cmin	Cmax	RPMX	Weight	Insert
			mm	mm		mm	mm		mm	mm		mm	mm		kg	
R217.29-0816.RE-04.2	00047266	Combimaster	8,0	16,0	2	4,0	–	M8	13,5	23,0	90,0	24,0	30,0	36200	0,1	RD..0803
R217.29-1020.RE-04.2A	00040294	Combimaster	12,0	20,0	2	4,0	–	M10	18,5	28,0	16,43	32,0	38,0	32400	0,1	RD..0803
R217.29-1020.RE-04.3A	00040062	Combimaster	12,0	20,0	3	4,0	–	M10	18,5	28,0	16,43	32,0	38,0	32400	0,1	RD..0803
R217.29-1225.RE-04.3A	02410817	Combimaster	17,0	25,0	3	4,0	–	M12	23,0	30,0	10,01	42,0	48,0	29000	0,2	–
R217.29-1225.RE-04.4A	00040297	Combimaster	17,0	25,0	4	4,0	–	M12	23,0	30,0	10,01	42,0	48,0	29000	0,2	RD..0803
R217.29-1632.RE-04.5A	02410823	Combimaster	24,0	32,0	5	4,0	–	M16	30,0	40,0	6,51	56,0	62,0	26100	0,3	RD..0803
R217.29-1640.RE-04.6A	00040303	Combimaster	32,0	40,0	6	4,0	–	M16	30,0	40,0	4,66	72,0	78,0	23300	0,3	RD..0803
R220.29-0050-04.5A	02410828	Arbor	42,0	50,0	5	4,0	22,0	–	42,0	40,0	3,44	92,0	98,0	17300	0,4	RD..0803
R220.29-0050-04.7A	02410829	Arbor	42,0	50,0	7	4,0	22,0	–	42,0	40,0	3,44	92,0	98,0	17300	0,4	RD..0803

For Combimaster Shanks, see Machining Navigator Tooling System

Spare Parts, included in delivery

For cutter	Arbor screw	Insert key	Insert screw
R217.69-..Ø16	–	H4B-T08P	C02506-T08P
R217.29-..Ø20-40	–	H4B-T08P	C02506-T08P
R220.29-..0050	220.17-692	H4B-T08P	C02506-T08P

Accessories

For cutter	Insert clamping torque	Torque key
R217/220.29-..	1.2NM	T00-08P12

Torque and fixed keys, see page 894

Square shoulder and slot milling cutters
Helical milling cutters
Face milling cutters
Disc milling cutters
High feed milling cutters
Copy milling cutters
Plunge milling cutters
Chamfer milling cutters
Spot facing cutters
Inserts

R217/220.29-04 – Insert selection – mm/Inch

SMG		a _p	f _z			
			100%	70%	30%	10%
P1	RDKW0803M0T-MD05 MP2501	1,6	0,16	0,16	0,16	0,22
		0,065	0,0065	0,0065	0,0065	0,0085
P2	RDKW0803M0T-MD05 MP2501	1,6	0,16	0,16	0,16	0,22
		0,065	0,0065	0,0065	0,0065	0,0085
P3	RDKW0803M0T-MD05 MP2501	1,6	0,15	0,15	0,15	0,22
		0,065	0,0060	0,0060	0,0060	0,0085
P4	RDKW0803M0T-MD05 MP2501	1,6	0,15	0,15	0,15	0,22
		0,065	0,0060	0,0060	0,0060	0,0085
P5	RDKW0803M0T-MD05 MP2501	1,6	0,15	0,15	0,15	0,20
		0,065	0,0060	0,0060	0,0060	0,0080
P6	RDKW0803M0T-MD05 MS2500	1,6	0,14	0,14	0,15	0,20
		0,065	0,0055	0,0055	0,0060	0,0080
P7	RDKW0803M0T-MD05 MS2500	1,6	0,14	0,14	0,15	0,20
		0,065	0,0055	0,0055	0,0060	0,0080
P8	RDKW0803M0T-MD05 MS2500	1,6	0,15	0,15	0,15	0,22
		0,065	0,0060	0,0060	0,0060	0,0085
P11	RDKW0803M0T-MD05 MS2500	1,6	0,14	0,14	0,15	0,20
		0,065	0,0055	0,0055	0,0060	0,0080
P12	RDKW0803M0T-MD05 MS2500	1,3	0,11	0,11	0,11	0,14
		0,050	0,0044	0,0044	0,0044	0,0055
M1	RDHW0803M0-MD03 F40M	1,6	0,13	0,13	0,13	0,18
		0,065	0,0050	0,0050	0,0050	0,0070
M2	RDHW0803M0-MD03 F40M	1,6	0,12	0,12	0,12	0,17
		0,065	0,0048	0,0048	0,0048	0,0065
M3	RDHW0803M0-MD03 F40M	1,3	0,10	0,10	0,10	0,13
		0,050	0,0040	0,0040	0,0040	0,0050
M4	RDHW0803M0-MD03 F40M	0,95	0,11	0,11	0,10	0,12
		0,038	0,0044	0,0044	0,0040	0,0048
M5	RDHW0803M0-MD03 F40M	0,95	0,11	0,11	0,10	0,12
		0,038	0,0044	0,0044	0,0040	0,0048
K1	RDKW0803M0T-MD05 MK2050	1,6	0,16	0,16	0,16	0,22
		0,065	0,0065	0,0065	0,0065	0,0085
K2	RDKW0803M0T-MD05 MK2050	1,6	0,15	0,15	0,15	0,20
		0,065	0,0060	0,0060	0,0060	0,0080
K3	RDKW0803M0T-MD05 MK2050	1,6	0,15	0,15	0,15	0,20
		0,065	0,0060	0,0060	0,0060	0,0080
K4	RDKW0803M0T-MD05 MK2050	1,6	0,15	0,15	0,15	0,20
		0,065	0,0060	0,0060	0,0060	0,0080
K5	RDKW0803M0T-MD05 MK2050	1,6	0,13	0,13	0,13	0,19
		0,065	0,0050	0,0050	0,0050	0,0075
K6	RDKW0803M0T-MD05 MK2050	1,6	0,15	0,15	0,15	0,20
		0,065	0,0060	0,0060	0,0060	0,0080
K7	RDKW0803M0T-MD05 MK2050	1,6	0,13	0,13	0,13	0,19
		0,065	0,0050	0,0050	0,0050	0,0075
N1	RDHT0803M0-E03 H25	1,6	0,12	0,12	0,12	0,17
		0,065	0,0048	0,0048	0,0048	0,0065
N2	RDHT0803M0-E03 H25	1,6	0,12	0,12	0,12	0,17
		0,065	0,0048	0,0048	0,0048	0,0065
N3	RDHT0803M0-E03 H25	1,6	0,12	0,12	0,12	0,17
		0,065	0,0048	0,0048	0,0048	0,0065
N11	RDHT0803M0-E03 H25	1,6	0,12	0,12	0,12	0,17
		0,065	0,0048	0,0048	0,0048	0,0065
S1	RDHW0803M0-MD03 F40M	0,95	0,11	0,11	0,10	0,12
		0,038	0,0044	0,0044	0,0040	0,0048
S2	RDHW0803M0-MD03 F40M	0,95	0,10	0,10	0,095	0,11
		0,038	0,0040	0,0040	0,0038	0,0044
S3	RDHW0803M0-MD03 F40M	1,1	0,11	0,11	0,11	0,13
		0,044	0,0044	0,0044	0,0044	0,0050
S11	RDHW0803M0-MD03 MS2050	1,1	0,11	0,11	0,11	0,13
		0,044	0,0044	0,0044	0,0044	0,0050
S12	RDHW0803M0-MD03 MS2050	0,95	0,11	0,11	0,10	0,12
		0,038	0,0044	0,0044	0,0040	0,0048
S13	RDHW0803M0-MD03 MS2050	1,3	0,11	0,11	0,11	0,14
		0,050	0,0044	0,0044	0,0044	0,0055
H5	RDKW0803M0T-MD05 F15M	1,1	0,090	0,090	0,090	0,11
		0,044	0,0036	0,0036	0,0036	0,0044
H8	RDKW0803M0T-MD05 F15M	1,3	0,11	0,11	0,11	0,14
		0,050	0,0044	0,0044	0,0044	0,0055
H11	RDKW0803M0T-MD05 F15M	1,1	0,090	0,090	0,090	0,11
		0,044	0,0036	0,0036	0,0036	0,0044
H12	RDKW0803M0T-MD05 F15M	1,1	0,090	0,090	0,090	0,11
		0,044	0,0036	0,0036	0,0036	0,0044
H21	RDKW0803M0T-MD05 F15M	1,1	0,090	0,090	0,090	0,11
		0,044	0,0036	0,0036	0,0036	0,0044

SMG = Seco material group
 f_z = mm/tooth (in/tooth), v_c = m/min (sf/min), a_p/DC = %
 All cutting data are start values

R217/220.29-04 – Cutting data v_c = (m/min)/(sf/min)

SMG	MP2501				MP3000				T350M				F15M				F25M			
	100%	70%	30%	10%	100%	70%	30%	10%	100%	70%	30%	10%	100%	70%	30%	10%	100%	70%	30%	10%
P1	330	375	450	530	330	370	445	520	370	420	500	590	—	—	—	—	275	310	375	440
	1075	1225	1475	1750	1075	1225	1450	1700	1225	1375	1650	1925	—	—	—	—	900	1025	1225	1450
P2	325	365	435	520	320	360	435	510	360	410	480	560	—	—	—	—	270	305	365	430
	1075	1200	1425	1700	1050	1175	1425	1675	1175	1350	1575	1825	—	—	—	—	890	1000	1200	1400
P3	280	320	380	445	280	315	380	445	315	355	420	490	—	—	—	—	235	265	320	370
	920	1050	1250	1450	920	1025	1250	1450	1025	1175	1375	1600	—	—	—	—	770	870	1050	1225
P4	250	280	335	390	245	280	335	390	275	315	370	435	—	—	—	—	205	235	280	325
	820	920	1100	1275	800	920	1100	1275	900	1025	1225	1425	—	—	—	—	670	770	920	1075
P5	235	265	320	380	235	265	320	375	265	300	355	420	—	—	—	—	195	225	265	320
	770	870	1050	1250	770	870	1050	1225	870	980	1175	1375	—	—	—	—	640	740	870	1050
P6	270	305	360	430	265	300	355	425	300	340	400	470	—	—	—	—	225	255	300	355
	890	1000	1175	1400	870	980	1175	1400	980	1125	1300	1550	—	—	—	—	740	840	980	1175
P7	255	290	340	405	250	280	335	400	280	320	375	445	—	—	—	—	215	240	285	335
	840	950	1125	1325	820	920	1100	1300	920	1050	1225	1450	—	—	—	—	710	790	940	1100
P8	235	265	320	375	235	265	320	375	265	300	355	415	—	—	—	—	195	225	265	310
	770	870	1050	1225	770	870	1050	1225	870	980	1175	1350	—	—	—	—	640	740	870	1025
P11	250	280	330	390	245	275	325	390	275	310	365	430	—	—	—	—	205	235	275	325
	820	920	1075	1275	800	900	1075	1275	900	1025	1200	1400	—	—	—	—	670	770	900	1075
P12	155	175	210	250	155	175	210	245	170	195	230	270	—	—	—	—	130	150	175	205
	510	570	690	820	510	570	690	800	560	640	750	890	—	—	—	—	425	490	570	670
M1	235	260	315	370	240	270	325	380	280	315	370	435	—	—	—	—	—	—	—	—
	770	850	1025	1225	790	890	1075	1250	920	1025	1225	1425	—	—	—	—	—	—	—	—
M2	190	215	260	305	195	220	265	310	230	260	305	360	—	—	—	—	—	—	—	—
	620	710	850	1000	640	720	870	1025	750	850	1000	1175	—	—	—	—	—	—	—	—
M3	155	175	205	240	160	180	210	250	180	205	240	285	—	—	—	—	—	—	—	—
	510	570	670	790	520	590	690	820	590	670	790	940	—	—	—	—	—	—	—	—
M4	120	135	155	185	120	135	160	190	140	155	185	215	—	—	—	—	—	—	—	—
	395	445	510	610	395	445	520	620	460	510	610	710	—	—	—	—	—	—	—	—
M5	100	110	130	155	100	115	135	160	115	130	155	180	—	—	—	—	—	—	—	—
	330	360	425	510	330	375	445	520	375	425	510	590	—	—	—	—	—	—	—	—
K1	255	290	345	410	255	285	345	405	—	—	—	—	230	260	315	370	215	240	290	340
	840	950	1125	1350	840	940	1125	1325	—	—	—	—	750	850	1025	1225	710	790	950	1125
K2	225	255	305	360	225	255	300	355	—	—	—	—	205	230	275	330	185	210	255	300
	740	840	1000	1175	740	840	980	1175	—	—	—	—	670	750	900	1075	610	690	840	980
K3	190	215	260	305	190	215	255	300	—	—	—	—	175	195	235	280	160	180	215	255
	620	710	850	1000	620	710	840	980	—	—	—	—	570	640	770	920	520	590	710	840
K4	180	205	245	290	180	205	245	285	—	—	—	—	165	185	225	265	150	170	205	245
	590	670	800	950	590	670	800	940	—	—	—	—	540	610	740	870	490	560	670	800
K5	110	125	150	175	110	125	150	175	—	—	—	—	100	115	135	160	95	105	125	145
	360	410	490	570	360	410	490	570	—	—	—	—	330	375	445	520	310	345	410	475
K6	160	180	215	260	160	180	215	250	—	—	—	—	145	165	195	235	135	150	180	215
	520	590	710	850	520	590	710	820	—	—	—	—	475	540	640	770	445	490	590	710
K7	145	160	195	225	145	160	190	225	—	—	—	—	130	145	175	205	120	135	160	190
	475	520	640	740	475	520	620	740	—	—	—	—	425	475	570	670	395	445	520	620
N1	—	—	—	—	1925	2150	2550	3000	—	—	—	—	—	—	—	—	—	—	—	—
	—	—	—	—	6325	7050	8375	9850	—	—	—	—	—	—	—	—	—	—	—	—
N2	—	—	—	—	770	870	1025	1225	—	—	—	—	—	—	—	—	—	—	—	—
	—	—	—	—	2525	2850	3375	4025	—	—	—	—	—	—	—	—	—	—	—	—
N3	—	—	—	—	520	580	690	810	—	—	—	—	—	—	—	—	—	—	—	—
	—	—	—	—	1700	1900	2275	2650	—	—	—	—	—	—	—	—	—	—	—	—
N11	—	—	—	—	590	670	790	930	—	—	—	—	—	—	—	—	—	—	—	—
	—	—	—	—	1925	2200	2600	3050	—	—	—	—	—	—	—	—	—	—	—	—
S1	—	—	—	—	55	65	75	90	65	75	85	100	—	—	—	—	—	—	—	—
	—	—	—	—	180	215	245	295	215	245	280	330	—	—	—	—	—	—	—	—
S2	—	—	—	—	45	50	60	70	50	60	70	80	—	—	—	—	—	—	—	—
	—	—	—	—	150	165	195	230	165	195	230	260	—	—	—	—	—	—	—	—
S3	—	—	—	—	40	45	55	60	45	50	60	70	—	—	—	—	—	—	—	—
	—	—	—	—	130	150	180	195	150	165	195	230	—	—	—	—	—	—	—	—
S11	—	—	—	—	80	90	105	125	90	105	120	145	—	—	—	—	—	—	—	—
	—	—	—	—	260	295	345	410	295	345	395	475	—	—	—	—	—	—	—	—
S12	—	—	—	—	55	60	75	85	65	70	85	100	—	—	—	—	—	—	—	—
	—	—	—	—	180	195	245	280	215	230	280	330	—	—	—	—	—	—	—	—
S13	—	—	—	—	32	36	43	50	36	41	48	55	—	—	—	—	—	—	—	—
	—	—	—	—	105	120	140	165	120	135	155	180	—	—	—	—	—	—	—	—
H5	—	—	—	—	48	55	65	75	55	65	75	90	47	55	65	75	—	—	—	—
	—	—	—	—	155	180	215	245	180	215	245	295	155	180	215	245	—	—	—	—
H8	—	—	—	—	50	55	65	80	60	65	80	90	50	55	65	80	—	—	—	—
	—	—	—	—	165	180	215	260	195	215	260	295	165	180	215	260	—	—	—	—
H11	—	—	—	—	60	70	80	95	75	80	95	115	60	70	80	95	—	—	—	—
	—	—	—	—	195	230	260	310	245	260	310	375	195	230	260	310	—	—	—	—
H12	—	—	—	—	95	110	130	150	105	120	140	165	90	100	120	140	—	—	—	—
	—	—	—	—	310	360	425	490	345	395	460	540	295	330	395	460	—	—	—	—
H21	—	—	—	—	50	55	65	80	60	65	80	90	50	55	65	80	—	—	—	—
	—	—	—	—	165	180</														

R217/220.29-04 – Cutting data $v_c = (m/min)/(sf/min)$

SMG	F40M				MK2050				MS2050				MS2500				H25			
	100%	70%	30%	10%	100%	70%	30%	10%	100%	70%	30%	10%	100%	70%	30%	10%	100%	70%	30%	10%
P1	265	295	355	420	325	370	440	520	—	—	—	—	360	410	490	580	—	—	—	—
	870	970	1175	1375	1075	1225	1450	1700	—	—	—	—	1175	1350	1600	1900	—	—	—	—
P2	255	290	345	410	320	360	430	510	—	—	—	—	350	395	475	560	—	—	—	—
	840	950	1125	1350	1050	1175	1400	1675	—	—	—	—	1150	1300	1550	1825	—	—	—	—
P3	225	255	305	355	280	315	375	440	—	—	—	—	310	345	415	485	—	—	—	—
	740	840	1000	1175	920	1025	1225	1450	—	—	—	—	1025	1125	1350	1600	—	—	—	—
P4	195	225	265	310	245	275	330	385	—	—	—	—	270	305	365	425	—	—	—	—
	640	740	870	1025	800	900	1075	1275	—	—	—	—	890	1000	1200	1400	—	—	—	—
P5	190	215	255	300	235	265	315	375	—	—	—	—	260	290	350	415	—	—	—	—
	620	710	840	980	770	870	1025	1225	—	—	—	—	850	950	1150	1350	—	—	—	—
P6	210	240	285	340	265	300	355	420	—	—	—	—	295	335	395	465	—	—	—	—
	690	790	940	1125	870	980	1175	1375	—	—	—	—	970	1100	1300	1525	—	—	—	—
P7	200	225	270	320	250	285	335	400	—	—	—	—	280	315	370	440	—	—	—	—
	660	740	890	1050	820	940	1100	1300	—	—	—	—	920	1025	1225	1450	—	—	—	—
P8	190	215	255	300	235	265	315	370	—	—	—	—	260	290	350	410	—	—	—	—
	620	710	840	980	770	870	1025	1225	—	—	—	—	850	950	1150	1350	—	—	—	—
P11	195	220	260	310	245	275	325	385	—	—	—	—	270	305	360	430	—	—	—	—
	640	720	850	1025	800	900	1075	1275	—	—	—	—	890	1000	1175	1400	—	—	—	—
P12	125	140	165	195	155	175	205	245	—	—	—	—	170	195	230	270	—	—	—	—
	410	460	540	640	510	570	670	800	—	—	—	—	560	640	750	890	—	—	—	—
M1	205	235	280	330	—	—	—	—	—	—	—	—	250	285	340	405	—	—	—	—
	670	770	920	1075	—	—	—	—	—	—	—	—	820	940	1125	1325	—	—	—	—
M2	170	190	230	270	—	—	—	—	—	—	—	—	205	235	280	335	—	—	—	—
	560	620	750	890	—	—	—	—	—	—	—	—	670	770	920	1100	—	—	—	—
M3	135	155	185	215	—	—	—	—	—	—	—	—	165	185	225	260	—	—	—	—
	445	510	610	710	—	—	—	—	—	—	—	—	540	610	740	850	—	—	—	—
M4	105	115	140	165	—	—	—	—	—	—	—	—	130	145	170	200	—	—	—	—
	345	375	460	540	—	—	—	—	—	—	—	—	425	475	560	660	—	—	—	—
M5	85	95	115	135	—	—	—	—	—	—	—	—	105	120	140	165	—	—	—	—
	280	310	375	445	—	—	—	—	—	—	—	—	345	395	460	540	—	—	—	—
K1	205	230	275	325	345	385	465	550	—	—	—	—	—	—	—	—	—	—	—	—
	670	750	900	1075	1125	1275	1525	1800	—	—	—	—	—	—	—	—	—	—	—	—
K2	180	200	240	285	300	340	410	485	—	—	—	—	—	—	—	—	—	—	—	—
	590	660	790	940	980	1125	1350	1600	—	—	—	—	—	—	—	—	—	—	—	—
K3	150	170	205	240	255	290	345	410	—	—	—	—	—	—	—	—	—	—	—	—
	490	560	670	790	840	950	1125	1350	—	—	—	—	—	—	—	—	—	—	—	—
K4	145	165	195	230	245	275	330	390	—	—	—	—	—	—	—	—	—	—	—	—
	475	540	640	750	800	900	1075	1275	—	—	—	—	—	—	—	—	—	—	—	—
K5	90	100	120	140	150	170	200	235	—	—	—	—	—	—	—	—	—	—	—	—
	295	330	395	460	490	560	660	770	—	—	—	—	—	—	—	—	—	—	—	—
K6	125	145	170	200	215	240	290	345	—	—	—	—	—	—	—	—	—	—	—	—
	410	475	560	660	710	790	950	1125	—	—	—	—	—	—	—	—	—	—	—	—
K7	115	130	150	180	190	215	260	300	—	—	—	—	—	—	—	—	—	—	—	—
	375	425	490	590	620	710	850	980	—	—	—	—	—	—	—	—	—	—	—	—
N1	1525	1725	2050	2400	—	—	—	—	—	—	—	—	—	—	—	—	1775	2025	2400	2825
	5000	5650	6725	7875	—	—	—	—	—	—	—	—	—	—	—	—	5825	6650	7875	9275
N2	620	700	830	970	—	—	—	—	—	—	—	—	—	—	—	—	720	810	970	1150
	2025	2300	2725	3175	—	—	—	—	—	—	—	—	—	—	—	—	2350	2650	3175	3775
N3	415	465	550	650	—	—	—	—	—	—	—	—	—	—	—	—	480	540	650	760
	1350	1525	1800	2125	—	—	—	—	—	—	—	—	—	—	—	—	1575	1775	2125	2500
N11	470	530	630	740	—	—	—	—	—	—	—	—	—	—	—	—	550	620	740	870
	1550	1750	2075	2425	—	—	—	—	—	—	—	—	—	—	—	—	1800	2025	2425	2850
S1	48	55	65	75	—	—	—	—	55	60	70	85	65	70	85	100	—	—	—	—
	155	180	215	245	—	—	—	—	180	195	230	280	215	230	280	330	—	—	—	—
S2	39	44	55	60	—	—	—	—	43	48	60	65	50	55	65	80	—	—	—	—
	130	145	180	195	—	—	—	—	140	155	195	215	165	180	215	260	—	—	—	—
S3	34	38	46	55	—	—	—	—	38	42	50	60	44	50	60	70	—	—	—	—
	110	125	150	180	—	—	—	—	125	140	165	195	145	165	195	230	—	—	—	—
S11	70	80	90	110	—	—	—	—	75	85	100	120	90	100	115	140	—	—	—	—
	230	260	295	360	—	—	—	—	245	280	330	395	295	330	375	460	—	—	—	—
S12	48	55	65	75	—	—	—	—	50	60	70	85	60	70	80	95	—	—	—	—
	155	180	215	245	—	—	—	—	165	195	230	280	195	230	260	310	—	—	—	—
S13	27	31	37	43	—	—	—	—	30	34	40	47	35	40	47	55	—	—	—	—
	90	100	120	140	—	—	—	—	100	110	130	155	115	130	155	180	—	—	—	—
H5	41	46	55	65	—	—	—	—	—	—	—	—	—	—	—	—	—	—	—	—
	135	150	180	215	—	—	—	—	—	—	—	—	—	—	—	—	—	—	—	—
H8	43	48	55	65	—	—	—	—	—	—	—	—	—	—	—	—	—	—	—	—
	140	155	180	215	—	—	—	—	—	—	—	—	—	—	—	—	—	—	—	—
H11	50	60	70	85	—	—	—	—	—	—	—	—	—	—	—	—	—	—	—	—
	165	195	230	280	—	—	—	—	—	—	—	—	—	—	—	—	—	—	—	—
H12	75	85	105	120	—	—	—	—	—	—	—	—	—	—	—	—	—	—	—	—
	245	280	345	395	—	—	—	—	—	—	—	—	—	—	—	—	—	—	—	—
H21	43	48	55	65	—	—	—	—	—	—	—	—	—	—	—	—	—	—	—	—
	140	155	180	215	—	—	—	—	—	—	—	—	—	—	—	—	—	—	—	—

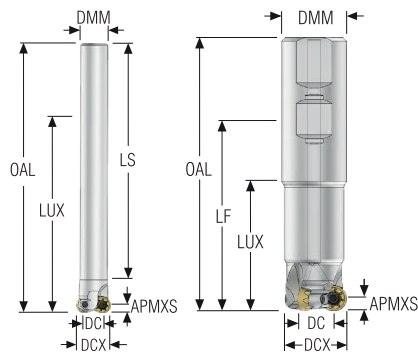

R217.29I-05 – Metric





- For insert selection and cutting data recommendations, see page(s) 636-638
- For complete insert programme, see page(s) 839
- For ISO attribute explanation, see page 16

Designation	Item number	Type of mounting	DC	DCX	ZEFP	APMXS	DMM	LS	OAL	LUX	RMPX°	Cmin	Cmax	RPMX	Weight	Insert
			mm	mm		mm	mm	mm	mm	mm		mm	mm		kg	
R217.29I-2016.0-05.1.100A	03278796	Cylindrical	5,9	16,0	1	5,0	20,0	90,0	150,0	60,0	6,9	21,8	30,0	29900	0,4	RD..10T3
R217.29I-1620.0-05.2.112E	03278795	Cylindrical	10,0	20,0	2	5,0	16,0	140,0	160,0	112,0	90,0	30,0	38,0	27400	0,5	RD..10T3
R217.29I-2025.0-05.2.120A	03278797	Cylindrical	15,0	25,0	2	5,0	20,0	140,0	170,0	120,0	14,5	40,0	48,0	24400	0,4	RD..10T3
R217.29I-2525.0-05.3.124A	03278798	Cylindrical	15,0	25,0	3	5,0	25,0	130,0	180,0	50,1	13,8	40,0	48,0	24400	0,7	RD..10T3
R217.29I-2520.3-05.2.070A	03278800	Weldon	10,0	20,0	2	5,0	25,0	55,5	125,5	70,0	90,0	30,0	38,0	27400	0,4	RD..10T3
R217.29I-2525.3-05.3.050A	03278801	Weldon	15,0	25,0	3	5,0	25,0	55,5	105,5	50,0	14,4	40,0	48,0	24400	0,4	RD..10T3
R217.29I-3232.3-05.4.060A	03278802	Weldon	22,0	32,0	4	5,0	32,0	59,5	119,5	60,0	8,7	54,0	62,0	21600	0,7	RD..10T3

Spare Parts, included in delivery

For cutter	Insert key	Insert screw
		
R217.29I-2016-2520	H4B-T09P	C03006-T09P
R217.29I-2025-3232	H4B-T09P	C03007-T09P

Accessories

For cutter	Insert clamping torque	Torque key
		
R217.29I-..	2.0NM	T00-09P20

Torque and fixed keys, see page 894

Square shoulder and slot milling cutters

Helical milling cutters

Face milling cutters

Disc milling cutters

High feed milling cutters

Copy milling cutters

Plunge milling cutters

Chamfer milling cutters

Spot facing cutters

Inserts

R217.29I-05 – inch

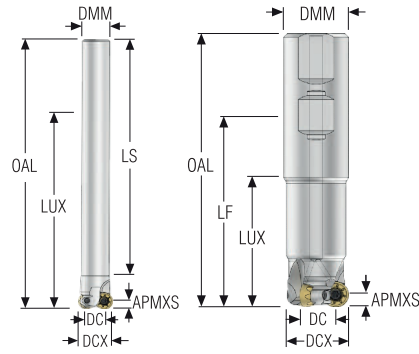

- For insert selection and cutting data recommendations, see page(s) 636-638
- For complete insert programme, see page(s) 839
- For ISO attribute explanation, see page 16

Designation	Item number	Type of mounting	DC	DCX	ZEFP	APMXS	DMM	LS	OAL	LUX	RMPX°	C min	C max	RPMX	Weight	Insert
			inch	inch		inch	inch	inch	inch	inch		inch	inch		lbs	
R217.29I-01.00-3-05.3A	03278812	Weldon	0.608	1.000	3	0.197	1.000	2.280	5.280	3.000	13,8	1.610	1.921	24400	1.100	RD..10T3

Spare Parts, included in delivery

For cutter	Insert key	Insert screw
R217.29I-..	H4B-T09P	C03007-T09P

Accessories

Insert clamping torque	Torque key
17.7IN.LBS	T00-09P20

Torque and fixed keys, see page 894

Square shoulder and slot milling cutters
Helical milling cutters
Face milling cutters
Disc milling cutters
High feed milling cutters
Copy milling cutters
Plunge milling cutters
Chamfer milling cutters
Spot facing cutters
Inserts

R217/220.29I-05 – Metric

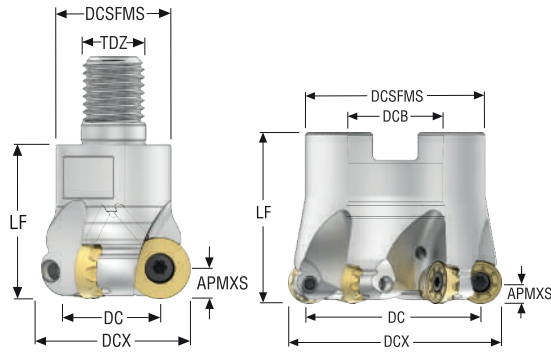



- For insert selection and cutting data recommendations, see page(s) 636-638
- For complete insert programme, see page(s) 839
- For ISO attribute explanation, see page 16

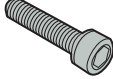

Designation	Item number	Type of mounting	DC	DCX	ZEFP	APMXS	DCB	TDZ	DCSFMS	LF	RMPX°	Cmin	Cmax	RPMX	Weight	Insert
			mm	mm		mm	mm		mm	mm		mm	mm		kg	
R217.29I-1020.RE-05.2A	03278781	Combimaster	10,0	20,0	2	5,0	–	M10	18,5	28,0	90,0	30,0	38,0	27400	0,1	RD..10T3
R217.29I-1225.RE-05.3A	03278782	Combimaster	15,0	25,0	3	5,0	–	M12	23,0	30,0	13,8	40,0	48,0	24400	0,1	RD..10T3
R217.29I-1232.RE-05.4A	03278783	Combimaster	22,0	32,0	4	5,0	–	M12	23,0	30,0	8,0	54,0	62,0	21600	0,1	RD..10T3
R217.29I-1632.RE-05.4A	03278784	Combimaster	22,0	32,0	4	5,0	–	M16	30,0	40,0	8,8	54,0	62,0	21600	0,2	RD..10T3
R217.29I-1632.RE-05.5A	03278785	Combimaster	22,2	32,0	5	5,0	–	M16	30,0	40,0	4,1	54,4	62,0	21600	0,2	RD..10T3
R217.29I-1635.RE-05.5A	03278786	Combimaster	25,1	35,0	5	5,0	–	M16	30,0	40,0	7,5	60,2	68,0	15600	0,2	RD..10T3
R217.29I-1640.RE-05.4A	03278787	Combimaster	30,0	40,0	4	5,0	–	M16	30,0	40,0	5,5	70,0	78,0	19300	0,3	RD..10T3
R217.29I-1640.RE-05.5A	03278788	Combimaster	30,0	40,0	5	5,0	–	M16	30,0	40,0	5,5	70,0	78,0	19300	0,3	RD..10T3
R217.29I-2040.RE-05.6A	03278791	Combimaster	30,2	40,0	6	5,0	–	M20	36,5	40,0	5,9	70,4	78,0	19300	0,3	RD..10T3
R217.29I-1642.RE-05.5A	03278789	Combimaster	32,0	42,0	5	5,0	–	M16	30,0	40,0	5,6	74,0	82,0	18800	0,3	RD..10T3
R217.29I-1642.RE-05.6A	03278790	Combimaster	32,0	42,0	6	5,0	–	M16	30,0	40,0	6,0	74,0	82,0	18800	0,3	RD..10T3
R220.29I-0040-05.5A	03278803	Arbor	30,0	40,0	5	5,0	16,0	–	33,0	40,0	7,3	70,0	78,0	19300	0,3	RD..10T3
R220.29I-0050-05.4A	03278804	Arbor	40,0	50,0	4	5,0	22,0	–	41,0	40,0	4,3	90,0	98,0	17300	0,3	RD..10T3
R220.29I-0050-05.6A	03278805	Arbor	40,0	50,0	6	5,0	22,0	–	41,0	40,0	4,3	90,0	98,0	17300	0,3	RD..10T3
R220.29I-0052-05.7A	03278806	Arbor	42,1	52,0	7	5,0	22,0	–	41,0	40,0	4,3	94,2	102,0	17000	0,3	RD..10T3
R220.29I-0063-05.6A	03278807	Arbor	53,0	63,0	6	5,0	22,0	–	49,0	40,0	3,1	116,0	124,0	15800	0,5	RD..10T3
R220.29I-0063-05.8A	03278808	Arbor	53,0	63,0	8	5,0	22,0	–	49,0	40,0	3,9	116,0	124,0	15800	0,5	RD..10T3

For Combimaster Shanks, see Machining Navigator Tooling System

Spare Parts, included in delivery

For cutter	Arbor screw	Insert key	Insert screw
			
R217.29I-1020	-	H4B-T09P	C03006-T09P
R217.29I-1225-2042	-	H4B-T09P	C03007-T09P
R220.29I-0040	220.17-689	H4B-T09P	C03007-T09P
R220.29I-0050-0063	220.17-692	H4B-T09P	C03007-T09P

Accessories

For cutter	Insert clamping torque	Torque key
		
R217/220.29I-..	2.0NM	T00-09P20

Torque and fixed keys, see page 894

- Square shoulder and slot milling cutters
- Helical milling cutters
- Face milling cutters
- Disc milling cutters
- High feed milling cutters
- Copy milling cutters
- Plunge milling cutters
- Chamfer milling cutters
- Spot facing cutters
- Inserts

R217/220.29I-05 – inch

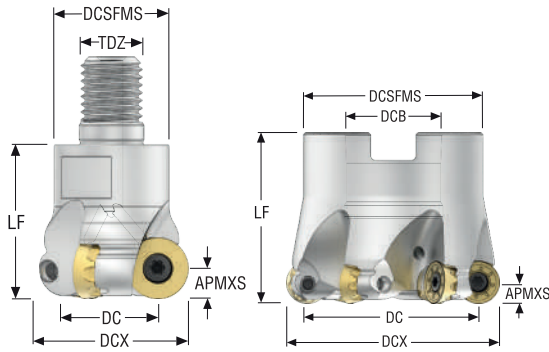

- For insert selection and cutting data recommendations, see page(s) 636-638
- For complete insert programme, see page(s) 839
- For ISO attribute explanation, see page 16

Designation	Item number	Type of mounting	DC	DCX	ZEFP	APMXS	DCB	TDZ	DCSFMS	LF	RMPX°	C min	C max	RPMX	Weight	Insert
			inch	inch		inch	inch		inch	inch		inch	inch		lbs	
R217.29I-1.00-12RE-05.3A	03278809	Combimaster	0.608	1.000	3	0.197	–	M12	0.906	1.181	13,3	1.610	1.921	24400	0.440	RD..10T3
R217.29I-1.25-16RE-05.4A	03278810	Combimaster	0.856	1.250	4	0.197	–	M16	1.181	1.575	8,9	2.106	2.421	21600	0.440	RD..10T3
R217.29I-1.50-16RE-05.5A	03278811	Combimaster	1.106	1.500	5	0.197	–	M16	1.181	1.575	6,0	2.606	2.921	19300	0.660	RD..10T3
R220.29I-01.50-05.5A	03278813	Arbor	1.106	1.500	5	0.197	0.500	–	1.339	1.500	6,5	2.606	2.921	14000	0.440	RD..10T3
R220.29I-02.00-05.6A	03278814	Arbor	1.606	2.000	6	0.197	0.750	–	1.614	1.500	4,2	3.606	3.921	12500	0.660	RD..10T3

For Combimaster Shanks, see Machining Navigator Tooling System

Spare Parts, included in delivery

For cutter	Arbor screw	Insert key	Insert screw
R217.29I-..	–	H4B-T09P	C03007-T09P
R220.29I-01.50	UC6S1/4UNFX1	H4B-T09P	C03007-T09P
R220.29I-02.00	UC6S3/8UNFX1	H4B-T09P	C03007-T09P

Accessories

For cutter	Insert clamping torque	Torque key
R217/220.29I-..	17.7IN.LBS	T00-09P20

Torque and fixed keys, see page 894

Square shoulder and slot milling cutters

Helical milling cutters

Face milling cutters

Disc milling cutters

High feed milling cutters

Copy milling cutters

Plunge milling cutters

Chamfer milling cutters

Spot facing cutters

Inserts

R217/220.291-05 – Insert selection – mm/Inch

SMG		a_p		f_z			
				100%	70%	30%	10%
P1	RDKT10T3M0T-6-M05 MP2501	2,0	0,16	0,16	0,16	0,16	0,22
		0,080	0,0065	0,0065	0,0065	0,0065	0,0085
P2	RDKT10T3M0T-6-M05 MP2501	2,0	0,16	0,16	0,16	0,16	0,22
		0,080	0,0065	0,0065	0,0065	0,0065	0,0085
P3	RDKT10T3M0T-6-M05 MP2501	2,0	0,15	0,15	0,15	0,16	0,20
		0,080	0,0060	0,0060	0,0060	0,0065	0,0080
P4	RDKT10T3M0T-6-M05 MP2501	2,0	0,15	0,15	0,15	0,15	0,20
		0,080	0,0060	0,0060	0,0060	0,0060	0,0080
P5	RDKT10T3M0T-6-M05 MP2501	2,0	0,15	0,15	0,15	0,15	0,20
		0,080	0,0060	0,0060	0,0060	0,0060	0,0080
P6	RDKT10T3M0T-6-M05 MP2501	2,0	0,14	0,14	0,14	0,15	0,20
		0,080	0,0055	0,0055	0,0055	0,0060	0,0080
P7	RDKW10T3M0T-6-MD06 MS2500	2,0	0,17	0,17	0,17	0,18	0,24
		0,080	0,0065	0,0065	0,0065	0,0070	0,0095
P8	RDKW10T3M0T-6-MD06 MS2500	2,0	0,18	0,18	0,18	0,19	0,25
		0,080	0,0070	0,0070	0,0070	0,0075	0,010
P11	RDKW10T3M0T-6-MD06 MS2500	2,0	0,17	0,17	0,17	0,18	0,24
		0,080	0,0065	0,0065	0,0065	0,0070	0,0095
P12	RDKW10T3M0T-6-MD06 MS2500	1,6	0,13	0,13	0,13	0,14	0,16
		0,065	0,0050	0,0050	0,0050	0,0055	0,0065
M1	RDHT10T3M0T-8-M11 MP2050	2,0	0,36	0,36	0,36	0,36	0,48
		0,080	0,014	0,014	0,014	0,014	0,019
M2	RDHT10T3M0T-8-M11 MP2050	2,0	0,32	0,32	0,32	0,32	0,44
		0,080	0,013	0,013	0,013	0,013	0,017
M3	RDHT10T3M0T-8-M11 MP2050	1,6	0,28	0,28	0,28	0,30	0,36
		0,065	0,011	0,011	0,011	0,012	0,014
M4	RDHT10T3M0T-8-M11 MP2050	1,2	0,28	0,28	0,28	0,28	0,32
		0,048	0,011	0,011	0,011	0,011	0,013
M5	RDHT10T3M0T-8-M11 MP2050	1,2	0,28	0,28	0,28	0,28	0,32
		0,048	0,011	0,011	0,011	0,011	0,013
K1	RDKW10T3M0T-8-MD06 MK2050	2,0	0,19	0,19	0,19	0,20	0,26
		0,080	0,0075	0,0075	0,0075	0,0080	0,010
K2	RDKW10T3M0T-8-MD06 MK2050	2,0	0,17	0,17	0,17	0,18	0,24
		0,080	0,0065	0,0065	0,0065	0,0070	0,0095
K3	RDKW10T3M0T-8-MD06 MK2050	2,0	0,17	0,17	0,17	0,18	0,24
		0,080	0,0065	0,0065	0,0065	0,0070	0,0095
K4	RDKW10T3M0T-8-MD06 MK2050	2,0	0,17	0,17	0,17	0,18	0,24
		0,080	0,0065	0,0065	0,0065	0,0070	0,0095
K5	RDKW10T3M0T-8-MD06 MK2050	2,0	0,16	0,16	0,16	0,16	0,22
		0,080	0,0065	0,0065	0,0065	0,0065	0,0085
K6	RDKW10T3M0T-8-MD06 MK2050	2,0	0,17	0,17	0,17	0,18	0,24
		0,080	0,0065	0,0065	0,0065	0,0070	0,0095
K7	RDKW10T3M0T-8-MD06 MK2050	2,0	0,16	0,16	0,16	0,16	0,22
		0,080	0,0065	0,0065	0,0065	0,0065	0,0085
N1	RDHT10T3M0-8-E04 H25	2,0	0,16	0,16	0,16	0,17	0,22
		0,080	0,0065	0,0065	0,0065	0,0065	0,0085
N2	RDHT10T3M0-8-E04 H25	2,0	0,16	0,16	0,16	0,17	0,22
		0,080	0,0065	0,0065	0,0065	0,0065	0,0085
N3	RDHT10T3M0-8-E04 H25	2,0	0,16	0,16	0,16	0,17	0,22
		0,080	0,0065	0,0065	0,0065	0,0065	0,0085
N11	RDHT10T3M0-8-E04 H25	2,0	0,16	0,16	0,16	0,17	0,22
		0,080	0,0065	0,0065	0,0065	0,0065	0,0085
S1	RDKT10T3M0T-8-M07 MS2500	1,2	0,18	0,18	0,18	0,18	0,20
		0,048	0,0070	0,0070	0,0070	0,0070	0,0080
S2	RDKT10T3M0T-8-M07 MS2500	1,2	0,18	0,18	0,18	0,18	0,20
		0,048	0,0070	0,0070	0,0070	0,0070	0,0080
S3	RDKT10T3M0T-6-M05 MS2500	1,2	0,12	0,12	0,12	0,12	0,13
		0,048	0,0048	0,0048	0,0048	0,0048	0,0050
S11	RDHT10T3M0T-8-M11 MS2050	1,4	0,30	0,30	0,30	0,30	0,36
		0,055	0,012	0,012	0,012	0,012	0,014
S12	RDHT10T3M0T-8-M11 MS2050	1,4	0,30	0,30	0,30	0,30	0,36
		0,055	0,012	0,012	0,012	0,012	0,014
S13	RDHT10T3M0T-8-M11 MS2050	1,2	0,28	0,28	0,28	0,28	0,32
		0,048	0,011	0,011	0,011	0,011	0,013
H5	RDHW10T3M0T-8-MD06 MH1000	1,6	0,13	0,13	0,13	0,14	0,16
		0,065	0,0050	0,0050	0,0050	0,0055	0,0065
H8	RDHW10T3M0T-8-MD06 MH1000	1,4	0,11	0,11	0,11	0,11	0,13
		0,055	0,0044	0,0044	0,0044	0,0044	0,0050
H11	RDHW10T3M0T-8-MD06 MH1000	1,6	0,13	0,13	0,13	0,14	0,16
		0,065	0,0050	0,0050	0,0050	0,0055	0,0065
H12	RDHW10T3M0T-8-MD06 MH1000	1,4	0,11	0,11	0,11	0,11	0,13
		0,055	0,0044	0,0044	0,0044	0,0044	0,0050
H21	RDHW10T3M0T-8-MD06 MH1000	1,4	0,11	0,11	0,11	0,11	0,13
		0,055	0,0044	0,0044	0,0044	0,0044	0,0050

SMG = Seco material group
 f_z = mm/tooth (in/tooth), v_c = m/min (sf/min), a_p/DC = %
 All cutting data are start values

R217/220.291-05 – Cutting data $v_c = (m/min)/(sf/min)$

SMG	MM4500				MS2050				MS2500				MH1000				H25			
	100%	70%	30%	10%	100%	70%	30%	10%	100%	70%	30%	10%	100%	70%	30%	10%	100%	70%	30%	10%
P1	200	230	280	325	310	350	420	490	405	460	550	640	—	—	—	—	—	—	—	—
	660	750	920	1075	1025	1150	1375	1600	1325	1500	1800	2100	—	—	—	—	—	—	—	—
P2	195	225	265	315	300	340	410	480	390	445	540	630	—	—	—	—	—	—	—	—
	640	740	870	1025	980	1125	1350	1575	1275	1450	1775	2075	—	—	—	—	—	—	—	—
P3	170	195	235	275	260	300	350	420	340	390	460	550	—	—	—	—	—	—	—	—
	560	640	770	900	850	980	1150	1375	1125	1275	1500	1800	—	—	—	—	—	—	—	—
P4	155	175	205	245	230	260	315	370	300	345	410	485	—	—	—	—	—	—	—	—
	510	570	670	800	750	850	1025	1225	980	1125	1350	1600	—	—	—	—	—	—	—	—
P5	145	165	200	235	220	250	300	355	290	330	395	460	—	—	—	—	—	—	—	—
	475	540	660	770	720	820	980	1175	950	1075	1300	1500	—	—	—	—	—	—	—	—
P6	165	185	225	260	250	285	335	395	330	375	440	520	—	—	—	—	—	—	—	—
	540	610	740	850	820	940	1100	1300	1075	1225	1450	1700	—	—	—	—	—	—	—	—
P7	155	175	210	245	235	270	320	375	310	355	415	490	—	—	—	—	—	—	—	—
	510	570	690	800	770	890	1050	1225	1025	1175	1350	1600	—	—	—	—	—	—	—	—
P8	145	160	195	230	220	250	295	355	290	330	390	460	—	—	—	—	—	—	—	—
	475	520	640	750	720	820	970	1175	950	1075	1275	1500	—	—	—	—	—	—	—	—
P11	150	170	205	240	230	260	310	365	300	345	405	475	—	—	—	—	—	—	—	—
	490	560	670	790	750	850	1025	1200	980	1125	1325	1550	—	—	—	—	—	—	—	—
P12	95	110	130	155	145	165	195	230	190	215	260	300	—	—	—	—	—	—	—	—
	310	360	425	510	475	540	640	750	620	710	850	980	—	—	—	—	—	—	—	—
M1	170	190	225	270	240	275	330	385	280	320	385	450	—	—	—	—	—	—	—	—
	560	620	740	890	790	900	1075	1275	920	1050	1275	1475	—	—	—	—	—	—	—	—
M2	140	160	190	225	200	225	270	320	230	260	315	370	—	—	—	—	—	—	—	—
	460	520	620	740	660	740	890	1050	750	850	1025	1225	—	—	—	—	—	—	—	—
M3	110	125	150	180	160	180	215	255	185	210	250	295	—	—	—	—	—	—	—	—
	360	410	490	590	520	590	710	840	610	690	820	970	—	—	—	—	—	—	—	—
M4	85	100	115	140	125	140	165	195	145	160	190	225	—	—	—	—	—	—	—	—
	280	330	375	460	410	460	540	640	475	520	620	740	—	—	—	—	—	—	—	—
M5	70	80	100	115	100	115	135	160	120	135	160	190	—	—	—	—	—	—	—	—
	230	260	330	375	330	375	445	520	395	445	520	620	—	—	—	—	—	—	—	—
K1	—	—	—	—	—	—	—	—	—	—	—	—	270	305	365	430	—	—	—	—
	—	—	—	—	—	—	—	—	—	—	—	—	890	1000	1200	1400	—	—	—	—
K2	—	—	—	—	—	—	—	—	—	—	—	—	240	270	320	380	—	—	—	—
	—	—	—	—	—	—	—	—	—	—	—	—	790	890	1050	1250	—	—	—	—
K3	—	—	—	—	—	—	—	—	—	—	—	—	200	230	275	320	—	—	—	—
	—	—	—	—	—	—	—	—	—	—	—	—	660	750	900	1050	—	—	—	—
K4	—	—	—	—	—	—	—	—	—	—	—	—	195	220	260	305	—	—	—	—
	—	—	—	—	—	—	—	—	—	—	—	—	640	720	850	1000	—	—	—	—
K5	—	—	—	—	—	—	—	—	—	—	—	—	115	130	160	185	—	—	—	—
	—	—	—	—	—	—	—	—	—	—	—	—	375	425	520	610	—	—	—	—
K6	—	—	—	—	—	—	—	—	—	—	—	—	170	195	230	270	—	—	—	—
	—	—	—	—	—	—	—	—	—	—	—	—	560	640	750	890	—	—	—	—
K7	—	—	—	—	—	—	—	—	—	—	—	—	150	170	205	240	—	—	—	—
	—	—	—	—	—	—	—	—	—	—	—	—	490	560	670	790	—	—	—	—
N1	—	—	—	—	—	—	—	—	—	—	—	—	—	—	—	—	1675	1900	2250	2650
	—	—	—	—	—	—	—	—	—	—	—	—	—	—	—	—	5500	6225	7375	8700
N2	—	—	—	—	—	—	—	—	—	—	—	—	—	—	—	—	670	760	910	1075
	—	—	—	—	—	—	—	—	—	—	—	—	—	—	—	—	2200	2500	2975	3525
N3	—	—	—	—	—	—	—	—	—	—	—	—	—	—	—	—	450	510	600	720
	—	—	—	—	—	—	—	—	—	—	—	—	—	—	—	—	1475	1675	1975	2350
N11	—	—	—	—	—	—	—	—	—	—	—	—	—	—	—	—	510	580	690	820
	—	—	—	—	—	—	—	—	—	—	—	—	—	—	—	—	1675	1900	2275	2700
S1	27	30	36	42	55	65	75	90	70	80	95	110	—	—	—	—	—	—	—	—
	90	100	120	140	180	215	245	295	230	260	310	360	—	—	—	—	—	—	—	—
S2	21	24	29	34	46	50	60	75	55	65	75	90	—	—	—	—	—	—	—	—
	70	80	95	110	150	165	195	245	180	215	245	295	—	—	—	—	—	—	—	—
S3	19	21	25	30	40	46	55	65	49	55	65	80	—	—	—	—	—	—	—	—
	60	70	80	100	130	150	180	215	160	180	215	260	—	—	—	—	—	—	—	—
S11	37	42	50	60	80	90	110	130	100	110	130	155	—	—	—	—	—	—	—	—
	120	140	165	195	260	295	360	425	330	360	425	510	—	—	—	—	—	—	—	—
S12	34	39	46	55	55	65	75	90	70	75	90	110	—	—	—	—	—	—	—	—
	110	130	150	180	180	215	245	295	230	245	295	360	—	—	—	—	—	—	—	—
S13	20	23	27	32	32	36	43	50	39	44	55	60	—	—	—	—	—	—	—	—
	65	75	90	105	105	120	140	165	130	145	180	195	—	—	—	—	—	—	—	—
H5	—	—	—	—	—	—	—	—	—	—	—	—	55	65	75	90	—	—	—	—
	—	—	—	—	—	—	—	—	—	—	—	—	180	215	245	295	—	—	—	—
H8	—	—	—	—	—	—	—	—	—	—	—	—	60	65	75	90	—	—	—	—
	—	—	—	—	—	—	—	—	—	—	—	—	195	215	245	295	—	—	—	—
H11	—	—	—	—	—	—	—	—	—	—	—	—	70	80	95	110	—	—	—	—
	—	—	—	—	—	—	—	—	—	—	—	—	230	260	310	360	—	—	—	—
H12	—	—	—	—	—	—	—	—	—	—	—	—	105	120	140	165	—	—	—	—
	—	—	—	—	—	—	—	—	—	—	—	—	345	395	460	540	—	—	—	—
H21	—	—	—	—	—	—	—	—	—	—	—	—	60	65	75	90	—	—	—	—
	—	—	—	—	—	—	—	—	—	—	—	—	195	215	245	295	—	—	—	—

R217.291-06 – Metric

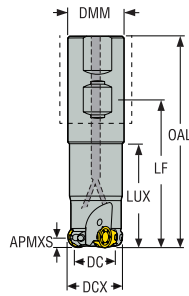

- For insert selection and cutting data recommendations, see page(s) 646-648
- For complete insert programme, see page(s) 841
- For ISO attribute explanation, see page 16

Designation	Item number	Type of mounting	DC	DCX	ZFP	APMXS	DMM	LS	OAL	LUX	RMPX°	Cmin	Cmax	RPMX	Weight	Insert
			mm	mm		mm	mm	mm	mm	mm		mm	mm		kg	
R217.291-2525.3-06.2.050A	02949613	Weldon	13,0	25,0	2	6,0	25,0	46,0	106,0	21,6	13,0	38,0	48,0	17700	0,4	RP..1204
R217.291-3232.3-06.3.060A	02949614	Weldon	20,0	32,0	3	6,0	32,0	60,0	120,0	26,6	7,0	52,0	62,0	15600	0,7	RP..1204
R217.291-3240.3-06-055.4A	03024047	Weldon	28,0	40,0	4	6,0	32,0	60,0	115,0	55,0	8,0	68,0	78,0	14000	0,6	RP..1204
R217.291-3240.3-06.4.075A	02949615	Weldon	28,0	40,0	4	6,0	32,0	60,0	135,0	72,0	8,0	68,0	78,0	14000	0,8	RP..1204

Center coolant hole possibility by removing centre screw

Spare Parts, included in delivery

For cutter	Centre screw	Insert key	Insert screw	Key	Screw
R217.291-... Ø25	-	H4B-T15P	C03508-T15P	T05P-2	SX2035-T05P
R217.291-... Ø32-40	-	H4B-T15P	C03509-T15P	T05P-2	SX2035-T05P
R217.291-... Ø32-40-4A	SH3040	H4B-T15P	C03509-T15P	T05P-2	SX2035-T05P

Accessories

For cutter	Insert clamping torque	Torque key
R217.29-...	3.0NM	T00-15P30

Torque and fixed keys, see page 894

Square shoulder and slot milling cutters

Helical milling cutters

Face milling cutters

Disc milling cutters

High feed milling cutters

Copy milling cutters

Plunge milling cutters

Chamfer milling cutters

Spot facing cutters

Inserts

R217.29I-06 – inch

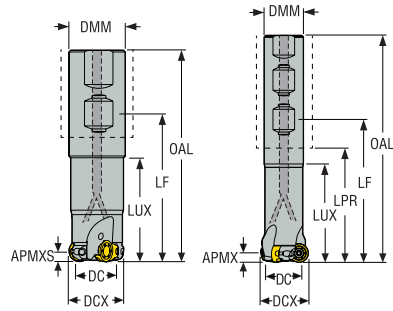

- For insert selection and cutting data recommendations, see page(s) 646-648
- For complete insert programme, see page(s) 841
- For ISO attribute explanation, see page 16

Designation	Item number	Type of mounting	DC	DCX	ZFP	APMXS	DMM	LS	LPR	OAL	LUX	RMPX°	C min	C max	RPMX	Weight	Insert
			inch	inch		inch	inch	inch	inch	inch	inch		inch	inch		lbs	
R217.29I-01.00-0-06.2A	02949638	Cylindrical	0.528	1.000	2	0.236	1.000	4.008	4.295	6.500	2.480	12,0	1.528	1.921	17700	1.320	RP.1204
R217.29I-01.00-3F-06.2A	02949640	Weldon	0.528	1.000	2	0.236	1.000	3.280	2.500	5.780	2.500	12,0	1.528	1.921	17700	1.100	RP.1204

Center coolant hole possibility by removing centre screw

Spare Parts, included in delivery

For cutter	Insert key	Insert screw	Key	Screw
R217.29I-..	H4B-T15P	C03508-T15P	T05P-2	SX2035-T05P

Accessories

For cutter	Insert clamping torque	Torque key
R217.29I-01.00	26.6IN.LBS	T00-15P30

Torque and fixed keys, see page 894

R220.29I-06 – Metric

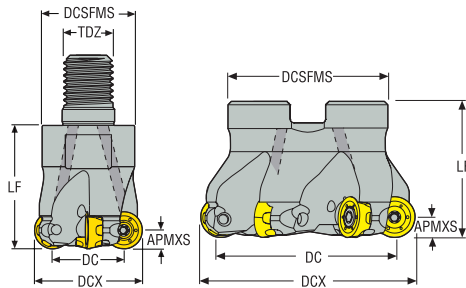

- For insert selection and cutting data recommendations, see page(s) 646-648
- For complete insert programme, see page(s) 841
- For ISO attribute explanation, see page 16

Designation	Item number	Type of mounting	DC	DCX	ZEFP	APMXS	DCB	TDZ	DCSFMS	LF	RMPX*	Cmin	Cmax	RPMX	Weight	Insert
			mm	mm		mm	mm		mm	mm		mm	mm		kg	
R217.29I-1225.RE-06.2A	02949605	Combimaster	13,0	25,0	2	6,0	–	M12	23,0	35,0	13,0	38,0	48,0	17700	0,2	RP..1204
R217.29I-1632.RE-06.3A	02949607	Combimaster	20,0	32,0	3	6,0	–	M16	30,0	40,0	7,0	52,0	62,0	15600	0,3	RP..1204
R217.29I-1635.RE-06.3A	02949608	Combimaster	23,0	35,0	3	6,0	–	M16	30,0	40,0	10,0	58,0	68,0	15000	0,3	RP..1204
R217.29I-1635.RE-06.4A	02949609	Combimaster	23,0	35,0	4	6,0	–	M16	30,0	40,0	6,0	58,0	68,0	15000	0,2	RP..1204
R217.29I-1640.RE-06.4A	02949611	Combimaster	28,0	40,0	4	6,0	–	M16	30,0	40,0	8,0	68,0	78,0	14000	0,3	RP..1204
R217.29I-2040.RE06.4A	02928079	Combimaster	28,0	40,0	4	6,0	–	M20	36,5	45,0	8,0	68,0	78,0	14000	0,4	RP..1204
R217.29I-1642.RE-06.5A	02949612	Combimaster	30,0	42,0	5	6,0	–	M16	30,0	40,0	4,0	72,0	82,0	13600	0,3	RP..1204
R217.29I-2042.RE-06.5A	02991174	Combimaster	30,0	42,0	5	6,0	–	M20	36,5	45,0	4,2	72,0	82,0	13600	0,4	RP..1204
R220.29I-0040-06.4A	02949616	Arbor	28,0	40,0	4	6,0	16,0	–	35,0	40,0	8,0	68,0	78,0	14000	0,3	RP..1204
R220.29I-0044-06.4A	03002205	Arbor	32,0	44,0	4	6,0	16,0	–	35,0	40,0	7,9	76,0	86,0	13300	0,2	RP..1204
R220.29I-0050-06.4A	02949617	Arbor	38,0	50,0	4	6,0	22,0	–	42,0	40,0	5,5	88,0	98,0	12500	0,3	RP..1204
R220.29I-0050-06.5A	02949618	Arbor	38,0	50,0	5	6,0	22,0	–	42,0	40,0	5,5	88,0	98,0	12500	0,3	RP..1204
R220.29I-0050-06.6A	03203202	Arbor	38,0	50,0	6	6,0	22,0	–	42,0	40,0	5,0	88,0	98,0	12500	0,3	RP..1204
R220.29I-0052-06.4A	02949619	Arbor	40,0	52,0	4	6,0	22,0	–	42,0	40,0	5,0	92,0	102,0	12300	0,3	RP..1204
R220.29I-0052-06.5A	02949620	Arbor	40,0	52,0	5	6,0	22,0	–	42,0	40,0	5,0	92,0	102,0	12300	0,4	RP..1204
R220.29I-0063-06.5A	02949621	Arbor	51,0	63,0	5	6,0	22,0	–	47,0	40,0	4,0	114,0	124,0	11200	0,4	RP..1204
R220.29I-0063-06.6A	02949622	Arbor	51,0	63,0	6	6,0	22,0	–	47,0	40,0	4,0	114,0	124,0	11200	0,5	RP..1204
R220.29I-0063-06.7A	02949623	Arbor	51,0	63,0	7	6,0	22,0	–	47,0	40,0	3,0	114,0	124,0	11200	0,5	RP..1204
R220.29I-0066-06.6A	02949624	Arbor	54,0	66,0	6	6,0	27,0	–	50,0	50,0	3,5	120,0	130,0	10900	0,6	RP..1204
R220.29I-0080-06.6A	02949625	Arbor	68,0	80,0	6	6,0	27,0	–	62,0	50,0	3,0	148,0	158,0	10000	1,0	RP..1204
R220.29I-0080-06.7A	02949626	Arbor	68,0	80,0	7	6,0	27,0	–	62,0	50,0	3,0	148,0	158,0	10000	1,0	RP..1204
R220.29I-0080-06.8A	02949627	Arbor	68,0	80,0	8	6,0	27,0	–	62,0	50,0	2,0	148,0	158,0	10000	1,0	RP..1204
R220.29I-0084-06.6A	02969096	Arbor	72,0	84,0	6	6,0	32,0	–	77,0	50,0	2,5	156,0	166,0	9500	1,2	RP..1204
R220.29I-0092-06.7A	02949628	Arbor	80,0	92,0	7	6,0	32,0	–	77,0	50,0	2,5	172,0	182,0	9200	1,4	RP..1204
R220.29I-0100-06.9A	02949629	Arbor	88,0	100,0	9	6,0	32,0	–	77,0	50,0	2,0	188,0	198,0	8800	1,6	RP..1204
R220.29I-0112-06.7A	02949630	Arbor	100,0	112,0	7	6,0	32,0	–	77,0	63,0	1,5	212,0	222,0	8400	1,8	RP..1204
R220.29I-0125-06.11A	02949631	Arbor	113,0	125,0	11	6,0	40,0	–	90,0	63,0	1,5	238,0	248,0	8000	3,1	RP..1204
R220.29I-0137-06.8A	02949632	Arbor	125,0	137,0	8	6,0	40,0	–	90,0	63,0	1,5	262,0	272,0	7600	3,3	RP..1204

Square shoulder and slot milling cutters

Helical milling cutters

Face milling cutters

Disc milling cutters

High feed milling cutters

Copy milling cutters

Plunge milling cutters

Chamfer milling cutters

Spot facing cutters

Inserts

Spare Parts, included in delivery

For cutter	Arbor screw	Insert key	Insert screw	Key	Screw
R217.29I-25/35-4A/42	-	H4B-T15P	C03508-T15P	T05P-2	SX2035-T05P
R217.29I-32/35-3A/40	-	H4B-T15P	C03509-T15P	T05P-2	SX2035-T05P
R220.29I-.. Ø40-44	220.17-689	H4B-T15P	C03509-T15P	T05P-2	SX2035-T05P
R220.29I-.. Ø50-52	220.17-692	H4B-T15P	C03509-T15P	T05P-2	SX2035-T05P
R220.29I-.. Ø50-6A	220.17-692	H4B-T15P	C03508-T15P	T05P-2	SX2035-T05P
R220.29I-.. Ø63	220.17-692	H4B-T15P	C03509-T15P	T05P-2	SX2035-T05P
R220.29I-.. Ø66-80	MC6S12X35	H4B-T15P	C03509-T15P	T05P-2	SX2035-T05P
R220.29I-.. Ø84-112	950E1645	H4B-T15P	C03509-T15P	T05P-2	SX2035-T05P
R220.29I-.. Ø84-112	950E1645	H4B-T15PL	C03509-T15P	T05P-2	SX2035-T05P
R220.29I-.. Ø125-137	MC6S20X50	H4B-T15PL	C03509-T15P	T05P-2	SX2035-T05P

Accessories

For cutter	Insert clamping torque	Torque key
R217/220.29-..	3.0NM	T00-15P30

Torque and fixed keys, see page 894

Square shoulder and slot milling cutters
Helical milling cutters
Face milling cutters
Disc milling cutters
High feed milling cutters
Copy milling cutters
Plunge milling cutters
Chamfer milling cutters
Spot facing cutters
Inserts

R220.29I-06 – inch

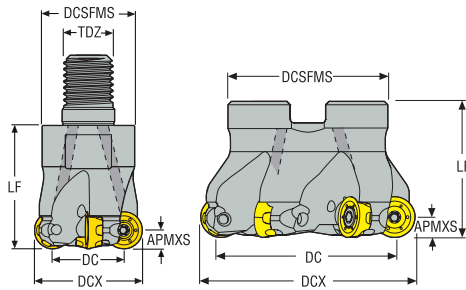

- For insert selection and cutting data recommendations, see page(s) 646-648
- For complete insert programme, see page(s) 841
- For ISO attribute explanation, see page 16

Designation	Item number	Type of mounting	DC	DCX	ZEFP	APMXS	DCB	TDZ	DCSFMS	LF	RMPX°	C min	C max	RPMX	Weight	Insert
			inch	inch		inch	inch		inch	inch		inch	inch		lbs	
R217.29I-01.00-12RE-06.2A	02949633	Combimaster	0.528	1.000	2	0.236	-	M12	0.906	1.378	12,0	1.528	1.921	17700	0.440	RP..1204
R217.29I-01.25-12RE-06.3A	02949635	Combimaster	0.778	1.250	3	0.236	-	M12	0.906	1.575	7,0	2.028	2.421	15600	0.440	RP..1204
R217.29I-01.25-16RE-06.3A	02949634	Combimaster	0.778	1.250	3	0.236	-	M16	1.181	1.575	7,0	2.028	2.421	15600	0.660	RP..1204
R217.29I-01.50-16RE-06.3A	02949636	Combimaster	1.028	1.500	3	0.236	-	M16	1.181	1.575	8,5	2.528	2.921	14000	0.660	RP..1204
R217.29I-01.50-16RE-06.4A	02949637	Combimaster	1.028	1.500	4	0.236	-	M16	1.181	1.575	8,5	2.528	2.921	14000	0.660	RP..1204
R217.29I-01.50-20RE-06.4A	03002402	Combimaster	1.028	1.500	4	0.236	-	M20	1.437	1.575	8,5	2.528	2.921	14000	0.660	RP..1204
R220.29I-02.00-06.4A	02949642	Arbor	1.528	2.000	4	0.236	0.750	-	1.654	1.500	6,5	3.528	3.921	12500	0.660	RP..1204
R220.29I-02.00-06.5A	02949643	Arbor	1.528	2.000	5	0.236	0.750	-	1.654	1.500	6,5	3.528	3.921	12500	0.660	RP..1204
R220.29I-02.00-06.6A	03279243	Arbor	1.535	2.000	6	0.236	0.750	-	1.654	1.500	5,0	3.535	3.921	12500	0.660	RP..1204
R220.29I-02.50-06.6A	02949644	Arbor	2.028	2.500	6	0.236	0.750	-	1.850	1.500	4,6	4.528	4.921	11200	1.100	RP..1204
R220.29I-02.50-06.7A	02949645	Arbor	2.028	2.500	7	0.236	0.750	-	1.850	1.500	4,6	4.528	4.921	11200	1.100	RP..1204
R220.29I-03.00-06.6A	02949647	Arbor	2.528	3.000	6	0.236	1.000	-	2.441	2.000	3,0	5.528	5.921	10000	2.200	RP..1204
R220.29I-03.00-06.7A	02949648	Arbor	2.528	3.000	7	0.236	1.000	-	2.441	2.000	3,0	5.528	5.921	10000	2.200	RP..1204
R220.29I-04.00-06.7A	02949649	Arbor	3.528	4.000	7	0.236	1.500	-	3.543	2.000	2,0	7.528	7.921	8800	4.410	RP..1204
R220.29I-04.00-06.9A	02949650	Arbor	3.528	4.000	9	0.236	1.500	-	3.543	2.000	2,0	7.528	7.921	8800	4.410	RP..1204
R220.29I-06.00-06.8	02949652	Arbor	5.528	6.000	8	0.236	2.000	-	4.331	2.000	1,2	11.528	11.921	7600	8.820	RP..1204

Square shoulder and slot milling cutters

Helical milling cutters

Face milling cutters

Disc milling cutters

High feed milling cutters

Copy milling cutters

Plunge milling cutters

Chamfer milling cutters

Spot facing cutters

Inserts

Spare Parts, included in delivery

For cutter	Arbor screw	Insert key	Insert screw	Key	Screw
R217.29I-01.00	-	H4B-T15P	C03508-T15P	T05P-2	SX2035-T05P
R217.29I-01.25	-	H4B-T15P	C03509-T15P	T05P-2	SX2035-T05P
R217.29I-01.50	-	H4B-T15P	C03509-T15P	T05P-2	SX2035-T05P
R217.29I-01.50-4A	-	H4B-T15P	C03509-T15P	T05P-2	SX2035-T05P
R220.29I-02.00-02.50	UC6S3/8UNFX1	H4B-T15P	C03509-T15P	T05P-2	SX2035-T05P
R220.29I-02.00-6A	UC6S3/8UNFX1	H4B-T15P	C03508-T15P	T05P-2	SX2035-T05P
R220.29I-03.00	UC6S1/2UNFX1-1/2	H4B-T15P	C03509-T15P	T05P-2	SX2035-T05P
R220.29I-04.00	ULC6S3/4UNFX11/2	H4B-T15PL	C03509-T15P	T05P-2	SX2035-T05P
R220.29I-06.00	-	H4B-T15PL	C03509-T15P	T05P-2	SX2035-T05P

Accessories

For cutter	Arbor screw	Insert clamping torque	Torque key
R217/220.29I-01.00-04.00	-	26.6IN.LBS	T00-15P30
R220.29I-06.00	58215080	26.6IN.LBS	T00-15P30

Torque and fixed keys, see page 894

Square shoulder and slot milling cutters
Helical milling cutters
Face milling cutters
Disc milling cutters
High feed milling cutters
Copy milling cutters
Plunge milling cutters
Chamfer milling cutters
Spot facing cutters
Inserts

R217/220.29B-06 – For blade machining – Metric

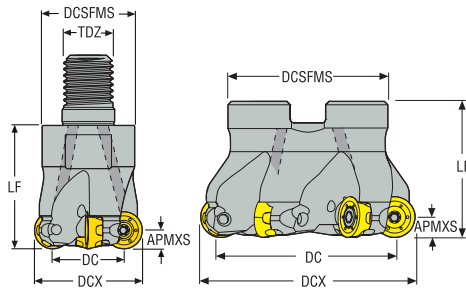







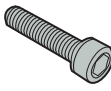

- For insert selection and cutting data recommendations, see page(s) 646-648
- For complete insert programme, see page(s) 841
- For ISO attribute explanation, see page 16

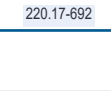

Designation	Item number	Type of mounting	DC	DCX	ZFEP	APMXS	DCB	TDZ	DCSFMS	LF	RMPX*	Cmin	Cmax	RPMX	Weight	Insert
			mm	mm		mm	mm		mm	mm		mm	mm		kg	
R220.29B-0040-06.4A	03007485	Arbor	28,0	40,0	4	6,0	16,0	-	35,0	40,0	5,0	68,0	78,0	14000	0,2	RP..1204
R220.29B-0050-06.5A	03007486	Arbor	38,0	50,0	5	6,0	22,0	-	42,0	40,0	5,0	88,0	98,0	12500	0,3	RP..1204
R220.29B-0052-06.5A	03007487	Arbor	38,0	52,0	5	6,0	22,0	-	42,0	40,0	5,0	90,0	102,0	12300	0,3	RP..1204
R220.29B-0063-06.6A	03074236	Arbor	51,0	63,0	6	6,0	22,0	-	47,0	40,0	4,0	114,0	124,0	11200	0,5	RP..1204
R220.29B-0063-06.7A	03074237	Arbor	51,0	63,0	7	6,0	22,0	-	47,0	40,0	4,0	114,0	124,0	11200	0,5	RP..1204

For Combimaster Shanks, see Machining Navigator Tooling System

Spare Parts, included in delivery

For cutter	Arbor screw	Insert key	Insert screw	Key	Screw
R220.29-0040					
	220.17-689	H4B-T15P	C03509-T15P	T05P-2	SX2035-T05P
R220.29-0050-0063					
	220.17-692	H4B-T15P	C03509-T15P	T05P-2	SX2035-T05P

Accessories

For cutter	Insert clamping torque	Torque key
R220.29-..		
	3.0NM	T00-15P30

Torque and fixed keys, see page 894

Square shoulder and slot milling cutters

Helical milling cutters

Face milling cutters

Disc milling cutters

High feed milling cutters

Copy milling cutters

Plunge milling cutters

Chamfer milling cutters

Spot facing cutters

Inserts

R217/220.29-06 – Insert selection – mm/Inch

SMG		a _p	f _z			
			100%	70%	30%	10%
P1	RPHT1204M0T-6-M08 MP2501	2,5	0,25	0,25	0,24	0,36
		0,10	0,010	0,010	0,0095	0,014
P2	RPHT1204M0T-6-M08 MP2501	2,5	0,25	0,25	0,25	0,38
		0,10	0,010	0,010	0,010	0,015
P3	RPHT1204M0T-6-M08 MP2501	2,5	0,24	0,24	0,24	0,36
		0,10	0,0095	0,0095	0,0095	0,014
P4	RPHT1204M0T-6-M08 MP2501	2,5	0,24	0,24	0,24	0,34
		0,10	0,0095	0,0095	0,0095	0,013
P5	RPKT1204M0T-6-M15 MP2501	2,5	0,42	0,42	0,42	0,65
		0,10	0,017	0,017	0,017	0,026
P6	RPKT1204M0T-6-M15 MP2501	2,5	0,42	0,42	0,42	0,65
		0,10	0,017	0,017	0,017	0,026
P7	RPKT1204M0T-6-M15 MP2501	2,5	0,42	0,42	0,42	0,65
		0,10	0,017	0,017	0,017	0,026
P8	RPHT1204M0T-6-M13 MS2500	2,5	0,38	0,38	0,38	0,55
		0,10	0,015	0,015	0,015	0,022
P11	RPHT1204M0T-6-M13 MS2500	2,5	0,36	0,36	0,36	0,55
		0,10	0,014	0,014	0,014	0,022
P12	RPHT1204M0T-4-M13 MS2500	1,9	0,28	0,28	0,30	0,38
		0,075	0,011	0,011	0,012	0,015
M1	RPHT1204M0T-6-ME07 MS2050	2,5	0,22	0,22	0,22	0,32
		0,10	0,0085	0,0085	0,0085	0,013
M2	RPHT1204M0T-6-ME07 MS2050	2,5	0,20	0,20	0,20	0,30
		0,10	0,0080	0,0080	0,0080	0,012
M3	RPHT1204M0T-6-ME07 MS2050	1,9	0,18	0,18	0,19	0,24
		0,075	0,0070	0,0070	0,0075	0,0095
M4	RPHT1204M0T-6-M08 T350M	1,4	0,22	0,22	0,20	0,24
		0,055	0,0085	0,0085	0,0080	0,0095
M5	RPHT1204M0T-6-M08 T350M	1,4	0,22	0,22	0,20	0,24
		0,055	0,0085	0,0085	0,0080	0,0095
K1	RPKT1204M0T-6-M15 MK2050	2,5	0,46	0,46	0,46	0,70
		0,10	0,018	0,018	0,018	0,028
K2	RPKT1204M0T-6-M15 MK2050	2,5	0,42	0,42	0,42	0,65
		0,10	0,017	0,017	0,017	0,026
K3	RPKT1204M0T-6-M15 MK2050	2,5	0,42	0,42	0,42	0,65
		0,10	0,017	0,017	0,017	0,026
K4	RPKT1204M0T-6-M15 MK2050	2,5	0,42	0,42	0,42	0,65
		0,10	0,017	0,017	0,017	0,026
K5	RPKT1204M0T-6-M15 MK2050	2,5	0,38	0,38	0,38	0,55
		0,10	0,015	0,015	0,015	0,022
K6	RPKT1204M0T-6-M15 MK2050	2,5	0,42	0,42	0,42	0,65
		0,10	0,017	0,017	0,017	0,026
K7	RPKT1204M0T-6-M15 MK2050	2,5	0,38	0,38	0,38	0,55
		0,10	0,015	0,015	0,015	0,022
N1	RPHT1204M0-6-E05 H25	2,5	0,20	0,20	0,20	0,30
		0,10	0,0080	0,0080	0,0080	0,012
N2	RPHT1204M0-6-E05 H25	2,5	0,20	0,20	0,20	0,30
		0,10	0,0080	0,0080	0,0080	0,012
N3	RPHT1204M0-6-E05 H25	2,5	0,20	0,20	0,20	0,30
		0,10	0,0080	0,0080	0,0080	0,012
N11	RPHT1204M0-6-E05 H25	2,5	0,20	0,20	0,20	0,30
		0,10	0,0080	0,0080	0,0080	0,012
S1	RPHT1204M0T-6-M13 MS2500	1,4	0,34	0,34	0,34	0,38
		0,055	0,013	0,013	0,013	0,015
S2	RPHT1204M0T-6-M13 MS2500	1,4	0,34	0,34	0,34	0,38
		0,055	0,013	0,013	0,013	0,015
S3	RPHT1204M0T-6-M13 MS2500	1,4	0,32	0,32	0,32	0,36
		0,055	0,013	0,013	0,013	0,014
S11	RPHT1204M0T-6-M13 MS2050	1,7	0,36	0,36	0,34	0,44
		0,065	0,014	0,014	0,013	0,017
S12	RPHT1204M0T-6-M13 MS2050	1,7	0,36	0,36	0,34	0,44
		0,065	0,014	0,014	0,013	0,017
S13	RPHT1204M0T-6-M13 MS2050	1,4	0,34	0,34	0,34	0,38
		0,055	0,013	0,013	0,013	0,015
H5	RPHW1204M0T-6-MD12 MH1000	1,9	0,26	0,26	0,28	0,34
		0,075	0,010	0,010	0,011	0,013
H8	RPHW1204M0T-6-MD12 MH1000	1,7	0,22	0,22	0,20	0,26
		0,065	0,0085	0,0085	0,0080	0,010
H11	RPHW1204M0T-6-MD12 MH1000	1,9	0,26	0,26	0,28	0,34
		0,075	0,010	0,010	0,011	0,013
H12	RPHT1204M0T-6-M13 T350M	1,7	0,24	0,24	0,22	0,28
		0,065	0,0095	0,0095	0,0085	0,011
H21	RPHW1204M0T-6-MD12 MH1000	1,7	0,22	0,22	0,20	0,26
		0,065	0,0085	0,0085	0,0080	0,010

SMG = Seco material group
 f_z = mm/tooth (in/tooth), v_c = m/min (sf/min), a_p/DC = %
 All cutting data are start values

R217/220.29I-08 – Metric

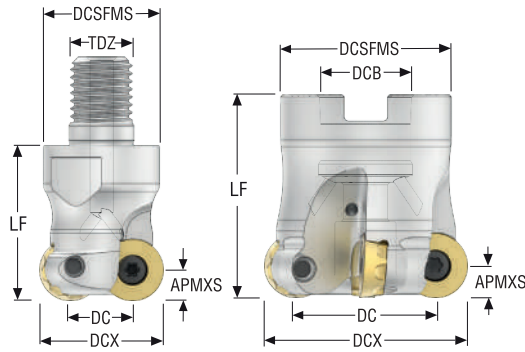

- For insert selection and cutting data recommendations, see page(s) 652-654
- For complete insert programme, see page(s) 842
- For ISO attribute explanation, see page 16

Designation	Item number	Type of mounting	DC	DCX	ZEFP	APMXS	DCB	TDZ	DCSFMS	LF	RMPX*	Cmin	Cmax	RPMX	Weight	Insert
			mm	mm		mm	mm		mm	mm		mm	mm		kg	
R217.29I-1632.RE-08.2A	03278975	Combimaster	15,9	32,0	2	8,0	–	M16	30,0	40,0	17,8	47,8	62,0	12200	0,2	RP..1605
R217.29I-1640.RE-08.3A	03278976	Combimaster	24,2	40,0	3	8,0	–	M16	30,0	40,0	2,4	64,4	78,0	10900	0,2	RP..1605
R217.29I-2040.RE-08.3A	03278977	Combimaster	24,2	40,0	3	8,0	–	M20	36,5	40,0	2,4	64,4	78,0	10900	0,3	RP..1605
R220.29I-0050-08.4A	03278978	Arbor	34,2	50,0	4	8,0	22,0	–	41,0	50,0	4,8	84,4	98,0	9700	0,4	RP..1605
R220.29I-0052-08.4A	03278979	Arbor	36,2	52,0	4	8,0	22,0	–	41,0	50,0	5,7	88,4	102,0	9600	0,4	RP..1605
R220.29I-0063-08.4A	03278980	Arbor	47,1	63,0	4	8,0	22,0	–	49,0	50,0	7,5	110,2	124,0	8700	0,6	RP..1605
R220.29I-0063-08.5A	03278981	Arbor	47,1	63,0	5	8,0	22,0	–	49,0	50,0	7,1	110,2	124,0	8700	0,6	RP..1605
R220.29I-0063-08.6A	03278982	Arbor	47,1	63,0	6	8,0	22,0	–	49,0	50,0	7,1	110,2	124,0	8700	0,6	RP..1605
R220.29I-0066-08.5A	03278983	Arbor	50,1	66,0	5	8,0	27,0	–	61,0	50,0	6,9	116,2	130,0	8400	0,7	RP..1605
R220.29I-0066-08.6A	03278984	Arbor	50,0	66,0	6	8,0	27,0	–	61,0	50,0	6,7	116,0	130,0	8400	0,7	RP..1605
R220.29I-0080-08.5A	03278985	Arbor	64,1	80,0	5	8,0	27,0	–	61,0	50,0	5,0	144,2	158,0	7700	1,0	RP..1605
R220.29I-0080-08.7A	03278986	Arbor	64,1	80,0	7	8,0	27,0	–	61,0	50,0	5,0	144,2	158,0	7700	1,0	RP..1605
R220.29I-0084-08.5A	03278987	Arbor	68,1	84,0	5	8,0	32,0	–	79,0	50,0	4,6	152,2	166,0	7500	1,2	RP..1605
R220.29I-0100-08.6MA	03278992	Arbor	84,1	100,0	6	8,0	32,0	–	79,0	50,0	3,8	184,2	198,0	6800	1,6	RP..1605
R220.29I-0100-08.8A	03278988	Arbor	84,1	100,0	8	8,0	32,0	–	79,0	50,0	3,7	184,2	198,0	6800	1,6	RP..1605
R220.29I-0125-08.6MA	03278991	Arbor	109,1	125,0	6	8,0	40,0	–	90,0	63,0	2,8	234,2	248,0	6100	2,9	RP..1605
R220.29I-0125-08.10A	03278989	Arbor	109,1	125,0	10	8,0	40,0	–	90,0	63,0	2,8	234,2	248,0	6100	2,9	RP..1605
R220.29I-8160-08.7MA	03278993	Arbor	143,1	160,0	7	8,0	40,0	–	90,0	63,0	2,2	302,2	318,0	5400	4,2	RP..1605
R220.29I-8160-08.10A	03278990	Arbor	144,1	160,0	10	8,0	40,0	–	90,0	63,0	2,1	304,2	318,0	5400	4,3	RP..1605

For Combimaster Shanks, see Machining Navigator Tooling System

Square shoulder and slot milling cutters

Helical milling cutters

Face milling cutters

Disc milling cutters

High feed milling cutters

Copy milling cutters

Plunge milling cutters

Chamfer milling cutters

Spot facing cutters

Inserts

Spare Parts, included in delivery

For cutter	Arbor screw	Insert key	Insert screw	Insert shim	Key	Lid	Lid screw	Shim screw	Stop screw
R217.29I-1632-2040	-	H6B-T20P	C05010-T20P	-	T05P-2	-	-	-	SX2035-T05P
R220.29I-0050-0052	220.17-692M	H6B-T20P	C05013-T20P	-	T05P-2	-	-	-	SX2035-T05P
R220.29I-0063	MC6S10X40	H6B-T20P	C05013-T20P	-	T05P-2	-	-	-	SX2035-T05P
R220.29I-0066-0080	MC6S12X40	H6B-T20P	C05013-T20P	-	T05P-2	-	-	-	SX2035-T05P
R220.29I-0084	950E1645	H6B-T20P	C05013-T20P	-	T05P-2	-	-	-	SX2035-T05P
R220.29I-0100MA	950E1645	H6B-T20P	C05018-T20P	SRP1604IM0	T05P-2	-	-	CA5010	SX2035-T05P
R220.29I-0100	950E1645	H6B-T20P	C05013-T20P	-	T05P-2	-	-	-	SX2035-T05P
R220.29I-0125MA	MC6S20X50	H6B-T20P	C05018-T20P	SRP1604IM0	T05P-2	-	-	CA5010	SX2035-T05P
R220.29I-0125	MC6S20X50	H6B-T20P	C05013-T20P	-	T05P-2	-	-	-	SX2035-T05P
R220.29I-8160MA	-	H6B-T20P	C05018-T20P	SRP1604IM0	T05P-2	SC160-53	MF6S4X10	CA5010	SX2035-T05P
R220.29I-8160	-	H6B-T20P	C05013-T20P	-	T05P-2	SC160-53	MF6S4X10	-	SX2035-T05P

Accessories

For cutter	Arbor screw	Insert clamping torque	Torque key
R217/220.29I-1632-0125	-	5.0NM	T00-20P50
R220.29I-8160	MC6S12X40	5.0NM	T00-20P50

Torque and fixed keys, see page 894

Square shoulder and slot milling cutters
Helical milling cutters
Face milling cutters
Disc milling cutters
High feed milling cutters
Copy milling cutters
Plunge milling cutters
Chamfer milling cutters
Spot facing cutters
Inserts



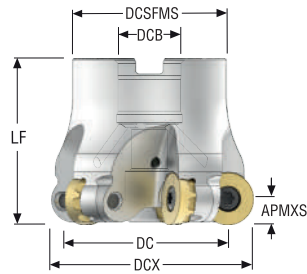

R217/220.291-08 – inch



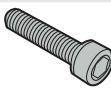
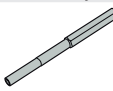

- For insert selection and cutting data recommendations, see page(s) 652-654
- For complete insert programme, see page(s) 842
- For ISO attribute explanation, see page 16

Designation	Item number	Type of mounting	DC	DCX	ZEFP	APMXS	DCB	DCSFMS	LF	RMPX°	C min	C max	RPMX	Weight	Insert
			inch	inch		inch	inch	inch	inch		inch	inch		lbs	
R220.291-02.00-08.4A	03278994	Arbor	1.379	2.000	4	0.315	0.750	1.614	2.000	2,7	3.388	3.921	9600	0.880	RP..1605
R220.291-02.50-08.5A	03278995	Arbor	1.876	2.500	5	0.315	0.750	1.811	2.000	7,0	4.382	4.921	8700	0.220	RP..1605
R220.291-03.00-08.6A	03278996	Arbor	2.376	3.000	6	0.315	1.000	2.402	2.000	5,3	5.381	5.921	7700	1.980	RP..1605
R220.291-04.00-08.7A	03278997	Arbor	3.375	4.000	7	0.315	1.500	3.504	2.500	3,6	7.380	7.921	6800	5.290	RP..1605

Spare Parts, included in delivery

For cutter	Arbor screw	Insert key	Insert screw	Key	Stop screw
R220.291-02.00-02.50					
	UC6S3/8UNFX11/2	H6B-T20P	C05013-T20P	T05P-2	SX2035-T05P
R220.291-03.00	UC6S1/2UNFX1-1/2	H6B-T20P	C05013-T20P	T05P-2	SX2035-T05P
R220.291-04.00	UC6S3/4UNFX1-1/4	H6B-T20P	C05013-T20P	T05P-2	SX2035-T05P

Accessories

For cutter	Insert clamping torque	Torque key
R220.291-..	 44.3IN.LBS	 T00-20P50

Torque and fixed keys, see page 894

Square shoulder and slot milling cutters

Helical milling cutters

Face milling cutters

Disc milling cutters

High feed milling cutters

Copy milling cutters

Plunge milling cutters

Chamfer milling cutters

Spot facing cutters

Inserts

R217/220.29-081 – Insert selection – mm/Inch

SMG		a _p	f _z			
			100%	70%	30%	10%
P1	RPKT1605M0T-8-M12 MP2501	3,0	0,38	0,38	0,38	0,60
		0,12	0,015	0,015	0,015	0,024
P2	RPKT1605M0T-8-M12 MP2501	3,0	0,40	0,40	0,40	0,60
		0,12	0,016	0,016	0,016	0,024
P3	RPKT1605M0T-8-M12 MP2501	3,0	0,38	0,38	0,36	0,55
		0,12	0,015	0,015	0,014	0,022
P4	RPKT1605M0T-8-M12 MP2501	3,0	0,36	0,36	0,36	0,55
		0,12	0,014	0,014	0,014	0,022
P5	RPKT1605M0T-8-M12 MP2501	3,0	0,36	0,36	0,36	0,55
		0,12	0,014	0,014	0,014	0,022
P6	RPKT1605M0T-8-M18 MS2500	3,0	0,55	0,55	0,55	0,80
		0,12	0,022	0,022	0,022	0,032
P7	RPKT1605M0T-6-M18 MS2500	3,0	0,55	0,55	0,55	0,80
		0,12	0,022	0,022	0,022	0,032
P8	RPKT1605M0T-6-M18 MS2500	3,0	0,55	0,55	0,55	0,85
		0,12	0,022	0,022	0,022	0,034
P11	RPKT1605M0T-6-M18 MS2500	3,0	0,55	0,55	0,55	0,80
		0,12	0,022	0,022	0,022	0,032
P12	RPKT1605M0T-6-M18 MS2500	2,5	0,40	0,40	0,38	0,55
		0,10	0,016	0,016	0,015	0,022
M1	RPHT1605M0T-8-M12 MS2050	3,0	0,40	0,40	0,40	0,60
		0,12	0,016	0,016	0,016	0,024
M2	RPHT1605M0T-8-M12 MS2050	3,0	0,36	0,36	0,36	0,55
		0,12	0,014	0,014	0,014	0,022
M3	RPHT1605M0T-8-M12 MS2050	2,5	0,32	0,32	0,30	0,44
		0,10	0,013	0,013	0,012	0,017
M4	RPKT1605M0T-8-M12 T350M	1,9	0,32	0,32	0,30	0,38
		0,075	0,013	0,013	0,012	0,015
M5	RPKT1605M0T-8-M12 T350M	1,9	0,32	0,32	0,30	0,38
		0,075	0,013	0,013	0,012	0,015
K1	RPKT1605M0T-8-M18 MK2050	3,0	0,60	0,60	0,60	0,90
		0,12	0,024	0,024	0,024	0,036
K2	RPKT1605M0T-8-M18 MK2050	3,0	0,55	0,55	0,55	0,85
		0,12	0,022	0,022	0,022	0,034
K3	RPKT1605M0T-8-M18 MK2050	3,0	0,55	0,55	0,55	0,85
		0,12	0,022	0,022	0,022	0,034
K4	RPKT1605M0T-8-M18 MK2050	3,0	0,55	0,55	0,55	0,85
		0,12	0,022	0,022	0,022	0,034
K5	RPKT1605M0T-8-M18 MK2050	3,0	0,48	0,48	0,48	0,75
		0,12	0,019	0,019	0,019	0,030
K6	RPKT1605M0T-8-M18 MK2050	3,0	0,55	0,55	0,55	0,85
		0,12	0,022	0,022	0,022	0,034
K7	RPKT1605M0T-8-M18 MK2050	3,0	0,48	0,48	0,48	0,75
		0,12	0,019	0,019	0,019	0,030
N1	RPHT1605M0T-8-ME11 F40M	3,0	0,46	0,46	0,46	0,70
		0,12	0,018	0,018	0,018	0,028
N2	RPHT1605M0T-8-ME11 F40M	3,0	0,46	0,46	0,46	0,70
		0,12	0,018	0,018	0,018	0,028
N3	RPHT1605M0T-8-ME11 F40M	3,0	0,46	0,46	0,46	0,70
		0,12	0,018	0,018	0,018	0,028
N11	RPHT1605M0T-8-ME11 F40M	3,0	0,46	0,46	0,46	0,70
		0,12	0,018	0,018	0,018	0,028
S1	RPKT1605M0T-8-M12 MS2500	1,9	0,32	0,32	0,30	0,38
		0,075	0,013	0,013	0,012	0,015
S2	RPKT1605M0T-8-M12 MS2500	1,9	0,32	0,32	0,30	0,38
		0,075	0,013	0,013	0,012	0,015
S3	RPKT1605M0T-8-M12 MS2500	1,9	0,30	0,30	0,28	0,36
		0,075	0,012	0,012	0,011	0,014
S11	RPHT1605M0T-8-M12 MS2050	2,5	0,32	0,32	0,32	0,44
		0,10	0,013	0,013	0,013	0,017
S12	RPHT1605M0T-8-M12 MS2050	2,5	0,32	0,32	0,32	0,44
		0,10	0,013	0,013	0,013	0,017
S13	RPHT1605M0T-8-M12 MS2050	1,9	0,32	0,32	0,30	0,38
		0,075	0,013	0,013	0,012	0,015
H5	RPKW1605M0T-8-MD20 F15M	2,5	0,44	0,44	0,42	0,60
		0,10	0,017	0,017	0,017	0,024
H8	RPKW1605M0T-8-MD20 F15M	2,5	0,34	0,34	0,34	0,48
		0,10	0,013	0,013	0,013	0,019
H11	RPKW1605M0T-8-MD20 F15M	2,5	0,44	0,44	0,42	0,60
		0,10	0,017	0,017	0,017	0,024
H12	RPKW1605M0T-8-MD20 F15M	2,5	0,34	0,34	0,34	0,48
		0,10	0,013	0,013	0,013	0,019
H21	RPKW1605M0T-8-MD20 F15M	2,5	0,34	0,34	0,34	0,48
		0,10	0,013	0,013	0,013	0,019

SMG = Seco material group
 f_z = mm/tooth (in/tooth), v_c = m/min (sf/min), a_p/DC = %
 All cutting data are start values

R217/220.29-08 – Cutting data $v_c = (m/min)/(sf/min)$

SMG	MK2050				MM4500				MS2050				MS2500			
	100%	70%	30%	10%	100%	70%	30%	10%	100%	70%	30%	10%	100%	70%	30%	10%
P1	255	295	355	420	185	215	255	295	250	290	345	405	325	380	455	530
	840	970	1175	1375	610	710	840	970	820	950	1125	1325	1075	1250	1500	1750
P2	245	290	345	410	175	205	245	290	240	280	335	390	310	365	435	510
	800	950	1125	1350	570	670	800	950	790	920	1100	1275	1025	1200	1425	1675
P3	220	255	305	360	155	180	215	255	210	245	295	345	275	320	385	455
	720	840	1000	1175	510	590	710	840	690	800	970	1125	900	1050	1275	1500
P4	195	225	270	315	140	160	190	225	185	220	260	305	245	285	340	400
	640	740	890	1025	460	520	620	740	610	720	850	1000	800	940	1125	1300
P5	185	215	260	300	130	155	185	215	180	210	250	290	235	270	325	380
	610	710	850	980	425	510	610	710	590	690	820	950	770	890	1075	1250
P6	205	240	290	345	145	170	205	240	200	235	280	325	260	305	365	425
	670	790	950	1125	475	560	670	790	660	770	920	1075	850	1000	1200	1400
P7	195	230	275	325	140	160	195	225	190	220	265	310	245	290	345	405
	640	750	900	1075	460	520	640	740	620	720	870	1025	800	950	1125	1325
P8	185	215	260	300	130	150	185	215	175	205	250	290	230	270	325	380
	610	710	850	980	425	490	610	710	570	670	820	950	750	890	1075	1250
P11	190	220	265	315	135	160	190	220	185	215	255	300	240	280	335	390
	620	720	870	1025	445	520	620	720	610	710	840	980	790	920	1100	1275
P12	125	150	180	210	90	105	125	145	120	140	170	200	160	185	220	260
	410	490	590	690	295	345	410	475	395	460	560	660	520	610	720	850
M1	—	—	—	—	150	175	210	250	190	225	270	315	225	260	310	370
	—	—	—	—	490	570	690	820	620	740	890	1025	740	850	1025	1225
M2	—	—	—	—	125	145	175	205	160	185	225	260	185	220	260	305
	—	—	—	—	410	475	570	670	520	610	740	850	610	720	850	1000
M3	—	—	—	—	100	120	140	165	130	150	180	210	150	175	210	245
	—	—	—	—	330	395	460	540	425	490	590	690	490	570	690	800
M4	—	—	—	—	80	90	110	130	100	115	140	165	120	135	165	190
	—	—	—	—	260	295	360	425	330	375	460	540	395	445	540	620
M5	—	—	—	—	65	75	90	110	85	95	115	140	100	115	135	160
	—	—	—	—	215	245	295	360	280	310	375	460	330	375	445	520
K1	265	310	375	440	—	—	—	—	—	—	—	—	—	—	—	—
	870	1025	1225	1450	—	—	—	—	—	—	—	—	—	—	—	—
K2	240	280	335	390	—	—	—	—	—	—	—	—	—	—	—	—
	790	920	1100	1275	—	—	—	—	—	—	—	—	—	—	—	—
K3	200	235	280	330	—	—	—	—	—	—	—	—	—	—	—	—
	660	770	920	1075	—	—	—	—	—	—	—	—	—	—	—	—
K4	190	225	270	315	—	—	—	—	—	—	—	—	—	—	—	—
	620	740	890	1025	—	—	—	—	—	—	—	—	—	—	—	—
K5	120	140	165	195	—	—	—	—	—	—	—	—	—	—	—	—
	395	460	540	640	—	—	—	—	—	—	—	—	—	—	—	—
K6	170	200	235	275	—	—	—	—	—	—	—	—	—	—	—	—
	560	660	770	900	—	—	—	—	—	—	—	—	—	—	—	—
K7	155	180	215	250	—	—	—	—	—	—	—	—	—	—	—	—
	510	590	710	820	—	—	—	—	—	—	—	—	—	—	—	—
N1	—	—	—	—	—	—	—	—	—	—	—	—	—	—	—	—
	—	—	—	—	—	—	—	—	—	—	—	—	—	—	—	—
N2	—	—	—	—	—	—	—	—	—	—	—	—	—	—	—	—
	—	—	—	—	—	—	—	—	—	—	—	—	—	—	—	—
N3	—	—	—	—	—	—	—	—	—	—	—	—	—	—	—	—
	—	—	—	—	—	—	—	—	—	—	—	—	—	—	—	—
N11	—	—	—	—	—	—	—	—	—	—	—	—	—	—	—	—
	—	—	—	—	—	—	—	—	—	—	—	—	—	—	—	—
S1	—	—	—	—	24	28	34	40	47	55	65	75	60	65	80	95
	—	—	—	—	80	90	110	130	155	180	215	245	195	215	260	310
S2	—	—	—	—	20	23	27	32	38	44	55	60	46	55	65	75
	—	—	—	—	65	75	90	105	125	145	180	195	150	180	215	245
S3	—	—	—	—	17	20	24	28	33	39	46	55	41	47	55	65
	—	—	—	—	55	65	80	90	110	130	150	180	135	155	180	215
S11	—	—	—	—	34	39	47	55	65	75	90	105	80	95	110	130
	—	—	—	—	110	130	155	180	215	245	295	345	260	310	360	425
S12	—	—	—	—	31	36	43	50	45	55	65	75	55	65	75	90
	—	—	—	—	100	120	140	165	150	180	215	245	180	215	245	295
S13	—	—	—	—	18	21	25	30	27	31	37	43	32	37	45	55
	—	—	—	—	60	70	80	100	90	100	120	140	105	120	150	180
H5	—	—	—	—	—	—	—	—	—	—	—	—	—	—	—	—
	—	—	—	—	—	—	—	—	—	—	—	—	—	—	—	—
H8	—	—	—	—	—	—	—	—	—	—	—	—	—	—	—	—
	—	—	—	—	—	—	—	—	—	—	—	—	—	—	—	—
H11	—	—	—	—	—	—	—	—	—	—	—	—	—	—	—	—
	—	—	—	—	—	—	—	—	—	—	—	—	—	—	—	—
H12	—	—	—	—	—	—	—	—	—	—	—	—	—	—	—	—
	—	—	—	—	—	—	—	—	—	—	—	—	—	—	—	—
H21	—	—	—	—	—	—	—	—	—	—	—	—	—	—	—	—
	—	—	—	—	—	—	—	—	—	—	—	—	—	—	—	—

R220.29-38 – inch

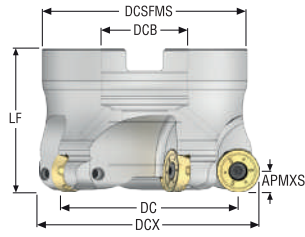

- For insert selection and cutting data recommendations, see page(s) 656-657
- For complete insert programme, see page(s) 842
- For ISO attribute explanation, see page 16

Designation	Item number	Type of mounting	DC	DCX	ZEFP	APMXS	DCB	DCSFMS	LF	RMPX*	C min	C max	RPMX	Weight	Insert
			inch	inch		inch	inch	inch	inch		inch	inch		lbs	
R220.29I-02.50-38-04A	10005910	Arbor	1.756	2.500	4	0.374	0.750	1.789	2.000	10,39	4.256	4.921	5800	2.200	RPHT19
R220.29I-03.00-38-06A	10005911	Arbor	2.256	3.000	6	0.374	1.000	2.289	2.000	7,69	5.256	5.921	5100	2.650	RPHT19
R220.29I-04.00-38-05A	10005912	Arbor	3.256	4.000	5	0.374	1.500	3.539	2.500	5,06	7.256	7.921	4500	5.070	RPHT19
R220.29I-04.00-38-06A	10005913	Arbor	3.256	4.000	6	0.374	1.500	3.539	2.500	5,06	7.256	7.921	4500	5.070	RPHT19
R220.29I-05.00-38-07A	10005914	Arbor	4.256	5.000	7	0.374	1.500	3.539	2.500	3,76	9.256	9.921	4000	6.830	RPHT19
R220.29I-05.00-38-09A	10005915	Arbor	4.256	5.000	9	0.374	1.500	3.539	2.500	3,76	9.256	9.921	4000	4.410	RPHT19

For Combimaster Shanks, see Machining Navigator Tooling System

Spare Parts, included in delivery

For cutter	Arbor screw	Coolant screw	Insert key	Insert screw
R220.29I-02.50	UC6S3/8UNFX11/2	SX2035-T05P	H6B-T20P	C05013-T20P
R220.29I-03.00	UC6S1/2UNFX1-1/2	SX2035-T05P	H6B-T20P	C05013-T20P
R220.29I-04.00-05.00	UC6S3/4UNFX1-1/4	SX2035-T05P	H6B-T20PL	C05013-T20P

Accessories

For cutter	Insert clamping torque	Torque key
R220.29I-..	44.3IN.LBS	T00-20P50

Torque and fixed keys, see page 894

Square shoulder and slot milling cutters

Helical milling cutters

Face milling cutters

Disc milling cutters

High feed milling cutters

Copy milling cutters

Plunge milling cutters

Chamfer milling cutters

Spot facing cutters

Inserts

R217.29-38 – Insert selection – mm/Inch

SMG		a _p	f _z			
			100%	30%	10%	5%
P1	RPHT190600T-6-M13 T350M	4,0	0,60	0,60	0,90	1,3
		0,16	0,024	0,024	0,036	0,050
P2	RPHT190600T-6-M13 T350M	4,0	0,60	0,60	0,90	1,3
		0,16	0,024	0,024	0,036	0,050
P3	RPHT190600T-6-M13 T350M	4,0	0,55	0,60	0,85	1,2
		0,16	0,022	0,024	0,034	0,048
P4	RPHT190600T-6-M13 MS2500	4,0	0,55	0,60	0,85	1,2
		0,16	0,022	0,024	0,034	0,048
P5	RPHT190600T-6-M13 MS2500	4,0	0,55	0,55	0,85	1,2
		0,16	0,022	0,022	0,034	0,048
P6	RPHT190600T-6-M13 MS2500	4,0	0,55	0,55	0,80	1,2
		0,16	0,022	0,022	0,032	0,048
P7	RPHT190600T-6-M13 MS2500	4,0	0,55	0,55	0,80	1,2
		0,16	0,022	0,022	0,032	0,048
P8	RPHT190600T-6-M13 MS2500	4,0	0,55	0,60	0,85	1,2
		0,16	0,022	0,024	0,034	0,048
P11	RPHT190600T-6-M13 MS2500	4,0	0,55	0,55	0,80	1,2
		0,16	0,022	0,022	0,032	0,048
P12	RPHT190600T-6-M13 MS2500	3,0	0,42	0,40	0,55	0,80
		0,12	0,017	0,016	0,022	0,032
M1	RPHT190600T-6-M13 F40M	4,0	0,60	0,60	0,90	1,3
		0,16	0,024	0,024	0,036	0,050
M2	RPHT190600T-6-M13 F40M	4,0	0,55	0,55	0,85	1,2
		0,16	0,022	0,022	0,034	0,048
M3	RPHT190600T-6-M13 F40M	3,0	0,50	0,48	0,65	0,95
		0,12	0,020	0,019	0,026	0,038
M4	RPHT190600T-6-M13 F40M	2,5	0,48	0,50	0,60	0,80
		0,10	0,019	0,020	0,024	0,032
M5	RPHT190600T-6-M13 F40M	2,5	0,48	0,50	0,60	0,80
		0,10	0,019	0,020	0,024	0,032
S1	RPHT190600T-6-M13 MS2500	2,5	0,48	0,50	0,60	0,80
		0,10	0,019	0,020	0,024	0,032
S2	RPHT190600T-6-M13 MS2500	2,5	0,48	0,50	0,60	0,80
		0,10	0,019	0,020	0,024	0,032
S3	RPHT190600T-6-M13 MS2500	2,5	0,44	0,46	0,55	0,75
		0,10	0,017	0,018	0,022	0,030
S11	RPHT190600T-6-M13 MS2050	2,5	0,55	0,50	0,65	0,95
		0,10	0,022	0,020	0,026	0,038
S12	RPHT190600T-6-M13 MS2050	2,5	0,55	0,50	0,65	0,95
		0,10	0,022	0,020	0,026	0,038
S13	RPHT190600T-6-M13 MS2050	2,5	0,48	0,50	0,60	0,80
		0,10	0,019	0,020	0,024	0,032

SMG = Seco material group
 f_z = mm/tooth (in/tooth), v_c = m/min (sf/min), a_p/DC = %
 All cutting data are start values

R217/220.29-38 – Cutting data $v_c = (m/min)/(sf/min)$

SMG	T350M				F40M				MS2050				MS2500			
	100%	30%	10%	5%	100%	30%	10%	5%	100%	30%	10%	5%	100%	30%	10%	5%
P1	215	305	355	370	190	265	310	320	205	290	340	355	270	380	445	465
	710	1000	1175	1225	620	870	1025	1050	670	950	1125	1175	890	1250	1450	1525
P2	210	295	345	360	185	260	300	315	200	285	330	345	265	370	435	450
	690	970	1125	1175	610	850	980	1025	660	940	1075	1125	870	1225	1425	1475
P3	185	255	305	320	160	220	265	275	180	245	290	305	235	320	380	400
	610	840	1000	1050	520	720	870	900	590	800	950	1000	770	1050	1250	1300
P4	165	225	270	280	145	195	235	245	155	215	255	270	205	280	335	350
	540	740	890	920	475	640	770	800	510	710	840	890	670	920	1100	1150
P5	155	220	255	265	135	190	220	230	150	210	245	255	195	275	320	335
	510	720	840	870	445	620	720	750	490	690	800	840	640	900	1050	1100
P6	175	250	290	300	155	215	255	260	170	235	280	285	220	310	365	375
	570	820	950	980	510	710	840	850	560	770	920	940	720	1025	1200	1225
P7	165	235	275	285	145	205	240	245	160	225	265	270	210	295	345	355
	540	770	900	940	475	670	790	840	520	740	870	890	690	970	1125	1175
P8	155	215	255	265	135	185	220	230	150	205	245	255	195	270	320	335
	510	710	840	870	445	610	720	750	490	670	800	840	640	890	1050	1100
P11	160	225	270	275	140	200	235	240	155	215	255	265	200	285	335	345
	520	740	890	900	460	660	770	790	510	710	840	870	660	940	1100	1125
P12	110	150	175	185	95	130	155	160	105	145	170	175	135	190	220	230
	360	490	570	610	310	425	510	520	345	475	560	570	445	620	720	750
M1	160	230	265	280	145	210	245	250	160	230	265	275	190	265	310	325
	520	750	870	920	475	690	800	820	520	750	870	900	620	870	1025	1075
M2	135	190	220	230	120	175	200	210	135	190	220	230	155	220	255	270
	445	620	720	750	395	570	660	690	445	620	720	750	510	720	840	890
M3	110	155	180	190	100	140	165	170	110	155	180	190	130	180	210	220
	360	510	590	620	330	460	540	560	360	510	590	620	425	590	690	720
M4	150	210	245	260	80	110	125	135	85	120	140	150	100	140	165	175
	490	690	800	850	260	360	410	445	280	395	460	490	330	460	540	570
M5	150	210	245	260	65	90	105	115	70	100	115	125	85	115	135	145
	490	690	800	850	215	295	345	375	230	330	375	410	280	375	445	475
S1	41	55	65	70	37	50	60	65	41	55	65	70	49	70	80	85
	135	180	215	230	120	165	195	215	135	180	215	230	160	230	260	280
S2	33	45	55	55	30	41	48	50	33	45	55	55	40	55	65	70
	110	150	180	180	100	135	155	165	110	150	180	180	130	180	215	230
S3	29	40	47	49	26	36	42	45	29	40	47	49	35	48	55	60
	95	130	155	160	85	120	140	150	95	130	155	160	115	155	180	195
S11	55	80	90	95	50	70	85	85	55	80	90	95	70	95	110	115
	180	260	295	310	165	230	280	280	180	260	295	310	230	310	360	375
S12	39	55	65	65	35	49	60	60	39	55	65	65	47	65	80	80
	130	180	215	215	115	160	195	195	130	180	215	215	155	215	260	260
S13	23	31	37	39	21	29	33	36	23	31	37	39	28	38	45	48
	75	100	120	130	70	95	110	120	75	100	120	130	90	125	150	155

Square shoulder and slot milling cutters
Helical milling cutters
Face milling cutters
Disc milling cutters
High feed milling cutters
Copy milling cutters
Plunge milling cutters
Chamfer milling cutters
Spot facing cutters
Inserts

R217.29-10 – Metric

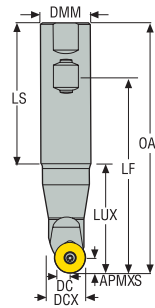

- For insert selection and cutting data recommendations, see page(s) 663-665
- For complete insert programme, see page(s) 842
- For ISO attribute explanation, see page 16

Designation	Item number	Type of mounting	DC	DCX	ZEFP	APMXS	DMM	LS	OAL	LUX	RMPX°	Cmin	Cmax	RPMX	Weight	Insert
			mm	mm		mm	mm	mm	mm	mm		mm	mm		kg	
R217.29-3250.3-10.3.080	02426255	Weldon	30,0	50,0	3	10,0	32,0	87,0	140,0	79,0	9,5	80,0	98,0	6500	1,0	RP.2006

Spare Parts, included in delivery

For cutter	Insert key	Insert screw
R217.29-..	H6B-T20P	C05013-T20P

Accessories

For cutter	Insert clamping torque	Torque key
R217.29-..	5.0NM	T00-20P50

Torque and fixed keys, see page 894

Square shoulder and slot milling cutters
Helical milling cutters
Face milling cutters
Disc milling cutters
High feed milling cutters
Copy milling cutters
Plunge milling cutters
Chamfer milling cutters
Spot facing cutters
Inserts

R217.29-10 – inch

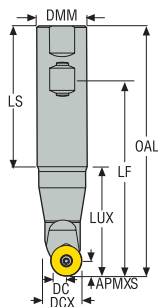

- For insert selection and cutting data recommendations, see page(s) 663-665
- For complete insert programme, see page(s) 842
- For ISO attribute explanation, see page 16

Designation	Item number	Type of mounting	DC	DCX	ZEFP	APMXS	DMM	LS	OAL	LUX	RMPX°	C min	C max	RPMX	Weight	Insert
			inch	inch		inch	inch	inch	inch	inch		inch	inch		lbs	
R217.29-02.00-3-10.3	00087696	Weldon	1.213	2.000	3	0.315	1.250	3.400	5.512	3.400	9,8	3.213	3.921	6500	2.200	RP.2006

Spare Parts, included in delivery

For cutter	Insert key	Insert screw
R217.29-..	H6B-T20P	C05013-T20P

Accessories

For cutter	Insert clamping torque	Torque key
R217.29-..	44.3IN.LBS	T00-20P50

Torque and fixed keys, see page 894

Square shoulder and slot milling cutters

Helical milling cutters

Face milling cutters

Disc milling cutters

High feed milling cutters

Copy milling cutters

Plunge milling cutters

Chamfer milling cutters

Spot facing cutters

Inserts

R220.29-10 – Metric

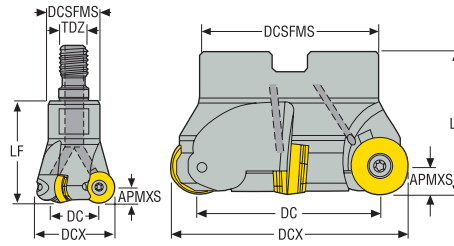

- For insert selection and cutting data recommendations, see page(s) 663-665
- For complete insert programme, see page(s) 842
- For ISO attribute explanation, see page 16

Designation	Item number	Type of mounting	DC	DCX	ZEFP	APMXS	DCB	TDZ	DCSFMS	LF	RMPX°	Cmin	Cmax	RPMX	Weight	Insert
			mm	mm		mm	mm		mm	mm		mm	mm		kg	
R217.29-1640.RE-10.2A	02426282	Combimaster	20,0	40,0	2	10,0	–	M16	30,0	40,0	40,0	60,0	78,0	8400	0,2	RP.2006
R220.29-0063-10.4A	02427241	Arbor	43,0	63,0	4	10,0	22,0	–	47,0	50,0	6,0	106,0	124,0	5800	0,5	RP.2006
R220.29-0080-10.4MA	02497996	Arbor	60,0	80,0	4	10,0	27,0	–	62,0	50,0	6,5	140,0	158,0	2100	0,9	RP.2006
R220.29-0080-10.5A	02497999	Arbor	60,0	80,0	5	10,0	27,0	–	62,0	50,0	6,5	140,0	158,0	2100	0,9	RP.2006
R220.29-0083-10.4MA	02498001	Arbor	63,0	83,0	4	10,0	27,0	–	62,0	50,0	6,2	146,0	164,0	5000	0,9	RP.2006
R220.29-0100-10.5MA	02498002	Arbor	80,0	100,0	5	10,0	32,0	–	77,0	50,0	4,7	180,0	198,0	4500	1,4	RP.2006
R220.29-0100-10.6A	02468476	Arbor	80,0	100,0	6	10,0	32,0	–	77,0	50,0	4,7	180,0	198,0	4500	1,5	RP.2006
R220.29-0125-10.5MA	02498005	Arbor	105,0	125,0	5	10,0	40,0	–	90,0	63,0	3,47	230,0	248,0	4000	2,9	RP.2006
R220.29-0125-10.7A	02498006	Arbor	105,0	125,0	7	10,0	40,0	–	90,0	63,0	3,47	230,0	248,0	4000	2,7	RP.2006
R220.29-8160-10.6M	02498008	Arbor	140,0	160,0	6	10,0	40,0	–	90,0	63,0	2,2	300,0	318,0	3600	4,1	RP.2006
R220.29-8200-10.8M	02495666	Arbor	180,0	200,0	8	10,0	60,0	–	130,0	63,0	1,66	380,0	398,0	3200	6,0	RP.2006
R220.29-8250-10.9M	02495667	Arbor	230,0	250,0	9	10,0	60,0	–	130,0	63,0	1,3	480,0	498,0	2900	11,1	RP.2006

For Combimaster Shanks, see Machining Navigator Tooling System

Spare Parts, included in delivery

For cutter	Arbor screw	Insert key	Insert screw	Insert shim	Shim key	Shim screw
R217.29-..	-	H6B-T20P	C05013-T20P	-	-	-
R220.29-0063	220.17-692	H6B-T20P	C05013-T20P	-	-	-
R220.29-0080M	MC6S12X35	H6B-T20P	C05018-T20P	SRP2004M0	H6B-H5.0L	CA5010
R220.29-0080A	MC6S12X35	H6B-T20P	C05013-T20P	-	-	-
R220.29-0083M	MC6S12X35	H6B-T20PL	C05018-T20P	SRP2004M0	H6B-H5.0L	CA5010
R220.29-0100M	MLC6S16X35	H6B-T20PL	C05018-T20P	SRP2004M0	H6B-H5.0L	CA5010
R220.29-0100	MLC6S16X35	H6B-T20PL	C05013-T20P	-	-	-
R220.29-0125M	MLC6S20X40	H6B-T20PL	C05018-T20P	SRP2004M0	H6B-H5.0L	CA5010
R220.29-0125A	MLC6S20X40	H6B-T20PL	C05013-T20P	-	-	-
R220.29-8160M	-	1/4HEX-T20PX90	C05018-T20P	SRP2004M0	1/4HEX-H5.0X50	CA5010
R220.29-8200-8250M	-	H6B-T20PL	C05018-T20P	SRP2004M0	H6B-H5.0L	CA5010

Accessories

For cutter	Adjustable Torque key	Adjustable Torque key 2	Arbor screw	Insert clamping torque	Torque key
R217.29-..	-	-	-	5.0NM	T00-20P50
R220.29-0063-0125	-	-	-	5.0NM	T00-20P50
R220.29-8160	1/4HEX-S-HANDLE-0.8-5.0NM	1/4HEX-T-HANDLE-5.0-14.0NM	MC6S12X40	5.0NM	T00-20P50
R220.29-8200-8250	-	-	MC6S16X50	5.0NM	T00-20P50

Torque and fixed keys, see page 894

Square shoulder and slot milling cutters
Helical milling cutters
Face milling cutters
Disc milling cutters
High feed milling cutters
Copy milling cutters
Plunge milling cutters
Chamfer milling cutters
Spot facing cutters
Inserts

R220.29-10 – inch

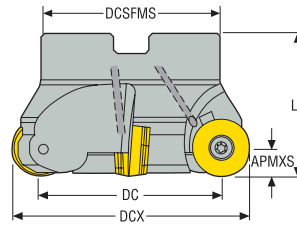

- For insert selection and cutting data recommendations, see page(s) 663-665
- For complete insert programme, see page(s) 842
- For ISO attribute explanation, see page 16

Designation	Item number	Type of mounting	DC	DCX	ZEFP	APMXS	DCB	TDZ	DCSFMS	LF	RMPX°	C min	C max	RPMX	Weight	Insert
			inch	inch		inch	inch		inch	inch		inch	inch		lbs	
R220.29-02.50-10.4A	00087697	Arbor	1.713	2.500	4	0.394	0.750	–	1.850	2.000	6,0	4.213	4.921	5800	1.320	RP.2006
R220.29-03.00-10.4A	00087698	Arbor	2.213	3.000	4	0.394	1.000	–	2.441	2.000	5,0	5.213	5.921	5100	2.200	RP.2006

For Combimaster Shanks, see Machining Navigator Tooling System

Spare Parts, included in delivery

For cutter	Arbor screw	Insert key	Insert screw	Insert shim	Shim key	Shim screw
R220.29-02.50						
	UC6S3/8UNFX11/2	H6B-T20P	C05013-T20P	–	–	–
R220.29-03.00						
	UC6S1/2UNFX1-1/4	H6B-T20P	C05018-T20P	SRP2004M0	H6B-H5.0L	CA5010

Accessories

For cutter	Insert clamping torque	Torque key
R220.29-..	44.3IN.LBS	T00-20P50

Torque and fixed keys, see page 894

R217/220.29-10 – Insert selection – mm/Inch

SMG		a _p	f _z			
			100%	70%	30%	10%
P1	RPHT2006M0T-ME12 MP2501	4,0	0,38	0,38	0,38	0,55
		0.16	0.015	0.015	0.015	0.022
P2	RPHT2006M0T-ME12 MP2501	4,0	0,38	0,38	0,38	0,55
		0.16	0.015	0.015	0.015	0.022
P3	RPHT2006M0T-ME12 MP2501	4,0	0,36	0,36	0,36	0,55
		0.16	0.014	0.014	0.014	0.022
P4	RPKT2006M0T-M15 MP2501	4,0	0,44	0,44	0,44	0,65
		0.16	0.017	0.017	0.017	0.026
P5	RPKT2006M0T-M15 MP2501	4,0	0,44	0,44	0,44	0,65
		0.16	0.017	0.017	0.017	0.026
P6	RPKT2006M0T-M20 MS2500	4,0	0,44	0,44	0,42	0,65
		0.16	0.017	0.017	0.017	0.026
P7	RPKT2006M0T-M20 MS2500	4,0	0,44	0,44	0,42	0,65
		0.16	0.017	0.017	0.017	0.026
P8	RPKT2006M0T-M20 MS2500	4,0	0,46	0,46	0,44	0,65
		0.16	0.018	0.018	0.017	0.026
P11	RPKT2006M0T-M20 MS2500	4,0	0,44	0,44	0,42	0,65
		0.16	0.017	0.017	0.017	0.026
P12	RPKT2006M0T-M20 MS2500	3,0	0,34	0,34	0,34	0,44
		0.12	0.013	0.013	0.013	0.017
M1	RPHT2006M0T-ME12 MS2050	4,0	0,38	0,38	0,38	0,55
		0.16	0.015	0.015	0.015	0.022
M2	RPHT2006M0T-ME12 MS2050	4,0	0,34	0,34	0,34	0,50
		0.16	0.013	0.013	0.013	0.020
M3	RPHT2006M0T-ME12 MS2050	3,0	0,32	0,32	0,32	0,42
		0.12	0.013	0.013	0.013	0.017
M4	RPHT2006M0T-ME12 T350M	2,5	0,30	0,30	0,32	0,36
		0.10	0.012	0.012	0.013	0.014
M5	RPHT2006M0T-ME12 T350M	2,5	0,30	0,30	0,32	0,36
		0.10	0.012	0.012	0.013	0.014
K1	RPKT2006M0T-M20 MK2050	4,0	0,48	0,48	0,48	0,70
		0.16	0.019	0.019	0.019	0.028
K2	RPKT2006M0T-M20 MK2050	4,0	0,44	0,44	0,44	0,65
		0.16	0.017	0.017	0.017	0.026
K3	RPKT2006M0T-M20 MK2050	4,0	0,44	0,44	0,44	0,65
		0.16	0.017	0.017	0.017	0.026
K4	RPKT2006M0T-M20 MK2050	4,0	0,44	0,44	0,44	0,65
		0.16	0.017	0.017	0.017	0.026
K5	RPKT2006M0T-M20 MK2050	4,0	0,40	0,40	0,38	0,60
		0.16	0.016	0.016	0.015	0.024
K6	RPKT2006M0T-M20 MK2050	4,0	0,44	0,44	0,44	0,65
		0.16	0.017	0.017	0.017	0.026
K7	RPKT2006M0T-M20 MK2050	4,0	0,40	0,40	0,38	0,60
		0.16	0.016	0.016	0.015	0.024
S1	RPHT2006M0T-ME12 MS2500	2,5	0,30	0,30	0,32	0,36
		0.10	0.012	0.012	0.013	0.014
S2	RPHT2006M0T-ME12 MS2500	2,5	0,30	0,30	0,32	0,36
		0.10	0.012	0.012	0.013	0.014
S3	RPKT2006M0T-M15 MS2500	2,5	0,36	0,36	0,36	0,42
		0.10	0.014	0.014	0.014	0.017
S11	RPHT2006M0T-ME12 MS2050	3,0	0,32	0,32	0,34	0,42
		0.12	0.013	0.013	0.013	0.017
S12	RPHT2006M0T-ME12 MS2050	3,0	0,32	0,32	0,34	0,42
		0.12	0.013	0.013	0.013	0.017
S13	RPHT2006M0T-ME12 MS2050	2,5	0,30	0,30	0,32	0,36
		0.10	0.012	0.012	0.013	0.014
H5	RPKW2006M0T-MD22 F15M	3,0	0,50	0,50	0,50	0,65
		0.12	0.020	0.020	0.020	0.026
H8	RPKW2006M0T-MD22 F15M	3,0	0,38	0,38	0,40	0,50
		0.12	0.015	0.015	0.016	0.020
H11	RPKW2006M0T-MD22 F15M	3,0	0,50	0,50	0,50	0,65
		0.12	0.020	0.020	0.020	0.026
H12	RPKT2006M0T-M15 T350M	3,0	0,26	0,26	0,28	0,34
		0.12	0.010	0.010	0.011	0.013
H21	RPKW2006M0T-MD22 F15M	3,0	0,38	0,38	0,40	0,50
		0.12	0.015	0.015	0.016	0.020

SMG = Seco material group
f_z = mm/tooth (in/tooth), v_c = m/min (sf/min), a_p/DC = %
All cutting data are start values

Square shoulder and slot milling cutters
Helical milling cutters
Face milling cutters
Disc milling cutters
High feed milling cutters
Copy milling cutters
Plunge milling cutters
Chamfer milling cutters
Spot facing cutters
Inserts

R217/220.29-10 – Cutting data $v_c = (m/min)/(sf/min)$

SMG	MP1501				MP2050				MP2501				T350M				F15M				F30M			
	100%	70%	30%	10%	100%	70%	30%	10%	100%	70%	30%	10%	100%	70%	30%	10%	100%	70%	30%	10%	100%	70%	30%	10%
P1	280	330	405	465	290	340	405	480	250	290	360	415	265	310	375	440	—	—	—	—	225	260	310	370
	920	1075	1325	1525	950	1125	1325	1575	820	950	1175	1350	870	1025	1225	1450	—	—	—	—	740	850	1025	1225
P2	275	320	385	455	285	330	395	470	240	285	340	400	260	305	365	430	—	—	—	—	215	255	305	355
	900	1050	1275	1500	940	1075	1300	1550	790	940	1125	1300	850	1000	1200	1400	—	—	—	—	710	840	1000	1175
P3	240	280	340	400	250	290	345	405	215	250	300	350	225	265	320	370	—	—	—	—	190	225	265	310
	790	920	1125	1300	820	950	1125	1325	710	820	980	1150	740	870	1050	1225	—	—	—	—	620	740	870	1025
P4	215	250	300	350	220	255	305	355	190	220	265	310	200	235	280	325	—	—	—	—	170	195	235	275
	710	820	980	1150	720	840	1000	1175	620	720	870	1025	660	770	920	1075	—	—	—	—	560	640	770	900
P5	205	235	285	340	210	250	295	350	180	210	255	300	195	225	270	320	—	—	—	—	160	185	225	265
	670	770	940	1125	690	820	970	1150	590	690	840	980	640	740	890	1050	—	—	—	—	520	610	740	870
P6	235	275	330	385	240	280	330	390	210	245	290	340	220	255	305	360	—	—	—	—	185	215	255	300
	770	900	1075	1275	790	920	1075	1275	690	800	950	1125	720	840	1000	1175	—	—	—	—	610	710	840	980
P7	220	260	310	360	225	265	315	370	195	230	275	320	205	240	290	340	—	—	—	—	175	200	240	280
	720	850	1025	1175	740	870	1025	1225	640	750	900	1050	670	790	950	1125	—	—	—	—	570	660	790	920
P8	205	235	285	335	210	245	290	340	180	210	255	295	190	225	265	310	—	—	—	—	160	185	225	260
	670	770	940	1100	690	800	950	1125	590	690	840	970	620	740	870	1025	—	—	—	—	520	610	740	850
P11	215	250	300	350	220	255	305	360	190	225	270	310	200	235	280	330	—	—	—	—	170	195	235	275
	710	820	980	1150	720	840	1000	1175	620	740	890	1025	660	770	920	1075	—	—	—	—	560	640	770	900
P12	140	165	200	230	140	165	200	235	125	145	175	205	130	150	185	215	—	—	—	—	110	130	150	175
	460	540	660	750	460	540	660	770	410	475	570	670	425	490	610	710	—	—	—	—	360	425	490	570
M1	—	—	—	—	205	235	285	335	175	205	245	290	200	235	280	330	—	—	—	—	175	205	245	285
	—	—	—	—	670	770	940	1100	570	670	800	950	660	770	920	1075	—	—	—	—	570	670	800	940
M2	—	—	—	—	170	200	235	280	145	170	205	245	165	195	235	275	—	—	—	—	145	170	205	240
	—	—	—	—	560	660	770	920	475	560	670	800	540	640	770	900	—	—	—	—	475	560	670	790
M3	—	—	—	—	135	160	190	220	120	140	165	195	135	155	185	220	—	—	—	—	120	140	165	190
	—	—	—	—	445	520	620	720	395	460	540	640	445	510	610	720	—	—	—	—	395	460	540	620
M4	—	—	—	—	105	125	145	175	95	110	130	155	105	120	145	170	—	—	—	—	90	105	125	150
	—	—	—	—	345	410	475	570	310	360	425	510	345	395	475	560	—	—	—	—	295	345	410	490
M5	—	—	—	—	90	105	120	145	80	90	110	130	90	100	120	145	—	—	—	—	75	90	105	125
	—	—	—	—	295	345	395	475	260	295	360	425	295	330	395	475	—	—	—	—	245	295	345	410
K1	215	255	305	360	225	260	315	370	190	225	270	320	—	—	—	—	150	180	215	250	170	200	240	280
	710	840	1000	1175	740	850	1025	1225	620	740	890	1050	—	—	—	—	490	590	710	820	560	660	790	920
K2	195	225	270	325	200	235	280	330	170	200	240	285	—	—	—	—	135	160	190	225	150	180	215	250
	640	740	890	1075	660	770	920	1075	560	660	790	940	—	—	—	—	445	520	620	740	490	590	710	820
K3	165	190	230	275	170	200	240	280	145	170	205	240	—	—	—	—	115	135	160	190	130	150	180	215
	540	620	750	900	560	660	790	920	475	560	670	790	—	—	—	—	375	445	520	620	425	490	590	710
K4	155	180	220	260	160	190	225	265	140	160	195	230	—	—	—	—	110	130	155	180	125	145	175	205
	510	590	720	850	520	620	740	870	460	520	640	750	—	—	—	—	360	425	510	590	410	475	570	670
K5	100	115	140	160	100	115	135	165	85	100	120	140	—	—	—	—	70	80	95	110	75	90	105	125
	330	375	460	520	330	375	445	540	280	330	395	460	—	—	—	—	230	260	310	360	245	295	345	410
K6	135	160	195	230	145	165	200	235	120	140	170	205	—	—	—	—	95	115	135	160	110	125	155	180
	445	520	640	750	475	540	660	770	395	460	560	670	—	—	—	—	310	375	445	520	360	410	510	590
K7	125	145	175	205	125	145	175	210	110	130	155	180	—	—	—	—	90	105	125	145	95	115	135	160
	410	475	570	670	410	475	570	690	360	425	510	590	—	—	—	—	295	345	410	475	310	375	445	520
S1	—	—	—	—	50	60	70	85	46	55	65	75	49	55	65	80	—	—	—	—	43	49	60	70
	—	—	—	—	165	195	230	280	150	180	215	245	160	180	215	260	—	—	—	—	140	160	195	230
S2	—	—	—	—	42	49	60	70	37	43	50	60	40	46	55	65	—	—	—	—	34	40	47	55
	—	—	—	—	140	160	195	230	120	140	165	195	130	150	180	215	—	—	—	—	110	130	155	180
S3	—	—	—	—	37	43	50	60	32	37	45	55	35	40	48	55	—	—	—	—	30	35	42	49
	—	—	—	—	120	140	165	195	105	120	150	180	115	130	155	180	—	—	—	—	100	115	140	160
S11	—	—	—	—	75	85	100	120	65	75	90	105	70	80	95	110	—	—	—	—	60	70	80	95
	—	—	—	—	245	280	330	395	215	245	295	345	230	260	310	360	—	—	—	—	195	230	260	310
S12	—	—	—	—	50	60	70	80	43	50	60	70	47	55	65	75	—	—	—	—	35	40	48	55
	—	—	—	—	165	195	230	260	140	165	195	230	155	180	215	245	—	—	—	—	115	130	155	180
S13	—	—	—	—	29	34	40	48	26	30	36	42	28	32	38	45	—	—	—	—	20	23	28	32
	—	—	—	—	95	110	130	155	85	100	120	140	90	105	125	150	—	—	—	—	65	75	90	105
H5	47	55	65	75	42	49	60	70	38	44	55	60	43	50	60	70	33	38	46	55	36	42	50	60
	155	180	215	245	140	160	195	230	125	145	180	195	140	165	195	230	110	125	150	180	120	140	165	195
H8	50	60	70	85	46	55	65	75	41	48	55	65	47	55	65	75	36	42	50	60	39	45	55	60
	165	195	230	280	150	180	215	245	135	155	180	215	155	180	215	245	120	140	165	195	130	150	180	195
H11	60	70	85	95	55	65	75	90	48	55	70	80	55	65	75	90	42	49	60	70	46	55	65	75
	195	230	280	310	180																			

R217/220.29-10 – Cutting data $v_c = (m/min)/(sf/min)$

SMG	F40M				MK2050				MM4500				MS2050				MS2500			
	100%	70%	30%	10%	100%	70%	30%	10%	100%	70%	30%	10%	100%	70%	30%	10%	100%	70%	30%	10%
P1	230	270	325	385	270	315	385	450	190	220	265	310	255	300	355	420	335	390	465	550
	750	890	1075	1275	890	1025	1275	1475	620	720	870	1025	840	980	1175	1375	1100	1275	1525	1800
P2	225	265	315	375	265	310	370	435	185	215	255	305	250	290	345	410	325	380	455	540
	740	870	1025	1225	870	1025	1225	1425	610	710	840	1000	820	950	1125	1350	1075	1250	1500	1775
P3	200	230	275	320	230	270	325	385	160	185	225	260	215	255	305	355	285	335	400	465
	660	750	900	1050	750	890	1075	1275	520	610	740	850	710	840	1000	1175	940	1100	1300	1525
P4	175	205	245	285	205	240	290	340	140	165	195	230	190	225	265	310	250	295	350	410
	570	670	800	940	670	790	950	1125	460	540	640	750	620	740	870	1025	820	970	1150	1350
P5	170	200	235	280	195	230	275	325	135	160	190	225	185	220	260	305	245	285	340	400
	560	660	770	920	640	750	900	1075	445	520	620	740	610	720	850	1000	800	940	1125	1300
P6	190	220	265	310	220	260	315	365	155	180	215	255	210	245	290	345	275	320	380	450
	620	720	870	1025	720	850	1025	1200	510	590	710	840	690	800	950	1125	900	1050	1250	1475
P7	180	210	250	295	210	245	295	345	145	170	205	240	195	230	275	325	260	300	360	425
	590	690	820	970	690	800	970	1125	475	560	670	790	640	750	900	1075	850	980	1175	1400
P8	165	195	230	270	195	225	275	325	135	160	190	220	185	215	255	295	240	280	335	390
	540	640	750	890	640	740	900	1075	445	520	620	720	610	710	840	970	790	920	1100	1275
P11	175	205	245	285	200	235	285	335	140	165	195	230	190	225	265	315	250	295	350	410
	570	670	800	940	660	770	940	1100	460	540	640	750	620	740	870	1025	820	970	1150	1350
P12	115	130	160	185	135	155	185	220	90	105	130	150	125	145	175	205	165	190	230	270
	375	425	520	610	445	510	610	720	295	345	425	490	410	475	570	670	540	620	750	890
M1	180	215	255	300	—	—	—	—	155	185	220	260	200	235	280	330	235	275	325	385
	590	710	840	980	—	—	—	—	510	610	720	850	660	770	920	1075	770	900	1075	1275
M2	150	180	210	250	—	—	—	—	130	155	185	215	165	195	235	275	195	230	270	320
	490	590	690	820	—	—	—	—	425	510	610	710	540	640	770	900	640	750	890	1050
M3	125	145	170	200	—	—	—	—	105	125	145	170	135	155	185	220	155	185	220	255
	410	475	560	660	—	—	—	—	345	410	475	560	445	510	610	720	510	610	720	840
M4	95	110	130	155	—	—	—	—	85	95	115	135	105	120	145	170	125	140	170	200
	310	360	425	510	—	—	—	—	280	310	375	445	345	395	475	560	410	460	560	660
M5	80	95	110	130	—	—	—	—	70	80	95	110	90	100	120	145	105	120	140	165
	260	310	360	425	—	—	—	—	230	260	310	360	295	330	395	475	345	395	460	540
K1	180	210	250	295	285	335	400	470	—	—	—	—	—	—	—	—	—	—	—	—
	590	690	820	970	940	1100	1300	1550	—	—	—	—	—	—	—	—	—	—	—	—
K2	160	190	225	265	255	295	355	420	—	—	—	—	—	—	—	—	—	—	—	—
	520	620	740	870	840	970	1175	1375	—	—	—	—	—	—	—	—	—	—	—	—
K3	135	160	190	225	215	250	300	355	—	—	—	—	—	—	—	—	—	—	—	—
	445	520	620	740	710	820	980	1175	—	—	—	—	—	—	—	—	—	—	—	—
K4	130	150	180	215	205	240	285	340	—	—	—	—	—	—	—	—	—	—	—	—
	425	490	590	710	670	790	940	1125	—	—	—	—	—	—	—	—	—	—	—	—
K5	80	90	110	130	125	145	180	205	—	—	—	—	—	—	—	—	—	—	—	—
	260	295	360	425	410	475	590	670	—	—	—	—	—	—	—	—	—	—	—	—
K6	115	135	160	190	180	210	255	295	—	—	—	—	—	—	—	—	—	—	—	—
	375	445	520	620	590	690	840	970	—	—	—	—	—	—	—	—	—	—	—	—
K7	100	120	140	165	160	190	230	265	—	—	—	—	—	—	—	—	—	—	—	—
	330	395	460	540	520	620	750	870	—	—	—	—	—	—	—	—	—	—	—	—
S1	45	50	60	75	—	—	—	—	25	29	35	41	49	55	65	80	60	70	80	95
	150	165	195	245	—	—	—	—	80	95	115	135	160	180	215	260	195	230	260	310
S2	36	42	49	60	—	—	—	—	20	24	28	33	40	46	55	65	48	55	65	80
	120	140	160	195	—	—	—	—	65	80	90	110	130	150	180	215	155	180	215	260
S3	32	37	44	50	—	—	—	—	18	21	25	29	35	40	48	55	43	49	60	70
	105	120	145	165	—	—	—	—	60	70	80	95	115	130	155	180	140	160	195	230
S11	60	70	85	100	—	—	—	—	35	41	49	55	70	80	95	110	85	95	115	135
	195	230	280	330	—	—	—	—	115	135	160	180	230	260	310	360	280	310	375	445
S12	43	50	60	70	—	—	—	—	32	38	45	55	47	55	65	75	60	65	80	95
	140	165	195	230	—	—	—	—	105	125	150	180	155	180	215	245	195	215	260	310
S13	25	29	34	41	—	—	—	—	19	22	26	31	28	32	38	45	34	39	46	55
	80	95	110	135	—	—	—	—	60	70	85	100	90	105	125	150	110	130	150	180
H5	38	44	55	60	—	—	—	—	—	—	—	—	—	—	—	—	—	—	—	—
	125	145	180	195	—	—	—	—	—	—	—	—	—	—	—	—	—	—	—	—
H8	41	48	55	65	—	—	—	—	—	—	—	—	—	—	—	—	—	—	—	—
	135	155	180	215	—	—	—	—	—	—	—	—	—	—	—	—	—	—	—	—
H11	48	55	65	80	—	—	—	—	—	—	—	—	—	—	—	—	—	—	—	—
	155	180	215	260	—	—	—	—	—	—	—	—	—	—	—	—	—	—	—	—
H12	75	85	100	120	—	—	—	—	—	—	—	—	—	—	—	—	—	—	—	—
	245	280	330	395	—	—	—	—	—	—	—	—	—	—	—	—	—	—	—	—
H21	41	48	55	65	—	—	—	—	—	—	—	—	—	—	—	—	—	—	—	—
	135	155	180	215	—	—	—	—	—	—	—	—	—	—	—	—	—	—	—	—

Square shoulder and slot milling cutters
Helical milling cutters
Face milling cutters
Disc milling cutters
High feed milling cutters
Copy milling cutters
Plunge milling cutters
Chamfer milling cutters
Spot facing cutters
Inserts



R217/220.28 ROUND INSERT CUTTERS

Our range of double-sided round inserts in size 12 and cutters, R217/220.28, is ideal for light copy milling applications, face milling, slot milling and side milling in all workpiece materials.

- Cutter range 32-100 mm (1.25 - 4 inch)
- Max depth of cut 6 mm (.236 inch)
- Recommended slotting depth of cut 3 mm (.118 inch)
- Up to 16 cutting edges

Square shoulder and slot milling cutters
Helical milling cutters
Face milling cutters
Disc milling cutters
High feed milling cutters
Copy milling cutters
Plunge milling cutters
Chamfer milling cutters
Spot facing cutters
Inserts

R217.28-06 – inch

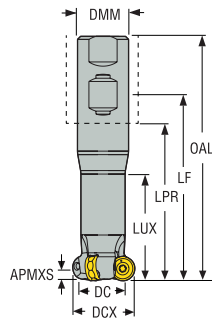

- For insert selection and cutting data recommendations, see page(s) 670-671
- For complete insert programme, see page(s) 840
- For ISO attribute explanation, see page 16

Designation	Item number	Type of mounting	DC	DCX	ZEFP	APMXS	DMM	LS	OAL	LUX	RMPX°	C min	C max	RPMX	Weight	Insert
			inch	inch		inch	inch	inch	inch	inch		inch	inch		lbs	
R217.28-01.25-3-06-3A	03092089	Weldon	0.780	1.250	3	0.236	1.000	2.280	4.783	2.578	0,4	2.030	2.421	15600	0.880	RNMU12..

Spare Parts, included in delivery

For cutter	Insert key	Insert screw
R217.28-..	H4B-T15P	C04009-T15P

Accessories

For cutter	Insert clamping torque	Torque key
R217.28-..	31.0IN.LBS	T00-15P35

Torque and fixed keys, see page 894

Square shoulder and slot milling cutters

Helical milling cutters

Face milling cutters

Disc milling cutters

High feed milling cutters

Copy milling cutters

Plunge milling cutters

Chamfer milling cutters

Spot facing cutters

Inserts

R220.28-06 – Metric

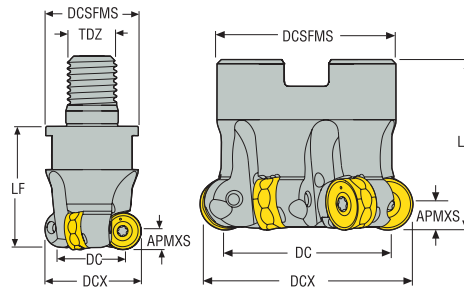

- For insert selection and cutting data recommendations, see page(s) 670-671
- For complete insert programme, see page(s) 840
- For ISO attribute explanation, see page 16

Designation	Item number	Type of mounting	DC	DCX	ZEFP	APMXS	DCB	TDZ	DCSFMS	LF	RMPX°	Cmin	Cmax	RPMX	Weight	Insert
			mm	mm		mm	mm		mm	mm		mm	mm		kg	
R217.28-1632.RE-06.3A	03092078	Combimaster	20,1	32,0	3	6,0	–	M16	30,0	40,0	0,4	52,1	62,0	15600	0,2	RNMU12..
R217.28-2040.RE-06.4A	03092079	Combimaster	28,0	40,0	4	6,0	–	M20	36,5	45,0	0,54	68,0	78,0	14000	0,4	RNMU12..
R220.28-0040-06.4A	03092080	Arbor	28,0	40,0	4	6,0	16,0	–	35,0	40,0	0,54	68,0	78,0	14000	0,2	RNMU12..
R220.28-0050-06.5A	03092081	Arbor	38,0	50,0	5	6,0	22,0	–	42,0	40,0	0,62	88,0	98,0	12500	0,3	RNMU12..
R220.28-0050-06.6A	03092082	Arbor	38,0	50,0	6	6,0	22,0	–	42,0	40,0	0,62	88,0	98,0	12500	0,3	RNMU12..
R220.28-0052-06.5A	03092083	Arbor	40,0	52,0	5	6,0	22,0	–	47,0	40,0	0,6	92,0	102,0	12300	0,4	RNMU12..
R220.28-0063-06.6A	03092084	Arbor	51,0	63,0	6	6,0	22,0	–	47,0	40,0	0,47	114,0	124,0	11200	0,4	RNMU12..
R220.28-0063-06.8A	03092086	Arbor	51,0	63,0	8	6,0	22,0	–	47,0	40,0	0,47	114,0	124,0	10000	0,5	RNMU12..
R220.28-0066-06.7A	03092087	Arbor	54,0	66,0	7	6,0	27,0	–	62,0	50,0	0,45	120,0	130,0	10900	0,8	RNMU12..
R220.28-0080-06.8A	03092088	Arbor	67,9	80,0	8	6,0	27,0	–	62,0	50,0	0,53	147,9	158,0	10000	1,0	RNMU12..

Spare Parts, included in delivery

For cutter	Arbor screw	Insert key	Insert screw
R217.28-..	–	H4B-T15P	C04009-T15P
R220.28-0040-0063	220.17-692	H4B-T15P	C04009-T15P
R220.28-0066	MC6S12X40	H4B-T15P	C04009-T15P
R220.28-0080	MC6S12X40	H4B-T15P	C04009-T15P

Accessories

For cutter	Insert clamping torque	Torque key
R217/220.28-..	3.5NM	T00-15P35

Torque and fixed keys, see page 894

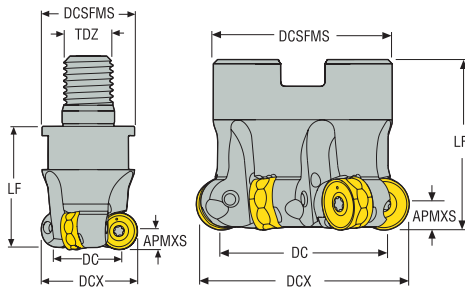

R220.28-06 – inch



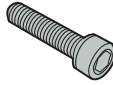

- For insert selection and cutting data recommendations, see page(s) 670-671
- For complete insert programme, see page(s) 840
- For ISO attribute explanation, see page 16

Designation	Item number	Type of mounting	DC	DCX	ZEFP	APMXS	DCB	TDZ	DCSFMS	LF	RMPX°	C min	C max	RPMX	Weight	Insert
			inch	inch		inch	inch		inch	inch		inch	inch		lbs	
R220.28-02.00-06-5A	03092092	Arbor	1.528	2.000	5	0.236	0.750	–	1.654	1.500	0,61	3.528	3.921	12500	0.660	RNMU12..
R220.28-02.00-06-6A	03092093	Arbor	1.528	2.000	6	0.236	0.750	–	1.654	1.500	0,61	3.528	3.921	12500	0.660	RNMU12..
R220.28-02.50-06-7A	03092094	Arbor	2.028	2.500	7	0.236	0.750	–	1.850	1.500	0,47	4.528	4.921	11200	1.100	RNMU12..
R220.28-04.00-06-12A	03137204	Arbor	3.528	4.000	12	0.236	1.500	–	3.543	2.000	0,11	7.528	7.921	8800	3.970	RNMU12..

Spare Parts, included in delivery

For cutter	Arbor screw	Insert key	Insert screw
R220.28-02.00-02.50	 UC6S3/8UNFX1-1/4	 H4B-T15P	 C04009-T15P
R220.28-04.00	ULC6S3/4UNFX11/2	H4B-T15PL	C04009-T15P

Accessories

For cutter	Insert clamping torque	Torque key
R220.28-..	 31.0IN.LBS	 T00-15P35

Torque and fixed keys, see page 894

Square shoulder and slot milling cutters

Helical milling cutters

Face milling cutters

Disc milling cutters

High feed milling cutters

Copy milling cutters

Plunge milling cutters

Chamfer milling cutters

Spot facing cutters

Inserts

R217/220.28 – Insert selection – mm/Inch

SMG		a _p	f _z			
			100%	70%	30%	10%
P1	RNMU1204M0-ME10 T350M	2,5	0,30	0,30	0,30	0,44
		0.10	0.012	0.012	0.012	0.017
P2	RNMU1204M0-ME10 T350M	2,5	0,32	0,32	0,30	0,44
		0.10	0.013	0.013	0.012	0.017
P3	RNMU1204M0-ME10 T350M	2,5	0,30	0,30	0,28	0,42
		0.10	0.012	0.012	0.011	0.017
P4	RNMU1204M0T-M10 MP2501	2,5	0,28	0,28	0,28	0,42
		0.10	0.011	0.011	0.011	0.017
P5	RNMU1204M0T-M10 MP2501	2,5	0,28	0,28	0,28	0,40
		0.10	0.011	0.011	0.011	0.016
P6	RNMU1204M0T-M10 MP2501	2,5	0,28	0,28	0,28	0,40
		0.10	0.011	0.011	0.011	0.016
P7	RNMU1204M0T-M10 MP2501	2,5	0,28	0,28	0,28	0,40
		0.10	0.011	0.011	0.011	0.016
P8	RNMU1204M0T-M10 MP2050	2,5	0,30	0,30	0,28	0,42
		0.10	0.012	0.012	0.011	0.017
P11	RNMU1204M0T-M10 MP2050	2,5	0,28	0,28	0,28	0,40
		0.10	0.011	0.011	0.011	0.016
P12	RNMU1204M0T-M10 MS2500	1,9	0,22	0,22	0,22	0,28
		0.075	0.0085	0.0085	0.0085	0.011
M1	RNMU1204M0-ME10 T350M	2,5	0,32	0,32	0,30	0,44
		0.10	0.013	0.013	0.012	0.017
M2	RNMU1204M0-ME10 T350M	2,5	0,28	0,28	0,28	0,40
		0.10	0.011	0.011	0.011	0.016
M3	RNMU1204M0-ME10 T350M	1,9	0,26	0,26	0,26	0,32
		0.075	0.010	0.010	0.010	0.013
M4	RNMU1204M0T-M10 T350M	1,4	0,26	0,26	0,25	0,28
		0.055	0.010	0.010	0.010	0.011
M5	RNMU1204M0T-M10 T350M	1,4	0,26	0,26	0,25	0,28
		0.055	0.010	0.010	0.010	0.011
K1	RNMU1204M0T-M10 MK2050	2,5	0,32	0,32	0,30	0,44
		0.10	0.013	0.013	0.012	0.017
K2	RNMU1204M0T-M10 MK2050	2,5	0,28	0,28	0,28	0,40
		0.10	0.011	0.011	0.011	0.016
K3	RNMU1204M0T-M10 MK2050	2,5	0,28	0,28	0,28	0,40
		0.10	0.011	0.011	0.011	0.016
K4	RNMU1204M0T-M10 MK2050	2,5	0,28	0,28	0,28	0,40
		0.10	0.011	0.011	0.011	0.016
K5	RNMU1204M0T-M10 MK2050	2,5	0,25	0,25	0,25	0,36
		0.10	0.010	0.010	0.010	0.014
K6	RNMU1204M0T-M10 MK2050	2,5	0,28	0,28	0,28	0,40
		0.10	0.011	0.011	0.011	0.016
K7	RNMU1204M0T-M10 MK2050	2,5	0,25	0,25	0,25	0,36
		0.10	0.010	0.010	0.010	0.014
N1	RNMU1204M0-ME10 F40M	2,5	0,40	0,40	0,38	0,55
		0.10	0.016	0.016	0.015	0.022
N2	RNMU1204M0-ME10 F40M	2,5	0,40	0,40	0,38	0,55
		0.10	0.016	0.016	0.015	0.022
N3	RNMU1204M0-ME10 F40M	2,5	0,40	0,40	0,38	0,55
		0.10	0.016	0.016	0.015	0.022
N11	RNMU1204M0-ME10 F40M	2,5	0,40	0,40	0,38	0,55
		0.10	0.016	0.016	0.015	0.022
S1	RNMU1204M0T-M10 MS2500	1,4	0,26	0,26	0,25	0,28
		0.055	0.010	0.010	0.010	0.011
S2	RNMU1204M0T-M10 MS2500	1,4	0,26	0,26	0,25	0,28
		0.055	0.010	0.010	0.010	0.011
S3	RNMU1204M0T-M10 MS2500	1,4	0,24	0,24	0,24	0,26
		0.055	0.0095	0.0095	0.0095	0.010
S11	RNMU1204M0T-M10 MS2050	1,7	0,28	0,28	0,26	0,32
		0.065	0.011	0.011	0.010	0.013
S12	RNMU1204M0T-M10 MS2050	1,7	0,28	0,28	0,26	0,32
		0.065	0.011	0.011	0.010	0.013
S13	RNMU1204M0T-M10 MS2050	1,4	0,26	0,26	0,25	0,28
		0.055	0.010	0.010	0.010	0.011
H5	RNMU1204M0T-M10 MP2501	1,9	0,22	0,22	0,22	0,28
		0.075	0.0085	0.0085	0.0085	0.011
H8	RNMU1204M0T-M10 MP2501	1,7	0,18	0,18	0,17	0,22
		0.065	0.0070	0.0070	0.0065	0.0085
H11	RNMU1204M0T-M10 MP2501	1,9	0,22	0,22	0,22	0,28
		0.075	0.0085	0.0085	0.0085	0.011
H12	RNMU1204M0T-M10 MP2501	1,7	0,18	0,18	0,17	0,22
		0.065	0.0070	0.0070	0.0065	0.0085
H21	RNMU1204M0T-M10 MP2501	1,7	0,18	0,18	0,17	0,22
		0.065	0.0070	0.0070	0.0065	0.0085

SMG = Seco material group
 f_z = mm/tooth (in/tooth), v_c = m/min (sf/min), a_p/DC = %
 All cutting data are start values



R218.20/19/24 BALLNOSE

We offer a variety of highly productive ballnose cutters for all materials and applications, ranging from general purpose to segment-oriented tools. The ballnose cutter is designed to deliver higher performance and better reliability in copy milling applications.

- Ballnose K=1, 3-cutting edge, cutter range 16-40 mm (0.75 - 1 inch)
- Ballnose K=2, 2-cutting edge, cutter range 12-50 mm (0.5 - 2 inch)
- Tapered Ballnose, 2-cutting edge, cutter range 16 mm

Square shoulder and slot milling cutters

Helical milling cutters

Face milling cutters

Disc milling cutters

High feed milling cutters

Copy milling cutters

Plunge milling cutters

Chamfer milling cutters

Spot facing cutters

Inserts

R218.20 – Metric

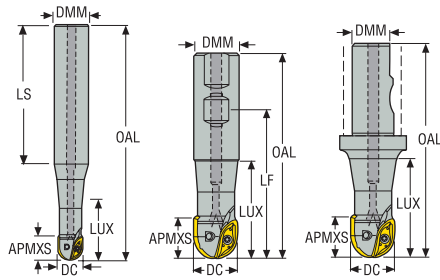

- For insert selection and cutting data recommendations, see page(s) 681-712
- For complete insert programme, see page(s) 860, 879
- For ISO attribute explanation, see page 16

Designation	Item number	Type of mounting	DC	ZEFP	APMXS	APMXE	DMM	LS	LF	OAL	LUX	RMPX°	RPMX	Weight	218.20	SPM.
			mm		mm	mm	mm	mm	mm	mm	mm			kg		
R218.20-1612.0-10.112A	02627903	Cylindrical	12,0	2	10,0	6,0	16,0	120,0	–	160,0	25,0	45,0	30000	0,3	-060(2)	–
R218.20-2016.0-14.070A	02722506	Cylindrical	16,0	2	14,0	8,0	20,0	70,0	–	120,0	36,0	45,0	28500	0,3	-080(2)	–
R218.20-1616.0-14.105E	00031596	Cylindrical	16,0	2	14,0	8,0	16,0	115,0	–	165,0	49,0	45,0	28500	0,5	-080(2)	–
R218.20-2520.0-18.120A	00031701	Cylindrical	20,0	2	18,0	10,0	25,0	104,0	–	176,0	54,0	45,0	20200	0,5	-100(2)	–
R218.20-3225.0-22.160A	00031940	Cylindrical	25,0	2	22,0	12,5	32,0	130,0	–	220,0	68,0	45,0	16900	1,1	-125(2)	–
R218.20-3230.0-26.160A	00032027	Cylindrical	30,0	2	27,0	15,0	32,0	130,0	–	220,0	73,0	45,0	12500	1,1	-150(2)	–
R218.20-3232.0-28.160A	00030730	Cylindrical	32,0	2	28,0	16,0	32,0	130,0	–	220,0	90,0	45,0	10900	1,2	-160(2)	–
R218.20-2520.3-18.070A	00031654	Weldon	20,0	2	18,0	10,0	25,0	56,0	93,94	126,0	54,0	45,0	20200	0,4	-100(2)	–
R218.20-2525.3-22.060A	00038464	Weldon	25,0	2	22,0	12,5	25,0	60,0	83,96	116,0	56,0	45,0	16900	0,4	-125(2)	–
R218.20-2525.3-22.080A	00031897	Weldon	25,0	2	22,0	12,5	25,0	60,0	103,96	136,0	75,5	45,0	16900	0,5	-125(2)	–
R218.20-3230.3-45.100A	00032046	Weldon	30,0	2	44,0	15,0	32,0	70,0	123,93	160,0	71,0	45,0	12500	0,8	-150(2)	SPMT10(2)
R218.20-3232.3-28.070A	00032245	Weldon	32,0	2	28,0	16,0	32,0	60,0	93,92	130,0	68,0	45,0	10900	0,7	-160(2)	–
R218.20-3232.3-28.100A	00030731	Weldon	32,0	2	28,0	16,0	32,0	70,0	123,92	160,0	89,0	45,0	10900	0,8	-160(2)	–
R218.20-3232.3-54.100A	00030733	Weldon	32,0	2	54,0	16,0	32,0	70,0	123,92	160,0	89,0	45,0	10900	0,8	-160(2)	SPMT10(3)

Square shoulder and slot milling cutters

Helical milling cutters

Face milling cutters

Disc milling cutters

High feed milling cutters

Copy milling cutters



Plunge milling cutters

Chamfer milling cutters





Spot facing cutters

Inserts

Spare Parts, included in delivery

For cutter	Insert key 	Insert screw centre 	Insert screw periph 
R218.20-1612	H4B-T06P	C01805-T06P	-
R218.20.. Ø16	H4B-T08P	C02506-T08P	-
R218.20.. Ø20	H4B-T09P	C03007-T09P	-
R218.20.. Ø25-30	H4B-T15P	C04009-T15P	-
R218.20.. Ø32	H4B-T15P	C04011-T15P	-
R218.20.. Ø30-100A	H4B-T15P	C04009-T15P	C03508-T15P
R218.20.. Ø32-100A	H4B-T15P	C04011-T15P	C03508-T15P

Accessories

For cutter	Insert clamping torque 	Insert clamping torque 2 	Torque key 	Torque key 2 
R218.20-1612	0.5NM	-	T00-06P05	-
R218.20.. Ø16	1.2NM	-	T00-08P12	-
R218.20.. Ø20	2.0NM	-	T00-09P20	-
R218.20.. Ø25-32	3.5NM	-	T00-15P35	-
R218.20.. Ø30-32-100A	3.5NM	3.0NM	T00-15P35	T00-15P30

Torque and fixed keys, see page 894

- Square shoulder and slot milling cutters
- Helical milling cutters
- Face milling cutters
- Disc milling cutters
- High feed milling cutters
- Copy milling cutters
- Plunge milling cutters
- Chamfer milling cutters
- Spot facing cutters
- Inserts

R218.20 – Metric

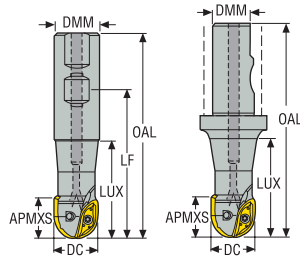

- For insert selection and cutting data recommendations, see page(s) 681-712
- For complete insert programme, see page(s) 843, 879
- For ISO attribute explanation, see page 16

Designation	Item number	Type of mounting	DC	ZEFP	APMXS	APMXE	DMM	LS	LF	OAL	LUX	RMPX°	RPMX	Weight	218.20	SCET
			mm		mm	mm	mm	mm	mm	mm	mm			kg		
R218.20-3240.3S-60.100	00032440	Seco-Weldon	40,0	2	60,0	20,0	32,0	59,5	–	159,4	89,0	45,0	7200	1,0	-200(2)	SC..12 (3)
R218.20-3250.3S-70.100	00032627	Seco-Weldon	50,0	2	70,0	25,0	32,0	59,5	–	159,37	91,0	45,0	3700	1,2	-250(2)	SC..12 (3)
R218.20-5050.3-70.150	00032677	Weldon	50,0	2	70,0	25,0	50,0	80,0	184,87	229,87	149,0	45,0	3700	2,9	-250(2)	SC..12 (3)

Spare Parts, included in delivery

For cutter	Insert key	Insert screw centre	Insert screw periph	Key periphery
R218.20.. Ø40	H6B-T20P	C05013-T20P	C45011-T20P	–
R218.20.. Ø50	H6B-T25P	C06018-T25P	C45011-T20P	H6B-T20P

Accessories

For cutter	Insert clamping torque	Torque key
R218.20.. Ø40	5.0NM	T00-20P50
R218.20.. Ø50	5.0NM	T00T-25P80

Torque and fixed keys, see page 894

Square shoulder and slot milling cutters

Helical milling cutters

Face milling cutters

Disc milling cutters

High feed milling cutters

Copy milling cutters

Plunge milling cutters

Chamfer milling cutters

Spot facing cutters

Inserts

R218.20 – inch

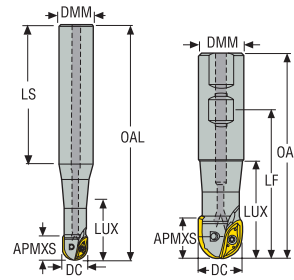

- For insert selection and cutting data recommendations, see page(s) 681-712
- For complete insert programme, see page(s) 860, 879
- For ISO attribute explanation, see page 16

Designation	Item number	Type of mounting	DC	ZEFP	APMXS	APMXE	DMM	LS	LF	OAL	LUX	RMPX ^o	RPMX	Weight	218.20
			inch		inch	inch	inch	inch	inch	inch	inch			lbs	
R218.20-0.500.0-11-111A	02687512	Cylindrical	0.500	2	0.433	0.250	0.625	4.724	–	6.298	1.142	45,0	30000	0.660	-0.250.R (2)
R218.20-0.625.0-14-070A	02740370	Cylindrical	0.625	2	0.551	0.313	0.750	2.819	–	4.785	1.398	45,0	28500	0.660	-080.R (2)
R218.20-0.750.0-17-120A	00040031	Cylindrical	0.750	2	0.669	0.375	1.000	4.248	–	7.002	2.087	45,0	20200	1.320	-0.375.R (2)
R218.20-01.00.0-22-160A	00040032	Cylindrical	1.000	2	0.866	0.500	1.250	4.996	–	8.577	2.795	45,0	16900	2.430	-125.R (2)
R218.20-0.500.3-11-060A	02687514	Weldon	0.500	2	0.433	0.250	0.750	2.362	3.313	4.331	0.827	45,0	30000	0.440	-0.250.R (2)
R218.20-0.625.3-14-050A	02740373	Weldon	0.625	2	0.551	0.313	0.625	2.299	2.919	3.874	1.500	45,0	28500	0.440	-080 (2)
R218.20-0.750.3-17-070A	00040022	Weldon	0.750	2	0.669	0.375	1.000	2.280	3.895	5.035	2.000	45,0	20200	1.100	-0.375.R (2)
R218.20-01.00.3-22-070A	00040024	Weldon	1.000	2	0.866	0.500	1.000	2.362	3.896	5.039	2.000	45,0	16900	1.100	-125.R (2)
R218.20-01.25.3-28-100A	00040025	Weldon	1.250	2	1.102	0.625	1.250	2.673	5.073	6.213	3.500	45,0	10900	1.760	-160.R (2)
R218.20-01.50.3-34-100A	00040027	Weldon	1.500	2	1.339	0.750	1.500	3.083	5.435	6.626	3.500	45,0	7200	2.650	-0.750.R (2)

Spare Parts, included in delivery

For cutter	Insert key	Insert screw
R218.20-0.500	H4B-T06P	C02052-T06P
R218.20-0.625	H4B-T08P	C02506-T08P
R218.20-0.750	H4B-T09P	C03006-T09P
R218.20-01.00	H4B-T15P	C04009-T15P
R218.20-01.25	H4B-T15P	C04011-T15P
R218.20-01.50	H6B-T20P	C05013-T20P

Accessories

For cutter	Insert clamping torque	Torque key
R218.20-0.500	0.5NM	T00-06P05
R218.20-0.625	1.2NM	T00-08P12
R218.20-0.750	2.0NM	T00-09P20
R218.20-01.00-01.25	3.5NM	T00-15P35
R218.20-01.50	5.0NM	T00-20P50

Torque and fixed keys, see page 894

R218.20 – inch

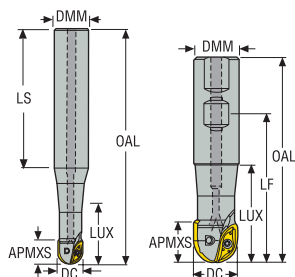

- For insert selection and cutting data recommendations, see page(s) 681-712
- For complete insert programme, see page(s) 843, 879
- For ISO attribute explanation, see page 16

Designation	Item number	Type of mounting	DC	ZEFP	APMXS	APMXE	DMM	LS	LF	OAL	LUX	RMPX°	RPMX	Weight	218.20	SCET
			inch		inch	inch	inch	inch	inch	inch	inch			lbs		
R218.20-02.00.3-70-120A	02740375	Weldon	2.000	2	2.756	1.000	2.000	3.243	6.124	7.967	4.705	45,0	3700	5.730	-250.R (2)	SC..12 (3)

Spare Parts, included in delivery

For cutter	Insert key	Insert screw centre	Insert screw periph	Key periphery
R218.20-02.00	H6B-T25P	C06018-T25P	C45011-T20P	H6B-T20P

Accessories

For cutter	Insert clamping torque	Torque key
R218.20-02.00	70.8IN.LBS	T00T-25P80

Torque and fixed keys, see page 894

Square shoulder and slot milling cutters

Helical milling cutters

Face milling cutters

Disc milling cutters

High feed milling cutters

Copy milling cutters

Plunge milling cutters

Chamfer milling cutters

Spot facing cutters

Inserts

R218.20 – Metric

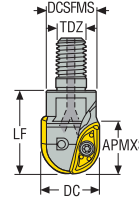



- For insert selection and cutting data recommendations, see page(s) 681-712
- For complete insert programme, see page(s) 879
- For ISO attribute explanation, see page 16



Designation	Item number	Type of mounting	DC	ZEFP	APMXS	APMXE	DCSFMS	TDZ	LF	RMPX°	RPMX	Weight	218.20
			mm		mm	mm	mm		mm			kg	
R218.20-0612.RE-10A	02731891	Combimaster	12,0	2	10,0	6,0	11,0	M6	20,0	45,0	30000	0,1	-060(2)
R218.20-0812.RE-10A	02627909	Combimaster	12,0	2	10,0	6,0	13,5	M8	23,0	45,0	30000	0,1	-060(2)
R218.20-0816.RE-14A	02742691	Combimaster	16,0	2	14,0	8,0	13,5	M8	23,0	45,0	28500	0,1	-080(2)
R218.20-1016.RE-14A	00031585	Combimaster	16,0	2	14,0	8,0	18,0	M10	28,0	45,0	28500	0,1	-080(2)
R218.20-1020.RE-18A	00039896	Combimaster	20,0	2	18,0	10,0	18,0	M10	28,0	45,0	20200	0,1	-100(2)
R218.20-1220.RE-18A	00031619	Combimaster	20,0	2	18,0	10,0	21,5	M12	35,0	45,0	20200	0,2	-100(2)
R218.20-1225.RE-22A	00031777	Combimaster	25,0	2	22,0	12,5	21,5	M12	35,0	45,0	16900	0,2	-125(2)
R218.20-1630.RE-26A	00032025	Combimaster	30,0	2	27,0	15,0	28,5	M16	40,0	45,0	12500	0,2	-150(2)
R218.20-1632.RE-28A	00030728	Combimaster	32,0	2	28,0	16,0	28,5	M16	40,0	45,0	10900	0,2	-160(2)
R218.20-1640.RE-35A	00032409	Combimaster	40,0	2	35,0	20,0	34,0	M16	50,0	45,0	7200	0,3	-200(2)
R218.20-2040.RE-35A	02928081	Combimaster	40,0	2	35,0	20,0	36,5	M20	55,0	45,0	7200	0,3	-200(2)
R218.20-2050.RE-44A	02928082	Combimaster	50,0	2	44,0	25,0	36,5	M20	65,0	45,0	5000	0,4	-250(2)

For Combimaster Shanks, see Machining Navigator Tooling System

Spare Parts, included in delivery

For cutter	Insert key 	Insert screw 
R218.20-0612-0812	H4B-T06P	C01805-T06P
R218.20-0816-1016	H4B-T08P	C02506-T08P
R218.20-1020-1220	H4B-T09P	C03007-T09P
R218.20-1225-1630	H4B-T15P	C04009-T15P
R218.20-1632	H4B-T15P	C04011-T15P
R218.20-1640-2040	H6B-T20P	C05013-T20P
R218.20-2050	H6B-T25P	C06018-T25P

Accessories

For cutter	Insert clamping torque 	Torque key 
R218.20-0612-0812	0.5NM	T00-06P05
R218.20-0816-1016	1.2NM	T00-08P12
R218.20-1020-1220	2.0NM	T00-09P20
R218.20-1225-1632	3.5NM	T00-15P35
R218.20-1640-2040	5.0NM	T00-20P50
R218.20-2050	8.0NM	T00T-25P80

Torque and fixed keys, see page 894

- Square shoulder and slot milling cutters
- Helical milling cutters
- Face milling cutters
- Disc milling cutters
- High feed milling cutters
- Copy milling cutters
- Plunge milling cutters
- Chamfer milling cutters
- Spot facing cutters
- Inserts

R218.20 – inch

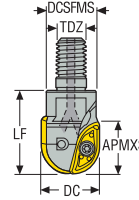

- For insert selection and cutting data recommendations, see page(s) 681-712
- For complete insert programme, see page(s) 879
- For ISO attribute explanation, see page 16

Designation	Item number	Type of mounting	DC	ZEPF	APMXS	APMXE	DCSFMS	TDZ	LF	RMPX°	RPMX	Weight	218.20
			inch		inch	inch	inch		inch			lbs	
R218.20-0.500-06RE-11A	02687515	Combimaster	0.500	2	0.433	0.250	0.433	M6	0.787	45,0	30000	0.020	-0.250.R (2)
R218.20-0.500-08RE-11A	02687516	Combimaster	0.500	2	0.433	0.250	0.531	M8	0.906	45,0	28500	0.220	-0.250.R (2)
R218.20-0.625-08RE-14A	02742688	Combimaster	0.625	2	0.551	0.313	0.531	M8	0.906	45,0	28500	0.020	-080.R (2)
R218.20-0.750-10RE-17A	02428548	Combimaster	0.750	2	0.669	0.375	0.728	M10	1.102	45,0	20200	0.220	-0.375.R (2)
R218.20-01.00-12RE-22A	00040018	Combimaster	1.000	2	0.866	0.500	0.846	M12	1.378	45,0	16900	0.220	-125.R (2)
R218.20-01.25-16RE-28A	00040019	Combimaster	1.250	2	1.102	0.625	1.122	M16	1.575	45,0	10900	0.220	-160.R (2)
R218.20-01.50-16RE-34A	00040020	Combimaster	1.500	2	1.339	0.750	1.339	M16	1.969	45,0	7200	0.220	-0.750.R (2)
R218.20-02.00-20RE-44A	02928066	Combimaster	2.000	2	1.732	1.000	1.437	M20	2.559	45,0	5000	1.100	-250(2)

For Combimaster Shanks, see Machining Navigator Tooling System

Spare Parts, included in delivery

For cutter	Insert key	Insert screw
R218.20-0.500	H4B-T06P	C02052-T06P
R218.20-0.625	H4B-T08P	C02506-T08P
R218.20-0.750	H4B-T09P	C03006-T09P
R218.20-01.00	H4B-T15P	C04009-T15P
R218.20-01.25	H4B-T15P	C04011-T15P
R218.20-01.50	H6B-T20P	C05013-T20P
R218.20-02.00	H6B-T25P	C06018-T25P

Accessories

For cutter	Insert clamping torque	Torque key
R218.20-0.500	4.4IN.LBS	T00-06P05
R218.20-0.625	10.6IN.LBS	T00-08P12
R218.20-0.750	17.7IN.LBS	T00-09P20
R218.20-01.00-01.25	31.0IN.LBS	T00-15P35
R218.20-01.50	44.3IN.LBS	T00-20P50
R218.20-02.00	70.8IN.LBS	T00T-25P80

Torque and fixed keys, see page 894

R218.20-0.250 – Insert selection – mm/Inch

SMG		a _p	f _z		
			100%	70%	30%
P1	218.20-0.250ER-ME03 F40M	7,0	0,044	0,044	0,048
		0,28	0,0017	0,0017	0,0019
P2	218.20-0.250ER-ME03 F40M	7,0	0,044	0,044	0,048
		0,28	0,0017	0,0017	0,0019
P3	218.20-0.250ER-ME03 F40M	7,0	0,042	0,042	0,046
		0,28	0,0017	0,0017	0,0018
P4	218.20-0.250ER-M03 F40M	7,0	0,042	0,042	0,046
		0,28	0,0017	0,0017	0,0018
P5	218.20-0.250ER-M03 F40M	7,0	0,040	0,040	0,044
		0,28	0,0016	0,0016	0,0017
P6	218.20-0.250ER-M03 F40M	7,0	0,040	0,040	0,044
		0,28	0,0016	0,0016	0,0017
P7	218.20-0.250ER-M03 F40M	7,0	0,040	0,040	0,044
		0,28	0,0016	0,0016	0,0017
P8	218.20-0.250ER-M03 F40M	7,0	0,042	0,042	0,046
		0,28	0,0017	0,0017	0,0018
P11	218.20-0.250ER-M03 F40M	7,0	0,040	0,040	0,044
		0,28	0,0016	0,0016	0,0017
M1	218.20-0.250ER-ME03 F40M	7,0	0,044	0,044	0,048
		0,28	0,0017	0,0017	0,0019
M2	218.20-0.250ER-ME03 F40M	7,0	0,040	0,040	0,044
		0,28	0,0016	0,0016	0,0017
M3	218.20-0.250ER-ME03 F40M	5,0	0,034	0,034	0,036
		0,20	0,0013	0,0013	0,0014
M4	218.20-0.250ER-ME03 F40M	4,0	0,032	0,032	0,032
		0,16	0,0013	0,0013	0,0013
M5	218.20-0.250ER-M03 F40M	4,0	0,032	0,032	0,032
		0,16	0,0013	0,0013	0,0013
K1	218.20-0.250ER-M03 F40M	7,0	0,044	0,044	0,048
		0,28	0,0017	0,0017	0,0019
K2	218.20-0.250ER-M03 F40M	7,0	0,040	0,040	0,044
		0,28	0,0016	0,0016	0,0017
K3	218.20-0.250ER-M03 F40M	7,0	0,040	0,040	0,044
		0,28	0,0016	0,0016	0,0017
K4	218.20-0.250ER-M03 F40M	7,0	0,040	0,040	0,044
		0,28	0,0016	0,0016	0,0017
K5	218.20-0.250ER-M03 F40M	7,0	0,036	0,036	0,040
		0,28	0,0014	0,0014	0,0016
K6	218.20-0.250ER-M03 F40M	7,0	0,040	0,040	0,044
		0,28	0,0016	0,0016	0,0017
K7	218.20-0.250ER-M03 F40M	7,0	0,036	0,036	0,040
		0,28	0,0014	0,0014	0,0016
N1	218.20-0.250ER-ME03 F40M	7,0	0,055	0,055	0,060
		0,28	0,0022	0,0022	0,0024
N2	218.20-0.250ER-ME03 F40M	7,0	0,055	0,055	0,060
		0,28	0,0022	0,0022	0,0024
N3	218.20-0.250ER-ME03 F40M	7,0	0,055	0,055	0,060
		0,28	0,0022	0,0022	0,0024
N11	218.20-0.250ER-ME03 F40M	7,0	0,055	0,055	0,060
		0,28	0,0022	0,0022	0,0024
S1	218.20-0.250ER-ME03 F40M	4,0	0,032	0,032	0,032
		0,16	0,0013	0,0013	0,0013
S2	218.20-0.250ER-ME03 F40M	4,0	0,032	0,032	0,032
		0,16	0,0013	0,0013	0,0013
S3	218.20-0.250ER-ME03 F40M	4,0	0,030	0,030	0,030
		0,16	0,0012	0,0012	0,0012
S11	218.20-0.250ER-ME03 F40M	4,5	0,036	0,036	0,038
		0,18	0,0014	0,0014	0,0015
S12	218.20-0.250ER-ME03 F40M	4,5	0,036	0,036	0,038
		0,18	0,0014	0,0014	0,0015
S13	218.20-0.250ER-ME03 F40M	4,0	0,032	0,032	0,032
		0,16	0,0013	0,0013	0,0013
H5	218.20-0.250ER-M03 F40M	5,0	0,030	0,030	0,032
		0,20	0,0012	0,0012	0,0013
H8	218.20-0.250ER-M03 F40M	4,5	0,024	0,024	0,024
		0,18	0,00095	0,00095	0,00095
H11	218.20-0.250ER-M03 F40M	5,0	0,030	0,030	0,032
		0,20	0,0012	0,0012	0,0013
H12	218.20-0.250ER-M03 F40M	4,5	0,024	0,024	0,024
		0,18	0,00095	0,00095	0,00095
H21	218.20-0.250ER-M03 F40M	4,5	0,024	0,024	0,024
		0,18	0,00095	0,00095	0,00095

SMG = Seco material group
 f_z = mm/tooth (in/tooth), v_c = m/min (sf/min), a_e/DC = %
 All cutting data are start values

Square shoulder and slot milling cutters
 Helical milling cutters
 Face milling cutters
 Disc milling cutters
 High feed milling cutters
 Copy milling cutters
 Plunge milling cutters
 Chamfer milling cutters
 Spot facing cutters
 Inserts

R218.20-0.250 – Insert selection – mm/Inch

SMG		a_p	f_z		
			15%	10%	5%
P1	218.20-0.250ER-ME03 F40M	7,0	0,060	0,075	0,10
		0,28	0,0024	0,0030	0,0040
P2	218.20-0.250ER-ME03 F40M	7,0	0,060	0,075	0,10
		0,28	0,0024	0,0030	0,0040
P3	218.20-0.250ER-ME03 F40M	7,0	0,060	0,070	0,095
		0,28	0,0024	0,0028	0,0038
P4	218.20-0.250ER-M03 F40M	7,0	0,060	0,070	0,095
		0,28	0,0024	0,0028	0,0038
P5	218.20-0.250ER-M03 F40M	7,0	0,055	0,065	0,095
		0,28	0,0022	0,0026	0,0038
P6	218.20-0.250ER-M03 F40M	7,0	0,055	0,065	0,090
		0,28	0,0022	0,0026	0,0036
P7	218.20-0.250ER-M03 F40M	7,0	0,055	0,065	0,090
		0,28	0,0022	0,0026	0,0036
P8	218.20-0.250ER-M03 F40M	7,0	0,060	0,070	0,095
		0,28	0,0024	0,0028	0,0038
P11	218.20-0.250ER-M03 F40M	7,0	0,055	0,065	0,090
		0,28	0,0022	0,0026	0,0036
M1	218.20-0.250ER-ME03 F40M	7,0	0,060	0,075	0,10
		0,28	0,0024	0,0030	0,0040
M2	218.20-0.250ER-ME03 F40M	7,0	0,055	0,065	0,095
		0,28	0,0022	0,0026	0,0038
M3	218.20-0.250ER-ME03 F40M	5,0	0,046	0,055	0,075
		0,20	0,0018	0,0022	0,0030
M4	218.20-0.250ER-ME03 F40M	4,0	0,040	0,048	0,065
		0,16	0,0016	0,0019	0,0026
M5	218.20-0.250ER-ME03 F40M	4,0	0,040	0,048	0,065
		0,16	0,0016	0,0019	0,0026
K1	218.20-0.250ER-M03 F40M	7,0	0,060	0,075	0,10
		0,28	0,0024	0,0030	0,0040
K2	218.20-0.250ER-M03 F40M	7,0	0,055	0,065	0,095
		0,28	0,0022	0,0026	0,0038
K3	218.20-0.250ER-M03 F40M	7,0	0,055	0,065	0,095
		0,28	0,0022	0,0026	0,0038
K4	218.20-0.250ER-M03 F40M	7,0	0,055	0,065	0,095
		0,28	0,0022	0,0026	0,0038
K5	218.20-0.250ER-M03 F40M	7,0	0,050	0,060	0,085
		0,28	0,0020	0,0024	0,0034
K6	218.20-0.250ER-M03 F40M	7,0	0,055	0,065	0,095
		0,28	0,0022	0,0026	0,0038
K7	218.20-0.250ER-M03 F40M	7,0	0,050	0,060	0,085
		0,28	0,0020	0,0024	0,0034
N1	218.20-0.250ER-ME03 F40M	7,0	0,080	0,095	0,13
		0,28	0,0032	0,0038	0,0050
N2	218.20-0.250ER-ME03 F40M	7,0	0,080	0,095	0,13
		0,28	0,0032	0,0038	0,0050
N3	218.20-0.250ER-ME03 F40M	7,0	0,080	0,095	0,13
		0,28	0,0032	0,0038	0,0050
N11	218.20-0.250ER-ME03 F40M	7,0	0,080	0,095	0,13
		0,28	0,0032	0,0038	0,0050
S1	218.20-0.250ER-ME03 F40M	4,0	0,040	0,048	0,065
		0,16	0,0016	0,0019	0,0026
S2	218.20-0.250ER-ME03 F40M	4,0	0,040	0,048	0,065
		0,16	0,0016	0,0019	0,0026
S3	218.20-0.250ER-ME03 F40M	4,0	0,036	0,044	0,060
		0,16	0,0014	0,0017	0,0024
S11	218.20-0.250ER-ME03 F40M	4,5	0,046	0,055	0,075
		0,18	0,0018	0,0022	0,0030
S12	218.20-0.250ER-ME03 F40M	4,5	0,046	0,055	0,075
		0,18	0,0018	0,0022	0,0030
S13	218.20-0.250ER-ME03 F40M	4,0	0,040	0,048	0,065
		0,16	0,0016	0,0019	0,0026
H5	218.20-0.250ER-M03 F40M	5,0	0,038	0,046	0,065
		0,20	0,0015	0,0018	0,0026
H8	218.20-0.250ER-M03 F40M	4,5	0,030	0,034	0,048
		0,18	0,0012	0,0013	0,0019
H11	218.20-0.250ER-M03 F40M	5,0	0,038	0,046	0,065
		0,20	0,0015	0,0018	0,0026
H12	218.20-0.250ER-M03 F40M	4,5	0,030	0,034	0,048
		0,18	0,0012	0,0013	0,0019
H21	218.20-0.250ER-M03 F40M	4,5	0,030	0,034	0,048
		0,18	0,0012	0,0013	0,0019

SMG = Seco material group
 f_z = mm/tooth (in/tooth), v_c = m/min (sf/min), a_p/DC = %
 All cutting data are start values

R218.20-0.250 – Cutting data $v_c = (m/min)/(sf/min)$

SMG	F40M				
	100%	70%	30%	10%	5%
P1	295	325	385	450	490
	970	1075	1275	1475	1600
P2	290	315	375	435	480
	950	1025	1225	1425	1575
P3	250	275	325	380	415
	820	900	1075	1250	1350
P4	220	240	285	335	365
	720	790	940	1100	1200
P5	210	230	275	325	350
	690	750	900	1075	1150
P6	235	260	310	360	395
	770	850	1025	1175	1300
P7	225	245	290	340	370
	740	800	950	1125	1225
P8	210	230	270	320	350
	690	750	890	1050	1150
P11	220	240	280	330	360
	720	790	920	1075	1175
M1	230	255	300	350	385
	750	840	980	1150	1275
M2	190	210	245	290	315
	620	690	800	950	1025
M3	160	175	205	225	245
	520	570	670	740	800
M4	125	135	160	170	190
	410	445	520	560	620
M5	105	110	135	145	155
	345	360	445	475	510
K1	230	250	295	345	380
	750	820	970	1125	1250
K2	200	220	260	305	330
	660	720	850	1000	1075
K3	170	185	220	260	280
	560	610	720	850	920
K4	160	180	210	245	265
	520	590	690	800	870
K5	100	105	125	150	160
	330	345	410	490	520
K6	145	155	185	220	235
	475	510	610	720	770
K7	125	140	160	190	205
	410	460	520	620	670
N1	1750	1900	2250	2650	2875
	5750	6225	7375	8700	9425
N2	700	770	910	1075	1175
	2300	2525	2975	3525	3850
N3	470	510	610	710	780
	1550	1675	2000	2325	2550
N11	530	580	700	810	890
	1750	1900	2300	2650	2925
S1	60	65	75	80	90
	195	215	245	260	295
S2	48	50	60	65	70
	155	165	195	215	230
S3	41	44	50	55	60
	135	145	165	180	195
S11	85	90	105	115	125
	280	295	345	375	410
S12	55	60	75	80	85
	180	195	245	260	280
S13	33	35	42	45	49
	110	115	140	150	160
H5	48	50	60	70	75
	155	165	195	230	245
H8	50	55	65	70	75
	165	180	215	230	245
H11	60	65	80	85	95
	195	215	260	280	310
H12	90	95	115	125	135
	295	310	375	410	445
H21	50	55	65	70	75
	165	180	215	230	245

Square shoulder and slot milling cutters
Helical milling cutters
Face milling cutters
Disc milling cutters
High feed milling cutters
Copy milling cutters
Plunge milling cutters
Chamfer milling cutters
Spot facing cutters
Inserts

R218.20-0.375 – Insert selection – mm/Inch

SMG		a _p	f _z		
			100%	70%	30%
P1	218.20-0.375ER-ME05 F40M	10,0	0,075	0,075	0,080
		0.40	0.0030	0.0030	0.0032
P2	218.20-0.375ER-ME05 F40M	10,0	0,075	0,075	0,080
		0.40	0.0030	0.0030	0.0032
P3	218.20-0.375ER-ME05 F40M	10,0	0,070	0,070	0,075
		0.40	0.0028	0.0028	0.0030
P4	218.20-0.375ER-M05 F25M	10,0	0,070	0,070	0,075
		0.40	0.0028	0.0028	0.0030
P5	218.20-0.375ER-M05 F25M	10,0	0,070	0,070	0,075
		0.40	0.0028	0.0028	0.0030
P6	218.20-0.375ER-M05 F25M	10,0	0,070	0,070	0,075
		0.40	0.0028	0.0028	0.0030
P7	218.20-0.375ER-M05 F25M	10,0	0,070	0,070	0,075
		0.40	0.0028	0.0028	0.0030
P8	218.20-0.375ER-M05 F25M	10,0	0,070	0,070	0,075
		0.40	0.0028	0.0028	0.0030
P11	218.20-0.375ER-M05 F25M	10,0	0,070	0,070	0,075
		0.40	0.0028	0.0028	0.0030
M1	218.20-0.375ER-ME05 F40M	10,0	0,075	0,075	0,080
		0.40	0.0030	0.0030	0.0032
M2	218.20-0.375ER-ME05 F40M	10,0	0,070	0,070	0,075
		0.40	0.0028	0.0028	0.0030
M3	218.20-0.375ER-ME05 F40M	8,0	0,055	0,055	0,060
		0.32	0.0022	0.0022	0.0024
M4	218.20-0.375ER-ME05 F40M	6,0	0,055	0,055	0,055
		0.24	0.0022	0.0022	0.0022
M5	218.20-0.375ER-M05 F40M	6,0	0,055	0,055	0,055
		0.24	0.0022	0.0022	0.0022
K1	218.20-0.375ER-M05 F25M	10,0	0,075	0,075	0,080
		0.40	0.0030	0.0030	0.0032
K2	218.20-0.375ER-M05 F25M	10,0	0,070	0,070	0,075
		0.40	0.0028	0.0028	0.0030
K3	218.20-0.375ER-M05 F25M	10,0	0,070	0,070	0,075
		0.40	0.0028	0.0028	0.0030
K4	218.20-0.375ER-M05 F25M	10,0	0,070	0,070	0,075
		0.40	0.0028	0.0028	0.0030
K5	218.20-0.375ER-M05 F25M	10,0	0,060	0,060	0,065
		0.40	0.0024	0.0024	0.0026
K6	218.20-0.375ER-M05 F25M	10,0	0,070	0,070	0,075
		0.40	0.0028	0.0028	0.0030
K7	218.20-0.375ER-M05 F25M	10,0	0,060	0,060	0,065
		0.40	0.0024	0.0024	0.0026
N1	218.20-0.375ER-ME05 F40M	10,0	0,095	0,095	0,10
		0.40	0.0038	0.0038	0.0040
N2	218.20-0.375ER-ME05 F40M	10,0	0,095	0,095	0,10
		0.40	0.0038	0.0038	0.0040
N3	218.20-0.375ER-ME05 F40M	10,0	0,095	0,095	0,10
		0.40	0.0038	0.0038	0.0040
N11	218.20-0.375ER-ME05 F40M	10,0	0,095	0,095	0,10
		0.40	0.0038	0.0038	0.0040
S1	218.20-0.375ER-ME05 F40M	6,0	0,055	0,055	0,055
		0.24	0.0022	0.0022	0.0022
S2	218.20-0.375ER-ME05 F40M	6,0	0,055	0,055	0,055
		0.24	0.0022	0.0022	0.0022
S3	218.20-0.375ER-ME05 F40M	6,0	0,050	0,050	0,050
		0.24	0.0020	0.0020	0.0020
S11	218.20-0.375ER-ME05 F40M	7,0	0,060	0,060	0,060
		0.28	0.0024	0.0024	0.0024
S12	218.20-0.375ER-ME05 F40M	7,0	0,060	0,060	0,060
		0.28	0.0024	0.0024	0.0024
S13	218.20-0.375ER-ME05 F40M	6,0	0,055	0,055	0,055
		0.24	0.0022	0.0022	0.0022
H5	218.20-0.375ER-M05 F25M	8,0	0,048	0,048	0,050
		0.32	0.0019	0.0019	0.0020
H8	218.20-0.375ER-M05 F25M	7,0	0,038	0,038	0,040
		0.28	0.0015	0.0015	0.0016
H11	218.20-0.375ER-M05 F25M	8,0	0,048	0,048	0,050
		0.32	0.0019	0.0019	0.0020
H12	218.20-0.375ER-M05 F25M	7,0	0,038	0,038	0,040
		0.28	0.0015	0.0015	0.0016
H21	218.20-0.375ER-M05 F25M	7,0	0,038	0,038	0,040
		0.28	0.0015	0.0015	0.0016

SMG = Seco material group
 f_z = mm/tooth (in/tooth), v_c = m/min (sf/min), a_p/DC = %
 All cutting data are start values

R218.20-0.375 – Insert selection – mm/Inch

SMG		a _p	f _z		
			15%	10%	5%
P1	218.20-0.375ER-ME05 F40M	10,0	0,10	0,12	0,17
		0,40	0,0040	0,0048	0,0065
P2	218.20-0.375ER-ME05 F40M	10,0	0,10	0,12	0,17
		0,40	0,0040	0,0048	0,0065
P3	218.20-0.375ER-ME05 F40M	10,0	0,10	0,12	0,16
		0,40	0,0040	0,0048	0,0065
P4	218.20-0.375ER-M05 F25M	10,0	0,095	0,12	0,16
		0,40	0,0038	0,0048	0,0065
P5	218.20-0.375ER-M05 F25M	10,0	0,095	0,11	0,16
		0,40	0,0038	0,0044	0,0065
P6	218.20-0.375ER-M05 F25M	10,0	0,095	0,11	0,15
		0,40	0,0038	0,0044	0,0060
P7	218.20-0.375ER-M05 F25M	10,0	0,095	0,11	0,15
		0,40	0,0038	0,0044	0,0060
P8	218.20-0.375ER-M05 F25M	10,0	0,10	0,12	0,16
		0,40	0,0040	0,0048	0,0065
P11	218.20-0.375ER-M05 F25M	10,0	0,095	0,11	0,15
		0,40	0,0038	0,0044	0,0060
M1	218.20-0.375ER-ME05 F40M	10,0	0,10	0,12	0,17
		0,40	0,0040	0,0048	0,0065
M2	218.20-0.375ER-ME05 F40M	10,0	0,095	0,11	0,16
		0,40	0,0038	0,0044	0,0065
M3	218.20-0.375ER-ME05 F40M	8,0	0,075	0,090	0,12
		0,32	0,0030	0,0036	0,0048
M4	218.20-0.375ER-ME05 F40M	6,0	0,065	0,080	0,11
		0,24	0,0026	0,0032	0,0044
M5	218.20-0.375ER-ME05 F40M	6,0	0,065	0,080	0,11
		0,24	0,0026	0,0032	0,0044
K1	218.20-0.375ER-M05 F25M	10,0	0,10	0,12	0,17
		0,40	0,0040	0,0048	0,0065
K2	218.20-0.375ER-M05 F25M	10,0	0,095	0,11	0,16
		0,40	0,0038	0,0044	0,0065
K3	218.20-0.375ER-M05 F25M	10,0	0,095	0,11	0,16
		0,40	0,0038	0,0044	0,0065
K4	218.20-0.375ER-M05 F25M	10,0	0,095	0,11	0,16
		0,40	0,0038	0,0044	0,0065
K5	218.20-0.375ER-M05 F25M	10,0	0,085	0,10	0,14
		0,40	0,0034	0,0040	0,0055
K6	218.20-0.375ER-M05 F25M	10,0	0,095	0,11	0,16
		0,40	0,0038	0,0044	0,0065
K7	218.20-0.375ER-M05 F25M	10,0	0,085	0,10	0,14
		0,40	0,0034	0,0040	0,0055
N1	218.20-0.375ER-ME05 F40M	10,0	0,13	0,16	0,22
		0,40	0,0050	0,0065	0,0085
N2	218.20-0.375ER-ME05 F40M	10,0	0,13	0,16	0,22
		0,40	0,0050	0,0065	0,0085
N3	218.20-0.375ER-ME05 F40M	10,0	0,13	0,16	0,22
		0,40	0,0050	0,0065	0,0085
N11	218.20-0.375ER-ME05 F40M	10,0	0,13	0,16	0,22
		0,40	0,0050	0,0065	0,0085
S1	218.20-0.375ER-ME05 F40M	6,0	0,065	0,080	0,11
		0,24	0,0026	0,0032	0,0044
S2	218.20-0.375ER-ME05 F40M	6,0	0,065	0,080	0,11
		0,24	0,0026	0,0032	0,0044
S3	218.20-0.375ER-ME05 F40M	6,0	0,060	0,075	0,10
		0,24	0,0024	0,0030	0,0040
S11	218.20-0.375ER-ME05 F40M	7,0	0,075	0,090	0,12
		0,28	0,0030	0,0036	0,0048
S12	218.20-0.375ER-ME05 F40M	7,0	0,075	0,090	0,12
		0,28	0,0030	0,0036	0,0048
S13	218.20-0.375ER-ME05 F40M	6,0	0,065	0,080	0,11
		0,24	0,0026	0,0032	0,0044
H5	218.20-0.375ER-M05 F25M	8,0	0,065	0,075	0,11
		0,32	0,0026	0,0030	0,0044
H8	218.20-0.375ER-M05 F25M	7,0	0,050	0,060	0,080
		0,28	0,0020	0,0024	0,0032
H11	218.20-0.375ER-M05 F25M	8,0	0,065	0,075	0,11
		0,32	0,0026	0,0030	0,0044
H12	218.20-0.375ER-M05 F25M	7,0	0,050	0,060	0,080
		0,28	0,0020	0,0024	0,0032
H21	218.20-0.375ER-M05 F25M	7,0	0,050	0,060	0,080
		0,28	0,0020	0,0024	0,0032

SMG = Seco material group
 f_z = mm/tooth (in/tooth), v_c = m/min (sf/min), a_e/DC = %
 All cutting data are start values

Square shoulder and slot milling cutters
 Helical milling cutters
 Face milling cutters
 Disc milling cutters
 High feed milling cutters
 Copy milling cutters
 Plunge milling cutters
 Chamfer milling cutters
 Spot facing cutters
 Inserts

R218.20-0.375 – Cutting data $v_c = (m/min)/(sf/min)$

SMG	F25M					F40M				
	100%	70%	30%	10%	5%	100%	70%	30%	10%	5%
P1	280	305	370	435	475	270	295	355	420	455
	920	1000	1225	1425	1550	890	970	1175	1375	1500
P2	275	300	360	425	460	265	285	345	410	445
	900	980	1175	1400	1500	870	940	1125	1350	1450
P3	240	260	315	365	400	230	250	300	350	385
	790	850	1025	1200	1300	750	820	980	1150	1275
P4	210	230	275	320	355	205	220	265	310	340
	690	750	900	1050	1175	670	720	870	1025	1125
P5	200	220	265	310	335	195	210	255	300	325
	660	720	870	1025	1100	640	690	840	980	1075
P6	225	245	295	350	385	220	235	285	335	370
	740	800	970	1150	1275	720	770	940	1100	1225
P7	215	230	280	330	360	205	225	270	320	350
	710	750	920	1075	1175	670	740	890	1050	1150
P8	200	220	265	305	335	195	210	255	295	325
	660	720	870	1000	1100	640	690	840	970	1075
P11	205	225	270	320	350	200	215	260	310	340
	670	740	890	1050	1150	660	710	850	1025	1125
M1	—	—	—	—	—	215	230	280	330	360
	—	—	—	—	—	710	750	920	1075	1175
M2	—	—	—	—	—	175	190	230	270	290
	—	—	—	—	—	570	620	750	890	950
M3	—	—	—	—	—	150	160	190	215	235
	—	—	—	—	—	490	520	620	710	770
M4	—	—	—	—	—	120	125	150	165	180
	—	—	—	—	—	395	410	490	540	590
M5	—	—	—	—	—	100	105	125	135	150
	—	—	—	—	—	330	345	410	445	490
K1	220	235	285	335	365	210	230	275	325	350
	720	770	940	1100	1200	690	750	900	1075	1150
K2	190	210	250	295	320	185	200	240	285	310
	620	690	820	970	1050	610	660	790	940	1025
K3	160	175	210	250	270	155	170	205	240	260
	520	570	690	820	890	510	560	670	790	850
K4	155	170	200	240	260	150	160	195	230	250
	510	560	660	790	850	490	520	640	750	820
K5	95	105	125	145	155	90	100	120	140	150
	310	345	410	475	510	295	330	395	460	490
K6	135	150	180	210	230	130	140	170	205	220
	445	490	590	690	750	425	460	560	670	720
K7	120	130	160	185	200	115	125	150	180	195
	395	425	520	610	660	375	410	490	590	640
N1	—	—	—	—	—	1575	1700	2075	2425	2650
	—	—	—	—	—	5175	5575	6800	7950	8700
N2	—	—	—	—	—	640	690	840	980	1075
	—	—	—	—	—	2100	2275	2750	3225	3525
N3	—	—	—	—	—	425	460	560	650	710
	—	—	—	—	—	1400	1500	1825	2125	2325
N11	—	—	—	—	—	485	530	640	740	810
	—	—	—	—	—	1600	1750	2100	2425	2650
S1	55	60	70	80	85	55	60	70	75	85
	180	195	230	260	280	180	195	230	245	280
S2	46	48	60	65	70	44	46	55	60	65
	150	155	195	215	230	145	150	180	195	215
S3	40	42	50	55	60	39	41	49	55	60
	130	140	165	180	195	130	135	160	180	195
S11	80	85	100	110	125	75	80	100	110	120
	260	280	330	360	410	245	260	330	360	395
S12	55	60	70	75	85	55	55	70	75	80
	180	195	230	245	280	180	180	230	245	260
S13	32	34	41	44	48	31	32	39	43	47
	105	110	135	145	155	100	105	130	140	155
H5	46	50	60	65	70	45	48	55	65	70
	150	165	195	215	230	150	155	180	215	230
H8	49	55	65	70	75	47	50	60	65	75
	160	180	215	230	245	155	165	195	215	245
H11	60	65	75	85	90	55	60	75	80	90
	195	215	245	280	295	180	195	245	260	295
H12	90	95	110	125	135	85	90	110	120	130
	295	310	360	410	445	280	295	360	395	425
H21	49	55	65	70	75	47	50	60	65	75
	160	180	215	230	245	155	165	195	215	245

R218.20-0.750 – Insert selection – mm/Inch

SMG			a_p		f_z		
					100%	70%	30%
P1	218.20-0.750ER-ME10 F40M	SCET120612T-M14 T350M	36,0	0,14	0,14	0,15	
			1,4	0,0055	0,0055	0,0060	
P2	218.20-0.750ER-ME10 F40M	SCET120612T-M14 T350M	36,0	0,14	0,14	0,16	
			1,4	0,0055	0,0055	0,0065	
P3	218.20-0.750ER-ME10 F40M	SCET120612T-M14 T350M	36,0	0,14	0,14	0,15	
			1,4	0,0055	0,0055	0,0060	
P4	218.20-0.750ER-M10 MM4500	SCET120612T-M11 MP2501	36,0	0,13	0,13	0,14	
			1,4	0,0050	0,0050	0,0055	
P5	218.20-0.750ER-M10 MM4500	SCET120612T-M11 MP2501	36,0	0,13	0,13	0,14	
			1,4	0,0050	0,0050	0,0055	
P6	218.20-0.750ER-M10 MM4500	SCET120612T-M11 MP2501	36,0	0,13	0,13	0,14	
			1,4	0,0050	0,0050	0,0055	
P7	218.20-0.750ER-M10 MM4500	SCET120612T-M11 MP2501	36,0	0,13	0,13	0,14	
			1,4	0,0050	0,0050	0,0055	
P8	218.20-0.750ER-M10 MM4500	SCET120612T-M11 MP2501	36,0	0,14	0,14	0,15	
			1,4	0,0055	0,0055	0,0060	
P11	218.20-0.750ER-M10 MM4500	SCET120612T-M11 MP2501	36,0	0,13	0,13	0,14	
			1,4	0,0050	0,0050	0,0055	
M1	218.20-0.750ER-ME10 F40M	SCET120612T-M14 T350M	36,0	0,14	0,14	0,16	
			1,4	0,0055	0,0055	0,0065	
M2	218.20-0.750ER-ME10 F40M	SCET120612T-M14 T350M	36,0	0,13	0,13	0,14	
			1,4	0,0050	0,0050	0,0055	
M3	218.20-0.750ER-ME10 F40M	SCET120612T-M14 T350M	29,0	0,11	0,11	0,11	
			1,1	0,0044	0,0044	0,0044	
M4	218.20-0.750ER-ME10 F40M	SCET120612T-M14 T350M	22,0	0,095	0,095	0,10	
			0,85	0,0038	0,0038	0,0040	
M5	218.20-0.750ER-M10 MM4500	SCET120612T-M14 T350M	22,0	0,095	0,095	0,10	
			0,85	0,0038	0,0038	0,0040	
N1	218.20-0.750ER-ME10 F40M	SCET120612T-M11 F40M	36,0	0,18	0,18	0,20	
			1,4	0,0070	0,0070	0,0080	
N2	218.20-0.750ER-ME10 F40M	SCET120612T-M11 F40M	36,0	0,18	0,18	0,20	
			1,4	0,0070	0,0070	0,0080	
N3	218.20-0.750ER-ME10 F40M	SCET120612T-M11 F40M	36,0	0,18	0,18	0,20	
			1,4	0,0070	0,0070	0,0080	
N11	218.20-0.750ER-ME10 F40M	SCET120612T-M11 F40M	36,0	0,18	0,18	0,20	
			1,4	0,0070	0,0070	0,0080	
S1	218.20-0.750ER-ME10 F40M	SCET120612T-M14 T350M	22,0	0,095	0,095	0,10	
			0,85	0,0038	0,0038	0,0040	
S2	218.20-0.750ER-ME10 F40M	SCET120612T-M14 T350M	22,0	0,095	0,095	0,10	
			0,85	0,0038	0,0038	0,0040	
S3	218.20-0.750ER-ME10 F40M	SCET120612T-M14 T350M	22,0	0,090	0,090	0,095	
			0,85	0,0036	0,0036	0,0038	
S11	218.20-0.750ER-ME10 F40M	SCET120612T-M14 F40M	25,0	0,11	0,11	0,12	
			1,0	0,0044	0,0044	0,0048	
S12	218.20-0.750ER-ME10 F40M	SCET120612T-M14 F40M	25,0	0,11	0,11	0,12	
			1,0	0,0044	0,0044	0,0048	
S13	218.20-0.750ER-ME10 F40M	SCET120612T-M14 F40M	22,0	0,095	0,095	0,10	
			0,85	0,0038	0,0038	0,0040	

SMG = Seco material group
 f_z = mm/tooth (in/tooth), v_c = m/min (sf/min), a_p/DC = %
 All cutting data are start values

Square shoulder and slot milling cutters
 Helical milling cutters
 Face milling cutters
 Disc milling cutters
 High feed milling cutters
 Copy milling cutters
 Plunge milling cutters
 Chamfer milling cutters
 Spot facing cutters
 Inserts

R218.20-0.750 – Insert selection – mm/Inch

SMG			a _p	f _z		
				15%	10%	5%
P1	218.20-0.750ER-ME10 F40M	SCET120612T-M14 T350M	36,0	0,20	0,24	0,32
			1,4	0,0080	0,0095	0,013
P2	218.20-0.750ER-ME10 F40M	SCET120612T-M14 T350M	36,0	0,20	0,24	0,34
			1,4	0,0080	0,0095	0,013
P3	218.20-0.750ER-ME10 F40M	SCET120612T-M14 T350M	36,0	0,19	0,22	0,32
			1,4	0,0075	0,0085	0,013
P4	218.20-0.750ER-M10 MM4500	SCET120612T-M11 MP2501	36,0	0,19	0,22	0,30
			1,4	0,0075	0,0085	0,012
P5	218.20-0.750ER-M10 MM4500	SCET120612T-M11 MP2501	36,0	0,18	0,22	0,30
			1,4	0,0070	0,0085	0,012
P6	218.20-0.750ER-M10 MM4500	SCET120612T-M11 MP2501	36,0	0,18	0,22	0,30
			1,4	0,0070	0,0085	0,012
P7	218.20-0.750ER-M10 MM4500	SCET120612T-M11 MP2501	36,0	0,18	0,22	0,30
			1,4	0,0070	0,0085	0,012
P8	218.20-0.750ER-M10 MM4500	SCET120612T-M11 MP2501	36,0	0,19	0,22	0,32
			1,4	0,0075	0,0085	0,013
P11	218.20-0.750ER-M10 MM4500	SCET120612T-M11 MP2501	36,0	0,18	0,22	0,30
			1,4	0,0070	0,0085	0,012
M1	218.20-0.750ER-ME10 F40M	SCET120612T-M14 T350M	36,0	0,20	0,24	0,34
			1,4	0,0080	0,0095	0,013
M2	218.20-0.750ER-ME10 F40M	SCET120612T-M14 T350M	36,0	0,18	0,22	0,30
			1,4	0,0070	0,0085	0,012
M3	218.20-0.750ER-ME10 F40M	SCET120612T-M14 T350M	29,0	0,15	0,17	0,24
			1,1	0,0060	0,0065	0,0095
M4	218.20-0.750ER-ME10 F40M	SCET120612T-M14 T350M	22,0	0,13	0,15	0,22
			0,85	0,0050	0,0060	0,0085
M5	218.20-0.750ER-ME10 F40M	SCET120612T-M14 T350M	22,0	0,13	0,15	0,22
			0,85	0,0050	0,0060	0,0085
N1	218.20-0.750ER-ME10 F40M	SCET120612T-M14 F40M	36,0	0,26	0,30	0,42
			1,4	0,010	0,012	0,017
N2	218.20-0.750ER-ME10 F40M	SCET120612T-M14 F40M	36,0	0,26	0,30	0,42
			1,4	0,010	0,012	0,017
N3	218.20-0.750ER-ME10 F40M	SCET120612T-M14 F40M	36,0	0,26	0,30	0,42
			1,4	0,010	0,012	0,017
N11	218.20-0.750ER-ME10 F40M	SCET120612T-M14 F40M	36,0	0,26	0,30	0,42
			1,4	0,010	0,012	0,017
S1	218.20-0.750ER-ME10 F40M	SCET120612T-M14 T350M	22,0	0,13	0,15	0,22
			0,85	0,0050	0,0060	0,0085
S2	218.20-0.750ER-ME10 F40M	SCET120612T-M14 T350M	22,0	0,13	0,15	0,22
			0,85	0,0050	0,0060	0,0085
S3	218.20-0.750ER-ME10 F40M	SCET120612T-M14 T350M	22,0	0,12	0,14	0,20
			0,85	0,0048	0,0055	0,0080
S11	218.20-0.750ER-ME10 F40M	SCET120612T-M14 F40M	25,0	0,15	0,17	0,24
			1,0	0,0060	0,0065	0,0095
S12	218.20-0.750ER-ME10 F40M	SCET120612T-M14 F40M	25,0	0,15	0,17	0,24
			1,0	0,0060	0,0065	0,0095
S13	218.20-0.750ER-ME10 F40M	SCET120612T-M14 F40M	22,0	0,13	0,15	0,22
			0,85	0,0050	0,0060	0,0085

SMG = Seco material group
 f_z = mm/tooth (in/tooth), v_c = m/min (sf/min), a_p/DC = %
 All cutting data are start values

R218.20-0.750 – Cutting data $v_c = (m/min)/(sf/min)$

SMG	F40M					MM4500				
	100%	70%	30%	10%	5%	100%	70%	30%	10%	5%
P1	200	220	265	315	345	155	165	205	240	260
	660	720	870	1025	1125	510	540	670	790	850
P2	195	215	255	305	330	150	165	195	235	250
	640	710	840	1000	1075	490	540	640	770	820
P3	170	185	225	270	285	130	140	170	205	220
	560	610	740	890	940	425	460	560	670	720
P4	150	165	200	235	255	115	125	155	180	195
	490	540	660	770	840	375	410	510	590	640
P5	145	155	190	225	245	110	120	145	170	185
	475	510	620	740	800	360	395	475	560	610
P6	160	175	215	255	275	125	135	165	195	210
	520	570	710	840	900	410	445	540	640	690
P7	155	165	205	240	260	115	125	155	180	200
	510	540	670	790	850	375	410	510	590	660
P8	140	155	190	225	240	110	120	145	170	185
	460	510	620	740	790	360	395	475	560	610
P11	150	160	195	230	255	115	125	150	175	195
	490	520	640	750	840	375	410	490	570	640
M1	160	170	205	245	265	130	140	165	200	215
	520	560	670	800	870	425	460	540	660	710
M2	130	140	170	205	220	105	115	140	165	180
	425	460	560	670	720	345	375	460	540	590
M3	105	115	140	165	175	85	95	115	135	145
	345	375	460	540	570	280	310	375	445	475
M4	85	95	115	125	135	70	75	90	105	110
	280	310	375	410	445	230	245	295	345	360
M5	70	75	95	105	115	60	65	75	85	90
	230	245	310	345	375	195	215	245	280	295
N1	1150	1250	1500	1800	1950	—	—	—	—	—
	3775	4100	4925	5900	6400	—	—	—	—	—
N2	460	500	610	730	790	—	—	—	—	—
	1500	1650	2000	2400	2600	—	—	—	—	—
N3	305	335	405	485	520	—	—	—	—	—
	1000	1100	1325	1600	1700	—	—	—	—	—
N11	350	380	465	550	600	—	—	—	—	—
	1150	1250	1525	1800	1975	—	—	—	—	—
S1	40	43	55	60	65	21	23	28	32	34
	130	140	180	195	215	70	75	90	105	110
S2	32	35	42	48	50	17	19	23	25	27
	105	115	140	155	165	55	60	75	80	90
S3	28	30	37	42	45	15	16	20	22	24
	90	100	120	140	150	49	50	65	70	80
S11	55	60	70	85	90	29	31	38	44	48
	180	195	230	280	295	95	100	125	145	155
S12	37	41	49	60	60	27	29	35	41	44
	120	135	160	195	195	90	95	115	135	145
S13	22	24	30	33	36	16	17	21	24	25
	70	80	100	110	120	50	55	70	80	80

Square shoulder and slot milling cutters
Helical milling cutters
Face milling cutters
Disc milling cutters
High feed milling cutters
Copy milling cutters
Plunge milling cutters
Chamfer milling cutters
Spot facing cutters
Inserts

R218.20-060 – Insert selection – mm/Inch

SMG		a _p	f _z		
			100%	70%	30%
P1	218.20-060ER-ME03 F40M	6,0	0,044	0,044	0,048
		0.24	0.0017	0.0017	0.0019
P2	218.20-060ER-ME03 F40M	6,0	0,046	0,046	0,050
		0.24	0.0018	0.0018	0.0020
P3	218.20-060ER-ME03 F40M	6,0	0,044	0,044	0,046
		0.24	0.0017	0.0017	0.0018
P4	218.20-060ER-ME03 F40M	6,0	0,042	0,042	0,046
		0.24	0.0017	0.0017	0.0018
P5	218.20-060ER-ME03 F40M	6,0	0,042	0,042	0,044
		0.24	0.0017	0.0017	0.0017
P6	218.20-060ER-ME03 F40M	6,0	0,042	0,042	0,044
		0.24	0.0017	0.0017	0.0017
P7	218.20-060ER-ME03 F40M	6,0	0,042	0,042	0,044
		0.24	0.0017	0.0017	0.0017
P8	218.20-060ER-ME03 F40M	6,0	0,044	0,044	0,046
		0.24	0.0017	0.0017	0.0018
P11	218.20-060ER-ME03 F40M	6,0	0,042	0,042	0,044
		0.24	0.0017	0.0017	0.0017
P12	218.20-060ER-ME03 F40M	5,0	0,030	0,030	0,030
		0.20	0.0012	0.0012	0.0012
M1	218.20-060ER-ME03 F40M	6,0	0,046	0,046	0,050
		0.24	0.0018	0.0018	0.0020
M2	218.20-060ER-ME03 F40M	6,0	0,042	0,042	0,044
		0.24	0.0017	0.0017	0.0017
M3	218.20-060ER-ME03 F40M	5,0	0,034	0,034	0,036
		0.20	0.0013	0.0013	0.0014
M4	218.20-060ER-ME03 F40M	3,5	0,032	0,032	0,034
		0.14	0.0013	0.0013	0.0013
M5	218.20-060ER-ME03 F40M	3,5	0,032	0,032	0,034
		0.14	0.0013	0.0013	0.0013
K1	218.20-060ER-ME03 F40M	6,0	0,046	0,046	0,050
		0.24	0.0018	0.0018	0.0020
K2	218.20-060ER-ME03 F40M	6,0	0,042	0,042	0,044
		0.24	0.0017	0.0017	0.0017
K3	218.20-060ER-ME03 F40M	6,0	0,042	0,042	0,044
		0.24	0.0017	0.0017	0.0017
K4	218.20-060ER-ME03 F40M	6,0	0,042	0,042	0,044
		0.24	0.0017	0.0017	0.0017
K5	218.20-060ER-ME03 F40M	6,0	0,038	0,038	0,040
		0.24	0.0015	0.0015	0.0016
K6	218.20-060ER-ME03 F40M	6,0	0,042	0,042	0,044
		0.24	0.0017	0.0017	0.0017
K7	218.20-060ER-ME03 F40M	6,0	0,038	0,038	0,040
		0.24	0.0015	0.0015	0.0016
N1	218.20-060ER-ME03 F40M	6,0	0,060	0,060	0,060
		0.24	0.0024	0.0024	0.0024
N2	218.20-060ER-ME03 F40M	6,0	0,060	0,060	0,060
		0.24	0.0024	0.0024	0.0024
N3	218.20-060ER-ME03 F40M	6,0	0,060	0,060	0,060
		0.24	0.0024	0.0024	0.0024
N11	218.20-060ER-ME03 F40M	6,0	0,060	0,060	0,060
		0.24	0.0024	0.0024	0.0024
S1	218.20-060ER-ME03 F40M	3,5	0,032	0,032	0,034
		0.14	0.0013	0.0013	0.0013
S2	218.20-060ER-ME03 F40M	3,5	0,032	0,032	0,034
		0.14	0.0013	0.0013	0.0013
S3	218.20-060ER-ME03 F40M	3,5	0,030	0,030	0,030
		0.14	0.0012	0.0012	0.0012
S11	218.20-060ER-ME03 MS2050	4,0	0,036	0,036	0,038
		0.16	0.0014	0.0014	0.0015
S12	218.20-060ER-ME03 MS2050	4,0	0,036	0,036	0,038
		0.16	0.0014	0.0014	0.0015
S13	218.20-060ER-ME03 MS2050	3,5	0,032	0,032	0,034
		0.14	0.0013	0.0013	0.0013
H5	218.20-060ER-ME03 F40M	5,0	0,030	0,030	0,030
		0.20	0.0012	0.0012	0.0012
H8	218.20-060ER-ME03 F40M	4,0	0,024	0,024	0,024
		0.16	0.00095	0.00095	0.00095
H11	218.20-060ER-ME03 F40M	5,0	0,030	0,030	0,030
		0.20	0.0012	0.0012	0.0012
H12	218.20-060ER-ME03 F40M	4,0	0,024	0,024	0,024
		0.16	0.00095	0.00095	0.00095
H21	218.20-060ER-ME03 F40M	4,0	0,024	0,024	0,024
		0.16	0.00095	0.00095	0.00095

SMG = Seco material group
 f_z = mm/tooth (in/tooth), v_c = m/min (sf/min), a_p/DC = %
 All cutting data are start values

R218.20-060 – Insert selection – mm/Inch

SMG		a_p		f_z		
				15%	10%	5%
P1	218.20-060ER-ME03 F40M	6,0	0,060	0,075	0,10	
		0.24	0.0024	0.0030	0.0040	
P2	218.20-060ER-ME03 F40M	6,0	0,065	0,075	0,10	
		0.24	0.0026	0.0030	0.0040	
P3	218.20-060ER-ME03 F40M	6,0	0,060	0,070	0,10	
		0.24	0.0024	0.0028	0.0040	
P4	218.20-060ER-ME03 F40M	6,0	0,060	0,070	0,095	
		0.24	0.0024	0.0028	0.0038	
P5	218.20-060ER-ME03 F40M	6,0	0,055	0,070	0,095	
		0.24	0.0022	0.0028	0.0038	
P6	218.20-060ER-ME03 F40M	6,0	0,055	0,065	0,095	
		0.24	0.0022	0.0026	0.0038	
P7	218.20-060ER-ME03 F40M	6,0	0,055	0,065	0,095	
		0.24	0.0022	0.0026	0.0038	
P8	218.20-060ER-ME03 F40M	6,0	0,060	0,070	0,10	
		0.24	0.0024	0.0028	0.0040	
P11	218.20-060ER-ME03 F40M	6,0	0,055	0,065	0,095	
		0.24	0.0022	0.0026	0.0038	
P12	218.20-060ER-ME03 F40M	5,0	0,038	0,046	0,065	
		0.20	0.0015	0.0018	0.0026	
M1	218.20-060ER-ME03 F40M	6,0	0,065	0,075	0,10	
		0.24	0.0026	0.0030	0.0040	
M2	218.20-060ER-ME03 F40M	6,0	0,055	0,070	0,095	
		0.24	0.0022	0.0028	0.0038	
M3	218.20-060ER-ME03 F40M	5,0	0,046	0,055	0,075	
		0.20	0.0018	0.0022	0.0030	
M4	218.20-060ER-ME03 F40M	3,5	0,040	0,048	0,065	
		0.14	0.0016	0.0019	0.0026	
M5	218.20-060ER-ME03 F40M	3,5	0,040	0,048	0,065	
		0.14	0.0016	0.0019	0.0026	
K1	218.20-060ER-ME03 F40M	6,0	0,065	0,075	0,10	
		0.24	0.0026	0.0030	0.0040	
K2	218.20-060ER-ME03 F40M	6,0	0,055	0,070	0,095	
		0.24	0.0022	0.0028	0.0038	
K3	218.20-060ER-ME03 F40M	6,0	0,055	0,070	0,095	
		0.24	0.0022	0.0028	0.0038	
K4	218.20-060ER-ME03 F40M	6,0	0,055	0,070	0,095	
		0.24	0.0022	0.0028	0.0038	
K5	218.20-060ER-ME03 F40M	6,0	0,050	0,060	0,085	
		0.24	0.0020	0.0024	0.0034	
K6	218.20-060ER-ME03 F40M	6,0	0,055	0,070	0,095	
		0.24	0.0022	0.0028	0.0038	
K7	218.20-060ER-ME03 F40M	6,0	0,050	0,060	0,085	
		0.24	0.0020	0.0024	0.0034	
N1	218.20-060ER-ME03 F40M	6,0	0,080	0,095	0,13	
		0.24	0.0032	0.0038	0.0050	
N2	218.20-060ER-ME03 F40M	6,0	0,080	0,095	0,13	
		0.24	0.0032	0.0038	0.0050	
N3	218.20-060ER-ME03 F40M	6,0	0,080	0,095	0,13	
		0.24	0.0032	0.0038	0.0050	
N11	218.20-060ER-ME03 F40M	6,0	0,080	0,095	0,13	
		0.24	0.0032	0.0038	0.0050	
S1	218.20-060ER-ME03 F40M	3,5	0,040	0,048	0,065	
		0.14	0.0016	0.0019	0.0026	
S2	218.20-060ER-ME03 F40M	3,5	0,040	0,048	0,065	
		0.14	0.0016	0.0019	0.0026	
S3	218.20-060ER-ME03 F40M	3,5	0,036	0,044	0,060	
		0.14	0.0014	0.0017	0.0024	
S11	218.20-060ER-ME03 MS2050	4,0	0,046	0,055	0,075	
		0.16	0.0018	0.0022	0.0030	
S12	218.20-060ER-ME03 MS2050	4,0	0,046	0,055	0,075	
		0.16	0.0018	0.0022	0.0030	
S13	218.20-060ER-ME03 MS2050	3,5	0,040	0,048	0,065	
		0.14	0.0016	0.0019	0.0026	
H5	218.20-060ER-ME03 F40M	5,0	0,038	0,046	0,065	
		0.20	0.0015	0.0018	0.0026	
H8	218.20-060ER-ME03 F40M	4,0	0,030	0,036	0,048	
		0.16	0.0012	0.0014	0.0019	
H11	218.20-060ER-ME03 F40M	5,0	0,038	0,046	0,065	
		0.20	0.0015	0.0018	0.0026	
H12	218.20-060ER-ME03 F40M	4,0	0,030	0,036	0,048	
		0.16	0.0012	0.0014	0.0019	
H21	218.20-060ER-ME03 F40M	4,0	0,030	0,036	0,048	
		0.16	0.0012	0.0014	0.0019	

SMG = Seco material group
 f_z = mm/tooth (in/tooth), v_c = m/min (sf/min), a_p/DC = %
 All cutting data are start values

Square shoulder and slot milling cutters
 Helical milling cutters
 Face milling cutters
 Disc milling cutters
 High feed milling cutters
 Copy milling cutters
 Plunge milling cutters
 Chamfer milling cutters
 Spot facing cutters
 Inserts

R218.20-060 – Cutting data $v_c = (m/min)/(sf/min)$

	SMG	F40M					MS2050				
		100%	70%	30%	10%	5%	100%	70%	30%	10%	5%
Square shoulder and slot milling cutters	P1	305	335	395	465	510	335	365	435	510	560
		1000	1100	1300	1525	1675	1100	1200	1425	1675	1825
Helical milling cutters	P2	295	320	385	450	495	325	355	420	495	540
		970	1050	1275	1475	1625	1075	1175	1375	1625	1775
Face milling cutters	P3	255	280	335	390	425	280	305	365	430	470
		840	920	1100	1275	1400	920	1000	1200	1400	1550
Disc milling cutters	P4	230	250	295	345	375	250	275	325	380	415
		750	820	970	1125	1225	820	900	1075	1250	1350
High feed milling cutters	P5	215	235	280	330	360	240	260	310	360	395
		710	770	920	1075	1175	790	850	1025	1175	1300
Copy milling cutters	P6	245	265	315	375	405	270	290	350	410	445
		800	870	1025	1225	1325	890	950	1150	1350	1450
Chamfer milling cutters	P7	230	250	300	350	380	255	275	330	390	420
		750	820	980	1150	1250	840	900	1075	1275	1375
Spot facing cutters	P8	215	235	280	330	360	235	260	310	360	395
		710	770	920	1075	1175	770	850	1025	1175	1300
Inserts	P11	225	245	290	340	370	245	270	320	375	410
		740	800	950	1125	1225	800	890	1050	1225	1350
Plunge milling cutters	P12	145	155	185	210	230	160	170	205	230	250
		475	510	610	690	750	520	560	670	750	820
Chamfer milling cutters	M1	240	260	310	365	400	265	285	340	400	440
		790	850	1025	1200	1300	870	940	1125	1300	1450
Spot facing cutters	M2	195	215	255	295	325	215	235	280	325	355
		640	710	840	970	1075	710	770	920	1075	1175
Chamfer milling cutters	M3	160	175	205	235	255	175	190	225	255	280
		520	570	670	770	840	570	620	740	840	920
Spot facing cutters	M4	130	135	160	175	195	140	150	175	195	215
		425	445	520	570	640	460	490	570	640	710
Chamfer milling cutters	M5	110	115	135	150	160	120	125	150	165	180
		360	375	445	490	520	395	410	490	540	590
Copy milling cutters	K1	235	255	305	355	390	—	—	—	—	—
		770	840	1000	1175	1275	—	—	—	—	—
Chamfer milling cutters	K2	205	225	270	310	340	—	—	—	—	—
		670	740	890	1025	1125	—	—	—	—	—
Copy milling cutters	K3	175	190	225	265	290	—	—	—	—	—
		570	620	740	870	950	—	—	—	—	—
Chamfer milling cutters	K4	165	180	215	250	275	—	—	—	—	—
		540	590	710	820	900	—	—	—	—	—
Copy milling cutters	K5	100	110	130	155	165	—	—	—	—	—
		330	360	425	510	540	—	—	—	—	—
Chamfer milling cutters	K6	145	160	190	220	245	—	—	—	—	—
		475	520	620	720	800	—	—	—	—	—
Copy milling cutters	K7	130	140	165	195	215	—	—	—	—	—
		425	460	540	640	710	—	—	—	—	—
Plunge milling cutters	N1	1775	1925	2325	2725	2975	—	—	—	—	—
		5825	6325	7625	8950	9750	—	—	—	—	—
Chamfer milling cutters	N2	720	780	940	1100	1200	—	—	—	—	—
		2350	2550	3075	3600	3925	—	—	—	—	—
Spot facing cutters	N3	475	520	630	730	800	—	—	—	—	—
		1550	1700	2075	2400	2625	—	—	—	—	—
Chamfer milling cutters	N11	550	590	720	840	920	—	—	—	—	—
		1800	1925	2350	2750	3025	—	—	—	—	—
Spot facing cutters	S1	60	65	75	85	90	65	70	85	90	100
		195	215	245	280	295	215	230	280	295	330
Chamfer milling cutters	S2	49	50	60	65	75	55	55	65	75	80
		160	165	195	215	245	180	180	215	245	260
Spot facing cutters	S3	42	44	55	60	65	46	49	60	65	70
		140	145	180	195	215	150	160	195	215	230
Chamfer milling cutters	S11	85	90	105	120	130	95	100	115	130	140
		280	295	345	395	425	310	330	375	425	460
Spot facing cutters	S12	60	60	75	80	90	65	70	80	90	100
		195	195	245	260	295	215	230	260	295	330
Chamfer milling cutters	S13	34	36	42	47	50	37	39	47	50	55
		110	120	140	155	165	120	130	155	165	180
Spot facing cutters	H5	48	50	60	70	75	—	—	—	—	—
		155	165	195	230	245	—	—	—	—	—
Chamfer milling cutters	H8	50	55	65	70	80	—	—	—	—	—
		165	180	215	230	260	—	—	—	—	—
Inserts	H11	60	65	80	90	95	—	—	—	—	—
		195	215	260	295	310	—	—	—	—	—
Spot facing cutters	H12	90	100	115	130	140	—	—	—	—	—
		295	330	375	425	460	—	—	—	—	—
Chamfer milling cutters	H21	50	55	65	70	80	—	—	—	—	—
		165	180	215	230	260	—	—	—	—	—

R218.20-080 – Insert selection – mm/Inch

SMG		a _p	f _z		
			100%	70%	30%
P1	218.20-080ER-ME04 F40M	8,0 0.32	0,10 0.0040	0,10 0.0040	0,11 0.0044
P2	218.20-080ER-ME04 F40M	8,0 0.32	0,11 0.0044	0,11 0.0044	0,11 0.0044
P3	218.20-080ER-ME04 F40M	8,0 0.32	0,10 0.0040	0,10 0.0040	0,11 0.0044
P4	218.20-080ER-M04 F25M	8,0 0.32	0,10 0.0040	0,10 0.0040	0,11 0.0044
P5	218.20-080ER-M04 F25M	8,0 0.32	0,095 0.0038	0,095 0.0038	0,10 0.0040
P6	218.20-080ER-M04 F25M	8,0 0.32	0,095 0.0038	0,095 0.0038	0,10 0.0040
P7	218.20-080ER-M04 F25M	8,0 0.32	0,095 0.0038	0,095 0.0038	0,10 0.0040
P8	218.20-080ER-M04 F25M	8,0 0.32	0,10 0.0040	0,10 0.0040	0,11 0.0044
P11	218.20-080ER-M04 F25M	8,0 0.32	0,095 0.0038	0,095 0.0038	0,10 0.0040
P12	218.20-080ER-M04 F25M	7,0 0.28	0,070 0.0028	0,070 0.0028	0,070 0.0028
M1	218.20-080ER-ME04 F40M	8,0 0.32	0,11 0.0044	0,11 0.0044	0,11 0.0044
M2	218.20-080ER-ME04 F40M	8,0 0.32	0,095 0.0038	0,095 0.0038	0,10 0.0040
M3	218.20-080ER-ME04 F40M	7,0 0.28	0,080 0.0032	0,080 0.0032	0,085 0.0034
M4	218.20-080ER-ME04 F40M	5,0 0.20	0,075 0.0030	0,075 0.0030	0,075 0.0030
M5	218.20-080ER-M04 F40M	5,0 0.20	0,075 0.0030	0,075 0.0030	0,075 0.0030
K1	218.20-080ER-M04 F25M	8,0 0.32	0,11 0.0044	0,11 0.0044	0,11 0.0044
K2	218.20-080ER-M04 F25M	8,0 0.32	0,095 0.0038	0,095 0.0038	0,10 0.0040
K3	218.20-080ER-M04 F25M	8,0 0.32	0,095 0.0038	0,095 0.0038	0,10 0.0040
K4	218.20-080ER-M04 F25M	8,0 0.32	0,095 0.0038	0,095 0.0038	0,10 0.0040
K5	218.20-080ER-M04 F25M	8,0 0.32	0,085 0.0034	0,085 0.0034	0,095 0.0038
K6	218.20-080ER-M04 F25M	8,0 0.32	0,095 0.0038	0,095 0.0038	0,10 0.0040
K7	218.20-080ER-M04 F25M	8,0 0.32	0,085 0.0034	0,085 0.0034	0,095 0.0038
N1	218.20-080ER-ME04 F40M	8,0 0.32	0,14 0.0055	0,14 0.0055	0,15 0.0060
N2	218.20-080ER-ME04 F40M	8,0 0.32	0,14 0.0055	0,14 0.0055	0,15 0.0060
N3	218.20-080ER-ME04 F40M	8,0 0.32	0,14 0.0055	0,14 0.0055	0,15 0.0060
N11	218.20-080ER-ME04 F40M	8,0 0.32	0,14 0.0055	0,14 0.0055	0,15 0.0060
S1	218.20-080ER-ME04 T350M	5,0 0.20	0,075 0.0030	0,075 0.0030	0,075 0.0030
S2	218.20-080ER-ME04 T350M	5,0 0.20	0,075 0.0030	0,075 0.0030	0,075 0.0030
S3	218.20-080ER-ME04 T350M	5,0 0.20	0,070 0.0028	0,070 0.0028	0,070 0.0028
S11	218.20-080ER-ME04 MS2050	6,0 0.24	0,046 0.0018	0,046 0.0018	0,050 0.0020
S12	218.20-080ER-ME04 MS2050	6,0 0.24	0,046 0.0018	0,046 0.0018	0,050 0.0020
S13	218.20-080ER-ME04 MS2050	5,0 0.20	0,042 0.0017	0,042 0.0017	0,044 0.0017
H5	218.20-080ER-M04 F25M	7,0 0.28	0,070 0.0028	0,070 0.0028	0,070 0.0028
H8	218.20-080ER-M04 F25M	6,0 0.24	0,055 0.0022	0,055 0.0022	0,055 0.0022
H11	218.20-080ER-M04 F25M	7,0 0.28	0,070 0.0028	0,070 0.0028	0,070 0.0028
H12	218.20-080ER-M04 F25M	6,0 0.24	0,055 0.0022	0,055 0.0022	0,055 0.0022
H21	218.20-080ER-M04 F25M	6,0 0.24	0,055 0.0022	0,055 0.0022	0,055 0.0022

SMG = Seco material group
 f_z = mm/tooth (in/tooth), v_c = m/min (sf/min), a_p/DC = %
 All cutting data are start values

Square shoulder and slot milling cutters
 Helical milling cutters
 Face milling cutters
 Disc milling cutters
 High feed milling cutters
 Copy milling cutters
 Plunge milling cutters
 Chamfer milling cutters
 Spot facing cutters
 Inserts

R218.20-080 – Insert selection – mm/Inch

SMG		a _p	f _z		
			15%	10%	5%
P1	218.20-080ER-ME04 F40M	8,0	0,14	0,17	0,24
		0.32	0.0055	0.0065	0.0095
P2	218.20-080ER-ME04 F40M	8,0	0,15	0,18	0,25
		0.32	0.0060	0.0070	0.010
P3	218.20-080ER-ME04 F40M	8,0	0,14	0,17	0,24
		0.32	0.0055	0.0065	0.0095
P4	218.20-080ER-M04 F25M	8,0	0,14	0,16	0,22
		0.32	0.0055	0.0065	0.0085
P5	218.20-080ER-M04 F25M	8,0	0,13	0,16	0,22
		0.32	0.0050	0.0065	0.0085
P6	218.20-080ER-M04 F25M	8,0	0,13	0,16	0,22
		0.32	0.0050	0.0065	0.0085
P7	218.20-080ER-M04 F25M	8,0	0,13	0,16	0,22
		0.32	0.0050	0.0065	0.0085
P8	218.20-080ER-M04 F25M	8,0	0,14	0,17	0,24
		0.32	0.0055	0.0065	0.0095
P11	218.20-080ER-M04 F25M	8,0	0,13	0,16	0,22
		0.32	0.0050	0.0065	0.0085
P12	218.20-080ER-M04 F25M	7,0	0,090	0,11	0,15
		0.28	0.0036	0.0044	0.0060
M1	218.20-080ER-ME04 F40M	8,0	0,15	0,18	0,25
		0.32	0.0060	0.0070	0.010
M2	218.20-080ER-ME04 F40M	8,0	0,13	0,16	0,22
		0.32	0.0050	0.0065	0.0085
M3	218.20-080ER-ME04 F40M	7,0	0,11	0,13	0,18
		0.28	0.0044	0.0050	0.0070
M4	218.20-080ER-ME04 F40M	5,0	0,095	0,11	0,15
		0.20	0.0038	0.0044	0.0060
M5	218.20-080ER-ME04 F40M	5,0	0,095	0,11	0,15
		0.20	0.0038	0.0044	0.0060
K1	218.20-080ER-M04 F25M	8,0	0,15	0,18	0,25
		0.32	0.0060	0.0070	0.010
K2	218.20-080ER-M04 F25M	8,0	0,13	0,16	0,22
		0.32	0.0050	0.0065	0.0085
K3	218.20-080ER-M04 F25M	8,0	0,13	0,16	0,22
		0.32	0.0050	0.0065	0.0085
K4	218.20-080ER-M04 F25M	8,0	0,13	0,16	0,22
		0.32	0.0050	0.0065	0.0085
K5	218.20-080ER-M04 F25M	8,0	0,12	0,14	0,20
		0.32	0.0048	0.0055	0.0080
K6	218.20-080ER-M04 F25M	8,0	0,13	0,16	0,22
		0.32	0.0050	0.0065	0.0085
K7	218.20-080ER-M04 F25M	8,0	0,12	0,14	0,20
		0.32	0.0048	0.0055	0.0080
N1	218.20-080ER-ME04 F40M	8,0	0,19	0,22	0,32
		0.32	0.0075	0.0085	0.013
N2	218.20-080ER-ME04 F40M	8,0	0,19	0,22	0,32
		0.32	0.0075	0.0085	0.013
N3	218.20-080ER-ME04 F40M	8,0	0,19	0,22	0,32
		0.32	0.0075	0.0085	0.013
N11	218.20-080ER-ME04 F40M	8,0	0,19	0,22	0,32
		0.32	0.0075	0.0085	0.013
S1	218.20-080ER-ME04 T350M	5,0	0,095	0,11	0,15
		0.20	0.0038	0.0044	0.0060
S2	218.20-080ER-ME04 T350M	5,0	0,095	0,11	0,15
		0.20	0.0038	0.0044	0.0060
S3	218.20-080ER-ME04 T350M	5,0	0,085	0,10	0,14
		0.20	0.0034	0.0040	0.0055
S11	218.20-080ER-ME04 MS2050	6,0	0,060	0,070	0,10
		0.24	0.0024	0.0028	0.0040
S12	218.20-080ER-ME04 MS2050	6,0	0,060	0,070	0,10
		0.24	0.0024	0.0028	0.0040
S13	218.20-080ER-ME04 MS2050	5,0	0,055	0,065	0,085
		0.20	0.0022	0.0026	0.0034
H5	218.20-080ER-M04 F25M	7,0	0,090	0,11	0,15
		0.28	0.0036	0.0044	0.0060
H8	218.20-080ER-M04 F25M	6,0	0,070	0,080	0,11
		0.24	0.0028	0.0032	0.0044
H11	218.20-080ER-M04 F25M	7,0	0,090	0,11	0,15
		0.28	0.0036	0.0044	0.0060
H12	218.20-080ER-M04 F25M	6,0	0,070	0,080	0,11
		0.24	0.0028	0.0032	0.0044
H21	218.20-080ER-M04 F25M	6,0	0,070	0,080	0,11
		0.24	0.0028	0.0032	0.0044

SMG = Seco material group
 f_z = mm/tooth (in/tooth), v_c = m/min (sf/min), a_p/DC = %
 All cutting data are start values

R218.20-100 – Insert selection – mm/Inch

SMG		a _p	f _z		
			100%	70%	30%
P1	218.20-100ER-ME05 F40M	11,0	0,10	0,10	0,11
		0,44	0,0040	0,0040	0,0044
P2	218.20-100ER-ME05 F40M	11,0	0,10	0,10	0,11
		0,44	0,0040	0,0040	0,0044
P3	218.20-100ER-ME05 F40M	11,0	0,10	0,10	0,11
		0,44	0,0040	0,0040	0,0044
P4	218.20-100ER-M05 F25M	11,0	0,095	0,095	0,11
		0,44	0,0038	0,0038	0,0044
P5	218.20-100ER-M05 F25M	11,0	0,095	0,095	0,10
		0,44	0,0038	0,0038	0,0040
P6	218.20-100ER-M05 F25M	11,0	0,095	0,095	0,10
		0,44	0,0038	0,0038	0,0040
P7	218.20-100ER-M05 F25M	11,0	0,095	0,095	0,10
		0,44	0,0038	0,0038	0,0040
P8	218.20-100ER-M05 F25M	11,0	0,10	0,10	0,11
		0,44	0,0040	0,0040	0,0044
P11	218.20-100ER-M05 F25M	11,0	0,095	0,095	0,10
		0,44	0,0038	0,0038	0,0040
P12	218.20-100ER-M05 F25M	9,0	0,065	0,065	0,070
		0,36	0,0026	0,0026	0,0028
M1	218.20-100ER-ME05 F40M	11,0	0,10	0,10	0,11
		0,44	0,0040	0,0040	0,0044
M2	218.20-100ER-ME05 F40M	11,0	0,095	0,095	0,10
		0,44	0,0038	0,0038	0,0040
M3	218.20-100ER-ME05 F40M	9,0	0,080	0,080	0,085
		0,36	0,0032	0,0032	0,0034
M4	218.20-100ER-ME05 F40M	6,0	0,075	0,075	0,075
		0,24	0,0030	0,0030	0,0030
M5	218.20-100ER-M05 F40M	6,0	0,075	0,075	0,075
		0,24	0,0030	0,0030	0,0030
K1	218.20-100ER-M05 F25M	11,0	0,10	0,10	0,11
		0,44	0,0040	0,0040	0,0044
K2	218.20-100ER-M05 F25M	11,0	0,095	0,095	0,10
		0,44	0,0038	0,0038	0,0040
K3	218.20-100ER-M05 F25M	11,0	0,095	0,095	0,10
		0,44	0,0038	0,0038	0,0040
K4	218.20-100ER-M05 F25M	11,0	0,095	0,095	0,10
		0,44	0,0038	0,0038	0,0040
K5	218.20-100ER-M05 F25M	11,0	0,085	0,085	0,095
		0,44	0,0034	0,0034	0,0038
K6	218.20-100ER-M05 F25M	11,0	0,095	0,095	0,10
		0,44	0,0038	0,0038	0,0040
K7	218.20-100ER-M05 F25M	11,0	0,085	0,085	0,095
		0,44	0,0034	0,0034	0,0038
N1	218.20-100ER-ME05 F40M	11,0	0,13	0,13	0,14
		0,44	0,0050	0,0050	0,0055
N2	218.20-100ER-ME05 F40M	11,0	0,13	0,13	0,14
		0,44	0,0050	0,0050	0,0055
N3	218.20-100ER-ME05 F40M	11,0	0,13	0,13	0,14
		0,44	0,0050	0,0050	0,0055
N11	218.20-100ER-ME05 F40M	11,0	0,13	0,13	0,14
		0,44	0,0050	0,0050	0,0055
S1	218.20-100ER-ME05 F40M	6,0	0,075	0,075	0,075
		0,24	0,0030	0,0030	0,0030
S2	218.20-100ER-ME05 F40M	6,0	0,075	0,075	0,075
		0,24	0,0030	0,0030	0,0030
S3	218.20-100ER-ME05 F40M	6,0	0,070	0,070	0,070
		0,24	0,0028	0,0028	0,0028
S11	218.20-100ER-ME05 MS2050	8,0	0,060	0,060	0,060
		0,32	0,0024	0,0024	0,0024
S12	218.20-100ER-ME05 MS2050	8,0	0,060	0,060	0,060
		0,32	0,0024	0,0024	0,0024
S13	218.20-100ER-ME05 MS2050	6,0	0,055	0,055	0,055
		0,24	0,0022	0,0022	0,0022
H5	218.20-100ER-M05 F25M	9,0	0,065	0,065	0,070
		0,36	0,0026	0,0026	0,0028
H8	218.20-100ER-M05 F25M	8,0	0,055	0,055	0,055
		0,32	0,0022	0,0022	0,0022
H11	218.20-100ER-M05 F25M	9,0	0,065	0,065	0,070
		0,36	0,0026	0,0026	0,0028
H12	218.20-100ER-M05 F25M	8,0	0,055	0,055	0,055
		0,32	0,0022	0,0022	0,0022
H21	218.20-100ER-M05 F25M	8,0	0,055	0,055	0,055
		0,32	0,0022	0,0022	0,0022

SMG = Seco material group
 f_z = mm/tooth (in/tooth), v_c = m/min (sf/min), a_p/DC = %
 All cutting data are start values

Square shoulder and slot milling cutters
 Helical milling cutters
 Face milling cutters
 Disc milling cutters
 High feed milling cutters
 Copy milling cutters
 Plunge milling cutters
 Chamfer milling cutters
 Spot facing cutters
 Inserts

R218.20-100 – Insert selection – mm/Inch

SMG		a_p		f_z			
				15%	10%	5%	
Square shoulder and slot milling cutters	P1	218.20-100ER-ME05 F40M	11,0	0,14	0,17	0,24	
			0,44	0,0055	0,0065	0,0095	
	P2	218.20-100ER-ME05 F40M	11,0	0,15	0,17	0,24	
			0,44	0,0060	0,0065	0,0095	
	Helical milling cutters	P3	218.20-100ER-ME05 F40M	11,0	0,14	0,16	0,22
				0,44	0,0055	0,0065	0,0085
		P4	218.20-100ER-M05 F25M	11,0	0,13	0,16	0,22
				0,44	0,0050	0,0065	0,0085
		P5	218.20-100ER-M05 F25M	11,0	0,13	0,16	0,22
				0,44	0,0050	0,0065	0,0085
		P6	218.20-100ER-M05 F25M	11,0	0,13	0,16	0,22
				0,44	0,0050	0,0065	0,0085
P7		218.20-100ER-M05 F25M	11,0	0,13	0,16	0,22	
			0,44	0,0050	0,0065	0,0085	
P8		218.20-100ER-M05 F25M	11,0	0,14	0,16	0,22	
			0,44	0,0055	0,0065	0,0085	
P11	218.20-100ER-M05 F25M	11,0	0,13	0,16	0,22		
		0,44	0,0050	0,0065	0,0085		
P12	218.20-100ER-M05 F25M	9,0	0,090	0,11	0,15		
		0,36	0,0036	0,0044	0,0060		
Disc milling cutters	M1	218.20-100ER-ME05 F40M	11,0	0,15	0,17	0,24	
			0,44	0,0060	0,0065	0,0095	
	M2	218.20-100ER-ME05 F40M	11,0	0,13	0,16	0,22	
			0,44	0,0050	0,0065	0,0085	
	M3	218.20-100ER-ME05 F40M	9,0	0,11	0,13	0,17	
0,36			0,0044	0,0050	0,0065		
M4	218.20-100ER-ME05 F40M	6,0	0,090	0,11	0,15		
		0,24	0,0036	0,0044	0,0060		
M5	218.20-100ER-ME05 F40M	6,0	0,090	0,11	0,15		
		0,24	0,0036	0,0044	0,0060		
High feed milling cutters	K1	218.20-100ER-M05 F25M	11,0	0,15	0,17	0,24	
			0,44	0,0060	0,0065	0,0095	
	K2	218.20-100ER-M05 F25M	11,0	0,13	0,16	0,22	
			0,44	0,0050	0,0065	0,0085	
	K3	218.20-100ER-M05 F25M	11,0	0,13	0,16	0,22	
			0,44	0,0050	0,0065	0,0085	
	K4	218.20-100ER-M05 F25M	11,0	0,13	0,16	0,22	
0,44			0,0050	0,0065	0,0085		
K5	218.20-100ER-M05 F25M	11,0	0,12	0,14	0,20		
		0,44	0,0048	0,0055	0,0080		
K6	218.20-100ER-M05 F25M	11,0	0,13	0,16	0,22		
		0,44	0,0050	0,0065	0,0085		
K7	218.20-100ER-M05 F25M	11,0	0,12	0,14	0,20		
		0,44	0,0048	0,0055	0,0080		
Copy milling cutters	N1	218.20-100ER-ME05 F40M	11,0	0,19	0,22	0,32	
			0,44	0,0075	0,0085	0,013	
	N2	218.20-100ER-ME05 F40M	11,0	0,19	0,22	0,32	
			0,44	0,0075	0,0085	0,013	
N3	218.20-100ER-ME05 F40M	11,0	0,19	0,22	0,32		
		0,44	0,0075	0,0085	0,013		
N11	218.20-100ER-ME05 F40M	11,0	0,19	0,22	0,32		
		0,44	0,0075	0,0085	0,013		
Plunge milling cutters	S1	218.20-100ER-ME05 F40M	6,0	0,090	0,11	0,15	
			0,24	0,0036	0,0044	0,0060	
	S2	218.20-100ER-ME05 F40M	6,0	0,090	0,11	0,15	
			0,24	0,0036	0,0044	0,0060	
	S3	218.20-100ER-ME05 F40M	6,0	0,085	0,10	0,14	
			0,24	0,0034	0,0040	0,0055	
S11	218.20-100ER-ME05 MS2050	8,0	0,075	0,090	0,12		
		0,32	0,0030	0,0036	0,0048		
S12	218.20-100ER-ME05 MS2050	8,0	0,075	0,090	0,12		
		0,32	0,0030	0,0036	0,0048		
S13	218.20-100ER-ME05 MS2050	6,0	0,065	0,080	0,11		
		0,24	0,0026	0,0032	0,0044		
Chamfer milling cutters	H5	218.20-100ER-M05 F25M	9,0	0,090	0,11	0,15	
			0,36	0,0036	0,0044	0,0060	
	H8	218.20-100ER-M05 F25M	8,0	0,070	0,080	0,11	
0,32			0,0028	0,0032	0,0044		
H11	218.20-100ER-M05 F25M	9,0	0,090	0,11	0,15		
		0,36	0,0036	0,0044	0,0060		
H12	218.20-100ER-M05 F25M	8,0	0,070	0,080	0,11		
		0,32	0,0028	0,0032	0,0044		
H21	218.20-100ER-M05 F25M	8,0	0,070	0,080	0,11		
		0,32	0,0028	0,0032	0,0044		

SMG = Seco material group
 f_z = mm/tooth (in/tooth), v_c = m/min (sf/min), a_p/DC = %
 All cutting data are start values

R218.20-125 – Insert selection – mm/Inch

SMG		a _p	f _z		
			100%	70%	30%
P1	218.20-125ER-ME07 F40M	13,0	0,10	0,10	0,11
		0.50	0.0040	0.0040	0.0044
		13,0	0,11	0,11	0,11
P2	218.20-125ER-ME07 F40M	0.50	0.0044	0.0044	0.0044
		13,0	0,10	0,10	0,11
		0.50	0.0040	0.0040	0.0044
P3	218.20-125ER-ME07 F40M	13,0	0,10	0,10	0,11
		0.50	0.0040	0.0040	0.0044
		13,0	0,10	0,10	0,11
P4	218.20-125ER-M07 F25M	0.50	0.0040	0.0040	0.0044
		13,0	0,10	0,10	0,11
		0.50	0.0040	0.0040	0.0044
P5	218.20-125ER-M07 F25M	13,0	0,095	0,095	0,10
		0.50	0.0038	0.0038	0.0040
		13,0	0,095	0,095	0,10
P6	218.20-125ER-M07 F25M	0.50	0.0038	0.0038	0.0040
		13,0	0,095	0,095	0,10
		0.50	0.0038	0.0038	0.0040
P7	218.20-125ER-M07 F25M	13,0	0,095	0,095	0,10
		0.50	0.0038	0.0038	0.0040
		13,0	0,10	0,10	0,11
P8	218.20-125ER-M07 F25M	0.50	0.0040	0.0040	0.0044
		13,0	0,095	0,095	0,10
		0.50	0.0038	0.0038	0.0040
P11	218.20-125ER-M07 F25M	13,0	0,095	0,095	0,10
		0.50	0.0038	0.0038	0.0040
		11,0	0,065	0,065	0,070
P12	218.20-125ER-M07 F25M	0.44	0.0026	0.0026	0.0028
		13,0	0,11	0,11	0,11
		0.50	0.0044	0.0044	0.0044
M1	218.20-125ER-ME07 F40M	13,0	0,095	0,095	0,10
		0.50	0.0038	0.0038	0.0040
		11,0	0,080	0,080	0,085
M2	218.20-125ER-ME07 F40M	0.44	0.0032	0.0032	0.0034
		8,0	0,075	0,075	0,075
		0.32	0.0030	0.0030	0.0030
M3	218.20-125ER-ME07 F40M	8,0	0,075	0,075	0,075
		0.32	0.0030	0.0030	0.0030
		8,0	0,075	0,075	0,075
M4	218.20-125ER-ME07 F40M	0.32	0.0030	0.0030	0.0030
		8,0	0,075	0,075	0,075
		0.32	0.0030	0.0030	0.0030
M5	218.20-125ER-M07 F40M	13,0	0,11	0,11	0,11
		0.50	0.0044	0.0044	0.0044
		13,0	0,095	0,095	0,10
K1	218.20-125ER-M07 F25M	0.50	0.0038	0.0038	0.0040
		13,0	0,095	0,095	0,10
		0.50	0.0038	0.0038	0.0040
K2	218.20-125ER-M07 F25M	13,0	0,095	0,095	0,10
		0.50	0.0038	0.0038	0.0040
		13,0	0,095	0,095	0,10
K3	218.20-125ER-M07 F25M	0.50	0.0038	0.0038	0.0040
		13,0	0,095	0,095	0,10
		0.50	0.0038	0.0038	0.0040
K4	218.20-125ER-M07 F25M	13,0	0,095	0,095	0,10
		0.50	0.0038	0.0038	0.0040
		13,0	0,085	0,085	0,095
K5	218.20-125ER-M07 F25M	0.50	0.0034	0.0034	0.0038
		13,0	0,095	0,095	0,10
		0.50	0.0038	0.0038	0.0040
K6	218.20-125ER-M07 F25M	13,0	0,085	0,085	0,095
		0.50	0.0034	0.0034	0.0038
		13,0	0,085	0,085	0,095
K7	218.20-125ER-M07 F25M	0.50	0.0034	0.0034	0.0038
		13,0	0,13	0,13	0,15
		0.50	0.0050	0.0050	0.0060
N1	218.20-125ER-ME07 F40M	13,0	0,13	0,13	0,15
		0.50	0.0050	0.0050	0.0060
		13,0	0,13	0,13	0,15
N2	218.20-125ER-ME07 F40M	0.50	0.0050	0.0050	0.0060
		13,0	0,13	0,13	0,15
		0.50	0.0050	0.0050	0.0060
N3	218.20-125ER-ME07 F40M	13,0	0,13	0,13	0,15
		0.50	0.0050	0.0050	0.0060
		13,0	0,13	0,13	0,15
N11	218.20-125ER-ME07 F40M	0.50	0.0050	0.0050	0.0060
		8,0	0,075	0,075	0,075
		0.32	0.0030	0.0030	0.0030
S1	218.20-125ER-ME07 F40M	8,0	0,075	0,075	0,075
		0.32	0.0030	0.0030	0.0030
		8,0	0,070	0,070	0,070
S2	218.20-125ER-ME07 F40M	0.32	0.0028	0.0028	0.0028
		8,0	0,085	0,085	0,085
		0.32	0.0030	0.0030	0.0030
S3	218.20-125ER-ME07 F40M	8,0	0,070	0,070	0,070
		0.32	0.0028	0.0028	0.0028
		8,0	0,085	0,085	0,085
S11	218.20-125ER-ME07 MS2050	9,0	0,085	0,085	0,085
		0.36	0.0034	0.0034	0.0034
		9,0	0,085	0,085	0,085
S12	218.20-125ER-ME07 MS2050	0.36	0.0034	0.0034	0.0034
		8,0	0,075	0,075	0,075
		0.32	0.0030	0.0030	0.0030
S13	218.20-125ER-ME07 MS2050	8,0	0,075	0,075	0,075
		0.32	0.0030	0.0030	0.0030
		11,0	0,065	0,065	0,070
H5	218.20-125ER-M07 F25M	0.44	0.0026	0.0026	0.0028
		9,0	0,055	0,055	0,055
		0.36	0.0022	0.0022	0.0022
H8	218.20-125ER-M07 F25M	11,0	0,065	0,065	0,070
		0.44	0.0026	0.0026	0.0028
		9,0	0,055	0,055	0,055
H11	218.20-125ER-M07 F25M	0.36	0.0022	0.0022	0.0022
		11,0	0,065	0,065	0,070
		0.44	0.0026	0.0026	0.0028
H12	218.20-125ER-M07 F25M	9,0	0,055	0,055	0,055
		0.36	0.0022	0.0022	0.0022
		9,0	0,055	0,055	0,055
H21	218.20-125ER-M07 F25M	0.36	0.0022	0.0022	0.0022
		9,0	0,055	0,055	0,055
		0.36	0.0022	0.0022	0.0022

SMG = Seco material group
 f_z = mm/tooth (in/tooth), v_c = m/min (sf/min), a_p/DC = %
 All cutting data are start values

R218.20-125 – Insert selection – mm/Inch

SMG		a _p	f _z		
			15%	10%	5%
P1	218.20-125ER-ME07 F40M	13,0	0,14	0,17	0,24
		0,50	0,0055	0,0065	0,0095
P2	218.20-125ER-ME07 F40M	13,0	0,15	0,17	0,24
		0,50	0,0060	0,0065	0,0095
P3	218.20-125ER-ME07 F40M	13,0	0,14	0,16	0,22
		0,50	0,0055	0,0065	0,0085
P4	218.20-125ER-M07 F25M	13,0	0,14	0,16	0,22
		0,50	0,0055	0,0065	0,0085
P5	218.20-125ER-M07 F25M	13,0	0,13	0,16	0,22
		0,50	0,0050	0,0065	0,0085
P6	218.20-125ER-M07 F25M	13,0	0,13	0,16	0,22
		0,50	0,0050	0,0065	0,0085
P7	218.20-125ER-M07 F25M	13,0	0,13	0,16	0,22
		0,50	0,0050	0,0065	0,0085
P8	218.20-125ER-M07 F25M	13,0	0,14	0,16	0,22
		0,50	0,0055	0,0065	0,0085
P11	218.20-125ER-M07 F25M	13,0	0,13	0,16	0,22
		0,50	0,0050	0,0065	0,0085
P12	218.20-125ER-M07 F25M	11,0	0,090	0,11	0,15
		0,44	0,0036	0,0044	0,0060
M1	218.20-125ER-ME07 F40M	13,0	0,15	0,17	0,24
		0,50	0,0060	0,0065	0,0095
M2	218.20-125ER-ME07 F40M	13,0	0,13	0,16	0,22
		0,50	0,0050	0,0065	0,0085
M3	218.20-125ER-ME07 F40M	11,0	0,11	0,13	0,17
		0,44	0,0044	0,0050	0,0065
M4	218.20-125ER-ME07 F40M	8,0	0,095	0,11	0,15
		0,32	0,0038	0,0044	0,0060
M5	218.20-125ER-ME07 F40M	8,0	0,095	0,11	0,15
		0,32	0,0038	0,0044	0,0060
K1	218.20-125ER-M07 F25M	13,0	0,15	0,17	0,24
		0,50	0,0060	0,0065	0,0095
K2	218.20-125ER-M07 F25M	13,0	0,13	0,16	0,22
		0,50	0,0050	0,0065	0,0085
K3	218.20-125ER-M07 F25M	13,0	0,13	0,16	0,22
		0,50	0,0050	0,0065	0,0085
K4	218.20-125ER-M07 F25M	13,0	0,13	0,16	0,22
		0,50	0,0050	0,0065	0,0085
K5	218.20-125ER-M07 F25M	13,0	0,12	0,14	0,20
		0,50	0,0048	0,0055	0,0080
K6	218.20-125ER-M07 F25M	13,0	0,13	0,16	0,22
		0,50	0,0050	0,0065	0,0085
K7	218.20-125ER-M07 F25M	13,0	0,12	0,14	0,20
		0,50	0,0048	0,0055	0,0080
N1	218.20-125ER-ME07 F40M	13,0	0,19	0,22	0,30
		0,50	0,0075	0,0085	0,012
N2	218.20-125ER-ME07 F40M	13,0	0,19	0,22	0,30
		0,50	0,0075	0,0085	0,012
N3	218.20-125ER-ME07 F40M	13,0	0,19	0,22	0,30
		0,50	0,0075	0,0085	0,012
N11	218.20-125ER-ME07 F40M	13,0	0,19	0,22	0,30
		0,50	0,0075	0,0085	0,012
S1	218.20-125ER-ME07 F40M	8,0	0,095	0,11	0,15
		0,32	0,0038	0,0044	0,0060
S2	218.20-125ER-ME07 F40M	8,0	0,095	0,11	0,15
		0,32	0,0038	0,0044	0,0060
S3	218.20-125ER-ME07 F40M	8,0	0,085	0,10	0,14
		0,32	0,0034	0,0040	0,0055
S11	218.20-125ER-ME07 MS2050	9,0	0,11	0,13	0,17
		0,36	0,0044	0,0050	0,0065
S12	218.20-125ER-ME07 MS2050	9,0	0,11	0,13	0,17
		0,36	0,0044	0,0050	0,0065
S13	218.20-125ER-ME07 MS2050	8,0	0,095	0,11	0,15
		0,32	0,0038	0,0044	0,0060
H5	218.20-125ER-M07 F25M	11,0	0,090	0,11	0,15
		0,44	0,0036	0,0044	0,0060
H8	218.20-125ER-M07 F25M	9,0	0,070	0,080	0,11
		0,36	0,0028	0,0032	0,0044
H11	218.20-125ER-M07 F25M	11,0	0,090	0,11	0,15
		0,44	0,0036	0,0044	0,0060
H12	218.20-125ER-M07 F25M	9,0	0,070	0,080	0,11
		0,36	0,0028	0,0032	0,0044
H21	218.20-125ER-M07 F25M	9,0	0,070	0,080	0,11
		0,36	0,0028	0,0032	0,0044

SMG = Seco material group
 f_z = mm/tooth (in/tooth), v_c = m/min (sf/min), a_p/DC = %
 All cutting data are start values

Square shoulder and slot milling cutters
 Helical milling cutters
 Face milling cutters
 Disc milling cutters
 High feed milling cutters
 Copy milling cutters
 Plunge milling cutters
 Chamfer milling cutters
 Spot facing cutters
 Inserts

R218.20-125 – Cutting data $v_c = (m/min)/(sf/min)$

	SMG	F25M					F40M					MM4500					MS2050				
		100%	70%	30%	10%	5%	100%	70%	30%	10%	5%	100%	70%	30%	10%	5%	100%	70%	30%	10%	5%
Square shoulder and slot milling cutters	P1	260	285	340	400	435	255	275	335	390	425	205	225	270	320	345	280	305	365	430	470
		850	940	1125	1300	1425	840	900	1100	1275	1400	670	740	890	1050	1125	920	1000	1200	1400	1550
Helical milling cutters	P2	250	270	330	390	425	245	265	325	380	415	200	215	265	310	335	270	290	355	420	455
		820	890	1075	1275	1400	800	870	1075	1250	1350	660	710	870	1025	1100	890	950	1175	1375	1500
Face milling cutters	P3	220	235	285	340	370	215	230	280	335	365	175	190	225	270	295	235	255	305	365	400
		720	770	940	1125	1225	710	750	920	1100	1200	570	620	740	890	970	770	840	1000	1200	1300
Disc milling cutters	P4	195	210	250	300	325	190	205	245	295	320	155	165	200	240	260	210	225	270	320	350
		640	690	820	980	1075	620	670	800	970	1050	510	540	660	790	850	690	740	890	1050	1150
Face milling cutters	P5	185	200	245	285	315	180	195	240	280	305	150	160	195	225	250	200	215	265	310	335
		610	660	800	940	1025	590	640	790	920	1000	490	520	640	740	820	660	710	870	1025	1100
Face milling cutters	P6	210	225	275	320	350	205	220	270	315	345	165	180	220	255	280	225	245	295	345	375
		690	740	900	1050	1150	670	720	890	1025	1125	540	590	720	840	920	740	800	970	1125	1225
Face milling cutters	P7	200	215	260	305	330	195	210	255	295	325	155	170	205	240	260	215	230	280	325	355
		660	710	850	1000	1075	640	690	840	970	1075	510	560	670	790	850	710	750	920	1075	1175
Face milling cutters	P8	185	200	240	285	315	180	195	235	280	305	145	160	190	225	250	200	215	260	310	335
		610	660	790	940	1025	590	640	770	920	1000	475	520	620	740	820	660	710	850	1025	1100
Face milling cutters	P11	190	210	250	295	320	190	205	245	290	315	150	165	200	235	255	205	225	270	315	345
		620	690	820	970	1050	620	670	800	950	1025	490	540	660	770	840	670	740	890	1025	1125
Face milling cutters	P12	130	140	165	185	205	125	135	160	185	200	100	110	130	150	160	140	150	180	200	220
		425	460	540	610	670	410	445	520	610	660	330	360	425	490	520	460	490	590	660	720
Disc milling cutters	M1	—	—	—	—	—	195	210	260	310	335	170	185	225	265	290	215	235	285	340	370
	M2	—	—	—	—	—	165	180	215	250	275	140	155	185	215	235	180	195	235	275	305
	M3	—	—	—	—	—	135	145	175	200	220	120	125	150	175	190	150	160	195	220	245
	M4	—	—	—	—	—	110	115	140	155	170	95	100	120	135	145	120	130	155	170	185
	M5	—	—	—	—	—	95	95	120	130	140	80	85	100	110	120	100	105	130	140	155
High feed milling cutters	K1	195	215	265	310	335	195	210	255	305	330	—	—	—	—	—	—	—	—	—	—
	K2	640	710	870	1025	1100	640	690	840	1000	1075	—	—	—	—	—	—	—	—	—	—
	K3	175	190	230	270	295	175	185	225	265	290	—	—	—	—	—	—	—	—	—	—
	K4	570	620	750	890	970	570	610	740	870	950	—	—	—	—	—	—	—	—	—	—
	K5	150	160	195	230	250	145	160	190	225	245	—	—	—	—	—	—	—	—	—	—
	K6	490	520	640	750	820	475	520	620	740	800	—	—	—	—	—	—	—	—	—	—
	K7	145	155	190	220	240	140	150	185	215	235	—	—	—	—	—	—	—	—	—	—
Copy milling cutters	K8	475	510	620	720	790	460	490	610	710	770	—	—	—	—	—	—	—	—	—	—
		85	95	115	135	145	85	90	110	130	140	—	—	—	—	—	—	—	—	—	—
		280	310	375	445	475	280	295	360	425	460	—	—	—	—	—	—	—	—	—	—
		125	135	165	195	210	125	135	160	190	205	—	—	—	—	—	—	—	—	—	—
Plunge milling cutters	N1	110	120	145	170	185	110	120	140	170	180	—	—	—	—	—	—	—	—	—	—
		360	395	475	560	610	360	395	460	560	590	—	—	—	—	—	—	—	—	—	—
		—	—	—	—	—	1475	1575	1900	2250	2475	—	—	—	—	—	—	—	—	—	—
		—	—	—	—	—	4850	5175	6225	7375	8125	—	—	—	—	—	—	—	—	—	—
Chamfer milling cutters	S1	—	—	—	—	—	590	640	760	910	1000	—	—	—	—	—	—	—	—	—	—
		—	—	—	—	—	1925	2100	2500	2975	3275	—	—	—	—	—	—	—	—	—	—
		—	—	—	—	—	395	425	510	610	670	—	—	—	—	—	—	—	—	—	—
		—	—	—	—	—	1300	1400	1675	2000	2200	—	—	—	—	—	—	—	—	—	—
Spot facing cutters	S2	—	—	—	—	—	450	485	580	690	760	—	—	—	—	—	—	—	—	—	—
		—	—	—	—	—	1475	1600	1900	2275	2500	—	—	—	—	—	—	—	—	—	—
		55	55	70	75	80	50	55	65	70	80	29	31	37	41	45	55	60	75	80	85
		180	180	230	245	260	165	180	215	230	260	95	100	120	135	150	180	195	245	260	280
Inserts	H5	43	45	55	60	65	42	44	55	60	65	24	25	30	33	36	46	48	60	65	70
		140	150	180	195	215	140	145	180	195	215	80	80	100	110	120	150	155	195	215	230
		37	39	48	50	55	36	38	47	50	55	21	22	26	29	31	40	42	50	55	60
		120	130	155	165	180	120	125	155	165	180	70	70	85	95	100	130	140	165	180	195
Chamfer milling cutters	S3	75	75	95	105	115	70	75	90	100	110	40	43	50	55	65	80	85	100	110	125
		245	245	310	345	375	230	245	295	330	360	130	140	165	180	215	260	280	330	360	410
		50	55	65	70	80	49	50	65	70	75	37	39	48	55	60	55	60	70	75	85
		165	180	215	230	260	160	165	215	230	245	120	130	155	180	195	180	195	230	245	280
Spot facing cutters	S11	30	31	38	42	45	29	31	37	41	44	22	23	28	31	34	32	34	41	45	49
		100	100	125	140	150	95	100	120	135	145	70	75	90	100	110	105	110	135	150	160
		43	46	55	60	70	42	45	55	60	65	—	—	—	—	—	—	—	—	—	—
		140	150	180	195	230	140	150	180	195	215	—	—	—	—	—	—	—	—	—	—
Spot facing cutters	H8	46	49	60	65	70	45	48	60	65	70	—	—	—	—	—	—	—	—	—	—
		150	160	195	215	230	150	155	195	215	230	—	—	—	—	—	—	—	—	—	—
		55	60	70	80	85	55	55	70	75	85	—	—	—	—	—	—	—	—	—	—
		180	195	230	260	280	180	180	230	245	280	—	—	—	—	—	—	—	—	—	—
Inserts	H11	85	90	105	120	130	80	85	105	115	125	—	—	—	—	—	—	—	—	—	—
		280	295	345	395	425	260	280	345	375	410	—	—	—	—	—	—	—	—	—	—
		46	49	60	65	70	45	48	60	65	70	—	—	—	—	—	—	—	—	—	—
		150	160	195	215	230	150	155	195	215	230	—	—	—	—	—	—	—	—	—	—

R218.20-150 – Insert selection – mm/Inch

SMG			a _p	f _z		
				100%	70%	30%
P1	218.20-150ER-ME07 F40M	SPMT100408T-M08 F40M	26,0	0,14	0,14	0,15
			1,0	0,0055	0,0055	0,0060
P2	218.20-150ER-ME07 F40M	SPMT100408T-M08 F40M	26,0	0,14	0,14	0,16
			1,0	0,0055	0,0055	0,0065
P3	218.20-150ER-ME07 F40M	SPMT100408T-M08 F40M	26,0	0,14	0,14	0,15
			1,0	0,0055	0,0055	0,0060
P4	218.20-150ER-M08 F40M	SPMT100408T-M08 F40M	26,0	0,13	0,13	0,15
			1,0	0,0050	0,0050	0,0060
P5	218.20-150ER-M08 F40M	SPMT100408T-M08 F40M	26,0	0,13	0,13	0,14
			1,0	0,0050	0,0050	0,0055
P6	218.20-150ER-M08 F40M	SPMT100408T-M08 F40M	26,0	0,13	0,13	0,14
			1,0	0,0050	0,0050	0,0055
P7	218.20-150ER-M08 F40M	SPMT100408T-M08 F40M	26,0	0,13	0,13	0,14
			1,0	0,0050	0,0050	0,0055
P8	218.20-150ER-M08 F40M	SPMT100408T-M08 F40M	26,0	0,14	0,14	0,15
			1,0	0,0055	0,0055	0,0060
P11	218.20-150ER-M08 F40M	SPMT100408T-M08 F40M	26,0	0,13	0,13	0,14
			1,0	0,0050	0,0050	0,0055
P12	218.20-150ER-M08 F40M	SPMT100408T-M08 F40M	21,0	0,090	0,090	0,10
			0,85	0,0036	0,0036	0,0040
M1	218.20-150ER-ME07 F40M	SPMT100408T-M08 F40M	26,0	0,14	0,14	0,16
			1,0	0,0055	0,0055	0,0065
M2	218.20-150ER-ME07 F40M	SPMT100408T-M08 F40M	26,0	0,13	0,13	0,14
			1,0	0,0050	0,0050	0,0055
M3	218.20-150ER-ME07 F40M	SPMT100408T-M08 F40M	21,0	0,11	0,11	0,12
			0,85	0,0044	0,0044	0,0048
M4	218.20-150ER-ME07 F40M	SPMT100408T-M08 F40M	16,0	0,095	0,095	0,10
			0,65	0,0038	0,0038	0,0040
M5	218.20-150ER-M08 F40M	SPMT100408T-M08 F40M	16,0	0,095	0,095	0,10
			0,65	0,0038	0,0038	0,0040
K1	218.20-150ER-M08 F40M	SPMT100408T-M08 F40M	26,0	0,14	0,14	0,16
			1,0	0,0055	0,0055	0,0065
K2	218.20-150ER-M08 F40M	SPMT100408T-M08 F40M	26,0	0,13	0,13	0,14
			1,0	0,0050	0,0050	0,0055
K3	218.20-150ER-M08 F40M	SPMT100408T-M08 F40M	26,0	0,13	0,13	0,14
			1,0	0,0050	0,0050	0,0055
K4	218.20-150ER-M08 F40M	SPMT100408T-M08 F40M	26,0	0,13	0,13	0,14
			1,0	0,0050	0,0050	0,0055
K5	218.20-150ER-M08 F40M	SPMT100408T-M08 F40M	26,0	0,12	0,12	0,13
			1,0	0,0048	0,0048	0,0050
K6	218.20-150ER-M08 F40M	SPMT100408T-M08 F40M	26,0	0,13	0,13	0,14
			1,0	0,0050	0,0050	0,0055
K7	218.20-150ER-M08 F40M	SPMT100408T-M08 F40M	26,0	0,12	0,12	0,13
			1,0	0,0048	0,0048	0,0050
N1	218.20-150ER-ME07 F40M	SPMT100408T-M08 F40M	26,0	0,18	0,18	0,20
			1,0	0,0070	0,0070	0,0080
N2	218.20-150ER-ME07 F40M	SPMT100408T-M08 F40M	26,0	0,18	0,18	0,20
			1,0	0,0070	0,0070	0,0080
N3	218.20-150ER-ME07 F40M	SPMT100408T-M08 F40M	26,0	0,18	0,18	0,20
			1,0	0,0070	0,0070	0,0080
N11	218.20-150ER-ME07 F40M	SPMT100408T-M08 F40M	26,0	0,18	0,18	0,20
			1,0	0,0070	0,0070	0,0080
S1	218.20-150ER-ME07 F40M	SPMT100408T-M08 F40M	16,0	0,095	0,095	0,10
			0,65	0,0038	0,0038	0,0040
S2	218.20-150ER-ME07 F40M	SPMT100408T-M08 F40M	16,0	0,095	0,095	0,10
			0,65	0,0038	0,0038	0,0040
S3	218.20-150ER-ME07 F40M	SPMT100408T-M08 F40M	16,0	0,090	0,090	0,095
			0,65	0,0036	0,0036	0,0038
S11	218.20-150ER-ME07 MS2050	SPMT100408T-M08 F40M	18,0	0,075	0,075	0,080
			0,70	0,0030	0,0030	0,0032
S12	218.20-150ER-ME07 MS2050	SPMT100408T-M08 F40M	18,0	0,075	0,075	0,080
			0,70	0,0030	0,0030	0,0032
S13	218.20-150ER-ME07 MS2050	SPMT100408T-M08 F40M	16,0	0,065	0,065	0,070
			0,65	0,0026	0,0026	0,0028

SMG = Seco material group
 f_z = mm/tooth (in/tooth), v_c = m/min (sf/min), a_p/DC = %
 All cutting data are start values

Square shoulder and slot milling cutters
 Helical milling cutters
 Face milling cutters
 Disc milling cutters
 High feed milling cutters
 Copy milling cutters
 Plunge milling cutters
 Chamfer milling cutters
 Spot facing cutters
 Inserts

R218.20-150 – Insert selection – mm/Inch

SMG			a_p	f_z				
				15%	10%	5%		
Square shoulder and slot milling cutters	P1	218.20-150ER-ME07 F40M	SPMT100408T-M08 F40M	26,0 1,0	0,20 0,0080	0,24 0,0095	0,34 0,013	
	P2	218.20-150ER-ME07 F40M	SPMT100408T-M08 F40M	26,0 1,0	0,20 0,0080	0,24 0,0095	0,34 0,013	
	Helical milling cutters	P3	218.20-150ER-ME07 F40M	SPMT100408T-M08 F40M	26,0 1,0	0,19 0,0075	0,22 0,0085	0,32 0,013
		P4	218.20-150ER-M08 F40M	SPMT100408T-M08 F40M	26,0 1,0	0,19 0,0075	0,22 0,0085	0,32 0,013
		P5	218.20-150ER-M08 F40M	SPMT100408T-M08 F40M	26,0 1,0	0,18 0,0070	0,22 0,0085	0,30 0,012
		P6	218.20-150ER-M08 F40M	SPMT100408T-M08 F40M	26,0 1,0	0,18 0,0070	0,22 0,0085	0,30 0,012
		P7	218.20-150ER-M08 F40M	SPMT100408T-M08 F40M	26,0 1,0	0,18 0,0070	0,22 0,0085	0,30 0,012
		P8	218.20-150ER-M08 F40M	SPMT100408T-M08 F40M	26,0 1,0	0,19 0,0075	0,22 0,0085	0,32 0,013
	Face milling cutters	P11	218.20-150ER-M08 F40M	SPMT100408T-M08 F40M	26,0 1,0	0,18 0,0070	0,22 0,0085	0,30 0,012
		P12	218.20-150ER-M08 F40M	SPMT100408T-M08 F40M	21,0 0,85	0,12 0,0048	0,15 0,0060	0,20 0,0080
		Disc milling cutters	M1	218.20-150ER-ME07 F40M	SPMT100408T-M08 F40M	26,0 1,0	0,20 0,0080	0,24 0,0095
	M2		218.20-150ER-ME07 F40M	SPMT100408T-M08 F40M	26,0 1,0	0,18 0,0070	0,22 0,0085	0,30 0,012
M3	218.20-150ER-ME07 F40M		SPMT100408T-M08 F40M	21,0 0,85	0,15 0,0060	0,18 0,0070	0,24 0,0085	
M4	218.20-150ER-ME07 F40M		SPMT100408T-M08 F40M	16,0 0,65	0,13 0,0050	0,15 0,0060	0,22 0,0085	
M5	218.20-150ER-ME07 F40M		SPMT100408T-M08 F40M	16,0 0,65	0,13 0,0050	0,15 0,0060	0,22 0,0085	
High feed milling cutters	K1	218.20-150ER-M08 F40M	SPMT100408T-M08 F40M	26,0 1,0	0,20 0,0080	0,24 0,0095	0,34 0,013	
	K2	218.20-150ER-M08 F40M	SPMT100408T-M08 F40M	26,0 1,0	0,18 0,0070	0,22 0,0085	0,30 0,012	
	K3	218.20-150ER-M08 F40M	SPMT100408T-M08 F40M	26,0 1,0	0,18 0,0070	0,22 0,0085	0,30 0,012	
	K4	218.20-150ER-M08 F40M	SPMT100408T-M08 F40M	26,0 1,0	0,18 0,0070	0,22 0,0085	0,30 0,012	
	K5	218.20-150ER-M08 F40M	SPMT100408T-M08 F40M	26,0 1,0	0,17 0,0065	0,20 0,0080	0,28 0,011	
	K6	218.20-150ER-M08 F40M	SPMT100408T-M08 F40M	26,0 1,0	0,18 0,0070	0,22 0,0085	0,30 0,012	
	K7	218.20-150ER-M08 F40M	SPMT100408T-M08 F40M	26,0 1,0	0,17 0,0065	0,20 0,0080	0,28 0,011	
Copy milling cutters	N1	218.20-150ER-ME07 F40M	SPMT100408T-M08 F40M	26,0 1,0	0,26 0,010	0,30 0,012	0,44 0,017	
	N2	218.20-150ER-ME07 F40M	SPMT100408T-M08 F40M	26,0 1,0	0,26 0,010	0,30 0,012	0,44 0,017	
	N3	218.20-150ER-ME07 F40M	SPMT100408T-M08 F40M	26,0 1,0	0,26 0,010	0,30 0,012	0,44 0,017	
	N11	218.20-150ER-ME07 F40M	SPMT100408T-M08 F40M	26,0 1,0	0,26 0,010	0,30 0,012	0,44 0,017	
Plunge milling cutters	S1	218.20-150ER-ME07 F40M	SPMT100408T-M08 F40M	16,0 0,65	0,13 0,0050	0,15 0,0060	0,22 0,0085	
	S2	218.20-150ER-ME07 F40M	SPMT100408T-M08 F40M	16,0 0,65	0,13 0,0050	0,15 0,0060	0,22 0,0085	
	S3	218.20-150ER-ME07 F40M	SPMT100408T-M08 F40M	16,0 0,65	0,12 0,0048	0,14 0,0055	0,20 0,0080	
	Chamfer milling cutters	S11	218.20-150ER-ME07 MS2050	SPMT100408T-M08 F40M	18,0 0,70	0,10 0,0040	0,12 0,0048	0,17 0,0065
S12		218.20-150ER-ME07 MS2050	SPMT100408T-M08 F40M	18,0 0,70	0,10 0,0040	0,12 0,0048	0,17 0,0065	
Spot facing cutters		S13	218.20-150ER-ME07 MS2050	SPMT100408T-M08 F40M	16,0 0,65	0,090 0,0036	0,11 0,0044	0,15 0,0060

SMG = Seco material group
 f_z = mm/tooth (in/tooth), v_c = m/min (sf/min), a_p/DC = %
 All cutting data are start values

R218.20-150 – Cutting data $v_c = (m/min)/(sf/min)$

SMG	F40M					MM4500					MS2050				
	100%	70%	30%	10%	5%	100%	70%	30%	10%	5%	100%	70%	30%	10%	5%
P1	220	240	290	345	375	170	180	225	265	285	270	290	350	415	450
	720	790	950	1125	1225	560	590	740	870	940	890	950	1150	1350	1475
P2	215	235	285	335	365	165	180	215	255	280	255	280	340	405	435
	710	770	940	1100	1200	540	590	710	840	920	840	920	1125	1325	1425
P3	190	205	250	290	320	145	155	190	220	245	225	245	295	350	385
	620	670	820	950	1050	475	510	620	720	800	740	800	970	1150	1275
P4	165	180	220	255	280	125	135	165	195	215	200	215	260	310	335
	540	590	720	840	920	410	445	540	640	710	660	710	850	1025	1100
P5	160	170	210	250	270	120	130	160	190	205	190	210	255	295	320
	520	560	690	820	890	395	425	520	620	670	620	690	840	970	1050
P6	180	195	235	280	300	135	145	180	215	230	215	235	285	330	360
	590	640	770	920	980	445	475	590	710	750	710	770	940	1075	1175
P7	170	180	220	265	285	130	140	170	200	215	205	220	270	315	340
	560	590	720	870	940	425	460	560	660	710	670	720	890	1025	1125
P8	160	170	210	245	270	120	130	160	185	205	190	205	245	295	320
	520	560	690	800	890	395	425	520	610	670	620	670	800	970	1050
P11	165	175	215	255	275	125	135	165	195	210	200	215	260	305	330
	540	570	710	840	900	410	445	540	640	690	660	710	850	1000	1075
P12	115	120	145	165	180	85	90	110	125	135	130	140	175	195	210
	375	395	475	540	590	280	295	360	410	445	425	460	570	640	690
M1	175	190	230	270	295	140	150	185	220	240	205	225	275	325	350
	570	620	750	890	970	460	490	610	720	790	670	740	900	1075	1150
M2	145	155	190	225	240	115	125	155	185	195	175	185	225	265	290
	475	510	620	740	790	375	410	510	610	640	570	610	740	870	950
M3	125	130	160	180	195	100	105	130	145	160	145	155	190	210	235
	410	425	520	590	640	330	345	425	475	520	475	510	620	690	770
M4	100	105	125	140	150	80	85	105	110	120	115	125	150	165	180
	330	345	410	460	490	260	280	345	360	395	375	410	490	540	590
M5	85	90	105	115	125	70	70	85	95	100	100	105	125	135	150
	280	295	345	375	410	230	230	280	310	330	330	345	410	445	490
K1	170	185	225	265	290	—	—	—	—	—	—	—	—	—	—
	560	610	740	870	950	—	—	—	—	—	—	—	—	—	—
K2	150	165	200	235	255	—	—	—	—	—	—	—	—	—	—
	490	540	660	770	840	—	—	—	—	—	—	—	—	—	—
K3	130	140	170	200	215	—	—	—	—	—	—	—	—	—	—
	425	460	560	660	710	—	—	—	—	—	—	—	—	—	—
K4	120	130	160	190	205	—	—	—	—	—	—	—	—	—	—
	395	425	520	620	670	—	—	—	—	—	—	—	—	—	—
K5	75	80	100	115	125	—	—	—	—	—	—	—	—	—	—
	245	260	330	375	410	—	—	—	—	—	—	—	—	—	—
K6	105	115	140	170	180	—	—	—	—	—	—	—	—	—	—
	345	375	460	560	590	—	—	—	—	—	—	—	—	—	—
K7	95	105	125	150	160	—	—	—	—	—	—	—	—	—	—
	310	345	410	490	520	—	—	—	—	—	—	—	—	—	—
N1	1275	1375	1675	1975	2150	—	—	—	—	—	—	—	—	—	—
	4175	4500	5500	6475	7050	—	—	—	—	—	—	—	—	—	—
N2	510	550	680	790	870	—	—	—	—	—	—	—	—	—	—
	1675	1800	2225	2600	2850	—	—	—	—	—	—	—	—	—	—
N3	340	365	450	530	580	—	—	—	—	—	—	—	—	—	—
	1125	1200	1475	1750	1900	—	—	—	—	—	—	—	—	—	—
N11	390	420	520	600	660	—	—	—	—	—	—	—	—	—	—
	1275	1375	1700	1975	2175	—	—	—	—	—	—	—	—	—	—
S1	47	49	60	65	70	25	26	31	34	37	55	55	70	75	85
	155	160	195	215	230	80	85	100	110	120	180	180	230	245	280
S2	38	40	47	50	55	20	21	25	28	30	44	46	55	60	65
	125	130	155	165	180	65	70	80	90	100	145	150	180	195	215
S3	33	34	42	45	50	18	18	22	24	26	38	40	49	55	60
	110	110	140	150	165	60	60	70	80	85	125	130	160	180	195
S11	65	65	85	90	100	34	36	44	48	55	75	80	100	105	120
	215	215	280	295	330	110	120	145	155	180	245	260	330	345	395
S12	44	46	55	65	70	31	33	41	45	49	55	55	70	75	80
	145	150	180	215	230	100	110	135	150	160	180	180	230	245	260
S13	26	28	33	36	40	19	20	24	26	28	31	32	39	43	47
	85	90	110	120	130	60	65	80	85	90	100	105	130	140	155

Square shoulder and slot milling cutters
Helical milling cutters
Face milling cutters
Disc milling cutters
High feed milling cutters
Copy milling cutters
Plunge milling cutters
Chamfer milling cutters
Spot facing cutters
Inserts

R218.20-160 – Insert selection – mm/Inch

SMG			a _p	f _z				
				100%	70%	30%		
Square shoulder and slot milling cutters	P1	218.20-160ER-ME08 F40M	SPMT100408T-M08 F40M	32,0 1,3	0,14 0,0055	0,14 0,0055	0,15 0,0060	
	P2	218.20-160ER-ME08 F40M	SPMT100408T-M08 F40M	32,0 1,3	0,14 0,0055	0,14 0,0055	0,16 0,0065	
	Helical milling cutters	P3	218.20-160ER-ME08 F40M	SPMT100408T-M08 F40M	32,0 1,3	0,14 0,0055	0,14 0,0055	0,15 0,0060
		P4	218.20-160ER-M08 F25M	SPMT100408T-M08 F40M	32,0 1,3	0,13 0,0050	0,13 0,0050	0,14 0,0055
		P5	218.20-160ER-M08 F25M	SPMT100408T-M08 F40M	32,0 1,3	0,13 0,0050	0,13 0,0050	0,14 0,0055
		P6	218.20-160ER-M08 F25M	SPMT100408T-M08 F40M	32,0 1,3	0,13 0,0050	0,13 0,0050	0,14 0,0055
		P7	218.20-160ER-M08 F25M	SPMT100408T-M08 F40M	32,0 1,3	0,13 0,0050	0,13 0,0050	0,14 0,0055
		P8	218.20-160ER-M08 F25M	SPMT100408T-M08 F40M	32,0 1,3	0,14 0,0055	0,14 0,0055	0,15 0,0060
	Face milling cutters	P11	218.20-160ER-M08 F25M	SPMT100408T-M08 F40M	32,0 1,3	0,13 0,0050	0,13 0,0050	0,14 0,0055
		P12	218.20-160ER-M08 F25M	SPMT100408T-M08 F40M	26,0 1,0	0,090 0,0036	0,090 0,0036	0,095 0,0038
		Disc milling cutters	M1	218.20-160ER-ME08 F40M	SPMT100408T-M08 F40M	32,0 1,3	0,14 0,0055	0,14 0,0055
	M2		218.20-160ER-ME08 F40M	SPMT100408T-M08 F40M	32,0 1,3	0,13 0,0050	0,13 0,0050	0,14 0,0055
M3	218.20-160ER-ME08 F40M		SPMT100408T-M08 F40M	26,0 1,0	0,10 0,0040	0,10 0,0040	0,11 0,0044	
M4	218.20-160ER-ME08 F40M		SPMT100408T-M08 F40M	19,0 0,75	0,095 0,0038	0,095 0,0038	0,10 0,0040	
M5	218.20-160ER-M08 F40M		SPMT100408T-M08 F40M	19,0 0,75	0,095 0,0038	0,095 0,0038	0,10 0,0040	
High feed milling cutters	K1	218.20-160ER-M08 F25M	SPMT100408T-M08 F25M	32,0 1,3	0,14 0,0055	0,14 0,0055	0,16 0,0065	
	K2	218.20-160ER-M08 F25M	SPMT100408T-M08 F25M	32,0 1,3	0,13 0,0050	0,13 0,0050	0,14 0,0055	
	K3	218.20-160ER-M08 F25M	SPMT100408T-M08 F25M	32,0 1,3	0,13 0,0050	0,13 0,0050	0,14 0,0055	
	K4	218.20-160ER-M08 F25M	SPMT100408T-M08 F25M	32,0 1,3	0,13 0,0050	0,13 0,0050	0,14 0,0055	
	K5	218.20-160ER-M08 F25M	SPMT100408T-M08 F25M	32,0 1,3	0,12 0,0048	0,12 0,0048	0,13 0,0050	
	K6	218.20-160ER-M08 F25M	SPMT100408T-M08 F25M	32,0 1,3	0,13 0,0050	0,13 0,0050	0,14 0,0055	
	K7	218.20-160ER-M08 F25M	SPMT100408T-M08 F25M	32,0 1,3	0,12 0,0048	0,12 0,0048	0,13 0,0050	
Copy milling cutters	N1	218.20-160ER-ME08 F40M	SPMT100408T-M08 F25M	32,0 1,3	0,18 0,0070	0,18 0,0070	0,20 0,0080	
	N2	218.20-160ER-ME08 F40M	SPMT100408T-M08 F25M	32,0 1,3	0,18 0,0070	0,18 0,0070	0,20 0,0080	
	N3	218.20-160ER-ME08 F40M	SPMT100408T-M08 F25M	32,0 1,3	0,18 0,0070	0,18 0,0070	0,20 0,0080	
	N11	218.20-160ER-ME08 F40M	SPMT100408T-M08 F25M	32,0 1,3	0,18 0,0070	0,18 0,0070	0,20 0,0080	
Plunge milling cutters	S1	218.20-160ER-ME08 F40M	SPMT100408T-M08 F40M	19,0 0,75	0,095 0,0038	0,095 0,0038	0,10 0,0040	
	S2	218.20-160ER-ME08 F40M	SPMT100408T-M08 F40M	19,0 0,75	0,095 0,0038	0,095 0,0038	0,10 0,0040	
	S3	218.20-160ER-ME08 F40M	SPMT100408T-M08 F40M	19,0 0,75	0,090 0,0036	0,090 0,0036	0,095 0,0038	
	S11	218.20-160ER-ME08 MS2050	SPMT100408T-M08 F40M	23,0 0,90	0,085 0,0034	0,085 0,0034	0,090 0,0036	
	S12	218.20-160ER-ME08 MS2050	SPMT100408T-M08 F40M	23,0 0,90	0,085 0,0034	0,085 0,0034	0,090 0,0036	
	S13	218.20-160ER-ME08 MS2050	SPMT100408T-M08 F40M	19,0 0,75	0,075 0,0030	0,075 0,0030	0,080 0,0032	
Chamfer milling cutters	H5	218.20-160ER-M08 F25M	SPMT100408T-M08 F25M	26,0 1,0	0,090 0,0036	0,090 0,0036	0,095 0,0038	
	H8	218.20-160ER-M08 F25M	SPMT100408T-M08 F25M	23,0 0,90	0,070 0,0028	0,070 0,0028	0,075 0,0030	
	H11	218.20-160ER-M08 F25M	SPMT100408T-M08 F25M	26,0 1,0	0,090 0,0036	0,090 0,0036	0,095 0,0038	
	H12	218.20-160ER-M08 F25M	SPMT100408T-M08 F25M	23,0 0,90	0,070 0,0028	0,070 0,0028	0,075 0,0030	
Spot facing cutters	H21	218.20-160ER-M08 F25M	SPMT100408T-M08 F25M	23,0 0,90	0,070 0,0028	0,070 0,0028	0,075 0,0030	

SMG = Seco material group
 f_z = mm/tooth (in/tooth), v_c = m/min (sf/min), a_p/DC = %
 All cutting data are start values

R218.20-160 – Insert selection – mm/Inch

SMG			a _p	f _z		
				15%	10%	5%
P1	218.20-160ER-ME08 F40M	SPMT100408T-M08 F40M	32,0	0,20	0,24	0,32
			1,3	0,0080	0,0095	0,013
P2	218.20-160ER-ME08 F40M	SPMT100408T-M08 F40M	32,0	0,20	0,24	0,34
			1,3	0,0080	0,0095	0,013
P3	218.20-160ER-ME08 F40M	SPMT100408T-M08 F40M	32,0	0,19	0,22	0,32
			1,3	0,0075	0,0085	0,013
P4	218.20-160ER-M08 F25M	SPMT100408T-M08 F40M	32,0	0,19	0,22	0,30
			1,3	0,0075	0,0085	0,012
P5	218.20-160ER-M08 F25M	SPMT100408T-M08 F40M	32,0	0,18	0,22	0,30
			1,3	0,0070	0,0085	0,012
P6	218.20-160ER-M08 F25M	SPMT100408T-M08 F40M	32,0	0,18	0,22	0,30
			1,3	0,0070	0,0085	0,012
P7	218.20-160ER-M08 F25M	SPMT100408T-M08 F40M	32,0	0,18	0,22	0,30
			1,3	0,0070	0,0085	0,012
P8	218.20-160ER-M08 F25M	SPMT100408T-M08 F40M	32,0	0,19	0,22	0,32
			1,3	0,0075	0,0085	0,013
P11	218.20-160ER-M08 F25M	SPMT100408T-M08 F40M	32,0	0,18	0,22	0,30
			1,3	0,0070	0,0085	0,012
P12	218.20-160ER-M08 F25M	SPMT100408T-M08 F40M	26,0	0,12	0,15	0,20
			1,0	0,0048	0,0060	0,0080
M1	218.20-160ER-ME08 F40M	SPMT100408T-M08 F40M	32,0	0,20	0,24	0,34
			1,3	0,0080	0,0095	0,013
M2	218.20-160ER-ME08 F40M	SPMT100408T-M08 F40M	32,0	0,18	0,22	0,30
			1,3	0,0070	0,0085	0,012
M3	218.20-160ER-ME08 F40M	SPMT100408T-M08 F40M	26,0	0,15	0,17	0,24
			1,0	0,0060	0,0065	0,0095
M4	218.20-160ER-ME08 F40M	SPMT100408T-M08 F40M	19,0	0,13	0,15	0,22
			0,75	0,0050	0,0060	0,0085
M5	218.20-160ER-ME08 F40M	SPMT100408T-M08 F40M	19,0	0,13	0,15	0,22
			0,75	0,0050	0,0060	0,0085
K1	218.20-160ER-M08 F25M	SPMT100408T-M08 F40M	32,0	0,20	0,24	0,34
			1,3	0,0080	0,0095	0,013
K2	218.20-160ER-M08 F25M	SPMT100408T-M08 F40M	32,0	0,18	0,22	0,30
			1,3	0,0070	0,0085	0,012
K3	218.20-160ER-M08 F25M	SPMT100408T-M08 F40M	32,0	0,18	0,22	0,30
			1,3	0,0070	0,0085	0,012
K4	218.20-160ER-M08 F25M	SPMT100408T-M08 F40M	32,0	0,18	0,22	0,30
			1,3	0,0070	0,0085	0,012
K5	218.20-160ER-M08 F25M	SPMT100408T-M08 F40M	32,0	0,16	0,20	0,28
			1,3	0,0065	0,0080	0,011
K6	218.20-160ER-M08 F25M	SPMT100408T-M08 F40M	32,0	0,18	0,22	0,30
			1,3	0,0070	0,0085	0,012
K7	218.20-160ER-M08 F25M	SPMT100408T-M08 F40M	32,0	0,16	0,20	0,28
			1,3	0,0065	0,0080	0,011
N1	218.20-160ER-ME08 F40M	SPMT100408T-M08 F40M	32,0	0,26	0,30	0,42
			1,3	0,010	0,012	0,017
N2	218.20-160ER-ME08 F40M	SPMT100408T-M08 F40M	32,0	0,26	0,30	0,42
			1,3	0,010	0,012	0,017
N3	218.20-160ER-ME08 F40M	SPMT100408T-M08 F40M	32,0	0,26	0,30	0,42
			1,3	0,010	0,012	0,017
N11	218.20-160ER-ME08 F40M	SPMT100408T-M08 F40M	32,0	0,26	0,30	0,42
			1,3	0,010	0,012	0,017
S1	218.20-160ER-ME08 F40M	SPMT100408T-M08 F40M	19,0	0,13	0,15	0,22
			0,75	0,0050	0,0060	0,0085
S2	218.20-160ER-ME08 F40M	SPMT100408T-M08 F40M	19,0	0,13	0,15	0,22
			0,75	0,0050	0,0060	0,0085
S3	218.20-160ER-ME08 F40M	SPMT100408T-M08 F40M	19,0	0,12	0,14	0,20
			0,75	0,0048	0,0055	0,0080
S11	218.20-160ER-ME08 MS2050	SPMT100408T-M08 F40M	23,0	0,12	0,14	0,19
			0,90	0,0048	0,0055	0,0075
S12	218.20-160ER-ME08 MS2050	SPMT100408T-M08 F40M	23,0	0,12	0,14	0,19
			0,90	0,0048	0,0055	0,0075
S13	218.20-160ER-ME08 MS2050	SPMT100408T-M08 F40M	19,0	0,10	0,12	0,17
			0,75	0,0040	0,0048	0,0065
H5	218.20-160ER-M08 F25M	SPMT100408T-M08 F40M	26,0	0,12	0,15	0,20
			1,0	0,0048	0,0060	0,0080
H8	218.20-160ER-M08 F25M	SPMT100408T-M08 F40M	23,0	0,095	0,11	0,16
			0,90	0,0038	0,0044	0,0065
H11	218.20-160ER-M08 F25M	SPMT100408T-M08 F40M	26,0	0,12	0,15	0,20
			1,0	0,0048	0,0060	0,0080
H12	218.20-160ER-M08 F25M	SPMT100408T-M08 F40M	23,0	0,095	0,11	0,16
			0,90	0,0038	0,0044	0,0065
H21	218.20-160ER-M08 F25M	SPMT100408T-M08 F40M	23,0	0,095	0,11	0,16
			0,90	0,0038	0,0044	0,0065

SMG = Seco material group
 f_z = mm/tooth (in/tooth), v_c = m/min (sf/min), a_p/DC = %
 All cutting data are start values

Square shoulder and slot milling cutters
 Helical milling cutters
 Face milling cutters
 Disc milling cutters
 High feed milling cutters
 Copy milling cutters
 Plunge milling cutters
 Chamfer milling cutters
 Spot facing cutters
 Inserts

R218.20-160 – Cutting data $v_c = (m/min)/(sf/min)$

SMG	F25M					F40M					MM4500					MS2050				
	100%	70%	30%	10%	5%	100%	70%	30%	10%	5%	100%	70%	30%	10%	5%	100%	70%	30%	10%	5%
P1	230	250	300	360	390	220	240	290	345	375	180	195	235	280	305	260	280	340	405	435
	750	820	980	1175	1275	720	790	950	1125	1225	590	640	770	920	1000	850	920	1125	1325	1425
P2	225	240	295	345	380	215	235	285	335	365	175	190	230	270	295	250	270	330	390	425
	740	790	970	1125	1250	710	770	940	1100	1200	570	620	750	890	970	820	890	1075	1275	1400
P3	195	210	260	300	330	190	205	250	290	320	155	165	200	235	260	220	240	290	340	370
	640	690	850	980	1075	620	670	820	950	1050	510	540	660	770	850	720	790	950	1125	1225
P4	170	185	225	265	290	165	180	220	255	280	135	145	175	210	230	195	210	255	300	330
	560	610	740	870	950	540	590	720	840	920	445	475	570	690	750	640	690	840	980	1075
P5	165	180	215	260	280	160	170	210	250	270	130	140	170	205	220	185	200	245	290	315
	540	590	710	850	920	520	560	690	820	890	425	460	560	670	720	610	660	800	950	1025
P6	185	200	245	290	315	180	195	235	280	300	145	155	190	225	245	210	225	270	325	350
	610	660	800	950	1025	590	640	770	920	980	475	510	620	740	800	690	740	890	1075	1150
P7	175	190	230	275	295	170	180	220	265	285	135	145	180	215	230	195	215	255	305	330
	570	620	750	900	970	560	590	720	870	940	445	475	590	710	750	640	710	840	1000	1075
P8	165	180	215	255	280	160	170	210	245	270	130	140	170	200	220	185	200	245	285	310
	540	590	710	840	920	520	560	690	800	890	425	460	560	660	720	610	660	800	940	1025
P11	170	185	225	265	285	165	175	215	255	275	135	145	175	210	225	190	205	250	295	325
	560	610	740	870	940	540	570	710	840	900	445	475	570	690	740	620	670	820	970	1075
P12	120	125	155	170	185	115	120	150	165	180	90	100	120	135	145	130	140	170	190	205
	395	410	510	560	610	375	395	490	540	590	295	330	395	445	475	425	460	560	620	670
M1	—	—	—	—	—	175	190	230	270	295	150	160	200	235	255	205	220	265	315	340
	—	—	—	—	—	570	620	750	890	970	490	520	660	770	840	670	720	870	1025	1125
M2	—	—	—	—	—	145	155	190	225	240	125	135	160	195	210	165	180	220	260	280
	—	—	—	—	—	475	510	620	740	790	410	445	520	640	690	540	590	720	850	920
M3	—	—	—	—	—	125	130	160	180	195	105	115	140	155	170	145	155	185	210	225
	—	—	—	—	—	410	425	520	590	640	345	375	460	510	560	475	510	610	690	740
M4	—	—	—	—	—	100	105	125	140	150	85	90	110	120	130	115	120	145	160	175
	—	—	—	—	—	330	345	410	460	490	280	295	360	395	425	375	395	475	520	570
M5	—	—	—	—	—	85	85	105	115	125	70	75	90	100	110	95	100	120	130	145
	—	—	—	—	—	280	280	345	375	410	230	245	295	330	360	310	330	395	425	475
K1	175	190	235	275	300	170	185	225	265	290	—	—	—	—	—	—	—	—	—	—
	570	620	770	900	980	560	610	740	870	950	—	—	—	—	—	—	—	—	—	—
K2	155	170	205	245	265	150	165	200	235	255	—	—	—	—	—	—	—	—	—	—
	510	560	670	800	870	490	540	660	770	840	—	—	—	—	—	—	—	—	—	—
K3	130	145	175	210	225	130	140	170	200	215	—	—	—	—	—	—	—	—	—	—
	425	475	570	690	740	425	460	560	660	710	—	—	—	—	—	—	—	—	—	—
K4	125	135	165	200	215	120	130	160	190	205	—	—	—	—	—	—	—	—	—	—
	410	445	540	660	710	395	425	520	620	670	—	—	—	—	—	—	—	—	—	—
K5	80	85	100	120	130	75	80	100	115	125	—	—	—	—	—	—	—	—	—	—
	260	280	330	395	425	245	260	330	375	410	—	—	—	—	—	—	—	—	—	—
K6	110	120	145	175	190	105	115	140	170	180	—	—	—	—	—	—	—	—	—	—
	360	395	475	570	620	345	375	460	560	590	—	—	—	—	—	—	—	—	—	—
K7	100	110	130	155	170	95	105	125	150	160	—	—	—	—	—	—	—	—	—	—
	330	360	425	510	560	310	345	410	490	520	—	—	—	—	—	—	—	—	—	—
N1	—	—	—	—	—	1275	1375	1675	1975	2150	—	—	—	—	—	—	—	—	—	—
	—	—	—	—	—	4175	4500	5500	6475	7050	—	—	—	—	—	—	—	—	—	—
N2	—	—	—	—	—	510	550	680	790	870	—	—	—	—	—	—	—	—	—	—
	—	—	—	—	—	1675	1800	2225	2600	2850	—	—	—	—	—	—	—	—	—	—
N3	—	—	—	—	—	340	365	450	530	580	—	—	—	—	—	—	—	—	—	—
	—	—	—	—	—	1125	1200	1475	1750	1900	—	—	—	—	—	—	—	—	—	—
N11	—	—	—	—	—	390	420	520	610	660	—	—	—	—	—	—	—	—	—	—
	—	—	—	—	—	1275	1375	1700	2000	2175	—	—	—	—	—	—	—	—	—	—
S1	48	50	60	65	75	46	48	60	65	70	26	27	34	36	40	55	55	70	75	80
	155	165	195	215	245	150	155	195	215	230	85	90	110	120	130	180	180	230	245	260
S2	39	40	50	55	60	37	39	48	50	55	21	22	27	29	32	43	45	55	60	65
	130	130	165	180	195	120	130	155	165	180	70	70	90	95	105	140	150	180	195	215
S3	34	36	44	47	50	33	34	42	45	50	19	19	24	26	28	38	40	48	50	55
	110	120	145	155	165	110	110	140	150	165	60	60	80	85	90	125	130	155	165	180
S11	65	70	85	95	100	65	65	80	90	100	36	38	47	50	55	75	80	95	105	115
	215	230	280	310	330	215	215	260	295	330	120	125	155	165	180	245	260	310	345	375
S12	45	48	60	65	70	44	46	55	65	70	33	35	43	47	50	50	55	65	75	80
	150	155	195	215	230	145	150	180	215	230	110	115	140	155	165	165	180	215	245	260
S13	27	28	35	38	41	26	27	33	36	40	20	21	25	27	30	30	32	38	42	46
	90	90	115	125	135	85	90	110	120	130	65	70	80	90	100	100	105	125	140	150
H5	39	42	50	55	60	38	40	49	55	60	—	—	—	—	—	—	—	—	—	—
	130	140	165	180	195	125	130	160	180	195	—	—	—	—	—	—	—	—	—	—
H8	42	45	55	60	65	41	43	50	55	65	—	—	—	—	—	—	—	—	—	—
	140	150	180	195	215	135	140	165	180	215	—	—	—	—	—	—	—	—	—	—
H11	50	55	65	70	80	48	50	65	70	75	—	—	—	—	—	—	—	—	—	—
	165	180	215	230	260	155	165	215	230	245	—	—	—	—	—	—	—	—	—	—
H12	75	80	95	105	115	75	80	95	105	115	—	—	—	—	—	—	—	—	—	—
	245	260	310	345	375	245	260	310	345	375	—	—	—	—	—	—	—	—	—	—
H21	42	45	55	60	65	41	43	50	55	65	—	—	—	—	—	—	—	—	—	—

R218.20-200 – Insert selection – mm/Inch

SMG			a_p		f_z		
					100%	70%	30%
P1	218.20-200ER-ME10 F40M	SCET120612T-M14 T350M	36,0	0,20	0,20	0,22	
			1.4	0.0080	0.0080	0.0085	
P2	218.20-200ER-ME10 F40M	SCET120612T-M14 T350M	36,0	0,20	0,20	0,22	
			1.4	0.0080	0.0080	0.0085	
P3	218.20-200ER-ME10 F40M	SCET120612T-M14 T350M	36,0	0,19	0,19	0,20	
			1.4	0.0075	0.0075	0.0080	
P4	218.20-200ER-M10 F40M	SCET120612T-M11 MP250I	36,0	0,19	0,19	0,20	
			1.4	0.0075	0.0075	0.0080	
P5	218.20-200ER-M10 F40M	SCET120612T-M11 MP250I	36,0	0,18	0,18	0,20	
			1.4	0.0070	0.0070	0.0080	
P6	218.20-200ER-M10 F40M	SCET120612T-M11 MP250I	36,0	0,18	0,18	0,20	
			1.4	0.0070	0.0070	0.0080	
P7	218.20-200ER-M10 F40M	SCET120612T-M11 MP250I	36,0	0,18	0,18	0,20	
			1.4	0.0070	0.0070	0.0080	
P8	218.20-200ER-M10 F40M	SCET120612T-M11 MP250I	36,0	0,19	0,19	0,20	
			1.4	0.0075	0.0075	0.0080	
P11	218.20-200ER-M10 F40M	SCET120612T-M11 MP250I	36,0	0,18	0,18	0,20	
			1.4	0.0070	0.0070	0.0080	
P12	218.20-200ER-M10 F40M	SCET120612T-M11 MP250I	29,0	0,13	0,13	0,14	
			1.1	0.0050	0.0050	0.0055	
M1	218.20-200ER-ME10 F40M	SCET120612T-M14 T350M	36,0	0,20	0,20	0,22	
			1.4	0.0080	0.0080	0.0085	
M2	218.20-200ER-ME10 F40M	SCET120612T-M14 T350M	36,0	0,18	0,18	0,20	
			1.4	0.0070	0.0070	0.0080	
M3	218.20-200ER-ME10 F40M	SCET120612T-M14 T350M	29,0	0,15	0,15	0,16	
			1.1	0.0060	0.0060	0.0065	
M4	218.20-200ER-ME10 F40M	SCET120612T-M14 T350M	22,0	0,13	0,13	0,14	
			0.85	0.0050	0.0050	0.0055	
M5	218.20-200ER-M10 F40M	SCET120612T-M14 T350M	22,0	0,13	0,13	0,14	
			0.85	0.0050	0.0050	0.0055	
N1	218.20-200ER-ME10 F40M	SCET120612T-M11 F40M	36,0	0,26	0,26	0,28	
			1.4	0.010	0.010	0.011	
N2	218.20-200ER-ME10 F40M	SCET120612T-M11 F40M	36,0	0,26	0,26	0,28	
			1.4	0.010	0.010	0.011	
N3	218.20-200ER-ME10 F40M	SCET120612T-M11 F40M	36,0	0,26	0,26	0,28	
			1.4	0.010	0.010	0.011	
N11	218.20-200ER-ME10 F40M	SCET120612T-M11 F40M	36,0	0,26	0,26	0,28	
			1.4	0.010	0.010	0.011	
S1	218.20-200ER-ME10 F40M	SCET120612T-M14 T350M	22,0	0,13	0,13	0,14	
			0.85	0.0050	0.0050	0.0055	
S2	218.20-200ER-ME10 F40M	SCET120612T-M14 T350M	22,0	0,13	0,13	0,14	
			0.85	0.0050	0.0050	0.0055	
S3	218.20-200ER-ME10 F40M	SCET120612T-M14 T350M	22,0	0,12	0,12	0,13	
			0.85	0.0048	0.0048	0.0050	
S11	218.20-200ER-ME10 MS2050	SCET120612T-M14 MS2050	25,0	0,11	0,11	0,12	
			1.0	0.0044	0.0044	0.0048	
S12	218.20-200ER-ME10 MS2050	SCET120612T-M14 MS2050	25,0	0,11	0,11	0,12	
			1.0	0.0044	0.0044	0.0048	
S13	218.20-200ER-ME10 MS2050	SCET120612T-M14 MS2050	22,0	0,095	0,095	0,10	
			0.85	0.0038	0.0038	0.0040	

SMG = Seco material group
 f_z = mm/tooth (in/tooth), v_c = m/min (sf/min), a_p /DC = %
 All cutting data are start values

Square shoulder and slot milling cutters
 Helical milling cutters
 Face milling cutters
 Disc milling cutters
 High feed milling cutters
 Copy milling cutters
 Plunge milling cutters
 Chamfer milling cutters
 Spot facing cutters
 Inserts

R218.20-200 – Insert selection – mm/Inch

SMG			a _p	f _z		
				15%	10%	5%
P1	218.20-200ER-ME10 F40M	SCET120612T-M14 T350M	36,0	0,28	0,34	0,46
			1,4	0,011	0,013	0,018
P2	218.20-200ER-ME10 F40M	SCET120612T-M14 T350M	36,0	0,28	0,34	0,48
			1,4	0,011	0,013	0,019
P3	218.20-200ER-ME10 F40M	SCET120612T-M14 T350M	36,0	0,26	0,32	0,44
			1,4	0,010	0,013	0,017
P4	218.20-200ER-M10 F40M	SCET120612T-M11 MP2501	36,0	0,26	0,32	0,44
			1,4	0,010	0,013	0,017
P5	218.20-200ER-M10 F40M	SCET120612T-M11 MP2501	36,0	0,26	0,30	0,42
			1,4	0,010	0,012	0,017
P6	218.20-200ER-M10 F40M	SCET120612T-M11 MP2501	36,0	0,25	0,30	0,42
			1,4	0,010	0,012	0,017
P7	218.20-200ER-M10 F40M	SCET120612T-M11 MP2501	36,0	0,25	0,30	0,42
			1,4	0,010	0,012	0,017
P8	218.20-200ER-M10 F40M	SCET120612T-M11 MP2501	36,0	0,26	0,32	0,44
			1,4	0,010	0,013	0,017
P11	218.20-200ER-M10 F40M	SCET120612T-M11 MP2501	36,0	0,25	0,30	0,42
			1,4	0,010	0,012	0,017
P12	218.20-200ER-M10 F40M	SCET120612T-M11 MP2501	29,0	0,17	0,20	0,28
			1,1	0,0065	0,0080	0,011
M1	218.20-200ER-ME10 F40M	SCET120612T-M14 T350M	36,0	0,28	0,34	0,48
			1,4	0,011	0,013	0,019
M2	218.20-200ER-ME10 F40M	SCET120612T-M14 T350M	36,0	0,26	0,30	0,42
			1,4	0,010	0,012	0,017
M3	218.20-200ER-ME10 F40M	SCET120612T-M14 T350M	29,0	0,20	0,24	0,34
			1,1	0,0080	0,0095	0,013
M4	218.20-200ER-ME10 F40M	SCET120612T-M14 T350M	22,0	0,18	0,22	0,30
			0,85	0,0070	0,0085	0,012
M5	218.20-200ER-ME10 F40M	SCET120612T-M14 T350M	22,0	0,18	0,22	0,30
			0,85	0,0070	0,0085	0,012
N1	218.20-200ER-ME10 F40M	SCET120612T-M14 F40M	36,0	0,36	0,44	0,60
			1,4	0,014	0,017	0,024
N2	218.20-200ER-ME10 F40M	SCET120612T-M14 F40M	36,0	0,36	0,44	0,60
			1,4	0,014	0,017	0,024
N3	218.20-200ER-ME10 F40M	SCET120612T-M14 F40M	36,0	0,36	0,44	0,60
			1,4	0,014	0,017	0,024
N11	218.20-200ER-ME10 F40M	SCET120612T-M14 F40M	36,0	0,36	0,44	0,60
			1,4	0,014	0,017	0,024
S1	218.20-200ER-ME10 F40M	SCET120612T-M14 T350M	22,0	0,18	0,22	0,30
			0,85	0,0070	0,0085	0,012
S2	218.20-200ER-ME10 F40M	SCET120612T-M14 T350M	22,0	0,18	0,22	0,30
			0,85	0,0070	0,0085	0,012
S3	218.20-200ER-ME10 F40M	SCET120612T-M14 T350M	22,0	0,17	0,20	0,28
			0,85	0,0065	0,0080	0,011
S11	218.20-200ER-ME10 MS2050	SCET120612T-M14 MS2050	25,0	0,15	0,17	0,24
			1,0	0,0060	0,0065	0,0095
S12	218.20-200ER-ME10 MS2050	SCET120612T-M14 MS2050	25,0	0,15	0,17	0,24
			1,0	0,0060	0,0065	0,0095
S13	218.20-200ER-ME10 MS2050	SCET120612T-M14 MS2050	22,0	0,13	0,15	0,22
			0,85	0,0050	0,0060	0,0085

SMG = Seco material group
 f_z = mm/tooth (in/tooth), v_c = m/min (sf/min), a_p/DC = %
 All cutting data are start values

R218.20-200 – Cutting data $v_c = (m/min)/(sf/min)$

SMG	F40M					MM4500					MS2050				
	100%	70%	30%	10%	5%	100%	70%	30%	10%	5%	100%	70%	30%	10%	5%
P1	205	220	270	320	345	165	180	220	260	280	245	265	320	385	415
	670	720	890	1050	1125	540	590	720	850	920	800	870	1050	1275	1350
P2	195	210	260	310	335	160	170	210	250	270	240	255	315	370	405
	640	690	850	1025	1100	520	560	690	820	890	790	840	1025	1225	1325
P3	170	185	225	270	290	140	150	180	220	235	210	225	275	320	355
	560	610	740	890	950	460	490	590	720	770	690	740	900	1050	1175
P4	150	165	200	240	260	125	130	160	195	210	185	200	240	290	310
	490	540	660	790	850	410	425	520	640	690	610	660	790	950	1025
P5	145	160	195	230	250	120	130	160	185	200	175	190	230	275	295
	475	520	640	750	820	395	425	520	610	660	570	620	750	900	970
P6	165	175	220	255	280	135	145	175	205	225	195	215	260	310	340
	540	570	720	840	920	445	475	570	670	740	640	710	850	1025	1125
P7	155	165	205	240	265	125	135	165	195	215	185	200	245	290	320
	510	540	670	790	870	410	445	540	640	710	610	660	800	950	1050
P8	145	155	190	230	245	115	125	155	185	200	175	190	230	270	295
	475	510	620	750	800	375	410	510	610	660	570	620	750	890	970
P11	150	165	200	235	255	120	130	160	190	210	180	195	235	285	310
	490	540	660	770	840	395	425	520	620	690	590	640	770	940	1025
P12	105	110	135	150	165	85	90	110	125	135	125	135	160	180	195
	345	360	445	490	540	280	295	360	410	445	410	445	520	590	640
M1	155	170	210	250	270	135	145	180	215	235	190	205	255	300	325
	510	560	690	820	890	445	475	590	710	770	620	670	840	980	1075
M2	130	140	175	205	225	115	125	150	175	195	160	170	210	250	265
	425	460	570	670	740	375	410	490	570	640	520	560	690	820	870
M3	115	120	145	165	180	95	105	125	145	155	135	145	175	200	215
	375	395	475	540	590	310	345	410	475	510	445	475	570	660	710
M4	90	95	120	130	140	80	80	100	110	120	110	115	140	150	165
	295	310	395	425	460	260	260	330	360	395	360	375	460	490	540
M5	75	80	100	105	120	65	70	85	95	100	90	95	115	125	140
	245	260	330	345	395	215	230	280	310	330	295	310	375	410	460
N1	1150	1250	1525	1800	1975	—	—	—	—	—	—	—	—	—	—
	3775	4100	5000	5900	6475	—	—	—	—	—	—	—	—	—	—
N2	470	500	620	730	800	—	—	—	—	—	—	—	—	—	—
	1550	1650	2025	2400	2625	—	—	—	—	—	—	—	—	—	—
N3	310	335	410	485	530	—	—	—	—	—	—	—	—	—	—
	1025	1100	1350	1600	1750	—	—	—	—	—	—	—	—	—	—
N11	355	380	470	550	610	—	—	—	—	—	—	—	—	—	—
	1175	1250	1550	1800	2000	—	—	—	—	—	—	—	—	—	—
S1	43	45	55	60	65	24	25	31	34	37	50	55	65	70	80
	140	150	180	195	215	80	80	100	110	120	165	180	215	230	260
S2	35	36	44	48	55	20	20	25	27	30	41	43	50	55	65
	115	120	145	155	180	65	65	80	90	100	135	140	165	180	215
S3	30	32	39	43	46	17	18	22	24	26	36	38	46	50	55
	100	105	130	140	150	55	60	70	80	85	120	125	150	165	180
S11	60	60	75	85	90	33	35	43	48	50	70	75	90	100	110
	195	195	245	280	295	110	115	140	155	165	230	245	295	330	360
S12	41	43	50	60	65	31	32	40	44	47	48	50	65	70	75
	135	140	165	195	215	100	105	130	145	155	155	165	215	230	245
S13	24	25	31	34	37	18	19	23	26	28	29	30	37	40	44
	80	80	100	110	120	60	60	75	85	90	95	100	120	130	145

Square shoulder and slot milling cutters
Helical milling cutters
Face milling cutters
Disc milling cutters
High feed milling cutters
Copy milling cutters
Plunge milling cutters
Chamfer milling cutters
Spot facing cutters
Inserts

R218.20-250 – Insert selection – mm/Inch

SMG			a _p	f _z		
				100%	70%	30%
P1	218.20-250ER-ME12 F40M	SCET120612T-M14 T350M	42,0	0,17	0,17	0,18
			1,7	0,0065	0,0065	0,0070
P2	218.20-250ER-ME12 F40M	SCET120612T-M14 T350M	42,0	0,17	0,17	0,19
			1,7	0,0065	0,0065	0,0075
P3	218.20-250ER-ME12 F40M	SCET120612T-M14 T350M	42,0	0,16	0,16	0,18
			1,7	0,0065	0,0065	0,0070
P4	218.20-250TR-M14 F40M	SCET120612T-M11 MP2501	42,0	0,19	0,19	0,20
			1,7	0,0075	0,0075	0,0080
P5	218.20-250TR-M14 F40M	SCET120612T-M11 MP2501	42,0	0,18	0,18	0,20
			1,7	0,0070	0,0070	0,0080
P6	218.20-250TR-M14 F40M	SCET120612T-M11 MP2501	42,0	0,18	0,18	0,20
			1,7	0,0070	0,0070	0,0080
P7	218.20-250TR-M14 F40M	SCET120612T-M11 MP2501	42,0	0,18	0,18	0,20
			1,7	0,0070	0,0070	0,0080
P8	218.20-250TR-M14 F40M	SCET120612T-M11 MP2501	42,0	0,19	0,19	0,20
			1,7	0,0075	0,0075	0,0080
P11	218.20-250TR-M14 F40M	SCET120612T-M11 MP2501	42,0	0,18	0,18	0,20
			1,7	0,0070	0,0070	0,0080
P12	218.20-250TR-M14 F40M	SCET120612T-M11 MP2501	34,0	0,13	0,13	0,14
			1,3	0,0050	0,0050	0,0055
M1	218.20-250ER-ME12 F40M	SCET120612T-M14 T350M	42,0	0,17	0,17	0,19
			1,7	0,0065	0,0065	0,0075
M2	218.20-250ER-ME12 F40M	SCET120612T-M14 T350M	42,0	0,16	0,16	0,17
			1,7	0,0065	0,0065	0,0065
M3	218.20-250ER-ME12 F40M	SCET120612T-M14 T350M	34,0	0,13	0,13	0,14
			1,3	0,0050	0,0050	0,0055
M4	218.20-250ER-ME12 F40M	SCET120612T-M14 T350M	25,0	0,12	0,12	0,12
			1,0	0,0048	0,0048	0,0048
M5	218.20-250TR-M14 F40M	SCET120612T-M14 T350M	25,0	0,14	0,14	0,15
			1,0	0,0055	0,0055	0,0060
N1	218.20-250ER-ME12 F40M	SCET120612T-M11 F40M	42,0	0,22	0,22	0,24
			1,7	0,0085	0,0085	0,0095
N2	218.20-250ER-ME12 F40M	SCET120612T-M11 F40M	42,0	0,22	0,22	0,24
			1,7	0,0085	0,0085	0,0095
N3	218.20-250ER-ME12 F40M	SCET120612T-M11 F40M	42,0	0,22	0,22	0,24
			1,7	0,0085	0,0085	0,0095
N11	218.20-250ER-ME12 F40M	SCET120612T-M11 F40M	42,0	0,22	0,22	0,24
			1,7	0,0085	0,0085	0,0095
S1	218.20-250ER-ME12 F40M	SCET120612T-M14 T350M	25,0	0,12	0,12	0,12
			1,0	0,0048	0,0048	0,0048
S2	218.20-250ER-ME12 F40M	SCET120612T-M14 T350M	25,0	0,12	0,12	0,12
			1,0	0,0048	0,0048	0,0048
S3	218.20-250ER-ME12 F40M	SCET120612T-M14 T350M	25,0	0,11	0,11	0,12
			1,0	0,0044	0,0044	0,0048
S11	218.20-250ER-ME12 MS2050	SCET120612T-M14 MS2050	29,0	0,13	0,13	0,14
			1,1	0,0050	0,0050	0,0055
S12	218.20-250ER-ME12 MS2050	SCET120612T-M14 MS2050	29,0	0,13	0,13	0,14
			1,1	0,0050	0,0050	0,0055
S13	218.20-250ER-ME12 MS2050	SCET120612T-M14 MS2050	25,0	0,12	0,12	0,12
			1,0	0,0048	0,0048	0,0048

SMG = Seco material group
 f_z = mm/tooth (in/tooth), v_c = m/min (sf/min), a_p/DC = %
 All cutting data are start values

R218.20-250 – Insert selection – mm/Inch

SMG			a_p	f_z		
				15%	10%	5%
P1	218.20-250ER-ME12 F40M	SCET120612T-M14 T350M	42,0	0,24	0,28	0,40
			1,7	0,0095	0,011	0,016
P2	218.20-250ER-ME12 F40M	SCET120612T-M14 T350M	42,0	0,24	0,28	0,40
			1,7	0,0095	0,011	0,016
P3	218.20-250ER-ME12 F40M	SCET120612T-M14 T350M	42,0	0,22	0,28	0,38
			1,7	0,0085	0,011	0,015
P4	218.20-250TR-M14 F40M	SCET120612T-M11 MP2501	42,0	0,26	0,32	0,44
			1,7	0,010	0,013	0,017
P5	218.20-250TR-M14 F40M	SCET120612T-M11 MP2501	42,0	0,26	0,30	0,42
			1,7	0,010	0,012	0,017
P6	218.20-250TR-M14 F40M	SCET120612T-M11 MP2501	42,0	0,25	0,30	0,42
			1,7	0,010	0,012	0,017
P7	218.20-250TR-M14 F40M	SCET120612T-M11 MP2501	42,0	0,25	0,30	0,42
			1,7	0,010	0,012	0,017
P8	218.20-250TR-M14 F40M	SCET120612T-M11 MP2501	42,0	0,26	0,32	0,44
			1,7	0,010	0,013	0,017
P11	218.20-250TR-M14 F40M	SCET120612T-M11 MP2501	42,0	0,25	0,30	0,42
			1,7	0,010	0,012	0,017
P12	218.20-250TR-M14 F40M	SCET120612T-M11 MP2501	34,0	0,17	0,20	0,28
			1,3	0,0065	0,0080	0,011
M1	218.20-250ER-ME12 F40M	SCET120612T-M14 T350M	42,0	0,24	0,28	0,40
			1,7	0,0095	0,011	0,016
M2	218.20-250ER-ME12 F40M	SCET120612T-M14 T350M	42,0	0,22	0,26	0,36
			1,7	0,0085	0,010	0,014
M3	218.20-250ER-ME12 F40M	SCET120612T-M14 T350M	34,0	0,18	0,22	0,30
			1,3	0,0070	0,0085	0,012
M4	218.20-250ER-ME12 F40M	SCET120612T-M14 T350M	25,0	0,15	0,18	0,25
			1,0	0,0060	0,0070	0,010
M5	218.20-250ER-ME12 F40M	SCET120612T-M14 T350M	25,0	0,15	0,18	0,25
			1,0	0,0060	0,0070	0,010
N1	218.20-250ER-ME12 F40M	SCET120612T-M14 F40M	42,0	0,30	0,36	0,50
			1,7	0,012	0,014	0,020
N2	218.20-250ER-ME12 F40M	SCET120612T-M14 F40M	42,0	0,30	0,36	0,50
			1,7	0,012	0,014	0,020
N3	218.20-250ER-ME12 F40M	SCET120612T-M14 F40M	42,0	0,30	0,36	0,50
			1,7	0,012	0,014	0,020
N11	218.20-250ER-ME12 F40M	SCET120612T-M14 F40M	42,0	0,30	0,36	0,50
			1,7	0,012	0,014	0,020
S1	218.20-250ER-ME12 F40M	SCET120612T-M14 T350M	25,0	0,15	0,18	0,25
			1,0	0,0060	0,0070	0,010
S2	218.20-250ER-ME12 F40M	SCET120612T-M14 T350M	25,0	0,15	0,18	0,25
			1,0	0,0060	0,0070	0,010
S3	218.20-250ER-ME12 F40M	SCET120612T-M14 T350M	25,0	0,14	0,17	0,24
			1,0	0,0055	0,0065	0,0095
S11	218.20-250ER-ME12 MS2050	SCET120612T-M14 MS2050	29,0	0,18	0,22	0,30
			1,1	0,0070	0,0085	0,012
S12	218.20-250ER-ME12 MS2050	SCET120612T-M14 MS2050	29,0	0,18	0,22	0,30
			1,1	0,0070	0,0085	0,012
S13	218.20-250ER-ME12 MS2050	SCET120612T-M14 MS2050	25,0	0,15	0,18	0,25
			1,0	0,0060	0,0070	0,010

SMG = Seco material group
 f_z = mm/tooth (in/tooth), v_c = m/min (sf/min), a_p/DC = %
 All cutting data are start values

Square shoulder and slot milling cutters
 Helical milling cutters
 Face milling cutters
 Disc milling cutters
 High feed milling cutters
 Copy milling cutters
 Plunge milling cutters
 Chamfer milling cutters
 Spot facing cutters
 Inserts

R218.20-250 – Cutting data $v_c = (m/min)/(sf/min)$

SMG	F40M					MM4500					MS2050				
	100%	70%	30%	10%	5%	100%	70%	30%	10%	5%	100%	70%	30%	10%	5%
P1	190	210	255	305	325	155	170	210	245	265	210	230	280	335	360
	620	690	840	1000	1075	510	560	690	800	870	690	750	920	1100	1175
P2	185	205	245	295	315	150	165	200	240	255	205	225	270	325	350
	610	670	800	970	1025	490	540	660	790	840	670	740	890	1075	1150
P3	165	180	215	255	275	130	145	175	205	225	180	195	235	280	305
	540	590	710	840	900	425	475	570	670	740	590	640	770	920	1000
P4	145	155	190	230	245	115	125	155	185	195	160	170	210	250	270
	475	510	620	750	800	375	410	510	610	640	520	560	690	820	890
P5	135	150	185	215	235	110	120	150	175	190	150	165	200	240	260
	445	490	610	710	770	360	395	490	570	620	490	540	660	790	850
P6	155	170	205	245	265	125	135	165	200	215	170	185	225	270	290
	510	560	670	800	870	410	445	540	660	710	560	610	740	890	950
P7	145	160	195	230	250	120	130	160	185	200	160	175	215	255	275
	475	520	640	750	820	395	425	520	610	660	520	570	710	840	900
P8	135	150	180	215	230	110	120	145	175	190	150	165	200	235	255
	445	490	590	710	750	360	395	475	570	620	490	540	660	770	840
P11	140	155	190	225	245	115	125	155	180	195	155	170	210	245	265
	460	510	620	740	800	375	410	510	590	640	510	560	690	800	870
P12	95	105	125	145	155	75	85	100	115	125	105	115	135	160	170
	310	345	410	475	510	245	280	330	375	410	345	375	445	520	560
M1	150	165	200	235	255	130	140	170	205	220	165	180	220	260	280
	490	540	660	770	840	425	460	560	670	720	540	590	720	850	920
M2	125	135	165	195	210	105	115	140	170	185	135	150	180	215	235
	410	445	540	640	690	345	375	460	560	610	445	490	590	710	770
M3	100	110	135	155	170	90	95	115	135	145	110	120	150	170	185
	330	360	445	510	560	295	310	375	445	475	360	395	490	560	610
M4	85	90	110	125	135	75	80	95	105	115	95	100	125	135	145
	280	295	360	410	445	245	260	310	345	375	310	330	410	445	475
M5	70	75	95	100	110	60	65	80	90	95	75	85	105	110	120
	230	245	310	330	360	195	215	260	295	310	245	280	345	360	395
N1	1075	1175	1450	1725	1875	—	—	—	—	—	—	—	—	—	—
	3525	3850	4750	5650	6150	—	—	—	—	—	—	—	—	—	—
N2	435	475	580	690	750	—	—	—	—	—	—	—	—	—	—
	1425	1550	1900	2275	2450	—	—	—	—	—	—	—	—	—	—
N3	290	315	390	465	500	—	—	—	—	—	—	—	—	—	—
	950	1025	1275	1525	1650	—	—	—	—	—	—	—	—	—	—
N11	335	360	445	530	570	—	—	—	—	—	—	—	—	—	—
	1100	1175	1450	1750	1875	—	—	—	—	—	—	—	—	—	—
S1	39	42	50	55	60	22	24	30	32	35	43	47	55	65	70
	130	140	165	180	195	70	80	100	105	115	140	155	180	215	230
S2	32	34	42	46	50	18	19	24	26	28	35	38	46	50	55
	105	110	140	150	165	60	60	80	85	90	115	125	150	165	180
S3	28	30	36	40	43	16	17	21	23	25	31	33	40	44	48
	90	100	120	130	140	50	55	70	75	80	100	110	130	145	155
S11	55	60	70	80	85	30	33	40	44	48	60	65	75	85	95
	180	195	230	260	280	100	110	130	145	155	195	215	245	280	310
S12	37	40	49	55	60	28	30	37	41	45	40	44	55	60	65
	120	130	160	180	195	90	100	120	135	150	130	145	180	195	215
S13	22	24	29	32	35	17	18	22	24	26	24	26	32	35	38
	70	80	95	105	115	55	60	70	80	85	80	85	105	115	125

R218.19 – Metric

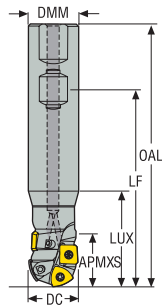

- For insert selection and cutting data recommendations, see page(s) 716-731
- For complete insert programme, see page(s) 860, 878
- For ISO attribute explanation, see page 16

Designation	Item number	Type of mounting	DC	ZEFP	APMXS	DMM	LS	OAL	LUX	RPMX	Weight	218.19	SPMT
			mm		mm	mm	mm	mm	mm		kg		
R218.19-2016.3-17.050A	75069117	Weldon	16,0	1	17,5	20,0	60,0	100,0	31,0	41600	0,2	-080(2)	-0602(2)
R218.19-2520.3-21.069A	75069118	Weldon	20,0	1	21,6	25,0	82,5	125,0	31,0	26200	0,4	-100(2)	-0703(2)
R218.19-2525.3-26.074HA	75069119	Weldon	25,0	1	26,6	25,0	82,5	130,0	46,0	21700	0,4	-125(2)	-0903(2)
R218.19-3232.3-30.070HA	75069120	Weldon	32,0	1	31,2	32,0	82,5	130,0	46,0	14800	0,7	-160(2)	-

Spare Parts, included in delivery

For cutter	Insert key	Insert screw
R218.19-2016	H4B-T07P	C02205-T07P
R218.19-2520	H4B-T07P	C02506-T07P
R218.19-2525	H4B-T09P	C03006-T09P
R218.19-3232	H4B-T15P	C03508-T15P

Accessories

For cutter	Insert clamping torque	Torque key
R218.19-2016	0.9NM	T00-07P09
R218.19-2520	0.9NM	T00-07P09
R218.19-2525	2.0NM	T00-09P20
R218.19-3232	3.0NM	T00-15P30

Torque and fixed keys, see page 894

Square shoulder and slot milling cutters
Helical milling cutters
Face milling cutters
Disc milling cutters
High feed milling cutters
Copy milling cutters
Plunge milling cutters
Chamfer milling cutters
Spot facing cutters
Inserts

R218.19 – inch

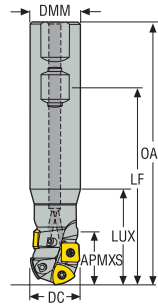

- For insert selection and cutting data recommendations, see page(s) 716-731
- For complete insert programme, see page(s) 860, 878
- For ISO attribute explanation, see page 16

Designation	Item number	Type of mounting	DC	ZEFP	APMXS	DMM	LS	OAL	LUX	RPMX	Weight	218.19	SPMX
			inch		inch	inch	inch	inch	inch		lbs		
R218.19-00.75-3-21M	00087573	Weldon	0.750	1	0.835	0.750	2.583	4.031	1.425	26200	0.660	100 (2)	0703 (2)
R218.19-01.00-3-26H	00087575	Weldon	1.000	1	1.063	1.000	2.835	5.031	2.173	21700	1.100	125 (2)	0903 (2)

Spare Parts, included in delivery

For cutter	Insert key	Insert screw
R218.19-00.75	H4B-T07P	C02506-T07P
R218.19-01.00	H4B-T09P	C03006-T09P

Accessories

For cutter	Insert clamping torque	Torque key
R218.19-00.750	8.0IN.LBS	T00-07P09
R218.19-01.00	17.7IN.LBS	T00-09P20

Torque and fixed keys, see page 894

R218.19 – Metric

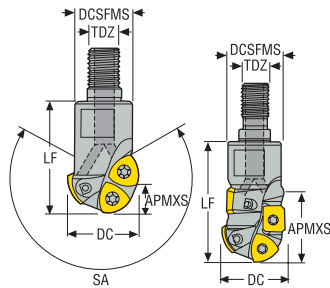

- For insert selection and cutting data recommendations, see page(s) 716-731
- For complete insert programme, see page(s) 860, 878
- For ISO attribute explanation, see page 16

Designation	Item number	Type of mounting	DC	ZEFP	APMXS	DCSFMS	TDZ	LF	RPMX	Weight	218.19	SPMX	SPMT
			mm		mm	mm		mm		kg			
R218.19-0816.RE-12A	02644033	Combimaster	16,0	1	12,0	13,5	M8	23,0	41600	0,1	-080(2)	-0602	-
R218.19-1020.RE-16A	02644034	Combimaster	20,0	1	16,0	18,0	M10	28,0	26200	0,1	-100(2)	-0703	-
R218.19-1220.RE-21A	75077649	Combimaster	20,0	1	21,6	21,0	M12	45,0	26200	0,1	-100(2)	-0703(2)	-
R218.19-1225.RE-26HA	75094632	Combimaster	25,0	1	26,6	21,0	M12	45,0	21700	0,1	-125(2)	-0903(2)	-
R218.19-1632.RE-36HA	75077650	Combimaster	32,0	1	38,6	28,0	M16	55,0	14800	0,2	-160(2)	-	-1004(3)
R218.19-1225.RE-14HFA	75094633	Combimaster	25,0	1	12,5	21,0	M12	40,0	21700	0,2	-125(3)	-	-
R218.19-1632.RE-18HFA	75094580	Combimaster	32,0	1	16,0	28,0	M16	40,0	14800	0,2	-160(3)	-	-
R218.19-1640.RE-25HFA	00089918	Combimaster	40,0	1	20,0	28,0	M16	50,0	10400	0,2	-200(3)	-	-

For Combimaster Shanks, see Machining Navigator Tooling System

Spare Parts, included in delivery

For cutter	Insert key	Insert screw
R218.19-0816	H4B-T07P	C02205-T07P
R218.19-1020	H4B-T07P	C02506-T07P
R218.19-1220	H4B-T07P	C02506-T07P
R218.19-1225	H4B-T09P	C03006-T09P
R218.19-1632	H4B-T15P	C03508-T15P
R218.19-1640	H6B-T20P	C45011-T20P

Accessories

For cutter	Insert clamping torque	Torque key
R218.19-0816-1220	0.9NM	T00-07P09
R218.19-1225	2.0NM	T00-09P20
R218.19-1632	3.0NM	T00-15P30
R218.19-1640	5.0NM	T00-20P50

Torque and fixed keys, see page 894

R218.19-080 – Insert selection – mm/Inch

SMG			a_p	f_z		
				100%	70%	30%
P1	218.19-080T-M04 F40M	SPMX060204-75 F40M	11,0	0,15	0,15	0,16
			0,44	0,0060	0,0060	0,0065
P2	218.19-080T-M04 F40M	SPMX060204-75 F40M	11,0	0,15	0,15	0,17
			0,44	0,0060	0,0060	0,0065
P3	218.19-080T-M04 F40M	SPMX060204-75 F40M	11,0	0,14	0,14	0,16
			0,44	0,0055	0,0055	0,0065
P4	218.19-080T-M04 MP2501	SPMX060204-75 F40M	11,0	0,14	0,14	0,15
			0,44	0,0055	0,0055	0,0060
P5	218.19-080T-M04 MP2501	SPMX060204-75 F40M	11,0	0,14	0,14	0,15
			0,44	0,0055	0,0055	0,0060
P6	218.19-080T-M04 MP2501	SPMX060204-75 F40M	11,0	0,14	0,14	0,15
			0,44	0,0055	0,0055	0,0060
P7	218.19-080T-M04 MP2501	SPMX060204-75 F40M	11,0	0,14	0,14	0,15
			0,44	0,0055	0,0055	0,0060
P8	218.19-080T-M04 MP2501	SPMX060204-75 F40M	11,0	0,14	0,14	0,16
			0,44	0,0055	0,0055	0,0065
P11	218.19-080T-MD04 MS2500	SPMX060204-75 F40M	11,0	0,14	0,14	0,15
			0,44	0,0055	0,0055	0,0060
P12	218.19-080T-MD04 MS2500	SPMX060204-75 F40M	9,0	0,095	0,095	0,10
			0,36	0,0038	0,0038	0,0040
M1	218.19-080T-M04 F40M	SPMX060204-75 F40M	11,0	0,15	0,15	0,17
			0,44	0,0060	0,0060	0,0065
M2	218.19-080T-M04 F40M	SPMX060204-75 F40M	11,0	0,14	0,14	0,15
			0,44	0,0055	0,0055	0,0060
M3	218.19-080T-M04 F40M	SPMX060204-75 F40M	9,0	0,11	0,11	0,12
			0,36	0,0044	0,0044	0,0048
M4	218.19-080T-M04 F40M	SPMX060204-75 F40M	6,0	0,11	0,11	0,11
			0,24	0,0044	0,0044	0,0044
M5	218.19-080T-M04 F40M	SPMX060204-75 F40M	6,0	0,11	0,11	0,11
			0,24	0,0044	0,0044	0,0044
K1	218.19-080T-MD04 F15M	SPMX060204-75 F40M	11,0	0,15	0,15	0,17
			0,44	0,0060	0,0060	0,0065
K2	218.19-080T-MD04 F15M	SPMX060204-75 F40M	11,0	0,14	0,14	0,15
			0,44	0,0055	0,0055	0,0060
K3	218.19-080T-MD04 F15M	SPMX060204-75 F40M	11,0	0,14	0,14	0,15
			0,44	0,0055	0,0055	0,0060
K4	218.19-080T-MD04 F15M	SPMX060204-75 F40M	11,0	0,14	0,14	0,15
			0,44	0,0055	0,0055	0,0060
K5	218.19-080T-MD04 F15M	SPMX060204-75 F40M	11,0	0,12	0,12	0,14
			0,44	0,0048	0,0048	0,0055
K6	218.19-080T-MD04 F15M	SPMX060204-75 F40M	11,0	0,14	0,14	0,15
			0,44	0,0055	0,0055	0,0060
K7	218.19-080T-MD04 F15M	SPMX060204-75 F40M	11,0	0,12	0,12	0,14
			0,44	0,0048	0,0048	0,0055
S1	218.19-080T-M04 F40M	SPMX060204-75 F40M	6,0	0,11	0,11	0,11
			0,24	0,0044	0,0044	0,0044
S2	218.19-080T-M04 F40M	SPMX060204-75 F40M	6,0	0,11	0,11	0,11
			0,24	0,0044	0,0044	0,0044
S3	218.19-080T-M04 F40M	SPMX060204-75 F40M	6,0	0,10	0,10	0,10
			0,24	0,0040	0,0040	0,0040
S11	218.19-080T-M04 F40M	SPMX060204-75 F40M	8,0	0,12	0,12	0,12
			0,32	0,0048	0,0048	0,0048
S12	218.19-080T-M04 F40M	SPMX060204-75 F40M	8,0	0,12	0,12	0,12
			0,32	0,0048	0,0048	0,0048
S13	218.19-080T-M04 F40M	SPMX060204-75 F40M	6,0	0,11	0,11	0,11
			0,24	0,0044	0,0044	0,0044
H5	218.19-080T-MD04 F15M	SPMX060204-75 F40M	7,0	0,090	0,090	0,095
			0,28	0,0036	0,0036	0,0038
H8	218.19-080T-MD04 F15M	SPMX060204-75 F40M	6,0	0,070	0,070	0,075
			0,24	0,0028	0,0028	0,0030
H11	218.19-080T-MD04 F15M	SPMX060204-75 F40M	7,0	0,090	0,090	0,095
			0,28	0,0036	0,0036	0,0038
H12	218.19-080T-M04 F30M	SPMX060204-75 F40M	6,0	0,070	0,070	0,075
			0,24	0,0028	0,0028	0,0030
H21	218.19-080T-MD04 F15M	SPMX060204-75 F40M	6,0	0,070	0,070	0,075
			0,24	0,0028	0,0028	0,0030

SMG = Seco material group
 f_z = mm/tooth (in/tooth), v_c = m/min (sf/min), a_p/DC = %
 All cutting data are start values

R218.19-080 – Insert selection – mm/Inch

SMG			a_p	f_z		
				15%	10%	5%
P1	218.19-080T-M04 F40M	SPMX060204-75 F40M	11,0	0,22	0,25	0,36
			0,44	0,0085	0,010	0,014
P2	218.19-080T-M04 F40M	SPMX060204-75 F40M	11,0	0,22	0,26	0,36
			0,44	0,0085	0,010	0,014
P3	218.19-080T-M04 F40M	SPMX060204-75 F40M	11,0	0,20	0,24	0,34
			0,44	0,0080	0,0095	0,013
P4	218.19-080T-M04 MP2501	SPMX060204-75 F40M	11,0	0,20	0,24	0,34
			0,44	0,0080	0,0095	0,013
P5	218.19-080T-M04 MP2501	SPMX060204-75 F40M	11,0	0,20	0,24	0,34
			0,44	0,0080	0,0095	0,013
P6	218.19-080T-M04 MP2501	SPMX060204-75 F40M	11,0	0,19	0,24	0,32
			0,44	0,0075	0,0095	0,013
P7	218.19-080T-M04 MP2501	SPMX060204-75 F40M	11,0	0,19	0,24	0,32
			0,44	0,0075	0,0095	0,013
P8	218.19-080T-M04 MP2501	SPMX060204-75 F40M	11,0	0,20	0,24	0,34
			0,44	0,0080	0,0095	0,013
P11	218.19-080T-M04 MP2501	SPMX060204-75 F40M	11,0	0,19	0,24	0,32
			0,44	0,0075	0,0095	0,013
P12	218.19-080T-M04 MP2501	SPMX060204-75 F40M	9,0	0,13	0,16	0,22
			0,36	0,0050	0,0065	0,0085
M1	218.19-080T-M04 F30M	SPMX060204-75 F40M	11,0	0,22	0,26	0,36
			0,44	0,0085	0,010	0,014
M2	218.19-080T-M04 F30M	SPMX060204-75 F40M	11,0	0,20	0,24	0,34
			0,44	0,0080	0,0095	0,013
M3	218.19-080T-M04 F30M	SPMX060204-75 F40M	9,0	0,16	0,19	0,26
			0,36	0,0065	0,0075	0,010
M4	218.19-080T-M04 F30M	SPMX060204-75 F40M	6,0	0,14	0,17	0,24
			0,24	0,0055	0,0065	0,0095
M5	218.19-080T-M04 F30M	SPMX060204-75 F40M	6,0	0,14	0,17	0,24
			0,24	0,0055	0,0065	0,0095
K1	218.19-080T-MD04 F15M	SPMX060204-75 F40M	11,0	0,22	0,26	0,36
			0,44	0,0085	0,010	0,014
K2	218.19-080T-MD04 F15M	SPMX060204-75 F40M	11,0	0,20	0,24	0,34
			0,44	0,0080	0,0095	0,013
K3	218.19-080T-MD04 F15M	SPMX060204-75 F40M	11,0	0,20	0,24	0,34
			0,44	0,0080	0,0095	0,013
K4	218.19-080T-MD04 F15M	SPMX060204-75 F40M	11,0	0,20	0,24	0,34
			0,44	0,0080	0,0095	0,013
K5	218.19-080T-MD04 F15M	SPMX060204-75 F40M	11,0	0,18	0,22	0,30
			0,44	0,0070	0,0085	0,012
K6	218.19-080T-MD04 F15M	SPMX060204-75 F40M	11,0	0,20	0,24	0,34
			0,44	0,0080	0,0095	0,013
K7	218.19-080T-MD04 F15M	SPMX060204-75 F40M	11,0	0,18	0,22	0,30
			0,44	0,0070	0,0085	0,012
S1	218.19-080T-M04 F40M	SPMX060204-75 F40M	6,0	0,14	0,17	0,24
			0,24	0,0055	0,0065	0,0095
S2	218.19-080T-M04 F40M	SPMX060204-75 F40M	6,0	0,14	0,17	0,24
			0,24	0,0055	0,0065	0,0095
S3	218.19-080T-M04 F40M	SPMX060204-75 F40M	6,0	0,13	0,16	0,22
			0,24	0,0050	0,0065	0,0085
S11	218.19-080T-M04 F40M	SPMX060204-75 F40M	8,0	0,16	0,19	0,26
			0,32	0,0065	0,0075	0,010
S12	218.19-080T-M04 F40M	SPMX060204-75 F40M	8,0	0,16	0,19	0,26
			0,32	0,0065	0,0075	0,010
S13	218.19-080T-M04 F40M	SPMX060204-75 F40M	6,0	0,14	0,17	0,24
			0,24	0,0055	0,0065	0,0095
H5	218.19-080T-MD04 F15M	SPMX060204-75 F40M	7,0	0,12	0,14	0,20
			0,28	0,0048	0,0055	0,0080
H8	218.19-080T-MD04 F15M	SPMX060204-75 F40M	6,0	0,090	0,11	0,15
			0,24	0,0036	0,0044	0,0060
H11	218.19-080T-MD04 F15M	SPMX060204-75 F40M	7,0	0,12	0,14	0,20
			0,28	0,0048	0,0055	0,0080
H12	218.19-080T-M04 F30M	SPMX060204-75 F40M	6,0	0,090	0,11	0,15
			0,24	0,0036	0,0044	0,0060
H21	218.19-080T-MD04 F15M	SPMX060204-75 F40M	6,0	0,090	0,11	0,15
			0,24	0,0036	0,0044	0,0060

SMG = Seco material group
 f_z = mm/tooth (in/tooth), v_c = m/min (sf/min), a_p/DC = %
 All cutting data are start values

Square shoulder and slot milling cutters
 Helical milling cutters
 Face milling cutters
 Disc milling cutters
 High feed milling cutters
 Copy milling cutters
 Plunge milling cutters
 Chamfer milling cutters
 Spot facing cutters
 Inserts

R218.19-080 – Cutting data $v_c = (m/min)/(sf/min)$

SMG	MP2501					F15M					F40M					MS2500				
	100%	70%	30%	10%	5%	100%	70%	30%	10%	5%	100%	70%	30%	10%	5%	100%	70%	30%	10%	5%
P1	275	300	365	430	460	—	—	—	—	—	210	225	275	325	350	285	310	380	445	480
	900	980	1200	1400	1500	—	—	—	—	—	690	740	900	1075	1150	940	1025	1250	1450	1575
P2	265	290	350	415	450	—	—	—	—	—	200	220	265	315	340	275	300	360	430	465
	870	950	1150	1350	1475	—	—	—	—	—	660	720	870	1025	1125	900	980	1175	1400	1525
P3	235	255	305	365	395	—	—	—	—	—	175	195	230	275	300	240	265	315	375	405
	770	840	1000	1200	1300	—	—	—	—	—	570	640	750	900	980	790	870	1025	1225	1325
P4	205	225	275	320	345	—	—	—	—	—	155	170	210	245	260	215	235	285	330	360
	670	740	900	1050	1125	—	—	—	—	—	510	560	690	800	850	710	770	940	1075	1175
P5	195	215	260	305	330	—	—	—	—	—	150	165	200	230	250	205	220	270	315	340
	640	710	850	1000	1075	—	—	—	—	—	490	540	660	750	820	670	720	890	1025	1125
P6	220	240	295	345	375	—	—	—	—	—	165	180	225	260	285	230	250	305	355	390
	720	790	970	1125	1225	—	—	—	—	—	540	590	740	850	940	750	820	1000	1175	1275
P7	210	225	275	325	355	—	—	—	—	—	160	170	210	245	270	215	235	285	335	370
	690	740	900	1075	1175	—	—	—	—	—	520	560	690	800	890	710	770	940	1100	1225
P8	195	215	255	305	330	—	—	—	—	—	150	165	195	230	250	205	220	265	315	340
	640	710	840	1000	1075	—	—	—	—	—	490	540	640	750	820	670	720	870	1025	1125
P11	205	220	270	315	345	—	—	—	—	—	155	165	205	240	260	210	230	280	325	355
	670	720	890	1025	1125	—	—	—	—	—	510	540	670	790	850	690	750	920	1075	1175
P12	140	150	180	210	230	—	—	—	—	—	105	115	135	160	175	140	155	190	220	240
	460	490	590	690	750	—	—	—	—	—	345	375	445	520	570	460	510	620	720	790
M1	190	210	250	300	325	—	—	—	—	—	165	180	215	255	275	200	215	260	310	335
	620	690	820	980	1075	—	—	—	—	—	540	590	710	840	900	660	710	850	1025	1100
M2	160	175	210	245	265	—	—	—	—	—	135	145	180	210	225	165	180	215	255	275
	520	570	690	800	870	—	—	—	—	—	445	475	590	690	740	540	590	710	840	900
M3	135	145	175	205	225	—	—	—	—	—	115	125	150	175	190	140	150	180	210	230
	445	475	570	670	740	—	—	—	—	—	375	410	490	570	620	460	490	590	690	750
M4	115	120	145	175	190	—	—	—	—	—	95	100	125	145	160	115	125	150	180	195
	375	395	475	570	620	—	—	—	—	—	310	330	410	475	520	375	410	490	590	640
M5	95	100	120	145	155	—	—	—	—	—	80	85	105	120	135	95	100	125	150	160
	310	330	395	475	510	—	—	—	—	—	260	280	345	395	445	310	330	410	490	520
K1	210	230	275	330	355	185	200	240	285	310	160	175	210	250	270	—	—	—	—	—
	690	750	900	1075	1175	610	660	790	940	1025	520	570	690	820	890	—	—	—	—	—
K2	185	205	250	290	315	160	175	215	250	270	140	155	190	220	235	—	—	—	—	—
	610	670	820	950	1025	520	570	710	820	890	460	510	620	720	770	—	—	—	—	—
K3	160	170	210	245	265	135	150	180	210	230	120	130	160	185	200	—	—	—	—	—
	520	560	690	800	870	445	490	590	690	750	395	425	520	610	660	—	—	—	—	—
K4	150	165	200	235	255	130	140	175	205	220	115	125	150	180	190	—	—	—	—	—
	490	540	660	770	840	425	460	570	670	720	375	410	490	590	620	—	—	—	—	—
K5	95	100	120	145	155	80	90	105	125	135	70	75	90	110	120	—	—	—	—	—
	310	330	395	475	510	260	295	345	410	445	230	245	295	360	395	—	—	—	—	—
K6	135	145	175	205	225	115	125	150	180	190	100	110	135	155	170	—	—	—	—	—
	445	475	570	670	740	375	410	490	590	620	330	360	445	510	560	—	—	—	—	—
K7	120	130	155	185	200	105	115	135	160	170	90	100	120	140	150	—	—	—	—	—
	395	425	510	610	660	345	375	445	520	560	295	330	395	460	490	—	—	—	—	—
N1	—	—	—	—	—	—	—	—	—	—	1175	1300	1550	1825	1975	—	—	—	—	—
	—	—	—	—	—	—	—	—	—	—	3850	4275	5075	6000	6475	—	—	—	—	—
N2	—	—	—	—	—	—	—	—	—	—	480	520	620	740	800	—	—	—	—	—
	—	—	—	—	—	—	—	—	—	—	1575	1700	2025	2425	2625	—	—	—	—	—
N3	—	—	—	—	—	—	—	—	—	—	320	345	415	495	530	—	—	—	—	—
	—	—	—	—	—	—	—	—	—	—	1050	1125	1350	1625	1750	—	—	—	—	—
N11	—	—	—	—	—	—	—	—	—	—	365	395	475	560	610	—	—	—	—	—
	—	—	—	—	—	—	—	—	—	—	1200	1300	1550	1825	2000	—	—	—	—	—
S1	55	60	70	85	90	—	—	—	—	—	45	47	60	70	75	55	60	75	85	95
	180	195	230	280	295	—	—	—	—	—	150	155	195	230	245	180	195	245	280	310
S2	44	47	55	70	75	—	—	—	—	—	36	38	47	55	60	46	48	60	70	75
	145	155	180	230	245	—	—	—	—	—	120	125	155	180	195	150	155	195	230	245
S3	39	41	50	60	65	—	—	—	—	—	32	34	41	48	55	40	43	50	60	65
	130	135	165	195	215	—	—	—	—	—	105	110	135	155	180	130	140	165	195	215
S11	70	75	95	110	120	—	—	—	—	—	60	65	80	90	100	75	80	100	115	125
	230	245	310	360	395	—	—	—	—	—	195	215	260	295	330	245	260	330	375	410
S12	50	55	65	75	85	—	—	—	—	—	40	44	55	65	70	50	55	70	80	90
	165	180	215	245	280	—	—	—	—	—	130	145	180	215	230	165	180	230	260	295
S13	31	33	40	47	50	—	—	—	—	—	25	27	33	38	42	32	34	41	49	55
	100	110	130	155	165	—	—	—	—	—	80	90	110	125	140	105	110	135	160	180
H5	45	49	60	70	75	43	46	55	65	70	38	40	49	60	65	—	—	—	—	—
	150	160	195	230	245	140	150	180	215	230	125	130	160	195	215	—	—	—	—	—
H8	49	55	65	75	80	47	50	60	70	80	41	44	55	60	70	—	—	—	—	—
	160	180	215	245	260	155	165	195	230	260	135	145	180	195	230	—	—	—	—	—
H11	60	60	75	90	95	55	60	70	85	90	48	50	60	75	80	—	—	—	—	—
	195	195	245	295	310	180	195	230	280	295	155	165	195	245	260	—	—	—	—	—
H12	100	105	125	150	160	85	90	105	125	140	75	80	95	110	125	—	—	—	—	—
	330	345	410	490	520	280	295	345	410	460	245	260	310	360	410	—	—	—	—	—
H21	49	55	65	75	80	47	50	60	70	80	41	44	55	60	70	—	—	—	—	—
	160	180	215	245	260	155	165	195	230	260	135	145	180	195	230	—	—	—	—	—

R218.19-100 – Insert selection – mm/Inch

SMG			a _p	f _z		
				100%	70%	30%
P1	218.19-100T-M06 F40M	SPMX070304-75 F40M	19,0	0,20	0,20	0,22
			0,75	0,0080	0,0080	0,0085
P2	218.19-100T-M06 F40M	SPMX070304-75 F40M	19,0	0,22	0,22	0,24
			0,75	0,0085	0,0085	0,0095
P3	218.19-100T-M06 F40M	SPMX070304-75 F40M	19,0	0,20	0,20	0,22
			0,75	0,0080	0,0080	0,0085
P4	218.19-100T-MD08 MP2501	SPMX070304-75 F40M	19,0	0,26	0,26	0,28
			0,75	0,010	0,010	0,011
P5	218.19-100T-MD08 MP2501	SPMX070304-75 F40M	19,0	0,26	0,26	0,28
			0,75	0,010	0,010	0,011
P6	218.19-100T-MD08 MP2501	SPMX070304-75 F40M	19,0	0,25	0,25	0,28
			0,75	0,010	0,010	0,011
P7	218.19-100T-MD08 MP2501	SPMX070304-75 F40M	19,0	0,25	0,25	0,28
			0,75	0,010	0,010	0,011
P8	218.19-100T-MD08 MP2501	SPMX070304-75 F40M	19,0	0,26	0,26	0,30
			0,75	0,010	0,010	0,012
P11	218.19-100T-MD08 MS2500	SPMX070304-75 F40M	19,0	0,25	0,25	0,28
			0,75	0,010	0,010	0,011
P12	218.19-100T-MD08 MS2500	SPMX070304-75 F40M	16,0	0,18	0,18	0,19
			0,65	0,0070	0,0070	0,0075
M1	218.19-100T-M06 T350M	SPMX070304-75 F40M	19,0	0,22	0,22	0,24
			0,75	0,0085	0,0085	0,0095
M2	218.19-100T-M06 T350M	SPMX070304-75 F40M	19,0	0,19	0,19	0,22
			0,75	0,0075	0,0075	0,0085
M3	218.19-100T-M06 T350M	SPMX070304-75 F40M	16,0	0,16	0,16	0,17
			0,65	0,0065	0,0065	0,0065
M4	218.19-100T-M06 T350M	SPMX070304-75 F40M	12,0	0,14	0,14	0,15
			0,48	0,0055	0,0055	0,0060
M5	218.19-100T-M06 T350M	SPMX070304-75 F40M	12,0	0,14	0,14	0,15
			0,48	0,0055	0,0055	0,0060
K1	218.19-100T-MD08 F15M	SPMX070304-75 F40M	19,0	0,28	0,28	0,30
			0,75	0,011	0,011	0,012
K2	218.19-100T-MD08 F15M	SPMX070304-75 F40M	19,0	0,26	0,26	0,28
			0,75	0,010	0,010	0,011
K3	218.19-100T-MD08 F15M	SPMX070304-75 F40M	19,0	0,26	0,26	0,28
			0,75	0,010	0,010	0,011
K4	218.19-100T-MD08 F15M	SPMX070304-75 F40M	19,0	0,26	0,26	0,28
			0,75	0,010	0,010	0,011
K5	218.19-100T-MD08 F15M	SPMX070304-75 F40M	19,0	0,24	0,24	0,25
			0,75	0,0095	0,0095	0,010
K6	218.19-100T-MD08 F15M	SPMX070304-75 F40M	19,0	0,26	0,26	0,28
			0,75	0,010	0,010	0,011
K7	218.19-100T-MD08 F15M	SPMX070304-75 F40M	19,0	0,24	0,24	0,25
			0,75	0,0095	0,0095	0,010
S1	218.19-100T-M06 MS2500	SPMX070304-75 F40M	12,0	0,14	0,14	0,15
			0,48	0,0055	0,0055	0,0060
S2	218.19-100T-M06 MS2500	SPMX070304-75 F40M	12,0	0,13	0,13	0,14
			0,48	0,0050	0,0050	0,0055
S3	218.19-100T-M06 MS2500	SPMX070304-75 F40M	14,0	0,16	0,16	0,17
			0,55	0,0065	0,0065	0,0065
S11	218.19-100T-M06 MS2050	SPMX070304-75 F40M	14,0	0,16	0,16	0,17
			0,55	0,0065	0,0065	0,0065
S12	218.19-100T-M06 MS2050	SPMX070304-75 F40M	14,0	0,16	0,16	0,17
			0,55	0,0065	0,0065	0,0065
S13	218.19-100T-M06 MS2050	SPMX070304-75 F40M	12,0	0,14	0,14	0,15
			0,48	0,0055	0,0055	0,0060
H5	218.19-100T-MD08 F15M	SPMX070304-75 F40M	12,0	0,16	0,16	0,17
			0,48	0,0065	0,0065	0,0065
H8	218.19-100T-MD08 F15M	SPMX070304-75 F40M	11,0	0,12	0,12	0,13
			0,44	0,0048	0,0048	0,0050
H11	218.19-100T-MD08 F15M	SPMX070304-75 F40M	12,0	0,16	0,16	0,17
			0,48	0,0065	0,0065	0,0065
H12	218.19-100T-M06 MP3000	SPMX070304-75 F40M	11,0	0,090	0,090	0,10
			0,44	0,0036	0,0036	0,0040
H21	218.19-100T-MD08 F15M	SPMX070304-75 F40M	11,0	0,12	0,12	0,13
			0,44	0,0048	0,0048	0,0050

SMG = Seco material group
 f_z = mm/tooth (in/tooth), v_c = m/min (sf/min), a_p/DC = %
 All cutting data are start values

Square shoulder and slot milling cutters
 Helical milling cutters
 Face milling cutters
 Disc milling cutters
 High feed milling cutters
 Copy milling cutters
 Plunge milling cutters
 Chamfer milling cutters
 Spot facing cutters
 Inserts

R218.19-100 – Insert selection – mm/Inch

SMG			a_p	f_z		
				15%	10%	5%
P1	218.19-100T-M06 F40M	SPMX070304-75 F40M	19,0	0,30	0,36	0,50
			0,75	0,012	0,014	0,020
P2	218.19-100T-M06 F40M	SPMX070304-75 F40M	19,0	0,30	0,36	0,50
			0,75	0,012	0,014	0,020
P3	218.19-100T-M06 F40M	SPMX070304-75 F40M	19,0	0,28	0,34	0,48
			0,75	0,011	0,013	0,019
P4	218.19-100T-M06 MP2501	SPMX070304-75 F40M	19,0	0,28	0,34	0,48
			0,75	0,011	0,013	0,019
P5	218.19-100T-M06 MP2501	SPMX070304-75 F40M	19,0	0,28	0,32	0,46
			0,75	0,011	0,013	0,018
P6	218.19-100T-M06 MP2501	SPMX070304-75 F40M	19,0	0,28	0,32	0,46
			0,75	0,011	0,013	0,018
P7	218.19-100T-M06 MP2501	SPMX070304-75 F40M	19,0	0,28	0,32	0,46
			0,75	0,011	0,013	0,018
P8	218.19-100T-M06 MP2501	SPMX070304-75 F40M	19,0	0,28	0,34	0,48
			0,75	0,011	0,013	0,019
P11	218.19-100T-M06 MP2501	SPMX070304-75 F40M	19,0	0,28	0,32	0,46
			0,75	0,011	0,013	0,018
P12	218.19-100T-M06 MP2501	SPMX070304-75 F40M	16,0	0,19	0,22	0,32
			0,65	0,0075	0,0085	0,013
M1	218.19-100T-M06 F40M	SPMX070304-75 F40M	19,0	0,30	0,36	0,50
			0,75	0,012	0,014	0,020
M2	218.19-100T-M06 F40M	SPMX070304-75 F40M	19,0	0,28	0,32	0,46
			0,75	0,011	0,013	0,018
M3	218.19-100T-M06 F40M	SPMX070304-75 F40M	16,0	0,22	0,26	0,38
			0,65	0,0085	0,010	0,015
M4	218.19-100T-M06 F40M	SPMX070304-75 F40M	12,0	0,20	0,24	0,32
			0,48	0,0080	0,0095	0,013
M5	218.19-100T-M06 F40M	SPMX070304-75 F40M	12,0	0,20	0,24	0,32
			0,48	0,0080	0,0095	0,013
K1	218.19-100T-MD08 F25M	SPMX070304-75 F40M	19,0	0,40	0,48	0,70
			0,75	0,016	0,019	0,028
K2	218.19-100T-MD08 F25M	SPMX070304-75 F40M	19,0	0,36	0,44	0,65
			0,75	0,014	0,017	0,026
K3	218.19-100T-MD08 F25M	SPMX070304-75 F40M	19,0	0,36	0,44	0,65
			0,75	0,014	0,017	0,026
K4	218.19-100T-MD08 F25M	SPMX070304-75 F40M	19,0	0,36	0,44	0,65
			0,75	0,014	0,017	0,026
K5	218.19-100T-MD08 F25M	SPMX070304-75 F40M	19,0	0,32	0,40	0,55
			0,75	0,013	0,016	0,022
K6	218.19-100T-MD08 F25M	SPMX070304-75 F40M	19,0	0,36	0,44	0,65
			0,75	0,014	0,017	0,026
K7	218.19-100T-MD08 F25M	SPMX070304-75 F40M	19,0	0,32	0,40	0,55
			0,75	0,013	0,016	0,022
S1	218.19-100T-M06 F40M	SPMX070304-75 F40M	12,0	0,20	0,24	0,32
			0,48	0,0080	0,0095	0,013
S2	218.19-100T-M06 F40M	SPMX070304-75 F40M	12,0	0,20	0,24	0,32
			0,48	0,0080	0,0095	0,013
S3	218.19-100T-M06 F40M	SPMX070304-75 F40M	12,0	0,18	0,22	0,30
			0,48	0,0070	0,0085	0,012
S11	218.19-100T-M06 MS2050	SPMX070304-75 F40M	14,0	0,22	0,26	0,38
			0,55	0,0085	0,010	0,015
S12	218.19-100T-M06 MS2050	SPMX070304-75 F40M	14,0	0,22	0,26	0,38
			0,55	0,0085	0,010	0,015
S13	218.19-100T-M06 MS2050	SPMX070304-75 F40M	12,0	0,20	0,24	0,32
			0,48	0,0080	0,0095	0,013
H5	218.19-100T-MD08 F15M	SPMX070304-75 F40M	12,0	0,22	0,26	0,36
			0,48	0,0085	0,010	0,014
H8	218.19-100T-MD08 F15M	SPMX070304-75 F40M	11,0	0,17	0,20	0,28
			0,44	0,0065	0,0080	0,011
H11	218.19-100T-MD08 F15M	SPMX070304-75 F40M	12,0	0,22	0,26	0,36
			0,48	0,0085	0,010	0,014
H12	218.19-100T-M06 MP3000	SPMX070304-75 F40M	11,0	0,13	0,15	0,20
			0,44	0,0050	0,0060	0,0080
H21	218.19-100T-MD08 F15M	SPMX070304-75 F40M	11,0	0,17	0,20	0,28
			0,44	0,0065	0,0080	0,011

SMG = Seco material group
 f_z = mm/tooth (in/tooth), v_c = m/min (sf/min), a_p/DC = %
 All cutting data are start values

R218.19-125 – Insert selection – mm/Inch

SMG			a _p	f _z		
				100%	70%	30%
P1	218.19-125T-T3-M07 T350M	SPMX090304-75 F40M	24,0	0,22	0,22	0,25
			0,95	0,0085	0,0085	0,010
P2	218.19-125T-T3-M07 T350M	SPMX090304-75 F40M	24,0	0,22	0,22	0,25
			0,95	0,0085	0,0085	0,010
P3	218.19-125T-T3-M07 T350M	SPMX090304-75 F40M	24,0	0,22	0,22	0,24
			0,95	0,0085	0,0085	0,0095
P4	218.19-125T-T3-MD10 MP2501	SPMX090304-75 F40M	24,0	0,30	0,30	0,34
			0,95	0,012	0,012	0,013
P5	218.19-125T-T3-MD10 MP2501	SPMX090304-75 F40M	24,0	0,30	0,30	0,32
			0,95	0,012	0,012	0,013
P6	218.19-125T-T3-MD10 MP2501	SPMX090304-75 F40M	24,0	0,30	0,30	0,32
			0,95	0,012	0,012	0,013
P7	218.19-125T-T3-MD10 MP2501	SPMX090304-75 F40M	24,0	0,30	0,30	0,32
			0,95	0,012	0,012	0,013
P8	218.19-125T-T3-MD10 MP2501	SPMX090304-75 F40M	24,0	0,30	0,30	0,34
			0,95	0,012	0,012	0,013
P11	218.19-125T-T3-MD10 MS2500	SPMX090304-75 F40M	24,0	0,30	0,30	0,32
			0,95	0,012	0,012	0,013
P12	218.19-125T-T3-MD10 MS2500	SPMX090304-75 F40M	19,0	0,20	0,20	0,22
			0,75	0,0080	0,0080	0,0085
M1	218.19-125T-T3-M07 T350M	SPMX090304-75 F40M	24,0	0,22	0,22	0,25
			0,95	0,0085	0,0085	0,010
M2	218.19-125T-T3-M07 T350M	SPMX090304-75 F40M	24,0	0,20	0,20	0,22
			0,95	0,0080	0,0080	0,0085
M3	218.19-125T-T3-M07 T350M	SPMX090304-75 F40M	19,0	0,17	0,17	0,18
			0,75	0,0065	0,0065	0,0070
M4	218.19-125T-T3-M07 T350M	SPMX090304-75 F40M	14,0	0,15	0,15	0,16
			0,55	0,0060	0,0060	0,0065
M5	218.19-125T-T3-M07 T350M	SPMX090304-75 F40M	14,0	0,15	0,15	0,16
			0,55	0,0060	0,0060	0,0065
K1	218.19-125T-T3-MD10 F15M	SPMX090304-75 F40M	24,0	0,32	0,32	0,36
			0,95	0,013	0,013	0,014
K2	218.19-125T-T3-MD10 F15M	SPMX090304-75 F40M	24,0	0,30	0,30	0,32
			0,95	0,012	0,012	0,013
K3	218.19-125T-T3-MD10 F15M	SPMX090304-75 F40M	24,0	0,30	0,30	0,32
			0,95	0,012	0,012	0,013
K4	218.19-125T-T3-MD10 F15M	SPMX090304-75 F40M	24,0	0,30	0,30	0,32
			0,95	0,012	0,012	0,013
K5	218.19-125T-T3-MD10 F15M	SPMX090304-75 F40M	24,0	0,26	0,26	0,30
			0,95	0,010	0,010	0,012
K6	218.19-125T-T3-MD10 F15M	SPMX090304-75 F40M	24,0	0,30	0,30	0,32
			0,95	0,012	0,012	0,013
K7	218.19-125T-T3-MD10 F15M	SPMX090304-75 F40M	24,0	0,26	0,26	0,30
			0,95	0,010	0,010	0,012
S1	218.19-125T-T3-M07 MS2500	SPMX090304-75 F40M	14,0	0,15	0,15	0,16
			0,55	0,0060	0,0060	0,0065
S2	218.19-125T-T3-M07 MS2500	SPMX090304-75 F40M	14,0	0,15	0,15	0,16
			0,55	0,0060	0,0060	0,0065
S3	218.19-125T-T3-M07 MS2500	SPMX090304-75 F40M	14,0	0,14	0,14	0,15
			0,55	0,0055	0,0055	0,0060
S11	218.19-125T-T3-M07 MS2050	SPMX090304-75 F40M	17,0	0,17	0,17	0,19
			0,65	0,0065	0,0065	0,0075
S12	218.19-125T-T3-M07 MS2050	SPMX090304-75 F40M	17,0	0,17	0,17	0,19
			0,65	0,0065	0,0065	0,0075
S13	218.19-125T-T3-M07 MS2050	SPMX090304-75 F40M	14,0	0,15	0,15	0,16
			0,55	0,0060	0,0060	0,0065
H5	218.19-125T-T3-MD10 F15M	SPMX090304-75 F40M	15,0	0,18	0,18	0,20
			0,60	0,0070	0,0070	0,0080
H8	218.19-125T-T3-MD10 F15M	SPMX090304-75 F40M	13,0	0,14	0,14	0,15
			0,50	0,0055	0,0055	0,0060
H11	218.19-125T-T3-MD10 F15M	SPMX090304-75 F40M	15,0	0,18	0,18	0,20
			0,60	0,0070	0,0070	0,0080
H12	218.19-125T-T3-MD08 MP3000	SPMX090304-75 F40M	13,0	0,11	0,11	0,12
			0,50	0,0044	0,0044	0,0048
H21	218.19-125T-T3-MD10 F15M	SPMX090304-75 F40M	13,0	0,14	0,14	0,15
			0,50	0,0055	0,0055	0,0060

SMG = Seco material group
 f_z = mm/tooth (in/tooth), v_c = m/min (sf/min), a_p/DC = %
 All cutting data are start values

Square shoulder and slot milling cutters
 Helical milling cutters
 Face milling cutters
 Disc milling cutters
 High feed milling cutters
 Copy milling cutters
 Plunge milling cutters
 Chamfer milling cutters
 Spot facing cutters
 Inserts

R218.19-125 – Insert selection – mm/Inch

SMG			a_p	f_z					
				15%	10%	5%			
Square shoulder and slot milling cutters	P1	218.19-125T-T3-M07 F40M	SPMX090304-75 F40M	24,0 0,95	0,32 0,013	0,38 0,015	0,55 0,022		
	P2	218.19-125T-T3-M07 F40M	SPMX090304-75 F40M	24,0 0,95	0,32 0,013	0,38 0,015	0,55 0,022		
	Helical milling cutters	P3	218.19-125T-T3-M07 F40M	SPMX090304-75 F40M	24,0 0,95	0,30 0,012	0,36 0,014	0,50 0,020	
		P4	218.19-125T-T3-M07 MP2501	SPMX090304-75 F40M	24,0 0,95	0,30 0,012	0,36 0,014	0,50 0,020	
		P5	218.19-125T-T3-M07 MP2501	SPMX090304-75 F40M	24,0 0,95	0,30 0,012	0,36 0,014	0,50 0,020	
		P6	218.19-125T-T3-M07 MP2501	SPMX090304-75 F40M	24,0 0,95	0,30 0,012	0,34 0,013	0,50 0,020	
		P7	218.19-125T-T3-M07 MP2501	SPMX090304-75 F40M	24,0 0,95	0,30 0,012	0,34 0,013	0,50 0,020	
		P8	218.19-125T-T3-M07 MP2501	SPMX090304-75 F40M	24,0 0,95	0,30 0,012	0,36 0,014	0,50 0,020	
	Face milling cutters	P11	218.19-125T-T3-M07 MP2501	SPMX090304-75 F40M	24,0 0,95	0,30 0,012	0,34 0,013	0,50 0,020	
		P12	218.19-125T-T3-M07 MP2501	SPMX090304-75 F40M	19,0 0,75	0,20 0,0080	0,24 0,0095	0,34 0,013	
		Disc milling cutters	M1	218.19-125T-T3-M07 MP3000	SPMX090304-75 F40M	24,0 0,95	0,32 0,013	0,38 0,015	0,55 0,022
			M2	218.19-125T-T3-M07 MP3000	SPMX090304-75 F40M	24,0 0,95	0,30 0,012	0,36 0,014	0,50 0,020
M3	218.19-125T-T3-M07 MP3000		SPMX090304-75 F40M	19,0 0,75	0,24 0,0095	0,28 0,011	0,40 0,016		
M4	218.19-125T-T3-M07 MP3000		SPMX090304-75 F40M	14,0 0,55	0,22 0,0085	0,25 0,010	0,36 0,014		
M5	218.19-125T-T3-M07 MP3000		SPMX090304-75 F40M	14,0 0,55	0,22 0,0085	0,25 0,010	0,36 0,014		
High feed milling cutters	K1	218.19-125T-T3-MD10 F25M	SPMX090304-75 F40M	24,0 0,95	0,46 0,018	0,55 0,022	0,80 0,032		
	K2	218.19-125T-T3-MD10 F25M	SPMX090304-75 F40M	24,0 0,95	0,42 0,017	0,50 0,020	0,70 0,028		
	K3	218.19-125T-T3-MD10 F25M	SPMX090304-75 F40M	24,0 0,95	0,42 0,017	0,50 0,020	0,70 0,028		
	K4	218.19-125T-T3-MD10 F25M	SPMX090304-75 F40M	24,0 0,95	0,42 0,017	0,50 0,020	0,70 0,028		
	K5	218.19-125T-T3-MD10 F25M	SPMX090304-75 F40M	24,0 0,95	0,38 0,015	0,46 0,018	0,65 0,026		
	K6	218.19-125T-T3-MD10 F25M	SPMX090304-75 F40M	24,0 0,95	0,42 0,017	0,50 0,020	0,70 0,028		
	K7	218.19-125T-T3-MD10 F25M	SPMX090304-75 F40M	24,0 0,95	0,38 0,015	0,46 0,018	0,65 0,026		
Copy milling cutters	S1	218.19-125T-T3-M07 F40M	SPMX090304-75 F40M	14,0 0,55	0,22 0,0085	0,25 0,010	0,36 0,014		
	S2	218.19-125T-T3-M07 F40M	SPMX090304-75 F40M	14,0 0,55	0,22 0,0085	0,25 0,010	0,36 0,014		
	S3	218.19-125T-T3-M07 F40M	SPMX090304-75 F40M	14,0 0,55	0,20 0,0080	0,24 0,0095	0,32 0,013		
	Plunge milling cutters	S11	218.19-125T-T3-M07 MS2050	SPMX090304-75 F40M	17,0 0,65	0,24 0,0095	0,28 0,011	0,40 0,016	
		S12	218.19-125T-T3-M07 MS2050	SPMX090304-75 F40M	17,0 0,65	0,24 0,0095	0,28 0,011	0,40 0,016	
		S13	218.19-125T-T3-M07 MS2050	SPMX090304-75 F40M	14,0 0,55	0,22 0,0085	0,25 0,010	0,36 0,014	
H5		218.19-125T-T3-MD10 F15M	SPMX090304-75 F40M	15,0 0,60	0,25 0,010	0,30 0,012	0,42 0,017		
H8		218.19-125T-T3-MD10 F15M	SPMX090304-75 F40M	13,0 0,50	0,19 0,0075	0,24 0,0095	0,32 0,013		
Chamfer milling cutters	H11	218.19-125T-T3-MD10 F15M	SPMX090304-75 F40M	15,0 0,60	0,25 0,010	0,30 0,012	0,42 0,017		
	H12	218.19-125T-T3-M07 MP3000	SPMX090304-75 F40M	13,0 0,50	0,14 0,0055	0,16 0,0065	0,22 0,0085		
	H21	218.19-125T-T3-MD10 F15M	SPMX090304-75 F40M	13,0 0,50	0,19 0,0075	0,24 0,0095	0,32 0,013		

SMG = Seco material group
 f_z = mm/tooth (in/tooth), v_c = m/min (sf/min), a_p/DC = %
 All cutting data are start values

R218.19-125 – Cutting data $v_c = (m/min)/(sf/min)$

SMG	MP2501					T350M					F15M					F40M				
	100%	70%	30%	10%	5%	100%	70%	30%	10%	5%	100%	70%	30%	10%	5%	100%	70%	30%	10%	5%
P1	195	215	260	310	335	210	230	275	330	350	180	195	240	285	300	180	200	240	285	305
	640	710	850	1025	1100	690	750	900	1075	1150	590	640	790	940	980	590	660	790	940	1000
P2	190	210	255	305	325	205	220	270	320	340	175	190	230	275	295	175	195	235	280	300
	620	690	840	1000	1075	670	720	890	1050	1125	570	620	750	900	970	570	640	770	920	980
P3	170	185	225	260	285	175	190	235	280	305	155	165	205	235	260	155	165	205	245	265
	560	610	740	850	940	570	620	770	920	1000	510	540	670	770	850	510	540	670	800	870
P4	150	160	195	235	250	155	170	205	245	265	135	145	180	215	230	135	145	180	215	230
	490	520	640	770	820	510	560	670	800	870	445	475	590	710	750	445	475	590	710	750
P5	140	155	190	225	245	150	165	200	235	255	130	140	175	205	225	130	145	175	205	220
	460	510	620	740	800	490	540	660	770	840	425	460	570	670	740	425	475	570	670	720
P6	160	175	215	255	275	170	185	225	270	285	145	155	195	230	250	150	160	195	235	250
	520	570	710	840	900	560	610	740	890	940	475	510	640	750	820	490	520	640	770	820
P7	150	165	205	240	260	160	175	215	255	270	135	150	185	220	235	140	150	185	220	235
	490	540	670	790	850	520	570	710	840	890	445	490	610	720	770	460	490	610	720	770
P8	140	155	190	220	240	150	160	195	235	255	130	140	170	200	220	130	140	170	205	220
	460	510	620	720	790	490	520	640	770	840	425	460	560	660	720	425	460	560	670	720
P11	145	160	195	235	250	155	170	210	245	260	135	145	180	210	230	135	150	180	215	230
	475	520	640	770	820	510	560	690	800	850	445	475	590	690	750	445	490	590	710	750
P12	100	110	130	155	165	105	115	135	160	175	—	—	—	—	—	90	100	120	140	150
	330	360	425	510	540	345	375	445	520	570	—	—	—	—	—	295	330	395	460	490
M1	140	150	185	220	235	155	170	205	245	265	—	—	—	—	—	145	155	190	225	240
	460	490	610	720	770	510	560	670	800	870	—	—	—	—	—	475	510	620	740	790
M2	115	125	155	180	195	130	140	175	200	220	—	—	—	—	—	120	130	160	185	200
	375	410	510	590	640	425	460	570	660	720	—	—	—	—	—	395	425	520	610	660
M3	95	105	125	150	160	105	115	140	165	180	—	—	—	—	—	95	105	130	150	160
	310	345	410	490	520	345	375	460	540	590	—	—	—	—	—	310	345	425	490	520
M4	80	85	100	115	125	85	95	110	130	140	—	—	—	—	—	80	85	100	115	125
	260	280	330	375	410	280	310	360	425	460	—	—	—	—	—	260	280	330	375	410
M5	65	70	85	95	105	75	80	90	105	115	—	—	—	—	—	65	70	85	95	105
	215	230	280	310	345	245	260	295	345	375	—	—	—	—	—	215	230	280	310	345
K1	150	165	200	240	255	160	175	215	255	270	140	150	185	220	235	140	155	185	220	235
	490	540	660	790	840	520	570	710	840	890	460	490	610	720	770	460	510	610	720	770
K2	135	145	180	215	230	145	155	190	225	240	125	135	165	195	210	125	135	165	195	210
	445	475	590	710	750	475	510	620	740	790	410	445	540	640	690	410	445	540	640	690
K3	115	125	155	180	195	120	135	160	190	205	105	110	140	165	180	105	115	140	165	180
	375	410	510	590	640	395	445	520	620	670	345	360	460	540	590	345	375	460	540	590
K4	110	120	145	175	190	115	125	155	180	195	100	105	135	160	170	100	110	135	155	170
	360	395	475	570	620	375	410	510	590	640	330	345	445	520	560	330	360	445	510	560
K5	70	75	90	105	115	70	75	95	110	120	60	65	80	95	105	60	65	80	95	105
	230	245	295	345	375	230	245	310	360	395	195	215	260	310	345	195	215	260	310	345
K6	95	105	130	155	165	105	110	135	160	170	85	95	115	140	150	90	95	120	140	150
	310	345	425	510	540	345	360	445	520	560	280	310	375	460	490	295	310	395	460	490
K7	85	95	115	135	145	90	100	120	140	155	80	85	105	125	135	80	85	105	125	135
	280	310	375	445	475	295	330	395	460	510	260	280	345	410	445	260	280	345	410	445
N1	—	—	—	—	—	—	—	—	—	—	—	—	—	—	—	1000	1100	1350	1600	1725
	—	—	—	—	—	—	—	—	—	—	—	—	—	—	—	3275	3600	4425	5250	5650
N2	—	—	—	—	—	—	—	—	—	—	—	—	—	—	—	405	440	550	650	700
	—	—	—	—	—	—	—	—	—	—	—	—	—	—	—	1325	1450	1800	2125	2300
N3	—	—	—	—	—	—	—	—	—	—	—	—	—	—	—	270	295	365	430	465
	—	—	—	—	—	—	—	—	—	—	—	—	—	—	—	890	970	1200	1400	1525
N11	—	—	—	—	—	—	—	—	—	—	—	—	—	—	—	310	335	415	490	530
	—	—	—	—	—	—	—	—	—	—	—	—	—	—	—	1025	1100	1350	1600	1750
S1	—	—	—	—	—	41	43	50	60	65	—	—	—	—	—	37	39	47	55	60
	—	—	—	—	—	135	140	165	195	215	—	—	—	—	—	120	130	155	180	195
S2	—	—	—	—	—	33	35	41	48	55	—	—	—	—	—	30	32	38	44	48
	—	—	—	—	—	110	115	135	155	180	—	—	—	—	—	100	105	125	145	155
S3	—	—	—	—	—	29	31	36	43	46	—	—	—	—	—	26	28	33	39	42
	—	—	—	—	—	95	100	120	140	150	—	—	—	—	—	85	90	110	130	140
S11	—	—	—	—	—	55	60	70	85	90	—	—	—	—	—	49	55	65	75	80
	—	—	—	—	—	180	195	230	280	295	—	—	—	—	—	160	180	215	245	260
S12	—	—	—	—	—	38	41	50	60	60	—	—	—	—	—	34	37	45	55	55
	—	—	—	—	—	125	135	165	195	195	—	—	—	—	—	110	120	150	180	180
S13	—	—	—	—	—	23	24	29	34	37	—	—	—	—	—	21	22	26	31	33
	—	—	—	—	—	75	80	95	110	120	—	—	—	—	—	70	70	85	100	110
H5	—	—	—	—	—	37	40	48	55	60	32	35	43	50	55	32	35	42	49	55
	—	—	—	—	—	120	130	155	180	195	105	115	140	165	180	105	115	140	160	180
H8	—	—	—	—	—	41	44	50	60	65	36	39	47	55	60	35	38	45	55	60
	—	—	—	—	—	135	145	165	195	215	120	130	155	180	195	115	125	150	180	195
H11	—	—	—	—	—	47	50	60	70	80	41	45	55	65	70	40	44	55	65	70
	—	—	—	—	—	155	165	195	230	260	135	150	180	215	230	130	145	180	215	230
H12	—	—	—	—	—	75	80	95	110	120	65	70	85	95	105	65	70	80	95	105
	—	—	—	—	—	245	260	310	360	395	215	230	280	310	345	215	230	260	310	345
H21	—	—	—	—	—	41	44													

R218.19-125 – Cutting data $v_c = (m/min)/(sf/min)$

SMG	MS2050					MS2500					MP3000					F25M				
	100%	70%	30%	10%	5%	100%	70%	30%	10%	5%	100%	70%	30%	10%	5%	100%	70%	30%	10%	5%
P1	200	220	265	315	335	265	285	345	410	440	230	245	300	355	380	165	180	220	260	275
	660	720	870	1025	1100	870	940	1125	1350	1450	750	800	980	1175	1250	540	590	720	850	900
P2	195	210	255	305	325	255	275	335	400	430	220	240	290	350	370	160	175	210	255	270
	640	690	840	1000	1075	840	900	1100	1300	1400	720	790	950	1150	1225	520	570	690	840	890
P3	170	180	225	265	290	220	240	295	350	380	190	205	255	305	330	140	155	185	215	235
	560	590	740	870	950	720	790	970	1150	1250	620	670	840	1000	1075	460	510	610	710	770
P4	150	160	195	235	255	195	210	260	310	335	170	180	225	270	290	125	135	165	200	210
	490	520	640	770	840	640	690	850	1025	1100	560	590	740	890	950	410	445	540	660	690
P5	145	160	195	225	245	190	205	255	295	320	165	180	220	255	275	120	130	160	190	205
	475	520	640	740	800	620	670	840	970	1050	540	590	720	840	900	395	425	520	620	670
P6	165	175	215	255	275	215	230	285	335	360	185	200	245	290	310	135	145	180	210	230
	540	570	710	840	900	710	750	940	1100	1175	610	660	800	950	1025	445	475	590	690	750
P7	155	165	205	240	260	200	220	270	315	340	175	190	230	275	295	125	135	170	200	215
	510	540	670	790	850	660	720	890	1025	1125	570	620	750	900	970	410	445	560	660	710
P8	140	155	190	225	245	185	200	245	295	320	160	175	215	255	275	120	130	155	185	200
	460	510	620	740	800	610	660	800	970	1050	520	570	710	840	900	395	425	510	610	660
P11	150	165	200	235	250	195	215	260	310	330	170	185	225	265	285	120	130	165	195	210
	490	540	660	770	820	640	710	850	1025	1075	560	610	740	870	940	395	425	540	640	690
P12	100	110	130	155	165	130	140	170	205	220	115	125	150	175	190	85	90	110	130	140
	330	360	425	510	540	425	460	560	670	720	375	410	490	570	620	280	295	360	425	460
M1	155	170	205	245	265	185	200	240	285	305	165	180	220	260	280	—	—	—	—	—
	510	560	670	800	870	610	660	790	940	1000	540	590	720	850	920	—	—	—	—	—
M2	130	140	175	200	220	150	165	200	235	255	140	150	185	215	230	—	—	—	—	—
	425	460	570	660	720	490	540	660	770	840	460	490	610	710	750	—	—	—	—	—
M3	105	115	140	170	180	125	135	165	195	210	110	120	150	175	190	—	—	—	—	—
	345	375	460	560	590	410	445	540	640	690	360	395	490	570	620	—	—	—	—	—
M4	85	95	115	135	145	100	110	135	160	170	90	100	120	145	155	—	—	—	—	—
	280	310	375	445	475	330	360	445	520	560	295	330	395	475	510	—	—	—	—	—
M5	75	80	95	115	120	85	90	110	130	140	75	85	100	120	130	—	—	—	—	—
	245	260	310	375	395	280	295	360	425	460	245	280	330	395	425	—	—	—	—	—
K1	—	—	—	—	—	—	—	—	—	—	175	190	230	275	295	125	135	170	200	215
	—	—	—	—	—	—	—	—	—	—	570	620	750	900	970	410	445	560	660	710
K2	—	—	—	—	—	—	—	—	—	—	155	170	210	240	265	110	120	150	180	195
	—	—	—	—	—	—	—	—	—	—	510	560	690	790	870	360	395	490	590	640
K3	—	—	—	—	—	—	—	—	—	—	135	145	175	205	220	95	105	130	150	165
	—	—	—	—	—	—	—	—	—	—	445	475	570	670	720	310	345	425	490	540
K4	—	—	—	—	—	—	—	—	—	—	125	140	170	195	210	90	100	120	145	155
	—	—	—	—	—	—	—	—	—	—	410	460	560	640	690	295	330	395	475	510
K5	—	—	—	—	—	—	—	—	—	—	75	85	105	120	130	55	60	75	90	95
	—	—	—	—	—	—	—	—	—	—	245	280	345	395	425	180	195	245	295	310
K6	—	—	—	—	—	—	—	—	—	—	110	120	150	175	185	80	85	110	125	140
	—	—	—	—	—	—	—	—	—	—	360	395	490	570	610	260	280	360	410	460
K7	—	—	—	—	—	—	—	—	—	—	100	105	130	155	170	75	80	95	115	120
	—	—	—	—	—	—	—	—	—	—	330	345	425	510	560	245	260	310	375	395
N1	—	—	—	—	—	—	—	—	—	—	1250	1350	1700	2000	2175	—	—	—	—	—
	—	—	—	—	—	—	—	—	—	—	4100	4425	5575	6550	7125	—	—	—	—	—
N2	—	—	—	—	—	—	—	—	—	—	510	550	680	810	870	—	—	—	—	—
	—	—	—	—	—	—	—	—	—	—	1675	1800	2225	2650	2850	—	—	—	—	—
N3	—	—	—	—	—	—	—	—	—	—	340	365	455	540	580	—	—	—	—	—
	—	—	—	—	—	—	—	—	—	—	1125	1200	1500	1775	1900	—	—	—	—	—
N11	—	—	—	—	—	—	—	—	—	—	385	420	520	620	670	—	—	—	—	—
	—	—	—	—	—	—	—	—	—	—	1275	1375	1700	2025	2200	—	—	—	—	—
S1	41	44	55	65	70	50	55	65	75	85	43	47	55	65	70	—	—	—	—	—
	135	145	180	215	230	165	180	215	245	280	140	155	180	215	230	—	—	—	—	—
S2	33	36	43	50	55	40	43	55	60	65	35	37	46	55	60	—	—	—	—	—
	110	120	140	165	180	130	140	180	195	215	115	120	150	180	195	—	—	—	—	—
S3	29	31	38	45	49	35	38	46	55	60	30	33	40	47	50	—	—	—	—	—
	95	100	125	150	160	115	125	150	180	195	100	110	130	155	165	—	—	—	—	—
S11	55	60	70	85	90	65	70	85	105	115	55	60	75	90	95	—	—	—	—	—
	180	195	230	280	295	215	230	280	345	375	180	195	245	295	310	—	—	—	—	—
S12	38	41	50	60	65	46	50	60	70	80	40	43	50	65	65	—	—	—	—	—
	125	135	165	195	215	150	165	195	230	260	130	140	165	215	215	—	—	—	—	—
S13	23	25	30	36	38	28	30	37	43	47	24	26	32	38	41	—	—	—	—	—
	75	80	100	120	125	90	100	120	140	155	80	85	105	125	135	—	—	—	—	—
H5	—	—	—	—	—	—	—	—	—	—	37	40	49	60	65	—	—	—	—	—
	—	—	—	—	—	—	—	—	—	—	120	130	160	195	215	—	—	—	—	—
H8	—	—	—	—	—	—	—	—	—	—	41	45	55	65	70	—	—	—	—	—
	—	—	—	—	—	—	—	—	—	—	135	150	180	215	230	—	—	—	—	—
H11	—	—	—	—	—	—	—	—	—	—	47	50	60	75	80	—	—	—	—	—
	—	—	—	—	—	—	—	—	—	—	155	165	195	245	260	—	—	—	—	—
H12	—	—	—	—	—	90	100	120	140	155	80	85	105	125	135	—	—	—	—	—
	—	—	—	—	—	295	330	395	460	510	260	280	345	410	445	—	—	—	—	—
H21	—	—	—	—	—	—	—	—	—	—	41	45	55	65	70	—	—	—	—	—
	—	—	—	—	—	—	—	—	—	—	135	150	180	215	230	—	—	—	—	—

R218.19-160 – Insert selection – mm/Inch

SMG			a_p		f_z		
					100%	70%	30%
P1	218.19-160T-04-M08 T350M	SPMT100408T-M08 F40M	28,0	0,22	0,22	0,25	
			1,1	0,0085	0,0085	0,010	
P2	218.19-160T-04-M08 T350M	SPMT100408T-M08 F40M	28,0	0,24	0,24	0,26	
			1,1	0,0095	0,0095	0,010	
P3	218.19-160T-04-M08 T350M	SPMT100408T-M08 F40M	28,0	0,22	0,22	0,24	
			1,1	0,0085	0,0085	0,0095	
P4	218.19-160T-04-MD11 MP2501	SPMT100408T-M08 F40M	28,0	0,30	0,30	0,32	
			1,1	0,012	0,012	0,013	
P5	218.19-160T-04-MD11 MP2501	SPMT100408T-M08 F40M	28,0	0,30	0,30	0,32	
			1,1	0,012	0,012	0,013	
P6	218.19-160T-04-MD11 MP2501	SPMT100408T-M08 F40M	28,0	0,28	0,28	0,32	
			1,1	0,011	0,011	0,013	
P7	218.19-160T-04-MD11 MP2501	SPMT100408T-M08 F40M	28,0	0,28	0,28	0,32	
			1,1	0,011	0,011	0,013	
P8	218.19-160T-04-MD11 MP2501	SPMT100408T-M08 F40M	28,0	0,30	0,30	0,34	
			1,1	0,012	0,012	0,013	
P11	218.19-160T-04-MD11 MS2500	SPMT100408T-M08 F40M	28,0	0,28	0,28	0,32	
			1,1	0,011	0,011	0,013	
P12	218.19-160T-04-MD11 MS2500	SPMT100408T-M08 F40M	22,0	0,20	0,20	0,22	
			0,85	0,0080	0,0080	0,0085	
M1	218.19-160T-04-M08 T350M	SPMT100408T-M08 F40M	28,0	0,24	0,24	0,26	
			1,1	0,0095	0,0095	0,010	
M2	218.19-160T-04-M08 T350M	SPMT100408T-M08 F40M	28,0	0,22	0,22	0,24	
			1,1	0,0085	0,0085	0,0095	
M3	218.19-160T-04-M08 T350M	SPMT100408T-M08 F40M	22,0	0,17	0,17	0,19	
			0,85	0,0065	0,0065	0,0075	
M4	218.19-160T-04-M08 T350M	SPMT100408T-M08 F40M	17,0	0,16	0,16	0,17	
			0,65	0,0065	0,0065	0,0065	
M5	218.19-160T-04-M08 T350M	SPMT100408T-M08 F40M	17,0	0,16	0,16	0,17	
			0,65	0,0065	0,0065	0,0065	
K1	218.19-160T-04-MD11 MK2050	SPMT100408T-M08 F40M	28,0	0,32	0,32	0,36	
			1,1	0,013	0,013	0,014	
K2	218.19-160T-04-MD11 MK2050	SPMT100408T-M08 F40M	28,0	0,30	0,30	0,32	
			1,1	0,012	0,012	0,013	
K3	218.19-160T-04-MD11 MK2050	SPMT100408T-M08 F40M	28,0	0,30	0,30	0,32	
			1,1	0,012	0,012	0,013	
K4	218.19-160T-04-MD11 MK2050	SPMT100408T-M08 F40M	28,0	0,30	0,30	0,32	
			1,1	0,012	0,012	0,013	
K5	218.19-160T-04-MD11 MK2050	SPMT100408T-M08 F40M	28,0	0,26	0,26	0,28	
			1,1	0,010	0,010	0,011	
K6	218.19-160T-04-MD11 MK2050	SPMT100408T-M08 F40M	28,0	0,30	0,30	0,32	
			1,1	0,012	0,012	0,013	
K7	218.19-160T-04-MD11 MK2050	SPMT100408T-M08 F40M	28,0	0,26	0,26	0,28	
			1,1	0,010	0,010	0,011	
N1	218.19-160-04-E07 H25	SPMT100408T-M08 F40M	28,0	0,26	0,26	0,28	
			1,1	0,010	0,010	0,011	
N2	218.19-160-04-E07 H25	SPMT100408T-M08 F40M	28,0	0,26	0,26	0,28	
			1,1	0,010	0,010	0,011	
N3	218.19-160-04-E07 H25	SPMT100408T-M08 F40M	28,0	0,26	0,26	0,28	
			1,1	0,010	0,010	0,011	
N11	218.19-160-04-E07 H25	SPMT100408T-M08 F40M	28,0	0,26	0,26	0,28	
			1,1	0,010	0,010	0,011	
S1	218.19-160T-04-M08 MS2500	SPMT100408T-M08 F40M	17,0	0,16	0,16	0,17	
			0,65	0,0065	0,0065	0,0065	
S2	218.19-160T-04-M08 MS2500	SPMT100408T-M08 F40M	17,0	0,16	0,16	0,17	
			0,65	0,0065	0,0065	0,0065	
S3	218.19-160T-04-M08 MS2500	SPMT100408T-M08 F40M	17,0	0,15	0,15	0,16	
			0,65	0,0060	0,0060	0,0065	
S11	218.19-160T-04-M08 MS2050	SPMT100408T-M08 F40M	20,0	0,17	0,17	0,19	
			0,80	0,0065	0,0065	0,0075	
S12	218.19-160T-04-M08 MS2050	SPMT100408T-M08 F40M	20,0	0,17	0,17	0,19	
			0,80	0,0065	0,0065	0,0075	
S13	218.19-160T-04-M08 MS2050	SPMT100408T-M08 F40M	17,0	0,16	0,16	0,17	
			0,65	0,0065	0,0065	0,0065	
H5	218.19-160T-04-MD11 F15M	SPMT100408T-M08 F40M	18,0	0,18	0,18	0,19	
			0,70	0,0070	0,0070	0,0075	
H8	218.19-160T-04-MD11 F15M	SPMT100408T-M08 F40M	15,0	0,14	0,14	0,15	
			0,60	0,0055	0,0055	0,0060	
H11	218.19-160T-04-MD11 F15M	SPMT100408T-M08 F40M	18,0	0,18	0,18	0,19	
			0,70	0,0070	0,0070	0,0075	
H12	218.19-160T-04-MD09 MP3000	SPMT100408T-M08 F40M	15,0	0,12	0,12	0,12	
			0,60	0,0048	0,0048	0,0048	
H21	218.19-160T-04-MD11 F15M	SPMT100408T-M08 F40M	15,0	0,14	0,14	0,15	
			0,60	0,0055	0,0055	0,0060	

SMG = Seco material group
 f_z = mm/tooth (in/tooth), v_c = m/min (sf/min), a_p/DC = %
 All cutting data are start values

Square shoulder and slot milling cutters
 Helical milling cutters
 Face milling cutters
 Disc milling cutters
 High feed milling cutters
 Copy milling cutters
 Plunge milling cutters
 Chamfer milling cutters
 Spot facing cutters
 Inserts

R218.19-160 – Insert selection – mm/Inch

SMG			a_p		f_z		
					15%	10%	5%
P1	218.19-160T-04-M08 F40M	SPMT100408T-M08 F40M	35,0	0,32	0,38	0,55	
			1,4	0,013	0,015	0,022	
P2	218.19-160T-04-M08 F40M	SPMT100408T-M08 F40M	35,0	0,32	0,40	0,55	
			1,4	0,013	0,016	0,022	
P3	218.19-160T-04-M08 F40M	SPMT100408T-M08 F40M	35,0	0,32	0,38	0,50	
			1,4	0,013	0,015	0,020	
P4	218.19-160T-04-MD11 MP1501	SPMT100408T-M08 F40M	35,0	0,42	0,50	0,70	
			1,4	0,017	0,020	0,028	
P5	218.19-160T-04-MD11 MP1501	SPMT100408T-M08 F40M	35,0	0,42	0,50	0,70	
			1,4	0,017	0,020	0,028	
P6	218.19-160T-04-MD11 MP1501	SPMT100408T-M08 F40M	35,0	0,40	0,48	0,70	
			1,4	0,016	0,019	0,028	
P7	218.19-160T-04-MD11 MP1501	SPMT100408T-M08 F40M	35,0	0,40	0,48	0,70	
			1,4	0,016	0,019	0,028	
P8	218.19-160T-04-MD11 MP1501	SPMT100408T-M08 F40M	35,0	0,42	0,50	0,75	
			1,4	0,017	0,020	0,030	
P11	218.19-160T-04-MD11 MP1501	SPMT100408T-M08 F40M	35,0	0,40	0,48	0,70	
			1,4	0,016	0,019	0,028	
P12	218.19-160T-04-MD11 MP1501	SPMT100408T-M08 F40M	28,0	0,28	0,34	0,46	
			1,1	0,011	0,013	0,018	
M1	218.19-160T-04-M08 MP3000	SPMT100408T-M08 F40M	35,0	0,32	0,40	0,55	
			1,4	0,013	0,016	0,022	
M2	218.19-160T-04-M08 MP3000	SPMT100408T-M08 F40M	35,0	0,30	0,36	0,50	
			1,4	0,012	0,014	0,020	
M3	218.19-160T-04-M08 MP3000	SPMT100408T-M08 F40M	28,0	0,24	0,28	0,40	
			1,1	0,0095	0,011	0,016	
M4	218.19-160T-04-M08 MP3000	SPMT100408T-M08 F40M	21,0	0,22	0,25	0,36	
			0,85	0,0085	0,010	0,014	
M5	218.19-160T-04-M08 MP3000	SPMT100408T-M08 F40M	21,0	0,22	0,25	0,36	
			0,85	0,0085	0,010	0,014	
K1	218.19-160T-04-MD11 F25M	SPMT100408T-M08 F40M	35,0	0,46	0,55	0,75	
			1,4	0,018	0,022	0,030	
K2	218.19-160T-04-MD11 F25M	SPMT100408T-M08 F40M	35,0	0,42	0,50	0,70	
			1,4	0,017	0,020	0,028	
K3	218.19-160T-04-MD11 F25M	SPMT100408T-M08 F40M	35,0	0,42	0,50	0,70	
			1,4	0,017	0,020	0,028	
K4	218.19-160T-04-MD11 F25M	SPMT100408T-M08 F40M	35,0	0,42	0,50	0,70	
			1,4	0,017	0,020	0,028	
K5	218.19-160T-04-MD11 F25M	SPMT100408T-M08 F40M	35,0	0,38	0,44	0,60	
			1,4	0,015	0,017	0,024	
K6	218.19-160T-04-MD11 F25M	SPMT100408T-M08 F40M	35,0	0,42	0,50	0,70	
			1,4	0,017	0,020	0,028	
K7	218.19-160T-04-MD11 F25M	SPMT100408T-M08 F40M	35,0	0,38	0,44	0,60	
			1,4	0,015	0,017	0,024	
N1	218.19-160-04-E07 H25	SPMT100408T-M08 F40M	35,0	0,36	0,44	0,60	
			1,4	0,014	0,017	0,024	
N2	218.19-160-04-E07 H25	SPMT100408T-M08 F40M	35,0	0,36	0,44	0,60	
			1,4	0,014	0,017	0,024	
N3	218.19-160-04-E07 H25	SPMT100408T-M08 F40M	35,0	0,36	0,44	0,60	
			1,4	0,014	0,017	0,024	
N11	218.19-160-04-E07 H25	SPMT100408T-M08 F40M	35,0	0,36	0,44	0,60	
			1,4	0,014	0,017	0,024	
S1	218.19-160T-04-M08 F40M	SPMT100408T-M08 F40M	21,0	0,22	0,25	0,36	
			0,85	0,0085	0,010	0,014	
S2	218.19-160T-04-M08 F40M	SPMT100408T-M08 F40M	21,0	0,22	0,25	0,36	
			0,85	0,0085	0,010	0,014	
S3	218.19-160T-04-M08 F40M	SPMT100408T-M08 F40M	21,0	0,20	0,24	0,32	
			0,85	0,0080	0,0095	0,013	
S11	218.19-160T-04-M08 MS2050	SPMT100408T-M08 F40M	24,0	0,24	0,28	0,40	
			0,95	0,0095	0,011	0,016	
S12	218.19-160T-04-M08 MS2050	SPMT100408T-M08 F40M	24,0	0,24	0,28	0,40	
			0,95	0,0095	0,011	0,016	
S13	218.19-160T-04-M08 MS2050	SPMT100408T-M08 F40M	21,0	0,22	0,25	0,36	
			0,85	0,0085	0,010	0,014	
H5	218.19-160T-04-MD11 F15M	SPMT100408T-M08 F40M	22,0	0,25	0,30	0,40	
			0,85	0,010	0,012	0,016	
H8	218.19-160T-04-MD11 F15M	SPMT100408T-M08 F40M	19,0	0,19	0,22	0,32	
			0,75	0,0075	0,0085	0,013	
H11	218.19-160T-04-MD11 F15M	SPMT100408T-M08 F40M	22,0	0,25	0,30	0,40	
			0,85	0,010	0,012	0,016	
H12	218.19-160T-04-M08 MP3000	SPMT100408T-M08 F40M	19,0	0,14	0,16	0,22	
			0,75	0,0055	0,0065	0,0085	
H21	218.19-160T-04-MD11 F15M	SPMT100408T-M08 F40M	19,0	0,19	0,22	0,32	
			0,75	0,0075	0,0085	0,013	

SMG = Seco material group
 f_z = mm/tooth (in/tooth), v_c = m/min (sf/min), a_p/DC = %
 All cutting data are start values

R218.19-160 – Cutting data $v_c = (m/min)/(sf/min)$

SMG	MP1501					MP2050					MP2501					MP3000					F15M					F40M									
	100%	70%	30%	10%	5%	100%	70%	30%	10%	5%	100%	70%	30%	10%	5%	100%	70%	30%	10%	5%	100%	70%	30%	10%	5%	100%	70%	30%	10%	5%					
P1	220	235	295	345	375	230	250	305	365	390	195	210	260	305	335	225	245	295	350	375	175	190	240	280	305	180	195	235	280	300	220	235	295	345	375
	720	770	970	1125	1225	750	820	1000	1200	1275	640	690	850	1000	1100	740	800	970	1150	1225	570	620	790	920	1000	590	640	770	920	980	720	770	970	1125	1225
P2	215	230	280	335	365	220	240	295	350	380	190	205	250	300	325	210	230	285	335	365	170	185	225	270	295	170	185	225	270	290	215	230	280	335	365
	710	750	920	1100	1200	720	790	970	1150	1250	620	670	820	980	1075	690	750	940	1100	1200	560	610	740	890	970	560	610	750	890	950	710	750	920	1100	1200
P3	185	205	245	300	315	195	210	260	305	335	165	180	220	265	280	185	205	250	295	325	150	165	200	240	255	150	165	200	240	250	185	205	245	300	315
	610	670	800	980	1025	640	690	850	1000	1100	540	590	720	870	920	610	670	820	970	1075	490	540	660	790	840	490	540	660	790	850	610	670	800	980	1025
P4	165	180	220	265	285	170	185	230	270	295	145	160	195	235	250	165	180	220	265	285	135	145	180	210	230	130	145	180	210	230	165	180	220	265	285
	540	590	720	870	940	560	610	750	890	970	475	520	640	770	820	540	590	720	870	940	445	475	590	690	750	445	475	590	690	750	540	590	720	870	940
P5	155	170	210	250	270	165	175	220	260	280	140	150	190	220	240	160	170	210	250	270	125	135	170	200	220	125	135	170	200	220	155	170	210	250	270
	510	560	690	820	890	540	570	720	850	920	460	490	620	720	790	520	560	690	820	890	410	445	560	660	720	410	445	560	660	720	510	560	690	820	890
P6	180	195	240	285	305	185	200	250	290	315	160	175	210	255	270	175	190	240	280	305	145	160	190	230	245	140	155	195	225	245	180	195	240	285	305
	590	640	790	940	1000	610	660	820	950	1025	520	570	690	840	890	570	620	790	920	1000	475	520	620	750	800	475	520	620	750	800	590	640	790	940	1000
P7	170	185	225	270	285	175	190	235	275	300	150	165	200	240	255	165	180	230	265	290	140	150	180	215	230	135	145	185	215	230	170	185	225	270	285
	560	610	740	890	940	570	620	770	900	980	490	540	660	790	840	540	590	750	870	950	460	490	590	710	750	460	490	590	710	750	560	610	740	890	940
P8	155	170	210	250	265	165	175	220	255	280	140	150	185	220	235	160	170	210	245	270	125	135	165	200	215	125	135	170	200	220	155	170	210	250	265
	510	560	690	820	870	540	570	720	840	920	460	490	610	720	770	520	560	690	800	890	410	445	540	660	710	410	445	560	660	720	510	560	690	820	870
P11	165	180	220	260	280	170	180	230	270	290	145	160	195	230	245	160	175	220	260	280	135	145	175	210	225	130	140	175	205	225	165	180	220	260	280
	540	590	720	850	920	560	590	750	890	950	520	540	690	820	890	570	620	790	920	1000	445	475	570	690	740	445	475	570	690	740	540	590	720	850	920
P12	110	120	145	175	190	115	125	150	180	195	100	105	130	155	170	110	120	145	175	185	—	—	—	—	—	90	95	115	140	150	110	120	145	175	190
	360	395	475	570	620	375	410	490	590	640	330	345	425	510	560	360	395	475	570	610	—	—	—	—	—	295	310	375	460	490	360	395	475	570	620
M1	—	—	—	—	—	155	170	215	250	270	135	145	180	215	235	160	170	215	250	275	—	—	—	—	—	135	150	185	215	235	—	—	—	—	—
	—	—	—	—	—	510	560	710	820	890	445	475	590	710	770	520	560	710	820	900	—	—	—	—	—	445	490	610	710	770	—	—	—	—	—
M2	—	—	—	—	—	130	140	175	210	225	110	120	150	180	195	130	145	175	210	225	—	—	—	—	—	115	125	150	180	195	—	—	—	—	—
	—	—	—	—	—	425	460	570	690	740	360	395	490	590	640	425	475	570	690	740	—	—	—	—	—	375	410	490	590	640	—	—	—	—	—
M3	—	—	—	—	—	110	120	145	175	185	95	100	125	155	160	110	120	145	175	185	—	—	—	—	—	95	105	125	150	160	—	—	—	—	—
	—	—	—	—	—	360	395	475	570	610	310	330	410	490	520	360	395	475	570	610	—	—	—	—	—	310	345	410	490	520	—	—	—	—	—
M4	—	—	—	—	—	85	95	115	135	145	75	85	100	120	130	90	95	115	140	150	—	—	—	—	—	75	80	100	120	130	—	—	—	—	—
	—	—	—	—	—	280	310	375	445	475	245	280	330	395	425	295	310	375	460	490	—	—	—	—	—	245	260	330	395	425	—	—	—	—	—
M5	—	—	—	—	—	75	80	95	115	120	65	70	85	100	105	75	80	95	115	125	—	—	—	—	—	65	70	85	100	105	—	—	—	—	—
	—	—	—	—	—	245	260	310	375	395	215	230	280	330	345	245	260	310	375	410	—	—	—	—	—	215	230	280	330	345	—	—	—	—	—
K1	170	180	225	265	290	—	—	—	—	—	150	160	200	235	255	170	180	225	265	290	135	145	180	215	235	135	145	180	215	230	170	180	225	265	290
	560	590	740	870	950	—	—	—	—	—	490	520	660	770	840	560	590	740	870	950	445	475	590	710	770	445	475	590	710	750	560	590	740	870	950
K2	150	160	200	240	255	—	—	—	—	—	130	145	180	210	230	150	160	200	240	260	120	130	160	190	205	120	130	160	190	205	150	160	200	240	255
	490	520	660	790	840	—	—	—	—	—	425	475	590	690	750	490	520	660	790	850	395	425	520	620	670	395	425	520	620	670	490	520	660	790	840
K3	125	135	170	200	220	—	—	—	—	—	110	120	150	180	195	125	135	170	200	220	100	110	135	160	175	100	110	135	160	175	125	135	170	200	220
	410	445	560	660	720	—	—	—	—	—	360	395	490	590	640	410	445	560	660	720	330	360	445	520	570	330	360	445	520	570	410	445	560	660	720
K4	120	130	165	190	210	—	—	—	—	—	105	115	145	170	185	120	130	160	190	210	95	105	130	155	165	95	105	130	155	165	120	130	165	190	210
	395	425	540	620	690	—	—	—	—	—	345	375	475	560	610	395	425	520	620	690	310	345	425	510	540	310	345	425	510	540	395	425	540	620	690
K5	75	80	100	120	130	—	—	—	—	—	65	70	90	105	115	75	80	100	120	130	60	65	80	95	105	60	65	80	95	105	75	80	100	120	130
	245	260	330	395	425	—	—	—	—	—	215	230	295	345	375	245	260	330	395	425	195	215	260	310	345	195	215	260	310	345	245	260	330	395	425
K6	105	115	145	170	185	—	—	—	—	—	95	100	125	150	160	105	115	140	170	185	85	95	115	135	150	85	95	115	135	145	105	115	145	170	185
	345	375	475	560</																															

R218.19-160 – Cutting data $v_c = (m/min)/(sf/min)$

SMG	MK2050					MS2050					MS2500					MH1000					H25								
	100%	70%	30%	10%	5%	100%	70%	30%	10%	5%	100%	70%	30%	10%	5%	100%	70%	30%	10%	5%	100%	70%	30%	10%	5%				
P1	190	205	255	300	330	195	215	260	310	330	260	280	340	405	430	—	—	—	—	—	—	—	—	—	—	—	—	—	—
	620	670	840	980	1075	640	710	850	1025	1075	850	920	1125	1325	1400	—	—	—	—	—	—	—	—	—	—	—	—	—	—
P2	185	200	245	295	320	185	200	250	295	320	245	265	330	385	420	—	—	—	—	—	—	—	—	—	—	—	—	—	—
	610	660	800	970	1050	610	660	820	970	1050	800	870	1075	1275	1375	—	—	—	—	—	—	—	—	—	—	—	—	—	—
P3	165	175	215	260	275	165	180	220	260	285	215	235	290	340	375	—	—	—	—	—	—	—	—	—	—	—	—	—	—
	540	570	710	850	900	540	590	720	850	940	710	770	950	1125	1225	—	—	—	—	—	—	—	—	—	—	—	—	—	—
P4	145	155	195	230	250	145	160	195	230	250	190	205	255	305	330	—	—	—	—	—	—	—	—	—	—	—	—	—	—
	475	510	640	750	820	475	520	640	750	820	620	670	840	1000	1075	—	—	—	—	—	—	—	—	—	—	—	—	—	—
P5	135	150	185	220	235	140	150	185	220	240	180	195	240	290	315	155	165	205	245	265	—	—	—	—	—	—	—	—	—
	445	490	610	720	770	460	490	610	720	790	590	640	790	950	1025	510	540	670	800	870	—	—	—	—	—	—	—	—	—
P6	160	170	210	250	265	155	170	215	250	270	205	220	280	325	350	175	190	230	280	295	—	—	—	—	—	—	—	—	—
	520	560	690	820	870	510	560	710	820	890	670	720	920	1075	1150	570	620	750	920	970	—	—	—	—	—	—	—	—	—
P7	150	160	195	235	250	145	160	200	235	255	190	210	265	305	330	165	180	220	260	280	—	—	—	—	—	—	—	—	—
	490	520	640	770	820	475	520	660	770	840	620	690	870	1000	1075	540	590	720	850	920	—	—	—	—	—	—	—	—	—
P8	135	150	180	220	230	140	150	185	215	240	180	195	240	285	315	155	165	200	245	260	—	—	—	—	—	—	—	—	—
	445	490	590	720	750	460	490	610	710	790	590	640	790	940	1025	510	540	660	800	850	—	—	—	—	—	—	—	—	—
P11	145	155	190	230	245	145	155	195	225	245	185	205	255	300	325	160	175	210	255	270	—	—	—	—	—	—	—	—	—
	475	510	620	750	800	475	510	640	740	800	610	670	840	980	1075	520	570	690	840	890	—	—	—	—	—	—	—	—	—
P12	95	105	130	150	165	100	105	130	150	165	130	140	165	200	215	110	115	145	170	185	—	—	—	—	—	—	—	—	—
	310	345	425	490	540	330	345	425	490	540	425	460	540	660	710	360	375	475	560	610	—	—	—	—	—	—	—	—	—
M1	—	—	—	—	—	150	165	205	240	260	175	190	235	275	300	—	—	—	—	—	—	—	—	—	—	—	—	—	—
	—	—	—	—	—	490	540	670	790	850	570	620	770	900	980	—	—	—	—	—	—	—	—	—	—	—	—	—	—
M2	—	—	—	—	—	125	135	165	200	215	145	160	195	230	250	—	—	—	—	—	—	—	—	—	—	—	—	—	—
	—	—	—	—	—	410	445	540	660	710	475	520	640	750	820	—	—	—	—	—	—	—	—	—	—	—	—	—	—
M3	—	—	—	—	—	105	115	140	165	175	120	130	160	190	205	—	—	—	—	—	—	—	—	—	—	—	—	—	—
	—	—	—	—	—	345	375	460	540	570	395	425	520	620	670	—	—	—	—	—	—	—	—	—	—	—	—	—	—
M4	—	—	—	—	—	85	90	110	130	140	95	105	125	150	165	—	—	—	—	—	—	—	—	—	—	—	—	—	—
	—	—	—	—	—	280	295	360	425	460	310	345	410	490	540	—	—	—	—	—	—	—	—	—	—	—	—	—	—
M5	—	—	—	—	—	70	75	90	110	115	80	90	105	125	135	—	—	—	—	—	—	—	—	—	—	—	—	—	—
	—	—	—	—	—	230	245	295	360	375	260	295	345	410	445	—	—	—	—	—	—	—	—	—	—	—	—	—	—
K1	200	215	265	315	345	—	—	—	—	—	—	—	—	—	—	165	175	215	260	285	—	—	—	—	—	—	—	—	—
	660	710	870	1025	1125	—	—	—	—	—	—	—	—	—	—	540	570	710	850	940	—	—	—	—	—	—	—	—	—
K2	180	190	240	285	305	—	—	—	—	—	—	—	—	—	—	145	155	195	230	250	—	—	—	—	—	—	—	—	—
	590	620	790	940	1000	—	—	—	—	—	—	—	—	—	—	475	510	640	750	820	—	—	—	—	—	—	—	—	—
K3	150	165	200	240	260	—	—	—	—	—	—	—	—	—	—	125	135	165	195	210	—	—	—	—	—	—	—	—	—
	490	540	660	790	850	—	—	—	—	—	—	—	—	—	—	410	445	540	640	690	—	—	—	—	—	—	—	—	—
K4	145	155	195	230	245	—	—	—	—	—	—	—	—	—	—	115	125	160	185	200	—	—	—	—	—	—	—	—	—
	475	510	640	750	800	—	—	—	—	—	—	—	—	—	—	375	410	520	610	660	—	—	—	—	—	—	—	—	—
K5	90	95	120	140	155	—	—	—	—	—	—	—	—	—	—	75	80	100	115	125	—	—	—	—	—	—	—	—	—
	295	310	395	460	510	—	—	—	—	—	—	—	—	—	—	245	260	330	375	410	—	—	—	—	—	—	—	—	—
K6	125	135	170	200	220	—	—	—	—	—	—	—	—	—	—	105	110	140	165	180	—	—	—	—	—	—	—	—	—
	410	445	560	660	720	—	—	—	—	—	—	—	—	—	—	345	360	460	540	590	—	—	—	—	—	—	—	—	—
K7	115	125	155	180	200	—	—	—	—	—	—	—	—	—	—	95	100	125	150	160	—	—	—	—	—	—	—	—	—
	375	410	510	590	660	—	—	—	—	—	—	—	—	—	—	310	330	410	490	520	—	—	—	—	—	—	—	—	—
N1	—	—	—	—	—	—	—	—	—	—	—	—	—	—	—	—	—	—	—	—	1050	1150	1400	1675	1825	—	—	—	—
	—	—	—	—	—	—	—	—	—	—	—	—	—	—	—	—	—	—	—	—	3450	3775	4600	5500	6000	—	—	—	—
N2	—	—	—	—	—	—	—	—	—	—	—	—	—	—	—	—	—	—	—	—	425	460	570	670	730	—	—	—	—
	—	—	—	—	—	—	—	—	—	—	—	—	—	—	—	—	—	—	—	—	1400	1500	1875	2200	2400	—	—	—	—
N3	—	—	—	—	—	—	—	—	—	—	—	—	—	—	—	—	—	—	—	—	285	305	380	450	490	—	—	—	—
	—	—	—	—	—	—	—	—	—	—	—	—	—	—	—	—	—	—	—	—	940	1000	1250	1475	1600	—	—	—	—
N11	—	—	—	—	—	—	—	—	—	—	—	—	—	—	—	—	—	—	—	—	325	350	435	510	560	—	—	—	—
	—	—	—	—	—	—	—	—	—	—	—	—	—	—	—	—	—	—	—	—	1075	1150	1425	1675	1825	—	—	—	—
S1	—	—	—	—	—	39	42	50	60	65	47	50	60	75	80	—	—	—	—	—	—	—	—	—	—	—	—	—	—
	—	—	—	—	—	130	140	165	195	215	155	165	195	245	260	—	—	—	—	—	—	—	—	—	—	—	—	—	—
S2	—	—	—	—	—	31	34	41	49	55	38	42	50	60	65	—	—	—	—	—	—	—							

R218.19-200 – Insert selection – mm/Inch

SMG		a _p	f _z		
			100%	70%	30%
P1	218.19-200T-05-M10 F40M	18,0	0,28	0,28	0,30
		0,70	0,011	0,011	0,012
P2	218.19-200T-05-M10 F40M	18,0	0,28	0,28	0,30
		0,70	0,011	0,011	0,012
P3	218.19-200T-05-M10 F40M	18,0	0,26	0,26	0,28
		0,70	0,010	0,010	0,011
P4	218.19-200T-05-M10 F25M	18,0	0,26	0,26	0,28
		0,70	0,010	0,010	0,011
P5	218.19-200T-05-M10 F25M	18,0	0,25	0,25	0,26
		0,70	0,010	0,010	0,010
P6	218.19-200T-05-M10 F25M	18,0	0,25	0,25	0,26
		0,70	0,010	0,010	0,010
P7	218.19-200T-05-M10 F25M	18,0	0,25	0,25	0,26
		0,70	0,010	0,010	0,010
P8	218.19-200T-05-M10 F25M	18,0	0,26	0,26	0,28
		0,70	0,010	0,010	0,011
P11	218.19-200T-05-M10 F25M	18,0	0,25	0,25	0,26
		0,70	0,010	0,010	0,010
P12	218.19-200T-05-M10 F25M	14,0	0,18	0,18	0,19
		0,55	0,0070	0,0070	0,0075
M1	218.19-200T-05-M10 F40M	18,0	0,28	0,28	0,30
		0,70	0,011	0,011	0,012
M2	218.19-200T-05-M10 F40M	18,0	0,25	0,25	0,26
		0,70	0,010	0,010	0,010
M3	218.19-200T-05-M10 F40M	14,0	0,22	0,22	0,22
		0,55	0,0085	0,0085	0,0085
M4	218.19-200T-05-M10 F40M	11,0	0,20	0,20	0,20
		0,44	0,0080	0,0080	0,0080
M5	218.19-200T-05-M10 F40M	11,0	0,20	0,20	0,20
		0,44	0,0080	0,0080	0,0080
K1	218.19-200T-05-M10 F25M	18,0	0,28	0,28	0,30
		0,70	0,011	0,011	0,012
K2	218.19-200T-05-M10 F25M	18,0	0,25	0,25	0,26
		0,70	0,010	0,010	0,010
K3	218.19-200T-05-M10 F25M	18,0	0,25	0,25	0,26
		0,70	0,010	0,010	0,010
K4	218.19-200T-05-M10 F25M	18,0	0,25	0,25	0,26
		0,70	0,010	0,010	0,010
K5	218.19-200T-05-M10 F25M	18,0	0,22	0,22	0,24
		0,70	0,0085	0,0085	0,0095
K6	218.19-200T-05-M10 F25M	18,0	0,25	0,25	0,26
		0,70	0,010	0,010	0,010
K7	218.19-200T-05-M10 F25M	18,0	0,22	0,22	0,24
		0,70	0,0085	0,0085	0,0095
N1	218.19-200T-05-ME10 F40M	18,0	0,36	0,36	0,38
		0,70	0,014	0,014	0,015
N2	218.19-200T-05-ME10 F40M	18,0	0,36	0,36	0,38
		0,70	0,014	0,014	0,015
N3	218.19-200T-05-ME10 F40M	18,0	0,36	0,36	0,38
		0,70	0,014	0,014	0,015
N11	218.19-200T-05-ME10 F40M	18,0	0,36	0,36	0,38
		0,70	0,014	0,014	0,015
S1	218.19-200T-05-M10 F40M	11,0	0,20	0,20	0,20
		0,44	0,0080	0,0080	0,0080
S2	218.19-200T-05-M10 F40M	11,0	0,20	0,20	0,20
		0,44	0,0080	0,0080	0,0080
S3	218.19-200T-05-M10 F40M	11,0	0,18	0,18	0,19
		0,44	0,0070	0,0070	0,0075
S11	218.19-200T-05-M10 F40M	13,0	0,22	0,22	0,22
		0,50	0,0085	0,0085	0,0085
S12	218.19-200T-05-M10 F40M	13,0	0,22	0,22	0,22
		0,50	0,0085	0,0085	0,0085
S13	218.19-200T-05-M10 F40M	11,0	0,20	0,20	0,20
		0,44	0,0080	0,0080	0,0080
H5	218.19-200T-05-M10 F25M	11,0	0,16	0,16	0,17
		0,44	0,0065	0,0065	0,0065
H8	218.19-200T-05-M10 F25M	10,0	0,13	0,13	0,13
		0,40	0,0050	0,0050	0,0050
H11	218.19-200T-05-M10 F25M	11,0	0,16	0,16	0,17
		0,44	0,0065	0,0065	0,0065
H12	218.19-200T-05-M10 F25M	10,0	0,13	0,13	0,13
		0,40	0,0050	0,0050	0,0050
H21	218.19-200T-05-M10 F25M	10,0	0,13	0,13	0,13
		0,40	0,0050	0,0050	0,0050

SMG = Seco material group
 f_z = mm/tooth (in/tooth), v_c = m/min (sf/min), a_p/DC = %
 All cutting data are start values

Square shoulder and slot milling cutters
 Helical milling cutters
 Face milling cutters
 Disc milling cutters
 High feed milling cutters
 Copy milling cutters
 Plunge milling cutters
 Chamfer milling cutters
 Spot facing cutters
 Inserts

R218.19-200 – Insert selection – mm/Inch

SMG		a_p	f_z		
			15%	10%	5%
P1	218.19-200T-05-M10 F40M	18,0	0,38	0,44	0,60
		0,70	0,015	0,017	0,024
P2	218.19-200T-05-M10 F40M	18,0	0,38	0,46	0,65
		0,70	0,015	0,018	0,026
P3	218.19-200T-05-M10 F40M	18,0	0,36	0,42	0,60
		0,70	0,014	0,017	0,024
P4	218.19-200T-05-M10 F25M	18,0	0,36	0,42	0,60
		0,70	0,014	0,017	0,024
P5	218.19-200T-05-M10 F25M	18,0	0,34	0,42	0,55
		0,70	0,013	0,017	0,022
P6	218.19-200T-05-M10 F25M	18,0	0,34	0,40	0,55
		0,70	0,013	0,016	0,022
P7	218.19-200T-05-M10 F25M	18,0	0,34	0,40	0,55
		0,70	0,013	0,016	0,022
P8	218.19-200T-05-M10 F25M	18,0	0,36	0,42	0,60
		0,70	0,014	0,017	0,024
P11	218.19-200T-05-M10 F25M	18,0	0,34	0,40	0,55
		0,70	0,013	0,016	0,022
P12	218.19-200T-05-M10 F25M	14,0	0,24	0,28	0,40
		0,55	0,0095	0,011	0,016
M1	218.19-200T-05-M10 F40M	18,0	0,38	0,46	0,65
		0,70	0,015	0,018	0,026
M2	218.19-200T-05-M10 F40M	18,0	0,34	0,42	0,55
		0,70	0,013	0,017	0,022
M3	218.19-200T-05-M10 F40M	14,0	0,28	0,34	0,46
		0,55	0,011	0,013	0,018
M4	218.19-200T-05-M10 F40M	11,0	0,25	0,30	0,40
		0,44	0,010	0,012	0,016
M5	218.19-200T-05-M10 F40M	11,0	0,25	0,30	0,40
		0,44	0,010	0,012	0,016
K1	218.19-200T-05-M10 F25M	18,0	0,38	0,46	0,65
		0,70	0,015	0,018	0,026
K2	218.19-200T-05-M10 F25M	18,0	0,34	0,42	0,55
		0,70	0,013	0,017	0,022
K3	218.19-200T-05-M10 F25M	18,0	0,34	0,42	0,55
		0,70	0,013	0,017	0,022
K4	218.19-200T-05-M10 F25M	18,0	0,34	0,42	0,55
		0,70	0,013	0,017	0,022
K5	218.19-200T-05-M10 F25M	18,0	0,30	0,36	0,50
		0,70	0,012	0,014	0,020
K6	218.19-200T-05-M10 F25M	18,0	0,34	0,42	0,55
		0,70	0,013	0,017	0,022
K7	218.19-200T-05-M10 F25M	18,0	0,30	0,36	0,50
		0,70	0,012	0,014	0,020
N1	218.19-200T-05-ME10 F40M	18,0	0,48	0,60	0,80
		0,70	0,019	0,024	0,032
N2	218.19-200T-05-ME10 F40M	18,0	0,48	0,60	0,80
		0,70	0,019	0,024	0,032
N3	218.19-200T-05-ME10 F40M	18,0	0,48	0,60	0,80
		0,70	0,019	0,024	0,032
N11	218.19-200T-05-ME10 F40M	18,0	0,48	0,60	0,80
		0,70	0,019	0,024	0,032
S1	218.19-200T-05-M10 F40M	11,0	0,25	0,30	0,40
		0,44	0,010	0,012	0,016
S2	218.19-200T-05-M10 F40M	11,0	0,25	0,30	0,40
		0,44	0,010	0,012	0,016
S3	218.19-200T-05-M10 F40M	11,0	0,24	0,28	0,38
		0,44	0,0095	0,011	0,015
S11	218.19-200T-05-M10 F40M	13,0	0,28	0,34	0,46
		0,50	0,011	0,013	0,018
S12	218.19-200T-05-M10 F40M	13,0	0,28	0,34	0,46
		0,50	0,011	0,013	0,018
S13	218.19-200T-05-M10 F40M	11,0	0,25	0,30	0,40
		0,44	0,010	0,012	0,016
H5	218.19-200T-05-M10 F25M	11,0	0,20	0,25	0,34
		0,44	0,0080	0,010	0,013
H8	218.19-200T-05-M10 F25M	10,0	0,16	0,19	0,26
		0,40	0,0065	0,0075	0,010
H11	218.19-200T-05-M10 F25M	11,0	0,20	0,25	0,34
		0,44	0,0080	0,010	0,013
H12	218.19-200T-05-M10 F25M	10,0	0,16	0,19	0,26
		0,40	0,0065	0,0075	0,010
H21	218.19-200T-05-M10 F25M	10,0	0,16	0,19	0,26
		0,40	0,0065	0,0075	0,010

SMG = Seco material group

 f_z = mm/tooth (in/tooth), v_c = m/min (sf/min), a_p/DC = %

All cutting data are start values

R218.19-200 – Cutting data $v_c = (m/min)/(sf/min)$

SMG	F25M					F40M				
	100%	70%	30%	10%	5%	100%	70%	30%	10%	5%
P1	220	230	285	345	380	200	210	260	315	345
	720	750	940	1125	1250	660	690	850	1025	1125
P2	215	225	280	330	360	195	205	255	300	330
	710	740	920	1075	1175	640	670	840	980	1075
P3	190	200	245	295	320	170	180	225	265	290
	620	660	800	970	1050	560	590	740	870	950
P4	165	175	215	260	280	150	160	195	235	255
	540	570	710	850	920	490	520	640	770	840
P5	160	170	210	245	275	145	155	190	225	250
	520	560	690	800	900	475	510	620	740	820
P6	180	190	235	280	310	165	175	215	255	280
	590	620	770	920	1025	540	570	710	840	920
P7	170	180	225	265	290	155	165	205	240	265
	560	590	740	870	950	510	540	670	790	870
P8	160	170	205	245	265	145	150	185	225	245
	520	560	670	800	870	475	490	610	740	800
P11	165	175	215	255	280	150	160	195	235	255
	540	570	710	840	920	490	520	640	770	840
P12	115	120	145	175	190	105	110	135	160	175
	375	395	475	570	620	345	360	445	520	570
M1	—	—	—	—	—	155	165	205	245	265
	—	—	—	—	—	510	540	670	800	870
M2	—	—	—	—	—	130	140	170	200	225
	—	—	—	—	—	425	460	560	660	740
M3	—	—	—	—	—	110	115	145	170	190
	—	—	—	—	—	360	375	475	560	620
M4	—	—	—	—	—	90	90	115	135	150
	—	—	—	—	—	295	295	375	445	490
M5	—	—	—	—	—	75	75	95	115	125
	—	—	—	—	—	245	245	310	375	410
K1	170	180	220	260	285	155	165	200	240	260
	560	590	720	850	940	510	540	660	790	850
K2	150	160	200	235	260	140	145	180	210	235
	490	520	660	770	850	460	475	590	690	770
K3	130	135	170	200	220	115	125	155	180	200
	425	445	560	660	720	375	410	510	590	660
K4	120	130	160	190	210	110	120	145	170	190
	395	425	520	620	690	360	395	475	560	620
K5	75	80	100	115	130	70	75	90	105	115
	245	260	330	375	425	230	245	295	345	375
K6	110	115	140	165	185	100	105	130	150	170
	360	375	460	540	610	330	345	425	490	560
K7	95	105	125	150	165	90	95	115	135	150
	310	345	410	490	540	295	310	375	445	490
N1	—	—	—	—	—	1125	1175	1475	1750	1925
	—	—	—	—	—	3700	3850	4850	5750	6325
N2	—	—	—	—	—	450	480	600	700	780
	—	—	—	—	—	1475	1575	1975	2300	2550
N3	—	—	—	—	—	300	320	395	470	520
	—	—	—	—	—	980	1050	1300	1550	1700
N11	—	—	—	—	—	345	365	455	530	590
	—	—	—	—	—	1125	1200	1500	1750	1925
S1	46	47	60	70	75	42	43	55	65	70
	150	155	195	230	245	140	140	180	215	230
S2	37	38	47	55	60	34	35	43	50	55
	120	125	155	180	195	110	115	140	165	180
S3	33	34	41	49	55	30	31	37	45	49
	110	110	135	160	180	100	100	120	150	160
S11	65	65	80	95	105	55	60	75	85	95
	215	215	260	310	345	180	195	245	280	310
S12	43	45	55	65	75	39	41	50	60	65
	140	150	180	215	245	130	135	165	195	215
S13	26	27	33	39	43	24	24	30	36	39
	85	90	110	130	140	80	80	100	120	130
H5	41	42	50	60	65	37	38	47	55	60
	135	140	165	195	215	120	125	155	180	195
H8	44	45	55	65	70	40	41	50	60	65
	145	150	180	215	230	130	135	165	195	215
H11	50	55	65	80	85	47	49	60	70	80
	165	180	215	260	280	155	160	195	230	260
H12	80	80	100	120	130	70	75	90	105	120
	260	260	330	395	425	230	245	295	345	395
H21	44	45	55	65	70	40	41	50	60	65
	145	150	180	215	230	130	135	165	195	215

Square shoulder and slot milling cutters
Helical milling cutters
Face milling cutters
Disc milling cutters
High feed milling cutters
Copy milling cutters
Plunge milling cutters
Chamfer milling cutters
Spot facing cutters
Inserts

R218.24 – Metric

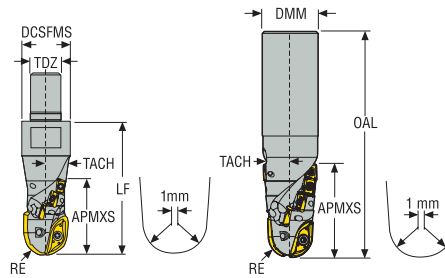

- For insert selection and cutting data recommendations, see page(s) [XXX]-[XXX]
- For complete insert programme, see page(s) 866-867, 868, 879
- For ISO attribute explanation, see page 16

Designation	Item number	Type of mounting	DC	ZEFP	APMXS	DCSFMS	DMM	TDZ	LF	RPMX	Weight	218.20	XO.X
			mm		mm	mm	mm		mm		kg		
R218.24-12R080.RE-028-06.2A	02735924	Combimaster	15,92	2	28,0	23,0	–	M12	50,0	18000	0,1	R080 (2)	06 (8)

Spare Parts, included in delivery

For cutter	Insert key	Insert screw centre	Insert screw periph	Key periphery
R218.24-080	H4B-T08P	C02506-T08P	C01804-T06P	H4B-T06P

Accessories

For cutter	Insert clamping torque	Torque key
R218.24-080	0.5NM	T00-08P12

Torque and fixed keys, see page 894

Square shoulder and slot milling cutters
Helical milling cutters
Face milling cutters
Disc milling cutters
High feed milling cutters
Copy milling cutters
Plunge milling cutters
Chamfer milling cutters
Spot facing cutters
Inserts

R218.24-080 – Insert selection – mm/Inch

SMG			f _z				
			100%	70%	30%	10%	5%
P1	218.20-080ER-ME04 F40M	XOMX060204R-M05 F40M	0,10	0,10	0,11	0,18	0,25
			0.0040	0.0040	0.0044	0.0070	0.010
P2	218.20-080ER-ME04 F40M	XOMX060204R-M05 F40M	0,10	0,10	0,11	0,18	0,25
			0.0040	0.0040	0.0044	0.0070	0.010
P3	218.20-080ER-ME04 F40M	XOMX060204R-M05 F40M	0,095	0,095	0,11	0,17	0,24
			0.0038	0.0038	0.0044	0.0065	0.0095
P4	218.20-080ER-ME04 F40M	XOMX060204R-M05 F40M	0,095	0,095	0,11	0,17	0,24
			0.0038	0.0038	0.0044	0.0065	0.0095
P5	218.20-080ER-M04 F25M	XOMX060204R-M05 F40M	0,090	0,090	0,10	0,16	0,22
			0.0036	0.0036	0.0040	0.0065	0.0085
P6	218.20-080ER-M04 F25M	XOMX060204R-M05 F40M	0,090	0,090	0,10	0,16	0,22
			0.0036	0.0036	0.0040	0.0065	0.0085
P7	218.20-080ER-M04 F25M	XOMX060204R-M05 MP3000	0,090	0,090	0,10	0,16	0,22
			0.0036	0.0036	0.0040	0.0065	0.0085
P8	218.20-080ER-M04 F25M	XOMX060204R-M05 MP3000	0,095	0,095	0,11	0,17	0,24
			0.0038	0.0038	0.0044	0.0065	0.0095
P11	218.20-080ER-M04 F25M	XOMX060204R-M05 MP3000	0,090	0,090	0,10	0,16	0,22
			0.0036	0.0036	0.0040	0.0065	0.0085
P12	218.20-080ER-M04 F25M	XOMX060204R-M05 MP3000	0,060	0,060	0,070	0,11	0,15
			0.0024	0.0024	0.0028	0.0044	0.0060
M1	218.20-080ER-ME04 F40M	XOMX060204R-M05 F40M	0,10	0,10	0,11	0,18	0,25
			0.0040	0.0040	0.0044	0.0070	0.010
M2	218.20-080ER-ME04 F40M	XOMX060204R-M05 F40M	0,090	0,090	0,10	0,16	0,22
			0.0036	0.0036	0.0040	0.0065	0.0085
M3	218.20-080ER-ME04 F40M	XOMX060204R-M05 F40M	0,075	0,075	0,080	0,13	0,18
			0.0030	0.0030	0.0032	0.0050	0.0070
M4	218.20-080ER-M04 F40M	XOMX060204R-M05 F40M	0,065	0,065	0,070	0,11	0,16
			0.0026	0.0026	0.0028	0.0044	0.0065
M5	218.20-080ER-M04 F40M	XOMX060204R-M05 F40M	0,065	0,065	0,070	0,11	0,16
			0.0026	0.0026	0.0028	0.0044	0.0065
K1	218.20-080ER-M04 F25M	XOMX060204R-M05 MP3000	0,10	0,10	0,11	0,18	0,25
			0.0040	0.0040	0.0044	0.0070	0.010
K2	218.20-080ER-M04 F25M	XOMX060204R-M05 MP3000	0,090	0,090	0,10	0,16	0,22
			0.0036	0.0036	0.0040	0.0065	0.0085
K3	218.20-080ER-M04 F25M	XOMX060204R-M05 MP3000	0,090	0,090	0,10	0,16	0,22
			0.0036	0.0036	0.0040	0.0065	0.0085
K4	218.20-080ER-M04 F25M	XOMX060204R-M05 MP3000	0,090	0,090	0,10	0,16	0,22
			0.0036	0.0036	0.0040	0.0065	0.0085
K5	218.20-080ER-M04 F25M	XOMX060204R-M05 MP3000	0,080	0,080	0,095	0,15	0,20
			0.0032	0.0032	0.0038	0.0060	0.0080
K6	218.20-080ER-M04 F25M	XOMX060204R-M05 MP3000	0,090	0,090	0,10	0,16	0,22
			0.0036	0.0036	0.0040	0.0065	0.0085
K7	218.20-080ER-M04 F25M	XOMX060204R-M05 MP3000	0,080	0,080	0,095	0,15	0,20
			0.0032	0.0032	0.0038	0.0060	0.0080
N1	218.20-080ER-ME04 F40M	XOMX060204R-M05 F40M	0,13	0,13	0,14	0,22	0,32
			0.0050	0.0050	0.0055	0.0085	0.013
N2	218.20-080ER-ME04 F40M	XOMX060204R-M05 F40M	0,13	0,13	0,14	0,22	0,32
			0.0050	0.0050	0.0055	0.0085	0.013
N3	218.20-080ER-ME04 F40M	XOMX060204R-M05 F40M	0,13	0,13	0,14	0,22	0,32
			0.0050	0.0050	0.0055	0.0085	0.013
N11	218.20-080ER-ME04 F40M	XOMX060204R-M05 F40M	0,13	0,13	0,14	0,22	0,32
			0.0050	0.0050	0.0055	0.0085	0.013
S1	218.20-080ER-ME04 T350M	XOMX060204R-M05 F40M	0,065	0,065	0,070	0,11	0,16
			0.0026	0.0026	0.0028	0.0044	0.0065
S2	218.20-080ER-ME04 T350M	XOMX060204R-M05 F40M	0,065	0,065	0,070	0,11	0,16
			0.0026	0.0026	0.0028	0.0044	0.0065
S3	218.20-080ER-ME04 T350M	XOMX060204R-M05 F40M	0,060	0,060	0,065	0,11	0,15
			0.0024	0.0024	0.0026	0.0044	0.0060
S11	218.20-080ER-ME04 MS2050	XOMX060204R-M05 MS2050	0,042	0,042	0,046	0,075	0,10
			0.0017	0.0017	0.0018	0.0030	0.0040
S12	218.20-080ER-ME04 MS2050	XOMX060204R-M05 MS2050	0,042	0,042	0,046	0,075	0,10
			0.0017	0.0017	0.0018	0.0030	0.0040
S13	218.20-080ER-ME04 MS2050	XOMX060204R-M05 MS2050	0,036	0,036	0,040	0,065	0,090
			0.0014	0.0014	0.0016	0.0026	0.0036
H11	218.20-080ER-M04 F25M	XOMX060204R-M05 MP3000	0,060	0,060	0,070	0,11	0,15
			0.0024	0.0024	0.0028	0.0044	0.0060
H12	218.20-080ER-M04 F25M	XOMX060204R-M05 MP3000	0,048	0,048	0,055	0,085	0,12
			0.0019	0.0019	0.0022	0.0034	0.0048

SMG = Seco material group
 f_z = mm/tooth (in/tooth), v_c = m/min (sf/min), a_g/DC = %
 All cutting data are start values

Square shoulder and slot milling cutters
 Helical milling cutters
 Face milling cutters
 Disc milling cutters
 High feed milling cutters
 Copy milling cutters
 Plunge milling cutters
 Chamfer milling cutters
 Spot facing cutters
 Inserts



R217/220.97

Aluminium routers high productivity cutters are designed to provide optimal performance in slotting, square shoulder milling and pocketing operations in aluminum. These tools are specifically optimized to achieve high speed and high metal removal rates in aluminum.

- Cutter range 16-100mm (0.625 - 4 inch)
- Available in cylindrical, combimaster or for arbor mounting

Square shoulder and
slot milling cutters

Helical milling cutters

Face milling cutters

Disc milling cutters

High feed milling
cutters

Copy milling cutters

Plunge milling cutters

Chamfer milling cutters

Spot facing cutters

Inserts

R217.97-X08 – Metric

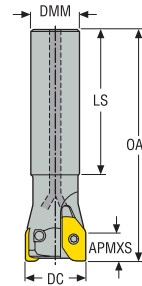

- For insert selection and cutting data recommendations, see page(s) 748
- For complete insert programme, see page(s) 875
- For ISO attribute explanation, see page 16

Designation	Item number	Type of mounting	DC	ZEFP	APMXS	DMM	LS	OAL	RMPX°	Cmin	Cmax	RPMX	Weight	Insert
			mm		mm	mm	mm	mm		mm	mm		kg	
R217.97-1616.0-X08.2A	03245364	Cylindrical	16,0	2	8,0	16,0	67,0	100,0	11,0	26,4	30,0	40000	0,2	XP..08..
R217.97-2020.0-X08.2A	03245365	Cylindrical	20,0	2	8,0	20,0	79,0	120,0	7,2	34,4	38,0	40000	0,3	XP..08..
R217.97-2525.0-X08.3A	03245366	Cylindrical	25,0	3	8,0	25,0	99,0	150,0	5,0	44,4	48,0	40000	0,6	XP..08..

Spare Parts, included in delivery

For cutter	Insert key	Insert screw
R217.97-1616-2020	H4B-T07P	C02505-T07P
R217.97-2525	H4B-T07P	C02506-T07P

Accessories

For cutter	Insert clamping torque	Torque key
R217.97-..	0.9NM	T00-07P09

Torque and fixed keys, see page 894

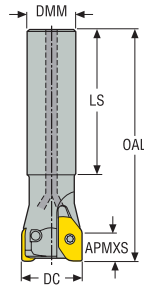

R217.97-X08 – inch





- For insert selection and cutting data recommendations, see page(s) 748
- For complete insert programme, see page(s) 875
- For ISO attribute explanation, see page 16

Designation	Item number	Type of mounting	DC	ZEPF	APMXS	DMM	LS	OAL	RMPX*	C min	C max	RPMX	Weight	Insert
			inch		inch	inch	inch	inch		inch	inch		lbs	
R217.97-0.62-0-X08.2A	03245370	Cylindrical	0.625	2	0.315	0.625	2.638	3.937	11,2	1.028	1.171	40000	0.440	XP..08..
R217.97-0.75-0-X08.2A	03245371	Cylindrical	0.750	2	0.315	0.750	3.110	4.724	7,8	1.280	1.421	40000	0.660	XP..08..
R217.97-1.00-0-X08.3A	03245372	Cylindrical	1.000	3	0.315	1.000	3.898	5.906	4,9	1.780	1.921	40000	1.320	XP..08..

Spare Parts, included in delivery

For cutter	Insert key	Insert screw
		
R217.97-0.62-0.75	H4B-T07P	C02505-T07P
R217.97-1.00	H4B-T07P	C02506-T07P

Accessories

For cutter	Insert clamping torque	Torque key
		
R217.97-..	8.0IN.LBS	T00-07P09

Torque and fixed keys, see page 894

Square shoulder and slot milling cutters

Helical milling cutters

Face milling cutters

Disc milling cutters

High feed milling cutters

Copy milling cutters

Plunge milling cutters

Chamfer milling cutters

Spot facing cutters

Inserts

R217.97-X08 – Metric

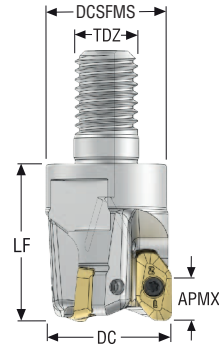

- For insert selection and cutting data recommendations, see page(s) 748
- For complete insert programme, see page(s) 875
- For ISO attribute explanation, see page 16

Designation	Item number	Type of mounting	DC	ZEFP	APMXS	TDZ	DCSFMS	LF	RMPX°	Cmin	Cmax	RPMX	Weight	Insert
			mm		mm		mm	mm		mm	mm		kg	
R217.97-0816.RE-X08.2A	03245589	Combimaster	16,0	2	8,0	M8	13,5	23,0	11,0	26,4	30,0	40000	0,1	XP.08..
R217.97-1020.RE-X08.2A	03245362	Combimaster	20,0	2	8,0	M10	18,5	28,0	7,2	34,4	38,0	40000	0,1	XP.08..
R217.97-1020.RE-X08.3A	03308725	Combimaster	20,0	3	8,0	M10	18,5	28,0	7,2	34,4	38,0	40000	0,1	XP.08..
R217.97-1225.RE-X08.3A	03245363	Combimaster	25,0	3	8,0	M12	23,0	30,0	5,0	44,4	48,0	40000	0,1	XP.08..
R217.97-1225.RE-X08.4A	03308726	Combimaster	25,0	4	8,0	M12	23,0	30,0	5,0	44,4	48,0	40000	0,1	XP.08..

For Combimaster Shanks, see Machining Navigator Tooling System

Spare Parts, included in delivery

For cutter	Insert key	Insert screw
R217.97-0816-1020	H4B-T07P	C02505-T07P
R217.97-1225	H4B-T07P	C02506-T07P

Accessories

For cutter	Insert clamping torque	Torque key
R217.97-..	0.9NM	T00-07P09

Torque and fixed keys, see page 894

R217.97-X08 – inch

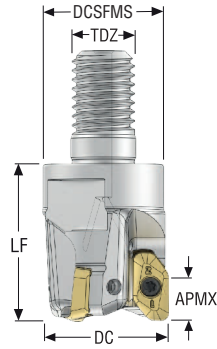

- For insert selection and cutting data recommendations, see page(s) 748
- For complete insert programme, see page(s) 875
- For ISO attribute explanation, see page 16

Designation	Item number	Type of mounting	DC	ZEFP	APMXS	TDZ	DCSFMS	LF	RMPX°	C min	C max	RPMX	Weight	Insert
			inch		inch		inch	inch		inch	inch		lbs	
R217.97-0.62-08RE-X08.2A	03245367	Combimaster	0.625	2	0.315	M8	0.531	0.906	11,2	1.028	1.171	40000	0.220	XP..08..
R217.97-0.75-10RE-X08.2A	03245368	Combimaster	0.750	2	0.315	M10	0.728	1.102	7,8	1.280	1.421	40000	0.220	XP..08..
R217.97-1.00-12RE-X08.3A	03245369	Combimaster	1.000	3	0.315	M12	0.906	1.181	4,9	1.780	1.921	40000	0.220	XP..08..

For Combimaster Shanks, see Machining Navigator Tooling System

Spare Parts, included in delivery

For cutter	Insert key	Insert screw
R217.97-0.62-0.75	H4B-T07P	C02505-T07P
R217.97-1.00	H4B-T07P	C02506-T07P

Accessories

For cutter	Insert clamping torque	Torque key
R217.97-..	8.0IN.LBS	T00-07P09

Torque and fixed keys, see page 894

Square shoulder and slot milling cutters

Helical milling cutters

Face milling cutters

Disc milling cutters

High feed milling cutters

Copy milling cutters

Plunge milling cutters

Chamfer milling cutters

Spot facing cutters

Inserts

R217.97-X12 – Metric

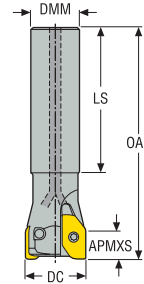

- For insert selection and cutting data recommendations, see page(s) 749
- For complete insert programme, see page(s) 875
- For ISO attribute explanation, see page 16

Designation	Item number	Type of mounting	DC	ZEFP	APMXS	DMM	LS	OAL	LUX	RMPX°	Cmin	Cmax	RPMX	Weight	Insert
			mm		mm	mm	mm	mm	mm		mm	mm		kg	
R217.97-2525.0-X12.2A	02450300	Cylindrical	25,0	2	12,0	25,0	95,0	150,0	54,5	10,0	40,0	49,0	40000	0,6	XP..12
R217.97-3232.0-X12.2A	02450301	Cylindrical	32,0	2	12,0	32,0	85,0	150,0	64,5	8,0	54,0	63,0	40000	0,8	XP..12
R217.97-3232.0-X12.3A	02450302	Cylindrical	32,0	3	12,0	32,0	85,0	150,0	64,5	8,0	54,0	63,0	40000	0,8	XP..12

Spare Parts, included in delivery

For cutter	Insert key	Insert screw
R217.97-..Ø25	H4B-T10P	C03508-T10P
R217.97-..Ø32	H4B-T10P	C03509-T10P

Accessories

For cutter	Insert clamping torque	Torque key
R217.97-..	3.0NM	T00-10P30

Torque and fixed keys, see page 894

R217.97-X12 – inch

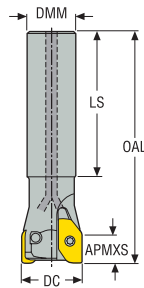

- For insert selection and cutting data recommendations, see page(s) 749
- For complete insert programme, see page(s) 875
- For ISO attribute explanation, see page 16

Designation	Item number	Type of mounting	DC	ZEFP	APMXS	DMM	LS	OAL	LUX	RMPX°	C min	C max	RPMX	Weight	Insert
			inch		inch	inch	inch	inch	inch		inch	inch		lbs	
R217.97-01.00-0-12.2A	02450377	Cylindrical	1.000	2	0.472	1.000	3.799	6.000	2.165	10,0	1.606	1.961	40000	1.320	XP.12

Spare Parts, included in delivery

For cutter	Insert key	Insert screw
R217.97-01.00	H4B-T10P	C03508-T10P

Accessories

For cutter	Insert clamping torque	Torque key
R217.97-..	26.6IN.LBS	T00-10P30

Torque and fixed keys, see page 894

Square shoulder and slot milling cutters

Helical milling cutters

Face milling cutters

Disc milling cutters

High feed milling cutters

Copy milling cutters

Plunge milling cutters

Chamfer milling cutters

Spot facing cutters

Inserts

R217/220.97-X12 – Metric

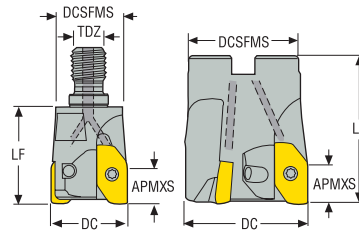

- For insert selection and cutting data recommendations, see page(s) 749
- For complete insert programme, see page(s) 875
- For ISO attribute explanation, see page 16

Designation	Item number	Type of mounting	DC	ZEFP	APMXS	TDZ	DCSFMS	LF	RMPX°	Cmin	Cmax	RPMX	Weight	Insert
			mm		mm		mm	mm		mm	mm		kg	
R217.97-1225.RE-X12.2A	02449582	Combimaster	25,0	2	12,0	M12	23,0	30,0	10,0	40,0	49,0	40000	0,2	XP..12
R217.97-1632.RE-X12.2A	02450297	Combimaster	32,0	2	12,0	M16	30,0	40,0	8,0	54,0	63,0	40000	0,3	XP..12
R217.97-1632.RE-X12.3A	02450299	Combimaster	32,0	3	12,0	M16	30,0	40,0	8,0	54,0	63,0	40000	0,3	XP..12
R217.97-1640.RE-X12.3A	02486599	Combimaster	40,0	3	12,0	M16	30,0	40,0	6,0	70,0	79,0	35000	0,3	XP..12
R217.97-2040.RE-X12.3A	02928076	Combimaster	40,0	3	12,0	M20	36,5	40,0	6,0	70,0	79,0	35000	0,4	XP..12
R220.97-0050-X12.4A	02450306	Arbor	50,0	4	12,0	–	47,0	45,0	5,0	90,0	99,0	30000	0,4	XP..12

For Combimaster Shanks, see Machining Navigator Tooling System

Spare Parts, included in delivery

For cutter	Arbor screw	Insert key	Insert screw
R217.97-.. Ø25	–	H4B-T10P	C03508-T10P
R217.97-.. Ø32-40	–	H4B-T10P	C03509-T10P
R220.97-0050	220.17-692	H4B-T10P	C03509-T10P

Accessories

For cutter	Insert clamping torque	Torque key
R217/220.97-..	3.0NM	T00-10P30

Torque and fixed keys, see page 894

R217/220.97-X12 – inch

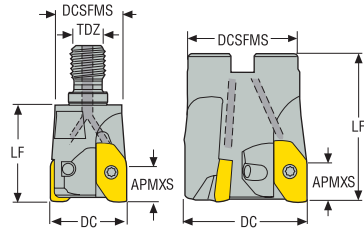

- For insert selection and cutting data recommendations, see page(s) 749
- For complete insert programme, see page(s) 875
- For ISO attribute explanation, see page 16

Designation	Item number	Type of mounting	DC	ZEFP	APMXS	TDZ	DCSFMS	LF	RMPX°	C min	C max	RPMX	Weight	Insert
			inch		inch		inch	inch		inch	inch		lbs	
R217.97-1.00-12RE-12.2A	02450374	Combimaster	1.000	2	0.472	M12	0.906	1.181	10,0	1.606	1.961	40000	0.220	XP.12
R217.97-1.25-16RE-12.3A	02450376	Combimaster	1.250	3	0.472	M16	1.181	1.575	8,0	2.106	2.461	40000	0.440	XP.12
R217.97-01.50-20RE-12.3A	02928061	Combimaster	1.500	3	0.472	M20	1.437	1.575	6,0	2.606	2.961	35000	0.660	XP.12
R217.97-1.50-16RE-12.3A	02520346	Combimaster	1.500	3	0.472	M16	1.181	1.575	6,0	2.606	2.961	35000	0.660	XP.12
R220.97-02.00-12.3A	02534482	Arbor	2.000	3	0.472	–	1.850	1.772	5,0	3.606	3.961	30000	0.880	XP.12
R220.97-02.00-12.4A	02450395	Arbor	2.000	4	0.472	–	1.850	1.772	5,0	3.606	3.961	30000	0.880	XP.12

For Combimaster Shanks, see Machining Navigator Tooling System

Spare Parts, included in delivery

For cutter	Arbor screw	Insert key	Insert screw
R217.97-01.00	–	H4B-T10P	C03508-T10P
R217.97-01.25-01.50	–	H4B-T10P	C03509-T10P
R220.97-..	UC6S3/8UNFX1	H4B-T10P	C03509-T10P

Accessories

For cutter	Insert clamping torque	Torque key
R217/220.97-..	26.6IN.LBS	T00-10P30

Torque and fixed keys, see page 894

Square shoulder and slot milling cutters

Helical milling cutters

Face milling cutters

Disc milling cutters

High feed milling cutters

Copy milling cutters

Plunge milling cutters

Chamfer milling cutters

Spot facing cutters

Inserts

R217.97-V22 – Metric

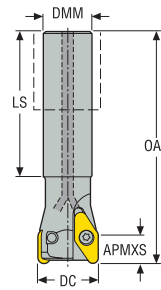

- For insert selection and cutting data recommendations, see page(s) 750
- For complete insert programme, see page(s) 862
- For ISO attribute explanation, see page 16

Designation	Item number	Type of mounting	DC	ZEFP	APMXS	DMM	LS	OAL	LUX	RMPX°	Cmin	Cmax	RPMX	Weight	Insert
			mm		mm	mm	mm	mm	mm		mm	mm		kg	
R217.97-2532.0-V22.2A	00035425	Cylindrical	32,0	2	14,0	25,0	75,0	120,0	64,0	15,0	56,0	62,0	40000	0,4	VPGX22
R217.97-3240.0-V22.2A	00035427	Cylindrical	40,0	2	14,0	32,0	105,0	150,0	90,0	10,0	72,0	78,0	35000	0,9	VPGX22

Spare Parts, included in delivery

For cutter	Insert key	Insert screw
R217.97-..	H6B-T20P	C05010-T20P

Accessories

For cutter	Insert clamping torque	Torque key
R217.97-..	5.0NM	T00-20P50

Torque and fixed keys, see page 894

Square shoulder and slot milling cutters
Helical milling cutters
Face milling cutters
Disc milling cutters
High feed milling cutters
Copy milling cutters
Plunge milling cutters
Chamfer milling cutters
Spot facing cutters
Inserts

R217.97-V22 – inch

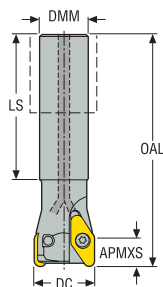

- For insert selection and cutting data recommendations, see page(s) 750
- For complete insert programme, see page(s) 862
- For ISO attribute explanation, see page 16

Designation	Item number	Type of mounting	DC	ZEFP	APMXS	DMM	LS	OAL	LUX	RMPX°	C min	C max	RPMX	Weight	Insert
			inch		inch	inch	inch	inch	inch		inch	inch		lbs	
R217.97-01.25-0-V22.2A	00054103	Cylindrical	1.250	2	0.551	1.000	4.000	6.000	3.795	10,0	2.185	2.421	40000	0.220	VPGX22
R217.97-01.50-0-V22.2A	00054181	Cylindrical	1.500	2	0.551	1.250	4.000	6.000	3.638	10,0	2.685	2.921	35000	1.980	VPGX22

Spare Parts, included in delivery

For cutter	Insert key	Insert screw
R217.97-..	H6B-T20P	C05010-T20P

Accessories

For cutter	Insert clamping torque	Torque key
R217.97-..	44.3IN.LBS	T00-20P50

Torque and fixed keys, see page 894

Square shoulder and slot milling cutters

Helical milling cutters

Face milling cutters

Disc milling cutters

High feed milling cutters

Copy milling cutters

Plunge milling cutters

Chamfer milling cutters

Spot facing cutters

Inserts

R217/220.97-V22 – Metric

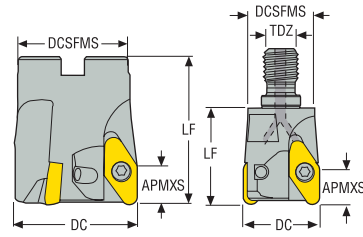

- For insert selection and cutting data recommendations, see page(s) 750
- For complete insert programme, see page(s) 862
- For ISO attribute explanation, see page 16

Designation	Item number	Type of mounting	DC	ZEFP	APMXS	TDZ	DCSFMS	LF	RMPX°	Cmin	Cmax	RPMX	Weight	Insert
			mm		mm		mm	mm		mm	mm		kg	
R217.97-1632.RE-V22.2A	00035424	Combimaster	32,0	2	14,0	M16	30,0	40,0	15,0	56,0	62,0	40000	0,2	VPGX22
R217.97-1640.RE-V22.2A	00035426	Combimaster	40,0	2	14,0	M16	30,0	40,0	10,0	72,0	78,0	35000	0,3	VPGX22
R217.97-2040.RE-V22.2A	02928075	Combimaster	40,0	2	14,0	M20	36,5	45,0	10,0	72,0	78,0	35000	0,3	VPGX22
R220.97-0050-V22.2A	00035392	Arbor	50,0	2	14,0	–	47,0	57,0	8,0	92,0	98,0	30000	0,5	VPGX22
R220.97-0050-V22.3A	00035393	Arbor	50,0	3	14,0	–	47,0	57,0	8,0	92,0	98,0	30000	0,6	VPGX22
R220.97-0063-V22.3A	00035394	Arbor	63,0	3	14,0	–	50,0	57,0	6,0	116,0	125,0	27000	0,6	VPGX22
R220.97-0063-V22.4A	00035395	Arbor	63,0	4	14,0	–	50,0	57,0	6,0	116,0	125,0	27000	0,7	VPGX22
R220.97-0080-V22.4A	00035396	Arbor	80,0	4	14,0	–	60,0	57,0	5,0	152,0	158,0	25000	1,1	VPGX22
R220.97-0100-V22.5A	00035397	Arbor	100,0	5	14,0	–	77,0	57,0	4,0	192,0	198,0	22000	1,7	VPGX22

For Combimaster Shanks, see Machining Navigator Tooling System

Spare Parts, included in delivery

For cutter	Arbor screw	Insert key	Insert screw
R217.97-1632-1640	–	H6B-T20P	C05010-T20P
R217.97-2040	–	H6B-T20P	C05010-T20P
R220.97-0050	MC6S10X40	H6B-T20P	C05010-T20P
R220.97-0063	MC6S12X35	H6B-T20P	C05013-T20P
R220.97-0080	MC6S16X35	H6B-T20P	C05013-T20P
R220.97-0100	MC6S16X35	H6B-T20PL	C05013-T20P

Accessories

For cutter	Insert clamping torque	Torque key
R217/220.97-..	5.0NM	T00-20P50

Torque and fixed keys, see page 894

R217/220.97-V22 – inch

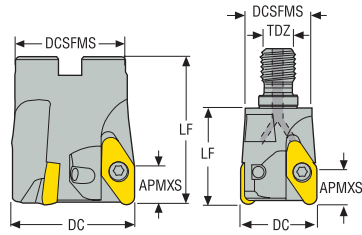

- For insert selection and cutting data recommendations, see page(s) 750
- For complete insert programme, see page(s) 862
- For ISO attribute explanation, see page 16

Designation	Item number	Type of mounting	DC	ZEFP	APMXS	TDZ	DCSFMS	LF	RMPX°	C min	C max	RPMX	Weight	Insert
			inch		inch		inch	inch		inch	inch		lbs	
R217.97-1.25-16REV22.2A	00054077	Combimaster	1.250	2	0.551	M16	1.181	1.600	10,0	2.185	2.421	40000	0.660	VPGX22
R217.97-1.50-16REV22.2A	00054146	Combimaster	1.500	2	0.551	M16	1.181	1.600	10,0	2.685	2.921	35000	0.880	VPGX22
R220.97-02.00-V22.2A	00054269	Arbor	2.000	2	0.551	–	1.850	2.250	8,0	3.685	3.921	30000	1.540	VPGX22
R220.97-02.00-V22.3A	00054587	Arbor	2.000	3	0.551	–	1.850	2.250	8,0	3.685	3.921	30000	1.320	VPGX22
R220.97-02.50-V22.4A	00055249	Arbor	2.500	4	0.551	–	2.047	2.250	6,0	4.685	4.921	27000	1.980	VPGX22
R220.97-03.00-V22.4A	00050756	Arbor	3.000	4	0.551	–	2.441	2.250	5,0	5.685	5.921	25000	2.870	VPGX22
R220.97-04.00-V22.5A	00050828	Arbor	4.000	5	0.551	–	3.543	2.250	4,0	7.685	7.921	22000	4.850	VPGX22

For Combimaster Shanks, see Machining Navigator Tooling System

Spare Parts, included in delivery

For cutter	Arbor screw	Insert key	Insert screw
R217.97-..			
R220.97-02.00	UC6S3/8UNFX11/2	H6B-T20P	C05010-T20P
R220.97-02.50-03.00	UC6S1/2UNFX1-1/2	H6B-T20P	C05013-T20P
R220.97-04.00	UC6S3/4UNFX1-1/4	H6B-T20PL	C05013-T20P

Accessories

For cutter	Insert clamping torque	Torque key
R217/220.97-..		
	44.3IN.LBS	T00-20P50

Torque and fixed keys, see page 894

Square shoulder and slot milling cutters

Helical milling cutters

Face milling cutters

Disc milling cutters

High feed milling cutters

Copy milling cutters

Plunge milling cutters

Chamfer milling cutters

Spot facing cutters

Inserts

R217.97-X08 – Insert selection – mm/Inch

SMG		a_p	f_z				
			100%	70%	30%	10%	5%
N1	XPkX080304PDER-E06 H25	4,0	0,11	0,11	0,12	0,18	0,26
		0.16	0.0044	0.0044	0.0048	0.0070	0.010
N2	XPkX080304PDER-E06 H25	4,0	0,11	0,11	0,12	0,18	0,26
		0.16	0.0044	0.0044	0.0048	0.0070	0.010
N3	XPkX080304PDER-E06 H25	4,0	0,11	0,11	0,12	0,18	0,26
		0.16	0.0044	0.0044	0.0048	0.0070	0.010
N11	XPkX080304PDER-E06 H25	4,0	0,11	0,11	0,12	0,18	0,26
		0.16	0.0044	0.0044	0.0048	0.0070	0.010

SMG = Seco material group

 f_z = mm/tooth (in/tooth), v_c = m/min (sf/min), a_p/DC = %

All cutting data are start values

R217.97-X008 – Cutting data $v_c = (m/min)/(sf/min)$

SMG	H25				
	100%	70%	30%	10%	5%
N1	2350	2550	3100	3675	3925
	7700	8375	10175	12050	12875
N2	590	640	780	920	990
	1925	2100	2550	3025	3250
N3	395	430	520	620	660
	1300	1400	1700	2025	2175
N11	450	490	590	700	760
	1475	1600	1925	2300	2500

R217/220.97-X12 – Insert selection – mm/Inch

SMG		a _p	f _z				
			100%	70%	30%	10%	5%
N1	XPKX12T304PDER-E08 H25	6,0	0,13	0,13	0,14	0,22	0,30
		0.24	0.0050	0.0050	0.0055	0.0085	0.012
N2	XPKX12T304PDER-E08 H25	6,0	0,13	0,13	0,14	0,22	0,30
		0.24	0.0050	0.0050	0.0055	0.0085	0.012
N3	XPKX12T304PDER-E08 H25	6,0	0,13	0,13	0,14	0,22	0,30
		0.24	0.0050	0.0050	0.0055	0.0085	0.012
N11	XPKX12T304PDER-E08 H25	6,0	0,13	0,13	0,14	0,22	0,30
		0.24	0.0050	0.0050	0.0055	0.0085	0.012

SMG = Seco material group
 f_z = mm/tooth (in/tooth), v_c = m/min (sf/min), a_p/DC = %
 All cutting data are start values

R217/220.97-X12 – Cutting data v_c = (m/min)/(sf/min)

SMG	H25				
	100%	70%	30%	10%	5%
N1	2175	2375	2900	3400	3700
	7125	7800	9525	11150	12150
N2	550	600	730	860	940
	1800	1975	2400	2825	3075
N3	365	400	485	570	620
	1200	1300	1600	1875	2025
N11	420	455	560	650	710
	1375	1500	1825	2125	2325

- Square shoulder and slot milling cutters
- Helical milling cutters
- Face milling cutters
- Disc milling cutters
- High feed milling cutters
- Copy milling cutters
- Plunge milling cutters
- Chamfer milling cutters
- Spot facing cutters
- Inserts

R217/220.97-V22 – Insert selection – mm/Inch

SMG		a _p	f _z				
			100%	70%	30%	10%	5%
N1	VPGX220605ER-E10 H25	7,0	0,18	0,18	0,20	0,30	0,42
		0,28	0,0070	0,0070	0,0080	0,012	0,017
N2	VPGX220605ER-E10 H25	7,0	0,18	0,18	0,20	0,30	0,42
		0,28	0,0070	0,0070	0,0080	0,012	0,017
N3	VPGX220605ER-E10 H25	7,0	0,18	0,18	0,20	0,30	0,42
		0,28	0,0070	0,0070	0,0080	0,012	0,017
N11	VPGX220605ER-E10 H25	7,0	0,18	0,18	0,20	0,30	0,42
		0,28	0,0070	0,0070	0,0080	0,012	0,017

SMG = Seco material group
 f_z = mm/tooth (in/tooth), v_c = m/min (sf/min), a_p/DC = %
 All cutting data are start values

R217/220.97-V22 – Cutting data v_c = (m/min)/(sf/min)

SMG	H15					H25				
	100%	70%	30%	10%	5%	100%	70%	30%	10%	5%
N1	2375	2575	3125	3725	4025	2050	2225	2700	3225	3500
	7800	8450	10250	12225	13200	6725	7300	8850	10575	11475
N2	600	650	790	940	1025	520	560	680	810	880
	1975	2125	2600	3075	3375	1700	1825	2225	2650	2875
N3	400	435	530	630	680	345	375	455	540	590
	1300	1425	1750	2075	2225	1125	1225	1500	1775	1925
N11	455	495	600	710	770	395	425	520	620	670
	1500	1625	1975	2325	2525	1300	1400	1700	2025	2200

- Square shoulder and slot milling cutters
- Helical milling cutters
- Face milling cutters
- Disc milling cutters
- High feed milling cutters
- Copy milling cutters
- Plunge milling cutters
- Chamfer milling cutters
- Spot facing cutters
- Inserts

Code keys metric and inch

R	217	79	18	20	0	10	A
1	2	3	4	5	6	7	8

R	217	79	01.50	3	08	3	A
1	2	3	4	5	6	7	8

1.	2.	3.
R = Right hand rotation Cx = For Seco-Capto	217 = With shank 220 = For arbor	Cutter system
4.	5. (Not for inch designation)	6.
Shank diameter (connecting thread diameter for Combimaster)	Cutter diameter	Shank type RE = Combimaster 0. = Cylindrical 3. = Weldon
7.	8.	
Insert size	A = With through coolant supply	

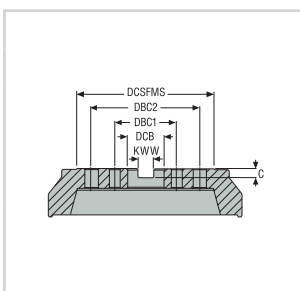

Dimensions in mm					
DCB	DCSFMS	DBC1	DBC2	KWW	C
16	30-35	-	-	8,4	5,6
22	42-47	-	-	10,4	6,3
27	48-62	-	-	12,4	7
32	60-90	-	-	14,4	8
40	90-130	66,7	-	16,4	9
60	130-270	101,6	177,8	25,7	14

Dimensions in inch					
DCB	DCSFMS	DBC1	DBC2	KWW	C
0.500	1.181 - 1.378	-	-	0.258	0.165
0.750	1.378 - 1.850	-	-	0.321	0.193
1.000	1.803 - 2.441	-	-	0.382	0.224
1.250	2.250 - 3.031	-	-	0.508	0.287
1.500	2.750 - 3.543	-	-	0.630	0.382
2.000	4.331	-	-	0.756	0.445
2.500	5.118 - 6.299 (8.858)	4.000	(7.000)	1.000	0.551

For a more exact DCSFMS and DCB measurement, see each product table.

Square shoulder and slot milling cutters

Helical milling cutters

Face milling cutters

Disc milling cutters

High feed milling cutters

Copy milling cutters

Plunge milling cutters

Chamfer milling cutters

Spot facing cutters

Inserts

Selection – Metric

Insert	a _p max	Material suitability								
		P	M	K	N	S	H			
XO06 	3,0	■	■	■	■	■	□	■	■	■
XO10 	6,0	■	■	■	■	■	□	■	■	■
XO12 	7,0	■	■	■	■	■	□	■	■	■
SCET 	11,0	■	■	■	■	■	□	-	■	■
	20,0									
	30,0									
	40,0									
XNEX08..L 	7,0	■	■	■	■	■	□	■	■	■













1st choice	■
Alternative choice	▣
Possible choice	□

High speed machine with low power/torque	
Strong stable machine with rigid connection	
Not recommended	

Unstable condition suitability	
Ramping ability	
Plunging ability	

Square shoulder and slot milling cutters
 Helical milling cutters
 Face milling cutters
 Disc milling cutters
 High feed milling cutters
 Copy milling cutters
 Plunge milling cutters
 Chamfer milling cutters
 Spot facing cutters
 Inserts

Selection – Metric

Insert	No. of cutting edges	Application	Cutter diameter (mm) available with effective number of teeth											See page		
			12	16	20	25	32	40	50	63	80	100	125		160	
XO.X06	2		2	3											762	
			3	4												
XO.X10	2				2										765	
						3	4	5								
XO.X12	2						2	3	4						772	
						2	3	4		5						
SCET12	4							2	3	4	5	6	7	8	779	
													4			
														4		
																4
XNEX08	6								3	4	5	6	7		N/A	
										5	6	7	9			

x indicates number of teeth (first choice)

x indicates number of teeth

 Troubleshooter for unstable fixturing and/or unstable conditions

 Basic choice

- Square shoulder and slot milling cutters
- Helical milling cutters
- Face milling cutters
- Disc milling cutters
- High feed milling cutters
- Copy milling cutters
- Plunge milling cutters
- Chamfer milling cutters
- Spot facing cutters
- Inserts











Selection – Inch

Insert	a _p max	Material suitability								
		P	M	K	N	S	H			
XO10 	0.236	■	■	■	■	■	□	■	■	■
XO12 	0.276	■	■	■	■	■	□	■	■	■
SCET 	0.433	■	■	■	■	■	□	-	■	■
XNEX08..L 	0.276	■	■	■	■	■	□	■	■	■

1st choice	■	High speed machine with low power/torque Strong stable machine with rigid connection Not recommended	Unstable condition suitability	
Alternative choice	▣		Ramping ability	
Possible choice	□		Plunging ability	

- Square shoulder and slot milling cutters
- Helical milling cutters
- Face milling cutters
- Disc milling cutters
- High feed milling cutters
- Copy milling cutters
- Plunge milling cutters
- Chamfer milling cutters
- Spot facing cutters
- Inserts

Selection – Inch

Insert	No. of cutting edges	Application	Cutter diameter (inch) available with effective number of teeth								See page
			0.75	1.00	1.25	1.50	2.00	2.50	3.00	4.00	
XO.X10	2		2								765
											
XO.X12	2										772
				2							
SCET12	4				2	3	4	5	6	7	779
											
											
											
XNEX08	6					3	4	6	7	9	N/A
											

x
x

x indicates number of teeth (first choice)

x indicates number of teeth



Troubleshooter for unstable fixturing and/or unstable conditions



Basic choice

- Square shoulder and slot milling cutters
- Helical milling cutters
- Face milling cutters
- Disc milling cutters
- High feed milling cutters
- Copy milling cutters
- Plunge milling cutters
- Chamfer milling cutters
- Spot facing cutters
- Inserts



Square 6 PLUNGE MILL

The Plunge Square 6 cutters are equipped with double sided inserts, means 6 cutting edges.

- Cutter range: 40-100 mm (1.5 - 3 inch)
- Max radial depth of cut 7 mm (.275 inch)
- Insert corner radii range 0.8-1.6 mm (.031 - .063 inch)

R217/220.79-08 – Metric

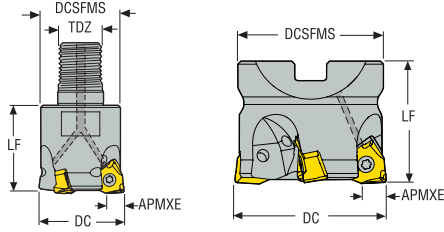

- For insert selection and cutting data recommendations, see page(s) 759-760
- For complete insert programme, see page(s) 863
- For ISO attribute explanation, see page 16

Designation	Item number	Type of mounting	DC	ZEFP	APMXE	DCB	TDZ	DCSFMS	LF	Weight	RPMX	Insert
			mm		mm	mm		mm	mm	kg		
R217.79-2040.RE-08-3A	03058302	Combimaster	40,0	3	7,0	–	M20	36,5	40,0	0,5	11800	XNEX08..L
R217.79-3240.3-08-3A	03058304	Weldon	40,0	3	7,0	–	–	–	164,0	1,3	11800	XNEX08..L
R220.79-0050-08-4A	03058315	Arbor	50,0	4	7,0	22,0	–	48,0	40,0	1,0	10600	XNEX08..L
R220.79-0050-08-5A	03058316	Arbor	50,0	5	7,0	22,0	–	48,0	40,0	0,5	10600	XNEX08..L
R220.79-0063-08-6A	03058318	Arbor	63,0	6	7,0	27,0	–	60,0	50,0	1,0	9400	XNEX08..L
R220.79-0080-08-7A	03058320	Arbor	80,0	7	7,0	27,0	–	62,0	50,0	1,2	8400	XNEX08..L
R220.79-0100-08-7A	03058321	Arbor	100,0	7	7,0	32,0	–	78,0	50,0	2,3	7500	XNEX08..L

Spare Parts, included in delivery

For cutter	Arbor screw	Insert key	Insert screw
R217.79-... Ø40	–	H4B-T15P	C04011-T15P
220.79-Ø50	220.17-896	H4B-T15P	C04011-T15P
220.79-Ø63	MC6S12X35	H4B-T15P	C04011-T15P
R220.79- Ø80-100	–	H4B-T15PL	C04011-T15P

Accessories

For cutter	Insert clamping torque	Torque key
R217/220.79-..	3.5NM	T00-15P35

Torque and fixed keys, see page 894

Square shoulder and slot milling cutters

Helical milling cutters

Face milling cutters

Disc milling cutters

High feed milling cutters

Copy milling cutters

Plunge milling cutters

Chamfer milling cutters

Spot facing cutters

Inserts

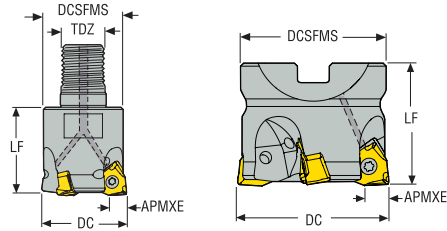

R217/220.79-08 – inch





- For insert selection and cutting data recommendations, see page(s) 759-760
- For complete insert programme, see page(s) 863
- For ISO attribute explanation, see page 16

Designation	Item number	Type of mounting	DC	ZEFP	APMXE	DCB	TDZ	DCSFMS	LF	Weight	RPMX	Insert
			inch		inch	inch		inch	inch	lbs		
R220.79-02.00-08-4A	03058348	Arbor	2.000	4	0.276	0.750	–	1.850	1.575	1.100	10600	XNEX08..L
R220.79-02.50-08-6A	03058349	Arbor	2.500	6	0.276	1.000	–	2.250	1.969	2.200	9400	XNEX08..L
R220.79-03.00-08-7A	03058350	Arbor	3.000	7	0.276	1.000	–	2.441	1.969	2.650	8400	XNEX08..L

Spare Parts, included in delivery

For cutter	Arbor screw	Insert key	Insert screw
R217.79-02.00	 220.17-698	 H4B-T15P	 C04011-T15P
R217.79-02.50-03.00	UC6S1/2UNFX1-1/4	H4B-T15P	C04011-T15P

Accessories

For cutter	Insert clamping torque	Torque key
R217.79-..	 31.0IN.LBS	 T00-15P35

Torque and fixed keys, see page 894

R217/220.79-08 – Insert selection – mm/Inch

SMG		f _z	a _{so}			
			100%	70%	50%	30%
P1	XNEX080608TL-M13 MP2501	0,18 0,0070	5,0 0,20	5,0 0,20	5,0 0,20	6,0 0,24
P2	XNEX080608TL-M13 MP2501	0,19 0,0075	5,0 0,20	5,0 0,20	5,0 0,20	6,0 0,24
P3	XNEX080608TL-M13 MP2501	0,18 0,0070	5,0 0,20	5,0 0,20	5,0 0,20	6,0 0,24
P4	XNEX080608TL-M13 MP2501	0,17 0,0065	5,0 0,20	5,0 0,20	5,0 0,20	6,0 0,24
P5	XNEX080608TL-M13 MP2501	0,17 0,0065	5,0 0,20	5,0 0,20	5,0 0,20	6,0 0,24
P6	XNEX080608TL-M13 MP2501	0,17 0,0065	5,0 0,20	5,0 0,20	5,0 0,20	6,0 0,24
P7	XNEX080608TL-M13 MP2501	0,17 0,0065	5,0 0,20	5,0 0,20	5,0 0,20	6,0 0,24
P8	XNEX080608TL-M13 MP2501	0,18 0,0070	5,0 0,20	5,0 0,20	5,0 0,20	6,0 0,24
P11	XNEX080608TL-M13 T350M	0,17 0,0065	5,0 0,20	5,0 0,20	5,0 0,20	6,0 0,24
P12	XNEX080608TL-M13 T350M	0,11 0,0044	4,0 0,16	4,0 0,16	4,0 0,16	4,5 0,18
M1	XNEX080608TL-M13 F40M	0,19 0,0075	5,0 0,20	5,0 0,20	5,0 0,20	6,0 0,24
M2	XNEX080608TL-M13 F40M	0,17 0,0065	5,0 0,20	5,0 0,20	5,0 0,20	6,0 0,24
M3	XNEX080608TL-M13 F40M	0,14 0,0055	4,0 0,16	4,0 0,16	4,0 0,16	4,5 0,18
M4	XNEX080608TL-M13 T350M	0,12 0,0048	3,0 0,12	3,0 0,12	3,0 0,12	3,5 0,14
M5	XNEX080608TL-M13 T350M	0,12 0,0048	3,0 0,12	3,0 0,12	3,0 0,12	3,5 0,14
K1	XNEX080608TL-M13 MP2501	0,19 0,0075	5,0 0,20	5,0 0,20	5,0 0,20	6,0 0,24
K2	XNEX080608TL-M13 MP2501	0,17 0,0065	5,0 0,20	5,0 0,20	5,0 0,20	6,0 0,24
K3	XNEX080608TL-M13 MP2501	0,17 0,0065	5,0 0,20	5,0 0,20	5,0 0,20	6,0 0,24
K4	XNEX080608TL-M13 MP2501	0,17 0,0065	5,0 0,20	5,0 0,20	5,0 0,20	6,0 0,24
K5	XNEX080608TL-M13 MP2501	0,15 0,0060	5,0 0,20	5,0 0,20	5,0 0,20	6,0 0,24
K6	XNEX080608TL-M13 MP2501	0,17 0,0065	5,0 0,20	5,0 0,20	5,0 0,20	6,0 0,24
K7	XNEX080608TL-M13 MP2501	0,15 0,0060	5,0 0,20	5,0 0,20	5,0 0,20	6,0 0,24
S1	XNEX080608TL-M13 T350M	0,12 0,0048	3,0 0,12	3,0 0,12	3,0 0,12	3,5 0,14
S2	XNEX080608TL-M13 T350M	0,12 0,0048	3,0 0,12	3,0 0,12	3,0 0,12	3,5 0,14
S3	XNEX080608TL-M13 T350M	0,11 0,0044	3,0 0,12	3,0 0,12	3,0 0,12	3,5 0,14
S11	XNEX080608TL-M13 MS2050	0,14 0,0055	3,5 0,14	3,5 0,14	3,5 0,14	4,0 0,16
S12	XNEX080608TL-M13 MS2050	0,14 0,0055	3,5 0,14	3,5 0,14	3,5 0,14	4,0 0,16
S13	XNEX080608TL-M13 MS2050	0,12 0,0048	3,0 0,12	3,0 0,12	3,0 0,12	3,5 0,14
H5	XNEX080608TL-M13 T350M	0,11 0,0044	4,0 0,16	4,0 0,16	4,0 0,16	4,5 0,18
H8	XNEX080608TL-M13 T350M	0,090 0,0036	3,5 0,14	3,5 0,14	3,5 0,14	4,0 0,16
H11	XNEX080608TL-M13 T350M	0,11 0,0044	4,0 0,16	4,0 0,16	4,0 0,16	4,5 0,18
H12	XNEX080608TL-M13 T350M	0,090 0,0036	3,5 0,14	3,5 0,14	3,5 0,14	4,0 0,16

SMG = Seco material group
f_z = mm/tooth (in/tooth), v_c = m/min (sf/min), a_g/DC = %
All cutting data are start values

Square shoulder and slot milling cutters
Helical milling cutters
Face milling cutters
Disc milling cutters
High feed milling cutters
Copy milling cutters
Plunge milling cutters
Chamfer milling cutters
Spot facing cutters
Inserts

R217/220.79-08 – Cutting data $v_c = (m/min)/(sf/min)$

SMG	MP2501				F40M				T350M				MS2050			
	100%	70%	50%	30%	100%	70%	50%	30%	100%	70%	50%	30%	100%	70%	50%	30%
P1	225	250	265	285	170	190	200	215	195	220	230	250	190	210	220	240
	740	820	870	940	560	620	660	710	640	720	750	820	620	690	720	790
P2	215	240	255	275	165	180	195	205	190	210	220	235	180	200	210	225
	710	790	840	900	540	590	640	670	620	690	720	770	590	660	690	740
P3	190	210	225	240	145	160	170	180	165	185	195	210	155	175	185	200
	620	690	740	790	475	520	560	590	540	610	640	690	510	570	610	660
P4	170	190	200	215	130	145	150	160	150	165	175	185	140	160	165	180
	560	620	660	710	425	475	490	520	490	540	570	610	460	520	540	590
P5	160	180	190	205	125	135	145	155	140	155	165	180	135	150	160	170
	520	590	620	670	410	445	475	510	460	510	540	590	445	490	520	560
P6	180	205	215	230	140	155	165	175	160	175	185	200	150	170	180	190
	590	670	710	750	460	510	540	570	520	570	610	660	490	560	590	620
P7	170	190	205	215	130	145	155	165	150	165	175	190	145	160	170	180
	560	620	670	710	425	475	510	540	490	540	570	620	475	520	560	590
P8	160	175	190	200	120	135	140	150	140	155	165	175	130	150	155	165
	520	570	620	660	395	445	460	490	460	510	540	570	425	490	510	540
P11	165	185	195	210	125	140	150	160	145	160	170	185	140	155	165	175
	540	610	640	690	410	460	490	520	475	520	560	610	460	510	540	570
P12	115	125	135	145	85	95	100	110	100	110	115	125	95	105	110	120
	375	410	445	475	280	310	330	360	330	360	375	410	310	345	360	395
M1	155	175	185	195	130	145	155	165	145	160	170	185	145	160	170	185
	510	570	610	640	425	475	510	540	475	520	560	610	475	520	560	610
M2	130	145	155	165	110	125	130	140	120	135	145	155	120	135	145	155
	425	475	510	540	360	410	425	460	395	445	475	510	395	445	475	510
M3	105	120	125	135	90	100	105	115	100	110	115	125	100	110	115	125
	345	395	410	445	295	330	345	375	330	360	375	410	330	360	375	410
M4	85	95	100	105	70	80	85	90	80	90	95	100	80	90	95	100
	280	310	330	345	230	260	280	295	260	295	310	330	260	295	310	330
M5	70	80	85	90	60	65	70	75	65	75	75	85	65	75	75	85
	230	260	280	295	195	215	230	245	215	245	245	280	215	245	245	280
K1	170	190	200	215	130	145	155	165	150	165	175	190	—	—	—	—
	560	620	660	710	425	475	510	540	490	540	570	620	—	—	—	—
K2	155	170	180	195	115	130	135	145	135	150	160	170	—	—	—	—
	510	560	590	640	375	425	445	475	445	490	520	560	—	—	—	—
K3	130	145	155	165	100	110	115	125	115	125	135	145	—	—	—	—
	425	475	510	540	330	360	375	410	375	410	445	475	—	—	—	—
K4	125	140	145	155	95	105	110	120	110	120	130	135	—	—	—	—
	410	460	475	510	310	345	360	395	360	395	425	445	—	—	—	—
K5	75	85	90	95	60	65	70	75	65	75	80	85	—	—	—	—
	245	280	295	310	195	215	230	245	215	245	260	280	—	—	—	—
K6	110	120	130	140	85	90	100	105	95	105	110	120	—	—	—	—
	360	395	425	460	280	295	330	345	310	345	360	395	—	—	—	—
K7	100	110	115	125	75	85	90	95	85	95	100	110	—	—	—	—
	330	360	375	410	245	280	295	310	280	310	330	360	—	—	—	—
S1	41	46	48	50	33	37	39	42	37	41	43	47	37	41	43	47
	135	150	155	165	110	120	130	140	120	135	140	155	120	135	140	155
S2	33	37	39	42	27	30	32	34	29	33	35	38	29	33	35	38
	110	120	130	140	90	100	105	110	95	110	115	125	95	110	115	125
S3	29	33	35	37	24	26	28	30	26	29	31	33	26	29	31	33
	95	110	115	120	80	85	90	100	85	95	100	110	85	95	100	110
S11	55	65	65	70	46	50	55	60	50	55	60	65	50	55	60	65
	180	215	215	230	150	165	180	195	165	180	195	215	165	180	195	215
S12	39	43	46	49	32	35	37	40	35	39	41	44	35	39	41	44
	130	140	150	160	105	115	120	130	115	130	135	145	115	130	135	145
S13	23	26	27	29	19	21	22	24	21	23	24	26	21	23	24	26
	75	85	90	95	60	70	70	80	70	75	80	85	70	75	80	85
H5	34	38	40	43	29	32	34	36	33	37	39	42	—	—	—	—
	110	125	130	140	95	105	110	120	110	120	130	140	—	—	—	—
H8	36	41	43	46	30	34	36	39	35	39	41	44	—	—	—	—
	120	135	140	150	100	110	120	130	115	130	135	145	—	—	—	—
H11	44	49	50	55	36	41	43	46	42	47	49	55	—	—	—	—
	145	160	165	180	120	135	140	150	140	155	160	180	—	—	—	—
H12	70	80	85	90	55	60	65	70	65	70	75	80	—	—	—	—
	230	260	280	295	180	195	215	230	215	230	245	260	—	—	—	—



TURBO PLUNGE MILL

Turbo Plunge mills can be used for both up-copying and down-copying in an axial feed direction, such as in deep cavities for mold tools. All cutters in this family incorporate internal coolant to optimize chip evacuation.

- Insert size 06, cutter range 12-16 mm
- Insert size 10, cutter range 20-32 mm (0.75 - 1 inch)
- Insert size 12, cutter range 25-63 mm (1 inch)

R217/220.79-06 – Metric

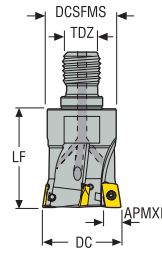

- For insert selection and cutting data recommendations, see page(s) 763-764
- For complete insert programme, see page(s) 866
- For ISO attribute explanation, see page 16

Designation	Item number	Type of mounting	DC	ZEFP	APMXE	TDZ	DCSFMS	LF	Weight	RPMX	Insert
			mm		mm		mm	mm	kg		
R217.79-0612.RE-06.3AN	02705857	Combimaster	12,0	3	3,0	M6	11,0	18,0	0,1	32000	XO..06
R217.79-0816.RE-06.3AN	02705859	Combimaster	16,0	3	3,0	M8	13,5	20,0	0,1	28000	XO..06

Spare Parts, included in delivery

For cutter	Insert key	Insert screw
R217.79-..	H4B-T06P	C01804-T06P

Accessories

For cutter	Insert clamping torque	Torque key
R217.79-..	0.5NM	T00-06P05

Torque and fixed keys, see page 894

Square shoulder and slot milling cutters
Helical milling cutters
Face milling cutters
Disc milling cutters
High feed milling cutters
Copy milling cutters
Plunge milling cutters
Chamfer milling cutters
Spot facing cutters
Inserts

R217.79-06 – Insert selection – mm/Inch

SMG		f _z	a _{so}			
			100%	70%	50%	30%
P1	XOMX060204R-M05 F40M	0,070	2,0	2,0	2,0	2,5
		0,0028	0,080	0,080	0,080	0,10
P2	XOMX060204R-M05 F40M	0,070	2,0	2,0	2,0	2,5
		0,0028	0,080	0,080	0,080	0,10
P3	XOMX060204R-M05 F40M	0,070	2,0	2,0	2,0	2,5
		0,0028	0,080	0,080	0,080	0,10
P4	XOMX060204R-M05 F40M	0,065	2,0	2,0	2,0	2,5
		0,0026	0,080	0,080	0,080	0,10
P5	XOMX060204R-M05 F40M	0,065	2,0	2,0	2,0	2,5
		0,0026	0,080	0,080	0,080	0,10
P6	XOMX060204R-M05 F40M	0,065	2,0	2,0	2,0	2,5
		0,0026	0,080	0,080	0,080	0,10
P7	XOMX060204R-M05 F40M	0,065	2,0	2,0	2,0	2,5
		0,0026	0,080	0,080	0,080	0,10
P8	XOMX060204R-M05 MP3000	0,070	2,0	2,0	2,0	2,5
		0,0028	0,080	0,080	0,080	0,10
P11	XOMX060204R-M05 F40M	0,065	2,0	2,0	2,0	2,5
		0,0026	0,080	0,080	0,080	0,10
P12	XOMX060204R-M05 F40M	0,044	1,7	1,7	1,7	2,0
		0,0017	0,065	0,065	0,065	0,080
M1	XOMX060204R-M05 F40M	0,070	2,0	2,0	2,0	2,5
		0,0028	0,080	0,080	0,080	0,10
M2	XOMX060204R-M05 F40M	0,065	2,0	2,0	2,0	2,5
		0,0026	0,080	0,080	0,080	0,10
M3	XOMX060204R-M05 F40M	0,050	1,7	1,7	1,7	2,0
		0,0020	0,065	0,065	0,065	0,080
M4	XOMX060204R-M05 F40M	0,046	1,3	1,3	1,3	1,4
		0,0018	0,050	0,050	0,050	0,055
M5	XOMX060204R-M05 F40M	0,046	1,3	1,3	1,3	1,4
		0,0018	0,050	0,050	0,050	0,055
K1	XOMX060204R-M05 MP3000	0,070	2,0	2,0	2,0	2,5
		0,0028	0,080	0,080	0,080	0,10
K2	XOMX060204R-M05 MP3000	0,065	2,0	2,0	2,0	2,5
		0,0026	0,080	0,080	0,080	0,10
K3	XOMX060204R-M05 MP3000	0,065	2,0	2,0	2,0	2,5
		0,0026	0,080	0,080	0,080	0,10
K4	XOMX060204R-M05 MP3000	0,065	2,0	2,0	2,0	2,5
		0,0026	0,080	0,080	0,080	0,10
K5	XOMX060204R-M05 MP3000	0,060	2,0	2,0	2,0	2,5
		0,0024	0,080	0,080	0,080	0,10
K6	XOMX060204R-M05 MP3000	0,065	2,0	2,0	2,0	2,5
		0,0026	0,080	0,080	0,080	0,10
K7	XOMX060204R-M05 MP3000	0,060	2,0	2,0	2,0	2,5
		0,0024	0,080	0,080	0,080	0,10
N1	XOEX060204FR-E03 H15	0,075	2,0	2,0	2,0	2,5
		0,0030	0,080	0,080	0,080	0,10
N2	XOEX060204FR-E03 F40M	0,075	2,0	2,0	2,0	2,5
		0,0030	0,080	0,080	0,080	0,10
N3	XOEX060204FR-E03 F40M	0,075	2,0	2,0	2,0	2,5
		0,0030	0,080	0,080	0,080	0,10
N11	XOEX060204FR-E03 H15	0,075	2,0	2,0	2,0	2,5
		0,0030	0,080	0,080	0,080	0,10
S1	XOMX060204R-M05 F40M	0,046	1,3	1,3	1,3	1,4
		0,0018	0,050	0,050	0,050	0,055
S2	XOMX060204R-M05 F40M	0,046	1,3	1,3	1,3	1,4
		0,0018	0,050	0,050	0,050	0,055
S3	XOMX060204R-M05 F40M	0,042	1,3	1,3	1,3	1,4
		0,0017	0,050	0,050	0,050	0,055
S11	XOMX060204R-M05 F40M	0,050	1,5	1,5	1,5	1,7
		0,0020	0,060	0,060	0,060	0,065
S12	XOMX060204R-M05 F40M	0,050	1,5	1,5	1,5	1,7
		0,0020	0,060	0,060	0,060	0,065
S13	XOMX060204R-M05 F40M	0,046	1,3	1,3	1,3	1,4
		0,0018	0,050	0,050	0,050	0,055
H5	XOMX060204R-M05 MP3000	0,044	1,7	1,7	1,7	2,0
		0,0017	0,065	0,065	0,065	0,080
H8	XOMX060204R-M05 MP3000	0,034	1,5	1,5	1,5	1,7
		0,0013	0,060	0,060	0,060	0,065
H11	XOMX060204R-M05 MP3000	0,044	1,7	1,7	1,7	2,0
		0,0017	0,065	0,065	0,065	0,080
H12	XOMX060204R-M05 MP3000	0,034	1,5	1,5	1,5	1,7
		0,0013	0,060	0,060	0,060	0,065
H21	XOMX060204R-M05 MP3000	0,034	1,5	1,5	1,5	1,7
		0,0013	0,060	0,060	0,060	0,065

SMG = Seco material group
f_z = mm/tooth (in/tooth), v_c = m/min (sf/min), a_p/DC = %
All cutting data are start values

Square shoulder and slot milling cutters
Helical milling cutters
Face milling cutters
Disc milling cutters
High feed milling cutters
Copy milling cutters
Plunge milling cutters
Chamfer milling cutters
Spot facing cutters
Inserts

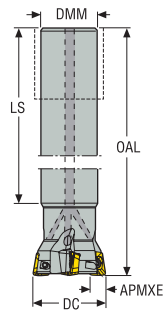

R217.79-10 – Metric





- For insert selection and cutting data recommendations, see page(s) 769-771
- For complete insert programme, see page(s) 867, 868
- For ISO attribute explanation, see page 16

Designation	Item number	Type of mounting	DC	ZEFP	APMXE	DMM	LS	OAL	RPMX	Weight	Insert
			mm		mm	mm	mm	mm		kg	
R217.79-1820.0-10-2A	02842051	Cylindrical	20,0	2	6,0	18,0	130,0	160,0	29000	0,3	XO.X10T3
R217.79-2025.0-10-3A	02842052	Cylindrical	25,0	3	6,0	20,0	170,0	200,0	26000	0,6	XO.X10T3
R217.79-2532.0-10-4A	02842053	Cylindrical	32,0	4	6,0	25,0	218,0	250,0	22900	1,3	XO.X10T3

Spare Parts, included in delivery

For cutter	Insert key	Insert screw
		
R217.79-..	H4B-T07P	C02506-T07P

Accessories

For cutter	Insert clamping torque	Torque key
		
R217.79-..	0.9NM	T00-07P09

Torque and fixed keys, see page 894

Square shoulder and slot milling cutters

Helical milling cutters

Face milling cutters

Disc milling cutters

High feed milling cutters

Copy milling cutters

Plunge milling cutters

Chamfer milling cutters

Spot facing cutters

Inserts

R217.79-10 – inch

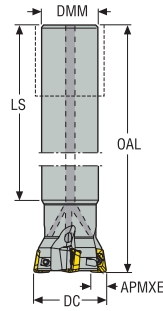

- For insert selection and cutting data recommendations, see page(s) 769-771
- For complete insert programme, see page(s) 867, 868
- For ISO attribute explanation, see page 16

Designation	Item number	Type of mounting	DC	ZEFP	APMXE	DMM	LS	OAL	RPMX	Weight	Insert
			inch		inch	inch	inch	inch		lbs	
R217.79-00.75-0-10-2A	02844106	Cylindrical	0.750	2	0.236	0.625	5.118	6.299	29000	0.440	XO.X10T3
R217.79-01.00-0-10-3A	02844107	Cylindrical	1.000	3	0.236	0.750	6.693	7.874	15000	0.880	XO.X10T3

Spare Parts, included in delivery

For cutter	Insert key	Insert screw
R217.79-..	H4B-T07P	C02506-T07P

Accessories

For cutter	Insert clamping torque	Torque key
R217.79-..	8.0IN.LBS	T00-07P09

Torque and fixed keys, see page 894

Square shoulder and slot milling cutters
Helical milling cutters
Face milling cutters
Disc milling cutters
High feed milling cutters
Copy milling cutters
Plunge milling cutters
Chamfer milling cutters
Spot facing cutters
Inserts

R217.79-10 – Metric

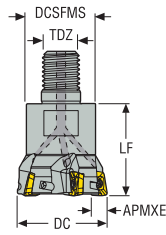



- For insert selection and cutting data recommendations, see page(s) 769-771
- For complete insert programme, see page(s) 867, 868
- For ISO attribute explanation, see page 16



Designation	Item number	Type of mounting	DC	ZEFP	APMXE	TDZ	DCSFMS	LF	Weight	RPMX	Insert
			mm		mm		mm	mm	kg		
R217.79-1020.RE-10-2A	02842054	Combimaster	20,0	2	6,0	M10	18,0	28,0	0,1	29000	XO.X10T3
R217.79-1225.RE-10-3A	02842056	Combimaster	25,0	3	6,0	M12	22,5	30,0	0,1	26000	XO.X10T3
R217.79-1632.RE-10-4A	02842057	Combimaster	32,0	4	6,0	M16	29,0	40,0	0,2	22900	XO.X10T3
R217.79-1640.RE-10-5A	02842058	Combimaster	40,0	5	6,0	M16	30,0	40,0	0,3	15000	XO.X10T3

For Combimaster Shanks, see Machining Navigator Tooling System

Spare Parts, included in delivery

For cutter	Insert key	Insert screw
		
R217.79-..	H4B-T07P	C02506-T07P

Accessories

For cutter	Insert clamping torque	Torque key
		
R217.79-..	0.9NM	T00-07P09

Torque and fixed keys, see page 894

Square shoulder and slot milling cutters

Helical milling cutters

Face milling cutters

Disc milling cutters

High feed milling cutters

Copy milling cutters

Plunge milling cutters

Chamfer milling cutters

Spot facing cutters

Inserts

R217.79-10 – inch

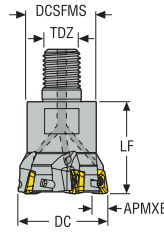

- For insert selection and cutting data recommendations, see page(s) 769-771
- For complete insert programme, see page(s) 867, 868
- For ISO attribute explanation, see page 16

Designation	Item number	Type of mounting	DC	ZEFP	APMXE	TDZ	DCSFMS	LF	Weight	RPMX	Insert
			inch		inch		inch	inch	lbs		
R217.79-1.00-12RE-10.3A	02844109	Combimaster	1.000	3	0.236	M12	0.886	1.181	0.220	15000	XO.X10T3

For Combimaster Shanks, see Machining Navigator Tooling System

Spare Parts, included in delivery

For cutter	Insert key	Insert screw
R217.79-..	H4B-T07P	C02506-T07P

Accessories

For cutter	Insert clamping torque	Torque key
R217.79-..	8.0IN.LBS	T00-07P09

Torque and fixed keys, see page 894

Square shoulder and slot milling cutters
Helical milling cutters
Face milling cutters
Disc milling cutters
High feed milling cutters
Copy milling cutters
Plunge milling cutters
Chamfer milling cutters
Spot facing cutters
Inserts

R217/220.79-10 – Insert selection – mm/Inch

SMG		f _z	a _{so}			
			100%	70%	50%	30%
P1	XOMX10T308TR-ME07 MP2501	0,10 0,0040	4,0 0,16	4,0 0,16	4,0 0,16	5,0 0,20
P2	XOMX10T308TR-ME07 MP2501	0,10 0,0040	4,0 0,16	4,0 0,16	4,0 0,16	5,0 0,20
P3	XOMX10T308TR-ME07 MP2501	0,095 0,0038	4,0 0,16	4,0 0,16	4,0 0,16	5,0 0,20
P4	XOMX10T308TR-ME07 MP2501	0,095 0,0038	4,0 0,16	4,0 0,16	4,0 0,16	5,0 0,20
P5	XOMX10T308TR-ME07 MP2501	0,090 0,0036	4,0 0,16	4,0 0,16	4,0 0,16	5,0 0,20
P6	XOMX10T308TR-ME07 MP2501	0,090 0,0036	4,0 0,16	4,0 0,16	4,0 0,16	5,0 0,20
P7	XOMX10T308TR-M09 MP2501	0,12 0,0048	4,0 0,16	4,0 0,16	4,0 0,16	5,0 0,20
P8	XOMX10T308TR-M09 MP2501	0,12 0,0048	4,0 0,16	4,0 0,16	4,0 0,16	5,0 0,20
P11	XOMX10T308TR-M09 MP2501	0,12 0,0048	4,0 0,16	4,0 0,16	4,0 0,16	5,0 0,20
P12	XOMX10T308TR-M09 MP2501	0,080 0,0032	3,5 0,14	3,5 0,14	3,5 0,14	4,0 0,16
M1	XOMX10T308TR-ME07 F40M	0,10 0,0040	4,0 0,16	4,0 0,16	4,0 0,16	5,0 0,20
M2	XOMX10T308TR-ME07 F40M	0,090 0,0036	4,0 0,16	4,0 0,16	4,0 0,16	5,0 0,20
M3	XOMX10T308TR-ME07 F40M	0,075 0,0030	3,5 0,14	3,5 0,14	3,5 0,14	4,0 0,16
M4	XOMX10T308TR-M09 F40M	0,080 0,0032	2,5 0,10	2,5 0,10	2,5 0,10	3,0 0,12
M5	XOMX10T308TR-M09 F40M	0,080 0,0032	2,5 0,10	2,5 0,10	2,5 0,10	3,0 0,12
K1	XOMX10T308TR-M09 MK1500	0,13 0,0050	4,0 0,16	4,0 0,16	4,0 0,16	5,0 0,20
K2	XOMX10T308TR-M09 MK1500	0,12 0,0048	4,0 0,16	4,0 0,16	4,0 0,16	5,0 0,20
K3	XOMX10T308TR-M09 MK1500	0,12 0,0048	4,0 0,16	4,0 0,16	4,0 0,16	5,0 0,20
K4	XOMX10T308TR-M09 MK1500	0,12 0,0048	4,0 0,16	4,0 0,16	4,0 0,16	5,0 0,20
K5	XOMX10T308TR-M09 MK1500	0,11 0,0044	4,0 0,16	4,0 0,16	4,0 0,16	5,0 0,20
K6	XOMX10T308TR-M09 MK1500	0,12 0,0048	4,0 0,16	4,0 0,16	4,0 0,16	5,0 0,20
K7	XOMX10T308TR-M09 MP1500	0,11 0,0044	4,0 0,16	4,0 0,16	4,0 0,16	5,0 0,20
N1	XOEX10T308FR-E05 H15	0,090 0,0036	4,0 0,16	4,0 0,16	4,0 0,16	5,0 0,20
N2	XOEX10T308FR-E05 H15	0,090 0,0036	4,0 0,16	4,0 0,16	4,0 0,16	5,0 0,20
N3	XOEX10T308FR-E05 H15	0,090 0,0036	4,0 0,16	4,0 0,16	4,0 0,16	5,0 0,20
N11	XOEX10T308FR-E05 H15	0,090 0,0036	4,0 0,16	4,0 0,16	4,0 0,16	5,0 0,20
S1	XOMX10T308TR-ME07 T350M	0,065 0,0026	2,5 0,10	2,5 0,10	2,5 0,10	3,0 0,12
S2	XOMX10T308TR-ME07 T350M	0,065 0,0026	2,5 0,10	2,5 0,10	2,5 0,10	3,0 0,12
S3	XOMX10T308TR-M09 T350M	0,075 0,0030	2,5 0,10	2,5 0,10	2,5 0,10	3,0 0,12
S11	XOMX10T308TR-ME07 MS2050	0,075 0,0030	3,0 0,12	3,0 0,12	3,0 0,12	3,5 0,14
S12	XOMX10T308TR-ME07 MS2050	0,075 0,0030	3,0 0,12	3,0 0,12	3,0 0,12	3,5 0,14
S13	XOMX10T308TR-ME07 MS2050	0,065 0,0026	2,5 0,10	2,5 0,10	2,5 0,10	3,0 0,12
H5	XOMX10T308TR-M09 MP1501	0,080 0,0032	3,5 0,14	3,5 0,14	3,5 0,14	4,0 0,16
H8	XOMX10T308TR-M09 MP1501	0,060 0,0024	3,0 0,12	3,0 0,12	3,0 0,12	3,5 0,14
H11	XOMX10T308TR-M09 T350M	0,080 0,0032	3,5 0,14	3,5 0,14	3,5 0,14	4,0 0,16
H12	XOMX10T308TR-M09 T350M	0,060 0,0024	3,0 0,12	3,0 0,12	3,0 0,12	3,5 0,14
H21	XOMX10T308TR-M09 MP1501	0,060 0,0024	3,0 0,12	3,0 0,12	3,0 0,12	3,5 0,14

SMG = Seco material group
f_z = mm/tooth (in/tooth), v_c = m/min (sf/min), a_p/DC = %
All cutting data are start values

Square shoulder and slot milling cutters
Helical milling cutters
Face milling cutters
Disc milling cutters
High feed milling cutters
Copy milling cutters
Plunge milling cutters
Chamfer milling cutters
Spot facing cutters
Inserts

R217/220.79-10 – Cutting data $v_c = (m/min)/(sf/min)$

SMG	MK1500				MK2050				MS2050				MS2500				H15			
	100%	70%	50%	30%	100%	70%	50%	30%	100%	70%	50%	30%	100%	70%	50%	30%	100%	70%	50%	30%
P1	—	—	—	—	240	265	280	300	235	265	280	295	265	295	315	335	—	—	—	—
	—	—	—	—	790	870	920	980	770	870	920	970	870	970	1025	1100	—	—	—	—
P2	—	—	—	—	235	260	275	290	230	255	270	285	260	290	305	325	—	—	—	—
	—	—	—	—	770	850	900	950	750	840	890	940	850	950	1000	1075	—	—	—	—
P3	—	—	—	—	205	230	245	260	200	225	235	250	230	255	270	285	—	—	—	—
	—	—	—	—	670	750	800	850	660	740	770	820	750	840	890	940	—	—	—	—
P4	—	—	—	—	180	200	215	225	175	195	210	220	200	225	235	250	—	—	—	—
	—	—	—	—	590	660	710	740	570	640	690	720	660	740	770	820	—	—	—	—
P5	—	—	—	—	175	195	205	215	170	190	200	215	190	215	225	240	—	—	—	—
	—	—	—	—	570	640	670	710	560	620	660	710	620	710	740	790	—	—	—	—
P6	—	—	—	—	195	215	230	245	190	215	225	240	215	240	255	270	—	—	—	—
	—	—	—	—	640	710	750	800	620	710	740	790	710	790	840	890	—	—	—	—
P7	—	—	—	—	185	205	215	230	180	200	215	225	205	225	240	255	—	—	—	—
	—	—	—	—	610	670	710	750	590	660	710	740	670	740	790	840	—	—	—	—
P8	—	—	—	—	175	195	205	215	170	190	200	210	190	215	225	240	—	—	—	—
	—	—	—	—	570	640	670	710	560	620	660	690	620	710	740	790	—	—	—	—
P11	—	—	—	—	180	200	210	225	175	195	205	220	200	220	230	245	—	—	—	—
	—	—	—	—	590	660	690	740	570	640	670	720	660	720	750	800	—	—	—	—
P12	—	—	—	—	120	130	140	150	115	130	135	145	130	145	155	165	—	—	—	—
	—	—	—	—	395	425	460	490	375	425	445	475	425	475	510	540	—	—	—	—
M1	—	—	—	—	—	—	—	—	185	205	220	230	185	205	220	230	—	—	—	—
	—	—	—	—	—	—	—	—	610	670	720	750	610	670	720	750	—	—	—	—
M2	—	—	—	—	—	—	—	—	155	170	180	195	155	170	180	190	—	—	—	—
	—	—	—	—	—	—	—	—	510	560	590	640	510	560	590	620	—	—	—	—
M3	—	—	—	—	—	—	—	—	125	140	145	155	125	140	150	160	—	—	—	—
	—	—	—	—	—	—	—	—	410	460	475	510	410	460	490	520	—	—	—	—
M4	—	—	—	—	—	—	—	—	95	110	115	125	100	110	120	125	—	—	—	—
	—	—	—	—	—	—	—	—	310	360	375	410	330	360	395	410	—	—	—	—
M5	—	—	—	—	—	—	—	—	80	90	95	100	85	95	100	105	—	—	—	—
	—	—	—	—	—	—	—	—	260	295	310	330	280	310	330	345	—	—	—	—
K1	265	295	315	335	250	280	295	315	—	—	—	—	—	—	—	—	—	—	—	—
	870	970	1025	1100	820	920	970	1025	—	—	—	—	—	—	—	—	—	—	—	—
K2	235	265	280	295	225	250	265	280	—	—	—	—	—	—	—	—	—	—	—	—
	770	870	920	970	740	820	870	920	—	—	—	—	—	—	—	—	—	—	—	—
K3	200	225	235	250	190	210	225	235	—	—	—	—	—	—	—	—	—	—	—	—
	660	740	770	820	620	690	740	770	—	—	—	—	—	—	—	—	—	—	—	—
K4	190	215	225	240	180	200	215	225	—	—	—	—	—	—	—	—	—	—	—	—
	620	710	740	790	590	660	710	740	—	—	—	—	—	—	—	—	—	—	—	—
K5	115	130	135	145	110	125	130	140	—	—	—	—	—	—	—	—	—	—	—	—
	375	425	445	475	360	410	425	460	—	—	—	—	—	—	—	—	—	—	—	—
K6	170	185	200	210	160	175	190	200	—	—	—	—	—	—	—	—	—	—	—	—
	560	610	660	690	520	570	620	660	—	—	—	—	—	—	—	—	—	—	—	—
K7	150	165	175	185	140	160	165	175	—	—	—	—	—	—	—	—	—	—	—	—
	490	540	570	610	460	520	540	570	—	—	—	—	—	—	—	—	—	—	—	—
N1	—	—	—	—	—	—	—	—	—	—	—	—	—	—	—	—	1300	1450	1525	1625
	—	—	—	—	—	—	—	—	—	—	—	—	—	—	—	—	4275	4750	5000	5325
N2	—	—	—	—	—	—	—	—	—	—	—	—	—	—	—	—	520	580	610	650
	—	—	—	—	—	—	—	—	—	—	—	—	—	—	—	—	1700	1900	2000	2125
N3	—	—	—	—	—	—	—	—	—	—	—	—	—	—	—	—	350	390	410	435
	—	—	—	—	—	—	—	—	—	—	—	—	—	—	—	—	1150	1275	1350	1425
N11	—	—	—	—	—	—	—	—	—	—	—	—	—	—	—	—	400	445	470	495
	—	—	—	—	—	—	—	—	—	—	—	—	—	—	—	—	1300	1450	1550	1625
S1	—	—	—	—	—	—	—	—	45	50	55	55	49	55	60	60	—	—	—	—
	—	—	—	—	—	—	—	—	150	165	180	180	160	180	195	195	—	—	—	—
S2	—	—	—	—	—	—	—	—	37	41	43	46	39	44	46	50	—	—	—	—
	—	—	—	—	—	—	—	—	120	135	140	150	130	145	150	165	—	—	—	—
S3	—	—	—	—	—	—	—	—	32	36	38	41	34	38	41	44	—	—	—	—
	—	—	—	—	—	—	—	—	105	120	125	135	110	125	135	145	—	—	—	—
S11	—	—	—	—	—	—	—	—	65	70	75	80	65	75	80	85	—	—	—	—
	—	—	—	—	—	—	—	—	215	230	245	260	215	245	260	280	—	—	—	—
S12	—	—	—	—	—	—	—	—	44	49	50	55	46	50	55	60	—	—	—	—
	—	—	—	—	—	—	—	—	145	160	165	180	150	165	180	195	—	—	—	—
S13	—	—	—	—	—	—	—	—	26	28	30	32	27	31	32	35	—	—	—	—
	—	—	—	—	—	—	—	—	85	90	100	105	90	100	105	115	—	—	—	—
H5	—	—	—	—	—	—	—	—	—	—	—	—	—	—	—	—	—	—	—	—
H8	—	—	—	—	—	—	—	—	—	—	—	—	—	—	—	—	—	—	—	—
H11	—	—	—	—	—	—	—	—	—	—	—	—	—	—	—	—	—	—	—	—
H12	—	—	—	—	—	—	—	—	—	—	—	—	—	—	—	—	—	—	—	—
H21	—	—	—	—	—	—	—	—	—	—	—	—	—	—	—	—	—	—	—	—

Square shoulder and slot milling cutters
Helical milling cutters
Face milling cutters
Disc milling cutters
High feed milling cutters
Copy milling cutters
Plunge milling cutters
Chamfer milling cutters
Spot facing cutters
Inserts

R217.79-XO12 – Metric

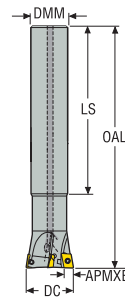

- For insert selection and cutting data recommendations, see page(s) 775-777
- For complete insert programme, see page(s) 869, 870
- For ISO attribute explanation, see page 16

Designation	Item number	Type of mounting	DC	ZEFP	APMXE	DMM	LS	OAL	RPMX	Weight	Insert
			mm		mm	mm	mm	mm		kg	
R217.79-2025.0-XO12-2AN	02732332	Cylindrical	25,0	2	7,0	20,0	170,0	200,0	20800	0,5	XO..1204
R217.79-2532.0-XO12-3AN	02732333	Cylindrical	32,0	3	7,0	25,0	215,0	250,0	18400	0,9	XO..1204

Spare Parts, included in delivery

For cutter	Insert key	Insert screw
R217.79-..	H4B-T10P	C03507-T10P

Accessories

For cutter	Insert clamping torque	Torque key
R217.79-..	3.0NM	T00-10P30

Torque and fixed keys, see page 894

Square shoulder and slot milling cutters
Helical milling cutters
Face milling cutters
Disc milling cutters
High feed milling cutters
Copy milling cutters
Plunge milling cutters
Chamfer milling cutters
Spot facing cutters
Inserts

R217.79-XO12 – inch

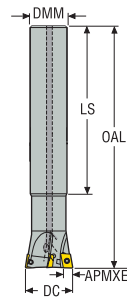

- For insert selection and cutting data recommendations, see page(s) 775-777
- For complete insert programme, see page(s) 869, 870
- For ISO attribute explanation, see page 16

Designation	Item number	Type of mounting	DC	ZEFP	APMXE	DMM	LS	OAL	RPMX	Weight	Insert
			inch		inch	inch	inch	inch		lbs	
R217.79-1.00.3-XO.2A	00097192	Weldon	1.000	2	0.276	0.750	6.693	7.874	20800	1.100	XO..1204

Spare Parts, included in delivery

For cutter	Insert key	Insert screw
R217.79-..	H4B-T10P	C03507-T10P

Accessories

For cutter	Insert clamping torque	Torque key
R217.79-..	26.6IN.LBS	T00-10P30

Torque and fixed keys, see page 894

Square shoulder and slot milling cutters

Helical milling cutters

Face milling cutters

Disc milling cutters

High feed milling cutters

Copy milling cutters

Plunge milling cutters

Chamfer milling cutters

Spot facing cutters

Inserts

R217.79-XO12 – Metric

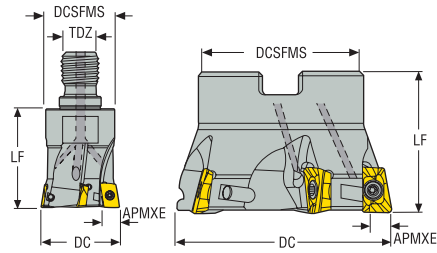

- For insert selection and cutting data recommendations, see page(s) 775-777
- For complete insert programme, see page(s) 869, 870
- For ISO attribute explanation, see page 16

Designation	Item number	Type of mounting	DC	ZEFP	APMXE	DCB	TDZ	DCSFMS	LF	Weight	RPMX	Insert
			mm		mm	mm		mm	mm	kg		
R217.79-1225.RE-XO12-2AN	02732338	Combimaster	25,0	2	7,0	–	M12	23,0	30,0	0,1	20800	XO..1204
R217.79-1632.RE-XO12-3AN	02732344	Combimaster	32,0	3	7,0	–	M16	30,0	40,0	0,2	18400	XO..1204
R220.79-0040-XO12-4AN	02732351	Arbor	40,0	4	7,0	16,0	–	35,0	40,0	0,2	16400	XO..1204
R220.79-0050-XO12-4AN	02732353	Arbor	50,0	4	7,0	22,0	–	42,0	40,0	0,3	14800	XO..1204
R220.79-0063-XO12-5AN	02732354	Arbor	63,0	5	7,0	22,0	–	47,0	40,0	0,5	13200	XO..1204

For Combimaster Shanks, see Machining Navigator Tooling System

Spare Parts, included in delivery

For cutter	Arbor screw	Insert key	Insert screw
R217.79-..	–	H4B-T10P	C03507-T10P
R220.79-0040	MC6S8X30	H4B-T10P	C03509-T10P
R220.79-0050-0063	220.17-692	H4B-T10P	C03509-T10P

Accessories

For cutter	Insert clamping torque	Torque key
R217/220.79-..	3.0NM	T00-10P30

Torque and fixed keys, see page 894

R217/220.79-XO12 – Insert selection – mm/Inch

SMG		f _z	a _{so}			
			100%	70%	50%	30%
P1	XOMX120408TR-ME08 MP2501	0,14 0,0055	5,0 0,20	5,0 0,20	5,0 0,20	6,0 0,24
P2	XOMX120408TR-ME08 MP2501	0,14 0,0055	5,0 0,20	5,0 0,20	5,0 0,20	6,0 0,24
P3	XOMX120408TR-ME08 MP2501	0,14 0,0055	5,0 0,20	5,0 0,20	5,0 0,20	6,0 0,24
P4	XOMX120408TR-ME08 MP2501	0,13 0,0050	5,0 0,20	5,0 0,20	5,0 0,20	6,0 0,24
P5	XOMX120408TR-ME08 MP2501	0,13 0,0050	5,0 0,20	5,0 0,20	5,0 0,20	6,0 0,24
P6	XOMX120408TR-ME08 MP2501	0,13 0,0050	5,0 0,20	5,0 0,20	5,0 0,20	6,0 0,24
P7	XOMX120408TR-M12 MP2501	0,15 0,0060	5,0 0,20	5,0 0,20	5,0 0,20	6,0 0,24
P8	XOMX120408TR-M12 MP2501	0,16 0,0065	5,0 0,20	5,0 0,20	5,0 0,20	6,0 0,24
P11	XOMX120408TR-M12 MP2501	0,15 0,0060	5,0 0,20	5,0 0,20	5,0 0,20	6,0 0,24
P12	XOMX120408TR-M12 MP2501	0,11 0,0044	4,0 0,16	4,0 0,16	4,0 0,16	4,5 0,18
M1	XOMX120408TR-ME08 F40M	0,14 0,0055	5,0 0,20	5,0 0,20	5,0 0,20	6,0 0,24
M2	XOMX120408TR-ME08 F40M	0,13 0,0050	5,0 0,20	5,0 0,20	5,0 0,20	6,0 0,24
M3	XOMX120408TR-ME08 F40M	0,10 0,0040	4,0 0,16	4,0 0,16	4,0 0,16	4,5 0,18
M4	XOEX120408ZZR-M07 F40M	0,075 0,0030	3,0 0,12	3,0 0,12	3,0 0,12	3,5 0,14
M5	XOEX120408ZZR-M07 F40M	0,075 0,0030	3,0 0,12	3,0 0,12	3,0 0,12	3,5 0,14
K1	XOMX120408TR-M12 MK1500	0,17 0,0065	5,0 0,20	5,0 0,20	5,0 0,20	6,0 0,24
K2	XOMX120408TR-M12 MK1500	0,16 0,0065	5,0 0,20	5,0 0,20	5,0 0,20	6,0 0,24
K3	XOMX120408TR-M12 MK1500	0,16 0,0065	5,0 0,20	5,0 0,20	5,0 0,20	6,0 0,24
K4	XOMX120408TR-M12 MK1500	0,16 0,0065	5,0 0,20	5,0 0,20	5,0 0,20	6,0 0,24
K5	XOMX120408TR-M12 MK1500	0,14 0,0055	5,0 0,20	5,0 0,20	5,0 0,20	6,0 0,24
K6	XOMX120408TR-M12 MK1500	0,16 0,0065	5,0 0,20	5,0 0,20	5,0 0,20	6,0 0,24
K7	XOMX120408TR-M12 MK1500	0,14 0,0055	5,0 0,20	5,0 0,20	5,0 0,20	6,0 0,24
N1	XOEX120408FR-E06 H15	0,13 0,0050	5,0 0,20	5,0 0,20	5,0 0,20	6,0 0,24
N2	XOEX120408FR-E06 H15	0,13 0,0050	5,0 0,20	5,0 0,20	5,0 0,20	6,0 0,24
N3	XOEX120408FR-E06 H15	0,13 0,0050	5,0 0,20	5,0 0,20	5,0 0,20	6,0 0,24
N11	XOEX120408FR-E06 H15	0,13 0,0050	5,0 0,20	5,0 0,20	5,0 0,20	6,0 0,24
S1	XOEX120408R-M07 T350M	0,075 0,0030	3,0 0,12	3,0 0,12	3,0 0,12	3,5 0,14
S2	XOEX120408R-M07 T350M	0,075 0,0030	3,0 0,12	3,0 0,12	3,0 0,12	3,5 0,14
S3	XOEX120408R-M07 F40M	0,070 0,0028	3,0 0,12	3,0 0,12	3,0 0,12	3,5 0,14
S11	XOEX120408R-M07 MS2050	0,085 0,0034	3,5 0,14	3,5 0,14	3,5 0,14	4,0 0,16
S12	XOEX120408R-M07 MS2050	0,085 0,0034	3,5 0,14	3,5 0,14	3,5 0,14	4,0 0,16
S13	XOEX120408R-M07 MS2050	0,075 0,0030	3,0 0,12	3,0 0,12	3,0 0,12	3,5 0,14
H5	XOMX120408TR-D14 MP1501	0,12 0,0048	4,0 0,16	4,0 0,16	4,0 0,16	4,5 0,18
H8	XOMX120408TR-D14 MP1501	0,095 0,0038	3,5 0,14	3,5 0,14	3,5 0,14	4,0 0,16
H11	XOMX120408TR-D14 MP1501	0,12 0,0048	4,0 0,16	4,0 0,16	4,0 0,16	4,5 0,18
H12	XOMX120408TR-D14 MP1501	0,095 0,0038	3,5 0,14	3,5 0,14	3,5 0,14	4,0 0,16
H21	XOMX120408TR-D14 MP1501	0,095 0,0038	3,5 0,14	3,5 0,14	3,5 0,14	4,0 0,16

SMG = Seco material group
f_z = mm/tooth (in/tooth), v_c = m/min (sf/min), a_p/DC = %
All cutting data are start values

Square shoulder and slot milling cutters
Helical milling cutters
Face milling cutters
Disc milling cutters
High feed milling cutters
Copy milling cutters
Plunge milling cutters
Chamfer milling cutters
Spot facing cutters
Inserts

R217/220.79-XO12 – Cutting data $v_c = (m/min)/(sf/min)$

SMG	MK1500				MK2050				MS2050				MS2500				H15			
	100%	70%	50%	30%	100%	70%	50%	30%	100%	70%	50%	30%	100%	70%	50%	30%	100%	70%	50%	30%
P1	—	—	—	—	220	240	255	275	210	235	250	265	295	330	350	375	—	—	—	—
	—	—	—	—	720	790	840	900	690	770	820	870	970	1075	1150	1225	—	—	—	—
P2	—	—	—	—	210	235	250	265	205	230	240	260	290	320	340	365	—	—	—	—
	—	—	—	—	690	770	820	870	670	750	790	850	950	1050	1125	1200	—	—	—	—
P3	—	—	—	—	185	205	220	235	175	195	210	220	250	275	295	315	—	—	—	—
	—	—	—	—	610	670	720	770	570	640	690	720	820	900	970	1025	—	—	—	—
P4	—	—	—	—	165	180	195	205	160	175	185	200	220	245	260	275	—	—	—	—
	—	—	—	—	540	590	640	670	520	570	610	660	720	800	850	900	—	—	—	—
P5	—	—	—	—	155	175	185	195	150	170	180	190	215	240	255	270	—	—	—	—
	—	—	—	—	510	570	610	640	490	560	590	620	710	790	840	890	—	—	—	—
P6	—	—	—	—	180	200	210	225	170	190	200	215	240	270	285	305	—	—	—	—
	—	—	—	—	590	660	690	740	560	620	660	710	790	890	940	1000	—	—	—	—
P7	—	—	—	—	170	190	200	215	160	180	190	200	230	255	270	285	—	—	—	—
	—	—	—	—	560	620	660	710	520	590	620	660	750	840	890	940	—	—	—	—
P8	—	—	—	—	155	175	185	195	150	165	175	185	210	235	245	265	—	—	—	—
	—	—	—	—	510	570	610	640	490	540	570	610	690	770	800	870	—	—	—	—
P11	—	—	—	—	165	185	195	205	155	175	185	195	220	245	260	280	—	—	—	—
	—	—	—	—	540	610	640	670	510	570	610	640	720	800	850	920	—	—	—	—
P12	—	—	—	—	105	120	125	135	105	115	120	130	145	160	170	185	—	—	—	—
	—	—	—	—	345	395	410	445	345	375	395	425	475	520	560	610	—	—	—	—
M1	—	—	—	—	—	—	—	—	165	185	195	210	205	230	245	260	—	—	—	—
	—	—	—	—	—	—	—	—	540	610	640	690	670	750	800	850	—	—	—	—
M2	—	—	—	—	—	—	—	—	135	150	160	170	170	190	205	215	—	—	—	—
	—	—	—	—	—	—	—	—	445	490	520	560	560	620	670	710	—	—	—	—
M3	—	—	—	—	—	—	—	—	115	125	135	145	140	155	165	175	—	—	—	—
	—	—	—	—	—	—	—	—	375	410	445	475	460	510	540	570	—	—	—	—
M4	—	—	—	—	—	—	—	—	90	100	105	110	110	120	125	135	—	—	—	—
	—	—	—	—	—	—	—	—	295	330	345	360	360	395	410	445	—	—	—	—
M5	—	—	—	—	—	—	—	—	75	80	85	95	90	100	105	115	—	—	—	—
	—	—	—	—	—	—	—	—	245	260	280	310	295	330	345	375	—	—	—	—
K1	240	270	285	305	230	255	270	290	—	—	—	—	—	—	—	—	—	—	—	—
	790	890	940	1000	750	840	890	950	—	—	—	—	—	—	—	—	—	—	—	—
K2	215	240	250	270	200	225	240	255	—	—	—	—	—	—	—	—	—	—	—	—
	710	790	820	890	660	740	790	840	—	—	—	—	—	—	—	—	—	—	—	—
K3	180	200	215	225	170	190	200	215	—	—	—	—	—	—	—	—	—	—	—	—
	590	660	710	740	560	620	660	710	—	—	—	—	—	—	—	—	—	—	—	—
K4	170	190	205	215	165	180	190	205	—	—	—	—	—	—	—	—	—	—	—	—
	560	620	670	710	540	590	620	670	—	—	—	—	—	—	—	—	—	—	—	—
K5	105	120	125	135	100	115	120	130	—	—	—	—	—	—	—	—	—	—	—	—
	345	395	410	445	330	375	395	425	—	—	—	—	—	—	—	—	—	—	—	—
K6	150	170	180	190	145	160	170	180	—	—	—	—	—	—	—	—	—	—	—	—
	490	560	590	620	475	520	560	590	—	—	—	—	—	—	—	—	—	—	—	—
K7	135	155	160	175	130	145	155	165	—	—	—	—	—	—	—	—	—	—	—	—
	445	510	520	570	425	475	510	540	—	—	—	—	—	—	—	—	—	—	—	—
N1	—	—	—	—	—	—	—	—	—	—	—	—	—	—	—	—	1200	1325	1400	1500
	—	—	—	—	—	—	—	—	—	—	—	—	—	—	—	—	3925	4350	4600	4925
N2	—	—	—	—	—	—	—	—	—	—	—	—	—	—	—	—	480	540	570	600
	—	—	—	—	—	—	—	—	—	—	—	—	—	—	—	—	1575	1775	1875	1975
N3	—	—	—	—	—	—	—	—	—	—	—	—	—	—	—	—	320	355	375	405
	—	—	—	—	—	—	—	—	—	—	—	—	—	—	—	—	1050	1175	1225	1325
N11	—	—	—	—	—	—	—	—	—	—	—	—	—	—	—	—	365	410	430	460
	—	—	—	—	—	—	—	—	—	—	—	—	—	—	—	—	1200	1350	1400	1500
S1	—	—	—	—	—	—	—	—	41	46	49	50	55	60	60	65	—	—	—	—
	—	—	—	—	—	—	—	—	135	150	160	165	180	195	195	215	—	—	—	—
S2	—	—	—	—	—	—	—	—	33	37	39	42	42	47	50	55	—	—	—	—
	—	—	—	—	—	—	—	—	110	120	130	140	140	155	165	180	—	—	—	—
S3	—	—	—	—	—	—	—	—	29	32	34	37	37	42	44	47	—	—	—	—
	—	—	—	—	—	—	—	—	95	105	110	120	120	140	145	155	—	—	—	—
S11	—	—	—	—	—	—	—	—	55	65	70	75	75	80	85	95	—	—	—	—
	—	—	—	—	—	—	—	—	180	215	230	245	245	260	280	310	—	—	—	—
S12	—	—	—	—	—	—	—	—	40	44	47	50	50	55	60	65	—	—	—	—
	—	—	—	—	—	—	—	—	130	145	155	165	165	180	195	215	—	—	—	—
S13	—	—	—	—	—	—	—	—	23	26	27	29	30	33	35	37	—	—	—	—
	—	—	—	—	—	—	—	—	75	85	90	95	100	110	115	120	—	—	—	—
H5	—	—	—	—	—	—	—	—	—	—	—	—	—	—	—	—	—	—	—	—
H8	—	—	—	—	—	—	—	—	—	—	—	—	—	—	—	—	—	—	—	—
H11	—	—	—	—	—	—	—	—	—	—	—	—	—	—	—	—	—	—	—	—
H12	—	—	—	—	—	—	—	—	—	—	—	—	—	—	—	—	—	—	—	—
H21	—	—	—	—	—	—	—	—	—	—	—	—	—	—	—	—	—	—	—	—

Square shoulder and slot milling cutters
Helical milling cutters
Face milling cutters
Disc milling cutters
High feed milling cutters
Copy milling cutters
Plunge milling cutters
Chamfer milling cutters
Spot facing cutters
Inserts

Square shoulder and
slot milling cutters

Helical milling cutters

Face milling cutters

Disc milling cutters

High feed milling
cutters

Copy milling cutters

Plunge milling cutters

Chamfer milling cutters

Spot facing cutters

Inserts



R217/220.79-12

The R217/220.79 for SCET12 inserts are strong and robust plunge mill.

- Cutter range 32-160 mm (1.25 - 6 inch)
- Max radial depth of cut: 11 mm (.433 inch)
- Insert corner radii range 1.2-3.1 mm (.047 - .122 inch)

R217.79-SC..12 – Metric

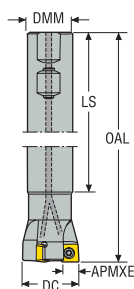

- For insert selection and cutting data recommendations, see page(s) 784-785
- For complete insert programme, see page(s) 843
- For ISO attribute explanation, see page 16

Designation	Item number	Type of mounting	DC	ZEFP	APMXE	DMM	LS	OAL	RPMX	Weight	Insert
			mm		mm	mm	mm	mm		kg	
R217.79-2532.3-12A	00097786	Weldon	32,0	2	11,0	25,0	150,0	200,0	12100	0,7	SC..1206
R217.79-3240.3-12A	00097787	Weldon	40,0	3	11,0	32,0	150,0	200,0	10800	1,1	SC..1206

Spare Parts, included in delivery

For cutter	Insert key	Insert screw
R217.79-..	H6B-T20P	C45011-T20P

Accessories

For cutter	Insert clamping torque	Torque key
R217.79-..	5.0NM	T00-20P50

Torque and fixed keys, see page 894

Square shoulder and slot milling cutters

Helical milling cutters

Face milling cutters

Disc milling cutters

High feed milling cutters

Copy milling cutters

Plunge milling cutters

Chamfer milling cutters

Spot facing cutters

Inserts

R217.79-SC..12 – inch

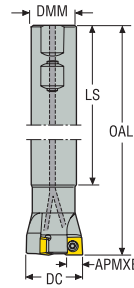

- For insert selection and cutting data recommendations, see page(s) 784-785
- For complete insert programme, see page(s) 843
- For ISO attribute explanation, see page 16

Designation	Item number	Type of mounting	DC	ZEFP	APMXE	DMM	LS	OAL	RPMX	Weight	Insert
			inch		inch	inch	inch	inch		lbs	
R217.79-01.25-3-12A	00057587	Weldon	1.250	2	0.433	1.000	5.906	7.874	12100	1.980	SC..1206
R217.79-01.50-3-12A	00057588	Weldon	1.500	3	0.433	1.250	5.906	7.874	10800	2.870	SC..1206

Spare Parts, included in delivery

For cutter	Insert key	Insert screw
R217.79-..	H6B-T20P	C45011-T20P

Accessories

For cutter	Insert clamping torque	Torque key
R217.79-..	44.3IN.LBS	T00-20P50

Torque and fixed keys, see page 894

Square shoulder and slot milling cutters
Helical milling cutters
Face milling cutters
Disc milling cutters
High feed milling cutters
Copy milling cutters
Plunge milling cutters
Chamfer milling cutters
Spot facing cutters
Inserts

R220.79-SC..12 – Metric

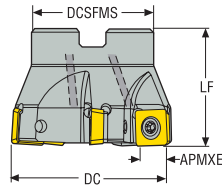

- For insert selection and cutting data recommendations, see page(s) 784-785
- For complete insert programme, see page(s) 843
- For ISO attribute explanation, see page 16

Designation	Item number	Type of mounting	DC	ZAFP	APMXE	DCB	TDZ	DCSFMS	LF	Weight	RPMX	Insert
			mm		mm	mm		mm	mm	kg		
R220.79-0050-12A	00030330	Arbor	50,0	4	11,0	22,0	–	42,0	40,0	0,3	9700	SC..1206
R220.79-0063-12A	00030331	Arbor	63,0	5	11,0	22,0	–	47,0	40,0	0,5	8600	SC..1206
R220.79-0080-12A	00030332	Arbor	80,0	6	11,0	27,0	–	62,0	50,0	1,0	7600	SC..1206
R220.79-0100-12A	00030335	Arbor	100,0	7	11,0	32,0	–	77,0	50,0	1,6	7000	SC..1206
R220.79-0125-12	00069980	Arbor	125,0	8	11,0	40,0	–	90,0	63,0	2,9	6300	SC..1206

Spare Parts, included in delivery

For cutter	Arbor screw	Insert key	Insert screw
R220.79-0050-0063	220.17-692	H6B-T20P	C45011-T20P
R220.79-0080	–	H6B-T20P	C45011-T20P
R220.79-0100-0125	–	H6B-T20PL	C45011-T20P

Accessories

For cutter	Insert clamping torque	Torque key
R220.79-..	5.0NM	T00-20P50

Torque and fixed keys, see page 894

Square shoulder and slot milling cutters

Helical milling cutters

Face milling cutters

Disc milling cutters

High feed milling cutters

Copy milling cutters

Plunge milling cutters

Chamfer milling cutters

Spot facing cutters

Inserts

R220.79-SC..12 – inch

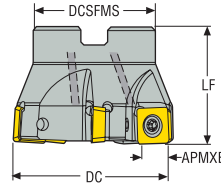

- For insert selection and cutting data recommendations, see page(s) 784-785
- For complete insert programme, see page(s) 843
- For ISO attribute explanation, see page 16

Designation	Item number	Type of mounting	DC	ZEPF	APMXE	DCB	TDZ	DCSFMS	LF	Weight	RPMX	Insert
			inch		inch	inch		inch	inch	lbs		
R220.79-02.00-12A	00039776	Shell mill	2.000	4	0.433	0.750	–	1.850	1.500	0.880	9700	SC..1206
R220.79-02.50-12A	00039777	Shell mill	2.500	5	0.433	0.750	–	1.850	1.500	1.320	8600	SC..1206
R220.79-03.00-12A	00039778	Shell mill	3.000	6	0.433	1.000	–	2.441	2.000	2.650	7600	SC..1206

Spare Parts, included in delivery

For cutter	Arbor screw	Insert key	Insert screw
R220.79-02.00-02.50	UC6S3/8UNFX1	H6B-T20P	C45011-T20P
R220.79-03.00	UC6S1/2UNFX1-1/4	H6B-T20P	C45011-T20P

Accessories

For cutter	Insert clamping torque	Torque key
R220.79-..	44.3IN.LBS	T00-20P50

Torque and fixed keys, see page 894

R220.79-SC..12 – Metric

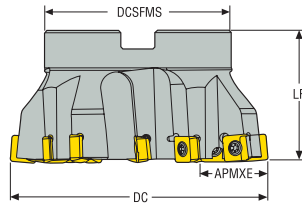

- For insert selection and cutting data recommendations, see page(s) 784-785
- For complete insert programme, see page(s) 843
- For ISO attribute explanation, see page 16

Designation	Item number	Type of mounting	DC	ZEPF	APMXE	DCB	TDZ	DCSFMS	LF	Weight	RPMX	Insert
			mm		mm	mm		mm	mm	kg		
R220.79-0100-20	00045683	Arbor	100,0	4	20,0	32,0	–	77,0	50,0	1,3	7000	SC..1206
R220.79-0125-30	00091797	Arbor	125,0	4	30,0	40,0	–	90,0	63,0	2,6	6300	SC..1206
R220.79-8160-40	00094578	Arbor	160,0	4	40,0	40,0	–	90,0	64,0	4,0	5600	SC..1206

Spare Parts, included in delivery

For cutter	Arbor screw	Insert key	Insert screw
R220.79-0100	–	H6B-T20PL	C45011-T20P
R220.79-0125	MC6S20X40	H6B-T20PL	C45011-T20P
R220.79-8160	–	H6B-T20PL	C45011-T20P

Accessories

For cutter	Arbor screw	Insert clamping torque	Torque key
R220.79-0100-0125	–	5.0NM	T00-20P50
R220.79-8160	MC6S12X40	5.0NM	T00-20P50

Torque and fixed keys, see page 894

Square shoulder and slot milling cutters

Helical milling cutters

Face milling cutters

Disc milling cutters

High feed milling cutters

Copy milling cutters

Plunge milling cutters

Chamfer milling cutters

Spot facing cutters

Inserts

R217/220.79-12 – Insert selection – mm/Inch

SMG		f _z	a _{so}			
			100%	70%	50%	30%
P1	SCET120612T-M14 MP2501	0,20	8,0	8,0	8,0	9,0
		0.0080	0.32	0.32	0.32	0.36
P2	SCET120612T-M14 MP2501	0,20	8,0	8,0	8,0	9,0
		0.0080	0.32	0.32	0.32	0.36
P3	SCET120612T-M14 MP2501	0,19	8,0	8,0	8,0	9,0
		0.0075	0.32	0.32	0.32	0.36
P4	SCET120612T-M14 MP2501	0,19	8,0	8,0	8,0	9,0
		0.0075	0.32	0.32	0.32	0.36
P5	SCET120612T-M14 MP2501	0,18	8,0	8,0	8,0	9,0
		0.0070	0.32	0.32	0.32	0.36
P6	SCET120612T-M14 MP2501	0,18	8,0	8,0	8,0	9,0
		0.0070	0.32	0.32	0.32	0.36
P7	SCET120612T-M14 MP2501	0,18	8,0	8,0	8,0	9,0
		0.0070	0.32	0.32	0.32	0.36
P8	SCET120612T-M14 MP2501	0,19	8,0	8,0	8,0	9,0
		0.0075	0.32	0.32	0.32	0.36
P11	SCET120612T-M14 MP2501	0,18	8,0	8,0	8,0	9,0
		0.0070	0.32	0.32	0.32	0.36
P12	SCET120612T-M14 MP2501	0,12	6,0	6,0	6,0	7,0
		0.0048	0.24	0.24	0.24	0.28
M1	SCET120612T-M14 MS2050	0,20	8,0	8,0	8,0	9,0
		0.0080	0.32	0.32	0.32	0.36
M2	SCET120612T-M14 MS2050	0,18	8,0	8,0	8,0	9,0
		0.0070	0.32	0.32	0.32	0.36
M3	SCET120612T-M14 MS2050	0,15	6,0	6,0	6,0	7,0
		0.0060	0.24	0.24	0.24	0.28
M4	SCET120612T-M14 MS2050	0,13	4,5	4,5	4,5	5,0
		0.0050	0.18	0.18	0.18	0.20
M5	SCET120612T-M14 MS2050	0,13	4,5	4,5	4,5	5,0
		0.0050	0.18	0.18	0.18	0.20
K1	SCET120612T-M14 MP2501	0,20	8,0	8,0	8,0	9,0
		0.0080	0.32	0.32	0.32	0.36
K2	SCET120612T-M14 MP2501	0,18	8,0	8,0	8,0	9,0
		0.0070	0.32	0.32	0.32	0.36
K3	SCET120612T-M14 MP2501	0,18	8,0	8,0	8,0	9,0
		0.0070	0.32	0.32	0.32	0.36
K4	SCET120612T-M14 MP2501	0,18	8,0	8,0	8,0	9,0
		0.0070	0.32	0.32	0.32	0.36
K5	SCET120612T-M14 MP2501	0,16	8,0	8,0	8,0	9,0
		0.0065	0.32	0.32	0.32	0.36
K6	SCET120612T-M14 MP2501	0,18	8,0	8,0	8,0	9,0
		0.0070	0.32	0.32	0.32	0.36
K7	SCET120612T-M14 MP2501	0,16	8,0	8,0	8,0	9,0
		0.0065	0.32	0.32	0.32	0.36
N1	SCMT120612T-M14 F40M	0,25	8,0	8,0	8,0	9,0
		0.010	0.32	0.32	0.32	0.36
N2	SCMT120612T-M14 F40M	0,25	8,0	8,0	8,0	9,0
		0.010	0.32	0.32	0.32	0.36
N3	SCMT120612T-M14 F40M	0,25	8,0	8,0	8,0	9,0
		0.010	0.32	0.32	0.32	0.36
N11	SCMT120612T-M14 F40M	0,25	8,0	8,0	8,0	9,0
		0.010	0.32	0.32	0.32	0.36
S1	SCMT120612T-M14 F40M	0,13	4,5	4,5	4,5	5,0
		0.0050	0.18	0.18	0.18	0.20
S2	SCMT120612T-M14 F40M	0,13	4,5	4,5	4,5	5,0
		0.0050	0.18	0.18	0.18	0.20
S3	SCMT120612T-M14 F40M	0,12	4,5	4,5	4,5	5,0
		0.0048	0.18	0.18	0.18	0.20
S11	SCET120612T-M14 MS2050	0,15	5,0	5,0	5,0	6,0
		0.0060	0.20	0.20	0.20	0.24
S12	SCET120612T-M14 MS2050	0,15	5,0	5,0	5,0	6,0
		0.0060	0.20	0.20	0.20	0.24
S13	SCET120612T-M14 MS2050	0,13	4,5	4,5	4,5	5,0
		0.0050	0.18	0.18	0.18	0.20
H5	SCMT120612T-M14 T350M	0,12	6,0	6,0	6,0	7,0
		0.0048	0.24	0.24	0.24	0.28
H8	SCMT120612T-M14 T350M	0,095	5,0	5,0	5,0	6,0
		0.0038	0.20	0.20	0.20	0.24
H11	SCMT120612T-M14 T350M	0,12	6,0	6,0	6,0	7,0
		0.0048	0.24	0.24	0.24	0.28
H12	SCMT120612T-M14 T350M	0,095	5,0	5,0	5,0	6,0
		0.0038	0.20	0.20	0.20	0.24
H21	SCMT120612T-M14 T350M	0,095	5,0	5,0	5,0	6,0
		0.0038	0.20	0.20	0.20	0.24

SMG = Seco material group
f_z = mm/tooth (in/tooth), v_c = m/min (sf/min), a_g/DC = %
All cutting data are start values



Chamfer Mills

Turbo 12, R217/220.49-XO12 Chamfer mills, for XOMX12 inserts with 2 cutting edges and is available in many different grades for most common workpiece materials

- Chamfer angle 30°, 45°, 60° and 75°
- Max. depth of cut 31 mm (1.22 inch) with the 75° milling cutter
- Front chamfering
- Available in combimaster, Seco-Capto or for arbor mounting

R215/220.49 Chamfer mills for SPMX06/09/12 insert types, 4-cutting edges, single sided positive inserts.

- Chamfer angle 45° and 60°
- Front and back chamfering
- Available in Weldon and Arbor mounting

Square shoulder and slot milling cutters

Helical milling cutters

Face milling cutters

Disc milling cutters

High feed milling cutters

Copy milling cutters

Plunge milling cutters

Chamfer milling cutters

Spot facing cutters

Inserts

R217/220.49-XO12 – Metric

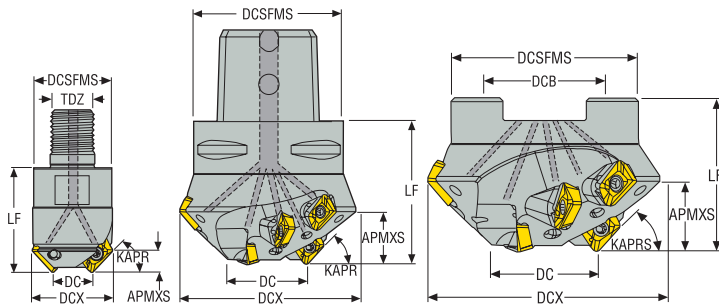

- For insert selection and cutting data recommendations, see page(s) 789-791
- For complete insert programme, see page(s) 869, 870
- For ISO attribute explanation, see page 16

Designation	Item number	Type of mounting	KAPRS°	DC	DCX	APMXS	ZEFP	ZNP	DCB	DCSFMS	LF	RPMX	Weight	Insert
				mm	mm	mm			mm	mm	mm		kg	
R217.49-1620.RE-XO12-30.3A	02669573	Combimaster	30,0	20,0	39,8	5,5	3	3	–	30,0	40,0	16400	0,3	XO.X12
R217.49-1616.RE-XO12-45.2A	02669571	Combimaster	45,0	16,0	30,8	8,0	2	2	–	30,0	40,0	18600	0,3	XO.X12
R217.49-1620.RE-XO12-45.3A	02669574	Combimaster	45,0	20,0	34,8	7,7	3	3	–	30,0	40,0	17400	0,3	XO.X12
R217.49-1216.RE-XO12-60.2A	02669572	Combimaster	60,0	16,0	27,0	9,0	2	2	–	23,0	30,0	20100	0,1	XO.X12
R217.49-1620.RE-XO12-60.3A	02669575	Combimaster	60,0	20,0	30,5	9,0	3	3	–	30,0	40,0	18400	0,3	XO.X12
R217.49-1220.RE-XO12-75.2A	02669576	Combimaster	75,0	20,0	25,4	11,0	2	2	–	23,0	30,0	20500	0,1	XO.X12
C6-R217.49-032-15-XO12-30.3A	02669613	Seco-Capto	30,0	32,0	88,8	15,9	3	9	–	63,0	60,0	10900	1,6	XO.X12
C6-R217.49-032-22-XO12-45.3A	02669615	Seco-Capto	45,0	32,0	76,4	22,5	3	9	–	63,0	60,0	11800	1,4	XO.X12
C6-R217.49-032-28-XO12-60.3A	02669616	Seco-Capto	60,0	32,0	64,0	28,0	3	9	–	63,0	60,0	12900	1,3	XO.X12
C5-R217.49-032-42-XO12-75.3A	02669617	Seco-Capto	75,0	32,0	54,1	42,5	3	12	–	50,0	70,0	14100	0,8	XO.X12
R220.49-0035-15-XO12-30.3A	02669634	Arbor	30,0	35,0	91,9	15,9	3	9	27,0	62,0	50,0	10700	1,1	XO.X12
R220.49-0035-22-XO12-45.3A	02669637	Arbor	45,0	35,0	79,4	22,5	3	9	27,0	62,0	50,0	11600	0,8	XO.X12
R220.49-0035-28-XO12-60.3A	02669638	Arbor	60,0	35,0	67,0	28,0	3	9	27,0	62,0	50,0	12600	0,6	XO.X12
R220.49-0035-31-XO12-75.3A	02669639	Arbor	75,0	35,0	51,5	31,0	3	9	22,0	47,0	50,0	14400	0,4	XO.X12

Spare Parts, included in delivery

For cutter	Arbor screw	Insert key	Insert screw
R217.49 Ø 20 30/45°	–	H4B-T10P	C03509-T10P
R217.49 Ø 16 45/60°	–	H4B-T10P	C03507-T10P
R217.49 Ø 20 60/75°	–	H4B-T10P	C03507-T10P
Cx-R217.49 Ø 32 30/45/60/75°	–	H4B-T10P	C03509-T10P
R220.49-... 30/45/60°	MC6S12X35	H4B-T10P	C03509-T10P
R220.49-...75°	MC6S10X40	H4B-T10P	C03509-T10P

Accessories

For cutter	Insert clamping torque	Torque key
R217/220.49-..	3.0NM	T00-10P30

Torque and fixed keys, see page 894

Square shoulder and slot milling cutters
Helical milling cutters
Face milling cutters
Disc milling cutters
High feed milling cutters
Copy milling cutters
Plunge milling cutters
Chamfer milling cutters
Spot facing cutters
Inserts

R217/220.49-XO12 – inch

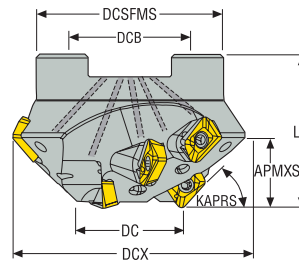

- For insert selection and cutting data recommendations, see page(s) 789-791
- For complete insert programme, see page(s) 869, 870
- For ISO attribute explanation, see page 16

Designation	Item number	Type of mounting	KAPRS°	DC	DCX	APMXS	ZEFP	ZNP	DCB	DCSFMS	LF	RPMX	Weight	Insert
				inch	inch	inch			inch	inch	inch		lbs	
R220.49-01.38-15-XO12-30.3A	02670045	Arbor	30,0	1.378	3.618	0.626	3	9	1.000	2.441	1.969	14400	2.200	XO.X12
R220.49-01.38-22-XO12-45.3A	02670048	Arbor	45,0	1.378	3.126	0.886	3	9	1.000	2.441	1.969	14400	1.760	XO.X12
R220.49-01.38-28-XO12-60.3A	02670049	Arbor	60,0	1.378	2.638	1.110	3	9	1.000	2.441	1.969	14400	1.320	XO.X12
R220.49-01.38-31-XO12-75.3A	02670051	Arbor	75,0	1.378	2.028	1.244	3	9	0.750	1.850	1.969	14400	0.880	XO.X12

Spare Parts, included in delivery

For cutter	Arbor screw	Insert key	Insert screw
R220.49-... 30/45/60°	UC6S1/2UNFX1-1/2	H4B-T10P	C03509-T10P
R220.49-...75°	UC6S3/8UNFX11/2	H4B-T10P	C03509-T10P

Accessories

For cutter	Insert clamping torque	Torque key
R217/220.49-..	26.6IN.LBS	T00-10P30

Torque and fixed keys, see page 894

R217/220.49-XO12 – Insert selection – mm/Inch

SMG		f _z		
		50%	30%	10%
P1	XOMX120408TR-ME08 F40M	0,18	0,22	0,36
		0.0070	0.0085	0.014
P2	XOMX120408TR-ME08 F40M	0,19	0,22	0,38
		0.0075	0.0085	0.015
P3	XOMX120408TR-ME08 MP2501	0,18	0,22	0,36
		0.0070	0.0085	0.014
P4	XOMX120408TR-M12 MP2501	0,20	0,25	0,42
		0.0080	0.010	0.017
P5	XOMX120408TR-M12 MP2501	0,20	0,24	0,40
		0.0080	0.0095	0.016
P6	XOMX120408TR-M12 MP2501	0,20	0,24	0,40
		0.0080	0.0095	0.016
P7	XOMX120408TR-M12 MP2501	0,20	0,24	0,40
		0.0080	0.0095	0.016
P8	XOMX120408TR-M12 MP2501	0,22	0,25	0,42
		0.0085	0.010	0.017
P11	XOMX120408TR-M12 T350M	0,20	0,24	0,40
		0.0080	0.0095	0.016
P12	XOEX120408R-M07 MS2500	0,090	0,11	0,18
		0.0036	0.0044	0.0070
M1	XOEX120408R-M07 F40M	0,15	0,18	0,30
		0.0060	0.0070	0.012
M2	XOEX120408R-M07 F40M	0,14	0,16	0,26
		0.0055	0.0065	0.010
M3	XOEX120408R-M07 F40M	0,11	0,13	0,22
		0.0044	0.0050	0.0085
M4	XOEX120408R-M07 T350M	0,095	0,11	0,19
		0.0038	0.0044	0.0075
M5	XOEX120408R-M07 T350M	0,095	0,11	0,19
		0.0038	0.0044	0.0075
K1	XOMX120408TR-M12 MK2050	0,22	0,26	0,44
		0.0085	0.010	0.017
K2	XOMX120408TR-M12 MK2050	0,20	0,24	0,40
		0.0080	0.0095	0.016
K3	XOMX120408TR-M12 MK2050	0,20	0,24	0,40
		0.0080	0.0095	0.016
K4	XOMX120408TR-M12 MK2050	0,18	0,22	0,36
		0.0070	0.0085	0.014
K5	XOMX120408TR-M12 MK2050	0,20	0,24	0,40
		0.0080	0.0095	0.016
K6	XOMX120408TR-M12 MK2050	0,18	0,22	0,36
		0.0070	0.0085	0.014
K7	XOMX120408TR-M12 MK2050	0,17	0,20	0,34
		0.0065	0.0080	0.013
N1	XOEX120408FR-E06 H15	0,17	0,20	0,34
		0.0065	0.0080	0.013
N2	XOEX120408FR-E06 H15	0,17	0,20	0,34
		0.0065	0.0080	0.013
N3	XOEX120408FR-E06 H15	0,17	0,20	0,34
		0.0065	0.0080	0.013
N11	XOEX120408FR-E06 H15	0,17	0,20	0,34
		0.0065	0.0080	0.013
S1	XOEX120408R-M07 F40M	0,095	0,11	0,19
		0.0038	0.0044	0.0075
S2	XOEX120408R-M07 F40M	0,090	0,10	0,17
		0.0036	0.0040	0.0065
S3	XOEX120408R-M07 F40M	0,11	0,13	0,22
		0.0044	0.0050	0.0085
S11	XOEX120408R-M07 MS2050	0,11	0,13	0,22
		0.0044	0.0050	0.0085
S12	XOEX120408R-M07 MS2050	0,095	0,11	0,19
		0.0038	0.0044	0.0075
S13	XOEX120408R-M07 MS2050	0,15	0,17	0,30
		0.0060	0.0065	0.012
H5	XOMX120408TR-MD13 MP3000	0,11	0,13	0,22
		0.0044	0.0050	0.0085
H8	XOMX120408TR-MD13 MP3000	0,15	0,17	0,30
		0.0060	0.0065	0.012
H11	XOMX120408TR-MD13 MP1501	0,11	0,12	0,20
		0.0044	0.0048	0.0080
H12	XOMX120408TR-M12 MP1501	0,11	0,12	0,20
		0.0044	0.0048	0.0080

SMG = Seco material group
 f_z = mm/tooth (in/tooth), v_c = m/min (sf/min), a_e/DC = %
 All cutting data are start values

Square shoulder and slot milling cutters
 Helical milling cutters
 Face milling cutters
 Disc milling cutters
 High feed milling cutters
 Copy milling cutters
 Plunge milling cutters
 Chamfer milling cutters
 Spot facing cutters
 Inserts

R217/220.49-XO12 – Cutting data $v_c = (m/min)/(sf/min)$

SMG	MP1501			MP2050			MP2501			MP3000			MM4500			MK1500			
	50%	30%	10%	50%	30%	10%	50%	30%	10%	50%	30%	10%	50%	30%	10%	50%	30%	10%	
P1	205	215	230	210	215	230	195	205	220	190	200	215	170	175	190	—	—	—	
	670	710	750	690	710	750	640	670	720	620	660	710	560	570	620	—	—	—	
P2	205	210	225	205	215	230	195	205	215	190	200	210	165	175	190	—	—	—	
	670	690	740	670	710	750	640	670	710	620	660	690	540	570	620	—	—	—	
P3	190	200	215	195	205	220	185	190	205	180	190	200	155	165	180	—	—	—	
	620	660	710	640	670	720	610	620	670	590	620	660	510	540	590	—	—	—	
P4	185	190	205	185	195	210	175	185	195	170	180	195	145	155	170	—	—	—	
	610	620	670	610	640	690	570	610	640	560	590	640	475	510	560	—	—	—	
P5	180	190	205	185	190	205	170	180	195	170	175	190	145	155	165	—	—	—	
	590	620	670	610	620	670	560	590	640	560	570	620	475	510	540	—	—	—	
P6	190	200	210	195	200	215	180	190	205	175	185	200	155	160	175	—	—	—	
	620	660	690	640	660	710	590	620	670	570	610	660	510	520	570	—	—	—	
P7	185	195	210	190	195	210	175	185	200	170	180	195	150	155	170	—	—	—	
	610	640	690	620	640	690	570	610	660	560	590	640	490	510	560	—	—	—	
P8	180	190	200	185	190	205	170	180	195	165	175	190	145	150	165	—	—	—	
	590	620	660	610	620	670	560	590	640	540	570	620	475	490	540	—	—	—	
P11	185	190	205	185	195	210	175	180	195	170	180	190	145	155	170	—	—	—	
	610	620	670	610	640	690	570	590	640	560	590	620	475	510	560	—	—	—	
P12	150	155	175	150	160	175	140	150	165	135	145	160	115	120	135	—	—	—	
	490	510	570	490	520	570	460	490	540	445	475	520	375	395	445	—	—	—	
M1	—	—	—	180	190	205	170	180	190	170	175	190	155	165	175	—	—	—	
	—	—	—	590	620	670	560	590	620	560	570	620	510	540	570	—	—	—	
M2	—	—	—	165	175	190	155	165	180	155	165	175	140	150	165	—	—	—	
	—	—	—	540	570	620	510	540	590	510	540	570	460	490	540	—	—	—	
M3	—	—	—	150	155	170	140	145	160	135	145	160	120	130	150	—	—	—	
	—	—	—	490	510	560	460	475	520	445	475	520	395	425	490	—	—	—	
M4	—	—	—	125	135	155	115	125	145	115	125	140	100	110	125	—	—	—	
	—	—	—	410	445	510	375	410	475	375	410	460	330	360	410	—	—	—	
M5	—	—	—	115	120	140	105	110	130	100	110	130	85	95	115	—	—	—	
	—	—	—	375	395	460	345	360	425	330	360	425	280	310	375	—	—	—	
K1	185	195	210	190	195	210	175	185	200	175	180	195	—	—	—	205	210	225	
	610	640	690	620	640	690	570	610	660	570	590	640	—	—	—	670	690	740	
K2	175	185	200	180	190	200	170	175	190	165	170	185	—	—	—	195	200	215	
	570	610	660	590	620	660	560	570	620	540	560	610	—	—	—	640	660	710	
K3	165	175	185	165	175	190	155	165	180	150	160	175	—	—	—	180	190	205	
	540	570	610	540	570	620	510	540	590	490	520	570	—	—	—	590	620	670	
K4	160	170	185	165	170	185	150	160	175	150	155	170	—	—	—	180	185	200	
	520	560	610	540	560	610	490	520	570	490	510	560	—	—	—	590	610	660	
K5	125	130	145	125	135	150	115	125	140	110	120	135	—	—	—	140	150	165	
	410	425	475	410	445	490	375	410	460	360	395	445	—	—	—	460	490	540	
K6	150	160	175	155	165	175	145	150	165	140	145	160	—	—	—	170	175	190	
	490	520	570	510	540	570	475	490	540	460	475	520	—	—	—	560	570	620	
K7	145	150	165	145	155	165	135	140	155	130	140	150	—	—	—	160	170	180	
	475	490	540	475	510	540	445	460	510	425	460	490	—	—	—	520	560	590	
N1	—	—	—	—	—	—	—	—	—	320	330	345	—	—	—	—	—	—	
	—	—	—	—	—	—	—	—	—	1050	1075	1125	—	—	—	—	—	—	
N2	—	—	—	—	—	—	—	—	—	—	255	260	275	—	—	—	—	—	—
	—	—	—	—	—	—	—	—	—	840	850	900	—	—	—	—	—	—	
N3	—	—	—	—	—	—	—	—	—	—	225	230	245	—	—	—	—	—	—
	—	—	—	—	—	—	—	—	—	740	750	800	—	—	—	—	—	—	
N11	—	—	—	—	—	—	—	—	—	—	235	240	255	—	—	—	—	—	—
	—	—	—	—	—	—	—	—	—	770	790	840	—	—	—	—	—	—	
S1	—	—	—	75	80	100	65	70	90	60	65	85	32	36	46	—	—	—	
	—	—	—	245	260	330	215	230	295	195	215	280	105	120	150	—	—	—	
S2	—	—	—	60	65	85	50	55	75	48	55	70	26	29	37	—	—	—	
	—	—	—	195	215	280	165	180	245	155	180	230	85	95	120	—	—	—	
S3	—	—	—	50	55	75	45	50	65	42	47	60	23	25	33	—	—	—	
	—	—	—	165	180	245	150	165	215	140	155	195	75	80	110	—	—	—	
S11	—	—	—	100	105	125	90	95	115	85	90	110	47	50	65	—	—	—	
	—	—	—	330	345	410	295	310	375	280	295	360	155	165	215	—	—	—	
S12	—	—	—	70	80	95	60	70	85	60	65	80	43	47	60	—	—	—	
	—	—	—	230	260	310	195	230	280	195	215	260	140	155	195	—	—	—	
S13	—	—	—	41	46	60	36	40	50	34	38	48	24	27	35	—	—	—	
	—	—	—	135	150	195	120	130	165	110	125	155	80	90	115	—	—	—	
H5	65	75	90	60	70	85	55	60	75	50	60	70	—	—	—	—	—	—	
	215	245	295	195	230	280	180	195	245	165	195	230	—	—	—	—	—	—	
H8	70	80	95	65	70	90	55	65	80	55	60	80	—	—	—	—	—	—	
	230	260	310	215	230	295	180	215	260	180	195	260	—	—	—	—	—	—	
H11	85	90	110	80	85	105	70	75	90	65	75	90	—	—	—	—	—	—	
	280	295	360	260	280	345	230	245	295	215	245	295	—	—	—	—	—	—	
H12	115	120	140	115	125	140	105	115	130	100	110	125	—	—	—	—	—	—	
	375	395	460	375	410	460	345	375	425	330	360	410	—	—	—	—	—	—	

R217/220.49-XO12 – Cutting data $v_c = (m/min)/(sf/min)$

SMG	MK2050			MS2050			MS2500			T350M			F40M			H15		
	50%	30%	10%	50%	30%	10%	50%	30%	10%	50%	30%	10%	50%	30%	10%	50%	30%	10%
P1	195	205	215	190	200	215	215	225	240	185	195	210	175	185	200	—	—	—
	640	670	710	620	660	710	710	740	790	610	640	690	570	610	660	—	—	—
P2	195	200	215	190	200	210	215	220	235	185	195	205	175	180	195	—	—	—
	640	660	710	620	660	690	710	720	770	610	640	670	570	590	640	—	—	—
P3	180	190	205	180	185	200	205	210	225	175	180	195	160	170	185	—	—	—
	590	620	670	590	610	660	670	690	740	570	590	640	520	560	610	—	—	—
P4	175	180	195	170	180	190	195	205	215	165	175	185	155	160	175	—	—	—
	570	590	640	560	590	620	640	670	710	540	570	610	510	520	570	—	—	—
P5	170	180	195	165	175	190	190	200	215	160	170	185	150	160	175	—	—	—
	560	590	640	540	570	620	620	660	710	520	560	610	490	520	570	—	—	—
P6	180	190	200	175	185	200	200	210	225	170	180	195	160	170	180	—	—	—
	590	620	660	570	610	660	660	690	740	560	590	640	520	560	590	—	—	—
P7	175	185	195	170	180	195	195	205	220	165	175	190	155	165	180	—	—	—
	570	610	640	560	590	640	640	670	720	540	570	620	510	540	590	—	—	—
P8	170	180	190	165	175	190	190	200	215	160	170	185	150	160	170	—	—	—
	560	590	620	540	570	620	620	660	710	520	560	610	490	520	560	—	—	—
P11	175	180	195	170	180	190	195	200	215	165	170	185	155	160	175	—	—	—
	570	590	640	560	590	620	640	660	710	540	560	610	510	520	570	—	—	—
P12	140	145	165	135	145	160	160	165	185	130	135	155	120	125	145	—	—	—
	460	475	540	445	475	520	520	540	610	425	445	510	395	410	475	—	—	—
M1	—	—	—	175	180	195	190	195	210	165	175	185	155	165	180	—	—	—
	—	—	—	570	590	640	620	640	690	540	570	610	510	540	590	—	—	—
M2	—	—	—	160	170	180	175	185	195	150	160	175	145	150	165	—	—	—
	—	—	—	520	560	590	570	610	640	490	520	570	475	490	540	—	—	—
M3	—	—	—	140	150	165	155	165	180	130	140	155	125	135	150	—	—	—
	—	—	—	460	490	540	510	540	590	425	460	510	410	445	490	—	—	—
M4	—	—	—	120	125	145	135	140	160	150	160	180	105	110	130	—	—	—
	—	—	—	395	410	475	445	460	520	490	520	590	345	360	425	—	—	—
M5	—	—	—	105	115	130	120	130	145	150	160	180	90	100	115	—	—	—
	—	—	—	345	375	425	395	425	475	490	520	590	295	330	375	—	—	—
K1	200	205	220	—	—	—	—	—	—	165	175	190	—	—	—	—	—	—
	660	670	720	—	—	—	—	—	—	540	570	620	—	—	—	—	—	—
K2	190	200	210	—	—	—	—	—	—	160	165	180	—	—	—	—	—	—
	620	660	690	—	—	—	—	—	—	520	540	590	—	—	—	—	—	—
K3	180	185	200	—	—	—	—	—	—	145	155	165	—	—	—	—	—	—
	590	610	660	—	—	—	—	—	—	475	510	540	—	—	—	—	—	—
K4	175	180	195	—	—	—	—	—	—	140	150	165	—	—	—	—	—	—
	570	590	640	—	—	—	—	—	—	460	490	540	—	—	—	—	—	—
K5	135	145	160	—	—	—	—	—	—	105	115	125	—	—	—	—	—	—
	445	475	520	—	—	—	—	—	—	345	375	410	—	—	—	—	—	—
K6	165	175	185	—	—	—	—	—	—	130	140	155	—	—	—	—	—	—
	540	570	610	—	—	—	—	—	—	425	460	510	—	—	—	—	—	—
K7	155	165	180	—	—	—	—	—	—	125	130	145	—	—	—	—	—	—
	510	540	590	—	—	—	—	—	—	410	425	475	—	—	—	—	—	—
N1	—	—	—	—	—	—	—	—	—	—	—	—	305	315	330	320	330	345
	—	—	—	—	—	—	—	—	—	—	—	—	1000	1025	1075	1050	1075	1125
N2	—	—	—	—	—	—	—	—	—	—	—	—	235	245	260	255	260	275
	—	—	—	—	—	—	—	—	—	—	—	—	770	800	850	840	850	900
N3	—	—	—	—	—	—	—	—	—	—	—	—	205	215	230	225	230	245
	—	—	—	—	—	—	—	—	—	—	—	—	670	710	750	740	750	800
N11	—	—	—	—	—	—	—	—	—	—	—	—	215	225	240	235	240	255
	—	—	—	—	—	—	—	—	—	—	—	—	710	740	790	770	790	840
S1	—	—	—	65	70	90	80	90	105	55	65	80	50	55	75	—	—	—
	—	—	—	215	230	295	260	295	345	180	215	260	165	180	245	—	—	—
S2	—	—	—	50	55	70	65	75	90	46	50	65	41	46	60	—	—	—
	—	—	—	165	180	230	215	245	295	150	165	215	135	150	195	—	—	—
S3	—	—	—	45	49	65	55	65	80	40	45	55	36	41	50	—	—	—
	—	—	—	150	160	215	180	215	260	130	150	180	120	135	165	—	—	—
S11	—	—	—	90	95	115	105	115	130	80	90	105	75	80	100	—	—	—
	—	—	—	295	310	375	345	375	425	260	295	345	245	260	330	—	—	—
S12	—	—	—	65	70	85	80	85	105	55	60	80	50	55	70	—	—	—
	—	—	—	215	230	280	260	280	345	180	195	260	165	180	230	—	—	—
S13	—	—	—	35	39	50	46	50	65	32	36	45	29	32	41	—	—	—
	—	—	—	115	130	165	150	165	215	105	120	150	95	105	135	—	—	—
H5	—	—	—	—	—	—	—	—	—	50	55	70	45	50	60	—	—	—
	—	—	—	—	—	—	—	—	—	165	180	230	150	165	195	—	—	—
H8	—	—	—	—	—	—	—	—	—	55	60	75	—	—	—	—	—	—
	—	—	—	—	—	—	—	—	—	180	195	245	—	—	—	—	—	—
H11	—	—	—	—	—	—	—	—	—	65	75	90	—	—	—	—	—	—
	—	—	—	—	—	—	—	—	—	215	245	295	—	—	—	—	—	—
H12	—	—	—	—	—	—	125	130	150	95	105	120	85	90	110	—	—	—
	—	—	—	—	—	—	410	425	490	310	345	395	280	295	360	—	—	—

Square shoulder and slot milling cutters
Helical milling cutters
Face milling cutters
Disc milling cutters
High feed milling cutters
Copy milling cutters
Plunge milling cutters
Chamfer milling cutters
Spot facing cutters
Inserts

R215.39/49 - R220.49 – Metric

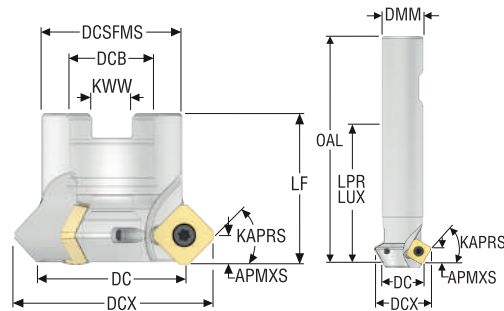
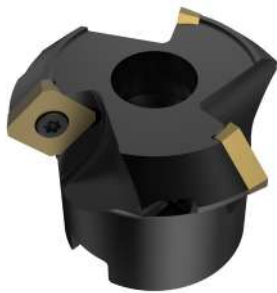

- For insert selection and cutting data recommendations, see page(s) 794-795
- For complete insert programme, see page(s) 861
- For ISO attribute explanation, see page 16

Designation	Item number	Type of mounting	KAPRS°	DC	DCX	APMXS	ZEFP	DCB	DCSFMS	OAL	LF	LPR	LUX	RPMX	Weight	Insert
				mm	mm	mm		mm	mm	mm	mm	mm	mm		kg	
R215.49-1609.3-06	75002621	Weldon	45,0	9,0	16,0	4,0	1	–	–	80,0	–	32,0	32,0	55600	0,2	SPMX0602
R215.49-2016.3-09	75002622	Weldon	45,0	16,0	26,0	5,0	2	–	–	110,0	–	60,0	60,0	27200	0,3	SPMX0903
R215.39-2020.3-09	75002620	Weldon	60,0	20,0	27,0	6,5	2	–	–	110,0	–	60,0	60,0	24300	0,3	SPMX0903
R215.49-3225.3-12	75002623	Weldon	45,0	25,0	39,0	7,0	2	–	–	130,0	–	70,0	70,0	16900	0,8	SPMX12T3
R220.49-0040-12	75012896	Arbor	45,0	40,0	54,0	7,0	3	22,0	37,0	–	40,0	–	–	13400	0,3	SPMX12T3

Spare Parts, included in delivery

For cutter	Arbor screw	Insert key	Insert screw
R215.49-06	–	H4B-T07P	C02205-T07P
R215.49-09	–	H4B-T09P	C03007-T09P
R215.39-09	–	H4B-T09P	C03007-T09P
R215.49-12	–	H4B-T15P	C03510-T15P
R220.49-12	220.17-691	H4B-T15P	C03508-T15P

Accessories

For cutter	Insert clamping torque	Torque key
R215.49-06	0.9NM	T00-07P09
R215.49-09	2.0NM	T00-09P20
R215.39-09	2.0NM	T00-09P20
R215.49-12	3.0NM	T00-15P30
R220.49-12	3.0NM	T00-15P30

Torque and fixed keys, see page 894

R215.39/49 - R220.49 – inch

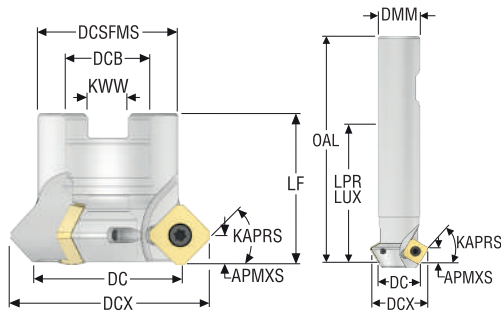

- For insert selection and cutting data recommendations, see page(s) 794-795
- For complete insert programme, see page(s) 861
- For ISO attribute explanation, see page 16

Designation	Item number	Type of mounting	KAPRS*	DC	DCX	APMXS	ZEFP	DCB	DCSFMS	OAL	LF	LPR	LUX	RPMX	Weight	Insert
				inch	inch	inch		inch	inch	inch	inch	inch	inch		lbs	
R215.49-00.375-3	00070083	Weld on	45,0	0.392	0.647	0.157	1	–	–	3.150	–	1.240	1.240	55600	0.440	SPMX0602
R215.49-00.625-3	00072168	Weld on	45,0	0.625	1.039	0.236	2	–	–	4.331	–	2.362	2.362	27200	0.660	SPMX0903
R215.39-00.750-3	00070080	Weld on	60,0	0.750	1.043	0.236	2	–	–	4.331	–	2.362	2.362	24300	0.660	SPMX0903
R215.49-01.00-3	00070081	Weld on	45,0	1.000	1.551	0.276	2	–	–	5.118	–	2.913	2.913	16900	1.100	SPMX12T3
R220.49-01.50	00070079	Arbor	45,0	1.500	2.047	0.276	3	0.750	1.575	–	1.575	–	–	13400	0.220	SPMX12T3

Spare Parts, included in delivery

For cutter	Arbor screw	Insert key	Insert screw
R215.49.00.375	–	H4B-T07P	C02205-T07P
R215.49.00.625	–	H4B-T09P	C03007-T09P
R215.39-00.750	–	H4B-T09P	C03007-T09P
R215.49.01.00	–	H4B-T15P	C03510-T15P
R220.49-01.50	220.17-695	H4B-T15P	C03508-T15P

Accessories

For cutter	Insert clamping torque	Torque key
R215.49.00.375	8.0IN.LBS	T00-07P09
R215.49.00.625	17.7IN.LBS	T00-09P20
R215.39-00.750	17.7IN.LBS	T00-09P20
R215.49.01.00	26.6IN.LBS	T00-15P30
R220.49-01.50	26.6IN.LBS	T00-15P30

Torque and fixed keys, see page 894

Square shoulder and slot milling cutters
Helical milling cutters
Face milling cutters
Disc milling cutters
High feed milling cutters
Copy milling cutters
Plunge milling cutters
Chamfer milling cutters
Spot facing cutters
Inserts

R217/220.49-SPMX06/09/12 – Insert selection – mm/Inch

SMG		a _p	f _z		
			50%	30%	10%
P1	SPMX 06/09/12-75 F40M	4,0	0,28	0,32	0,50
		0.16	0.011	0.013	0.020
P2	SPMX 06/09/12-75 F40M	4,0	0,30	0,32	0,50
		0.16	0.012	0.013	0.020
P3	SPMX 06/09/12-75 F40M	4,0	0,28	0,30	0,48
		0.16	0.011	0.012	0.019
P4	SPMX 06/09/12-75 F40M	4,0	0,26	0,30	0,48
		0.16	0.010	0.012	0.019
P5	SPMX 06/09/12-75 F40M	4,0	0,26	0,30	0,46
		0.16	0.010	0.012	0.018
P6	SPMX 06/09/12-75 F40M	4,0	0,26	0,30	0,46
		0.16	0.010	0.012	0.018
P7	SPMX 06/09/12-75 F40M	4,0	0,26	0,30	0,46
		0.16	0.010	0.012	0.018
P8	SPMX 06/09/12-75 F40M	4,0	0,28	0,30	0,48
		0.16	0.011	0.012	0.019
P11	SPMX 06/09/12-75 F40M	4,0	0,26	0,30	0,46
		0.16	0.010	0.012	0.018
P12	SPMX 06/09/12-75 F40M	3,5	0,18	0,20	0,32
		0.14	0.0070	0.0080	0.013
M1	SPMX 06/09/12-75 F40M	4,0	0,30	0,32	0,50
		0.16	0.012	0.013	0.020
M2	SPMX 06/09/12-75 F40M	4,0	0,26	0,30	0,46
		0.16	0.010	0.012	0.018
M3	SPMX 06/09/12-75 F40M	3,5	0,22	0,24	0,38
		0.14	0.0085	0.0095	0.015
M4	SPMX 06/09/12-75 F40M	2,5	0,20	0,22	0,32
		0.10	0.0080	0.0085	0.013
M5	SPMX 06/09/12-75 F40M	2,5	0,20	0,22	0,32
		0.10	0.0080	0.0085	0.013
K1	SPMX 06/09/12-75 F40M	4,0	0,30	0,32	0,50
		0.16	0.012	0.013	0.020
K2	SPMX 06/09/12-75 F40M	4,0	0,26	0,30	0,46
		0.16	0.010	0.012	0.018
K3	SPMX 06/09/12-75 F40M	4,0	0,26	0,30	0,46
		0.16	0.010	0.012	0.018
K4	SPMX 06/09/12-75 F40M	4,0	0,26	0,30	0,46
		0.16	0.010	0.012	0.018
K5	SPMX 06/09/12-75 F40M	4,0	0,24	0,26	0,42
		0.16	0.0095	0.010	0.017
K6	SPMX 06/09/12-75 F40M	4,0	0,26	0,30	0,46
		0.16	0.010	0.012	0.018
K7	SPMX 06/09/12-75 F40M	4,0	0,24	0,26	0,42
		0.16	0.0095	0.010	0.017
N1	SPMX 06/09/12-75 F40M	4,0	0,36	0,42	0,65
		0.16	0.014	0.017	0.026
N2	SPMX 06/09/12-75 F40M	4,0	0,36	0,42	0,65
		0.16	0.014	0.017	0.026
N3	SPMX 06/09/12-75 F40M	4,0	0,36	0,42	0,65
		0.16	0.014	0.017	0.026
N11	SPMX 06/09/12-75 F40M	4,0	0,36	0,42	0,65
		0.16	0.014	0.017	0.026
S1	SPMX 06/09/12-75 F40M	2,5	0,20	0,22	0,32
		0.10	0.0080	0.0085	0.013
S2	SPMX 06/09/12-75 F40M	2,5	0,20	0,22	0,32
		0.10	0.0080	0.0085	0.013
S3	SPMX 06/09/12-75 F40M	2,5	0,19	0,20	0,30
		0.10	0.0075	0.0080	0.012
S11	SPMX 06/09/12-75 F40M	3,0	0,22	0,25	0,38
		0.12	0.0085	0.010	0.015
S12	SPMX 06/09/12-75 F40M	3,0	0,22	0,25	0,38
		0.12	0.0085	0.010	0.015
S13	SPMX 06/09/12-75 F40M	2,5	0,20	0,22	0,32
		0.10	0.0080	0.0085	0.013

SMG = Seco material group
 f_z = mm/tooth (in/tooth), v_c = m/min (sf/min), a_p/DC = %
 All cutting data are start values

R217/220.49-SPMX06/09/12 – Cutting data $v_c = (m/min)/(sf/min)$

SMG	F40M		
	50%	30%	10%
P1	275	300	355
	900	980	1175
P2	265	290	345
	870	950	1125
P3	230	255	300
	750	840	980
P4	205	225	265
	670	740	870
P5	195	220	260
	640	720	850
P6	220	250	290
	720	820	950
P7	210	235	275
	690	770	900
P8	195	215	255
	640	710	840
P11	200	225	265
	660	740	870
P12	135	145	175
	445	475	570
M1	215	235	280
	710	770	920
M2	175	200	230
	570	660	750
M3	145	155	190
	475	510	620
M4	110	120	145
	360	395	475
M5	90	100	120
	295	330	395
K1	210	230	275
	690	750	900
K2	185	210	245
	610	690	800
K3	160	175	205
	520	570	670
K4	150	170	200
	490	560	660
K5	90	105	120
	295	345	395
K6	135	150	175
	445	490	570
K7	120	130	155
	395	425	510
N1	1525	1700	2000
	5000	5575	6550
N2	620	690	810
	2025	2275	2650
N3	410	460	540
	1350	1500	1775
N11	470	520	620
	1550	1700	2025
S1	50	55	70
	165	180	230
S2	41	46	55
	135	150	180
S3	36	40	48
	120	130	155
S11	70	80	95
	230	260	310
S12	50	55	65
	165	180	215
S13	29	32	38
	95	105	125

Square shoulder and slot milling cutters
Helical milling cutters
Face milling cutters
Disc milling cutters
High feed milling cutters
Copy milling cutters
Plunge milling cutters
Chamfer milling cutters
Spot facing cutters
Inserts

Square shoulder and slot milling cutters

Helical milling cutters

Face milling cutters

Disc milling cutters

High feed milling cutters

Copy milling cutters

Plunge milling cutters

Chamfer milling cutters

Spot facing cutters

Inserts



R417.19 SPOT FACING

Seco spot facing mills are cutters for milling spot faces of blind and countersunk holes. Key benefits include smooth cutting, reduced spindle bearing wear via a highly balanced tool and high security through a center-lock clamping system, all engineered in an economical solution.

- Strong SPMX inserts, available in many different grades for most workpiece materials
- Inserts with 4 cutting edges
- Cutter range metric, Ø 18-42mm (Imperial Ø 0.625-1.620 inch)

R417.19-SPMX – Metric

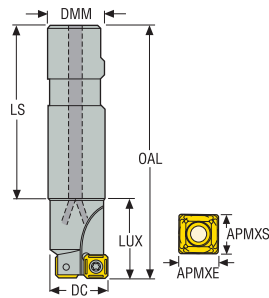

- For insert selection and cutting data recommendations, see page(s) 799-801
- For complete insert programme, see page(s) 861
- For ISO attribute explanation, see page 16

Designation	Item number	Type of mounting	DC	ZFP	ZNP	APMXS	APMXE	DMM	LUX	LS	OAL	RPM	Weight	Centre insert	Periph insert
														SPMX	SPMX
			mm			mm	mm	mm	mm	mm	mm		kg		
R417.19-2018.3-06A	00070768	Weld on	18,0	1	2	5,0	9,0	20,0	20,0	87,0	110,0	39200	0,2	0602AP (1)	060204 (1)
R417.19-2020.3-07A	00012939	Weld on	20,0	1	2	7,0	10,0	20,0	28,0	92,0	120,0	26200	0,3	0703AP (1)	070304 (1)
R417.19-2022.3-07A	02201611	Weld on	22,0	1	2	7,0	11,0	20,0	70,0	92,0	120,0	25000	0,3	0703AP (1)	070304 (1)
R417.19-2524.3-07A	02201606	Weld on	24,0	1	2	7,0	12,0	25,0	31,0	98,0	130,0	24000	0,5	0703AP (1)	070304 (1)
R417.19-2526.3-09A	00070772	Weld on	26,0	1	2	8,0	13,0	25,0	74,0	98,0	130,0	21200	0,4	0903AP (1)	090304 (1)
R417.19-2530.3-09A	02201604	Weld on	30,0	1	2	8,0	15,0	25,0	74,0	90,0	130,0	19800	0,5	0903AP (1)	090304 (1)
R417.19-3232.3-09A	02201607	Weld on	32,0	1	2	8,0	16,0	32,0	38,0	90,0	130,0	19200	0,7	0903AP (1)	090304 (1)
R417.19-3236.3-12A	02201608	Weld on	36,0	1	2	11,0	18,0	32,0	70,0	90,0	130,0	12600	0,7	12T3AP (1)	12T308 (1)
R417.19-3238.3-12A	02448870	Weld on	38,0	1	2	11,0	19,0	32,0	70,0	90,0	130,0	12300	0,7	12T3AP (1)	12T308 (1)
R417.19-3242.3-12A	02448871	Weld on	42,0	1	2	11,0	21,0	32,0	70,0	90,0	130,0	12000	0,8	12T3AP (1)	12T308 (1)

Spare Parts, included in delivery

For cutter	Insert key	Insert screw
R417.19-06A	H4B-T07P	C02205-T07P
R417.19-07A	H4B-T07P	C02506-T07P
R417.19-09A	H4B-T09P	C03007-T09P
R417.19-12A	H4B-T15P	C03510-T15P

Accessories

For cutter	Insert clamping torque	Torque key
R417.19-06A	0.9NM	T00-07P09
R417.19-07A	0.9NM	T00-07P09
R417.19-09A	2.0NM	T00-09P20
R417.19-12A	3.0NM	T00-15P30

Torque and fixed keys, see page 894

Square shoulder and slot milling cutters
Helical milling cutters
Face milling cutters
Disc milling cutters
High feed milling cutters
Plunge milling cutters
Chamfer milling cutters
Spot facing cutters
Inserts

R417.19-SPMX – inch

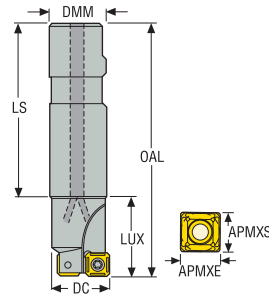

- For insert selection and cutting data recommendations, see page(s) 799-801
- For complete insert programme, see page(s) 861
- For ISO attribute explanation, see page 16

Designation	Item number	Type of mounting	DC	ZEFP	ZNP	APMXS	APMXE	DMM	LUX	LS	OAL	RPMX	Weight	Centre insert SPMX	Periph insert SPMX
			inch			inch	inch	inch	inch	inch	inch		lbs		
R417.19-00.62-3	75072193	Weldon	0.625	1	2	0.197	0.276	0.750	0.787	2.559	3.740	49100	0.660	0602AP (1)	060204 (1)
R417.19-00.750-3	75072183	Weldon	0.750	1	2	0.197	0.276	0.750	1.181	3.150	4.331	32500	0.660	0602AP (1)	060204 (1)
R417.19-00.81-3	75054856	Weldon	0.812	1	2	0.276	0.276	0.750	2.717	3.346	4.724	26200	0.660	0703AP (1)	070304 (1)
R417.19-01.00-3	75072173	Weldon	1.000	1	2	0.315	0.472	1.000	1.575	3.543	5.118	22500	1.320	0903AP (1)	090304 (1)
R417.19-01.18-3	75054857	Weldon	1.181	1	2	0.315	0.472	1.000	2.874	3.543	5.118	21200	1.320	0903AP (1)	090304 (1)
R417.19-01.37-3	75054858	Weldon	1.375	1	2	0.433	0.472	1.250	2.874	3.543	5.118	12600	1.980	12T3AP (1)	12T308 (1)
R417.19-01.62-3	75054859	Weldon	1.620	1	2	0.433	0.472	1.250	2.874	3.543	5.118	12000	1.980	12T3AP (1)	12T308 (1)

Spare Parts, included in delivery

For cutter	Insert key	Insert screw
R417.19-00.625-00.750	H4B-T07P	C02205-T07P
R417.19-00.812	H4B-T07P	C02506-T07P
R417.19-01.00-01.18	H4B-T09P	C03007-T09P
R417.19-01.37-01.62	H4B-T15P	C03510-T15P

Accessories

For cutter	Insert clamping torque	Torque key
R417.19-00.625-00.750	8.0IN.LBS	T00-07P09
R417.19-00.812	8.0IN.LBS	T00-07P09
R417.19-01.00-01.18	17.7IN.LBS	T00-09P20
R417.19-01.37-01.62	26.6IN.LBS	T00-15P30

Torque and fixed keys, see page 894

R417.19-SPMX06/07 – Insert selection – mm/Inch

SMG		f _z		
		100%	30%	10%
P1	SPMX 06/07-75 F40M	0,080	0,085	0,13
		0.0032	0.0034	0.0050
P2	SPMX 06/07-75 F40M	0,080	0,090	0,13
		0.0032	0.0036	0.0050
P3	SPMX 06/07-75 F40M	0,075	0,085	0,13
		0.0030	0.0034	0.0050
P4	SPMX 06/07-75 F40M	0,075	0,080	0,12
		0.0030	0.0032	0.0048
P5	SPMX 06/07-75 F40M	0,075	0,080	0,12
		0.0030	0.0032	0.0048
P6	SPMX 06/07-75 F40M	0,070	0,080	0,12
		0.0028	0.0032	0.0048
P7	SPMX 06/07-75 F40M	0,070	0,080	0,12
		0.0028	0.0032	0.0048
P8	SPMX 06/07-75 F40M	0,075	0,085	0,13
		0.0030	0.0034	0.0050
P11	SPMX 06/07-75 F40M	0,070	0,080	0,12
		0.0028	0.0032	0.0048
P12	SPMX 06/07-75 F40M	0,050	0,055	0,085
		0.0020	0.0022	0.0034
M1	SPMX 06/07-75 F40M	0,080	0,090	0,13
		0.0032	0.0036	0.0050
M2	SPMX 06/07-75 F40M	0,075	0,080	0,12
		0.0030	0.0032	0.0048
M3	SPMX 06/07-75 F40M	0,060	0,065	0,10
		0.0024	0.0026	0.0040
M4	SPMX 06/07-75 F40M	0,050	0,055	0,085
		0.0020	0.0022	0.0034
M5	SPMX 06/07-75 F40M	0,050	0,055	0,085
		0.0020	0.0022	0.0034
K1	SPMX 06/07-75 F40M	0,080	0,090	0,13
		0.0032	0.0036	0.0050
K2	SPMX 06/07-75 F40M	0,075	0,080	0,12
		0.0030	0.0032	0.0048
K3	SPMX 06/07-75 F40M	0,075	0,080	0,12
		0.0030	0.0032	0.0048
K4	SPMX 06/07-75 F40M	0,075	0,080	0,12
		0.0030	0.0032	0.0048
K5	SPMX 06/07-75 F40M	0,065	0,070	0,11
		0.0026	0.0028	0.0044
K6	SPMX 06/07-75 F40M	0,075	0,080	0,12
		0.0030	0.0032	0.0048
K7	SPMX 06/07-75 F40M	0,065	0,070	0,11
		0.0026	0.0028	0.0044

SMG = Seco material group
 f_z = mm/tooth (in/tooth), v_c = m/min (sf/min), a_e/DC = %
 All cutting data are start values

Square shoulder and slot milling cutters
 Helical milling cutters
 Face milling cutters
 Disc milling cutters
 High feed milling cutters
 Copy milling cutters
 Plunge milling cutters
 Chamfer milling cutters
 Spot facing cutters
 Inserts

R417.19-SPMX09/12 – Insert selection – mm/Inch

SMG		f _z		
		100%	30%	10%
P1-P12	P1 SPMX 09/12-75 F40M	0,12	0,13	0,20
		0,0048	0,0050	0,0080
	P2 SPMX 09/12-75 F40M	0,12	0,13	0,20
		0,0048	0,0050	0,0080
	P3 SPMX 09/12-75 F40M	0,11	0,12	0,19
		0,0044	0,0048	0,0075
	P4 SPMX 09/12-75 F40M	0,11	0,12	0,19
		0,0044	0,0048	0,0075
	P5 SPMX 09/12-75 F40M	0,11	0,12	0,18
		0,0044	0,0048	0,0070
	P6 SPMX 09/12-75 F40M	0,11	0,12	0,18
		0,0044	0,0048	0,0070
P7 SPMX 09/12-75 F40M	0,11	0,12	0,18	
	0,0044	0,0048	0,0070	
P8 SPMX 09/12-75 F40M	0,11	0,12	0,19	
	0,0044	0,0048	0,0075	
P11 SPMX 09/12-75 F40M	0,11	0,12	0,18	
	0,0044	0,0048	0,0070	
P12 SPMX 09/12-75 F40M	0,075	0,080	0,12	
	0,0030	0,0032	0,0048	
M1-M5	M1 SPMX 09/12-75 F40M	0,12	0,13	0,20
		0,0048	0,0050	0,0080
	M2 SPMX 09/12-75 F40M	0,11	0,12	0,18
		0,0044	0,0048	0,0070
	M3 SPMX 09/12-75 F40M	0,085	0,095	0,15
0,0034		0,0038	0,0060	
M4 SPMX 09/12-75 F40M	0,075	0,085	0,13	
	0,0030	0,0034	0,0050	
M5 SPMX 09/12-75 F40M	0,075	0,085	0,13	
	0,0030	0,0034	0,0050	
K1-K7	K1 SPMX 09/12-75 F40M	0,12	0,13	0,20
		0,0048	0,0050	0,0080
	K2 SPMX 09/12-75 F40M	0,11	0,12	0,18
		0,0044	0,0048	0,0070
	K3 SPMX 09/12-75 F40M	0,11	0,12	0,18
		0,0044	0,0048	0,0070
	K4 SPMX 09/12-75 F40M	0,11	0,12	0,18
0,0044		0,0048	0,0070	
K5 SPMX 09/12-75 F40M	0,10	0,11	0,16	
	0,0040	0,0044	0,0065	
K6 SPMX 09/12-75 F40M	0,11	0,12	0,18	
	0,0044	0,0048	0,0070	
K7 SPMX 09/12-75 F40M	0,10	0,11	0,16	
	0,0040	0,0044	0,0065	

SMG = Seco material group
 f_z = mm/tooth (in/tooth), v_c = m/min (sf/min), a_p/DC = %
 All cutting data are start values

R417.19-SPMX06/07/09/12 – Cutting data $v_c = (m/min)/(sf/min)$

SMG	F40M		
	100%	30%	10%
P1	195	225	240
	640	740	790
P2	195	220	240
	640	720	790
P3	180	205	225
	590	670	740
P4	170	195	215
	560	640	710
P5	165	190	210
	540	620	690
P6	175	205	220
	570	670	720
P7	170	195	215
	560	640	710
P8	165	190	205
	540	620	670
P11	165	195	210
	540	640	690
P12	120	150	165
	395	490	540
M1	170	200	215
	560	660	710
M2	150	180	200
	490	590	660
M3	130	160	175
	425	520	570
M4	105	135	150
	345	445	490
M5	90	115	130
	295	375	425
K1	170	200	215
	560	660	710
K2	160	185	205
	520	610	670
K3	140	170	185
	460	560	610
K4	135	165	180
	445	540	590
K5	90	115	130
	295	375	425
K6	125	150	170
	410	490	560
K7	110	140	155
	360	460	510

Square shoulder and slot milling cutters
 Helical milling cutters
 Face milling cutters
 Disc milling cutters
 High feed milling cutters
 Copy milling cutters
 Plunge milling cutters
 Chamfer milling cutters
 Spot facing cutters
 Inserts

Introduction

Polycrystalline Cubic Boron Nitride (PCBN) is a material which is sintered at extremely high pressure and high temperature into a wear-resistant material with properties close to those of diamond. Due to the hot hardness, oxidation resistance and fracture toughness of the material, inserts made of PCBN have excellent edge strength and long tool life when machining hard ferrous materials and pearlitic grey cast iron.

Secomax™ PCBN inserts are suitable for machining:

- Hardened steel (including hard-facing alloys)
- Pearlitic grey cast iron
- Chilled and white cast iron
- Manganese steel
- Cemented carbide
- Powder Metallurgy (PM) alloys

For more information including a comprehensive guide to understanding and applying PCBN successfully, please ask your sales representative for the Secomax™ PCBN, Technical Guide (available in English).

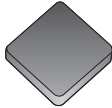
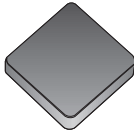
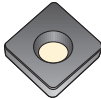
Selection of insert type	
	<ul style="list-style-type: none"> • Solid insert • According to the geometry, two sides can be used. • Grades: CBN200, CBN300, CBN300P, CBN500, CBN600
	<ul style="list-style-type: none"> • CBN layer sintered on to carbide. One side is usable. • Grades: CBN200
	

Cutters for PCBN inserts

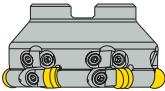
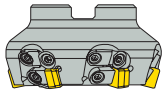
Face milling cutter type R217/220.70	Face milling cutter type 220.74
	
<ul style="list-style-type: none"> • Cutter especially developed for CBN inserts, 2 insert sizes. • Maximum cutting depth 3 mm DC = 20-63 mm and maximum cutting depth 4,5 mm DC = 63-200 mm (DC = 125-200 mm fitted with wiper insert). • Inserts for finishing: RNGN060300E (E = honed) RNGN/RNMN090300E • Inserts for roughing: RNGN/RNMN060300S (S = chamfered and honed) RNGN/RNMN090300S • Wiper insert: SNEX120312ZZ • The relation between cutting depth and number of usable cutting edges (per side). 	<ul style="list-style-type: none"> • Cutter especially developed for CBN inserts, maximum cutting depth 8,0 mm D = 63-200 mm. (D = 125-200 mm fitted with wiper insert). • Inserts for finishing: SNEN0903ENE-M06 (E = honed) SNMN090308E SNMN090312E • Inserts for roughing: SNEN0903ENS-M08 (S = chamfered and honed) SNMN090308S SNMN090312S SNMN090316S • Wiper insert: SNEX120312ZZ

D.O.C a_p (mm)	D.O.C a_p (inch)	RN.. 060300	RN.. 090300	D.O.C a_p (mm)	D.O.C a_p (inch)	RN.. 060300	RNMN 090300
0,1	.004	20	24	1,2	.048	5	7
0,15	.006	16	20	1,5	.060	5	6
0,2	.008	14	17	1,8	.072	4	5
0,25	.010	12	15	2,0	.080	4	5
0,3	.012	11	14	2,5	.100	3	4
0,4	.016	10	12	3,0	.120	3	4
0,5	.020	8	10	3,5	.140	–	4
0,8	.032	7	8	4,0	.160	–	3
1,0	.040	6	7	4,5	.200	–	–

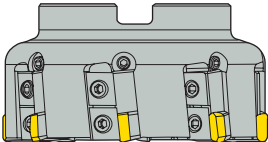
Square shoulder and slot milling cutter type R220.68

<ul style="list-style-type: none"> • Insert with corner chamfer for finishing operations: TNGN1604PNE • Insert with corner chamfer for roughing operations: TNGN1604PNS • Insert with corner radius for roughing operations: TNGN1604PRS

Inserts for standard milling cutters

Face milling cutters	Face milling cutters	Face milling cutters	Face milling cutters
 <ul style="list-style-type: none"> • For roughing • SEEX09T3AFTN-D09-LF • SEEX1204AFTN-D16-LF • R220.53 	 <ul style="list-style-type: none"> • For roughing • ONEW05 • Octomill R217/220.48 	 <ul style="list-style-type: none"> • For roughing • SEEN1203AFTN-D16 • R220.13 	 <ul style="list-style-type: none"> • For finishing • SEEX1203AETN-MD13-LF • R220.30
Wiper insert for high quality surface finish	Disc milling cutter	High feed milling cutter	Copy milling cutter
 <ul style="list-style-type: none"> • SEEX1204ZZTN-D16-LF 	 <ul style="list-style-type: none"> • RDHW0803M0S-01030-LF • R335.25/R335.18 	 <ul style="list-style-type: none"> • 218.19-100T-MD08-LF 	 <ul style="list-style-type: none"> • RDHW0803M0S-01030-LF • R217/220.29

Cutting speed recommendations are in the cutting data table.
Feed rate recommendations are in the cutting data table.
Formulae for cutting data calculation are on page 884

PCBN, Finishing $a_p < 0,5 \text{ mm/Inch}$

SMG	CBN200		CBN300		CBN500	
	v_c	f_z	v_c	f_z	v_c	f_z
K1	700 — 1900	0,050 — 0,20	700 — 1700	0,050 — 0,20	700 — 1700	0,050 — 0,20
H3	110 — 350	0,050 — 0,20	—	—	—	—
H5	200 — 320	0,050 — 0,20	—	—	—	—
H7	200 — 300	0,050 — 0,20	—	—	—	—
H8	170 — 250	0,050 — 0,20	—	—	—	—
H11	—	—	—	—	—	—
H21	120 — 220	0,050 — 0,20	—	—	130 — 230	0,050 — 0,20
H31	120 — 220	0,050 — 0,20	—	—	100 — 270	0,050 — 0,20
PM1	180 — 400	0,050 — 0,20	—	—	—	—
PM2	150 — 300	0,050 — 0,20	—	—	—	—
PM3	—	—	—	—	—	—
HF1	—	—	—	—	—	—
HF2	—	—	—	—	—	—

PCBN, Roughing $a_p 0,5-3,0 \text{ mm/Inch}$

SMG	CBN200		CBN300		CBN500	
	v_c	f_z	v_c	f_z	v_c	f_z
K1	700 — 1700	0,050 — 0,20	700 — 1700	0,050 — 0,20	700 — 1700	0,050 — 0,20
H3	—	—	—	—	—	—
H5	—	—	—	—	—	—
H7	—	—	—	—	—	—
H8	—	—	—	—	—	—
H11	—	—	—	—	—	—
H21	120 — 220	0,050 — 0,20	—	—	130 — 230	0,050 — 0,20
H31	120 — 220	0,050 — 0,20	—	—	100 — 270	0,050 — 0,20
PM1	180 — 400	0,050 — 0,20	—	—	—	—
PM2	150 — 300	0,050 — 0,20	—	—	—	—
PM3	—	—	—	—	—	—
HF1	150 — 240	0,050 — 0,20	—	—	150 — 250	0,050 — 0,20
HF2	120 — 300	0,050 — 0,20	—	—	120 — 300	0,050 — 0,20

220.70-06/09 – Metric

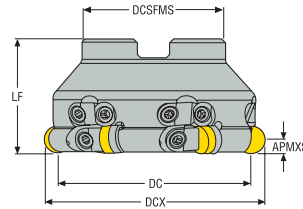

- For insert selection and cutting data recommendations, see page(s) 805
- For complete insert programme, see page(s) 813
- For ISO attribute explanation, see page 16

Designation	Item number	Type of mounting	DC	ZEFP	APMXS	DCX	DCB	DCSFMS	LF	RPMX	Weight	Insert
			mm		mm	mm	mm	mm	mm		kg	
R220.70-0063-09-6	00023749	Arbor	63,0	6	4,5	72,5	22,0	47,0	40,0	10200	0,7	RN..09
R220.70-0080-09-6	00023750	Arbor	80,0	6	4,5	89,5	27,0	62,0	50,0	9100	1,3	RN..09
R220.70-0100-09-8	00023751	Arbor	100,0	8	4,5	109,5	32,0	77,0	50,0	8100	2,0	RN..09
R220.70-8160-09-10	00023753	Arbor	160,0	10	4,5	169,5	40,0	90,0	63,0	6400	5,6	RN..09/SNEX12*

Spare Parts, included in delivery

For cutter	Anvil	Anvil screw	Arbor screw	Gauge screw	Insert shim	Insert wedge	Setting gauge	Setting key	Setting wedge	Shim screw	Wedge	Wedge screw
R220.70-0063	-	-	220.17-692	LD6019-T15P	117.10-620	-	AS6011F	T15P-4ST	-	174.10-652-T07P	CW0608M	LD6018T-T15P
R220.70-0080	-	-	-	LD6019-T15P	117.10-620	-	AS6011F	T15P-4ST	-	174.10-652-T07P	CW0608M	LD6018T-T15P
R220.70-0100	-	-	-	LD6019-T15P	117.10-620	-	AS6011F	T15P-4ST	-	174.10-652-T07P	CW0608M	LD6018T-T15P
R220.70-8160	268-621	F94009-T09P	-	LD6019-T15P	117.10-620	CW0608S	AS6011F	T15P-4ST	AS6011	174.10-652-T07P	CW0608M	LD6018T-T15P

Accessories

For cutter	Arbor screw	Insert clamping torque	Shim key	Torque key
R220.70-0063-0100	-	3.5NM	H4B-T07P	T00-15P35
R220.70-8160	MC6S12X40	3.5NM	H4B-T07P	T00-15P35

Torque and fixed keys, see page 894

220.70-06/09 – inch

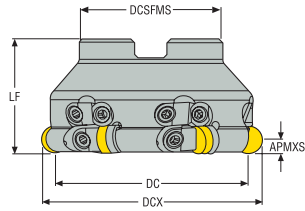

- For insert selection and cutting data recommendations, see page(s) 805
- For complete insert programme, see page(s) 813
- For ISO attribute explanation, see page 16

Designation	Item number	Type of mounting	DC	ZEFP	APMXS	DCX	DCB	DCSFMS	LF	RPMX	Weight	Insert
			inch		inch	inch	inch	inch	inch		lbs	
R220.70-03.00-09-6	00059852	Arbor	3.150	6	0.177	3.520	1.000	3.543	2.382	15900	3.750	RN..09

Spare Parts, included in delivery

For cutter	Gauge screw	Insert shim	Setting gauge	Setting key	Shim screw	Wedge	Wedge screw
R220.70-03.00	LD6019-T15P	117.10-620	AS6011F	T15P-4ST	174.10-652-T07P	CW0608M	LD6018T-T15P

Accessories

For cutter	Insert clamping torque	Shim key	Torque key
R220.70-03.00	31.0IN.LBS	H4B-T07P	T00-15P35

Torque and fixed keys, see page 894

220.74-09 – Metric

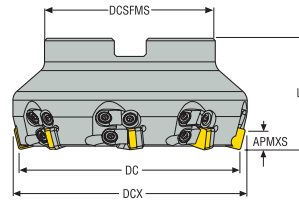

- For insert selection and cutting data recommendations, see page(s) 805
- For complete insert programme, see page(s) 815-814
- For ISO attribute explanation, see page 16

Designation	Item number	Type of mounting	DC	ZEPF	APMXS	KAPRS°	DCX	DCB	DCSFMS	LF	RPMX	Weight	Insert
			mm		mm		mm	mm	mm	mm		kg	
R220.74-0063-09-6	00023743	Arbor	63,0	6	8,0	75,0	65,3	22,0	47,0	40,0	10200	0,7	SN..09..
R220.74-0080-09-6	00023744	Arbor	80,0	6	8,0	75,0	82,3	27,0	62,0	50,0	9100	1,4	SN..09..
R220.74-0100-09-8	00023745	Arbor	100,0	8	8,0	75,0	102,3	32,0	77,0	50,0	8100	2,0	SN..09..
R220.74-8160-09-10	00023747	Arbor	160,0	10	8,0	75,0	162,3	40,0	90,0	63,0	6400	6,3	SN..09/SNEX12*
R220.74-8200-09-12	00023748	Arbor	200,0	12	8,0	75,0	202,3	60,0	130,0	63,0	5700	8,9	SN..09/SNEX12*

Spare Parts, included in delivery

For cutter	Anvil	Anvil screw	Arbor screw	Insert shim	Setting gauge	Setting key	Setting screw	Shim screw	Wedge	Wedge screw
R220.74-0063	-	-	220.17-692	174.10-620	AS6011	T15P-4ST	LD6019-T15P	174.10-652-T07P	CW0608M	LD6018T-T15P
R220.74-0080	-	-	-	174.10-620	AS6011	T15P-4ST	LD6019-T15P	174.10-652-T07P	CW0608M	LD6018T-T15P
R220.74-0100	-	-	-	174.10-620	AS6011	T15P-4ST	LD6019-T15P	174.10-652-T07P	CW0608M	LD6018T-T15P
R220.74-8160	-	-	-	174.10-620	AS6011	T15P-4ST	LD6019-T15P	174.10-652-T07P	CW0608M	LD6018T-T15P
R220.74-8200	268-621	F94009-T09P	-	174.10-620	AS6011	T15P-4ST	LD6019-T15P	174.10-652-T07P	CW0608M	LD6018T-T15P

Accessories

For cutter	Anvil Key	Arbor screw	Insert clamping torque	Shim key	Torque key
R220.74-0063-0100	-	-	3.5NM	H4B-T07P	T00-15P35
R220.74-8160	H4B-T09P	MC6S12X40	3.5NM	H4B-T07P	T00-15P35
R220.74-8200	H4B-T09P	-	3.5NM	H4B-T07P	T00-15P35

Torque and fixed keys, see page 894

220.74-09 – inch

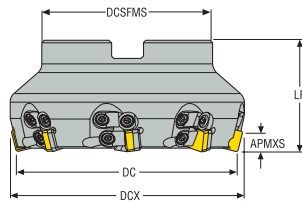

- For insert selection and cutting data recommendations, see page(s) 805
- For complete insert programme, see page(s) 815-814
- For ISO attribute explanation, see page 16

Designation	Item number	Type of mounting	DC	ZEFP	APMXS	KAPRS°	DCX	DCB	DCSFMS	LF	RPMX	Weight	Insert
			inch		inch		inch	inch	inch	inch		lbs	
R220.74-04.00-09-8	00059859	Arbor	4.028	8	0.315	75,0	4.028	1.500	3.543	2.374	8100	6.390	SN..09
R220.74-05.00-09-8	00059860	Arbor	5.008	8	0.315	75,0	5.012	1.500	3.543	2.374	7200	8.600	SN..09 / SNEX12*
R220.74-06.00-09-10	00059861	Arbor	6.299	10	0.315	75,0	6.390	2.000	4.331	2.374	6400	13.670	SN..09 / SNEX12*

Spare Parts, included in delivery

For cutter	Anvil	Anvil screw	Insert shim	Setting gauge	Setting key	Setting screw	Shim screw	Wedge	Wedge screw
R220.74-04.00	-	-	174.10-620	AS6011	T15P-4ST	LD6019-T15P	174.10-652-T07P	CW0608M	LD6018T-T15P
R220.74-05.00	268-621	F94009-T09P	174.10-620	AS6011	1/4HEX-T15PX50	LD6019-T15P	174.10-652-T07P	CW0608M	LD6018T-T15P
R220.74-06.00	268-621	F94009-T09P	174.10-620	AS6011	T15P-4ST	LD6019-T15P	174.10-652-T07P	CW0608M	LD6018T-T15P

Accessories

For cutter	Adjustable Torque key	Anvil Key	Arbor screw	Insert clamping torque	Shim key	Torque key
R220.74-04.00	-	-	-	31.0IN.LBS	H4B-T07P	T00-15P35
R220.74-05.00	1/4HEX-S-HANDLE-0.8-5.0NM	1/4HEX-T09PX50	-	31.0IN.LBS	1/4HEX-T07PX50	T00-15P35
R220.74-06.00	-	H4B-T09P	58215080	31.0IN.LBS	H4B-T07P	T00-15P35

Torque and fixed keys, see page 894

R220.68-T16C – Metric

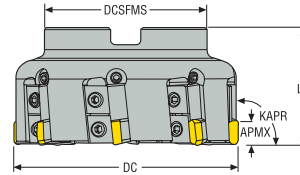

- For insert selection and cutting data recommendations, see page(s) 805
- For complete insert programme, see page(s) 816
- For ISO attribute explanation, see page 16

Designation	Item number	Type of mounting	DC	ZEFP	APMXS	KAPRS°	DCB	DCSFMS	LF	RPMX	Weight	Insert
			mm		mm		mm	mm	mm		kg	
R220.68-0063-T11C-4	02600204	Arbor	63,0	4	5,0	90,0	22,0	47,0	63,0	20600	1,1	TNGN1103..
R220.68-0080-T11C-5	02600206	Arbor	80,0	5	5,0	90,0	27,0	62,0	63,0	16700	1,7	TNGN1103..
R220.68-0100-T11C-6	02600207	Arbor	100,0	6	5,0	90,0	32,0	77,0	63,0	13400	2,7	TNGN1103..
R220.68-0125-T11C-8	02600208	Arbor	125,0	8	5,0	90,0	40,0	90,0	63,0	10400	3,4	TNGN1103..
R220.68-8160-T11C-10	02600209	Arbor	160,0	10	5,0	90,0	40,0	90,0	63,0	8400	5,6	TNGN1103..
R220.68-0063-T16C-4	00063814	Arbor	63,0	4	14,0	90,0	22,0	47,0	63,0	12000	1,1	TNGN1604..
R220.68-0080-T16C-5	00063812	Arbor	80,0	5	14,0	90,0	27,0	62,0	63,0	9600	1,7	TNGN1604..
R220.68-0125-T16C-8	00063815	Arbor	125,0	8	14,0	90,0	40,0	90,0	63,0	6100	3,4	TNGN1604..
R220.68-8160-T16C-10	00063813	Arbor	160,0	10	14,0	90,0	40,0	90,0	63,0	4800	5,9	TNGN1604..

Spare Parts, included in delivery

For cutter	Adjustment unit	Arbor screw	Cassette	Insert wedge	Setting key	Wedge clamp	Wedge key	Wedge screw
R220.68-0063-T11C	AU1114T-T15P	220.17-696	TN11PR	L257.9-120-T11	–	L257.9-120M	H6B-T25P	LD8020-T25P
R220.68-0080-T11C	AU1114T-T15P	MC6S12X40	TN11PR	L257.9-120-T11	–	L257.9-120M	H6B-T25P	LD8020-T25P
R220.68-0100-T11C	AU1114T-T15P	MC6S16X35	TN11PR	L257.9-120-T11	–	L257.9-120M	H6B-T25PL	LD8020-T25P
R220.68-0125-T11C	AU1114T-T15P	–	TN11PR	L257.9-120-T11	–	L257.9-120M	H6B-T25PL	LD8020-T25P
R220.68-8160-T11C	AU1114T-T15P	–	TN11PR	L257.9-120-T11	–	L257.9-120M	1/4HEX-T25PX90	LD8020-T25P
R220.68-0063-T16C	AU1114T-T15P	220.17-696	TN16PR	L257.9-120-T16	T15P-4	L257.9-120M	H6B-T25PL	LD8020-T25P
R220.68-0080-T16C	AU1114T-T15P	MC6S12X40	TN16PR	L257.9-120-T16	T15P-4	L257.9-120M	H6B-T25PL	LD8020-T25P
R220.68-0125-T16C	AU1114T-T15P	–	TN16PR	L257.9-120-T16	T15P-4	L257.9-120M	H6B-T25PL	LD8020-T25P
R220.68-8160-T16C	AU1114T-T15P	–	TN16PR	L257.9-120-T16	T15P-4	L257.9-120M	H6B-T25PL	LD8020-T25P

Accessories

For cutter	Adjustable Torque key	Arbor screw	Insert clamping torque	Torque key
R220.68-0063-0125-T11C	–	–	6.0NM	T00T-25P60
R220.68-8160-T11C	1/4HEX-T-HANDLE-5.0-14.0NM	MC6S12X40	6.0NM	T00T-25P60
R220.68-0063-0125-T16C	–	–	6.0NM	T00T-25P60
R220.68-8160-T16C	–	MC6S12X40	6.0NM	T00T-25P60

Torque and fixed keys, see page 894

R220.68-T16C – inch

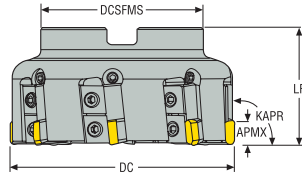

- For insert selection and cutting data recommendations, see page(s) 805
- For complete insert programme, see page(s) 816
- For ISO attribute explanation, see page 16

Designation	Item number	Type of mounting	DC	ZEFP	APMXS	KAPRS°	DCB	DCSFMS	LF	RPMX	Weight	Insert
			inch		inch		inch	inch	inch		lbs	
R220.68-02.50-T11C-4	02611344	Arbor	2.500	4	0.197	90,0	0.750	1.850	2.480	20600	2.430	TN..11
R220.68-03.00-T11C-5	02611345	Arbor	3.000	5	0.197	90,0	1.000	2.441	2.480	9600	3.970	TN..11
R220.68-04.00-T11C-6	02611346	Arbor	4.000	6	0.197	90,0	1.500	3.031	2.480	7600	9.920	TN..11
R220.68-05.00-T11C-8	02611347	Arbor	5.000	8	0.197	90,0	1.500	3.543	2.480	6100	7.500	TN..11
R220.68-06.00-T11C-10	02611348	Arbor	6.000	10	0.197	90,0	2.000	4.331	2.480	4800	12.350	TN..11

Spare Parts, included in delivery

For cutter	Adjustment unit	Arbor screw	Cassette	Circlip	Insert key	Insert wedge	Ring	Wedge clamp	Wedge key	Wedge screw
R220.68-02.50	AU1114T-T15P	220.17-695	TN11PR	SGH19SMS1582	H4B-T15P	L257.9-120-T11	220.13-114	L257.9-120M	H6B-T25P	LD8020-T25P
R220.68-03.00	AU1114T-T15P	UC6S1/2UNFX1-1/4	TN11PR	-	H4B-T15P	L257.9-120-T11	-	L257.9-120M	H6B-T25P	LD8020-T25P
R220.68-04.00	AU1114T-T15P	UC6S3/4UNFX2	TN11PR	-	H4B-T15PL	L257.9-120-T11	-	L257.9-120M	H6B-T25PL	LD8020-T25P
R220.68-05.00	AU1114T-T15P	UC6S3/4UNFX2	TN11PR	-	H4B-T15PL	L257.9-120-T11	-	L257.9-120M	H6B-T25PL	LD8020-T25P
R220.68-06.00	AU1114T-T15P	-	TN11PR	-	1/4HEX-T15PX90	L257.9-120-T11	-	L257.9-120M	1/4HEX-T25PX90	LD8020-T25P

Accessories

For cutter	Adjustable Torque key	Arbor screw	Insert clamping torque	Torque key
R220.68-02.50-05.00	-	-	53.1IN.LBS	T00T-25P60
R220.68-06.00	1/4HEX-T-HANDLE-5.0-14.0NM	58215080	53.1IN.LBS	T00T-25P60

Torque and fixed keys, see page 894

ONEW05

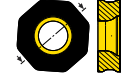
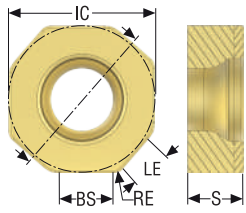

Designation	IC	BS	RE	LE	S	GAN	Grades CBN						
							CBN200	CBN300	CBN300P	CBN400C	CBN500	CBN600	
ONEW050410ZZSR4-02020-LF	11,9 0.469	3,26 0.128	1,0 0.039	3,57 0.141	4,427 0.174	0,0 °	■						
ONEW050410ANSN-02020-LF	12,0 0.472	0,3 0.012	1,0 0.039	3,6 0.142	4,427 0.174	0,0 °	■						

RDHW

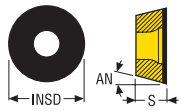

Designation	INSD	S	AN°	Grades CBN						
				CBN200	CBN300	CBN300P	CBN400C	CBN500	CBN600	
RDHW0803M0S-01030-LF	8,0 0.315	3,18 0.125	15,0 0.591	■						
RDHW10T3M0S-01030-8-LF	10,0 0.394	3,97 0.156	15,0 0.591	■						

RN.N-LF06/09/12

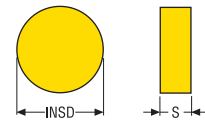

Designation	INSD	S	GAN	Grades CBN						
				CBN200	CBN300	CBN300P	CBN400C	CBN500	CBN600	
	mm Inch	mm Inch								
RNGN060300S-02020-LF	6,35 0.250	3,18 0.125	0,0°	■						
RNGN090300S-02020-LF	9,52 0.375	3,18 0.125	0,0°	■						
RNGN120400S-02020-LF	12,7 0.500	4,76 0.187	0,0°	■						
RNGN060300S	6,35 0.250	3,18 0.125	0,0°	■						
RNGN090300S	9,52 0.375	3,18 0.125	0,0°	■						
RNMN060300S	6,35 0.250	3,18 0.125	0,0°		■	■				
RNMN060300S-02020P	6,35 0.250	3,18 0.125	0,0°							■
RNMN090300E	9,52 0.375	3,18 0.125	0,0°		■		■			
RNMN090300S	9,52 0.375	3,18 0.125	0,0°		■	■				
RNMN090300S-02020	9,52 0.375	3,18 0.125	0,0°				■		■	
RNMN090300S-02020P	9,52 0.375	3,18 0.125	0,0°							■

SEE.12

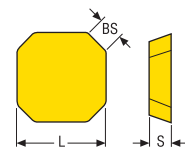

Designation	RE	BS	L	S	GAN	Grades Coated					
						CBN200	CBN300	CBN300P	CBN400C	CBN500	CBN600
	mm Inch	mm Inch	mm Inch	mm Inch							
SEEN1203AFTN-D16	1,0 0.039	1,5 0.059	12,7 0.500	3,18 0.125	0,0°		■				

SEEX

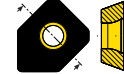
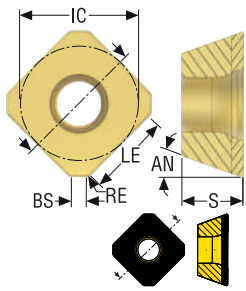

Designation	IC	BS	RE	LE	S	AN°	GAN	Grades					
								CBN					
	mm <i>Inch</i>	mm <i>Inch</i>	mm <i>Inch</i>	mm <i>Inch</i>	mm <i>Inch</i>			CBN200	CBN300	CBN300P	CBN400C	CBN500	CBN600
SEEX09T3AFTN-D09-LF	9,52 0.375	1,25 0.049	0,5 0.020	2,86 0.113	3,97 0.156	20,0	0,0 °	■					
SEEX1203AETN-MD13-LF	12,7 0.500	8,0 0.315	1,0 0.039	2,2 0.087	3,18 0.125	20,0	0,0 °	■					
SEEX1204AFTN-D16-LF	12,7 0.500	1,6 0.063	1,1 0.043	3,81 0.150	4,76 0.187	20,0	0,0 °	■					
SEEX1204ZZTN-D16-LF	12,7 0.500	7,53 0.296	1,0 0.039	3,81 0.150	4,76 0.187	20,0	0,0 °	■					

SNEN

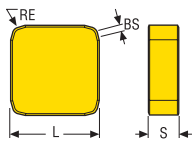

Designation	RE	BS	L	S	GAN	Grades					
						CBN					
	mm <i>Inch</i>	mm <i>Inch</i>	mm <i>Inch</i>	mm <i>Inch</i>		CBN200	CBN300	CBN300P	CBN400C	CBN500	CBN600
SNEN0903ENE-M06	0,8 0.031	0,9 0.035	9,52 0.375	3,18 0.125	0,0 °	■					
SNEN0903ENS-M08	0,8 0.031	0,9 0.035	9,52 0.375	3,18 0.125	0,0 °	■					

SN..06/09/SNEX12

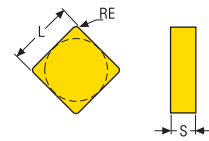

Designation	RE	L	S	GAN	Grades					
					CBN					
	mm Inch	mm Inch	mm Inch		CBN200	CBN300	CBN300P	CBN400C	CBN600	CBN600
SNMN060308E	0,8 0.031	6,35 0.250	3,18 0.125	0,0°				■		
SNMN060308S	0,8 0.031	6,35 0.250	3,18 0.125	0,0°		■				
SNMN090308E	0,8 0.031	9,525 0.375	3,18 0.125	0,0°		■				
SNMN090308S	0,8 0.031	9,525 0.375	3,18 0.125	0,0°		■				
SNMN090312E	1,2 0.047	9,525 0.375	3,18 0.125	0,0°		■				
SNMN090312S	1,2 0.047	9,525 0.375	3,18 0.125	0,0°		■	■			
SNMN090312S-02020P	1,2 0.047	9,525 0.375	3,18 0.125							■
SNMN090316S	1,6 0.063	9,525 0.375	3,18 0.125	0,0°		■				
SNGN090308E	0,8 0.031	9,525 0.375	3,18 0.125	0,0°	■					
SNGN090308S	0,8 0.031	9,525 0.375	3,18 0.125	0,0°	■					
SNGN090312S	1,2 0.047	9,525 0.375	3,18 0.125	0,0°	■					
SNGN090316S	1,6 0.063	9,525 0.375	3,18 0.125	0,0°	■					
SNEX120312ZZ	1,2 0.047	12,7 0.500	3,18 0.125	0,0°	■					

TNGN

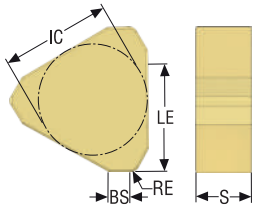

Designation	IC	BS	RE	LE	S	GAN	Grades CBN						
							CBN200	CBN300	CBN300P	CBN400C	CBN500	CBN600	
TNGN1103PNE	6,35 0.250	1,0 0.039	0,8 0.031	3,3 0.130	3,18 0.125	0,0 °	■						
TNGN1103PNS	6,35 0.250	1,0 0.039	0,8 0.031	3,3 0.130	3,18 0.125	0,0 °	■						
TNGN1103PRS	6,35 0.250	1,0 0.039	1,2 0.047	3,3 0.130	3,18 0.125	0,0 °	■						
TNGN1604PNE	9,52 0.375	1,9 0.075	0,8 0.031	4,95 0.195	4,76 0.187	0,0 °	■						
TNGN1604PNS	9,52 0.375	1,9 0.075	0,8 0.031	4,95 0.195	4,76 0.187	0,0 °	■						
TNGN1604PRS	9,52 0.375	1,3 0.051	1,2 0.047	4,95 0.195	4,76 0.187	0,0 °	■						

218.19

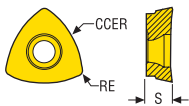

Designation	RE	CCER	S	GAN	Grades CBN						
					CBN200	CBN300	CBN300P	CBN400C	CBN500	CBN600	
218.19-100T-MD08-LF	0,8 0.031	10,0 0.394	2,81 0.111	0,0 °	■						

Introduction

Application areas

Secomax ceramics include a range of products developed to meet the manufacturing industries ever increasing demands on productivity and product performance.

The inserts are die-pressed and sintered by a HIP process using very fine and pure raw materials with fine microstructure to reach excellent material properties. All surfaces are then ground ensuring a product with superior dimensions and tolerances.

This comes together in a product with outstanding features:

- high thermal shock resistance
- optimised fracture toughness
- excellent wear resistance
- high product quality

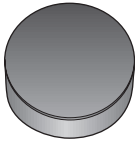
CS300	
	<p>Format: Solid.</p> <p>Composition: Sialon (Si, Al, O, N) ceramic grade.</p> <p>Coating: No coating.</p>

Chamfer size and angle		
CS300	=	0,10 mm x 20°
S	=	Chamfered and honed
T	=	Chamfered, no honing
E	=	Honed

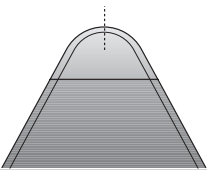
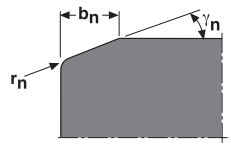
Chamfer size and angle	
	
<p>b_n = Chamfer width γ_n = Chamfer angle r_n = Hone radius</p>	

Ceramic, Roughing a_p 0,5 – 3,0 mm/Inch

SMG	CS300	
	v_c	f_z
S1	600 – 1000	0,050 – 0,15
	2000 – 3200	0,00197 – 0,00590
S2	600 – 1000	0,050 – 0,15
	2000 – 3200	0,00197 – 0,00590
S3	600 – 1000	0,050 – 0,15
	2000 – 3200	0,00197 – 0,00590
S11	—	—
S12	—	—
S13	—	—

R217/220.26 - Metric

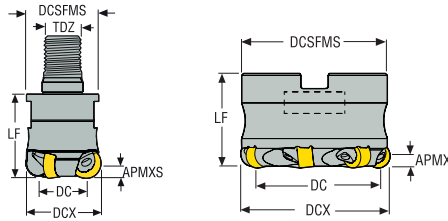

- For insert selection and cutting data recommendations, see page(s) 818
- For complete insert programme, see page(s) 821
- For ISO attribute explanation, see page 16

Designation	Item number	Type of mounting	DC	DCX	ZEFP	APMXS	DCB	TDZ	DCSFMS	LF	RPMX	Weight	Insert
			mm	mm		mm	mm		mm	mm		kg	
R217.26-1632.RE-RN1204.3A	03115686	Combimaster	19,3	32,0	3	6,0	–	M16	30,0	35,0	19100	0,2	RN1204
R217.26-1632.RE-RP1204.3A	03204228	Combimaster	19,4	32,0	3	6,0	–	M16	30,0	35,0	20800	0,2	RP1204
R217.26-2040.RE-RN1204.4A	03115687	Combimaster	27,3	40,0	4	6,0	–	M20	36,5	40,0	17100	0,4	RN1204
R217.26-2040.RE-RP1204.4A	03115679	Combimaster	27,4	40,0	4	6,0	–	M20	36,5	40,0	18600	0,4	RP1204
R220.26-0050-RN1204.6A	03115702	Arbor	37,3	50,0	6	6,0	22,0	–	47,0	45,0	16700	0,4	RN1204
R220.26-0050-RP1204.6A	03133188	Arbor	37,4	50,0	6	6,0	22,0	–	47,0	45,0	16700	0,4	RP1204
R220.26-0050-RN1207.5A	03115710	Arbor	37,3	50,0	5	6,0	22,0	–	47,0	45,0	11900	0,4	RN1207
R220.26-0063-RN1207.6A	03115711	Arbor	50,3	63,0	6	6,0	27,0	–	60,0	50,0	10600	0,8	RN1207
R220.26-0063-RN1207.7A	03115712	Arbor	50,3	63,0	7	6,0	27,0	–	60,0	50,0	10600	0,8	RN1207
R220.26-0080-RN1207.7A	03115713	Arbor	67,3	80,0	7	6,0	32,0	–	77,0	50,0	9400	1,6	RN1207
R220.26-0080-RN1207.8A	03115714	Arbor	67,3	80,0	8	6,0	32,0	–	77,0	50,0	9400	1,3	RN1207
R220.26-0100-RN1207.8A	03115715	Arbor	87,3	100,0	8	6,0	40,0	–	90,0	63,0	8400	2,7	RN1207
R220.26-0125-RN1207.9	03115716	Arbor	112,3	125,0	9	6,0	40,0	–	90,0	63,0	7500	3,6	RN1207

Spigot size = DCB

Spare Parts, included in delivery

For cutter	Wedge clamp	Wedge key	Wedge screw
R217/220.26-..	CW0508	H4B-H2.5	LD5015C

Accessories

For cutter	Insert clamping torque	Torque key
R217/220.26-..	3.5NM	H00-2535

Torque and fixed keys, see page 894

R217/220.26 - inch

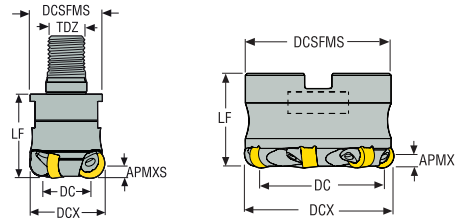

- For insert selection and cutting data recommendations, see page(s) 818
- For complete insert programme, see page(s) 821
- For ISO attribute explanation, see page 16

Designation	Item number	Type of mounting	DC	DCX	ZEFP	APMXS	TDZ	DCSFMS	LF	RPMX	Weight	Insert
			inch	inch		inch		inch	inch		lbs	
R217.26-01.50-20RE-RN1207.3A	10008700	Arbor	1.001	1.500	3	0.236	M20	1.437	1.575	12500	2.200	RN1207
R220.26-02.00-RN1207.5A	03115723	Arbor	1.501	2.000	5	0.236	–	1.750	2.000	11900	1.100	RN1207
R220.26-02.50-RN1207.6A	03115724	Arbor	2.001	2.500	6	0.236	–	2.250	2.000	10600	1.760	RN1207
R220.26-03.00-RN1207.7A	03115725	Arbor	2.499	3.000	7	0.236	–	2.750	2.000	9400	2.870	RN1207

Spare Parts, included in delivery

For cutter	Wedge clamp	Wedge key	Wedge screw
R217/220.26-..	CW0508	H4B-H2.5	LD5015C

Accessories

For cutter	Insert clamping torque	Torque key
R217/220.26-..	31.0IN.LBS	H00-2535

Torque and fixed keys, see page 894

RNGN12

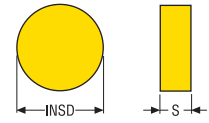

Designation	INSD		S		Grades Ceramic		
	mm <i>Inch</i>	mm <i>Inch</i>	mm <i>Inch</i>	mm <i>Inch</i>			
				CS300			
RNGN120400T-01020	12,7 <i>0.500</i>	4,76 <i>0.187</i>		■			
RNGN120700T-01020	12,7 <i>0.500</i>	7,94 <i>0.313</i>		■			
RPGN120400T-01020	12,7 <i>0.500</i>	4,76 <i>0.187</i>		■			

Introduction

Polycrystalline Diamond (PCD) is produced by sintering together carefully selected particles of diamond under conditions of high temperature and high pressure. PCD cutting tools combine the hardness, abrasion resistance and thermal conductivity of diamond with the toughness of tungsten carbide.

Secomax™ PCD inserts are suitable for machining non-ferrous metals and alloys, e.g.:



- Aluminium
- Copper
- Brass
- Bronze
- Cemented carbide

It can also be used for other materials, e.g.:

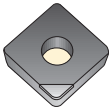
- Composites (MMC, ...)
- Reinforced plastics
- Graphite
- Tungsten carbide
- Ceramics
- Titanium alloys

Selection of insert types	
	<ul style="list-style-type: none"> • Sintered layer -LF • PCD sintered on carbide. • All cutting edges on one side are usable. • Grades: PCD20, PCD30M
	<ul style="list-style-type: none"> • Brazed tip -L1 and L2 • PCD brazed on to standard carbide inserts. • Grades: PCD05, PCD20, PCD30

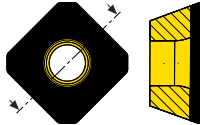
Inserts for standard milling cutters

Face milling cutters		Face milling cutters	
<ul style="list-style-type: none"> • SEHN12 • R220.13 • R220.30 		<ul style="list-style-type: none"> • SEEX12 • R220.53 	
Face milling cutters		Square shoulder milling cutters	
<ul style="list-style-type: none"> • OFEX05 • R220.43 		<ul style="list-style-type: none"> • XOEX06/10/12/16 • 217/220.69 	

Cutting speed recommendations are in the cutting data table.
Feed rate recommendations are in the cutting data table.
Formulae for cutting data calculation are on page 884

OFEX

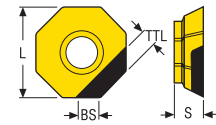

Designation	RE	BS	L	TTL	S	GAN	Grades PCD			
							PCD05	PCD20	PCD30	PCD30M
	mm Inch	mm Inch	mm Inch	mm Inch	mm Inch					
OFEX05T305FN-M05	0,5 0.020	2,4 0.094	4,9 0.193	– –	3,97 0.156	0,0 °		■		

SEEX

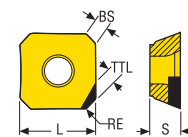

Designation	RE	BS	L	TTL	S	GAN	Grades PCD			
							PCD05	PCD20	PCD30	PCD30M
	mm Inch	mm Inch	mm Inch	mm Inch	mm Inch					
SEEX09T3AFFN-L1	0,4 0.016	1,5 0.059	9,525 0.375	– –	3,97 0.156	12,0 °	■	■		

SEHN

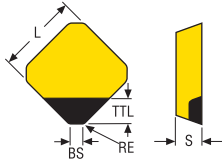

Designation	RE	BS	L	TTL	S	GAN	Grades PCD			
							PCD05	PCD20	PCD30	PCD30M
	mm <i>Inch</i>	mm <i>Inch</i>	mm <i>Inch</i>	mm <i>Inch</i>	mm <i>Inch</i>		PCD05	PCD20	PCD30	PCD30M
SEHN1203AFFN-E08	1,0 0.039	1,6 0.063	12,7 0.500	– –	3,18 0.125	0,0 °		■		

XOEX

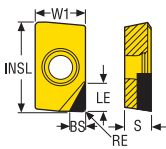

Designation	RE	BS	LE	INSL	W1	S	GAN	Grades PCD			
								PCD05	PCD20	PCD30	PCD30M
	mm <i>Inch</i>	mm <i>Inch</i>	mm <i>Inch</i>	mm <i>Inch</i>	mm <i>Inch</i>	mm <i>Inch</i>		PCD05	PCD20	PCD30	PCD30M
XOEX060204FR	0,4 0.016	1,1 0.043	2,5 0.098	6,94 0.273	4,09 0.161	2,45 0.096	8,0 °	■			
XOEX10T304F	0,4 0.016	1,08 0.043	4,0 0.157	11,08 0.436	6,87 0.270	3,77 0.148	15,0 °	■	■		
XOEX120404FR	0,4 0.016	1,11 0.044	4,0 0.157	13,88 0.546	8,18 0.322	5,03 0.198	15,0 °		■	■	
XOEX120404FR-L2	0,4 0.016	1,95 0.077	4,5 0.177	13,7 0.539	8,18 0.322	4,95 0.195	14,0 °	■			
XOEX160508F	0,8 0.031	1,3 0.051	15,7 0.618	18,3 0.720	10,2 0.402	5,8 0.228	15,65 °	■	■		■



Square shoulder and slot milling cutters

Helical milling cutters

Face milling cutters

Disc milling cutters

High feed milling cutters

Copy milling cutters

Plunge milling cutters

Chamfer milling cutters

Spot facing cutters

Inserts

ABEX26

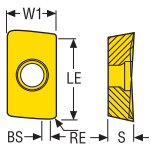

M15



Designation	RE	BS	LE	W1	S	GAN	Grades																	
							Coated											Uncoated						
	mm <i>Inch</i>	mm <i>Inch</i>	mm <i>Inch</i>	mm <i>Inch</i>	mm <i>Inch</i>		MP1501	MP2050	MP2501	MP3000	MH1000	MM4500	MK1500	MK2050	MS2050	MS2500	T25M	T350M	F15M	F30M	F40M	H15	H25	
ABEX2606ZFFR-M15	1,6 <i>0.063</i>	2,0 <i>0.079</i>	24,4 <i>0.961</i>	14,0 <i>0.551</i>	6,35 <i>0.250</i>	17,0 °	■		■				■					■				■		
ABEX2606ZZFR-M15	1,6 <i>0.063</i>	10,0 <i>0.394</i>	24,4 <i>0.961</i>	14,0 <i>0.551</i>	6,35 <i>0.250</i>	17,0 °												■						

- Square shoulder and slot milling cutters
- Helical milling cutters
- Face milling cutters
- Disc milling cutters
- High feed milling cutters
- Copy milling cutters
- Plunge milling cutters
- Chamfer milling cutters
- Spot facing cutters
- Inserts

AC..15

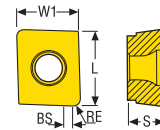

M10/M11/M14/MD15

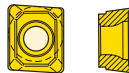

ME10

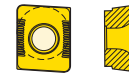

Designation	RE	BS	L	W1	S	GAN	Grades																	
							Coated															Uncoated		
	mm <i>Inch</i>	mm <i>Inch</i>	mm <i>Inch</i>	mm <i>Inch</i>	mm <i>Inch</i>		MP1501	MP2050	MP2501	MP3000	MH1000	MM4500	MK1500	MK2050	MS2050	MS2500	T25M	T350M	F15M	F30M	F40M	H15	H25	
ACET150612TR-ME10	1,2 <i>0.047</i>	0,13 <i>0.005</i>	15,0 <i>0.591</i>	12,7 <i>0.500</i>	6,35 <i>0.250</i>	22,0°									■									■
ACET150612TL-M11	1,2 <i>0.047</i>	0,13 <i>0.005</i>	15,0 <i>0.591</i>	12,7 <i>0.500</i>	6,35 <i>0.250</i>	14,0°																		■
ACET150612TR-M11	1,2 <i>0.047</i>	0,13 <i>0.005</i>	15,0 <i>0.591</i>	12,7 <i>0.500</i>	6,35 <i>0.250</i>	14,0°	■		■				■				■	■						■
ACET150631TR-M11	3,1 <i>0.122</i>	0,0 -	15,0 <i>0.591</i>	12,7 <i>0.500</i>	6,35 <i>0.250</i>	14,0°																		■
ACET150612TL-M14	1,2 <i>0.047</i>	0,13 <i>0.005</i>	15,0 <i>0.591</i>	12,7 <i>0.500</i>	6,35 <i>0.250</i>	15,0°																		■
ACET150612TR-M14	1,2 <i>0.047</i>	0,13 <i>0.005</i>	15,0 <i>0.591</i>	12,7 <i>0.500</i>	6,35 <i>0.250</i>	15,0°			■				■					■						■
ACET150630TR-M14	3,0 <i>0.118</i>	0,0 -	15,0 <i>0.591</i>	12,7 <i>0.500</i>	6,35 <i>0.250</i>	15,0°												■						
ACET150631TR-M14	3,1 <i>0.122</i>	0,0 -	15,0 <i>0.591</i>	12,7 <i>0.500</i>	6,35 <i>0.250</i>	15,0°																		■
ACET150660TL-M14	6,0 <i>0.236</i>	0,0 -	15,0 <i>0.591</i>	12,7 <i>0.500</i>	6,35 <i>0.250</i>	15,0°																		■
ACET150660TR-M14	6,0 <i>0.236</i>	0,0 -	15,0 <i>0.591</i>	12,7 <i>0.500</i>	6,35 <i>0.250</i>	15,0°												■						■
ACET150612TR-MD15	1,2 <i>0.047</i>	0,13 <i>0.005</i>	15,0 <i>0.591</i>	12,7 <i>0.500</i>	6,35 <i>0.250</i>	15,0°	■			■								■						
ACET150630TR-MD15	3,0 <i>0.118</i>	0,0 -	15,0 <i>0.591</i>	12,7 <i>0.500</i>	6,35 <i>0.250</i>	15,0°	■																	
ACMT150612TR-M14	1,2 <i>0.047</i>	0,13 <i>0.005</i>	15,0 <i>0.591</i>	12,7 <i>0.500</i>	6,35 <i>0.250</i>	15,0°			■									■						■

- Square shoulder and slot milling cutters
- Helical milling cutters
- Face milling cutters
- Disc milling cutters
- High feed milling cutters
- Copy milling cutters
- Plunge milling cutters
- Chamfer milling cutters
- Spot facing cutters
- Inserts

LOEX08/12

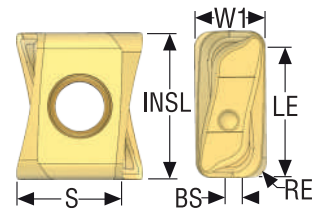

M08/MD08

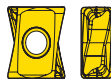

M09/M12/MD13



Designation	RE	BS	LE	S	INSL	W1	GAN	Grades																		
								Coated																Uncoated		
	mm Inch	mm Inch	mm Inch	mm Inch	mm Inch	mm Inch		MP1501	MP2050	MP2501	MP3000	MH1000	MM4500	MK1500	MK2050	MS2050	MS2500	T25M	T350M	F15M	F30M	F40M	H15	H25		
LOEX080404TR-M08	0,4 0.016	1,29 0.051	8,3 0.327	6,67 0.263	9,3 0.366	4,4 0.173	33,3 °	■		■	■				■								■			
LOEX080408TR-M08	0,8 0.031	0,9 0.035	8,3 0.327	6,6 0.260	9,3 0.366	4,4 0.173	34,0 °	■	■	■	■		■	■	■	■				■				■		
LOEX080412TR-M08	1,2 0.047	0,52 0.020	8,3 0.327	6,52 0.257	9,3 0.366	4,4 0.173	33,3 °			■					■									■		
LOEX080416TR-M08	1,6 0.063	0,13 0.005	8,3 0.327	6,45 0.254	9,3 0.366	4,4 0.173	33,3 °		■		■					■								■		
LOEX080404TR-MD08	0,4 0.016	1,29 0.051	8,3 0.327	6,67 0.263	9,3 0.366	4,4 0.173	29,0 °				■				■									■		
LOEX080408TR-MD08	0,8 0.031	0,92 0.036	8,3 0.327	6,6 0.260	9,3 0.366	4,4 0.173	29,5 °	■			■			■	■					■				■		
LOEX080412TR-MD08	1,2 0.047	0,52 0.020	8,3 0.327	6,52 0.257	9,3 0.366	4,4 0.173	29,5 °								■											
LOEX080416TR-MD08	1,6 0.063	0,13 0.005	8,3 0.327	6,45 0.254	9,3 0.366	4,4 0.173	29,5 °				■													■		
LOEX120708TR-M12	0,8 0.031	2,47 0.097	12,0 0.472	10,26 0.404	14,2 0.559	7,5 0.295	35,0 °		■	■	■		■		■	■	■			■				■		
LOEX120712TR-M12	1,2 0.047	2,1 0.083	12,0 0.472	10,19 0.401	14,2 0.559	7,5 0.295	35,0 °													■					■	
LOEX120716TR-M12	1,6 0.063	1,74 0.069	12,0 0.472	10,12 0.398	14,2 0.559	7,5 0.295	35,0 °								■										■	
LOEX120720TR-M12	2,0 0.079	1,37 0.054	12,0 0.472	10,04 0.395	14,2 0.559	7,5 0.295	35,0 °				■	■				■				■					■	
LOEX120724TR-M12	2,4 0.094	1,01 0.040	12,0 0.472	9,98 0.393	14,2 0.559	7,5 0.295	35,0 °				■					■									■	
LOEX120731TR-M12	3,1 0.122	0,37 0.015	12,0 0.472	9,88 0.389	14,2 0.559	7,5 0.295	35,0 °				■	■				■				■					■	
LOEX120708TR-MD13	0,8 0.031	2,47 0.097	12,0 0.472	10,26 0.404	14,2 0.559	7,5 0.295	30,0 °	■			■			■	■										■	
LOEX120712TR-MD13	1,2 0.047	2,1 0.083	12,0 0.472	10,19 0.401	14,2 0.559	7,5 0.295	30,0 °				■				■											
LOEX120716TR-MD13	1,6 0.063	1,74 0.069	12,0 0.472	10,12 0.398	14,2 0.559	7,5 0.295	30,0 °	■			■				■					■						■
LOEX120704R-M09	0,4 0.016	2,83 0.111	12,0 0.472	10,33 0.407	14,2 0.559	7,5 0.295	36,0 °																		■	
LOEX120708R-M09	0,8 0.031	2,47 0.097	12,0 0.472	10,26 0.404	14,2 0.559	7,5 0.295	36,0 °		■	■	■					■	■			■					■	
LOEX120716R-M09	1,6 0.063	1,74 0.069	12,0 0.472	10,12 0.398	14,2 0.559	7,5 0.295	36,0 °				■					■									■	
LOEX120724R-M09	2,4 0.094	1,01 0.040	12,0 0.472	9,98 0.393	14,2 0.559	7,5 0.295	36,0 °									■										
LOEX120731R-M09	3,1 0.122	0,37 0.015	12,0 0.472	9,88 0.389	14,2 0.559	7,5 0.295	36,0 °				■					■				■					■	
LOEX120740R-M09	4,0 0.157	0,14 0.006	12,0 0.472	9,74 0.383	14,2 0.559	7,5 0.295	36,0 °									■									■	

Square shoulder and slot milling cutters
Helical milling cutters
Face milling cutters
Disc milling cutters
High feed milling cutters
Copy milling cutters
Plunge milling cutters
Chamfer milling cutters
Spot facing cutters
Inserts

Square shoulder and slot milling cutters
Helical milling cutters
Face milling cutters
Disc milling cutters
High feed milling cutters
Copy milling cutters
Plunge milling cutters
Chamfer milling cutters
Spot facing cutters
Inserts

Designation	RE	BS	LE	S	INSL	W1	GAN	Grades																
								Coated																Uncoated
	mm Inch	mm Inch	mm Inch	mm Inch	mm Inch	mm Inch		MP1501	MP2050	MP2501	MP3000	MH1000	MM4500	MK1500	MK2050	MS2050	MS2500	T25M	T350M	F15M	F30M	F40M	H15	H25
LOEX120750R-2-M09	5,0 0.197	1,06 0.042	12,0 0.472	9,52 0.375	14,2 0.559	7,5 0.295	36,0 °																	
LOEX120763R-2-M09	6,3 0.248	0,43 0.017	12,0 0.472	9,28 0.365	14,2 0.559	7,5 0.295	36,0 °									■							■	

Note: LOEX1207xxR-2-M09 have only 2 edges

LNHQ14/17

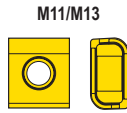
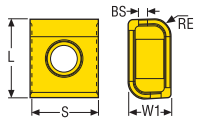

Designation	RE	L	W1	GAN	Grades																	
					Coated																Uncoated	
	mm Inch	mm Inch	mm Inch		MP1501	MP2050	MP2501	MP3000	MH1000	MM4500	MK1500	MK2050	MS2050	MS2500	T25M	T350M	F15M	F30M	F40M	H15	H25	
LNHQ140708TN4-M11	0,8 0.031	14,0 0.551	7,5 0.295	16,0 °			■													■		
LNHQ140731TN4-M11	3,1 0.122	14,0 0.551	7,5 0.295	16,0 °			■													■		
LNHQ140740TN4-M11	4,0 0.157	14,0 0.551	7,5 0.295	16,0 °			■													■		
LNHQ140750TN4-M11	5,0 0.197	14,0 0.551	7,5 0.295	16,0 °			■													■		
LNHQ140760TN4-M11	6,0 0.236	14,0 0.551	7,5 0.295	16,0 °			■													■		

LNK.05/06

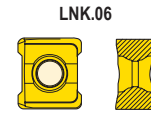
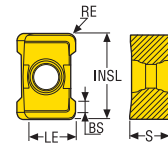

Designation	RE	BS	LE	INSL	S	GAN	Grades																	
							Coated																Uncoated	
	mm Inch	mm Inch	mm Inch	mm Inch	mm Inch		MP1501	MP2050	MP2501	MP3000	MH1000	MM4500	MK1500	MK2050	MS2050	MS2500	T25M	T350M	F15M	F30M	F40M	H15	H25	
LNKT050404PPN4-E05	0,4 0.016	1,3 0.051	5,0 0.197	10,0 0.394	4,7 0.185	23,0°																		
LNKT050404PPTN4-M06	0,4 0.016	1,3 0.051	5,0 0.197	10,0 0.394	4,7 0.185	15,0°				■		■										■		
LNKT050408PPTN4-M06	0,8 0.031	1,3 0.051	5,0 0.197	10,0 0.394	4,7 0.185	15,0°				■									■			■		
LNKT050416PPTN4-M06	1,6 0.063	0,8 0.031	5,0 0.197	10,0 0.394	4,7 0.185	15,0°																■		
LNKT050420PPTN4-M06	2,0 0.079	0,8 0.031	5,0 0.197	10,0 0.394	4,7 0.185	15,0°																■		
LNKT050424PPTN2-M06	2,4 0.094	0,6 0.024	5,0 0.197	10,0 0.394	4,7 0.185	15,0°																■		
LNKT050431PPTL1-M06	3,1 0.122	0,6 0.024	5,0 0.197	10,0 0.394	4,7 0.185	15,0°																■		
LNKT050431PPTR1-M06	3,1 0.122	0,6 0.024	5,0 0.197	10,0 0.394	4,7 0.185	15,0°																■		
LNKT050431PPTR1C-M06	3,1 0.122	0,6 0.024	4,96 0.195	10,0 0.394	4,7 0.185	15,0°																■		
LNKT050431PPTL1C-M06	3,1 0.122	0,6 0.024	4,96 0.195	10,0 0.394	4,7 0.185	15,0°																■		
LNKT060504PPN-E05	0,4 0.016	1,6 0.063	6,0 0.236	10,0 0.394	5,0 0.197	23,0°																		■
LNKT060508PPN-E05	0,8 0.031	1,1 0.043	6,0 0.236	10,0 0.394	5,0 0.197	23,0°																		■
LNKT060504PPTN-M06	0,4 0.016	1,6 0.063	6,0 0.236	10,0 0.394	5,0 0.197	15,0°				■												■		
LNKT060508PPTN-M06	0,8 0.031	1,1 0.043	6,0 0.236	10,0 0.394	5,0 0.197	15,0°				■	■			■	■							■		
LNKT060516PPTN-M06	1,6 0.063	1,3 0.051	6,0 0.236	10,0 0.394	5,0 0.197	15,0°								■	■							■		
LNKT060531PPTN-M06	3,1 0.122	0,6 0.024	6,0 0.236	10,0 0.394	5,0 0.197	15,0°																■		
LNKT060540PPTL-M06	4,0 0.157	0,8 0.031	6,0 0.236	10,0 0.394	5,0 0.197	15,0°																■		
LNKT060540PPTR-M06	4,0 0.157	0,8 0.031	6,0 0.236	10,0 0.394	5,0 0.197	15,0°																■		
LNKW060504PPN-MD08	0,4 0.016	1,6 0.063	6,0 0.236	10,0 0.394	5,0 0.197	0,0°									■									
LNKW060508PPN-MD08	0,8 0.031	1,1 0.043	6,0 0.236	10,0 0.394	5,0 0.197	0,0°				■				■										

LNK.0504031...C is the first choice for CW = 8 to 9mm and LNK.0504031 is the first choice for CW= 9 to 10mm

Square shoulder and slot milling cutters

Helical milling cutters

Face milling cutters

Disc milling cutters

High feed milling cutters

Copy milling cutters

Plunge milling cutters

Chamfer milling cutters

Spot facing cutters

Inserts

LNK.08

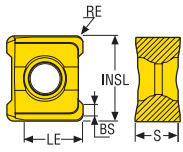

LNK.08

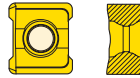

Designation	RE	BS	LE	INSL	S	GAN	Grades																	
							Coated																Uncoated	
	mm	mm	mm	mm	mm		MP1501	MP2050	MP2501	MP3000	MH1000	MM4500	MK1500	MK2050	MS2050	MS2500	T25M	T350M	F15M	F30M	F40M	H15	H25	
	Inch	Inch	Inch	Inch	Inch																			
LNKT080504PPN-E05	0,4 0.016	1,6 0.063	7,5 0.295	10,0 0.394	5,0 0.197	23,0°																		■
LNKT080508PPN-E05	0,8 0.031	1,1 0.043	7,5 0.295	10,0 0.394	5,0 0.197	23,0°																		■
LNKT080520PPN-E05	2,0 0.079	0,7 0.028	6,7 0.264	10,0 0.394	5,0 0.197	23,0°																		■
LNKT080531PPN-E05	3,1 0.122	0,6 0.024	7,5 0.295	10,0 0.394	5,0 0.197	23,0°																		■
LNKT080504PPTN-M06	0,4 0.016	1,6 0.063	7,5 0.295	10,0 0.394	5,0 0.197	15,0°			■									■					■	
LNKT080508PPTN-M06	0,8 0.031	1,1 0.043	7,5 0.295	10,0 0.394	5,0 0.197	15,0°			■	■			■	■				■					■	
LNKT080516PPTN-M06	1,6 0.063	1,3 0.051	7,2 0.283	10,0 0.394	5,0 0.197	15,0°								■									■	
LNKT080520PPTN-M06	2,0 0.079	0,7 0.028	6,7 0.264	10,0 0.394	5,0 0.197	15,0°							■	■									■	
LNKT080524PPTN-M06	2,4 0.094	0,5 0.020	6,7 0.264	10,0 0.394	5,0 0.197	15,0°							■	■									■	
LNKT080531PPTN-M06	3,1 0.122	0,6 0.024	7,5 0.295	10,0 0.394	5,0 0.197	15,0°							■	■									■	
LNKT080540PPTL-M06	4,0 0.157	0,8 0.031	7,5 0.295	10,0 0.394	5,0 0.197	15,0°																	■	
LNKT080540PPTR-M06	4,0 0.157	0,8 0.031	7,5 0.295	10,0 0.394	5,0 0.197	15,0°																	■	
LNKW080508PPN-MD08	0,8 0.031	1,1 0.043	7,5 0.295	10,0 0.394	5,0 0.197	0,0°			■				■											

Note: When using LNK insert with corner radius RE= 2,4, 3,1 and 4,0 mm please modify the external profile of the cutter or cassette by adding a corner radius or chamfer = 2,5 mm

- Square shoulder and slot milling cutters
- Helical milling cutters
- Face milling cutters
- Disc milling cutters
- High feed milling cutters
- Copy milling cutters
- Plunge milling cutters
- Chamfer milling cutters
- Spot facing cutters
- Inserts

LPH.05/06/09

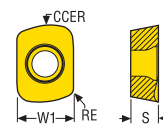

E05/E08/ME04/ME05/ME08/M05/M06/M13



MD05/MD07/MD15/D06/D12/D15



Designation	RE	W1	CCER	S	GAN	Grades																	
						Coated																	
						Uncoated																	
						MP1501	MP2050	MP2501	MP3000	MH1000	MM4500	MK1500	MK2050	MS2050	MS2500	T25M	T350M	F15M	F30M	F40M	H15	H25	
						mm	mm	mm	mm														
						Inch	Inch	Inch	Inch														
LPHT05T210TR-ME04	1,0 0.039	5,07 0.200	6,4 0.252	2,54 0.100	16,0°									■			■						
LPHT060310ER-E05	1,0 0.039	6,35 0.250	8,0 0.315	3,18 0.125	16,0°						■										■		■
LPHT060310TR-ME05	1,0 0.039	6,35 0.250	8,0 0.315	3,18 0.125	16,0°				■		■			■							■		
LPHT060310TR-M06	1,0 0.039	6,35 0.250	8,0 0.315	3,18 0.125	11,0°		■	■	■					■	■		■				■		
LPHT09T420R-E08	2,0 0.079	9,5 0.374	9,75 0.384	4,76 0.187	20,0°																		■
LPHW05T210TR-MD05	1,0 0.039	5,07 0.200	6,4 0.252	2,54 0.100	0,0°					■													
LPHW060310TR-MD07	1,0 0.039	6,35 0.250	8,0 0.315	3,18 0.125	0,0°			■							■								
LPHW060310TR-D06	1,0 0.039	6,35 0.250	8,0 0.315	3,18 0.125	0,0°				■	■													
LPHW09T420TR-D12	2,0 0.079	9,5 0.374	9,75 0.384	4,76 0.187	0,0°					■													
LPKT05T210TR-M05	1,0 0.039	5,07 0.200	6,4 0.252	2,54 0.100	11,0°		■	■	■					■	■						■		
LPKT09T420TR-ME08	2,0 0.079	9,5 0.374	9,75 0.384	4,76 0.187	15,0°						■			■							■		
LPKT09T420TR-M13	2,0 0.079	9,5 0.374	9,75 0.384	4,76 0.187	10,0°	■	■	■	■					■	■		■				■		
LPKW05T210TR-MD05	1,0 0.039	5,07 0.200	6,4 0.252	2,54 0.100	0,0°			■	■														
LPKW09T420TR-MD15	2,0 0.079	9,5 0.374	9,75 0.384	4,76 0.187	0,0°	■	■	■															
LPKW09T420TR-D15	2,0 0.079	9,5 0.374	9,75 0.384	4,76 0.187	0,0°				■				■										

Square shoulder and slot milling cutters
Helical milling cutters
Face milling cutters
Disc milling cutters
High feed milling cutters
Copy milling cutters
Plunge milling cutters
Chamfer milling cutters
Spot facing cutters
Inserts

OFER/OFEN/OFMR07

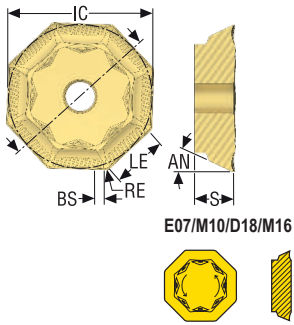

E07/M10/D18/M16

ME10/ME13/ME15/M15

ZZ...M10/M16



Designation	IC	BS	RE	LE	S	AN°	GAN	Grades																
								Coated																Uncoated
	mm <i>Inch</i>	mm <i>Inch</i>	mm <i>Inch</i>	mm <i>Inch</i>	mm <i>Inch</i>			MP1501	MP2050	MP2501	MP3000	MH1000	MM4500	MK1500	MK2050	MS2050	MS2500	T25M	T350M	F15M	F30M	F40M	H15	H25
OFER070405N-E07	17,941 <i>0.706</i>	1,4 <i>0.055</i>	0,5 <i>0.020</i>	7,0 <i>0.276</i>	4,56 <i>0.180</i>	26,0	20,0°														■			■
OFER070405TN-ME10	17,941 <i>0.706</i>	1,4 <i>0.055</i>	0,5 <i>0.020</i>	7,1 <i>0.280</i>	4,56 <i>0.180</i>	26,0	18,0°			■													■	
OFER070405TN-ME15	17,941 <i>0.706</i>	1,4 <i>0.055</i>	0,5 <i>0.020</i>	7,1 <i>0.280</i>	4,56 <i>0.180</i>	26,0	16,0°			■									■				■	
OFER070405N-M10	17,941 <i>0.706</i>	1,4 <i>0.055</i>	0,5 <i>0.020</i>	7,0 <i>0.276</i>	4,56 <i>0.180</i>	26,0	0,0°															■		
OFER070405TN-M16	17,941 <i>0.706</i>	1,4 <i>0.055</i>	0,5 <i>0.020</i>	7,1 <i>0.280</i>	4,56 <i>0.180</i>	26,0	0,0°	■		■				■	■					■			■	
OFMR070405TR-ME13	17,972 <i>0.708</i>	1,0 <i>0.039</i>	0,5 <i>0.020</i>	5,2 <i>0.205</i>	4,86 <i>0.191</i>	26,0	15,0°			■														
OFMR070405TR-M15	17,972 <i>0.708</i>	1,2 <i>0.047</i>	0,5 <i>0.020</i>	5,2 <i>0.205</i>	4,86 <i>0.191</i>	26,0	0,0°			■				■									■	
OFER070405TN-D18	17,96 <i>0.707</i>	2,0 <i>0.079</i>	0,5 <i>0.020</i>	7,0 <i>0.276</i>	4,76 <i>0.187</i>	26,0	0,0°	■		■	■			■										
OFEN0704ZZR-M10	18,081 <i>0.712</i>	6,6 <i>0.260</i>	0,5 <i>0.020</i>	7,5 <i>0.295</i>	4,76 <i>0.187</i>	26,0	0,0°															■		
OFEN0704ZZTR-M16	18,115 <i>0.713</i>	6,6 <i>0.260</i>	0,5 <i>0.020</i>	7,4 <i>0.291</i>	4,74 <i>0.187</i>	26,0	0,0°							■						■				

Square shoulder and slot milling cutters
Helical milling cutters
Face milling cutters
Disc milling cutters
High feed milling cutters
Copy milling cutters
Plunge milling cutters
Chamfer milling cutters
Spot facing cutters
Inserts

OF..05/07

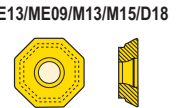
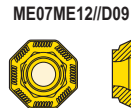
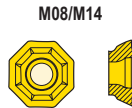
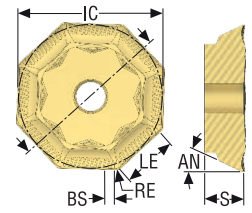

Designation	IC	BS	RE	LE	S	AN°	GAN	Grades																	
								Coated												Uncoated					
	mm <i>Inch</i>	mm <i>Inch</i>	mm <i>Inch</i>	mm <i>Inch</i>	mm <i>Inch</i>			MP1501	MP2050	MP2501	MP3000	MH1000	MM4500	MK1500	MK2050	MS2050	MS2500	T25M	T350M	F15M	F30M	F40M	H15	H25	
OFEX05T305N-E04	12,7 <i>0.500</i>	1,5 <i>0.059</i>	0,5 <i>0.020</i>	4,9 <i>0.193</i>	3,77 <i>0.148</i>	26,0	20,0°																		
OFEX05T305TN-ME07	12,7 <i>0.500</i>	1,5 <i>0.059</i>	0,5 <i>0.020</i>	4,9 <i>0.193</i>	3,77 <i>0.148</i>	26,0	18,0°																		
OFEX05T305N-M05	12,7 <i>0.500</i>	1,5 <i>0.059</i>	0,5 <i>0.020</i>	4,9 <i>0.193</i>	3,77 <i>0.148</i>	26,0	0,0°																		
OFEX05T305TN-M08	12,7 <i>0.500</i>	1,5 <i>0.059</i>	0,5 <i>0.020</i>	4,9 <i>0.193</i>	3,77 <i>0.148</i>	26,0	0,0°																		
OFEX05T305TN-D09	12,806 <i>0.504</i>	1,5 <i>0.059</i>	0,5 <i>0.020</i>	4,9 <i>0.193</i>	3,97 <i>0.156</i>	26,0	0,0°																		
OFMT050405TR-ME12	13,18 <i>0.519</i>	1,5 <i>0.059</i>	0,5 <i>0.020</i>	2,6 <i>0.102</i>	4,76 <i>0.187</i>	26,0	18,0°																		
OFMT070405TN-ME13	17,972 <i>0.708</i>	1,1 <i>0.043</i>	0,5 <i>0.020</i>	7,1 <i>0.280</i>	4,86 <i>0.191</i>	26,0	18,0°																		
OFMT070405TN-M15	17,972 <i>0.708</i>	1,1 <i>0.043</i>	0,5 <i>0.020</i>	7,1 <i>0.280</i>	4,86 <i>0.191</i>	26,0	0,0°																		
OFMT070405TR-M15	17,972 <i>0.708</i>	1,0 <i>0.039</i>	0,5 <i>0.020</i>	5,2 <i>0.205</i>	4,86 <i>0.191</i>	26,0	0,0°																		
OFET070405TN-ME10	17,941 <i>0.706</i>	1,4 <i>0.055</i>	0,5 <i>0.020</i>	7,1 <i>0.280</i>	4,56 <i>0.180</i>	26,0	18,0°																		
OFET070405TN-ME15	17,941 <i>0.706</i>	1,4 <i>0.055</i>	0,5 <i>0.020</i>	7,1 <i>0.280</i>	4,56 <i>0.180</i>	26,0	18,0°																		

Square shoulder and slot milling cutters

Helical milling cutters

Face milling cutters

Disc milling cutters

High feed milling cutters

Copy milling cutters

Plunge milling cutters

Chamfer milling cutters

Spot facing cutters

Inserts

ON.U05/09

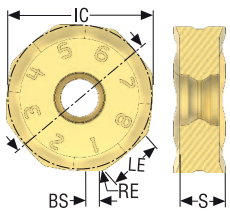

ON.U0504: ME10-11/M10-11

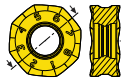

ON.U0905: MD16-17

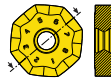

ON.U0905: ME12-13/M12-15

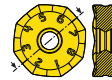

ZZTN4



Designation	*	IC	BS	RE	LE	S	GAN	Grades																	
								Coated						Uncoated											
		mm Inch	mm Inch	mm Inch	mm Inch	mm Inch		MP1501	MP2050	MP2501	MP3000	MH1000	MM4500	MK1500	MK2050	MS2050	MS2500	T25M	T350M	F15M	F30M	F40M	H15	H25	
ONMU050410ANTN-ME10	*	12,0 0.472	0,3 0.012	1,0 0.039	3,9 0.154	4,5 0.177	20,0°						■		■								■		
ONMU050410ANTN-ME11		12,0 0.472	1,0 0.039	1,0 0.039	3,4 0.134	4,5 0.177	20,0°			■	■				■								■		
ONMU050406ANTN-ME14		12,0 0.472	1,3 0.051	0,6 0.024	3,2 0.126	4,5 0.177	25,0°	■		■	■				■	■				■			■		
ONMU050410ANTN-M10	*	12,0 0.472	0,3 0.012	1,0 0.039	4,1 0.161	4,5 0.177	20,0°	■	■	■	■				■					■			■		
ONMU050410ANTN-M11		12,0 0.472	1,0 0.039	1,0 0.039	3,4 0.134	4,5 0.177	20,0°	■	■	■	■			■	■					■					
ONEU050410ZZTN4-M10		12,0 0.472	3,2 0.126	1,0 0.039	-	4,25 0.167	20,0°								■										
ONMU090510ANTN-ME16		22,0 0.866	1,5 0.059	1,0 0.039	6,8 0.268	6,8 0.268	25,0°	■		■	■				■	■				■			■		
ONMU090512TN-ME16		22,0 0.866	0,0 -	1,2 0.047	8,1 0.319	6,8 0.268	25,0°	■	■	■					■	■	■			■					
ONMU090520ANTN-ME12	**	22,0 0.866	0,45 0.018	2,0 0.079	7,3 0.287	6,8 0.268	20,0°	■		■				■		■	■						■		
ONMU090520ANTN-ME13		22,0 0.866	2,11 0.083	2,0 0.079	7,7 0.303	6,8 0.268	20,0°	■		■	■				■	■	■			■			■		
ONMU090510ANTN-M12		22,0 0.866	0,0 -	1,0 0.039	8,3 0.327	6,8 0.268	20,0°		■						■	■	■								
ONMU090520ANTN-M12	**	22,0 0.866	0,45 0.018	2,0 0.079	7,3 0.287	6,8 0.268	20,0°	■	■	■				■		■	■			■			■		
ONMU090520ANTN-M13	***	22,0 0.866	2,11 0.083	2,0 0.079	7,7 0.303	6,8 0.268	20,0°	■		■	■			■	■	■				■			■		
ONMU090520ANTN-M14	***	22,0 0.866	0,45 0.018	2,0 0.079	7,3 0.287	5,56 0.219	15,0°	■		■	■			■	■					■			■		
ONMU090520ANTN-M15		22,0 0.866	2,11 0.083	2,0 0.079	7,7 0.303	5,56 0.219	15,0°	■		■	■			■	■										
ONMU090520ANTN-MD16	***	22,0 0.866	0,45 0.018	2,0 0.079	7,3 0.287	5,56 0.219	0,0°	■		■				■						■					
ONMU090520ANTN-MD17		22,0 0.866	2,11 0.083	2,0 0.079	7,4 0.291	5,56 0.219	0,0°	■		■				■											
ONEU090520ZZTN4-M12		21,41 0.843	6,3 0.248	2,0 0.079	-	6,8 0.268	20,0°	■		■					■										
ONEU090520ZZTN4-M14		21,41 0.843	6,3 0.248	2,0 0.079	-	5,56 0.219	15,0°	■		■				■	■					■			■		

The marked inserts are compatible with these dedicated wiper inserts:

*ONEU050410ZZTN4-M10

**ONEU090520ZZTN4-M12

***ONEU090520ZZTN4-M14

RD..05/06/07/08/10

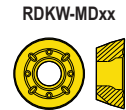
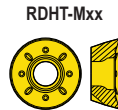
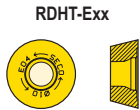
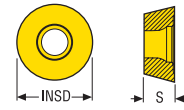

Designation	INSD	S	AN°	GAN	Grades																	
					Coated																Uncoated	
	mm <i>Inch</i>	mm <i>Inch</i>	mm <i>Inch</i>		MP1501	MP2050	MP2501	MP3000	MH1000	MM4500	MK1500	MK2050	MS2050	MS2500	T25M	T350M	F15M	F30M	F40M	H15	H25	
RDHT06T1M0-E02	6,0 <i>0.236</i>	2,18 <i>0.086</i>	15,0 <i>0.591</i>	18,0°																		
RDHT0803M0-E03	8,0 <i>0.315</i>	3,18 <i>0.125</i>	15,0 <i>0.591</i>	20,0°																		
RDHW0501M0-MD01	5,0 <i>0.197</i>	1,51 <i>0.059</i>	15,0 <i>0.591</i>	0,0°																		
RDHW06T1M0-MD02	6,0 <i>0.236</i>	2,18 <i>0.086</i>	15,0 <i>0.591</i>	0,0°																		
RDHW0702M0-MD03	7,0 <i>0.276</i>	2,38 <i>0.094</i>	15,0 <i>0.591</i>	0,0°																		
RDHW0702M0T-MD04	7,0 <i>0.276</i>	2,38 <i>0.094</i>	15,0 <i>0.591</i>	0,0°																		
RDHW0803M0-MD03	8,0 <i>0.315</i>	3,18 <i>0.125</i>	15,0 <i>0.591</i>	0,0°																		
RDKW0803M0T-MD05	8,0 <i>0.315</i>	3,18 <i>0.125</i>	15,0 <i>0.591</i>	0,0°																		
RDHT10T3M0-8-E04	10,0 <i>0.394</i>	3,97 <i>0.156</i>	15,0 <i>0.591</i>	20,0°																		
RDHT10T3M0T-8-M11	10,0 <i>0.394</i>	3,97 <i>0.156</i>	15,0 <i>0.591</i>	16,0°																		
RDHW10T3M0-8-MD04	10,0 <i>0.394</i>	3,97 <i>0.156</i>	15,0 <i>0.591</i>	0,0°																		
RDHW10T3M0T-8-MD06	10,0 <i>0.394</i>	3,97 <i>0.156</i>	15,0 <i>0.591</i>	0,0°																		
RDKT10T3M0T-6-M05	10,0 <i>0.394</i>	3,97 <i>0.156</i>	15,0 <i>0.591</i>	16,0°																		
RDKT10T3M0T-8-M05	10,0 <i>0.394</i>	3,97 <i>0.156</i>	15,0 <i>0.591</i>	16,0°																		
RDKT10T3M0T-8-M07	10,0 <i>0.394</i>	3,97 <i>0.156</i>	15,0 <i>0.591</i>	11,0°																		
RDKW10T3M0T-6-MD06	10,0 <i>0.394</i>	3,97 <i>0.156</i>	15,0 <i>0.591</i>	0,0°																		
RDKW10T3M0T-8-MD06	10,0 <i>0.394</i>	3,97 <i>0.156</i>	15,0 <i>0.591</i>	0,0°																		

Square shoulder and slot milling cutters

Helical milling cutters

Face milling cutters

Disc milling cutters

High feed milling cutters

Copy milling cutters

Plunge milling cutters

Chamfer milling cutters

Spot facing cutters

Inserts

REHR16

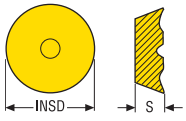

M14/MD15



Designation	INSD	S	Grades																	
			Coated															Uncoated		
	mm Inch	mm Inch	MP1501	MP2050	MP2501	MP3000	MH1000	MM4500	MK1500	MK2050	MS2050	MS2500	T25M	T350M	F15M	F30M	F40M	H15	H25	
REHR1605M0T-MD15	16,0 0.630	5,56 0.219	■																	

RNMU12

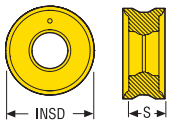

M10



ME10

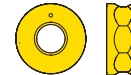

Designation	INSD	S	GAN	Grades																
				Coated															Uncoated	
	mm Inch	mm Inch		MP1501	MP2050	MP2501	MP3000	MH1000	MM4500	MK1500	MK2050	MS2050	MS2500	T25M	T350M	F15M	F30M	F40M	H15	H25
RNMU1204M0-ME10	12,0 0.472	4,8 0.189	27,0 °		■							■	■		■			■		
RNMU1204M0T-M10	12,0 0.472	4,8 0.189	20,0 °		■	■					■	■	■		■			■		

ROHT10/12

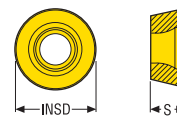

M09/M12/M14



Designation	INSD mm Inch	S mm Inch	GAN	Grades														Uncoated		
				Coated															H15	H25
ROHT1204M0-M12	12,0 0.472	4,76 0.187	10,0 °	MP1501	MP2050	MP2501	MP3000	MH1000	MM4500	MK1500	MK2050	MS2050	MS2500	T25M	T350M	F15M	F30M	F40M	H15	H25
ROHT1204M0-M14	12,0 0.472	4,76 0.187	16,0 °																	

RP.12

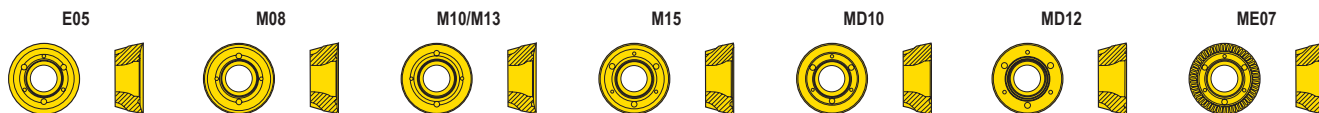
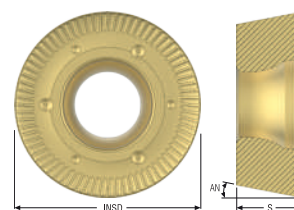

Designation	INSD mm Inch	S mm Inch	AN°	GAN	Grades														Uncoated		
					Coated															H15	H25
RPHT1204M0T-4-M08	12,0 0.472	4,76 0.187	11,0	16,0 °																	
RPKT1204M0T-4-M10	12,0 0.472	4,76 0.187	11,0	11,0 °																	
RPHT1204M0T-4-M13	12,0 0.472	4,76 0.187	11,0	16,0 °																	
RPHT1204M0-6-E05	12,0 0.472	4,76 0.187	11,0	20,0 °																	
RPHT1204M0T-6-ME07	12,0 0.472	4,76 0.187	11,0	20,0 °																	
RPHT1204M0T-6-M08	12,0 0.472	4,76 0.187	11,0	16,0 °																	
RPHT1204M0T-6-M13	12,0 0.472	4,76 0.187	11,0	16,0 °																	
RPKT1204M0T-6-M15	12,0 0.472	4,76 0.187	11,0	15,0 °																	
RPKW1204M0T-6-MD10	12,0 0.472	4,76 0.187	11,0	0,0 °																	
RPHW1204M0T-6-MD12	12,0 0.472	4,76 0.187	11,0	0,0 °																	

Square shoulder and slot milling cutters

Helical milling cutters

Face milling cutters

Disc milling cutters

High feed milling cutters

Copy milling cutters

Plunge milling cutters

Chamfer milling cutters

Spot facing cutters

Inserts

RP..16/19/20

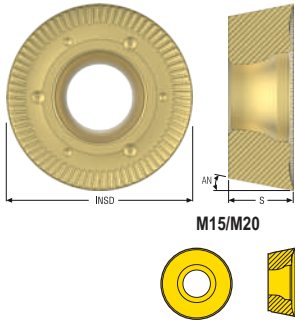

M15/M20

MD10/MD22

ME12

Designation	INSD	S	AN°	GAN	Grades																	
					Coated										Uncoated							
	mm <i>Inch</i>	mm <i>Inch</i>			MP1501	MP2050	MP2501	MP3000	MH1000	MM4500	MK1500	MK2050	MS2050	MS2500	T25M	T350M	F15M	F30M	F40M	H15	H25	
RPHT1605M0T-6-ME11	16,0 <i>0.630</i>	5,56 <i>0.219</i>	11,0	21,0 °									■									■
RPHT1605M0T-6-M12	16,0 <i>0.630</i>	5,56 <i>0.219</i>	11,0	15,0 °																		■
RPKT1605M0T-6-M18	16,0 <i>0.630</i>	5,56 <i>0.219</i>	11,0	15,0 °			■							■								
RPKW1605M0T-6-MD20	16,0 <i>0.630</i>	5,56 <i>0.219</i>	11,0	0,0 °	■		■					■		■								
RPHT1605M0T-8-ME11	16,0 <i>0.630</i>	5,56 <i>0.219</i>	11,0	21,0 °		■				■			■	■		■					■	
RPHT1605M0T-8-M12	16,0 <i>0.630</i>	5,56 <i>0.219</i>	11,0	15,0 °		■				■			■								■	
RPKT1605M0T-8-M12	16,0 <i>0.630</i>	5,56 <i>0.219</i>	11,0	15,0 °			■							■		■						
RPKT1605M0T-8-M18	16,0 <i>0.630</i>	5,56 <i>0.219</i>	11,0	15,0 °	■		■	■				■		■		■					■	
RPKW1605M0T-8-MD20	16,0 <i>0.630</i>	5,56 <i>0.219</i>	11,0	0,0 °	■		■										■					
RPHT190600T-6-M13	19,05 <i>0.750</i>	6,39 <i>0.252</i>	11,0	16,0 °									■	■		■					■	
RPHT2006M0T-ME12	20,0 <i>0.787</i>	6,35 <i>0.250</i>	11,0	20,0 °		■	■			■			■	■		■					■	
RPKT2006M0T-M15	20,0 <i>0.787</i>	6,35 <i>0.250</i>	11,0	15,0 °			■							■		■					■	
RPKT2006M0T-M20	20,0 <i>0.787</i>	6,35 <i>0.250</i>	11,0	15,0 °	■		■					■		■		■					■	
RPKW2006M0-MD10	20,0 <i>0.787</i>	6,35 <i>0.250</i>	11,0	0,0 °															■		■	
RPKW2006M0T-MD22	20,0 <i>0.787</i>	6,35 <i>0.250</i>	11,0	0,0 °	■							■		■			■					

SC..12

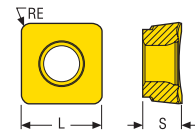

M10/M11/M14/MD15/MD16

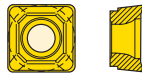

ME10

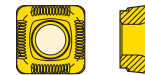

Designation	RE	L	S	GAN	Grades																	
					Coated											Uncoated						
	mm Inch	mm Inch	mm Inch		MP1501	MP2050	MP2501	MP3000	MH1000	MM4500	MK1500	MK2050	MS2050	MS2500	T25M	T350M	F15M	F30M	F40M	H15	H25	
SCET120612R-M10	1,2 0.047	12,673 0.499	6,35 0.250	20,0°									■									
SCET120612T-ME10	1,2 0.047	12,7 0.500	6,35 0.250	22,0°									■							■		
SCET120612T-M11	1,2 0.047	12,7 0.500	6,35 0.250	14,0°	■		■				■					■				■		
SCET120612T-M14	1,2 0.047	12,7 0.500	6,35 0.250	15,0°			■				■		■			■				■		
SCET120612T-MD15	1,2 0.047	12,7 0.500	6,35 0.250	15,0°	■			■								■						
SCET120630T-M14	3,0 0.118	12,7 0.500	6,35 0.250	15,0°			■	■				■	■	■		■				■		
SCET120630T-MD16	3,0 0.118	12,7 0.500	6,35 0.250	15,0°	■		■							■		■				■		
SCEX120660T-M14	6,0 0.236	12,7 0.500	6,35 0.250	15,0°												■						
SCMT120612T-M14	1,2 0.047	12,7 0.500	6,35 0.250	15,0°												■				■		

SEAN12-ZZ

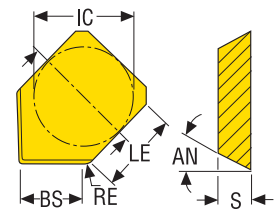

M15-18/MD15

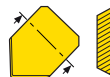

Designation	IC	BS	RE	LE	S	AN°	GAN	Grades																
								Coated											Uncoated					
	mm Inch	mm Inch	mm Inch	mm Inch	mm Inch			MP1501	MP2050	MP2501	MP3000	MH1000	MM4500	MK1500	MK2050	MS2050	MS2500	T25M	T350M	F15M	F30M	F40M	H15	H25
SEAN1203ZZTN-M15	12,7 0.500	7,3 0.287	1,0 0.039	9,3 0.366	3,18 0.125	20,0	0,0°							■										
SEAN1203ZZTN-MD15	12,7 0.500	7,3 0.287	1,0 0.039	9,3 0.366	3,18 0.125	20,0	0,0°	■																
SEAN1504ZZTN-M18	15,875 0.625	9,3 0.366	1,0 0.039	12,1 0.476	4,76 0.187	20,0	0,0°							■										

Square shoulder and slot milling cutters

Helical milling cutters

Face milling cutters

Disc milling cutters

High feed milling cutters

Copy milling cutters

Plunge milling cutters

Chamfer milling cutters

Spot facing cutters

Inserts

SEAN12

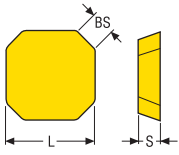

E12-E15/M14-M19

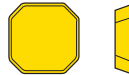

Designation	RE	BS	L	S	GAN	Grades																	
						Coated														Uncoated			
	mm Inch	mm Inch	mm Inch	mm Inch		MP1501	MP2050	MP2501	MP3000	MH1000	MM4500	MK1500	MK2050	MS2050	MS2500	T25M	T350M	F15M	F30M	F40M	H15	H25	
SEAN1203AFN-E12	1,0 0.039	1,5 0.059	12,7 0.500	3,18 0.125	0,0°													■					
SEAN1203AFTN-M14	1,0 0.039	1,5 0.059	12,7 0.500	3,18 0.125	0,0°											■							
SEAN1303AFTN-M14	0,8 0.031	3,5 0.138	13,44 0.529	3,36 0.132	0,0°												■						
SEAN1303AFTN-M15	0,8 0.031	3,5 0.138	13,44 0.529	3,36 0.132	0,0°							■											
SEAN1604AFTN-M19	1,0 0.039	4,1 0.161	16,8 0.661	4,79 0.189	0,0°							■											

SE.X09

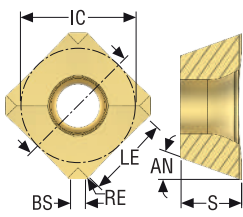

D09/M05/ME07



E04/E08/MD18MD19



ME06/M08



Designation	IC	BS	RE	LE	S	AN°	GAN	Grades																
								Coated														Uncoated		
	mm Inch	mm Inch	mm Inch	mm Inch	mm Inch			MP1501	MP2050	MP2501	MP3000	MH1000	MM4500	MK1500	MK2050	MS2050	MS2500	T25M	T350M	F15M	F30M	F40M	H15	H25
SEEX09T3AFN-E04	9,525 0.375	1,5 0.059	0,3 0.012	7,1 0.280	3,97 0.156	20,0	25,0°													■			■	
SEEX09T3AFN-M05	9,525 0.375	1,5 0.059	0,3 0.012	7,1 0.280	3,97 0.156	20,0	0,0°				■					■						■		
SEEX09T3AFTN-M08	9,525 0.375	1,5 0.059	0,3 0.012	7,1 0.280	3,97 0.156	20,0	0,0°							■	■				■			■		
SEEX09T3AFTN-ME07	9,525 0.375	1,5 0.059	0,3 0.012	7,1 0.280	3,97 0.156	20,0	22,0°			■								■	■			■		
SEEX09T3AFTN-D09	9,525 0.375	1,5 0.059	0,3 0.012	7,1 0.280	3,97 0.156	20,0	0,0°	■																
SEMX09T3AFTN-M08	9,525 0.375	1,5 0.059	0,3 0.012	7,1 0.280	3,97 0.156	20,0	0,0°			■									■			■		
SEMX09T3AFTN-ME06	9,525 0.375	1,5 0.059	0,3 0.012	7,1 0.280	3,97 0.156	20,0	22,0°			■												■		

SE.X12/15

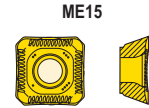
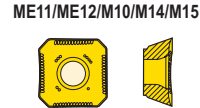
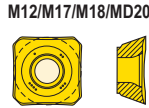
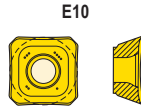
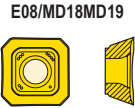
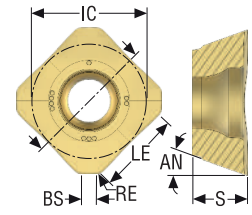

Designation	IC	BS	RE	LE	S	AN°	GAN	Grades																	
								Coated												Uncoated					
	mm Inch	mm Inch	mm Inch	mm Inch	mm Inch			MP1501	MP2050	MP2501	MP3000	MH1000	MM4500	MK1500	MK2050	MS2050	MS2500	T25M	T350M	F15M	F30M	F40M	H15	H25	
SEEX1204AFN-E08	12,7 0.500	1,5 0.059	1,12 0.044	8,7 0.343	4,76 0.187	20,0	25,0°																		
SEEX1204AFTN-ME11	12,7 0.500	1,5 0.059	1,12 0.044	8,7 0.343	4,76 0.187	20,0	21,0°			■			■						■				■		
SEEX1204AFN-M10	12,7 0.500	1,5 0.059	1,12 0.044	8,7 0.343	4,76 0.187	20,0	5,0°			■	■		■			■			■			■			
SEEX1204AFTN-M14	12,7 0.500	1,5 0.059	1,12 0.044	8,7 0.343	4,76 0.187	20,0	5,0°	■		■				■	■				■			■			
SEEX1204ZZTN-M14	12,7 0.500	7,4 0.291	1,12 0.044	8,7 0.343	4,76 0.187	20,0	5,0°	■		■				■					■		■	■			
SEEX1204AFTN-MD18	12,7 0.500	1,5 0.059	1,12 0.044	8,7 0.343	4,76 0.187	20,0	0,0°	■											■						
SEM1204AFTN-ME12	12,7 0.500	1,5 0.059	1,12 0.044	8,7 0.343	4,76 0.187	20,0	21,0°			■									■				■		
SEM1204AFTN-M15	12,7 0.500	1,5 0.059	1,12 0.044	8,7 0.343	4,76 0.187	20,0	4,0°	■		■			■	■	■				■			■			
SEM1204AFTN-MD19	12,7 0.500	1,5 0.059	1,12 0.044	8,7 0.343	4,76 0.187	20,0	0,0°	■			■			■					■						
SEEX1505AFN-E10	15,875 0.625	1,8 0.071	1,5 0.059	10,3 0.406	5,56 0.219	20,0	25,0°																	■	
SEEX1505AFN-M12	15,875 0.625	1,8 0.071	1,5 0.059	10,3 0.406	5,56 0.219	20,0	5,0°		■							■							■		
SEEX1505AFTN-M17	15,875 0.625	1,8 0.071	1,5 0.059	10,3 0.406	5,56 0.219	20,0	5,0°			■									■						
SEEX1505ZZTN-M17	15,875 0.625	9,4 0.370	1,5 0.059	10,3 0.406	5,56 0.219	20,0	5,0°			■									■						
SEM1505AFTN-ME15	15,875 0.625	1,8 0.071	1,5 0.059	10,3 0.406	5,56 0.219	20,0	21,0°												■				■		
SEM1505AFTN-M18	15,875 0.625	1,8 0.071	1,5 0.059	10,3 0.406	5,56 0.219	20,0	5,0°	■		■				■	■				■			■			
SEM1505AFTN-MD20	15,875 0.625	1,8 0.071	1,5 0.059	10,3 0.406	5,56 0.219	20,0	0,0°	■		■	■								■						

- Square shoulder and slot milling cutters
- Helical milling cutters
- Face milling cutters
- Disc milling cutters
- High feed milling cutters
- Copy milling cutters
- Plunge milling cutters
- Chamfer milling cutters
- Spot facing cutters
- Inserts

SE..12/15

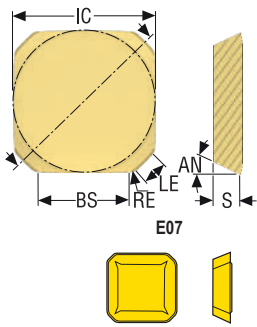

E10-15/M13-18/MD14-20/D16

ME10/ME12/ME13/ME16

SEEX1203AFTN-M13/MD14

Designation	IC	BS	RE	LE	S	AN°	GAN	Grades																
								Coated																Uncoated
	mm Inch	mm Inch	mm Inch	mm Inch	mm Inch			MP1501	MP2050	MP2501	MP3000	MH1000	MM4500	MK1500	MK2050	MS2050	MS2500	T25M	T350M	F15M	F30M	F40M	H15	H25
SEKR1203AFN-E07	12,7 0.500	1,5 0.059	1,0 0.039	8,8 0.346	3,18 0.125	20,0	18,0°											■					■	
SEKR1203AFTN-ME10	12,7 0.500	1,5 0.059	1,0 0.039	8,8 0.346	3,18 0.125	20,0	20,0°											■					■	
SEKR1203AFTN-ME13	12,7 0.500	1,5 0.059	1,0 0.039	8,8 0.346	3,18 0.125	20,0	25,5°			■								■	■				■	
SEKR1504AFTN-ME16	15,875 0.625	1,5 0.059	1,0 0.039	11,6 0.457	4,76 0.187	20,0	20,0°											■						
SEKR1604AFTN-ME16	16,8 0.661	4,1 0.161	1,0 0.039	-	4,79 0.189	20,0	20,0°											■						
SEEX1203AFTN-M13	12,77 0.503	8,0 0.315	1,0 0.039	2,2 0.087	3,18 0.125	20,0	0,0°												■					
SEEX1203AFTN-MD14	12,77 0.503	8,0 0.315	1,0 0.039	2,2 0.087	3,18 0.125	20,0	0,0°					■		■						■				■
SEKN1203AFTN-E10	12,7 0.500	2,3 0.091	0,0 -	8,8 0.346	3,18 0.125	20,0	0,0°															■		
SEKN1203AFN-E12	12,7 0.500	1,6 0.063	2,0 0.079	8,8 0.346	3,18 0.125	20,0	0,0°																■	
SEKN1203AFTN-M14	12,7 0.500	1,5 0.059	1,0 0.039	8,8 0.346	3,18 0.125	20,0	0,0°	■		■				■	■			■	■				■	
SEKN1203AFTN-D16	12,7 0.500	1,6 0.063	2,0 0.079	8,8 0.346	3,18 0.125	20,0	0,0°	■																
SEKN1504AFTN-M18	15,87 0.625	1,5 0.059	1,0 0.039	11,6 0.457	4,76 0.187	20,0	0,0°			■				■				■					■	
SEKN1504AFTN-MD20	15,87 0.625	1,9 0.075	2,0 0.079	11,6 0.457	4,76 0.187	20,0	0,0°	■																

- Square shoulder and slot milling cutters
- Helical milling cutters
- Face milling cutters
- Disc milling cutters
- High feed milling cutters
- Copy milling cutters
- Plunge milling cutters
- Chamfer milling cutters
- Spot facing cutters
- Inserts

SNHQ11

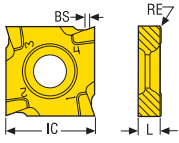

E05/M07

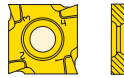

Designation	RE	BS	L	IC	GAN	Grades																	
						Coated										Uncoated							
	mm Inch	mm Inch	mm Inch	mm Inch		MP1501	MP2050	MP2501	MP3000	MH1000	MM4500	MK1500	MK2050	MS2050	MS2500	T25M	T350M	F15M	F30M	F40M	H15	H25	
SNHQ110202EL4-E05	0,2 0.008	0,5 0.020	2,3 0.091	11,0 0.433	20,0°																		■
SNHQ110202ER4-E05	0,2 0.008	0,5 0.020	2,3 0.091	11,0 0.433	20,0°																		■
SNHQ110202TL4-M07	0,2 0.008	0,5 0.020	2,3 0.091	11,0 0.433	20,0°																■		
SNHQ110202TR4-M07	0,2 0.008	0,5 0.020	2,3 0.091	11,0 0.433	20,0°																■		
SNHQ110204TL4-M07	0,4 0.016	0,3 0.012	2,3 0.091	11,0 0.433	20,0°			■												■	■		
SNHQ110204TR4-M07	0,4 0.016	0,3 0.012	2,3 0.091	11,0 0.433	20,0°			■											■	■			
SNHQ110208TL4-M07	0,8 0.031	0,2 0.008	2,3 0.091	11,0 0.433	20,0°						■			■							■		
SNHQ110208TR4-M07	0,8 0.031	0,2 0.008	2,3 0.091	11,0 0.433	20,0°						■			■							■		
SNHQ110212TL4-M07	1,2 0.047	0,2 0.008	2,3 0.091	11,0 0.433	20,0°																■		
SNHQ110212TR4-M07	1,2 0.047	0,2 0.008	2,3 0.091	11,0 0.433	20,0°																■		
SNHQ110216TL4-M07	1,6 0.063	0,2 0.008	2,3 0.091	11,0 0.433	20,0°																■		
SNHQ110216TR4-M07	1,6 0.063	0,2 0.008	2,3 0.091	11,0 0.433	20,0°																■		
SNHQ110220TL4-M07	2,0 0.079	0,0 -	2,3 0.091	11,0 0.433	20,0°															■			
SNHQ110220TR4-M07	2,0 0.079	0,0 -	2,3 0.091	11,0 0.433	20,0°															■			
SNHQ110302EL4-E05	0,2 0.008	0,5 0.020	2,7 0.106	11,0 0.433	20,0°																		■
SNHQ110302ER4-E05	0,2 0.008	0,5 0.020	2,7 0.106	11,0 0.433	20,0°																		■
SNHQ110302TL4-M07	0,2 0.008	0,5 0.020	2,7 0.106	11,0 0.433	20,0°																■		
SNHQ110302TR4-M07	0,2 0.008	0,5 0.020	2,7 0.106	11,0 0.433	20,0°																■		
SNHQ110304TL4-M07	0,4 0.016	0,3 0.012	2,7 0.106	11,0 0.433	20,0°			■												■	■		
SNHQ110304TR4-M07	0,4 0.016	0,3 0.012	2,7 0.106	11,0 0.433	20,0°			■												■	■		
SNHQ110308TL4-M07	0,8 0.031	0,2 0.008	2,7 0.106	11,0 0.433	20,0°																■		
SNHQ110308TR4-M07	0,8 0.031	0,2 0.008	2,7 0.106	11,0 0.433	20,0°																■		
SNHQ110312TL4-M07	1,2 0.047	0,2 0.008	2,7 0.106	11,0 0.433	20,0°																■		

Designation	RE	BS	L	IC	GAN	Grades																	
						Coated												Uncoated					
	mm Inch	mm Inch	mm Inch	mm Inch		MP1501	MP2050	MP2501	MP3000	MH1000	MM4500	MK1500	MK2050	MS2050	MS2500	T25M	T350M	F15M	F30M	F40M	H15	H25	
SNHQ110312TR4-M07	1.2 0.047	0.2 0.008	2.7 0.106	11.0 0.433	20,0 °																		
SNHQ110316TL4-M07	1.6 0.063	0.2 0.008	2.7 0.106	11.0 0.433	20,0 °																		
SNHQ110316TR4-M07	1.6 0.063	0.2 0.008	2.7 0.106	11.0 0.433	20,0 °																		
SNHQ110320TL4-M07	2.0 0.079	0.0 -	2.7 0.106	11.0 0.433	20,0 °																		
SNHQ110320TR4-M07	2.0 0.079	0.0 -	2.7 0.106	11.0 0.433	20,0 °																		

Square shoulder and slot milling cutters

Helical milling cutters

Face milling cutters

Disc milling cutters

High feed milling cutters

Copy milling cutters

Plunge milling cutters

Chamfer milling cutters

Spot facing cutters

Inserts

SNHQ1203/1204

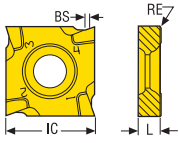

EL/ER2-E05/M07

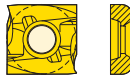

xL/xR4-E05/M07



Designation	RE	BS	L	IC	GAN	Grades																			
						Coated												Uncoated							
	mm Inch	mm Inch	mm Inch	mm Inch		MP1501	MP2050	MP2501	MP3000	MH1000	MM4500	MK1500	MK2050	MS2050	MS2500	T25M	T350M	F15M	F25M	F30M	F40M	HX	H15	H25	
SNHQ120302EL4-E05	0,2 0.008	0,75 0.030	3,2 0.126	12,7 0.500	20,0°																				■
SNHQ120302ER4-E05	0,2 0.008	0,75 0.030	3,2 0.126	12,7 0.500	20,0°																				■
SNHQ120302TL4-M07	0,2 0.008	0,75 0.030	3,2 0.126	12,7 0.500	20,0°																	■			
SNHQ120302TR4-M07	0,2 0.008	0,75 0.030	3,2 0.126	12,7 0.500	20,0°																	■			
SNHQ120304TL4-M07	0,4 0.016	0,75 0.030	3,2 0.126	12,7 0.500	20,0°			■													■	■			
SNHQ120304TR4-M07	0,4 0.016	0,75 0.030	3,2 0.126	12,7 0.500	20,0°			■													■	■			
SNHQ120308TL4-M07	0,8 0.031	0,75 0.030	3,2 0.126	12,7 0.500	20,0°			■														■			
SNHQ120308TR4-M07	0,8 0.031	0,75 0.030	3,2 0.126	12,7 0.500	20,0°			■														■			
SNHQ120310TL4-M07	1,0 0.039	0,6 0.024	3,2 0.126	12,7 0.500	20,0°																	■			
SNHQ120310TR4-M07	1,0 0.039	0,6 0.024	3,2 0.126	12,7 0.500	20,0°																	■			
SNHQ120312TL4-M07	1,2 0.047	0,4 0.016	3,2 0.126	12,7 0.500	20,0°																	■			
SNHQ120312TR4-M07	1,2 0.047	0,4 0.016	3,2 0.126	12,7 0.500	20,0°																	■			
SNHQ120316TL4-M07	1,6 0.063	0,2 0.008	3,2 0.126	12,7 0.500	20,0°																	■			
SNHQ120316TR4-M07	1,6 0.063	0,2 0.008	3,2 0.126	12,7 0.500	20,0°																	■			
SNHQ120320TL4-M07	2,0 0.079	0,2 0.008	3,2 0.126	12,7 0.500	20,0°																	■			
SNHQ120320TR4-M07	2,0 0.079	0,2 0.008	3,2 0.126	12,7 0.500	20,0°																	■			
SNHQ120324EL2-M07	2,4 0.094	0,0 -	3,2 0.126	12,7 0.500	20,0°																	■			
SNHQ120324ER2-M07	2,4 0.094	0,0 -	3,2 0.126	12,7 0.500	20,0°																	■			
SNHQ120330EL2-M07	3,0 0.118	0,0 -	3,2 0.126	12,7 0.500	20,0°																	■			
SNHQ120330ER2-M07	3,0 0.118	0,0 -	3,2 0.126	12,7 0.500	20,0°																	■			
SNHQ120404EL4-E05	0,4 0.016	0,75 0.030	4,0 0.157	12,7 0.500	20,0°																				■
SNHQ120404ER4-E05	0,4 0.016	0,75 0.030	4,0 0.157	12,7 0.500	20,0°																				■
SNHQ120402TL4-M07	0,2 0.008	0,75 0.030	4,0 0.157	12,7 0.500	20,0°																	■			

Designation	RE	BS	L	IC	GAN	Grades															Uncoated				
						Coated															HX	H15	H25		
	mm Inch	mm Inch	mm Inch	mm Inch		MP1501	MP2050	MP2501	MP3000	MH1000	MM4500	MK1500	MK2050	MS2050	MS2500	T25M	T350M	F15M	F25M	F30M				F40M	
SNHQ120402TR4-M07	0,2 0.008	0,75 0.030	4,0 0.157	12,7 0.500	20,0 °																				
SNHQ120404TL4-M07	0,4 0.016	0,75 0.030	4,0 0.157	12,7 0.500	20,0 °																				
SNHQ120404TR4-M07	0,4 0.016	0,75 0.030	4,0 0.157	12,7 0.500	20,0 °																				
SNHQ120408TL4-M07	0,8 0.031	0,75 0.030	4,0 0.157	12,7 0.500	20,0 °																				
SNHQ120408TR4-M07	0,8 0.031	0,75 0.030	4,0 0.157	12,7 0.500	20,0 °																				
SNHQ120412TL4-M07	1,2 0.047	0,4 0.016	4,0 0.157	12,7 0.500	20,0 °																				
SNHQ120412TR4-M07	1,2 0.047	0,4 0.016	4,0 0.157	12,7 0.500	20,0 °																				
SNHQ120416TL4-M07	1,6 0.063	0,2 0.008	4,0 0.157	12,7 0.500	20,0 °																				
SNHQ120416TR4-M07	1,6 0.063	0,2 0.008	4,0 0.157	12,7 0.500	20,0 °																				
SNHQ120420TL4-M07	2,0 0.079	0,2 0.008	4,0 0.157	12,7 0.500	20,0 °																				
SNHQ120420TR4-M07	2,0 0.079	0,2 0.008	4,0 0.157	12,7 0.500	20,0 °																				
SNHQ120424EL2-M07	2,4 0.094	0,0 -	4,0 0.157	12,7 0.500	20,0 °																				
SNHQ120424ER2-M07	2,4 0.094	0,0 -	4,0 0.157	12,7 0.500	20,0 °																				
SNHQ120431EL2-M07	3,1 0.122	0,0 -	4,0 0.157	12,7 0.500	20,0 °																				
SNHQ120431ER2-M07	3,1 0.122	0,0 -	4,0 0.157	12,7 0.500	20,0 °																				
SNHQ120435EL2-M07	3,5 0.138	0,0 -	4,0 0.157	12,7 0.500	20,0 °																				
SNHQ120435ER2-M07	3,5 0.138	0,0 -	4,0 0.157	12,7 0.500	20,0 °																				

- Square shoulder and slot milling cutters
- Helical milling cutters
- Face milling cutters
- Disc milling cutters
- High feed milling cutters
- Copy milling cutters
- Plunge milling cutters
- Chamfer milling cutters
- Spot facing cutters
- Inserts

SNHQ12045

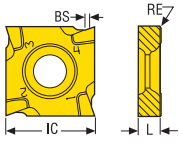

EL/ER2-M07



xLxR4-E05/M07

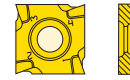

Designation	RE	BS	L	IC	GAN	Grades																	
						Coated												Uncoated					
	mm Inch	mm Inch	mm Inch	mm Inch		MP1501	MP2050	MP2501	MP3000	MH1000	MM4500	MK1500	MK2050	MS2050	MS2500	T25M	T350M	F15M	F30M	F40M	H15	H25	
SNHQ1204504EL4-E05	0,4 0.016	0,75 0.030	4,5 0.177	12,7 0.500	20,0 °																		■
SNHQ1204504ER4-E05	0,4 0.016	0,75 0.030	4,5 0.177	12,7 0.500	20,0 °																		■
SNHQ1204502TL4-M07	0,2 0.008	0,75 0.030	4,5 0.177	12,7 0.500	20,0 °																■		
SNHQ1204502TR4-M07	0,2 0.008	0,75 0.030	4,5 0.177	12,7 0.500	20,0 °																■		
SNHQ1204504TL4-M07	0,4 0.016	0,75 0.030	4,5 0.177	12,7 0.500	20,0 °			■												■	■		
SNHQ1204504TR4-M07	0,4 0.016	0,75 0.030	4,5 0.177	12,7 0.500	20,0 °			■											■	■			
SNHQ1204508TL4-M07	0,8 0.031	0,75 0.030	4,5 0.177	12,7 0.500	20,0 °			■													■		
SNHQ1204508TR4-M07	0,8 0.031	0,75 0.030	4,5 0.177	12,7 0.500	20,0 °			■													■		
SNHQ1204512TL4-M07	1,2 0.047	0,4 0.016	4,5 0.177	12,7 0.500	20,0 °																■		
SNHQ1204512TR4-M07	1,2 0.047	0,4 0.016	4,5 0.177	12,7 0.500	20,0 °																■		
SNHQ1204516TL4-M07	1,6 0.063	0,2 0.008	4,5 0.177	12,7 0.500	20,0 °																■		
SNHQ1204516TR4-M07	1,6 0.063	0,2 0.008	4,5 0.177	12,7 0.500	20,0 °																■		
SNHQ1204520TL4-M07	2,0 0.079	0,2 0.008	4,5 0.177	12,7 0.500	20,0 °																■		
SNHQ1204520TR4-M07	2,0 0.079	0,2 0.008	4,5 0.177	12,7 0.500	20,0 °																■		
SNHQ1204524EL2-M07	2,4 0.094	0,0 -	4,5 0.177	12,7 0.500	20,0 °																■		
SNHQ1204524ER2-M07	2,4 0.094	0,0 -	4,5 0.177	12,7 0.500	20,0 °																■		
SNHQ1204531EL2-M07	3,1 0.122	0,0 -	4,5 0.177	12,7 0.500	20,0 °																■		
SNHQ1204531ER2-M07	3,1 0.122	0,0 -	4,5 0.177	12,7 0.500	20,0 °																■		
SNHQ1204540EL2-M07	4,0 0.157	0,0 -	4,5 0.177	12,7 0.500	20,0 °																■		
SNHQ1204540ER2-M07	4,0 0.157	0,0 -	4,5 0.177	12,7 0.500	20,0 °																■		

Square shoulder and slot milling cutters
Helical milling cutters
Face milling cutters
Disc milling cutters
High feed milling cutters
Copy milling cutters
Plunge milling cutters
Chamfer milling cutters
Spot facing cutters
Inserts

SNHQ1205

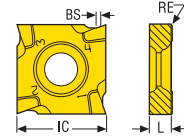

ER/EL2-M07



xL/xR4-E05/M07



Designation	RE	BS	L	IC	GAN	Grades																	
						Coated												Uncoated					
	mm Inch	mm Inch	mm Inch	mm Inch		MP1501	MP2050	MP2501	MP3000	MH1000	MM4500	MK1500	MK2050	MS2050	MS2500	T25M	T350M	F15M	F30M	F40M	H15	H25	
SNHQ120504EL4-E05	0,4 0.016	0,75 0.030	5,4 0.213	12,7 0.500	20,0 °																		■
SNHQ120504ER4-E05	0,4 0.016	0,75 0.030	5,4 0.213	12,7 0.500	20,0 °																		■
SNHQ120502TL4-M07	0,2 0.008	0,75 0.030	5,4 0.213	12,7 0.500	20,0 °																	■	
SNHQ120502TR4-M07	0,2 0.008	0,75 0.030	5,4 0.213	12,7 0.500	20,0 °																	■	
SNHQ120504TL4-M07	0,4 0.016	0,75 0.030	5,4 0.213	12,7 0.500	20,0 °			■			■									■	■		
SNHQ120504TR4-M07	0,4 0.016	0,75 0.030	5,4 0.213	12,7 0.500	20,0 °			■			■									■	■		
SNHQ120508TL4-M07	0,8 0.031	0,75 0.030	5,4 0.213	12,7 0.500	20,0 °			■												■	■		
SNHQ120508TR4-M07	0,8 0.031	0,75 0.030	5,4 0.213	12,7 0.500	20,0 °			■												■	■		
SNHQ120510TL4-M07	1,0 0.039	0,6 0.024	5,4 0.213	12,7 0.500	20,0 °																	■	
SNHQ120510TR4-M07	1,0 0.039	0,6 0.024	5,4 0.213	12,7 0.500	20,0 °																	■	
SNHQ120512TL4-M07	1,2 0.047	0,4 0.016	5,4 0.213	12,7 0.500	20,0 °																	■	
SNHQ120512TR4-M07	1,2 0.047	0,4 0.016	5,4 0.213	12,7 0.500	20,0 °																	■	
SNHQ120516TL4-M07	1,6 0.063	0,2 0.008	5,4 0.213	12,7 0.500	20,0 °																	■	
SNHQ120516TR4-M07	1,6 0.063	0,2 0.008	5,4 0.213	12,7 0.500	20,0 °																	■	
SNHQ120520TL4-M07	2,0 0.079	0,2 0.008	5,4 0.213	12,7 0.500	20,0 °																	■	
SNHQ120520TR4-M07	2,0 0.079	0,2 0.008	5,4 0.213	12,7 0.500	20,0 °																	■	
SNHQ120524EL2-M07	2,4 0.094	0,0 -	5,4 0.213	12,7 0.500	20,0 °																	■	
SNHQ120524ER2-M07	2,4 0.094	0,0 -	5,4 0.213	12,7 0.500	20,0 °																	■	
SNHQ120531EL2-M07	3,1 0.122	0,0 -	5,4 0.213	12,7 0.500	20,0 °																	■	
SNHQ120531ER2-M07	3,1 0.122	0,0 -	5,4 0.213	12,7 0.500	20,0 °																	■	
SNHQ120540EL2-M07	4,0 0.157	0,0 -	5,4 0.213	12,7 0.500	20,0 °																	■	
SNHQ120540ER2-M07	4,0 0.157	0,0 -	5,4 0.213	12,7 0.500	20,0 °																	■	
SNHQ120550FEL2-M07	5,0 0.197	0,0 -	5,4 0.218	12,7 0.500	20,0 °																	■	

- Square shoulder and slot milling cutters
- Helical milling cutters
- Face milling cutters
- Disc milling cutters
- High feed milling cutters
- Copy milling cutters
- Plunge milling cutters
- Chamfer milling cutters
- Spot facing cutters
- Inserts

Designation	RE	BS	L	IC	GAN	Grades																	
						Coated										Uncoated							
	mm Inch	mm Inch	mm Inch	mm Inch		MP1501	MP2050	MP2501	MP3000	MH1000	MM4500	MK1500	MK2050	MS2050	MS2500	T25M	T350M	F15M	F30M	F40M	H15	H25	
SNHQ120550FER2-M07	5,0 0.197	0,0 -	5,54 0.218	12,7 0.500	20,0 °																■		

Note: When using SNHQ insert with corner radius = 5 mm, please modify the external profile of the cutter by adding a corner radius or chamfer = 4 mm

- Square shoulder and slot milling cutters
- Helical milling cutters
- Face milling cutters
- Disc milling cutters
- High feed milling cutters
- Copy milling cutters
- Plunge milling cutters
- Chamfer milling cutters
- Spot facing cutters
- Inserts

SNHQ1207

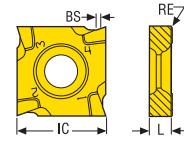

EL/ER2-M07

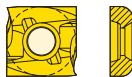

xL/xR4-E05/M07



Designation	RE	BS	L	IC	GAN	Grades																	
						Coated										Uncoated							
	mm Inch	mm Inch	mm Inch	mm Inch		MP1501	MP2050	MP2501	MP3000	MH1000	MM4500	MK1500	MK2050	MS2050	MS2500	T25M	T350M	F15M	F30M	F40M	H15	H25	
SNHQ120704EL4-E05	0,4 0.016	0,75 0.030	7,0 0.276	12,7 0.500	20,0 °																		■
SNHQ120704ER4-E05	0,4 0.016	0,75 0.030	7,0 0.276	12,7 0.500	20,0 °																		■
SNHQ120704TL4-M07	0,4 0.016	0,75 0.030	7,0 0.276	12,7 0.500	20,0 °																■		
SNHQ120704TR4-M07	0,4 0.016	0,75 0.030	7,0 0.276	12,7 0.500	20,0 °																■		
SNHQ120708TL4-M07	0,8 0.031	0,75 0.030	7,0 0.276	12,7 0.500	20,0 °			■												■	■		
SNHQ120708TR4-M07	0,8 0.031	0,75 0.030	7,0 0.276	12,7 0.500	20,0 °			■												■	■		
SNHQ120712TL4-M07	1,2 0.047	0,4 0.016	7,0 0.276	12,7 0.500	20,0 °																■		
SNHQ120712TR4-M07	1,2 0.047	0,4 0.016	7,0 0.276	12,7 0.500	20,0 °																■		
SNHQ120716TL4-M07	1,6 0.063	0,2 0.008	7,0 0.276	12,7 0.500	20,0 °																■		
SNHQ120716TR4-M07	1,6 0.063	0,2 0.008	7,0 0.276	12,7 0.500	20,0 °																■		
SNHQ120720TL4-M07	2,0 0.079	0,2 0.008	7,0 0.276	12,7 0.500	20,0 °																■		
SNHQ120720TR4-M07	2,0 0.079	0,2 0.008	7,0 0.276	12,7 0.500	20,0 °																■		
SNHQ120724EL2-M07	2,4 0.094	0,0 -	7,0 0.276	12,7 0.500	20,0 °																■		
SNHQ120724ER2-M07	2,4 0.094	0,0 -	7,0 0.276	12,7 0.500	20,0 °																■		
SNHQ120731EL2-M07	3,1 0.122	0,0 -	7,0 0.276	12,7 0.500	20,0 °																■		
SNHQ120731ER2-M07	3,1 0.122	0,0 -	7,0 0.276	12,7 0.500	20,0 °																■		
SNHQ120740EL2-M07	4,0 0.157	0,0 -	7,0 0.276	12,7 0.500	20,0 °																■		
SNHQ120740ER2-M07	4,0 0.157	0,0 -	7,0 0.276	12,7 0.500	20,0 °																■		
SNHQ120750FEL2-M07	5,0 0.197	0,0 -	7,14 0.281	12,7 0.500	20,0 °																■		
SNHQ120750FER2-M07	5,0 0.197	0,0 -	7,14 0.281	12,7 0.500	20,0 °																■		
SNHQ120760FEL2-M07	6,0 0.236	0,0 -	7,15 0.281	12,7 0.500	20,0 °																■		
SNHQ120760FER2-M07	6,0 0.236	0,0 -	7,15 0.281	12,7 0.500	20,0 °																■		

Note: When using SNHQ insert with corner radius = 5 and 6 mm, please modify the external profile of the cutter by adding a corner radius or chamfer = 4 mm

Square shoulder and slot milling cutters

Helical milling cutters

Face milling cutters

Disc milling cutters

High feed milling cutters

Copy milling cutters

Plunge milling cutters

Chamfer milling cutters

Spot facing cutters

Inserts

SNHX11/14

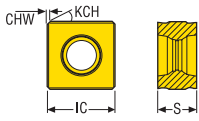

M11/M12



Designation	CHW	S	IC	KCH°	GAN	Grades																
						Coated										Uncoated						
	mm Inch	mm Inch	mm Inch	mm		MP1501	MP2050	MP2501	MP3000	MH1000	MM4500	MK1500	MK2050	MS2050	MS2500	T25M	T350M	F15M	F30M	F40M	H15	H25
SNHX1106TN8-M11	0,5 0.020	6,35 0.250	11,0 0.433	45,0	10,0°			■									■			■		
SNHX1406TN8-M12	0,8 0.031	6,35 0.250	14,5 0.571	45,0	10,0°			■									■			■		

SNMU12/16

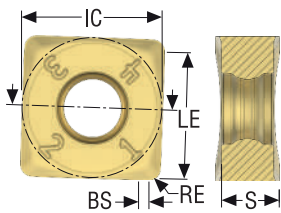

M10

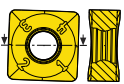

M16

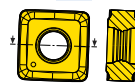

M16-1.6

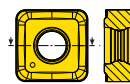

M18

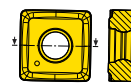

MD13/MD16

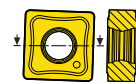

Designation	IC	RE	BS	S	GAN	Grades																	
						Coated										Uncoated							
	mm Inch	mm Inch	mm Inch	mm Inch		MP1501	MP2050	MP2501	MP3000	MH1000	MM4500	MK1500	MK2050	MS2050	MS2500	T25M	T350M	F15M	F30M	F40M	H15	H25	
SNMU120408TN-M10	12,0 0.472	0,8 0.031	0,0 -	4,8 0.189	20,0°	■		■					■										
SNMU120410TN-M10	12,0 0.472	1,0 0.039	1,0 0.039	4,8 0.189	20,0°	■		■	■				■	■	■		■				■		
SNMU120412TN-M16	12,0 0.472	1,2 0.047	1,4 0.055	4,78 0.188	15,0°	■		■	■			■	■				■				■		
SNMU120416TN-M16	12,0 0.472	1,6 0.063	0,0 -	4,78 0.188	15,0°	■		■					■								■		
SNMU120408TN-MD13	12,0 0.472	0,8 0.031	0,0 -	4,8 0.189	0,0°							■	■										
SNMU120410TN-MD13	12,0 0.472	1,0 0.039	1,0 0.039	4,8 0.189	0,0°	■		■				■	■										
SNMU160612TN-M10	16,0 0.630	1,2 0.047	1,2 0.047	6,4 0.252	20,0°	■		■	■				■										
SNMU160612TN-M18	16,0 0.630	1,2 0.047	1,6 0.063	6,38 0.251	15,0°	■		■	■			■	■				■				■		
SNMU160610TN-MD16	16,0 0.630	1,0 0.039	0,0 -	6,4 0.252	0,0°	■						■											
SNMU160612TN-MD16	16,0 0.630	1,2 0.047	1,2 0.047	6,4 0.252	0,0°	■						■	■										

SN.X14/22

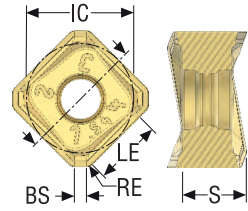

1407AN.R-ME10/M10/M16

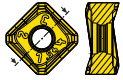

1407ZN.R-ME10/M10/M16

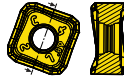

2209ANTR-M12-M18/2209ANR-ME12

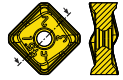

2209ZNTL-M18

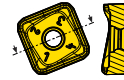

2209ZNTR-M12-M18/2209ZNR-ME12

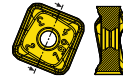

Designation	IC	BS	RE	LE	S	GAN	Grades																	
							Coated															Uncoated		
	mm Inch	mm Inch	mm Inch	mm Inch	mm Inch		MP1501	MP2050	MP2501	MP3000	MH1000	MM4500	MK1500	MK2050	MS2050	MS2500	T25M	T350M	F15M	F30M	F40M	H15	H25	
SNMX1407ANTR-M10	14,0 0.551	1,5 0.059	1,0 0.039	10,2 0.402	6,59 0.259	17,0°	■	■	■	■				■	■	■		■				■		
SNMX1407ANTR-M16	14,0 0.551	1,5 0.059	1,0 0.039	10,2 0.402	6,59 0.259	17,0°	■		■	■			■	■		■		■						
SNMX1407ZNTR-M10	14,0 0.551	1,5 0.059	1,0 0.039	10,7 0.421	6,59 0.259	15,0°	■	■	■	■				■	■	■		■				■		
SNMX1407ZNTR-M16	14,0 0.551	1,5 0.059	1,0 0.039	10,7 0.421	6,59 0.259	15,0°	■		■				■	■				■				■		
SNMX2209ANTR-M12	22,0 0.866	1,5 0.059	2,0 0.079	18,4 0.724	8,81 0.347	20,0°		■	■						■			■						
SNMX2209ANTR-M18	22,0 0.866	1,5 0.059	2,0 0.079	18,4 0.724	8,81 0.347	25,0°	■		■				■	■				■						
SNMX2209ZNTR-M12	22,0 0.866	1,5 0.059	2,0 0.079	18,07 0.711	8,79 0.346	20,0°			■						■							■		
SNMX2209ZNTR-M18	22,0 0.866	1,5 0.059	2,0 0.079	18,07 0.711	8,79 0.346	25,0°	■		■				■	■				■						
SNMX2209ZNTL-M18	22,0 0.866	1,5 0.059	2,0 0.079	18,07 0.711	8,79 0.346	25,0°	■		■															
SNHX1407ANR-ME10	14,0 0.551	1,5 0.059	1,0 0.039	10,2 0.402	6,59 0.259	20,0°									■							■		■
SNHX1407ZNR-ME10	14,0 0.551	1,5 0.059	1,0 0.039	10,7 0.421	6,59 0.259	20,0°									■									

Square shoulder and slot milling cutters

Helical milling cutters

Face milling cutters

Disc milling cutters

High feed milling cutters

Copy milling cutters

Plunge milling cutters

Chamfer milling cutters

Spot facing cutters

Inserts

SONX09/12

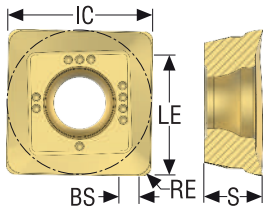

M10/M12/M14

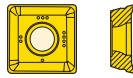

ME06/ME08

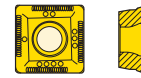

Designation	IC	BS	RE	LE	S	GAN	Grades																	
							Coated										Uncoated							
	mm Inch	mm Inch	mm Inch	mm Inch	mm Inch		MP1501	MP2050	MP2501	MP3000	MH1000	MM4500	MK1500	MK2050	MS2050	MS2500	T25M	T350M	F15M	F30M	F40M	H15	H25	
SONX09T304TR-ME06	9,55 0.376	1,3 0.051	0,4 0.016	8,0 0.315	3,97 0.156	22,0°																		
SONX09T304TR-M10	9,55 0.376	1,3 0.051	0,4 0.016	8,0 0.315	3,97 0.156	19,0°							■					■					■	
SONX09T308TR-M10	9,55 0.376	1,3 0.051	0,8 0.031	8,0 0.315	3,97 0.156	19,0°			■				■										■	
SONX120508TR-ME08	12,7 0.500	1,0 0.039	0,8 0.031	11,0 0.433	5,17 0.204	24,0°																	■	
SONX120508TR-M12	12,7 0.500	1,0 0.039	0,8 0.031	11,0 0.433	5,17 0.204	16,0°	■		■				■	■					■				■	
SONX150508TR-M14	15,8 0.622	2,0 0.079	0,8 0.031	14,0 0.551	5,56 0.219	22,0°			■				■						■				■	
SONX150508TR-ME10	15,8 0.622	2,0 0.079	0,8 0.031	14,0 0.551	5,56 0.219	19,0°																	■	

- Square shoulder and slot milling cutters
- Helical milling cutters
- Face milling cutters
- Disc milling cutters
- High feed milling cutters
- Copy milling cutters
- Plunge milling cutters
- Chamfer milling cutters
- Spot facing cutters
- Inserts

SP.19/28

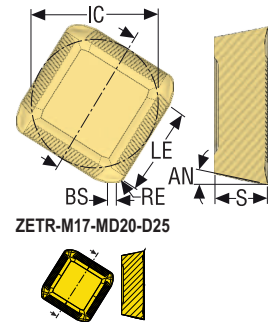
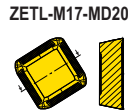
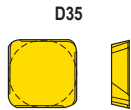

Designation	IC	BS	RE	LE	S	AN°	GAN	Grades																	
								Coated																Uncoated	
	mm <i>Inch</i>	mm <i>Inch</i>	mm <i>Inch</i>	mm <i>Inch</i>	mm <i>Inch</i>			MP1501	MP2050	MP2501	MP3000	MH1000	MM4500	MK1500	MK2050	MS2050	MS2500	T25M	T350M	F15M	F30M	F40M	H15	H25	
SPER1906ZETL-M17	19,05 0.750	1,8 0.071	3,0 0.118	12,7 0.500	6,35 0.250	11,0	17,0°		■																
SPER1906ZETR-M17	19,05 0.750	1,8 0.071	1,6 0.063	12,7 0.500	6,35 0.250	11,0	17,0°												■						
SPEN1906ZETL-MD20	19,05 0.750	1,8 0.071	1,6 0.063	13,3 0.524	6,35 0.250	11,0	0,0°			■															
SPEN1906ZETR-MD20	19,05 0.750	1,8 0.071	1,6 0.063	13,3 0.524	6,35 0.250	11,0	0,0°			■									■	■					
SPEN1906ZETR-D25	19,05 0.750	1,8 0.071	1,6 0.063	13,3 0.524	6,35 0.250	11,0	0,0°	■																	
SPEN2807ZETR-D35	28,58 1.125	1,8 0.071	2,0 0.079	13,3 0.524	7,938 0.313	11,0	0,0°	■																	
SPMR1906ZETR-M17	19,05 0.750	1,0 0.039	1,6 0.063	12,9 0.508	6,35 0.250	11,0	17,0°		■																



SPE.ZZ

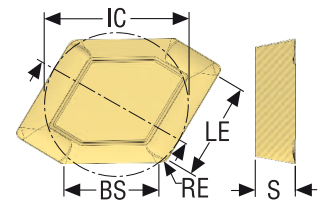

Designation	RE	BS	L	S	GAN	Grades																		
						Coated																Uncoated		
	mm <i>Inch</i>	mm <i>Inch</i>	mm <i>Inch</i>	mm <i>Inch</i>		MP1501	MP2050	MP2501	MP3000	MH1000	MM4500	MK1500	MK2050	MS2050	MS2500	T25M	T350M	F15M	F30M	F40M	H15	H25		
SPER1906ZZTL-M17	3,0 0.118	12,0 0.472	19,05 0.750	6,35 0.250	17,0°		■																	
SPER1906ZZTR-M17	3,0 0.118	12,0 0.472	19,05 0.750	6,35 0.250	17,0°		■																	
SPEN1906ZZTR-D25	3,0 0.118	12,0 0.472	20,0 0.787	6,35 0.250	0,0°	■		■																
SPEN1906ZZTR-MD20	3,0 0.118	12,0 0.472	20,0 0.787	6,35 0.250	0,0°			■																

Square shoulder and slot milling cutters

Helical milling cutters

Face milling cutters

Disc milling cutters

High feed milling cutters

Copy milling cutters

Plunge milling cutters

Chamfer milling cutters

Spot facing cutters

Inserts

SPKT10/14/18

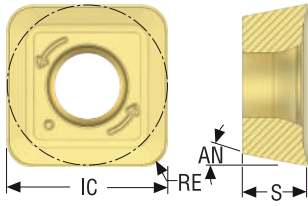

SP10-M10

SP10-MD12

SP14-M14

SP14-MD16

SP18-M14

SP18-MD16

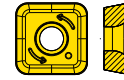
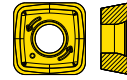
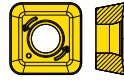
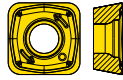
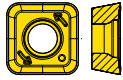

Designation	IC	RE	S	AN°	GAN	Grades																	
						Coated												Uncoated					
	mm <i>Inch</i>	mm <i>Inch</i>	mm <i>Inch</i>			MP1501	MP2050	MP2501	MP3000	MH1000	MM4500	MK1500	MK2050	MS2050	MS2500	T25M	T350M	F15M	F30M	F40M	H15	H25	
SPKT10T317TN-M10	10,0 <i>0.394</i>	1,7 <i>0.067</i>	3,97 <i>0.156</i>	11,0	13,0°	■	■	■			■		■	■	■		■				■		
SPKT10T317TN-MD12	10,0 <i>0.394</i>	1,7 <i>0.067</i>	3,97 <i>0.156</i>	11,0	5,0°	■		■	■				■									■	
SPKT140523TN-M14	14,0 <i>0.551</i>	2,3 <i>0.091</i>	5,56 <i>0.219</i>	11,0	13,0°			■	■		■		■	■	■		■					■	
SPKT140523TN-MD16	14,0 <i>0.551</i>	2,3 <i>0.091</i>	5,56 <i>0.219</i>	11,0	5,0°	■	■	■	■				■		■		■					■	
SPKT180630TN-M14	18,0 <i>0.709</i>	3,0 <i>0.118</i>	6,35 <i>0.250</i>	11,0	12,0°	■	■	■					■	■	■		■					■	
SPKT180630TN-MD16	18,0 <i>0.709</i>	3,0 <i>0.118</i>	6,35 <i>0.250</i>	11,0	5,0°	■		■	■				■									■	

SPMT

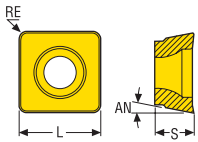

M08



Designation	RE	L	S	AN°	GAN	Grades																	
						Coated												Uncoated					
	mm <i>Inch</i>	mm <i>Inch</i>	mm <i>Inch</i>	mm <i>Inch</i>		MP1501	MP2050	MP2501	MP3000	MH1000	MM4500	MK1500	MK2050	MS2050	MS2500	T25M	T350M	F15M	F30M	F40M	H15	H25	
SPMT100408T-M08	0,8 <i>0.031</i>	10,0 <i>0.394</i>	4,76 <i>0.187</i>	11,0 <i>0.433</i>	10,0°																	■	

SPMX

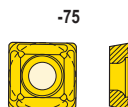
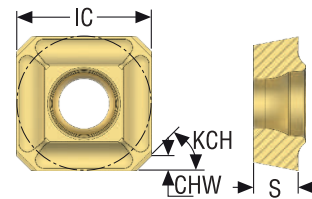

Designation	CHW	IC	S	KCH°	GAN	Grades																	
						Coated																Uncoated	
	mm Inch	mm Inch	mm Inch	mm		MP1501	MP2050	MP2501	MP3000	MH1000	MM4500	MK1500	MK2050	MS2050	MS2500	T25M	T350M	F15M	F30M	F40M	H15	H25	
SPMX0602AP-75	0,69 0,027	6,35 0,250	2,38 0,094	45,0	0,0°																		
SPMX0703AP-75	0,87 0,034	7,94 0,313	3,18 0,125	45,0	0,0°																		
SPMX0903AP-75	1,05 0,041	9,525 0,375	3,18 0,125	45,0	0,0°																		
SPMX12T3AP-75	1,39 0,055	12,7 0,500	3,97 0,156	45,0	0,0°																		
SPMX060204-75	-	6,35 0,250	2,38 0,094	-	20,0°																		
SPMX070304-75	-	7,94 0,313	3,18 0,125	-	16,0°																		
SPMX090304-75	-	9,525 0,375	3,18 0,125	-	16,0°																		
SPMX12T308-75	-	12,7 0,500	3,97 0,156	-	14,0°																		

Square shoulder and slot milling cutters

Helical milling cutters

Face milling cutters

Disc milling cutters

High feed milling cutters

Copy milling cutters

Plunge milling cutters

Chamfer milling cutters

Spot facing cutters

Inserts

VPGX

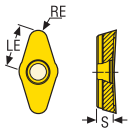

E06/E10



Designation	RE	LE	S	GAN	Grades																	
					Coated														Uncoated			
	mm <i>Inch</i>	mm <i>Inch</i>	mm <i>Inch</i>		MP1501	MP2050	MP2501	MP3000	MH1000	MM4500	MK1500	MK2050	MS2050	MS2500	T25M	T350M	F15M	F30M	F40M	H15	H25	
VPGX220605FR-E06	0,46 <i>0.018</i>	14,2 <i>0.559</i>	6,35 <i>0.250</i>	25,0 °																	■	
VPGX220605ER-E10	0,46 <i>0.018</i>	14,2 <i>0.559</i>	6,35 <i>0.250</i>	25,0 °																		■
VPGX220608PDER-E10	0,85 <i>0.033</i>	14,2 <i>0.559</i>	6,35 <i>0.250</i>	25,0 °																		■
VPGX220616ER-E10	1,64 <i>0.065</i>	13,7 <i>0.539</i>	6,35 <i>0.250</i>	25,0 °																		■
VPGX220620ER-E10	2,05 <i>0.081</i>	14,2 <i>0.559</i>	6,35 <i>0.250</i>	25,0 °																		■
VPGX220624ER-E10	2,5 <i>0.098</i>	14,2 <i>0.559</i>	6,35 <i>0.250</i>	25,0 °																		■
VPGX220631EN-E10	3,18 <i>0.125</i>	14,2 <i>0.559</i>	6,35 <i>0.250</i>	25,0 °																		■
VPGX220631FN-E06	3,18 <i>0.125</i>	14,2 <i>0.559</i>	6,35 <i>0.250</i>	25,0 °																	■	
VPGX220640ER-E10	4,12 <i>0.162</i>	14,2 <i>0.559</i>	6,35 <i>0.250</i>	25,0 °																		■
VPGX220663ER-E10	6,35 <i>0.250</i>	11,8 <i>0.465</i>	6,35 <i>0.250</i>	25,0 °																		■

*Insert with wiper flat 1,5mm

- Square shoulder and slot milling cutters
- Helical milling cutters
- Face milling cutters
- Disc milling cutters
- High feed milling cutters
- Copy milling cutters
- Plunge milling cutters
- Chamfer milling cutters
- Spot facing cutters
- Inserts

XNEX04/08

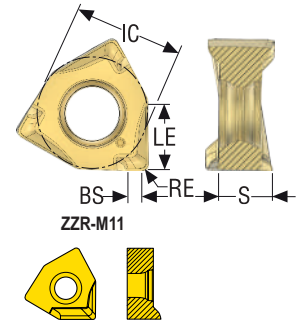

Designation	RE	BS	LE	S	IC	GAN	Grades																	
							Coated															Uncoated		
	mm Inch	mm Inch	mm Inch	mm Inch	mm Inch		MP1501	MP2050	MP2501	MP3000	MH1000	MM4500	MK1500	MK2050	MS2050	MS2500	T25M	T350M	F15M	F30M	F40M	H15	H25	
XNEX040304R-M06	0,4 0.016	0,8 0.031	4,0 0.157	3,31 0.130	6,7 0.264	32,6°				■					■							■		
XNEX040308R-M06	0,8 0.031	0,4 0.016	4,0 0.157	3,31 0.130	6,7 0.264	32,6°			■	■		■			■							■		
XNEX040304TR-M08	0,4 0.016	0,8 0.031	4,0 0.157	3,29 0.130	6,7 0.264	27,0°	■		■	■			■	■								■		
XNEX040308TR-M08	0,8 0.031	0,4 0.016	4,0 0.157	3,29 0.130	6,7 0.264	27,0°	■		■	■		■	■	■								■		
XNEX080604TR-M13	0,4 0.016	1,8 0.071	7,5 0.295	6,45 0.254	12,48 0.491	22,0°				■								■				■		
XNEX080604TR-ME09	0,4 0.016	1,8 0.071	7,5 0.295	6,45 0.254	12,48 0.491	27,0°			■	■												■		
XNEX080608TR-ME09	0,8 0.031	1,4 0.055	7,5 0.295	6,45 0.254	12,48 0.491	27,0°	■		■	■		■	■	■				■				■		
XNEX080608R-M08	0,8 0.031	1,4 0.055	7,5 0.295	6,45 0.254	12,48 0.491	24,0°		■		■		■			■	■		■				■		■
XNEX080608TR-M13	0,8 0.031	1,3 0.051	7,5 0.295	6,45 0.254	12,48 0.491	22,0°	■		■	■			■	■				■				■		
XNEX080608TR-MD15	0,8 0.031	1,4 0.055	7,5 0.295	6,45 0.254	12,48 0.491	17,0°	■		■	■			■	■				■				■		
XNEX080612TR-ME09	1,2 0.047	1,0 0.039	7,5 0.295	6,45 0.254	12,48 0.491	27,0°			■			■		■								■		
XNEX080612TR-M13	1,2 0.047	0,9 0.035	7,5 0.295	6,45 0.254	12,48 0.491	22,0°			■				■	■								■		
XNEX080612TR-MD15	1,2 0.047	1,0 0.039	7,5 0.295	6,45 0.254	12,48 0.491	17,0°	■		■				■											
XNEX080616TR-ME09	1,6 0.063	0,6 0.024	7,5 0.295	6,45 0.254	12,48 0.491	27,0°			■	■		■										■		
XNEX080616TR-M13	1,6 0.063	0,5 0.020	7,5 0.295	6,45 0.254	12,48 0.491	22,0°	■		■	■			■	■				■				■		
XNEX080616TR-MD15	1,6 0.063	0,7 0.028	7,5 0.295	6,45 0.254	12,48 0.491	17,0°	■		■	■			■	■				■				■		
XNEX080608TL-M13	0,8 0.031	1,3 0.051	7,5 0.295	6,45 0.254	12,48 0.491	22,0°			■						■			■				■		
XNEX080616TL-M13	1,6 0.063	0,5 0.020	7,5 0.295	6,45 0.254	12,48 0.491	22,0°			■															
XNEX080608ZZR-M11	0,8 0.031	6,0 0.236	7,5 0.295	6,45 0.254	12,48 0.491	19,0°				■			■									■		

Square shoulder and slot milling cutters
Helical milling cutters
Face milling cutters
Disc milling cutters
High feed milling cutters
Copy milling cutters
Plunge milling cutters
Chamfer milling cutters
Spot facing cutters
Inserts

XNHQ09/12/14/17

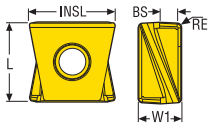

E07/E09/E10/E12/M08/M10/M11/M13



Designation	RE	BS	L	INSL	W1	GAN	Grades																
							Coated										Uncoated						
	mm Inch	mm Inch	mm Inch	mm Inch	mm Inch		MP1501	MP2050	MP2501	MP3000	MH1000	MM4500	MK1500	MK2050	MS2050	MS2500	T25M	T350M	F15M	F30M	F40M	H15	H25
XNHQ090504TN4-M08	0,4 0.016	2,2 0.087	9,3 0.366	11,81 0.465	5,5 0.217	16,0°																	
XNHQ090508TN4-M08	0,8 0.031	1,8 0.071	9,3 0.366	11,7 0.461	5,5 0.217	16,0°			■					■								■	
XNHQ090512TN4-M08	1,2 0.047	1,4 0.055	9,3 0.366	11,58 0.456	5,5 0.217	16,0°																■	
XNHQ090516TN4-M08	1,6 0.063	1,0 0.039	9,3 0.366	11,46 0.451	5,5 0.217	16,0°			■													■	
XNHQ090520TN4-M08	2,0 0.079	0,6 0.024	9,3 0.366	11,4 0.449	5,5 0.217	16,0°																■	
XNHQ090524TN4-M08	2,4 0.094	0,2 0.008	9,3 0.366	11,2 0.441	5,5 0.217	16,0°																■	
XNHQ090531TN4-M08	3,1 0.122	0,0 -	9,3 0.366	11,0 0.433	5,5 0.217	16,0°																■	
XNHQ090540TN4-M08	4,0 0.157	0,0 -	9,3 0.366	10,7 0.421	5,5 0.217	16,0°																■	
XNHQ120608EN4-E09	0,8 0.031	2,3 0.091	11,7 0.461	13,34 0.525	6,5 0.256	21,0°																■	
XNHQ120608TN4-M10	0,8 0.031	2,3 0.091	11,7 0.461	13,16 0.518	6,5 0.256	16,0°			■					■								■	
XNHQ120612TN4-M10	1,2 0.047	1,9 0.075	11,7 0.461	13,05 0.514	6,5 0.256	16,0°																■	
XNHQ120616TN4-M10	1,6 0.063	1,58 0.062	11,7 0.461	12,94 0.509	6,5 0.256	16,0°			■													■	
XNHQ120620TN4-M10	2,0 0.079	1,1 0.043	11,7 0.461	12,81 0.504	6,5 0.256	16,0°																■	
XNHQ120624TN4-M10	2,4 0.094	0,7 0.028	11,7 0.461	12,72 0.501	6,5 0.256	16,0°																■	
XNHQ120631TN4-M10	3,1 0.122	0,15 0.006	11,7 0.461	12,53 0.493	6,5 0.256	16,0°																■	
XNHQ120640TN4-M10	4,0 0.157	0,0 -	11,7 0.461	12,25 0.482	6,5 0.256	16,0°																■	
XNHQ120650TN4-M10	5,0 0.197	0,0 -	11,7 0.461	11,87 0.467	6,5 0.256	16,0°																■	
XNHQ140708EN4-E10	0,8 0.031	3,0 0.118	14,0 0.551	15,1 0.594	7,5 0.295	22,0°																■	■
XNHQ140708TN4-M11	0,8 0.031	3,0 0.118	14,0 0.551	15,1 0.594	7,5 0.295	16,0°			■					■								■	
XNHQ140716TN4-M11	1,6 0.063	2,2 0.087	14,0 0.551	14,8 0.583	7,5 0.295	16,0°			■													■	
XNHQ140720TN4-M11	2,0 0.079	1,8 0.071	14,0 0.551	14,7 0.579	7,5 0.295	16,0°																■	
XNHQ140724TN4-M11	2,4 0.094	1,4 0.055	14,0 0.551	14,6 0.575	7,5 0.295	16,0°																■	
XNHQ140731TN4-M11	3,1 0.122	0,7 0.028	14,0 0.551	14,4 0.567	7,5 0.295	16,0°			■													■	

Designation	RE	BS	L	INSL	W1	GAN	Grades														Uncoated			
							Coated														H15	H25		
	mm Inch	mm Inch	mm Inch	mm Inch	mm Inch		MP1501	MP2050	MP2501	MP3000	MH1000	MM4500	MK1500	MK2050	MS2050	MS2500	T25M	T350M	F15M	F30M	F40M	H15	H25	
XNHQ140740TN4-M11	4,0 0.157	0,0 -	14,0 0.551	14,2 0.559	7,5 0.295	16,0 °																		
XNHQ140750TN4-M11	5,0 0.197	0,0 -	14,0 0.551	13,9 0.547	7,5 0.295	16,0 °																		
XNHQ140760TN4-M11	6,0 0.236	0,0 -	14,0 0.551	13,6 0.535	7,5 0.295	16,0 °																		
XNHQ170708EN4-E12	0,8 0.031	3,0 0.118	17,0 0.669	0,0 -	7,5 0.295	16,0 °																		
XNHQ170708TN4-M13	0,8 0.031	3,0 0.118	17,0 0.669	0,0 -	7,5 0.295	16,0 °			■					■										
XNHQ170716TN4-M13	1,6 0.063	2,2 0.087	17,0 0.669	0,0 -	7,5 0.295	16,0 °			■															
XNHQ170720TN4-M13	2,0 0.079	1,8 0.071	17,0 0.669	0,0 -	7,5 0.295	16,0 °																		
XNHQ170724TN4-M13	2,4 0.094	1,4 0.055	17,0 0.669	0,0 -	7,5 0.295	16,0 °																		
XNHQ170731TN4-M13	3,1 0.122	0,7 0.028	17,0 0.669	0,0 -	7,5 0.295	16,0 °																		
XNHQ170740TN4-M13	4,0 0.157	0,0 -	17,0 0.669	0,0 -	7,5 0.295	16,0 °																		
XNHQ170750TN4-M13	5,0 0.197	0,0 -	17,0 0.669	0,0 -	7,5 0.295	16,0 °																		
XNHQ170760TN4-M13	6,0 0.236	0,0 -	17,0 0.669	0,0 -	7,5 0.295	16,0 °																		

- Square shoulder and slot milling cutters
- Helical milling cutters
- Face milling cutters
- Disc milling cutters
- High feed milling cutters
- Copy milling cutters
- Plunge milling cutters
- Chamfer milling cutters
- Spot facing cutters
- Inserts

XO.X06

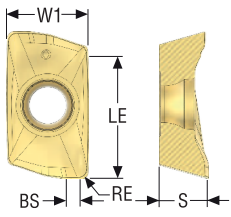

E03

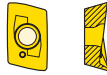

M05



Designation	RE	BS	LE	W1	S	GAN	Grades																	
							Coated										Uncoated							
	mm <i>Inch</i>	mm <i>Inch</i>	mm <i>Inch</i>	mm <i>Inch</i>	mm <i>Inch</i>		MP1501	MP2050	MP2501	MP3000	MH1000	MM4500	MK1500	MK2050	MS2050	MS2500	T25M	T350M	F15M	F30M	F40M	H15	H25	
XOEX060202FR-E03	0,2 <i>0.008</i>	1,1 <i>0.043</i>	6,0 <i>0.236</i>	4,1 <i>0.161</i>	2,45 <i>0.096</i>	30,6°																	■	
XOEX060204FR-E03	0,4 <i>0.016</i>	0,9 <i>0.035</i>	6,0 <i>0.236</i>	4,1 <i>0.161</i>	2,45 <i>0.096</i>	29,2°																	■	■
XOMX060202R-M05	0,2 <i>0.008</i>	1,1 <i>0.043</i>	5,5 <i>0.217</i>	4,1 <i>0.161</i>	2,45 <i>0.096</i>	20,2°			■												■	■		
XOMX060204R-M05	0,4 <i>0.016</i>	0,91 <i>0.036</i>	5,5 <i>0.217</i>	4,1 <i>0.161</i>	2,45 <i>0.096</i>	20,2°			■		■				■						■	■		
XOMX060208R-M05	0,8 <i>0.031</i>	0,51 <i>0.020</i>	5,5 <i>0.217</i>	4,1 <i>0.161</i>	2,45 <i>0.096</i>	20,2°			■		■				■					■	■	■		
XOMX060216R-M05	1,6 <i>0.063</i>	0,64 <i>0.025</i>	5,5 <i>0.217</i>	4,1 <i>0.161</i>	2,45 <i>0.096</i>	20,2°			■		■				■						■	■		

- Square shoulder and slot milling cutters
- Helical milling cutters
- Face milling cutters
- Disc milling cutters
- High feed milling cutters
- Copy milling cutters
- Plunge milling cutters
- Chamfer milling cutters
- Spot facing cutters
- Inserts

XO.X10

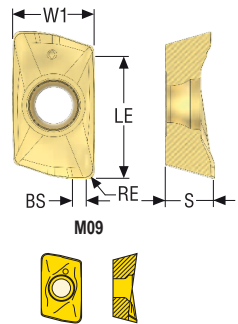
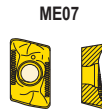

Designation	RE	BS	LE	W1	S	GAN	Grades																	
							Coated																Uncoated	
	mm Inch	mm Inch	mm Inch	mm Inch	mm Inch		MP1501	MP2050	MP2501	MP3000	MH1000	MM4500	MK1500	MK2050	MS2050	MS2500	T25M	T350M	F15M	F30M	F40M	H15	H25	
XOEX10T304FR-E05	0,4 0.016	1,3 0.051	9,7 0.382	6,9 0.272	3,8 0.150	21,6°																		
XOEX10T308FR-E05	0,8 0.031	1,3 0.051	9,7 0.382	6,9 0.272	3,8 0.150	21,6°																		
XOEX10T312FR-E05	1,2 0.047	1,3 0.051	9,7 0.382	6,9 0.272	3,8 0.150	21,6°																		
XOEX10T320FR-E05	2,0 0.079	0,6 0.024	9,7 0.382	6,9 0.272	3,8 0.150	21,6°																		
XOEX10T331FR-E05	3,1 0.122	0,39 0.015	9,7 0.382	6,9 0.272	3,8 0.150	24,1°																		
XOEX10T302R-M06	0,2 0.008	1,3 0.051	9,7 0.382	6,9 0.272	3,8 0.150	15,1°																		
XOEX10T304R-M06	0,4 0.016	1,3 0.051	9,7 0.382	6,9 0.272	3,8 0.150	15,1°			■						■							■		
XOEX10T308R-M06	0,8 0.031	1,3 0.051	9,7 0.382	6,9 0.272	3,8 0.150	15,1°		■	■						■	■		■				■		
XOEX10T312R-M06	1,2 0.047	1,3 0.051	9,7 0.382	6,9 0.272	3,8 0.150	15,1°									■							■		
XOEX10T316R-M06	1,6 0.063	1,0 0.039	9,7 0.382	6,9 0.272	3,8 0.150	15,1°									■							■		
XOEX10T320R-M06	2,0 0.079	0,6 0.024	9,7 0.382	6,9 0.272	3,8 0.150	18,8°									■			■						
XOEX10T324R-M06	2,4 0.094	0,2 0.008	9,7 0.382	6,9 0.272	3,8 0.150	18,3°									■									
XOEX10T331R-M06	3,1 0.122	0,4 0.016	9,7 0.382	6,9 0.272	3,8 0.150	17,3°		■							■	■						■		
XOMX10T304TR-ME07	0,4 0.016	1,3 0.051	9,3 0.366	6,9 0.272	3,83 0.151	20,4°	■		■	■			■		■	■		■				■		
XOMX10T308TR-ME07	0,8 0.031	1,3 0.051	9,3 0.366	6,9 0.272	3,83 0.151	20,4°	■	■	■	■		■	■		■	■		■				■		
XOMX10T312TR-ME07	1,2 0.047	1,3 0.051	9,3 0.366	6,9 0.272	3,83 0.151	20,4°			■	■					■			■				■		
XOMX10T316TR-ME07	1,6 0.063	1,0 0.039	9,3 0.366	6,9 0.272	3,83 0.151	20,4°		■	■	■					■			■				■		
XOMX10T320TR-ME07	2,0 0.079	0,6 0.024	9,3 0.366	6,9 0.272	3,83 0.151	20,4°			■	■					■			■				■		
XOMX10T324TR-ME07	2,4 0.094	0,2 0.008	9,3 0.366	6,9 0.272	3,83 0.151	20,4°			■						■							■		
XOMX10T331TR-ME07	3,1 0.122	0,4 0.016	9,3 0.366	6,9 0.272	3,83 0.151	20,4°		■	■						■							■		
XOMX10T304TR-M09	0,4 0.016	1,3 0.051	9,3 0.366	6,9 0.272	3,83 0.151	10,6°	■		■	■			■	■				■				■		
XOMX10T308TR-M09	0,8 0.031	1,3 0.051	9,3 0.366	6,9 0.272	3,83 0.151	10,6°	■		■	■		■	■	■		■		■				■		
XOMX10T312TR-M09	1,2 0.047	1,3 0.051	9,3 0.366	6,9 0.272	3,83 0.151	10,6°								■				■				■		

Square shoulder and slot milling cutters
Helical milling cutters
Face milling cutters
Disc milling cutters
High feed milling cutters
Copy milling cutters
Plunge milling cutters
Chamfer milling cutters
Spot facing cutters
Inserts

	Designation	RE mm Inch	BS mm Inch	LE mm Inch	W1 mm Inch	S mm Inch	GAN	Grades																			
								Coated														Uncoated					
								MP1501	MP2050	MP2501	MP3000	MH1000	MM4500	MK1500	MK2050	MS2050	MS2500	T25M	T350M	F15M	F30M	F40M	H15	H25			
Square shoulder and slot milling cutters	XOMX10T316TR-M09	1,6 0.063	1,0 0.039	9,3 0.366	6,9 0.272	3,83 0.151	10,6°												■					■			
Helical milling cutters	XOMX10T320TR-M09	2,0 0.079	0,6 0.024	9,3 0.366	6,9 0.272	3,83 0.151	10,6°												■					■			
	XOMX10T324TR-M09	2,4 0.094	0,2 0.008	9,3 0.366	6,9 0.272	3,83 0.151	10,6°																	■			
	XOMX10T331TR-M09	3,1 0.122	0,4 0.016	9,3 0.366	6,9 0.272	3,83 0.151	10,6°												■					■			
Face milling cutters																											
Disc milling cutters																											
High feed milling cutters																											
Copy milling cutters																											
Plunge milling cutters																											
Chamfer milling cutters																											
Spot facing cutters																											
Inserts																											

XO.X12



Designation	RE	BS	LE	W1	S	GAN	Grades																	
							Coated																	
	mm	mm	mm	mm	mm		MP1501	MP2050	MP2501	MP3000	MH1000	MM4500	MK1500	MK2050	MS2050	MS2500	T25M	T350M	F15M	F30M	F40M	H15	H25	
	Inch	Inch	Inch	Inch	Inch																			
XOEX120404FR-E06	0,4 0.016	2,0 0.079	12,0 0.472	8,2 0.323	5,03 0.198	27,4 °														■		■	■	
XOEX120408FR-E06	0,8 0.031	1,6 0.063	12,0 0.472	8,2 0.323	5,03 0.198	27,2 °														■		■	■	
XOEX120420FR-E06	2,0 0.079	0,6 0.024	12,0 0.472	8,2 0.323	5,03 0.198	21,2 °														■		■		
XOEX120416FR-E06	1,6 0.063	1,2 0.047	12,0 0.472	8,2 0.323	5,03 0.198	26,3 °														■		■		
XOEX120431FR-E06	3,1 0.122	-	12,0 0.472	8,2 0.323	5,03 0.198	24,8 °																■		
XOEX120402R-M07	0,2 0.008	2,0 0.079	12,0 0.472	8,2 0.323	5,03 0.198	20,5 °																■		
XOEX120404R-M07	0,4 0.016	2,0 0.079	12,0 0.472	8,2 0.323	5,03 0.198	20,5 °			■						■						■	■		
XOEX120408R-M07	0,8 0.031	1,6 0.063	12,0 0.472	8,2 0.323	5,03 0.198	20,3 °		■	■	■		■			■	■		■		■	■			
XOEX120416R-M07	1,6 0.063	1,2 0.047	12,0 0.472	8,2 0.323	5,03 0.198	19,1 °				■					■	■						■		
XOEX120420R-M07	2,0 0.079	0,95 0.037	12,0 0.472	8,2 0.323	5,03 0.198	18,6 °									■									
XOEX120424R-M07	2,4 0.094	0,6 0.024	12,0 0.472	8,2 0.323	5,03 0.198	18,6 °									■						■	■		
XOEX120431R-M07	3,1 0.122	-	12,0 0.472	8,2 0.323	5,03 0.198	15,0 °		■							■	■		■				■		
XOEX120440R-M07	4,0 0.157	-	12,0 0.472	8,2 0.323	5,03 0.198	16,8 °									■							■		
XOEX120463R-M07	6,3 0.248	-	12,0 0.472	8,2 0.323	5,03 0.198	15,3 °									■							■		
XOEX120450R-M07	5,0 0.197	-	12,0 0.472	8,2 0.323	5,03 0.198	16,8 °									■							■		
XOEX120408ZZR-M07	0,8 0.031	6,6 0.260	11,1 0.437	8,2 0.323	5,03 0.198	20,3 °				■											■	■		
XOMX120404TR-ME08	0,4 0.016	2,0 0.079	11,6 0.457	8,2 0.323	5,07 0.200	20,1 °			■						■							■		
XOMX120408TR-ME08	0,8 0.031	1,6 0.063	11,6 0.457	8,2 0.323	5,07 0.200	20,1 °		■	■			■	■	■	■	■		■				■		
XOMX120412TR-ME08	1,2 0.047	1,2 0.047	11,6 0.457	8,2 0.323	5,07 0.200	20,1 °			■						■					■		■		
XOMX120416TR-ME08	1,6 0.063	1,2 0.047	11,6 0.457	8,2 0.323	5,07 0.200	20,1 °		■	■						■					■		■		
XOMX120420TR-ME08	2,0 0.079	1,0 0.039	11,6 0.457	8,2 0.323	5,07 0.200	20,1 °			■						■					■		■		
XOMX120424TR-ME08	2,4 0.094	0,92 0.036	11,6 0.457	8,2 0.323	5,07 0.200	20,1 °			■						■					■		■		
XOMX120431TR-ME08	3,1 0.122	0,6 0.024	11,6 0.457	8,2 0.323	5,07 0.200	20,1 °		■	■						■	■		■				■		

Square shoulder and slot milling cutters
Helical milling cutters
Face milling cutters
Disc milling cutters
High feed milling cutters
Copy milling cutters
Plunge milling cutters
Chamfer milling cutters
Spot facing cutters
Inserts

	Designation	RE mm Inch	BS mm Inch	LE mm Inch	W1 mm Inch	S mm Inch	GAN	Grades																	
								Coated														Uncoated			
								MP1501	MP2050	MP2501	MP3000	MH1000	MM4500	MK1500	MK2050	MS2050	MS2500	T25M	T350M	F15M	F30M	F40M	H15	H25	
Square shoulder and slot milling cutters	XOMX120440TR-ME08	4,0 0.157	0,8 0.031	11,6 0.457	8,2 0.323	5,07 0.200	20,1 °		■	■						■						■			
Helical milling cutters	XOMX120408TR-M12	0,8 0.031	1,6 0.063	11,6 0.457	8,2 0.323	5,07 0.200	10,4 °	■		■	■						■						■		
	XOMX120416TR-M12	1,6 0.063	1,2 0.047	11,6 0.457	8,2 0.323	5,07 0.200	10,4 °				■							■					■		
	XOMX120431TR-M12	3,1 0.122	0,6 0.024	11,6 0.457	8,2 0.323	5,07 0.200	10,4 °				■								■				■		
Face milling cutters	XOMX120408TR-MD13	0,8 0.031	1,6 0.063	11,6 0.457	8,2 0.323	5,07 0.200	14,6 °	■		■	■								■				■		
	XOMX120404TR-MD13	0,4 0.016	2,0 0.079	11,6 0.457	8,2 0.323	5,07 0.200	14,6 °	■															■		
	XOMX120412TR-MD13	1,2 0.047	1,2 0.047	11,6 0.457	8,2 0.323	5,07 0.200	14,7 °	■			■												■		
Disc milling cutters	XOMX120416TR-MD13	1,6 0.063	1,2 0.047	11,6 0.457	8,2 0.323	5,07 0.200	14,7 °	■			■												■		
	XOMX120408TR-D14	0,8 0.031	1,6 0.063	11,6 0.457	8,2 0.323	5,07 0.200	1,0 °	■		■	■													■	
	XOMX120431TR-D14	3,1 0.122	0,6 0.024	11,6 0.457	8,2 0.323	5,07 0.200	1,0 °				■													■	
High feed milling cutters																									
Copy milling cutters																									
Plunge milling cutters																									
Chamfer milling cutters																									
Spot facing cutters																									
Inserts																									

XO.X16

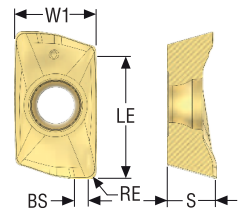

Square shoulder and slot milling cutters

Helical milling cutters

Face milling cutters

Disc milling cutters

High feed milling cutters

Copy milling cutters

Plunge milling cutters

Chamfer milling cutters

Spot facing cutters

Inserts

Designation	RE	BS	LE	W1	S	GAN	Grades Coated												Uncoated			
							MP1501	MP2050	MP2501	MP3000	MH1000	MM4500	MK1500	MK2050	MS2050	MS2500	T25M	T350M	F15M	F30M	F40M	H15
	mm <i>Inch</i>	mm <i>Inch</i>	mm <i>Inch</i>	mm <i>Inch</i>	mm <i>Inch</i>																	
XOEX160504FR-E07	0,4 <i>0.016</i>	2,0 <i>0.079</i>	15,4 <i>0.606</i>	10,2 <i>0.402</i>	5,9 <i>0.232</i>	23,0°																■
XOEX160508FR-E07	0,8 <i>0.031</i>	2,0 <i>0.079</i>	15,4 <i>0.606</i>	10,2 <i>0.402</i>	5,9 <i>0.232</i>	23,0°																■
XOEX160504R-M09	0,4 <i>0.016</i>	2,0 <i>0.079</i>	15,4 <i>0.606</i>	10,2 <i>0.402</i>	5,9 <i>0.232</i>	14,0°			■	■											■	
XOEX160508R-M09	0,8 <i>0.031</i>	2,0 <i>0.079</i>	15,4 <i>0.606</i>	10,2 <i>0.402</i>	5,9 <i>0.232</i>	14,0°		■	■	■				■	■			■			■	
XOEX160516R-M09	1,6 <i>0.063</i>	2,0 <i>0.079</i>	15,4 <i>0.606</i>	10,2 <i>0.402</i>	5,9 <i>0.232</i>	14,0°								■	■						■	
XOEX160520R-M09	2,0 <i>0.079</i>	2,0 <i>0.079</i>	15,4 <i>0.606</i>	10,2 <i>0.402</i>	5,9 <i>0.232</i>	14,0°								■							■	
XOEX160524R-M09	2,4 <i>0.094</i>	1,8 <i>0.071</i>	15,4 <i>0.606</i>	10,2 <i>0.402</i>	5,9 <i>0.232</i>	14,0°		■						■							■	
XOEX160531R-M09	3,1 <i>0.122</i>	1,6 <i>0.063</i>	15,3 <i>0.602</i>	10,2 <i>0.402</i>	5,9 <i>0.232</i>	14,0°		■						■	■						■	
XOEX160540R-M09	4,0 <i>0.157</i>	1,2 <i>0.047</i>	15,2 <i>0.598</i>	10,2 <i>0.402</i>	5,9 <i>0.232</i>	14,0°								■							■	
XOEX160550R-M09	5,0 <i>0.197</i>	0,3 <i>0.012</i>	15,0 <i>0.591</i>	10,2 <i>0.402</i>	5,59 <i>0.220</i>	14,0°								■							■	
XOEX160563R-M09	6,3 <i>0.248</i>	0,2 <i>0.008</i>	14,7 <i>0.579</i>	10,2 <i>0.402</i>	5,34 <i>0.210</i>	14,0°								■							■	
XOMX160504TR-ME11	0,4 <i>0.016</i>	2,0 <i>0.079</i>	15,4 <i>0.606</i>	10,2 <i>0.402</i>	5,94 <i>0.234</i>	19,0°			■												■	
XOMX160508TR-ME11	0,8 <i>0.031</i>	2,0 <i>0.079</i>	15,4 <i>0.606</i>	10,2 <i>0.402</i>	5,94 <i>0.234</i>	19,0°		■	■					■	■			■			■	
XOMX160512TR-ME11	1,2 <i>0.047</i>	2,0 <i>0.079</i>	15,4 <i>0.606</i>	10,2 <i>0.402</i>	5,94 <i>0.234</i>	19,0°			■												■	
XOMX160516TR-ME11	1,6 <i>0.063</i>	2,0 <i>0.079</i>	15,4 <i>0.606</i>	10,2 <i>0.402</i>	5,94 <i>0.234</i>	18,0°			■												■	
XOMX160520TR-ME11	2,0 <i>0.079</i>	1,9 <i>0.075</i>	15,4 <i>0.606</i>	10,2 <i>0.402</i>	5,94 <i>0.234</i>	18,0°			■					■							■	
XOMX160531TR-ME11	3,1 <i>0.122</i>	1,6 <i>0.063</i>	15,4 <i>0.606</i>	10,2 <i>0.402</i>	5,93 <i>0.233</i>	19,0°		■						■							■	
XOMX160540TR-ME11	4,0 <i>0.157</i>	1,2 <i>0.047</i>	15,2 <i>0.598</i>	10,2 <i>0.402</i>	5,93 <i>0.233</i>	19,0°								■							■	
XOMX160550TR-ME11	5,0 <i>0.197</i>	0,3 <i>0.012</i>	15,0 <i>0.591</i>	10,2 <i>0.402</i>	5,56 <i>0.219</i>	18,0°								■							■	
XOMX160563TR-ME11	6,3 <i>0.248</i>	0,2 <i>0.008</i>	14,6 <i>0.575</i>	10,2 <i>0.402</i>	5,3 <i>0.209</i>	18,0°								■							■	
XOMX160508R-M09	0,8 <i>0.031</i>	2,0 <i>0.079</i>	15,4 <i>0.606</i>	10,2 <i>0.402</i>	5,9 <i>0.232</i>	14,0°								■							■	
XOMX160508TR-M13	0,8 <i>0.031</i>	2,0 <i>0.079</i>	15,4 <i>0.606</i>	10,2 <i>0.402</i>	5,98 <i>0.235</i>	9,0°	■		■	■				■	■			■			■	
XOMX160516TR-M13	1,6 <i>0.063</i>	2,0 <i>0.079</i>	15,4 <i>0.606</i>	10,2 <i>0.402</i>	5,98 <i>0.235</i>	9,0°															■	

	Designation	RE mm Inch	BS mm Inch	LE mm Inch	W1 mm Inch	S mm Inch	GAN	Grades															
								Coated						Uncoated									
								MP1501	MP2050	MP2501	MP3000	MH1000	MM4500	MK1500	MK2050	MS2050	MS2500	T25M	T350M	F15M	F30M	F40M	H15
■	XOMX160531TR-M13	3,1 0.122	1,6 0.063	15,4 0.606	10,2 0.402	5,98 0.235	9,0 °													■			
■	XOMX160504TR-MD14	0,4 0.016	2,0 0.079	15,4 0.606	10,2 0.402	6,01 0.237	4,0 °						■										
■	XOMX160508TR-MD14	0,8 0.031	2,0 0.079	15,4 0.606	10,2 0.402	6,01 0.237	4,0 °	■		■			■						■				

XO.X18

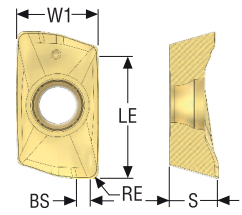

Designation	RE	BS	LE	W1	S	GAN	Grades Coated												Uncoated							
							MP1501	MP2050	MP2501	MP3000	MH1000	MM4500	MK1500	MK2050	MS2050	MS2500	T25M	T350M	F15M	F30M	F40M	H15	H25			
							mm <i>Inch</i>	mm <i>Inch</i>	mm <i>Inch</i>	mm <i>Inch</i>	mm <i>Inch</i>															
XOEX180604FR-E10	0,4 0.016	2,4 0.094	17,0 0.669	11,2 0.441	6,4 0.252	29,0°																				
XOEX180608FR-E10	0,8 0.031	2,4 0.094	17,0 0.669	11,2 0.441	6,4 0.252	29,0°																				
XOEX180616FR-E10	1,6 0.063	2,3 0.091	17,0 0.669	11,2 0.441	6,4 0.252	30,0°																				
XOEX180620FR-E10	2,0 0.079	2,2 0.087	17,0 0.669	11,2 0.441	6,4 0.252	30,0°																				
XOEX180631FR-E10	3,1 0.122	2,2 0.087	17,0 0.669	11,2 0.441	6,4 0.252	29,0°																				
XOEX180608ZZR-M10	0,8 0.031	9,0 0.354	17,0 0.669	11,2 0.441	6,4 0.252	22,4°																				
XOMX180604TR-ME13	0,4 0.016	2,4 0.094	17,0 0.669	11,2 0.441	6,4 0.252	25,0°																				
XOMX180608TR-ME13	0,8 0.031	2,4 0.094	17,0 0.669	11,2 0.441	6,4 0.252	25,3°																				
XOMX180616TR-ME13	1,6 0.063	2,3 0.091	17,0 0.669	11,2 0.441	6,4 0.252	24,7°																				
XOMX180620TR-ME13	2,0 0.079	2,2 0.087	17,0 0.669	11,2 0.441	6,4 0.252	24,7°																				
XOMX180631TR-ME13	3,1 0.122	2,2 0.087	17,0 0.669	11,2 0.441	6,38 0.251	23,6°																				
XOMX180640TR-ME13	4,0 0.157	0,8 0.031	17,0 0.669	11,2 0.441	6,38 0.251	24,0°																				
XOMX180604R-M10	0,4 0.016	2,4 0.094	17,0 0.669	11,2 0.441	6,4 0.252	22,0°																				
XOMX180608R-M10	0,8 0.031	2,4 0.094	17,0 0.669	11,2 0.441	6,4 0.252	22,4°																				
XOMX180616R-M10	1,6 0.063	2,3 0.091	17,0 0.669	11,2 0.441	6,4 0.252	21,7°																				
XOMX180620R-M10	2,0 0.079	2,2 0.087	17,0 0.669	11,2 0.441	6,4 0.252	21,8°																				
XOMX180624R-M10	2,4 0.094	2,2 0.087	17,0 0.669	11,2 0.441	6,35 0.250	21,1°																				
XOMX180631R-M10	3,1 0.122	2,2 0.087	17,0 0.669	11,2 0.441	6,35 0.250	21,0°																				
XOMX180640R-M10	4,0 0.157	0,8 0.031	17,0 0.669	11,2 0.441	6,35 0.250	21,0°																				
XOMX180650R-M10	5,0 0.197	0,3 0.012	17,0 0.669	11,2 0.441	6,35 0.250	19,4°																				
XOMX180663R-M10	6,3 0.248	0,3 0.012	17,0 0.669	11,2 0.441	6,35 0.250	19,0°																				
XOMX180608TR-M14	0,8 0.031	2,38 0.094	17,0 0.669	11,2 0.441	6,4 0.252	15,5°																				
XOMX180612TR-M14	1,2 0.047	2,4 0.094	17,0 0.669	11,2 0.441	6,4 0.252	15,5°																				

- Square shoulder and slot milling cutters
- Helical milling cutters
- Face milling cutters
- Disc milling cutters
- High feed milling cutters
- Copy milling cutters
- Plunge milling cutters
- Chamfer milling cutters
- Spot facing cutters
- Inserts

	Designation	RE mm Inch	BS mm Inch	LE mm Inch	W1 mm Inch	S mm Inch	GAN	Grades																
								Coated														Uncoated		
								MP1501	MP2050	MP2501	MP3000	MH1000	MM4500	MK1500	MK2050	MS2050	MS2500	T25M	T350M	F15M	F30M	F40M	H15	H25
Square shoulder and slot milling cutters	XOMX180616TR-M14	1,6 0.063	2,3 0.091	17,0 0.669	11,2 0.441	6,4 0.252	15,0 °			■	■				■			■						
Helical milling cutters	XOMX180620TR-M14	2,0 0.079	2,2 0.087	17,0 0.669	11,2 0.441	6,4 0.252	15,0 °			■						■							■	
	XOMX180624TR-M14	2,4 0.094	2,2 0.087	17,0 0.669	11,2 0.441	6,37 0.251	14,0 °			■						■							■	
	XOMX180631TR-M14	3,1 0.122	2,2 0.087	17,0 0.669	11,2 0.441	6,37 0.251	14,0 °			■	■					■							■	
Face milling cutters	XOMX180608TR-MD15	0,8 0.031	2,4 0.094	17,0 0.669	11,2 0.441	6,4 0.252	15,9 °	■		■	■				■			■			■			
	XOMX180612TR-MD15	1,2 0.047	2,4 0.094	17,0 0.669	11,2 0.441	6,4 0.252	15,0 °	■			■												■	
	XOMX180616TR-MD15	1,6 0.063	2,3 0.091	17,0 0.669	11,2 0.441	6,4 0.252	15,3 °				■					■							■	
Disc milling cutters	XOMX180608TR-D16	0,8 0.031	2,4 0.094	17,0 0.669	11,2 0.441	6,4 0.252	11,0 °	■		■					■							■		
	XOMX180631TR-D16	3,1 0.122	2,2 0.087	17,0 0.669	11,2 0.441	6,39 0.252	9,0 °	■			■													

XPKX

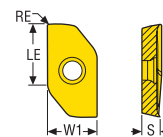

E06



E08



Designation	RE	LE	W1	S	GAN	Grades																	
						Coated												Uncoated					
	mm Inch	mm Inch	mm Inch	mm Inch		MP1501	MP2050	MP2501	MP3000	MH1000	MM4500	MK1500	MK2050	MS2050	MS2500	T25M	T350M	F15M	F30M	F40M	H15	H25	
XPKX080304PDER-E06	0,4 0.016	8,0 0.315	7,0 0.276	3,4 0.134	25,0 °																		■
XPKX080308PDER-E06	0,8 0.031	8,0 0.315	7,0 0.276	3,4 0.134	25,0 °																		■
XPKX080316PDER-E06	1,6 0.063	8,0 0.315	7,0 0.276	3,4 0.134	25,0 °																		■
XPKX080320PDER-E06	2,0 0.079	8,0 0.315	7,0 0.276	3,4 0.134	25,0 °																		■
XPKX080324PDER-E06	2,4 0.094	8,0 0.315	7,0 0.276	3,4 0.134	25,0 °																		■
XPKX080331PDER-E06	3,1 0.122	8,0 0.315	7,0 0.276	3,4 0.134	25,0 °																		■
XPKX12T304PDER-E08	0,4 0.016	12,1 0.476	10,0 0.394	3,97 0.156	23,1 °																		■
XPKX12T308PDER-E08	0,8 0.031	12,1 0.476	10,0 0.394	3,97 0.156	23,0 °																		■
XPKX12T320PDER-E08	2,0 0.079	12,1 0.476	10,0 0.394	3,97 0.156	25,0 °																		■
XPKX12T324PDER-E08	2,4 0.094	12,1 0.476	10,0 0.394	3,97 0.156	25,0 °																		■
XPKX12T331PDER-E08	3,1 0.122	12,1 0.476	10,0 0.394	3,97 0.156	25,0 °																		■
XPKX12T340PDER-E08	4,0 0.157	12,1 0.476	10,0 0.394	3,97 0.156	25,0 °																		■

Square shoulder and slot milling cutters

Helical milling cutters

Face milling cutters

Disc milling cutters

High feed milling cutters

Copy milling cutters

Plunge milling cutters

Chamfer milling cutters

Spot facing cutters

Inserts

ZOMX16

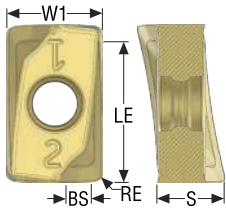

ME10



M12



Designation	RE	BS	LE	W1	S	GAN	Grades																	
							Coated										Uncoated							
	mm Inch	mm Inch	mm Inch	mm Inch	mm Inch		MP1501	MP2050	MP2501	MP3000	MH1000	MM4500	MK1500	MK2050	MS2050	MS2500	T25M	T350M	F15M	F30M	F40M	H15	H25	
ZOMX160708TR-ME10	0,8 0.031	2,0 0.079	15,5 0.610	10,76 0.424	7,38 0.291	39,1°			■						■	■						■		
ZOMX160708TR-M12	0,8 0.031	2,0 0.079	15,5 0.610	10,76 0.424	7,38 0.291	29,0°	■		■	■				■		■						■		
ZOMX160716TR-ME10	1,6 0.063	1,2 0.047	15,5 0.610	10,76 0.424	7,26 0.286	39,1°			■						■							■		
ZOMX160716TR-M12	1,6 0.063	1,2 0.047	15,5 0.610	10,76 0.424	7,26 0.286	29,0°	■		■	■				■								■		

150.10

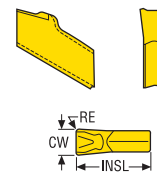

150.10-12



150.10-14



150.10-16



Designation	RE	CW	INSL	GAN	Grades																	
					Coated										Uncoated							
	mm Inch	mm Inch	mm Inch		MP1501	MP2050	MP2501	MP3000	MH1000	MM4500	MK1500	MK2050	MS2050	MS2500	T25M	T350M	F15M	F30M	F40M	H15	H25	
150.10-2.5N-12	0,17 0.007	2,5 0.098	9,0 0.354												■	■						
150.10-3N-12	0,19 0.007	3,1 0.122	9,0 0.354												■	■						
150.10-2.25N-14	0,15 0.006	2,25 0.089	9,0 0.354													■						
150.10-2.5N-14	0,17 0.007	2,5 0.098	9,0 0.354												■							
150.10-3N-14	0,19 0.007	3,1 0.122	9,0 0.354												■	■						
150.10-2.25N-16	0,15 0.006	2,25 0.089	9,0 0.354												■	■						
150.10-2.5N-16	0,17 0.007	2,5 0.098	9,0 0.354												■	■						
150.10-3N-16	0,19 0.007	3,1 0.122	9,0 0.354												■	■						
150.10-4N-12	0,23 0.009	4,1 0.161	9,0 0.354												■	■						
150.10-4N-14	0,23 0.009	4,1 0.161	9,0 0.354												■	■						
150.10-4N-16	0,23 0.009	4,1 0.161	9,0 0.354												■	■						

Square shoulder and slot milling cutters

Helical milling cutters

Face milling cutters

Disc milling cutters

High feed milling cutters

Copy milling cutters

Plunge milling cutters

Chamfer milling cutters

Spot facing cutters

Inserts

218.19

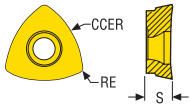

E04-E07



M04-M11



MD04-MD11



ME07-ME12



Designation	RE	S	CCER	GAN	Grades Coated																Uncoated	
					MP1501	MP2050	MP2501	MP3000	MH1000	MM4500	MK1500	MK2050	MS2050	MS2500	T25M	T350M	F15M	F30M	F40M	H15	H25	
	mm <i>Inch</i>	mm <i>Inch</i>	mm <i>Inch</i>																			
218.19-160-04-E07	1,2 <i>0.047</i>	4,76 <i>0.187</i>	16,0 <i>0.630</i>	20,0 °																	■	
218.19-125T-T3-ME07	0,8 <i>0.031</i>	3,97 <i>0.156</i>	12,5 <i>0.492</i>	20,0 °																	■	
218.19-160T-04-ME08	1,2 <i>0.047</i>	4,76 <i>0.187</i>	16,0 <i>0.630</i>	20,0 °																	■	
218.19-200T-05-ME10	0,6 <i>0.024</i>	5,5 <i>0.217</i>	20,0 <i>0.787</i>	20,0 °																	■	
218.19-080T-M04	0,4 <i>0.016</i>	2,38 <i>0.094</i>	8,0 <i>0.315</i>	7,0 °			■														■	
218.19-100T-M06	0,8 <i>0.031</i>	2,78 <i>0.109</i>	10,0 <i>0.394</i>	7,0 °			■	■					■	■		■					■	
218.19-125T-T3-M07	0,8 <i>0.031</i>	3,97 <i>0.156</i>	12,5 <i>0.492</i>	10,0 °			■	■		■			■	■		■					■	
218.19-160T-04-M11	1,2 <i>0.047</i>	4,76 <i>0.187</i>	16,0 <i>0.630</i>	15,0 °	■		■						■									
218.19-160T-04-M08	1,2 <i>0.047</i>	4,76 <i>0.187</i>	16,0 <i>0.630</i>	10,0 °		■	■	■		■			■	■		■					■	
218.19-200T-05-M10	0,6 <i>0.024</i>	5,5 <i>0.217</i>	20,0 <i>0.787</i>	10,0 °																	■	
218.19-080T-MD04	0,4 <i>0.016</i>	2,38 <i>0.094</i>	8,0 <i>0.315</i>	0,0 °										■				■				
218.19-100T-MD08	0,8 <i>0.031</i>	2,78 <i>0.109</i>	10,0 <i>0.394</i>	0,0 °			■		■					■					■			
218.19-125T-T3-MD10	0,8 <i>0.031</i>	3,97 <i>0.156</i>	12,5 <i>0.492</i>	0,0 °	■		■		■					■		■					■	
218.19-125T-T3-MD08	0,8 <i>0.031</i>	3,97 <i>0.156</i>	12,5 <i>0.492</i>	0,0 °				■													■	
218.19-160T-04-MD11	1,2 <i>0.047</i>	4,76 <i>0.187</i>	16,0 <i>0.630</i>	0,0 °	■		■		■				■	■		■			■			
218.19-160T-04-MD09	1,2 <i>0.047</i>	4,76 <i>0.187</i>	16,0 <i>0.630</i>	0,0 °				■													■	

218.20

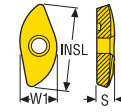

Designation	INSL	W1	S	GAN	Grades																	
					Coated												Uncoated					
	mm Inch	mm Inch	mm Inch		MP1501	MP2050	MP2501	MP3000	MH1000	MM4500	MK1500	MK2050	MS2050	MS2500	T25M	T350M	F15M	F30M	F40M	H15	H25	
218.20-0.250ER-ME03	12,42 0.489	5,46 0.215	2,52 0.099	11,0 °																		
218.20-0.250ER-M03	12,42 0.489	5,46 0.215	2,52 0.099	7,0 °																		
218.20-0.375ER-M05	18,62 0.733	8,19 0.322	3,85 0.152	3,0 °																		
218.20-0.375ER-ME05	18,62 0.733	8,19 0.322	3,85 0.152	11,0 °									■							■		
218.20-0.750ER-M10	36,44 1.435	15,12 0.595	7,625 0.300	-2,0 °						■												
218.20-0.750ER-ME10	36,44 1.435	15,12 0.595	7,625 0.300	6,0 °																■		
218.20-060ER-ME03	11,73 0.462	5,16 0.203	2,37 0.093	12,0 °									■							■		
218.20-080ER-ME04	15,64 0.616	6,88 0.271	3,21 0.126	5,0 °									■			■				■		
218.20-080ER-M04	15,64 0.616	6,88 0.271	3,21 0.126	1,0 °						■										■		
218.20-100ER-ME05	19,55 0.770	8,59 0.338	4,05 0.159	3,0 °						■			■							■		
218.20-100ER-M05	19,55 0.770	8,59 0.338	4,05 0.159	2,0 °						■										■		
218.20-125ER-ME07	24,48 0.964	10,74 0.423	5,05 0.199	11,0 °						■			■							■		
218.20-125ER-M07	24,48 0.964	10,74 0.423	5,05 0.199	1,0 °																■		
218.20-150ER-ME07	28,7 1.130	11,91 0.469	5,99 0.236	6,0 °									■							■		
218.20-150ER-M08	28,7 1.130	11,91 0.469	5,99 0.236	-2,0 °						■										■		
218.20-160ER-ME08	30,61 1.205	12,7 0.500	6,4 0.252	6,0 °						■			■							■		
218.20-160ER-M08	30,61 1.205	12,7 0.500	6,4 0.252	-2,0 °						■										■		
218.20-200ER-ME10	38,26 1.506	15,88 0.625	8,06 0.317	6,0 °						■			■							■		
218.20-200ER-M10	38,26 1.506	15,88 0.625	8,06 0.317	-2,0 °																■		
218.20-250ER-ME12	47,83 1.883	19,85 0.781	10,16 0.400	6,0 °						■			■							■		
218.20-250TR-M14	47,83 1.883	19,85 0.781	10,16 0.400	-2,0 °																■		

Square shoulder and slot milling cutters

Helical milling cutters

Face milling cutters

Disc milling cutters

High feed milling cutters

Copy milling cutters

Plunge milling cutters

Chamfer milling cutters

Spot facing cutters

Inserts

218.21

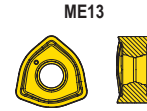
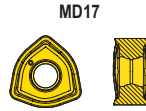
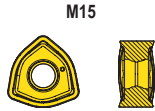
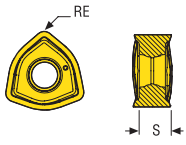

Designation	RE	S	GAN	Grades																	
				Coated												Uncoated					
	mm Inch	mm Inch		MP1501	MP2050	MP2501	MP3000	MH1000	MM4500	MK1500	MK2050	MS2050	MS2500	T25M	T350M	F15M	F30M	F40M	H15	H25	
218.21-230TR-06-ME13	1,6 0.063	5,95 0.234	21,0 °		■				■			■	■		■			■			
218.21-230TR-06-M15	1,6 0.063	5,95 0.234	17,0 °		■	■	■					■	■		■			■			
218.21-230TR-06-MD17	1,6 0.063	6,02 0.237	7,0 °	■		■	■				■		■								

R235.15

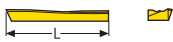

E05



Designation	L	GAN	Grades																	
			Coated												Uncoated					
	mm Inch		MP1501	MP2050	MP2501	MP3000	MH1000	MM4500	MK1500	MK2050	MS2050	MS2500	T25M	T350M	F15M	F30M	F40M	H15	H25	
R235.15-032-E05	42,987 1.692	22,0 °														■				
R235.15-050-E05	54,64 2.151	22,0 °														■				
R235.15-080-E05	54,746 2.155	22,0 °														■				

335.18

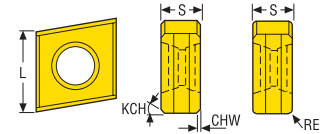

M10/M11/M12

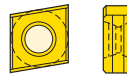

Designation	CHW	L	S	KCH°	GAN	Grades																	
						Coated												Uncoated					
	mm Inch	mm Inch	mm Inch	mm		MP1501	MP2050	MP2501	MP3000	MH1000	MM4500	MK1500	MK2050	MS2050	MS2500	T25M	T350M	F15M	F30M	F40M	H15	H25	
335.18-1005T-M10	0,5 0.020	10,0 0.394	5,4 0.213	45,0	10,0°	■		■				■	■								■		
335.18-100508-M10	0,0 -	10,0 0.394	5,4 0.213	0,0	10,0°												■						
335.18-1305T-M11	0,5 0.020	12,7 0.500	5,4 0.213	45,0	10,0°	■		■				■	■								■		
335.18-130508-M11	0,0 -	12,7 0.500	5,4 0.213	0,0	10,0°												■						
335.18-1606T-M12	0,5 0.020	16,0 0.630	6,4 0.252	45,0	10,0°	■		■													■		
335.18-160608-M12	0,0 -	16,0 0.630	6,4 0.252	0,0	10,0°												■						

Square shoulder and slot milling cutters

Helical milling cutters

Face milling cutters

Disc milling cutters

High feed milling cutters

Copy milling cutters

Plunge milling cutters

Chamfer milling cutters

Spot facing cutters

Inserts

335.19

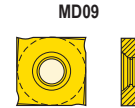
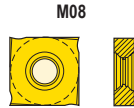
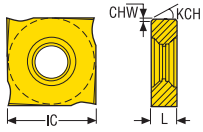

Designation	CHW	L	IC	KCH°	GAN	Grades																	
						Coated												Uncoated					
	mm Inch	mm Inch	mm Inch	mm		MP1501	MP2050	MP2501	MP3000	MH1000	MM4500	MK1500	MK2050	MS2050	MS2500	T25M	T350M	F15M	F30M	F40M	H15	H25	
335.19-1102-M08	0,1 0.004	2,3 0.091	11,0 0.433	45,0	15,0°																		
335.19-1103-M08	0,1 0.004	2,7 0.106	11,0 0.433	45,0	15,0°																		
335.19-1203-M08	0,15 0.006	3,2 0.126	12,7 0.500	45,0	15,0°																		
335.19-1204-M08	0,15 0.006	4,0 0.157	12,7 0.500	45,0	15,0°																		
335.19-12045-M08	0,15 0.006	4,5 0.177	12,7 0.500	45,0	15,0°																		
335.19-1205-M08	0,15 0.006	5,4 0.213	12,7 0.500	45,0	15,0°																		
335.19-1207-M08	0,15 0.006	7,0 0.276	12,7 0.500	45,0	15,0°																		
335.19-1203T-MD09	0,1 0.004	3,2 0.126	12,7 0.500	20,0	15,0°																		
335.19-12045T-MD09	0,1 0.004	4,5 0.177	12,7 0.500	20,0	15,0°																		
335.19-1204T-MD09	0,1 0.004	4,0 0.157	12,7 0.500	20,0	15,0°																		
335.19-1205T-MD09	0,1 0.004	5,4 0.213	12,7 0.500	20,0	15,0°																		
335.19-1207T-MD09	0,1 0.004	7,0 0.276	12,7 0.500	20,0	15,0°																		

- Square shoulder and slot milling cutters
- Helical milling cutters
- Face milling cutters
- Disc milling cutters
- High feed milling cutters
- Copy milling cutters
- Plunge milling cutters
- Chamfer milling cutters
- Spot facing cutters
- Inserts

R335.15-13/18

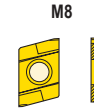
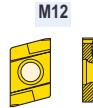
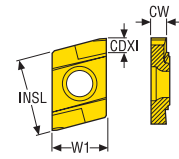

Designation	INSL	W1	CW	CDX	GAN	Grades																	
						Coated												Uncoated					
	mm Inch	mm Inch	mm Inch	mm Inch		MP1501	MP2050	MP2501	MP3000	MH1000	MM4500	MK1500	MK2050	MS2050	MS2500	T25M	T350M	F15M	F30M	F40M	H15	H25	
R335.15-13110FG-E08	13,5 0.531	9,0 0.354	1,13 0.044	1,8 0.071	15,0°																		
R335.15-13130FG-E08	13,5 0.531	9,0 0.354	1,33 0.052	2,0 0.079	15,0°																		
R335.15-13160FG-E08	13,5 0.531	9,0 0.354	1,63 0.064	2,6 0.102	15,0°																		
R335.15-13185FG-E08	13,5 0.531	9,0 0.354	1,88 0.074	2,6 0.102	15,0°																		
R335.15-13215FG-E08	13,5 0.531	9,0 0.354	2,18 0.086	3,15 0.124	15,0°																		
R335.15-13265FG-E08	13,5 0.531	9,0 0.354	2,68 0.106	3,15 0.124	15,0°																		
R335.15-13215FG-M10	13,5 0.531	9,0 0.354	2,18 0.086	3,15 0.124	0,0°																		
R335.15-13265FG-M10	13,5 0.531	9,0 0.354	2,68 0.106	3,15 0.124	0,0°																		
R335.15-18315FG-M12	18,0 0.709	9,0 0.354	3,2 0.126	3,8 0.150	0,0°																		
R335.15-18350FG-M12	18,0 0.709	9,0 0.354	3,55 0.140	4,1 0.161	0,0°																		
R335.15-18400FG-M12	18,0 0.709	9,0 0.354	4,05 0.159	4,8 0.189	0,0°																		
R335.15-18415FG-M12	18,0 0.709	9,0 0.354	4,2 0.165	4,8 0.189	0,0°																		
R335.15-18500FG-M12	18,0 0.709	9,0 0.354	5,05 0.199	5,5 0.217	0,0°																		
R335.15-18515FG-M12	18,0 0.709	9,0 0.354	5,2 0.205	5,5 0.217	0,0°																		

Tolerance (mm): CW: +0/+0.05 - CDX: +0/+0.15

- Square shoulder and slot milling cutters
- Helical milling cutters
- Face milling cutters
- Disc milling cutters
- High feed milling cutters
- Copy milling cutters
- Plunge milling cutters
- Chamfer milling cutters
- Spot facing cutters
- Inserts

Cutting data calculation		
RPM	$n = \frac{v_c \cdot 1000}{\pi \cdot D_c}$	(rev/min) (inch/min)
Cutting speed	$v_c = \frac{n \cdot \pi \cdot D_c}{1000}$	(m/min) (ft/min)
Feed speed	$v_f = n \cdot ZEFP \cdot f_z$	(mm/min) (inch/min)
Feed per revolution	$f = ZEFP \cdot f_z$	(mm/rev) (inch/rev)
Material removal rate	$Q = \frac{a_e \cdot a_p \cdot v_f}{1000}$	(cm ³ /min) (inch ³ /min)
Cutting speed and RPM for copying	$v_c = \frac{n \cdot \pi \cdot D_w}{1000}$	(m/min) (ft/min)
	$D_w = 2 \cdot \sqrt{a_p (D_c - a_p)}$	(mm) (inch)
	$n = \frac{v_c \cdot 1000}{\pi \cdot D_w}$	(RPM)
<p>Effective No. of teeth (ZEFP) The effective No. of teeth (ZEFP) is used to calculate the feed speed (v_f) and the feed per revolution (f). For most of the cutters the effective No. of teeth (ZEFP) is equal to the No. of teeth in the cutter (ZNP), but for some of the cutters ZEFP is less than ZNP.</p>		

Cutting data calculation

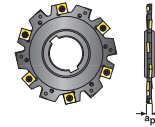
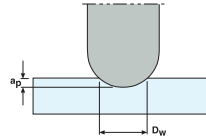
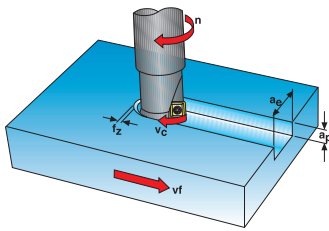

a_e	=	Width of cut mm/radial depth of cut	Example: Disc mill 335.19 Total No. of teeth (ZNP) = 12 Effective No. of teeth (ZEFP) = 6
a_p	=	Depth of cut mm/axial depth of cut	
DC	=	Cutter diameter	Explanation: 6 inserts on one side of the cutter and 6 overlapping inserts on the other side are used to get the full width (a_p), which means ZEFP = 6.
f	=	Feed per revolution	
f_z	=	Feed per tooth	
ZEFP	=	Effective No. of teeth for calculation of feed speed or feed per rev (see below)	
n	=	RPM	
Q	=	Material removal rate	
V_c	=	Cutting speed	
v_f	=	Feed speed	
v_f	=	Feed speed	

Cutting data calculation

Internal circular interpolation

When using circular interpolation or helical interpolation ramping to increase the diameter of a hole in a workpiece, the stock removal depth is not the same as the width of cut value. The real width of cut must be calculated from the formula below. The width of cut value is then used for calculation of feed/tooth and feed speed.

$$a_e = \frac{D_o^2 - D_i^2}{4 (D_o - D_c)}$$

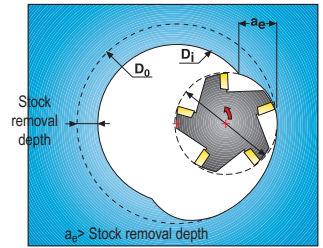

External circular interpolation

When using external circular interpolation or helical interpolation ramping to decrease the diameter of a round workpiece the stock removal depth is not the same as the width of cut value. The real width of cut must be calculated from the formula below.

$$a_e = \frac{D_o^2 - D_i^2}{4 (D_i + D_c)}$$

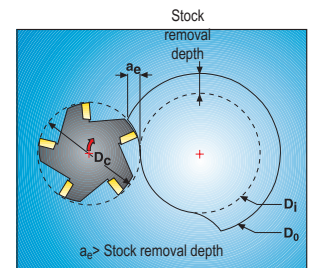

The width of cut is then used for calculation of feed/tooth and feed speed.

Increase the width of cut successively to full value

For circular interpolation operations it is recommended to successively increase the width of cut up to full value. When using radial infeed up to full width of cut, reduce the feed/tooth and feed speed to half.

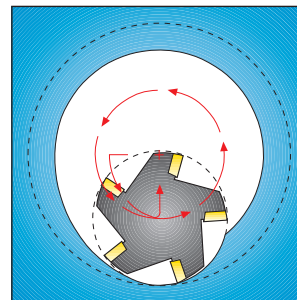

Successive increase of width of cut – recommended method.

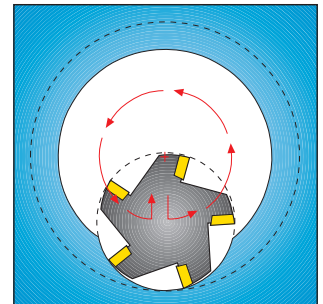

Radial infeed – Reduce feed/tooth.

Feed speed related to the centre of the cutter

When calculating feed speed and feed/tooth from average chip thickness using circular interpolation or helical interpolation ramping in an operation, the feed speed and feed/tooth are always related to the centre and not to the periphery of the cutter.

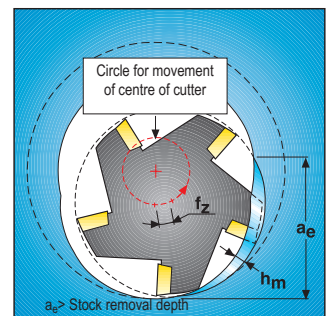

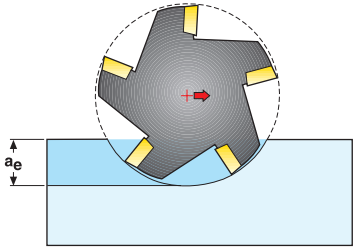
Side milling	
	<p>Relative engagement of the cutter diameter ($a_e/DC=\%$)</p> <ul style="list-style-type: none"> 30% 20% 10% 5% <p>Multiply the feed per tooth by the following factor</p> <ul style="list-style-type: none"> 1.25 1.5 2.0 3.0

This table can be used for cutters with cutting edge angle = 90°

a _e /D _c %	Feed Per Tooth, mm/tooth (f _z)													Speed Factor
	0,03	0,06	0,08	0,10	0,15	0,20	0,25	0,30	0,40	0,50	0,60	0,80	1,00	
Average Chip Thickness, mm/tooth (h _m)														
Width of cut up to and including DC/2														
2 (0.02)					0,02	0,03	0,04	0,04	0,06	0,07	0,08	0,11	0,14	1.8
3 (0.03)				0,02	0,03	0,03	0,04	0,05	0,07	0,09	0,10	0,14	0,17	1.7
5 (0.05)			0,02	0,02	0,03	0,04	0,06	0,07	0,09	0,11	0,13	0,18	0,22	1.6
10 (0.10)		0,02	0,02	0,03	0,05	0,06	0,08	0,09	0,12	0,16	0,19	0,25	0,31	1.5
15 (0.15)	0,011	0,02	0,03	0,04	0,06	0,08	0,09	0,11	0,15	0,19	0,23	0,30		1.4
20 (0.20)	0,013	0,03	0,03	0,04	0,06	0,09	0,11	0,13	0,17	0,22	0,26			1.35
30 (0.30)	0,016	0,03	0,04	0,05	0,08	0,10	0,13	0,16	0,21	0,26	0,31			1.3
40 (0.40)	0,018	0,04	0,05	0,06	0,09	0,12	0,15	0,18	0,23	0,29				1.25
50 (0.50)	0,02	0,04	0,05	0,06	0,10	0,13	0,16	0,19	0,25	0,32				1.2
Slotting (Width of cut = DC)														
100 (1.00)	0,02	0,04	0,05	0,06	0,10	0,13	0,16	0,19	0,25	0,32				1.0

--- = Feed per tooth correction example: at 20% engagement also increase speed by 1.35

When using side milling it is necessary to increase the feed per tooth to keep the chip thickness at the same value. It is also possible to increase the cutting speed and keep the same tool life. Use the tables below.

a _e /D _c %	Feed Per Tooth, in/tooth (f _z)													Speed Factor
	.0012	.0024	.0031	.004	.006	.008	.010	.012	.016	.020	.024	.031	.039	
Average Chip Thickness, in/tooth (h _m)														
Width of cut up to and including Dc/2														
2 (0.02)					.0008	.0012	.0016	.0016	.0024	.0028	.0031	.0043	.0055	1.8
3 (0.03)				.0008	.0012	.0012	.0016	.0020	.0028	.0035	.0039	.0055	.0067	1.7
5 (0.05)			.0008	.0008	.0012	.0016	.0024	.0028	.0035	.0043	.0051	.0071	.0087	1.6
10 (0.10)		.0008	.0008	.0012	.0020	.0024	.0031	.0035	.0047	.0063	.0075	.0098	.0122	1.5
15 (0.15)	.0004	.0008	.0012	.0016	.0024	.0031	.0035	.0043	.0059	.0075	.0091	.0118		1.4
20 (0.20)	.0005	.0012	.0012	.0016	.0024	.0035	.0043	.0051	.0067	.0087	.0102			1.35
30 (0.30)	.0006	.0012	.0016	.0020	.0031	.0039	.0051	.0063	.0083	.0102	.0122			1.3
40 (0.40)	.0007	.0016	.0020	.0024	.0035	.0047	.0059	.0071	.0091	.0114				1.25
50 (0.50)	.0008	.0016	.0020	.0024	.0039	.0051	.0063	.0075	.0098	.0126				1.2
Slotting (Width of cut = Dc)														
100 (1.00)	.0008	.0016	.0020	.0024	.0039	.0051	.0063	.0075	.0098	.0126				1.0

--- = Feed per tooth correction example: at 20% engagement also increase speed by 1.35

Instead of using the table above for calculating h_m and f_z, the following formula could be used if a_e/D_c < 30%.

$$h_m = f_z \cdot \sqrt{\frac{a_e}{D_c}}$$

$$f_z = h_m \cdot \sqrt{\frac{D_c}{a_e}}$$

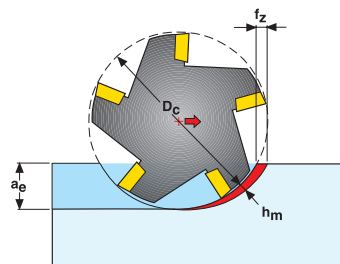

This table can be used for cutters with cutting edge angle = 45°

a _e /D _C %	Feed Per Tooth, mm/tooth (f _z)													Speed Factor
	0,03	0,06	0,08	0,10	0,15	0,20	0,25	0,30	0,40	0,50	0,60	0,80	1,00	
Average Chip Thickness, mm/tooth (h _m)														
Width of cut up to and including D _C /2														
2 (0.02)					0,01	0,02	0,02	0,03	0,04	0,05	0,06	0,08	0,10	1.8
3 (0.03)				0,01	0,02	0,02	0,03	0,04	0,05	0,06	0,07	0,10	0,12	1.7
5 (0.05)			0,01	0,02	0,02	0,03	0,04	0,05	0,06	0,08	0,09	0,13	0,16	1.6
10 (0.10)		0,01	0,02	0,02	0,03	0,04	0,05	0,07	0,09	0,11	0,13	0,18	0,22	1.5
15 (0.15)	0,008	0,02	0,02	0,03	0,04	0,05	0,07	0,08	0,11	0,13	0,16	0,21		1.4
20 (0.20)	0,009	0,02	0,02	0,03	0,05	0,06	0,08	0,09	0,12	0,15	0,18			1.35
30 (0.30)	0,011	0,02	0,03	0,04	0,05	0,07	0,09	0,11	0,15	0,18	0,22			1.3
40 (0.40)	0,012	0,02	0,03	0,04	0,06	0,08	0,10	0,12	0,17	0,21				1.25
50 (0.50)	0,01	0,03	0,04	0,05	0,07	0,09	0,11	0,14	0,18	0,23				1.2
Face milling full engagement (Width of cut = D _C)														
100 (1.00)	0,02	0,04	0,05	0,06	0,10	0,13	0,16	0,19	0,25	0,32				1.0

When using side milling it is necessary to increase the feed per tooth to keep the chip thickness at the same value. It is also possible to increase the cutting speed and keep the same tool life. Use the tables below.

a _e /D _c %	Feed Per Tooth, in/tooth (f _z)													Speed Factor
	.0012	.0024	.0031	.004	.006	.008	.010	.012	.016	.020	.024	.031	.039	
Average Chip Thickness, in/tooth (h _m)														
Width of cut up to and including D _c /2														
2 (0.02)					.0004	.0008	.0008	.0012	.0016	.0020	.0024	.0031	.0039	1.8
3 (0.03)				.0004	.0008	.0008	.0012	.0016	.0020	.0024	.0028	.0039	.0047	1.7
5 (0.05)			.0004	.0008	.0008	.0012	.0016	.0020	.0024	.0031	.0035	.0051	.0063	1.6
10 (0.10)		.0004	.0008	.0008	.0012	.0016	.0020	.0028	.0035	.0043	.0051	.0071	.0087	1.5
15 (0.15)	.0003	.0008	.0008	.0012	.0016	.0020	.0028	.0031	.0043	.0051	.0063	.0083		1.4
20 (0.20)	.0004	.0008	.0008	.0012	.0020	.0024	.0031	.0035	.0047	.0059	.0071			1.35
30 (0.30)	.0004	.0008	.0012	.0016	.0020	.0028	.0035	.0043	.0059	.0071	.0087			1.3
40 (0.40)	.0005	.0008	.0012	.0016	.0024	.0031	.0039	.0047	.0067	.0083				1.25
50 (0.50)	.0004	.0012	.0016	.0020	.0028	.0035	.0043	.0055	.0071	.0091				1.2
Face milling full engagement (Width of cut = D _c)														
100 (1.00)	.0004	.0012	.0016	.0020	.0028	.0035	.0043	.0055	.0071	.0091				1.0

Instead of using the table above for calculating h_m and f_z, the following formula could be used if a_e/D_C < 30%.

$$h_m = f_z \cdot \sqrt{\frac{a_e}{D_C}}$$

$$f_z = h_m \cdot \sqrt{\frac{D_C}{a_e}}$$

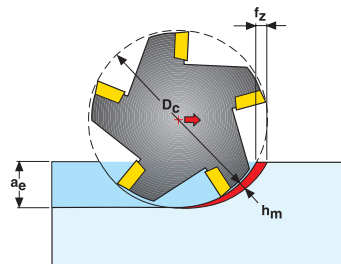

This table can be used for cutters with cutting edge angle = 60°

a _e /D _c %	Feed Per Tooth, mm/tooth (f _z)													Speed Factor
	0,03	0,06	0,08	0,10	0,15	0,20	0,25	0,30	0,40	0,50	0,60	0,80	1,00	
Average Chip Thickness, mm/tooth (h _m)														
Width of cut up to and including D _c /2														
2 (0.02)					0,02	0,02	0,03	0,04	0,05	0,06	0,07	0,10	0,12	1.8
3 (0.03)				0,01	0,02	0,03	0,04	0,04	0,06	0,07	0,09	0,12	0,15	1.7
5 (0.05)			0,02	0,02	0,03	0,04	0,05	0,06	0,08	0,10	0,12	0,15	0,19	1.6
10 (0.10)		0,02	0,02	0,03	0,04	0,05	0,07	0,08	0,11	0,13	0,16	0,22	0,27	1.5
15 (0.15)	0,010	0,02	0,03	0,03	0,05	0,07	0,08	0,10	0,13	0,16	0,20	0,26		1.4
20 (0.20)	0,011	0,02	0,03	0,04	0,06	0,07	0,09	0,11	0,15	0,19	0,22			1.35
30 (0.30)	0,013	0,03	0,04	0,04	0,07	0,08	0,11	0,13	0,18	0,22	0,27			1.3
40 (0.40)	0,015	0,03	0,04	0,05	0,08	0,10	0,13	0,15	0,20	0,25				1.25
50 (0.50)	0,02	0,03	0,04	0,06	0,08	0,11	0,14	0,17	0,22	0,28				1.2
Face milling full engagement (Width of cut = D _c)														
100 (1.00)	0,02	0,04	0,05	0,06	0,10	0,13	0,16	0,19	0,25	0,32				1.0

When using side milling it is necessary to increase the feed per tooth to keep the chip thickness at the same value. It is also possible to increase the cutting speed and keep the same tool life. Use the tables below.

a _e /D _c %	Feed Per Tooth, in/tooth (f _z)													Speed Factor
	.0012	.0024	.0031	.004	.006	.008	.010	.012	.016	.020	.024	.031	1,00	
Average Chip Thickness, in/tooth (h _m)														
Width of cut up to and including D _c /2														
2 (0.02)					.0008	.0008	.0012	.0016	.0020	.0024	.0028	.0039	.0047	1.8
3 (0.03)				.0004	.0008	.0012	.0016	.0016	.0024	.0028	.0035	.0047	.0059	1.7
5 (0.05)			.0008	.0008	.0012	.0016	.0020	.0024	.0031	.0039	.0047	.0059	.0075	1.6
10 (0.10)		.0008	.0008	.0012	.0016	.0020	.0028	.0031	.0043	.0051	.0063	.0087	.0106	1.5
15 (0.15)	.0004	.0008	.0012	.0012	.0020	.0028	.0031	.0039	.0051	.0063	.0079	.0102		1.4
20 (0.20)	.0004	.0008	.0012	.0016	.0024	.0028	.0035	.0043	.0059	.0075	.0087			1.35
30 (0.30)	.0005	.0012	.0016	.0016	.0028	.0031	.0043	.0051	.0071	.0087	.0102			1.3
40 (0.40)	.0006	.0012	.0016	.0020	.0031	.0039	.0051	.0059	.0079	.0098				1.25
50 (0.50)	.0008	.0012	.0016	.0024	.0031	.0043	.0055	.0067	.0087	.0110				1.2
Face milling full engagement (Width of cut = D _c)														
100 (1.00)	.0008	.0012	.0016	.0024	.0031	.0043	.0055	.0067	.0087	.0110				1.0

Instead of using the table above for calculating h_m and f_z, the following formula could be used if a_e/D_c < 30%.



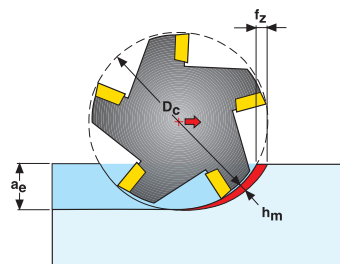

$$h_m = f_z \cdot \sqrt{\frac{a_e}{D_c}}$$

$$f_z = h_m \cdot \sqrt{\frac{D_c}{a_e}}$$

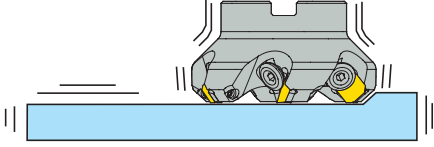
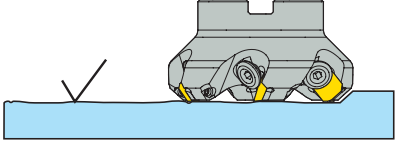

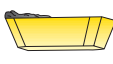

Trouble shooting carbide milling

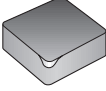

Vibrations	
	
<ul style="list-style-type: none"> • Improve the stability of cutter and workpiece. • Change cutter positioning. • Minimize tool overhang. • Reduce the cutting speed. • Increase the feed rate. • Reduce the depth of cut. • Select a different insert geometry, see page Insert geometry • Use Steadyline antivibration bar 	<ul style="list-style-type: none"> • Improve the stability of cutter and workpiece. • Minimize tool overhang. • Reduce the feed rate. • Increase the cutting speed • Use coolant. • Use wiper inserts. • Keep feed/rev value within wiper width • Use Steadyline antivibration bar

Tool life problems			
<p>Rapid flank wear</p> 	<ul style="list-style-type: none"> • Reduce the cutting speed. • Increase the feed rate. • Climb milling. 	<p>Comb cracks</p> 	<ul style="list-style-type: none"> • Reduce the cutting speed. • Reduce the feed rate. • No coolant • Change cutter positioning.
<p>Rapid notch wear</p> 	<ul style="list-style-type: none"> • Reduce the cutting speed. • Increase the feed rate. • Increase the depth of cut. • Climb milling. • Change cutter positioning 	<p>Built-up edge (BUE)</p> 	<ul style="list-style-type: none"> • Increase the cutting speed. • Increase the feed rate • No coolant. • Climb milling. • Change cutter positioning
<p>Chipping</p> 	<ul style="list-style-type: none"> • Increase the cutting speed. • reduce the feed rate. • Conventional milling. • Improve chip evacuation. • Change cutter positioning. • Minimize tool overhang. • Improve stability. 		

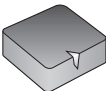
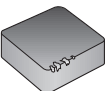
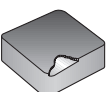
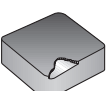
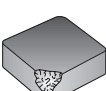
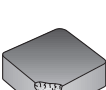
Troubleshooting – PCBN

Problem		Cause	Suggested action(s)
Flank wear		Not correct edge temperature	<ul style="list-style-type: none"> • Increase cutting speed • Increase feed rate • Increase depth of cut • Check cutting tool centre height • Check the ferrite content
Crater wear		Not correct edge temperature	<ul style="list-style-type: none"> • Decrease cutting speed • Decrease feed rate • Reduce chamfer angle • Use E edge preparation • Use coated insert • Use coolant (only in continuous cut)
Notch wear		Not correct edge temperature Too high cutting forces	<ul style="list-style-type: none"> • Increase cutting speed • Decrease feed rate • Increase insert approach angle (preferably round inserts) • Vary the depth of cut • Use inserts with chamfered cutting edges
Edge chipping		Too high cutting forces	<ul style="list-style-type: none"> • Use inserts with chamfered cutting edges • Increase system rigidity • For interrupted cuts, chamfer the tool entry/exit slots and holes • Vary the cutting speed to eliminate vibrations
Edge flaking (continuous cut)		Too high cutting forces	<ul style="list-style-type: none"> • Increase cutting speed • Reduce feed rate • Use chamfered and honed cutting edges • Check cutting tool center height • Reduce insert approach angle
Edge flaking (interrupted cut)		Too high cutting forces	<ul style="list-style-type: none"> • Do not use coolant • Use chamfered and honed cutting edges • Reduce feed rate • Increase cutting speed • Check cutting tool centre height • Reduce insert approach angle
Edge breakage		Too high cutting forces	<ul style="list-style-type: none"> • Reduce depth of cut • Reduce cutting speed • Increase nose radius • Use chamfered and honed inserts • Check cutting tool center height
Insert breakage		Too high cutting forces	<ul style="list-style-type: none"> • Check insert seating • Check insert shim and insert clamp • Check cutting tool centre height

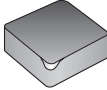
Troubleshooting – PCD

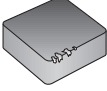
Problem	Cause	Suggested action(s)
<p>Flank wear</p> 	<p>Wrong grade Presence of Fe/Ni/Co</p>	<ul style="list-style-type: none"> • Change to coarser PCD grade • Check material composition • Reduce cutting speed • Use coolant
<p>Built-up edge</p> 	<p>Not correct edge temperature Wrong grade</p>	<ul style="list-style-type: none"> • Decrease or increase cutting speed • Choose a sharper insert • Change to a finer grade
<p>Edge chipping</p> 	<p>Poor rigidity Wrong grade Incorrect cutting data High run-out</p>	<ul style="list-style-type: none"> • Minimize vibrations • Change to a tougher grade • Change cutting data • Check set-up
<p>Poor surface finish</p>	<p>Wrong grade Too high cutting data Incorrect wiper position</p>	<ul style="list-style-type: none"> • Change to a finer PCD grade • Reduce cutting speed and feed rate • Check wiper position
<p>Flaking of workpiece</p>	<p>Too high depth of cut</p>	<ul style="list-style-type: none"> • Decrease depth of cut • Add entry chamfer on component

Torque keys, insert keys and Combimaster tightening torque

The range of Torque keys with fixed torque values are available in combinations of key grip/torque value for insert locking for most of the Seco milling products. By using a Torque key you always ensure the correct tightening force when mounting the insert. Torque keys are calibrated according to ISO 6789.

Code key: T00-15P35

T00 = Torque screw driver type for Torx Plus blade
T00T= Torque T-handle type for Torx Plus blade

15P= Torx Plus size
35 = Torque value 3,5 Nm

Please observe that blades are not interchangeable between screw driver type and T-handle type.
Torx Plus® is a registered trade mark belonging to Camcar-Textron (USA)

Torque key*	Replaceable blade	Torx Plus size	Torque value Nm/in.lbs
T00-06P05	T00-06P	T06P	0,5 / 4.4
T00-07P05	T00-07P	T07P	0,5 / 4.4
T00-07P09	T00-07P	T07P	0,9 / 8.0
T00-08P12	T00-08P	T08P	1,2 / 10.6
T00-08P20	T00-08P	T08P	2,0 / 17.7
T00-09P09	T00-09P	T09P	0,9 / 8.0
T00-09P12	T00-09P	T09P	1,2 / 10.6
T00-09P20	T00-09P	T09P	2,0 / 17.7
T00-10P20	T00-10P	T10P	2,0 / 17.7
T00-10P30	T00-10P	T10P	3,0 / 26.6
T00-10P35	T00-10P	T10P	3,5 / 31.0
T00-15P20	T00-15P	T15P	2,0 / 17.7
T00-15P30	T00-15P	T15P	3,0 / 26.6
T00-15P35	T00-15P	T15P	3,5 / 31.0
T00-15P40	T00-15P	T15P	4,0 / 35.4
T00-15P50	T00-15P	T15P	5,0 / 44.3
T00-20P35	T00-20P	T20P	3,5 / 31.0
T00-20P50	T00-20P	T20P	5,0 / 44.3

*Including blade

Torque key*	Replaceable blade	Torx Plus size	Torque value Nm/in.lbs
T00T-15P50	T00T-15P	T15P	5,0 / 44.3
T00T-20P50	T00T-20P	T20P	5,0 / 44.3
T00T-20P60	T00T-20P	T20P	6,0 / 53.1
T00T-20P80	T00T-20P	T20P	8,0 / 70.8
T00T-25P50	T00T-25P	T25P	5,0 / 44.3
T00T-25P60	T00T-25P	T25P	6,0 / 53.1
T00T-25P80	T00T-25P	T25P	8,0 / 70.8
T00T-30P80	T00T-30P	T30P	8,0 / 70.8

*Including blade

Torx Plus size	Torx Plus bit - short	Torx Plus bit - long	Key (T-handle)
T06P	H4B-T06P	-	DOUBLE-T
T07P	H4B-T07P	-	DOUBLE-T
T08P	H4B-T08P	-	DOUBLE-T
T09P	H4B-T09P	-	DOUBLE-T
T10P	H4B-T10P	H4B-T10PL	DOUBLE-T
T15P	H4B-T15P	H4B-T15PL	DOUBLE-T
T20P	H6B-T20P	H6B-T20PL	DOUBLE-T
T25P	H6B-T25P	H6B-T25PL	DOUBLE-T
T30P	-	H6B-T30PL	DOUBLE-T

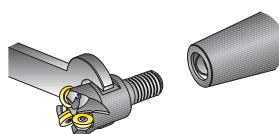

Hexagonal size	Hexagonal bit - short	Hexagonal bit - long	Key (T-handle)
2,5 mm	H4B-H2.5	-	DOUBLE-T
3,0 mm	H6B-H3.0	-	DOUBLE-T
5,0 mm	-	H6B-H5.0L	DOUBLE-T

Combimaster size M	Tightening torque
M6	10 Nm
M8	25 Nm
M10	40 Nm
M12	60 Nm
M16	80 Nm
M20	120 Nm

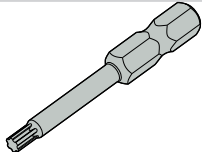
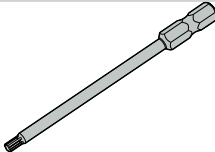
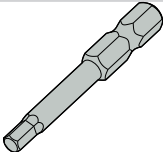

1/4" Hex Drive Bits and Adjustable Torque handles.

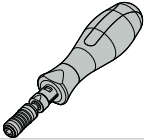
Size	Torx Plus bits (50mm / 1.96 inch)	Torx Plus bits (90mm / 3.54 inch)	Hexagonal bits (50mm / 1.96 inch)
			
Torx Plus - T05P	1/4HEX-T05Px50	-	
Torx Plus - T06P	1/4HEX-T06Px50	-	
Torx Plus - T07P	1/4HEX-T07Px50	-	
Torx Plus - T08P	1/4HEX-T08Px50	1/4HEX-T08Px90	
Torx Plus - T09P	1/4HEX-T09Px50	1/4HEX-T09Px90	
Torx Plus - T10P	1/4HEX-T10Px50	1/4HEX-T10Px90	
Torx Plus - T15P	1/4HEX-T15Px50	1/4HEX-T15Px90	
Torx Plus - T20P	1/4HEX-T20Px50	1/4HEX-T20Px90	
Torx Plus - T25P	1/4HEX-T25Px50	1/4HEX-T25Px90	
Torx Plus - T30P	1/4HEX-T30Px50	-	
Hexagonal - 2,5mm	-	-	1/4HEX-H2.5x50
Hexagonal - 4,0mm	-	-	1/4HEX-H4.0x50
Hexagonal - 5,0mm	-	-	1/4HEX-H5.0x50

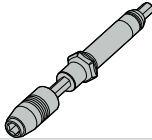
Adjustable torque S-handle 0,8 - 5,0Nm (7.1 - 44.0 in.lbs) *	Bit holder for S-HANDLE **	Adjustable torque T-handle 5,0 - 14,0Nm (44.0 - 123.9 in.lbs) *	Bit holder for T-HANDLE ***
			
1/4HEX-S-HANDLE-0.8-5.0NM	1/4HEX-BITHOLDER-S	1/4HEX-T-HANDLE-5.0-14.0NM	1/4HEX-BITHOLDER-T

* Including Bit holder

**The bit holder is also compatible with the fixed Torque keys.

*** The bit holder is also compatible with the fixed T-handle Torque keys.

Steels, ferritic and martensitic stainless steels

SMG	Description	Properties	Reference	$k_{c1.1}$	m_c
P1	Free-cutting steels	$360 < R_m < 880$	11 SMn30 $R_m = 385 \text{ N/mm}^2$	1500	0,14
P2	Low-alloy ferritic steels, $C < 0.25\% \text{wt}$ Low-alloy weldable general structural steels	$320 < R_m < 600$	S235JRG2 $R_m = 420 \text{ N/mm}^2$	1600	0,23
P3	Ferritic & ferritic/pearlitic steels, $C < 0.25\% \text{wt}$ Weldable general structural steels Case-hardening steels	$430 < R_m < 610$	16 MnCr 5 $R_m = 550 \text{ N/mm}^2$	1800	0,14
P4	Low-alloy general structural steels, $0.25\% < C < 0.67\% \text{wt}$ Low-alloy Quench & Temper steels	$520 < R_m < 1200$	C 45E $R_m = 660 \text{ N/mm}^2$	2000	0,15
P5	Structural steels, $0.25\% < C < 0.67\% \text{wt}$ Quench & Temper steels	$550 < R_m < 1200$	42 CrMo 4 $R_m = 700 \text{ N/mm}^2$	2020	0,18
P6	Low-alloy through-hardening steels, $C > 0.67\% \text{wt}$ Low-alloy spring and bearing steels	$520 < R_m < 1200$	C 100S $R_m = 600 \text{ N/mm}^2$	2100	0,17
P7	Through-hardening steels, $C > 0.67\% \text{wt}$ Spring and bearing steels	$600 < R_m < 1200$	100 Cr 6 $R_m = 650 \text{ N/mm}^2$	2160	0,17
P8	Tool steels High Speed Steels (HSS)	$600 < R_m < 1200$	X 40 CrMoV 5 1 $R_m = 700 \text{ N/mm}^2$	2400	0,20
P11	Ferritic & martensitic stainless steels	$415 < R_m < 1200$	X 20 Cr 13 $R_m = 675 \text{ N/mm}^2$	2000	0,15
P12	Maraging and precipitation- hardening stainless steels	$500 < R_m < 1200$	X 5 CrNiCuNb 16 4 $R_m = 1100 \text{ N/mm}^2$	2100	0,17

Free-cutting, austenitic and duplex stainless steels

SMG	Description	Properties	Reference	$k_{c1.1}$	m_c
M1	Free-cutting austenitic stainless steels		X 10 CrNiS 18 9	1700	0,14
M2	Low-alloy austenitic stainless steels		X 5 CrNi 18 10	1920	0,18
M3	Medium-alloy austenitic stainless steels		X 2 CrNiMo 18 14 3	2070	0,17
M4	High-alloy austenitic and duplex stainless steels		X 2 CrNiMoN 22 5 3	2230	0,16
M5	Difficult high-alloy austenitic and duplex stainless steels		X 2 CrNiMoN 25 7 4	2510	0,13

Cast irons

SMG	Description	Properties	Reference	$k_{c1.1}$	m_c
K1	Grey cast irons (GCI)		EN-GJL-250	930	0,32
K2	Compacted graphite irons (CGI)		EN-GJV-400	1000	0,35
K3	Malleable cast irons (MCI)		EN-GJMB-550-4	1050	0,37
K4	Nodular cast irons (SGI)		EN-GJS-500-7	1160	0,37
K5	Austempered ductile irons (ADI)		EN-GJS-1000-5		
K6	Austenitic lamellar cast irons		EN-GJLA-XNiCuCr15-6-2		
K7	Austenitic nodular cast irons		EN-GJSA-XNiMn23-4		

Non-ferrous metals

SMG	Description	Properties	Reference	$k_{c1.1}$	m_c
N1	Aluminium alloys, Si < 9%		AW-7075		
N2	Aluminium alloys, 9% < Si < 16%		AC-44200 Si = 12%		
N3	Aluminium alloys, Si > 16%		AlSi17Cu5		
N11	Copper alloys		CW614N	740	0,26

Superalloys and titanium

SMG	Description	Properties	Reference	$k_{c1.1}$	m_c
S1	Iron-based superalloys		Discolloy		
S2	Cobalt-based superalloys		Stellite 21		
S3	Nickel-based superalloys		Inconel 718	2530	0,21
S11	Titanium, low alloyed, (α)		Ti		
S12	Titanium, medium alloyed, (α + β)		TiAl6V4	1500	0,24
S13	Titanium, high alloyed, (near β and β)		Ti10V2Fe3Al		

Hard materials

SMG	Description	Properties	Reference	$k_{c1.1}$	m_c
H3	Case-hardened steels	58 < HRC < 62	16 MnCr 5 60 HRC	2070	0,14
H5	Quenched & Tempered steels	38 < HRC < 56	42 CrMo 4 50 HRC	2320	0,18
H7	Quenched & Tempered steels Bearing steels	56 < HRC < 64	100 Cr 6 60 HRC	2480	0,17
H8	Tool steels High Speed Steels (HSS)	38 < HRC < 64	X 40 CrMoV 5 1 50 HRC	2750	0,20
H11	Martensitic stainless steels	38 < HRC < 50	X 20 Cr 13 45 HRC	2300	0,15
H12	Maraged and precipitation- hardened stainless steels	1200 < R_m < 1650	X 5 CrNiCuNb 16 4 $R_m = 1450 \text{ N/mm}^2$	2410	0,17
H21	Manganese steels	23 < HRC < 64	X 120 Mn 12 50 HRC		
H31	White cast irons	50 < HRC < 64	EN-GJN-HV600(XCr11) 55 HRC		

Other difficult materials

SMG	Description	Properties	Reference	$k_{c1.1}$	m_c
PM1	Low-alloy PM-materials		F-0008 Fe-0.7C		
PM2	Medium-alloy PM-materials		FLC-4608 Fe2Cu1.8Ni 0.5Mo0.2Mn0.8C		
PM3	High-alloy PM-materials Exhaust valve seat materials, etc.				
HF1	Hardfacing alloys Welded or plasma-deposited iron-based alloys				
HF2	Hardfacing alloys Welded or plasma-deposited cobalt- and nickel-based alloys				
CC1	Sintered tungsten carbide		G50		

Plastics and Composites

SMG	Description	Properties	Reference	$k_{c1.1}$	m_c
TS1	Thermosetting polymers		Urea formaldehyde (UF)		
TS2	Thermosetting carbon-fibre composites		T300 T700 T800 HTA-S IMA - Epoxy (M21)...		
TS3	Thermosetting glass-fibre composites		Epoxy - HX..(42..)E glass (7781...)...		
TS4	Thermosetting aramide-fibre composites		Kevlar 49		
TP1	Thermoplastic polymers		Polycarbonate (PC)		
TP2	Thermoplastic carbon-fibre composites		PPS/PEEK - T300..		
TP3	Thermoplastic glass-fibre composites		PPS/PEEK - E-glass or A-glass...		
TP4	Thermoplastic aramide-fibre composites				

Graphite

SMG	Description	Properties	Reference	$k_{c1.1}$	m_c
GR1	Graphite		R 8500		

SMG

SMG	EN	EN-Nr	W-Nr	DIN	AFNOR	BS	UNI	JIS	SS	UNS
P1	11 SMn 30	1.0715	1.0715	9 SMn 28	S 250	230 M 07	CF 9 SMn 28	SUM 22	1912	G12130
	11 SMnPb 30	1.0718	1.0718	9 SMnPb 28	S 250 Pb		CF 9 SMnPb 28	SUM 22 L	1914	G12134
	10 S 20	1.0721	1.0721	10 S 20	10 F 1	210 M 15	CF 10 S 20			
			1.0722	10 SPb 20	10 PbF 2		CF 10 SPb 20			
	15 SMn 13	1.0725	1.0723	15 S 20		210 A 15		SUM 32	1922	
	35 S20	1.0726	1.0726	35 S 20	35 MF 4	212 M 36			1957	G11400
	46 S20	1.0727	1.0727	46 S 20	45 MF 4	212 M 44			1973	G11460
	11 SMn 37	1.0736	1.0736	9 SMn 36	S 300	240 M 07	CF 9 SMn 36			G12150
11 SMn 37	1.0736	1.0736	9 SMn 36	S 300	240 M 07	CF 9 SMn 36			G12150	
S235JR	1.0037	1.0037	St 37-2	E 24-2		Fe 360 B	STKM 12 C		1311	
S235JRG2	1.0038	1.0116	St 37-3	E 24-3, E 24-4	4360-40 C	Fe 360 D FF			1312, 1313	
S275J2G3	1.0144	1.0144	St 44-3 N	E 28-3, E 28-4	4360-43 C	Fe 430 D FF	SM 41 C		1412, 1414	
C 10	1.0301	1.0301	C 10	34 C 10, XC 10	045 M 10	C 10	S 10 C			G10100
		1.0401	C 15	37 C 12, XC 18	080 M 15	C 15, C 16			1350	G10170
C22	1.0402	1.0402	C 22	C 20	050 A 20	C 20, C 21			1450	G10200
S355JR	1.0570	1.0570	St 52-3	E 36-3, E 36-4	4360-50 C	Fe 510 B	SM 50 YA		2172, 2132	
C 15R	1.1141	1.1141	Ck 15	XC 15, XC 18	080 M 15	C 15, C 16			1370	G10170
		1.1158	Ck 25	XC 25	060 A 25	C 25	S 25 C			G10250
		1.2162	21 MnCr 5	20 NC 5			SCR 420 H			
P3	16 Mo 3	1.5415	1.5415	15 Mo 3	15 D 3	1501-240	16 Mo 3		2912	
			1.5423	16 Mo 5		1503-245-420	16 Mo 5	SB 450 M		G45200
	14 NiCr 14	1.5752	1.5752	14 NiCr 14	12 NC 15	655 M 13		SNC 815 (H)		G33106
			1.5919	15 CrNi 6	16 NC 6	S 107	16 CrNi 4			
	18 NiCrMo 7 6	1.6587	1.6587	18 CrNiMo 7 6	18 NCD 6	820 A 16	18 NiCrMo 7			
	16 MnCr 5	1.7131	1.7131	16 MnCr 5	16 MC 5	527 M 17	16 MnCr 5	SCR 415	2511	G51170
	16 MnCrS 5	1.7139	1.7139	16 MnCrS 5						
	20 MnCr 5	1.7147	1.7147	20 MnCr 5	20 MC 5		20 MnCr 5	SMnC 420 (H)		G51200
	20 MnCrS 5	1.7149	1.7149	20 MnCrS 5	20 MnCrS 5			SMnC 21 H		
	13 CrMo 4 5	1.7335	1.7335	13 CrMo 4 4	15 CD 3.5	1501-620 Gr. 27	14 CrMo 4 5		2216	
		1.7337	16 CrMo 4 4	15 CD 4.5	1501-620 Gr. 27	14 CrMo 4 5		2216		
10 CrMo 9 10	1.7380	1.7380	10 CrMo 9 10	10 CD 9.10	1501-622 Gr. 31	12 CrMo 9 10		2218	J21890	
P4	C35		1.0501	C 35	55 C 35	060 A 35	C 35		1550	G10350
	E 335	1.0503	1.0503	C 45	65 C 45	80 M 46	C 45	S 45 C	1650	G10430
	C40		1.0511	C 40	60 C 40	080 M 40	C 40	S 40 C		
	E 360	1.0070	1.0535	St 70-2	A 70-2		Fe 690		1655	
	C60	1.0601	1.0601	C 60	CC 55	080 A 62	C 60			G10600
			1.1157	40 Mn 4	35 M 5	150 M 36				G10390
	G 28 Mn6	1.1165	1.1165	30 Mn 5		120 M 36		SMn 1 H, SCMn 2		G13300
	C 35E	1.1181	1.1181	Ck 35	XC 38 H1	080 M 36	C 35	S 35 C	1572	G10340
	C 45E	1.1191	1.1191	Ck 45	XC 42	080 M 46	C 45	S 45 C	1672	G10420
	C 60E	1.1221	1.1221	Ck 60	XC 60	080 A 62	C 60	S 58 C	1665, 1678	G10640
			1.1740	C 60 W	Y3 55			SK 7		
P5	55 SiCr7	1.7100	1.0904	55 Si 7	55 S 7	250 A 53	55 Si 8		2085, 2090	
			1.2330	35 CrMo 4	34 CD 4	708 A 37	35 CrMo 4			T51620
			1.2542	45 WCrV 7		BS 1	45 WCrV 8 KU		2710	T41901
			1.2714	56 NiCrMoV 7		BH 224-5	56 NiCrMoV7-KU	SKT 4		T61206
			1.5121	46 MnSi 4						
			1.5710	36 NiCr 6	35 NC 6	640 A 35			SNC 236	
			1.5736	36 NiCr 10	35 NC 11		35 NiCr 9	SNC 631 (H)		
	36 CrNiMo 4		1.6511	36 CrNiMo 4	40 NCD 3	816 M 40	38 NiCrMo 4 (KB)			G98400
	34 CrNiMo 6	1.6582	1.6582	34 CrNiMo 6	35 NCD 6	817 M 40	35 NiCrMo 6 (KW)	SNCM 447	2541	G43400
	34 Cr 4	1.7033	1.7033	34 Cr 4	32 C 4	530 A 32	34 Cr 4 (KB)	SCR 430 (H)		G51320
	41 Cr 4	1.7035	1.7035	41 Cr 4	42 C 4	530 M 40	41 Cr 4	SCR 440 (H)		G51400
	25 CrMo 4	1.7218	1.7218	25 CrMo 4	25 CD 4 S	708 M 25	25 CrMo 4 (KB)	SCM 425	2225	G41300
	42 CrMo 4	1.7225	1.7225	42 CrMo 4	42 CD 4	708 M 40	42 CrMo 4	SCM 440 (H)	2244	G41400
	42 CrMo 4	1.7225	1.7225	42 CrMo 4	42 CD 4	708 M 40	42 CrMo 4	SCM 440 (H)	2244	G41400
		1.7361	32 CrMo 12	30 CD 12	722 M 24	32 CrMo 12		2240		
50 CrV 4	1.8159	1.8159	50 CrV 4	50 CV 4	735 A 50	51 CrV 4	SUP 10	2230	H61500	
41 CrAlMo 7 10	1.8509	1.8509	41 CrAlMo 7	40 CAD 6.12	905 M 39	41 CrAlMo 7	SACM 645	2940	K24065	
C 67S	1.1231	1.1231	Ck 67	XC 68	060 A 67	C 70		1770	G10700	
C 100S	1.1274	1.1274	Ck 101		060 A 96		SUP 4	1870	G10950	
C 105U	1.1545	1.1545	C 105 W1	Y1 105		C 100 KU		1880		
		1.1645	C 105 W2	Y1 105		C 100 KU	SK 3			
		1.1663	C 125 W	Y2 120		C 120 KU	SK 2			

SMG

U.N.E./ I.H.A.	AISI / ASTM	GOST	ČSN	Misc. Brands	Condition	Structure
	1213				Annealed	
	12 L 13				Annealed	
	1108				Annealed	
	11 L 08				Annealed	
					Annealed	
	1140	40			Annealed	
	1146				Annealed	
	1215				Annealed	
	12 L 14				Annealed	
		16D			Annealed	
	A573 Grade 58	18kp	11 378		Annealed	
	A573 Grade 70	St14kP	11 448		Annealed	
	1010	10			Annealed	
F.1110	1015	15			Annealed	
	1020, 1023	20	12 024		Annealed	
		17G1S	11 523		Annealed	
F.1511	1015	15			Annealed	
F.1120	1025	25			Annealed	
					Annealed	
	A204 Grade A		15 020		Annealed	
	4520				Annealed	
	3310, 9314	20X2H4A	16 420		Annealed	
	4320		16 220		Annealed	
					Annealed	
F.1516	5115	12KHN2	14 220		Annealed	
		18HG			Annealed	
	5120	20KH	14 221		Annealed	
	5120 H	20KH			Annealed	
	A182-F11, A182-F12	12KHM	15 121		Annealed	
	A387 Grade 12 Cl. 2				Annealed	
F.155	A182-F22	12KH8	15 313		Annealed	
F.1130	1035	35	12 040		Annealed	
F.5110	1045	45	12 050		Annealed	
	1040	40	12 041		Annealed	
F.1150	1055	55			Annealed	
	1060	60	12 061		Annealed	
	1039	40G			Annealed	
	1330	30G2			Annealed	
F.1135	1035	35			Annealed	
F.1140	1045	45	12 050		Annealed	
F.1150	1064	60			Annealed	
	1060	60			Annealed	
F.144	9255	55S2			Annealed	
F.1250	4135	35KHM			Annealed	
F.5241	S1	5KHV2S			Annealed	
	L6	5KHNV			Annealed	
	5045				Annealed	
	3135				Quenched & Tempered	
	3435				Annealed	
	9840				Quenched & Tempered	
F.1280	4340	38H2N2MA	16 343		Annealed	
	5132	35KH			Quenched & Tempered	
	5140	40H	14 140		Quenched & Tempered	
F.1251	4130	20KHM	15 130		Quenched & Tempered	
F.1252	4142, 4140	38HM	15 142		Annealed	
F.1252	4142, 4140	38HM	15 142		Quenched & Tempered	
					Quenched & Tempered	
F.143	6150	50KHFA	15 260		Quenched & Tempered	
F.1740	A355 Cl. A				Annealed	
F.5103	1070	70			Annealed	
F.5117	1095				Annealed	
F.5118	W1	U10A			Annealed	
		U10			Annealed	
	W1	U13			Annealed	

SMG

SMG	EN	EN-Nr	W.-Nr	DIN	AFNOR	BS	UNI	JIS	SS	UNS	
P7	107 CrV 3	1.2210	1.2210	115 CrV 3	100 C 3		107 CrV 3 KU			T61202	
			1.2510	100 MnCrW 4	90 MWCV 5	BO 1	95 MnWCr 5 KU	SKS 3	2140	T31501	
	90 MnCrV 8	1.2842	1.2842	90 MnCrV 8	90 MV 8	BO 2	90 MnVCr 8 KU			T31502	
	100 Cr 6	1.3505	1.3505	100 Cr 6	100 C 6	534 A 99	100 Cr 6	SUJ 2	2258	G51986	
P8	X 210 Cr 12	1.2080	1.2080	X 210 Cr 12	Z 200 C 12	BD 3	X 210 Cr 13 KU	SKD 1		T30403	
			1.2343	X 38 CrMoV 5 1	Z 38 CDV 5	BH 11	X 37 CrMoV 5 1 KU	SKD 6		T20811	
	X 40 CrMoV 5 1	1.2344	1.2344	X 40 CrMoV 5 1	Z 40 CDV 5	BH 13	X 40 CrMo 5 1 1 KU	SKD 61	2242	T20813	
	X 100 CrMoV 5	1.2363	1.2363	X 100 CrMoV 5 1	Z 100 CDV 5	BA 2	X 100 CrMoV 5 1 KU	SKD 12	2260	T30102	
			1.2365	X 32 CrMoV 3 3	32 DCV 28	BH 10	30 CrMoV 12 27 KU	SKD 7		T20810	
			1.2436	X 210 CrW 12			X 215 CrW 12 1 KU	SKD 2		2312	
			1.2601	X 165 CrMoV 12			X 165 CrMoW 12 KU			2310	
			1.2713	55 NiCrMoV 6	55 NCDV 7			SKT 4			T61206
	HS 6-5-2-5	1.3243	1.3243	S 6-5-2-5	Z 85 WDKCV 06-05-05-04-02			HS 6-5-2-5	SKH 55	2723	
	HS 2-10-1-8	1.3247	1.3247	S 2-10-1-8	Z 110 DKCWW 09-08-04		BM 42	HS 2-9-1-8	SKH 51		T11342
HS 18-1-2-5	1.3255	1.3255	S 18-1-2-5	Z 80 WKCW 18-05-04-01		BT 4	HS 18-1-1-5	SKH 3		T12004	
HS 6-5-2	1.3343	1.3343	S 6-5-2	Z 85 WDCV 06-05-04-02		BM 2	HS 6-5-2	SKH 9, SKH 51	2722	T11302	
HS 2-9-2	1.3348	1.3348	S 2-9-2	Z 100 DCWW 09-04-02-02			HS 2-9-2	SKH 58	2782	T11307	
HS 18-0-1	1.3355	1.3355	S 18-0-1	Z 80 WCV 18-04-01		BT 1	HS 18-0-1	SKH 2		T12001	
P11	X 6 Cr 13	1.4000	1.4000	X 6 Cr 13	Z 6 C 12	403 S 17	X 6 Cr 13	SUS 403	2301	S41008	
	X 12 Cr 13	1.4006	1.4006	X 10 Cr 13	Z 10 C 13	410 S 21	X 12 Cr 13	SUS 410	2302	S41000	
	X 6 Cr 17	1.4016	1.4016	X 6 Cr 17	Z 8 C 17	430 S 15	X 8 Cr 17	SUS 430	2320	S43000	
	X 20 Cr 13	1.4021	1.4021	X 20 Cr 13	Z 20 C 13	420 S 37	X 20 Cr 13	SUS 420 J 1	2303	S42000	
	X 39 Cr 13	1.4031	1.4031	X 40 Cr 13	Z 40 C 14	420 S 45	X 40 Cr 14	SUS 420	2304	S40280	
	X 70 CrMo 15	1.4109	1.4109	X 65 CrMo 14	Z 70 D 14			SUS 440 A		S44002	
	X 90 CrMoV 18	1.4112	1.4112	X 90 CrMoV 18	Z 2 CND 18 05	409 S 19	X CrTi 12	SUS 440 B	2327	S44003	
	X 105 CrMo 17	1.4125	1.4125	X 105 CrMo 17	Z 100 CD 17		X 105 CrMo 17	SUS 440 C		S44004	
	X 3 CrNiMo 13 3	1.4313	1.4313	X 5 CrNi 13 4	Z 5 CN 13 4	425 C 11	X 6 CrNi 13 04	SCS 5	2385	S41500	
	X 18 CrNi 28	1.4749	1.4749	X 18 CrNi 28	Z 18 C 25					2322	S44600
P12	X 6 NiCrTiMoV 25 15	1.4534	1.4534	X 3 CrNiMoAl 13 8 2						S13800	
	X 4 CrNiCuNb 16 4	1.4540	1.4540	X 4 CrNiCuNb 16 4						S15500	
		1.4540	1.4540	X 4 CrNiCuNb 16 4	Z 4 CNU Nb 16.4 M					S15500	
	X 4 CrNiCuNb 16 4	1.4540	1.4540	X 4 CrNiCuNb 16 4						S15500	
	X 5 CrNiCuNb 16 4	1.4542	1.4542	X 5 CrNiCuNb 16 4				SUS 630		S17400	
	X 5 CrNiCuNb 17 4	1.4548	1.4548	X 5 CrNiCuNb 17 4	Z 6 CNU 17.4			SCS 24, SUS 630		S17400	
	X 7 CrNiAl 17 7	1.4564	1.4564	X 7 CrNiAl 17 7	Z 9 CAN 17.7	301 S 81	X 7 CrNiAl 17 7	SUS 631	2388	S17700	
	X 2 NiCoMoTi 18 12 4	1.6356	1.6356	X 2 NiCoMoTi 18 12 4						K93160	
	X 2 NiCoMoTi 18 9 5	1.6358	1.6358	X 2 NiCoMoTi 18 9 5	Z 2 NKD 19-09					K93120	
	X 2 NiCoMo 18 9 5	1.6358	1.6358	X 2 NiCoMoTi 18 9 5	Z 2 NKD 19-09					K93120	
X 2 NiCoMo 18 8 5	1.6359	1.6359	X 2 NiCoMo 18 8 5		S 162				K92890		
X 2 NiCoMo 18 8 5	1.6359	1.6359	X 2 NiCoMo 18 8 5		S 162				K92890		
M1	X 10 CrNiS 18 9	1.4305	1.4305	X 10 CrNiS 18 9	Z 10 CNF 18.09	303 S 31	X 10 CrNi 18 09	SUS 303	2346	S30300	
M2	X 2 CrNi 19 11	1.4306	1.4306	X 2 CrNi 19 11	Z 2 CN 18.10	304 S 12	X 3 Cr Ni 18 11	SUS 304 L	2352	S30403	
	X 5 CrNi 18 10	1.4301	1.4301	X 5 CrNi 18 10	Z 6 CN 18.09	304 S 31	X 5 CrNi 18 11	SUS 304	2333	S30400	
	X 5 CrNiMo 17 12 2	1.4401	1.4401	X 5 CrNiMo 17 12 2	Z 3 CND 17.11.1	316 S 31	X 5 CrNiMo 17 12	SUS 316	2347	S31600	
	X 6 CrNiNb 18 10	1.4550	1.4550	X 6 CrNiNb 18 10	Z 6 CNNb 18.10	347 S 31	X 6 CrNiNb 18 11	SUS 347		2338	S34700
	X 9 CrNi 18 8	1.4310	1.4310	X 12 CrNi 17 7	Z 12 CN 17.07	301 S 21	X 12 CrNi 17 07	SUS 301		(2331)	S30100
X 12 CrNi 18 8	1.4300	1.4300	X 12 CrNi 18 8	Z 12 CN 18	302 S 25		SUS 302		2331	S30200	
M3	X 2 CrNiMo 18 14 3	1.4435	1.4435	X 2 CrNiMo 18 14 3	Z 2 CND 17.13	316 S 12	X 2 CrNiMo 17 13 2	SCS 16, SUS 316 L	2353	S31603	
	X 2 CrNiMoN 17 13 3	1.4429	1.4429	X 2 CrNiMoN 17 13 3	Z 2 CND 17.13 Az	316 S 62	X 2 CrNiMoN 17 13 3	SUS 316 LN		2375	S31653
	X 2 CrNiN 18 10	1.4311	1.4311	X 2 CrNiN 19 11	Z 2 CN 18 .10 Az	304 S 62	X 2 CrNiN 18 11	SUS 304 LN		2371	S30453
	X 3 CrNiMo 18 12 3	1.4466	1.4466	X 5 CrNi 18 15		317 S 16	X 5 CrNi 18 15	SUS 317		2366	S31700
	X 9 CrNiSiN 21 11 2	1.4835	1.4893	X 9 CrNiSiN 21 11 2		310 S 31				2368	S30815
	X 12 CrNi 25 21	1.4335	1.4335	X 12 CrNi 25 21	Z 12 CN 25.20	310 S 24	X 6 CrNi 26 20	SUH 310, SUS 310 S		2361	S31008
M4	X 2 CrNiMoN 22 5 3	1.4462	1.4462	X 2 CrNiMoN 22 5	Z 2 CND 22.05 Az	332 S 15	X 2 CrNiMoN 22 5			2377	S31803
	X 2 CrNiMoSi 19 5	1.4424	1.4417	X 2 CrNiMoSi 19 5	Z 2 CND 18.05.03					2376	S31500
	X 2 NiCrMoCu 25 20 5	1.4539	1.4539	X 2 NiCrMoCu 25 20 5	Z 2 NCDU 25 20	904 S 13				2562	N08904
	X 3 CrNiMo 27 5 2	1.4460	1.4460	X 4 CrNiMo 27 5 2	Z 3 CND 25.7 Az		X 3 CrNiMo 27 5 2	SUS 329 J 1		2324	S32900
X 5 CrNiCuNb 16 4	1.4980	1.4943	X 4 NiCrTi 25 15	Z 6 NCTDV 25.15		HR 51		SUH 660	2570	S66286	
M5	X 1 CrNiMoN 20 18 7	1.4547	1.4529	X 1 CrNiMoN 20 18 7	Z 1 CNDU 20.18.05 Az		X 1 CrNiMoN 20 18 7			2778	S31254
	X 1 CrNiMoN 25 22 8	1.4652	1.4652	X 2 CrNiMoN 25 22 7							S32654
	X 10 NiCrAlTi 32 20	1.4876	1.4876	X 10 NiCrAlTi 32 20	Z 10 NC 32.21			NCF 800			N08800
X 2 CrNiMoN 25 7 4	1.4410	1.4410	X 2 CrNiMoN 25 7 4	Z 3 CND 25.07 Az			X 2 CrNiMoN 25 7 4		2328	S32750	

SMG

U.N.E./I.H.A.	AIISI / ASTM	GOST	ČSN	Misc. Brands	Condition	Structure
F.520L	L2	11KHF			Annealed	
F.5220	O1	9KHVG			Annealed	
	O2	9G2F			Annealed	
F.5230	52100	SHKH15	14 109		Annealed	
F.5212	D3	KH12			Annealed	
	H11	4KH5MFS			Annealed	
F.5318	H13	4KH5MF1S			Annealed	
F.5227	A2	9KH5VF			Annealed	
	H10	3KH3M3F			Annealed	
F.5213		KH12			Annealed	
		KH12MF			Annealed	
F.520.S	L6	5KHNM			Annealed	
F.5613	M35	R6M5K5			Annealed	
	M42	R2AM9K5			Annealed	
	T4	R18K5F2			Annealed	
F.5603	M2	R6M5			Annealed	
	M7				Annealed	
	T1	R18			Annealed	
	403	08KH13			Annealed	Ferritic
F.3401	410, CA-15	12KH13, 08KH13			Annealed	Martensitic
F.3113	430	12KH17			Annealed	Ferritic
F.5261	420	20KH13	17 022		Annealed	Martensitic
F.3404	420	40KH13			Annealed	Martensitic
	440 A				Annealed	Martensitic
	440 B	95KH18			Annealed	Martensitic
	440 C	95KH18			Annealed	Martensitic
	A182 F6NM			F6NM	Annealed	Martensitic
	446	15KH28			Annealed	Ferritic
	XM-13			PH 13-8 Mo	Solution annealed	Austenitic
	XM-12			15-5 PH	H1150	Martensitic
	XM-12			15-5 PH	Solution annealed	Martensitic
	XM-12			15-5 PH	H1025	Martensitic
	SAE 630			17-4 PH	H1150	Martensitic
	630			17-4 PH	Solution annealed	Martensitic
	631	09KH17N7YU1		17-7 PH	Solution annealed	Austenitic/Ferritic
	AMS 6515			Marage 350	Solution annealed	Martensitic
	AMS 6521			Marage 300	Solution annealed	Martensitic
	AMS 6514			Marage 300, Vascomax C300	Solution annealed	Martensitic
	AMS 6512			Marage 250	Solution annealed	Martensitic
	AMS 6512			Marage 250, Vascomax C250	Solution annealed	Martensitic
F.3508	303	12KH19N9			Annealed	Austenitic
F.3504	304 L	03KH18N11			Annealed	Austenitic
F.3504	304	08KH18N10	17 240		Annealed	Austenitic
F.3534	316	08KH17H13M2T	17 346		Annealed	Austenitic
F.3524	347	08KH18N12B			Annealed	Austenitic
F.3517	301	07KH16N6			Annealed	Austenitic
	302	12KH18N9			Annealed	Austenitic
F.3533	(316 L)	03KH17N14M3	17 349		Annealed	Austenitic
	316 LN	03KH16N15M3			Annealed	Austenitic
F.3541	304 LN	03KH18N11			Annealed	Austenitic
	317	08KH17H15M3T			Annealed	Austenitic
				253 MA	Annealed	Austenitic
	310 S	12KH25N20			Annealed	Austenitic
	329 LN			SAF 2205	Annealed	Duplex
				3RE60	Annealed	Duplex
	904L				Annealed	Super austenitic
	329				Annealed	Duplex
	660			A286	Solution annealed	Austenitic
				254 SMO	Annealed	Super austenitic
				654 SMO	Annealed	Super austenitic
				Alloy 800	Annealed	Austenitic
	F 53			SAF 2507	Annealed	Super duplex

SMG

SMG	EN	EN-Nr	W.-Nr	DIN	AFNOR	BS	UNI	JIS	SS	UNS	
K1	EN-GJL-150	0.6150	0.6150	GG-15	Fl 15 D	Grade 150	G15	FC 150	01 15-00	F11601	
	EN-GJL-200	0.6200	0.6200	GG-20	Fl 20 D	Grade 220	G20	FC 200	01 20-00	F12101	
	EN-GJL-250	0.6250	0.6250	GG-25	Fl 25 D	Grade 260	G25	FC 250	01 25-00	F12401	
	EN-GJL-350	0.6350	0.6350	GG-35	Fl 35 D	Grade 350	G35	FC 350	01 35-00	F13502	
	EN-GJL-215			GG-220 HB					02 19		
K2	EN-GJV-300			GJV-300							
	EN-GJV-350			GJV-350							
	EN-GJV-400			GJV-400							
	EN-GJV-450			GJV-450							
	EN-GJV-500			GJV-500							
K3	EN-GJMB-550-4	0.8155		GTS-55-04	P 540/5	P 540/5	P 55-04	PCMP55-04	08 54-00	F24130	
K4	EN-GJS-350-22	0.7033	0.7033	GGG-35.3	FGS 370-17	Grade 350/22		FCD 350-22L	07 17-15		
	EN-GJS-400-15	0.7040	0.7040	GGG-40	FGS 400-12	Grade 420/12	GS 400-12	FCD 400-18L	07 17-02	F32800	
	EN-GJS-400-18	0.7043	0.7043	GGG-40.3	FGS 370-17	Grade 370/17	GSO 42/17		07 17-12	F32800	
	EN-GJS-500-7	0.7050	0.7050	GGG-50	FGS 500-7	Grade 500/7	GS 500-7	FCD 500-7	07 27-02	F33800	
	EN-GJS-600-3	0.7060	0.7060	GGG-60	FGS 600-3	Grade 600/3	GS 600-3	FCD 600-3	07 32-03	F34100	
	EN-GJS-700-2	0.7070	0.7070	GGG-70	FGS 700-2	Grade 700/2	GS 700-2	FCD 700-2	07 37-01	F34800	
K5	EN-GJS-1000-5			GJS-1000-5						ADI grade 5	
	EN-GJS-1200-2			GJS-1200-2						ADI grade 2	
	EN-GJS-1400-1			GJS-1400-1						ADI grade 3	
	EN-GJS-800-8			GJS-800-8						ADI grade 4	
K6	EN-GJLA-XNiCr 20-2	0.6660	0.6660	GGL-NiCr 20 2	FGL Ni20 Cr2	Grade F2			05 23-00	F41002	
	EN-GJLA-XNiCr 30-3	0.6676	0.6676	GGL-NiCr 30 3	FGL Ni30 Cr3	Grade F3				F41004	
	EN-GJLA-XNiCuCr 15-6-2	0.6655	0.6655	GGL-NiCuCr 15 6 2	FGL Ni15 Cu6 Cr2	Grade F1				F41000	
K7	EN-GJSA-XNiMn 13-7	0.7652	0.7652	GGG-NiMn 13 7	FGS Ni13 Mn7	Grade S6			07 72-00		
	EN-GJSA-XNiCr 20-2	0.7660	0.7660	GGG-NiCr 20 2	FGS Ni20 Cr2	Grade S2				F43000	
	EN-GJSA-XNiMn 23-4	0.7673	0.7673	GGG-NiMn 23 4	FGS Ni23 Mn4	Grade S2M				F43010	
	EN-GJSA-XNiCr 30-3	0.7676	0.7676	GGG-NiCr 30 3	FGS Ni30 Cr3	Grade S3				F43003	
	EN-GJSA-XNi 35	0.7683	0.7683	GGG-Ni 35	FGS Ni35					F43006	
N1	AW-1050A	Al99.5	3.0255	Al99.5	A-5/1050A	1B		(A1050)	4007	AA1050A	
	AW-2011	AlCuBiPb	3.1655	AlCuBiPb	A-U5PbBi/2011	FC1		A2011	4355	AA2011	
	AW-2014	AlCuSiMn	3.1255	AlCuSiMn	A-U4SG/2014	H15			4338	AA2014	
	AW-5005	AlMg1	3.3315	AlMg1	A-G0.6	N41			4106	AA5005	
	AW-6060	AlMgSi0.5	3.3206	AlMgSi0.5	A-GS/6060	(H9)			4103	AA6060	
	AW-6063	AlMgSi0.7	3.3210	AlMgSi0.7	A-GSUC/6061	(H10)		(A6063)	4104, 4107	AA6005	
	AW-3103	AlMn1	3.0515	AlMn1		N3			4054	AA3103	
	AW-3003	AlMn1Cu	3.0517	AlMn1Cu	A-M1/3003			A3003		AA3003	
	AW-7020	AlZn4.5Mg1	3.4335	AlZn4.5Mg1	A-Z5G/7020	H17			4425	AA7020	
	AW-7075		3.4365	AlZnMgCu1.5	A-Z5GU/7075	2L95/2L96			A7075	AA7075	
	AC-42000		3.2341	G-AlSi5Mg	A-S7G	LM25	3599		AC 4C	4244	
	AC-46200	AlSi8Cu3(Si)	3.2161	G-AlSi8Cu3						4251	A13800
	MG-P-63	MgAl6Zn	3.5612	G-MgAl6Zn	G-A6-Z1	MAG-E-121					M11600
	MG-P-61	MgAl8Zn	3.5812	G-MgAl8Zn	(G-A7-Z1)						
	MN65120	MgSe3Zn2Zr1	3.5103	G-MgSe3Zn2Zr1	ZRE1	MAG6-TE					M12330
	N2	AC-43400	AlSi10Mg(Fe)	3.2381	G-AlSi10Mg	A-S10G	LM9			4253	A13600
		AC-44200	AlSi12	3.2382	GD-AlSi12						
AW-6082		AlMgSi1	3.2315	AlMgSi1	A-SGM0.7/6082	H30			4212	AA6082	
N3			AlSi17Cu5					ADC14			
N11	CC331G		2.0940.01	CuAl10Fe	CuAl10Fe	AB1			5710	C95200	
	CC333G		2.0975.01	CuAl10Ni	CuAl10Ni5Fe5	AB2			5716	C95500	
		CuNi10Fe1Mn	2.0872	CuNi10Fe1Mn	CuNi10Fe1Mn	CN102			5667	C70600	
				CuNi10Zn45							
		CW408J	2.0790	CuNi18Zn19Pb	CuNi18Zn19Pb1						C76300
	CW352H		2.1176	CuPb10Sn	CuSn10Pb10	LB2			5640	C93700	
	CC480K		2.1050.01	CuSn10	CuSn10	CT1			5443	C90700	
			2.1087	CuSn10Zn					5458	C90500	
	CW452K	CuSn6	2.1020	CuSn6	CuSn6	PB103		C5191	5428	C51900	
	CW502L	CuZn15	2.0240	CuZn15	CuZn15	CZ102		C2300	5112	C23000	
	CW706R	CuZn28Sn1	2.0470	CuZn28Sn1	CuZn29Sn1				5220	C44300	
	CW508L	CuZn37	2.0321	CuZn37	CuZn37	CZ108			5150	C27200	
	CW717R	CuZn38Sn1	2.0530	CuZn38Sn1							C46400
	CW614N	CuZn39Pb3	2.0401	CuZn39Pb3	CuZn39Pb3	CZ121			5170	C38500	
	CW612N	CuZn40Pb2	2.0402	CuZn40Pb2	CuZn39Pb2	CZ120			5168	C37800	
	CW622N	CuZn44Pb2	2.0410	CuZn44Pb2		CZ104			5272	C68700	

SMG

SMG	EN	EN-Nr	W.-Nr	DIN	AFNOR	BS	UNI	JIS	SS	UNS
S1										
S2										
S3	NiMo30		2.4810							N10002
	NiMo16Cr15W		2.4819							N10276
	NiCr19Fe19Nb5Mo3		2.4668							N07718
			2.4669							N07750
	NiCr20TiAl		2.4631							N07080
	NiCr19Co18Mo4Ti3Al3									N07500
	NiCr20Co13Mo4Ti3Al		2.4654							N07001
S11			3.7024							R54620
S12										R56320
	TiAl6V4		3.7164							R56400
S13				TiV10Fe2Al3						
H3	16 MnCr 5	1.7131	1.7131	16 MnCr 5	16 MC 5	527 M 17	16 MnCr 5	SCR 415	2511	G51170
H5	C 67S	1.1231	1.1231	Ck 67	XC 68	060 A 67	C 70		1770	G10700
	C 75S	1.1248	1.1248	Ck 75	XC 75	060 A 78	C 75		1774, 1778	G10780
	C 100S	1.1274	1.1274	Ck 101		060 A 96		SUP 4	1870	G10950
	C 105U	1.1545	1.1545	C 105 W1	Y1 105		C 100 KU		1880	
			1.2550	60 WCrV 7	55 WC 20		55 WCrV 8 KU			
	55 Cr 3	1.7176	1.7176	55 Cr 3	55 C 3	527 A 60	55 Cr 3	SUP 9 (A)	2253	G51550
H7	42 CrMo 4	1.7225	1.7225	42 CrMo 4	42 CD 4	708 M 40	42 CrMo 4	SCM 440 (H)	2244	G41400
	107 CrV 3	1.2210	1.2210	115 CrV 3	100 C 3		107 CrV 3 KU			T61202
			1.2510	100 MnCrW 4	90 MWCV 5	BO 1	95 MnWCr 5 KU	SKS 3	2140	T31501
	90 MnCrV 8	1.2842	1.2842	90 MnCrV 8	90 MV 8	BO 2	90 MnVCr 8 KU			T31502
H8	100 Cr 6	1.3505	1.3505	100 Cr 6	100 C 6	534 A 99	100 Cr 6	SUJ 2	2258	G51986
	X 40 CrMoV 5 1	1.2344	1.2344	X 40 CrMoV 5 1	Z 40 CDV 5	BH 13	X 40 CrMo 5 1 1 KU	SKD 61	2242	T20813
	X 100 CrMoV 5	1.2363	1.2363	X 100 CrMoV 5 1	Z 100 CDV 5	BA 2	X 100 CrMoV 5 1 KU	SKD 12	2260	T30102
	X 155 CrVMo 12 1		1.2379	X 155 CrVMo 12 1	Z 160 CDV 12	BD 2	X 155 CrVMo 12 1 KU	SKD 11		T30402
			1.2436	X 210 CrW 12			X 215 CrW 12 1 KU	SKD 2	2312	
			1.2601	X 165 CrMoV 12			X 165 CrMoV 12 KU		2310	
			1.2713	55 NiCrMoV 6	55 NCDV 7			SKT 4		T61206
	HS 6-5-2-5	1.3243	1.3243	S 6-5-2-5	Z 85 WDKCV 06-05-05-04-02		HS 6-5-2-5	SKH 55	2723	
	HS 2-10-1-8	1.3247	1.3247	S 2-10-1-8	Z 110 DKCWV 09-08-	BM 42	HS 2-9-1-8	SKH 51		T11342
	HS 18-0-1	1.3355	1.3355	S 18-0-1	Z 80 WCV 18-04-01	BT 1	HS 18-0-1	SKH 2		T12001
H11	X 20 Cr 13	1.4021	1.4021	X 20 Cr 13	Z 20 C 13	420 S 37	X 20 Cr 13	SUS 420 J 1	2303	S42000
	X 70 CrMo 15	1.4109	1.4109	X 65 CrMo 14	Z 70 D 14			SUS 440 A		S44002
	X 90 CrMoV 18	1.4112	1.4112	X 90 CrMoV 18	Z 2 CND 18 05	409 S 19	X CrTi 12	SUS 440 B	2327	S44003
	X 105 CrMo 17	1.4125	1.4125	X 105 CrMo 17	Z 100 CD 17		X 105 CrMo 17	SUS 440 C		S44004
	X 4 CrNiCuNb 16 4	1.4540	1.4540	X 4 CrNiCuNb 16 4						S15500
H12	X 5 CrNiCuNb 16 4	1.4542	1.4542	X 5 CrNiCuNb 16 4				SUS 630		S17400
	X 5 CrNiCuNb 16 4	1.4542	1.4542	X 5 CrNiCuNb 16 4				SUS 630		S17400
	X 7 CrNiAl 17 7	1.4568	1.4568	X 7 CrNiAl 17 7	Z 9 CAN 17.7	301 S 81	X 7 CrNiAl 17 7	SUS 631	2388	S17700
	X 8 CrNiMoAl 15 7 5	1.4574	1.4574	X 8 CrNiMoAl 15 7 5						S15700
	X 6 NiCrTiMoV 25 15	1.4980	1.4943	X 4 NiCrTi 25 15	Z 6 NCTDV 25.15	HR 51		SUH 660	2570	S66286
	X 2 NiCoMo 18 8 5	1.6359	1.6359	X 2 NiCoMo 18 8 5		S 162				K92890
	X 2 NiCoMoTi 18 9 5	1.6358	1.6358	X 2 NiCoMoTi 18 9 5	Z 2 NKD 19-09					K93120
	X 2 NiCoMoTi 18 9 5	1.6358	1.6358	X 2 NiCoMoTi 18 9 5	Z 2 NKD 19-09					K93120
	X 2 NiCoMoTi 18 12 4	1.6356	1.6356	X 2 NiCoMoTi 18 12 4						K93160
	H21	X 120 Mn 12	1.3401	1.3401	X 120 Mn 12	Z 120 M 12	BW 10		SC MnH 1	2183
H31	EN-GJN-HV520	0.9620	0.9620	G-X330 NiCr 4 2	FB Ni4 Cr2 BC	Grade 2 A			05 12-00	F45001
	EN-GJN-HV550	0.9625	0.9625	G-X260 NiCr 4 2	FB Ni4 Cr2 HC	Grade 2 B			05 13-00	F45000
	EN-GJN-HV600(XCr11)	0.9630	0.9630	G-X300 CrNiSi 9 5 2	FB Cr9 Ni5	Grade 2 C, D, E			04 57-00	F45003

SMG

U.N.E./ I.H.A.	AISI / ASTM	GOST	ČSN	Misc. Brands	Condition	Structure
				Discolloy	Precipitation hardened	
				Haynes 25		
				Stellite 21		
				Hastelloy C		
		KHN65MV		Hastelloy C-276		
				IN 100		
				Inconel 718		
				Inconel X-750	Solution annealed	
				Nimonic 80A		
				René 41		
				Udimet 500		
				Waspalloy		
				Ti	Commercially pure	Ti (α)
	AMS 4919			Ti 6-2-4-2	Annealed	Ti (α)
	AMS 4943			Ti 3Al-2.5V (grd 9)	Annealed	Ti (α+β)
	AMS 4920, Grade 5	VT6		Ti 6Al-4V	Annealed	Ti (α+β)
	AMS 4986			Ti 10V-2Fe-3Al	Annealed	Ti (β)
F.1516	5115	12KHN2	14 220		Case hardened	
F.5103	1070	70			Quenched & Tempered	
F.5107	1078, 1080	75			Quenched & Tempered	
F.5117	1095				Quenched & Tempered	
F.5118	W1	U10A			Quenched & Tempered	
	S1	5KHV2SF			Quenched & Tempered	
	5155				Quenched & Tempered	
F.1252	4142, 4140	38HM	15 142		Quenched & Tempered	
F.520L	L2	11KHF			Quenched & Tempered	
F.5220	O1	9KHVG			Quenched & Tempered	
	O2	9G2F			Quenched & Tempered	
F.5230	52100	SHKH15	14 109		Quenched & Tempered	
F.5318	H13	4KH5MF1S			Quenched & Tempered	
F.5227	A2	9KH5VF			Quenched & Tempered	
F.5211	D2	KH12MF			Quenched & Tempered	
F.5213		KH12			Quenched & Tempered	
		KH12MF			Quenched & Tempered	
F.520.S	L6	5KHNM			Quenched & Tempered	
F.5613	M35	R6M5K5			Quenched & Tempered	
	M42	R2AM9K5			Quenched & Tempered	
	T1	R18			Quenched & Tempered	
F.5261	420	20KH13	17 022		Quenched & Tempered	Martensitic
	440 A				Quenched & Tempered	Martensitic
	440 B	95KH18			Quenched & Tempered	Martensitic
	440 C	95KH18			Quenched & Tempered	Martensitic
	XM-12			15-5 PH	H900	Martensitic
	SAE 630			17-4 PH	H1025	Martensitic
	SAE 630			17-4 PH	H900	Martensitic
	AMS 5528	09KH17N7YU1		17-7 PH	TH1050	Martensitic
	632			PH 15-7 Mo	TH1050	Martensitic
	660			A286	Precipitation hardened	Austenitic
	AMS 6512			Marage 250	Precipitation hardened	Martensitic
	AMS 6521			Marage 300	Precipitation hardened	Martensitic
	AMS 6521			Marage 300	Precipitation hardened	Martensitic
	AMS 6515			Marage 350	Precipitation hardened	Martensitic
	A128 Grade A			Hadfield		
	A532 IB (NiCr-LC)			Ni-Hard 2		White cast iron
	A532 IA (NiCr-HC)			Ni-Hard 1		White cast iron
	A532 ID (Ni-HiCr)			Ni-Hard 4		White cast iron

Cemented carbide inserts and insert carriers

Cemented carbide inserts and cemented carbide insert carriers from Seco Tools are not included in the product range intended for the following requirements. Nevertheless Seco Tools can make the following declaration.

These products meet all requirements in RoHS (Restriction of the use of certain Hazardous Substances in electrical and electronic equipment), WEEE (Waste Electrical & Electronic Equipment) and ELV (End of Life Vehicles) requirements.

Products do not contain mercury, lead, hexavalent chromium, cadmium, CFC, HCFC, flame retardants or solvents in concentrations that exceed specifications in the regulations.

Regrinding:

Wet or dry grinding can produce potentially hazardous dusts or mists that can irritate skin, eyes, nose, throat and result in lung damage or disease. To avoid injury use proper safety precautions and protective equipment.

Disposal:

Seco Tools will buy back used inserts and solid carbide tools for recycling. Inserts and solid carbide tools should be separated from other metal waste (steel, aluminium, copper etc).

All packing material is fully recyclable.

CBN and PCD inserts

Inserts from Seco Tools are not included in the product range intended for the following requirements. Nevertheless Seco Tools can make the following declaration.

This product meets all requirements in RoHS (Restriction of the use of certain Hazardous Substances in electrical and electronic equipment), WEEE (Waste Electrical & Electronic Equipment) and ELV (End of Life Vehicles) requirements.

Products do not contain mercury, lead, hexavalent chromium, cadmium, CFC, HCFC, flame retardants or solvents in concentrations that exceed specifications in the regulations.

Regrinding:

Wet or dry grinding can produce potentially hazardous dusts or mists that can irritate skin, eyes, nose, throat and result in lung damage or disease. To avoid injury use proper safety precautions and protective equipment.

Disposal:

Seco Tools will buy back used CBN- or PCD-tipped inserts for recycling. Inserts should be separated from other metal waste (steel, aluminium, copper etc). Solid CBN-inserts may be discarded as landfill waste.

All packing material is fully recyclable.

Black oxide insert carriers

Insert carriers from Seco Tools are not included in the product range intended for the following requirements. Nevertheless Seco Tools can make the following declaration.

This product meets all requirements in RoHS (Restriction of the use of certain Hazardous Substances in electrical and electronic equipment), WEEE (Waste Electrical & Electronic Equipment) and ELV (End of Life Vehicles) requirements.

Products do not contain mercury, lead, hexavalent chromium, cadmium, CFC, HCFC, flame retardants or solvents in concentrations that exceed specifications in the regulations.

Disposal:

Used insert carriers may be sent for recycling together with ordinary steel waste (swarf and discarded steel scrap) for recycling.

All packing material is fully recyclable.

Cermet inserts

Inserts from Seco Tools are not included in the product range intended for the following requirements. Nevertheless Seco Tools can make the following declaration.

This product meets all requirements in RoHS (Restriction of the use of certain Hazardous Substances in electrical and electronic equipment), WEEE (Waste Electrical & Electronic Equipment) and ELV (End of Life Vehicles) requirements.

Cermet grade C15M inserts do contain nickel and will leach nickel when in contact with the skin. Amount of leaching is higher than specified in norm SS-EN 1811 Reference test method for release of nickel from products intended to come into direct and prolonged contact with the skin. These norms are intended for products that are in direct and prolonged contact with the skin and are therefore not directly applicable for cermet inserts. Persons with known allergic reactions to nickel are advised to wear protective gloves when handling cermet inserts.

Regrinding:

Wet or dry grinding can produce potentially hazardous dusts or mists that can irritate skin, eyes, nose, throat and result in lung damage or disease. To avoid injury use proper safety precautions and protective equipment.

Disposal:

Used inserts may be recycled. Inserts should be separated from other metal waste (steel, aluminium, copper, etc) including cemented carbide inserts. All packing material is fully recyclable.

Nickel coated insert carriers

Insert carriers from Seco Tools are not included in the product range intended for the following requirements. Nevertheless Seco Tools can make the following declaration.

This product meets all requirements in RoHS (Restriction of the use of certain Hazardous Substances in electrical and electronic equipment), WEEE (Waste Electrical & Electronic Equipment) and ELV (End of Life Vehicles) requirements.

Products do not contain mercury, lead, hexavalent chromium, cadmium, CFC, HCFC, flame retardants or solvents in concentrations that exceed specifications in the regulations. Insert carriers do contain nickel and will leach nickel when in contact with the skin. Amount of leaching is not higher than norm SS-EN 1811 Reference test method for release of nickel from products intended to come into direct and prolonged contact with the skin.

These norms are intended for products that are in direct and prolonged contact with the skin and are therefore not directly applicable for insert carriers. Persons with known allergic reactions to nickel are advised to wear protective gloves when handling nickel coated insert carriers.

Disposal:

Used tools maybe sent for recycling together with ordinary steel waste (swarf and discarded steel scrap) for recycling. All packing material is fully recyclable.

Intentionally added alloying elements

Grade	Cemented carbide											Coating						
	W	Ti	Ta	Nb	Co	Cr	Ni	Mo	C	N	Ru	Ti	Al	C	N	O	Si	Nb
CP20	■				■				■			■			■			
CP200	■				■	■			■			■	■		■			
CP300	■	■	■	■	■				■			■	■		■			
CP500	■				■	■			■			■	■		■			
CP600	■				■	■			■			■	■		■			
C15M	■	■	■	■	■		■	■	■									
CF	■				■		■	■	■									
CM	■				■		■	■	■									
DP2000	■				■				■			■	■	■	■	■		
DP3000	■	■	■	■	■				■			■	■	■	■	■		
DS2050	■				■	■			■			■	■		■			
DS4050	■				■	■			■			■	■		■			■
F15M	■				■	■			■			■	■		■			
F25M	■	■	■	■	■	■			■			■	■		■			
F30M	■				■	■			■			■	■		■			
F40M	■				■	■			■			■	■		■			
HX	■		■		■	■			■			■	■		■			
H02	■		■		■	■			■			■	■		■			
H15	■				■	■			■			■	■		■			
H25	■				■	■			■			■	■		■			
KX	■				■	■			■			■	■		■			
MH1000	■				■	■			■			■	■		■			
MK1500	■		■		■	■			■			■	■	■	■	■		
MK2050	■		■		■	■			■			■	■		■		■	
MM4500	■				■	■			■			■	■	■	■	■	■	
MP1501	■		■	■	■	■			■			■	■	■	■	■	■	
MP2050	■				■	■			■		■	■	■		■		■	
MP2501	■		■	■	■	■			■			■	■	■	■	■	■	
MP3000	■				■	■			■			■	■		■		■	
MS2500	■		■	■	■	■			■			■	■	■	■	■	■	
MS2050	■				■	■			■			■	■		■		■	
RX1500	■		■		■	■	■	■	■			■	■		■			■
RX2000	■		■		■	■			■			■	■		■			
RM2020	■				■	■			■			■	■		■			
RM2090	■				■	■			■			■	■		■			
RN2010	■				■	■			■			■	■		■		■	
RS2090	■				■	■			■			■	■		■		■	
T350M	■		■	■	■	■			■			■	■	■	■	■	■	
T25M	■		■	■	■	■			■			■	■	■	■	■	■	
TGH1050	■				■	■			■			■	■		■		■	
TGK1500	■		■		■	■			■			■	■	■	■	■	■	
TGP25	■	■	■	■	■	■			■			■	■	■	■	■	■	
TGP35	■		■	■	■	■			■			■	■	■	■	■	■	
TGP45	■		■	■	■	■			■			■	■	■	■	■	■	
TGS2050	■				■	■			■			■	■	■	■	■	■	
TH1000	■				■	■			■			■	■		■		■	
TH1500	■				■	■			■			■	■	■	■	■	■	
TK0501	■				■	■			■			■	■	■	■	■	■	
TK1501	■		■		■	■			■			■	■	■	■	■	■	
TM1501	■	■	■	■	■	■			■		■	■	■	■	■	■	■	
TM2000	■	■	■	■	■	■			■		■	■	■	■	■	■	■	
TM2501	■	■	■	■	■	■			■		■	■	■	■	■	■	■	
TM3501	■				■	■			■			■	■	■	■	■	■	
TM4000	■	■	■	■	■	■			■		■	■	■	■	■	■	■	
TP0501	■	■	■	■	■	■			■			■	■	■	■	■	■	
TP1020	■	■	■	■	■	■			■		■	■	■	■	■	■	■	
TP1030	■	■	■	■	■	■			■			■	■	■	■	■	■	
TP1501	■	■	■	■	■	■			■			■	■	■	■	■	■	
TP25	■	■	■	■	■	■			■			■	■	■	■	■	■	
TP200	■	■	■	■	■	■			■			■	■	■	■	■	■	
TP2501	■	■	■	■	■	■			■			■	■	■	■	■	■	
TP3501	■	■	■	■	■	■			■			■	■	■	■	■	■	
TP40	■				■	■			■			■	■	■	■	■	■	
TS2000	■				■	■			■			■	■	■	■	■	■	
TS2050	■				■	■			■			■	■	■	■	■	■	
TS2500	■		■		■	■			■			■	■	■	■	■	■	
TTP2050	■				■	■			■			■	■	■	■	■	■	
T250D	■				■	■			■			■	■	■	■	■	■	
T400D	■				■	■			■			■	■	■	■	■	■	
T100R	■		■		■	■			■			■	■	■	■	■	■	
T60M	■	■	■	■	■	■			■			■	■	■	■	■	■	
883	■		■		■	■			■			■	■	■	■	■	■	
890	■				■	■			■			■	■	■	■	■	■	

This work is published with the understanding that Seco Tools and its editors are supplying information aimed to present a general orientation and direction of metal cutting and related sciences. If professional services are required for specific applications, the assistance of an appropriate professional should be acquired.

The information is provided “as is”;

Seco Tools and its editors disclaim all representations and warranties, express or implied, of any kind, including, without limitations, any warranties of merchantability, fitness for a particular purpose, title, or non-infringement. In no event will Seco Tools or its editors be liable to any party for any direct, indirect, special or other consequential damages for any use of the information, even if Seco Tools or its editors are advised of the possibility of such damage.

The information provided herein is for reference purposes only. Actual prices, specifications, and product descriptions are finalised at the time of sale and may vary by location.

The information provided herein is subject to change without prior notice.

WWW.SECOTOOLS.COM

70024852, ST20236774 GB,
© SECO TOOLS AB, 2023. All rights reserved.
Technical specifications are subject to
change without notice.