











Tapping

Taps Introduction	L2–L15
Spiral-Point/Left-Hand Spiral-Flute Taps	M2–M18
Spiral-Flute Taps	M20–M50
Straight-Flute Taps.....	M52–M68
Forming Taps.....	M70–M75
Pipe Taps	M76–M79
Solid Carbide Thread Mills	M80–M97
Technical Information	M98–M132

Spiral-Point and Left-Hand Spiral-Flute Taps	series	grade/ coating	shank/dimension	● first choice ○ alternate choice						
				P	M	K	N	S	H	
	T320	KC7542	6535 HA	●		○				
	T320	KC7542	6535 HA	●		○				
	T321	KC7542	6535 HA	●		○				
	T620	KP6525 KM6515	DIN 371, 374, 376	●	●	○	○			
	T621	KP6525 KM6515	DIN 371, 374, 376	●	●	○	○			
	T620	KP6525	DIN 376	●		●				
	T620	KP6525	XL	●		●				
	T620	KP6525	DIN 371, 376	●	○	○				
	T621	KP6525	DIN 371, 376	●	○	○				
	T670	KSN38	DIN 371, 376				●			
	T600	KSP21	DIN 371, 374, 376	●					○	
	T820	KSP32 KSP39	DIN 371, 374, 376	●	○	●	○			
	T820	KSP39	DIN 371, 376	○	○	○				
	T820	KSU31 KSU30	JIS	●	○	○	○			



	size range min-max	hole		chamfer		helix angle	coolant		page(s)	recommended cutting parameters
		through	blind	type	form		flood	through		
										
	3/8-1/2"	●		plug	D	L15°	●		M4	M98
	M6-M16	●		plug	D	L15°	●		M4	M98
	M10-M16	●		plug	D	L15°		●	M5	M98
	M3-M20	●		plug	D	L15°	●		M6	M98
	M5-M18	●		plug	D	L15°		●	M7	M98
	M24-M42	●		plug	D	L15°	●		M8	M98
	M24-M42	●		plug	D	L15°		●	M9	M98
	#6-1/2"	●		plug	D	L15°	●		M10	M98
	1/4-1/2"	●		plug	D	L15°		●	M11	M98
	M3-M16	●		plug	B	0°	●		M12	M98
	M3-M20	●		plug	B	0°	●		M13	M98
	M2-M36	●		plug	B	0°	●		M14-M15	M99
	#4-1"	●		plug	B	0°	●		M16-M17	M99
	M3-M20	●		plug	B	0°	●		M18	M99

Spiral-Flute Taps	series	grade/coating	shank/dimension	● first choice ○ alternate choice						
				P	M	K	N	S	H	
	T331	KC7542	6535 HA	●		○				
	T331	KC7542	6535 HA	●		○				
	T630	KP6525, KM6515	DIN 371, 374, 376	●	●	○	○			
	T631	KP6525, KM6515	DIN 371, 374, 376	●	●	○	○			
	T632	KP6525	DIN 371, 374, 376	●		○				
	T633	KP6525	DIN 371, 374, 376	●		○				
	T630	KP6525	DIN 376	●		●				
	T631	KP6525	DIN 376	●		●				
	T630	KP6525	XL	●		●				
	T631	KP6525	XL	●		●				
	T650	KP6525	DIN 376	●		●				
	T651	KP6525	DIN 376	●		●				
	T650	KP6525	XL	●		●				
	T651	KP6525	XL	●		●				
	T630	KP6525	DIN 371, 376	●	○	○				
	T631	KP6525	DIN 371, 376	●	○	○				
	T680	KSN38	DIN 371, 376				●			
	T604	KSH26	DIN 371, 374, 376	●				○		
	T830	KSP32, KSP39	DIN 371, 374, 376	●	○	●	○			
	T832	KSP32, KSP39	DIN 371, 374, 376	●	○	●	○			
	T838	KSU31, KSP39	DIN 371, 374, 376	●	○	○	○			
	T839	KSU31, KSP39	DIN 371, 376	●	○	○	○			
	T830	KSP39	DIN 371, 376	○	○	○				
	T838	KSU31, KSP39	DIN 371, 374, 376	●	○	○	○			
	T830	KSU31, KSU30	JIS	●	○	○	○			

	size range min-max	hole		chamfer		helix angle	coolant		page(s)	recommended cutting parameters
		through	blind	type	form		flood	through		
										
1/4-1/2"			●	semi-bottoming	C	45°		●	M22	M98
M6-M16			●	semi-bottoming	C	45°		●	M23	M98
M3-M20			●	semi-bottoming	C	45°	●		M24	M98
M5-M18			●	semi-bottoming	C	45°		●	M25	M98
M5-M16			●	bottoming	E	45°	●		M26	M98
M5-M16			●	bottoming	E	45°		●	M27	M98
M24-M42			●	semi-bottoming	C	45°	●		M28	M98
M24-M42			●	semi-bottoming	C	45°		●	M29	M98
M24-M42			●	semi-bottoming	C	45°	●		M30	M98
M24-M42			●	semi-bottoming	C	45°		●	M31	M98
M24-M42			●	semi-bottoming	C	15°	●		M32	M98
M24-M42			●	semi-bottoming	C	15°		●	M33	M98
M24-M42			●	semi-bottoming	C	15°	●		M34	M98
M24-M42			●	semi-bottoming	C	15°		●	M35	M98
#6-1/2"			●	semi-bottoming	C	45°	●		M36	M98
1/4-1/2"			●	semi-bottoming	C	45°		●	M37	M98
M3-M20			●	semi-bottoming	C	45°	●		M38	M98
M3-M20			●	semi-bottoming	C	42°	●		M39	M98
M2-M36			●	semi-bottoming	C	45°	●		M40-M41	M99
M3-M20			●	bottoming	E	45°	●		M42	M99
M2-M52			●	semi-bottoming	C	45°	●		M43-M44	M99
M3-M20			●	bottoming	E	45°	●		M45	M99
#4-1"			●	semi-bottoming	C	45°	●		M46, M49	M99
#6-2"			●	semi-bottoming	C	45°	●		M47-M48	M99
M3-M20			●	semi-bottoming	C	45°	●		M50	M99





Straight-Flute Taps	series	grade/coating	shank/dimension	● first choice ○ alternate choice					
				P	M	K	N	S	H
	T340	KCK17	6535 HA	○	●				
	T340	KCK17	6535 HA	○	●				
	T351	KCK17	6535 HA	○	●				
	T351	KCK17	6535 HA	○	●				
	T351	KCK17	DIN 371, 374, 376	○	●				
	T353	KCK17	DIN 371, 376	○	●				
	T471	KCN14	6535 HA			●			
	T471	KCN14	DIN 371			●			
	T410	KCU36	DIN 371, 374, 376					●	
	T640	KP6525	DIN 371, 376			●	●		
	T641	KP6525	DIN 371, 376			●	●		
	T642	KP6525	DIN 371, 374, 376			●	●		
	T643	KP6525	DIN 371, 374, 376			●	●		
	T640	KP6525	DIN 371, 376			●	●		
	T641	KP6525	DIN 371, 376			●	●		





*Through coolant 1/4", M6 and larger.

	size range min-max	hole		chamfer		helix angle	coolant		page(s)	recommended cutting parameters
		through	blind	type	form		flood	through		
										
#6-9/16"	●		plug	D	0°	●		M54	M98	
M4-M20	●		plug	D	0°	●		M55	M98	
#6-3/4"		●	bottoming	E	0°		●	M56	M98	
M4*-M16		●	bottoming	E	0°		●	M57	M98	
M6-M14		●	bottoming	E	0°		●	M58	M98	
M4*-M14		●	semi-bottoming	C	0°		●	M59	M98	
M6-M14		●	bottoming	E	0°		●	M60	M98	
M6-M10		●	bottoming	E	0°		●	M61	M98	
M3-M16		●	semi-bottoming	C	0°	●		M62	M98	
M4-M22	●	●	semi-bottoming	C	0°	●		M63	M98	
M5-M20		●	semi-bottoming	C	0°		●	M64	M98	
M5-M16	●	●	bottoming	E	0°	●		M65	M98	
M5-M16		●	bottoming	E	0°		●	M66	M98	
#6-1/2"	●	●	semi-bottoming	C	0°	●		M67	M98	
1/4-1/2"		●	semi-bottoming	C	0°		●	M68	M98	

Forming Taps	series	grade/coating	shank/dimension	● first choice ○ alternate choice					
				P	M	K	N	S	H
					T491	KCN14	6535 HA		
	T491	KCN14	DIN 2174				●		
	T622	KSP21, KSN28	DIN 2174	●			●		
	T623	KSP21, KSN28	DIN 2174	●			●		

Pipe Taps	series	grade/coating	shank/dimension	● first choice ○ alternate choice					
				P	M	K	N	S	H
					T877	KSU31, KSP39	DIN 5156	●	○
	T857	KSU31, KSP39	DIN 5156	●	○	○	○		
	T848	KSU30	DIN 5156	○		○			

	size range min-max	hole		chamfer		helix angle	coolant		page(s)	recommended cutting parameters
		through	blind	type	form		flood	through		
										
	M5-M12		●	bottoming	E	–		●	M72	M98
	M6-M10		●	bottoming	E	–		●	M73	M98
	M3-M16	●	●	semi-bottoming	C	–	●		M74	M98
	M5-M16		●	semi-bottoming	C	–		●	M75	M98

	size range min-max	hole		chamfer		helix angle	coolant		page(s)	recommended cutting parameters
		through	blind	type	form		flood	through		
										
	1/8-1"	●		plug	B	0°	●		M78	M99
	1/8-1"		●	semi-bottoming	C	42°	●		M78	M99
	1/16-1"	●	●	semi-bottoming	C	0°	●		M79	M99

Solid Carbide Tap Identification System

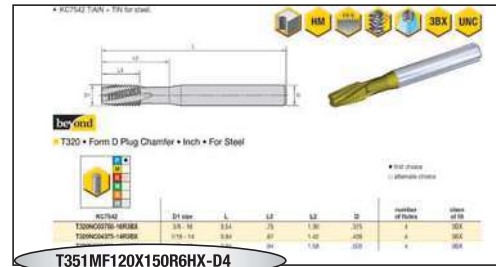

Metric							
T351	MF	120	X	150	R	6HX	-D4
T320	NC	05000	-	13	R	3BX	
Tap Design	Type of Thread	Nominal Diameter of Thread		Pitch	Cutting Direction	Tolerance Class	Taps Dimension
		mm or inch (depending on type)		mm or TPI (depending on type)			

M = Metric coarse-pitch thread (ISO form)	D1 = DIN 371
MF = Metric fine-pitch thread (ISO form)	D4 = DIN 374
NC = Unified coarse series thread	D6 = DIN 376
NF = Unified fine series thread	D74 = DIN 2174
	blank = 6535 HA

Tap design

- T320** = Steel, through holes, LH spiral flute, solid
- T321** = Steel, through holes, LH spiral flute, through coolant
- T331** = Steel, blind holes, RH spiral flute, through coolant
- T340** = Cast iron and cast aluminium, through holes, straight flute, solid
- T351** = Cast iron and cast aluminium, blind holes, straight flute, through coolant
- T353** = Cast iron and cast aluminium, blind holes, straight flute, through coolant
- T410** = Hard steel 55–63 HRC, through and blind holes, straight flute, solid
- T471** = Aluminium, blind holes, straight flute, through coolant
- T491** = Aluminium, blind holes, forming tap, through coolant

HSS-E-PM Tap Identification System

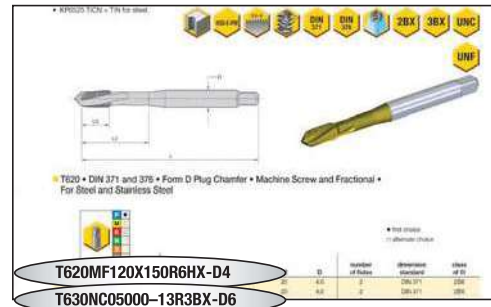

Metric	Inch
T620	T630
MF	NC
120	05000
X	-
150	13
R	R
6HX	3BX
-D4	-D6
Tap Design	Type of Thread
	Nominal Diameter of Thread
	Pitch
	Cutting Direction
	Tolerance Class
	Taps Dimension
	mm or inch (depending on type)
	mm or TPI (depending on type)

- M** = Metric coarse-pitch thread (ISO form)
- MF** = Metric fine-pitch thread (ISO form)
- NC** = Unified coarse series thread
- NF** = Unified fine series thread

- D1** = DIN 371
- D4** = DIN 374
- D6** = DIN 376
- D74** = DIN 2174
- XL** = DIN extra length

- Tap design**
- T600** = Steel 32–44 HRC, through holes, spiral point, solid
 - T604** = Steel 32–44 HRC, blind holes, 3 x D, RH 42° spiral flute, solid
 - T620** = Steel and stainless steel, through holes, LH spiral flute, solid
 - T621** = Steel and stainless steel, through holes, LH spiral flute, through coolant
 - T622** = Steel and aluminium, blind and through holes, forming tap, solid
 - T623** = Steel and aluminium, blind holes, forming tap, through coolant
 - T630** = Steel and stainless steel, blind holes, RH spiral flute, solid
 - T631** = Steel and stainless steel, blind holes, RH spiral flute, through coolant
 - T632** = Steel and stainless steel, blind holes, RH spiral flute, solid
 - T633** = Steel and stainless steel, blind holes, RH spiral flute, through coolant
 - T640** = Cast iron and cast aluminium, through and blind holes, straight flute, solid
 - T641** = Cast iron and cast aluminium, blind holes, straight flute, through coolant
 - T642** = Cast iron and cast aluminium, blind holes, straight flute, solid
 - T643** = Cast iron and cast aluminium, blind holes, straight flute, through coolant
 - T650** = Steel and cast iron, blind holes, RH spiral flute, large sizes, solid
 - T651** = Steel and cast iron, blind holes, RH spiral flute, large sizes, through coolant
 - T670** = Aluminium, through holes, spiral point, solid
 - T680** = Aluminium, blind holes, RH spiral flute, solid

GOtap HSS-E Tap Identification System

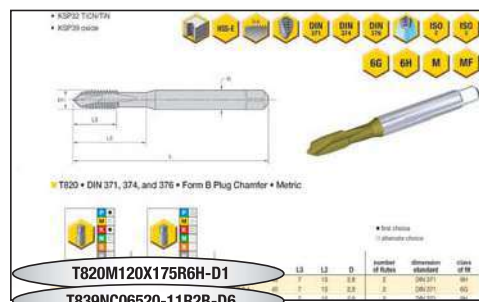

Metric	M	120	X	175	R	6H	-D1
T820	M	120	X	175	R	6H	-D1
Inch	NC	06520	-	11	R	2B	-D6
T839	NC	06520	-	11	R	2B	-D6
Tap Design	Type of Thread	Nominal Diameter of Thread		Pitch	Cutting Direction	Tolerance Class	Taps Dimension
		mm or inch (depending on type)		mm or TPI (depending on type)			

<p>M = Metric coarse-pitch thread (ISO form) MF = Metric fine-pitch thread (ISO form) NC = Unified coarse series thread NF = Unified fine series thread NPT = American standard taper pipe thread NPTF = Dryseal American standard taper pipe thread G = DIN EN ISO 228</p>	<p>D1 = DIN 371 D4 = DIN 374 D6 = DIN 376 D56 = DIN 5156 J = JIS</p>
--	---

Tap design

T820 = Steel, stainless steel, ductile iron, and cast aluminium, through holes, spiral point, solid

T830 = Steel, stainless steel, ductile iron, and cast aluminium, blind holes, spiral flute, semi-bottoming, solid

T832 = Steel, stainless steel, ductile iron, and cast aluminium, blind holes, spiral flute, bottoming, solid

T838 = Steel, stainless steel, ductile iron, and cast aluminium, blind holes, spiral flute, TC, semi-bottoming, solid

T839 = Steel, stainless steel, ductile iron, and cast aluminium, blind holes, spiral flute, TC, bottoming, solid

T848 = Steel, stainless steel, ductile iron, and cast aluminium, straight flute, NPT, NPTF, solid

T857 = Steel, stainless steel, ductile iron, and cast aluminium, spiral flute, G, solid

T877 = Steel, stainless steel, ductile iron, and cast aluminium, spiral point, G, solid

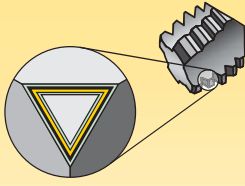

Coatings are designed for optimised tapping performance in specific materials.

P	Steel
M	Stainless Steel
K	Cast Iron
N	Non-Ferrous
S	High-Temp Alloys
H	Hardened Materials

wear resistance ← → toughness

Grade

Coating	Grade Description		05	10	15	20	25	30	35	40	45
KC7542 	Coated carbide, PVD-multilayer coating with TiAlN and TiN over a high-strength carbide substrate specifically designed for tap application. Use in steel up to 32 HRC and cast iron at 4x faster speeds than HSS-E-PM taps.	P									
		K									
KCK17 	Multilayer PVD AlCrN-coated fine-grain carbide. Newly-developed unique coating. Extraordinary wear resistance when tapping cast iron. High-temperature hardness enables long life at up to 4x faster speed than HSS-E-PM taps.	K									
KCN14 	Coated carbide, PVD-two-layer coating over fine-grain carbide. Coating consists of low-friction CrC/C over wear-resistant TiN. CrC/C resists galling of non-ferrous materials to the tap. Provides superior performance for tapping cast aluminium and other non-ferrous materials.	N									
KCU36 	Coated carbide, PVD — two-layer coating with heat-resistant TiAlN base layer and low-friction MoS ₂ top layer over carbide substrate. Use in hardened steel 55–63 HRC.	H									
KSP21 	Coated HSS-E-PM. PVD — powder metal HSS-E substrate with TiN coating. Use for tapping steel 32–44 HRC and for forming threads in steel 32 HRC.	P									
KSH26 	Coated HSS-E-PM. PVD — powder metal HSS-E substrate coated with TiN base layer and low-friction MoS ₂ top layer. Use in deep blind steel holes 32–44 HRC.	P									

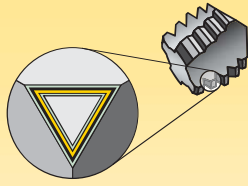

Coatings are designed for optimised tapping performance in specific materials.

P	Steel
M	Stainless Steel
K	Cast Iron
N	Non-Ferrous
S	High-Temp Alloys
H	Hardened Materials

wear resistance ← → toughness

Grade

Coating	Grade Description		05	10	15	20	25	30	35	40	45	
KSN25	Coated HSS-E-PM. PVD — powder metal HSS-E substrate with two-layer coating: TiN base layer and DLC top layer that resists galling of non-ferrous materials to the tap. Use for tapping titanium. Not recommended for steel.											
		S										
KSN28	Coated HSS-E-PM. PVD — powder metal HSS-E substrate with DLC coating. Use for form tapping aluminium. Not recommended for steel.											
		N										
KSN38	Coated HSS-E. PVD — lower vanadium HSS-E substrate with DLC coating. Use for tapping non-ferrous materials with low cutting temperatures like wrought aluminium. Not recommended for steel.											
		N										
KP6525	Coated HSS-E-PM. PVD — heat- and wear-resistant high vanadium — cobalt powder metal HSS substrate coated with wear-resistant TiCN base layer and low-friction TiN top layer. Use in steel, cast iron, and cast aluminium with silicon.											
		P										
		K										
KIM6515	Coated HSS-E-PM. PVD — heat- and wear-resistant high vanadium — cobalt powder metal HSS substrate. Coating consists of low-friction CrC/C over wear-resistant TiN base layer. Use for tapping stainless steel and non-ferrous materials.											
		M										
		N										
KSP32	High-vanadium HSS-E substrate coated with wear resistant TiCN base layer and low-friction TiN top layer. Use in multiple applications, including steel, stainless steel, ductile cast iron, and cast aluminium. KSP32 is abrasion resistant.											
		P										
		M										
K												
N												

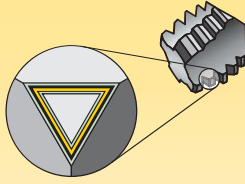

Coatings are designed for optimised tapping performance in specific materials.

P	Steel
M	Stainless Steel
K	Cast Iron
N	Non-Ferrous
S	High-Temp Alloys
H	Hardened Materials

Grade

Grade	Coating	Grade Description	wear resistance ← → toughness													
			05	10	15	20	25	30	35	40	45					
KSMN34		High-vanadium HSS-E substrate with a coating consists of low-friction CrC/C over wear-resistant TiN base layer. Use for tapping stainless steel and non-ferrous materials.														
			M													
			N													
KSU31		Coated HSS-E substrate with TiN PVD layer. Use in multiple applications, including steel, stainless steel, ductile cast iron, and cast aluminium.	P													
			M													
			K													
			N													
KSP39		HSS-E substrate with black oxide surface treatment. Use in a variety of materials, including steel, stainless steel, and ductile iron. Not recommended for non-ferrous materials.	P													
			M													
			K													
KSU30		Uncoated HSS-E grade with bright surface. Use in easy to machine, general-purpose applications.	P													
			M													
			K													
			N													



Tapping Portfolio

Spiral-Point/Left-Hand Spiral-Flute Taps	M2–M18
Beyond High-Performance Solid Carbide Taps.....	M4–M5
High-Performance HSS-E-PM Taps	M6–M13
Multipurpose GOtap	M14–M18
Spiral-Flute Taps	M20–M50
Beyond High-Performance Solid Carbide Taps.....	M22–M23
High-Performance HSS-E-PM Taps	M24–M39
Multipurpose GOtap	M40–M50
Straight-Flute Taps	M52–M68
Beyond High-Performance Solid Carbide Taps.....	M54–M62
High-Performance HSS-E-PM Taps	M63–M68
Forming Taps	M70–M75
Beyond High-Performance Solid Carbide Taps.....	M72–M73
High-Performance HSS-E-PM Taps	M74–M75
Pipe Taps	M76–M79
Multipurpose GOtap	M78–M79
Solid Carbide Thread Mills	M80–M97
Taps and Thread Milling Application and Technical Information	M98–M132

➤ Spiral-Point and Left-Hand Spiral-Flute Taps



High-Performance Taps for Through-Hole Applications

- Steel and steel alloys.
- Stainless steel.
- Cast iron.
- Nickel- and cobalt-based alloys.
- Titanium and titanium alloys.
- Aluminium.
- Hard steel.

High-Performance Beyond™ Solid Carbide Taps

- Left-hand spiral flute for optimal chip evacuation ahead of the tap.
- Runs up to 4x faster and 4x longer than conventional high-speed steel (HSS) taps.
- Ideal for long production runs where fewer tool changes result in greater productivity.
- For use on CNC machines with synchronous or rigid controls and precision toolholders.

High-Performance Beyond™ HSS-E-PM Taps

- Left-hand spiral flute for optimal chip evacuation ahead of the tap.
- Higher strength and wider range of applications versus solid carbide taps.
- Higher tapping speed capability and longer tool life than conventional HSS-E taps.
- Can be used on either conventional or synchronous tapping machines.

Multipurpose HSS-E GOtap™ Taps

- Optimised spiral-point geometry for efficient chip evacuation in through-hole applications.
- Manufactured with high vanadium HSS-E material for exceptional wear characteristics and longer tool life.
- Advanced PVD coatings to reduce tapping torque, resulting in high-quality thread finish and longer tool life.
- For use in both synchronous and non-synchronous machines, including rigid, synchronous, and tension/compression tap holders.



High-Performance Taps

Beyond™ Solid Carbide Left-Hand Spiral-Flute, Right-Hand Cut Taps • Through Holes



- KC7542 TiAIN + TiN for steel.

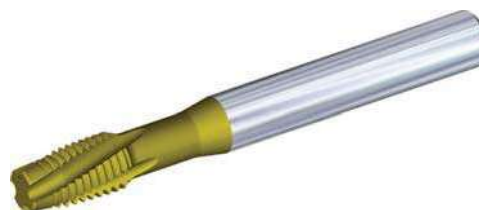
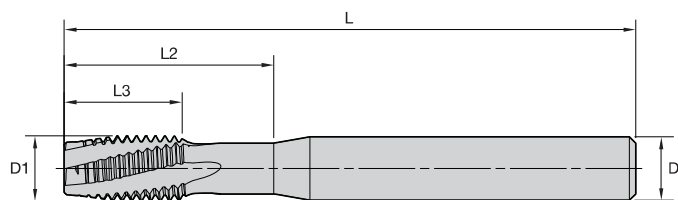

■ T320 • Form D Plug Chamfer • Inch • Solid Carbide • For Steel

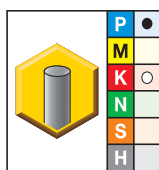

- first choice
- alternate choice

KC7542	D1 size	L	L3	L2	D	number of flutes	class of fit
T320NC03750-16R3BX	3/8 - 16	3.54	.75	1.30	.375	4	3BX
T320NC04375-14R3BX	7/16 - 14	3.94	.87	1.42	.438	4	3BX
T320NC05000-13R3BX	1/2 - 13	3.94	.94	1.58	.500	4	3BX

Shank Tolerance

D	tolerance h6
.250-.375	+0, -.0004
.438-.625	+0, -.0004



■ T320 • Form D Plug Chamfer • Metric • Solid Carbide • For Steel

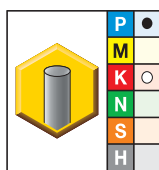

- first choice
- alternate choice

KC7542	D1 size	L	L3	L2	D	number of flutes	class of fit
T320M060X100R6HX	M6 X 1	70	12	23	6,0	3	6HX
T320M080X125R6HX	M8 X 1,25	80	15	28	8,0	3	6HX
T320M100X150R6HX	M10 X 1,5	90	18	33	10,0	4	6HX
T320M120X175R6HX	M12 X 1,75	100	21	40	12,0	4	6HX
T320MF140X150R6HX *	M14 X 1,5	110	24	47	12,0	4	6HX
T320M160X200R6HX	M16 X 2	110	24	53	14,0	4	6HX

NOTE: Proprietary technology.

*Made-to-order standard item. Standard pricing, manufacturing lead time, and minimum order quantity applies.

Shank Tolerance

D	tolerance h6
6	+0, -0,008
8-10	+0, -0,009
12-16	+0, -0,011

- KC7542 TiAlN + TiN for steel.

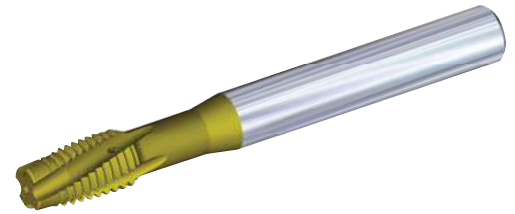
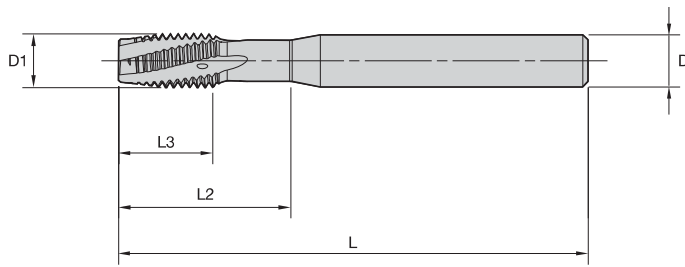

■ T321 • Form D Plug Chamfer • Through Coolant • Metric • Solid Carbide • For Steel

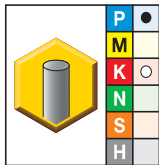

- first choice
- alternate choice

KC7542	D1 size	L	L3	L2	D	number of flutes	class of fit
T321M100X150R6HX	M10 X 1,5	90	18	33	10,0	4	6HX
T321MF120X150R6HX	M12 X 1,5	100	21	40	12,0	4	6HX
T321M120X175R6HX	M12 X 1,75	100	21	40	12,0	4	6HX
T321MF140X150R6HX	M14 X 1,5	110	24	47	12,0	4	6HX
T321M140X200R6HX	M14 X 2	110	24	47	12,0	4	6HX
T321M160X200R6HX *	M16 X 2	110	24	53	14,0	4	6HX

NOTE: Proprietary technology.

*Made-to-order standard item. Standard pricing, manufacturing lead time, and minimum order quantity applies.

Shank Tolerance

D	tolerance h6
6	+0, -0,008
8-10	+0, -0,009
12-16	+0, -0,011



High-Performance Taps

Beyond™ Left-Hand Spiral-Flute, Right-Hand Cut HSS-E-PM Taps • Through Holes



- KM6515 TiN + CrC/C for tapping stainless steel.
- KP6525 TiCN + TiN for tapping steel.

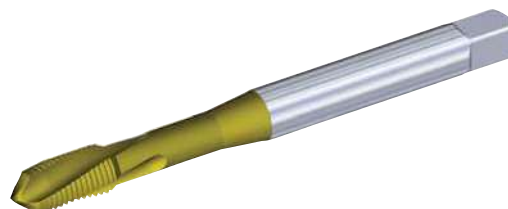
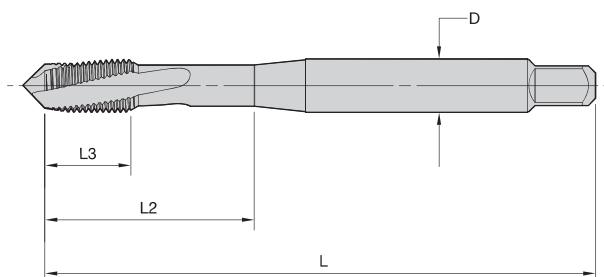

T620 • DIN 371, 374, and 376 • Form D Plug Chamfer • Metric • For Steel and Stainless Steel

Tapping

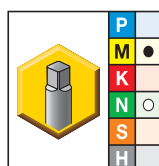
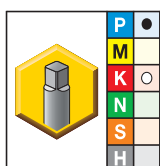

- first choice
- alternate choice

		D1 size	L	L3	L2	D	number of flutes	dimension standard	class of fit
KP6525	KM6515								
T620M030X050R6HX-D1	T620M030X050R6HX-D1	M3 X 0,5	56	8	18	3,5	2	DIN 371	6HX
T620M040X070R6HX-D1	T620M040X070R6HX-D1	M4 X 0,7	63	10	21	4,5	2	DIN 371	6HX
T620M050X080R6HX-D1	T620M050X080R6HX-D1	M5 X 0,8	70	10	25	6,0	2	DIN 371	6HX
T620M060X100R6HX-D1	T620M060X100R6HX-D1	M6 X 1	80	10	30	6,0	3	DIN 371	6HX
T620MF080X100R6HX-D4	T620MF080X100R6HX-D4	M8 X 1	90	13	35	6,0	3	DIN 374	6HX
T620M080X125R6HX-D1	T620M080X125R6HX-D1	M8 X 1,25	90	13	35	8,0	3	DIN 371	6HX
T620MF100X100R6HX-D4	T620MF100X100R6HX-D4	M10 X 1	90	10	35	7,0	3	DIN 374	6HX
T620MF100X125R6HX-D4	—	M10 X 1,25	100	15	39	7,0	3	DIN 374	6HX
T620M100X150R6HX-D1	T620M100X150R6HX-D1	M10 X 1,5	100	15	39	10,0	3	DIN 371	6HX
T620MF120X150R6HX-D4	T620MF120X150R6HX-D4	M12 X 1,5	100	15	39	9,0	3	DIN 374	6HX
T620M120X175R6HX-D6	T620M120X175R6HX-D6	M12 X 1,75	110	18	44	9,0	3	DIN 376	6HX
T620MF140X150R6HX-D4	T620MF140X150R6HX-D4	M14 X 1,5	100	15	47	11,0	4	DIN 374	6HX
T620M140X200R6HX-D6	T620M140X200R6HX-D6	M14 X 2	110	20	52	11,0	4	DIN 376	6HX
T620MF160X150R6HX-D4	T620MF160X150R6HX-D4	M16 X 1,5	100	15	46	12,0	4	DIN 374	6HX
T620M160X200R6HX-D6	T620M160X200R6HX-D6	M16 X 2	110	20	51	12,0	4	DIN 376	6HX
T620MF180X150R6HX-D4	T620MF180X150R6HX-D4	M18 X 1,5	110	15	50	14,0	4	DIN 374	6HX
T620M200X250R6HX-D6	T620M200X250R6HX-D6	M20 X 2,5	140	25	64	16,0	4	DIN 376	6HX

Shank Tolerance

D	tolerance h6
12-18	+0, -0,011
20-30	+0, -0,013
32-36	+0, -0,016

- KM6515 TiN + CrC/C for stainless steel.
- KP6525 TiCN + TiN for steel.

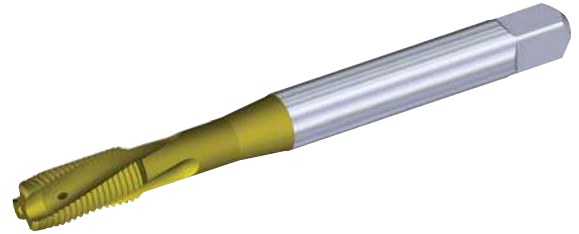
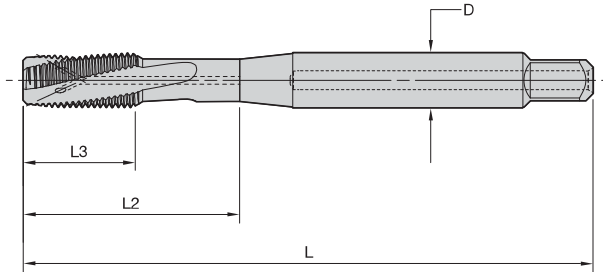
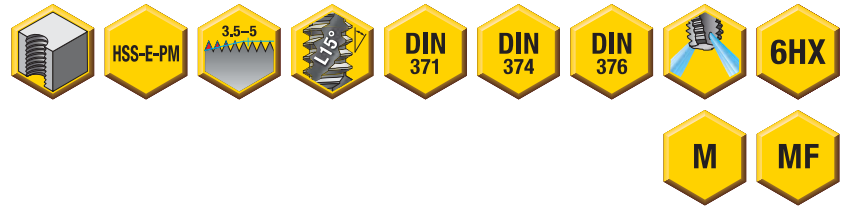

■ T621 • DIN 371, 374, and 376 • Form D Plug Chamfer • Through Coolant • Metric • For Steel and Stainless Steel

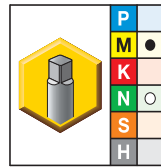
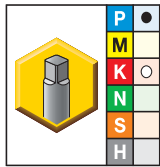

- first choice
- alternate choice

		D1 size	L	L3	L2	D	number of flutes	dimension standard	class of fit
KP6525	KM6515								
T621M050X080R6HX-D1	T621M050X080R6HX-D1	M5 X 0,8	70	10	25	6,0	2	DIN 371	6HX
T621M060X100R6HX-D1	T621M060X100R6HX-D1	M6 X 1	80	10	30	6,0	3	DIN 371	6HX
T621MF080X100R6HX-D4 *	T621MF080X100R6HX-D4 *	M8 X 1	90	13	35	6,0	3	DIN 374	6HX
T621M080X125R6HX-D1	T621M080X125R6HX-D1	M8 X 1,25	90	13	35	8,0	3	DIN 371	6HX
T621MF100X100R6HX-D4	T621MF100X100R6HX-D4	M10 X 1	90	10	35	7,0	3	DIN 374	6HX
T621MF100X125R6HX-D4	T621MF100X125R6HX-D4	M10 X 1,25	100	15	39	7,0	3	DIN 374	6HX
T621M100X150R6HX-D1	T621M100X150R6HX-D1	M10 X 1,5	100	15	39	10,0	3	DIN 371	6HX
T621MF120X125R6HX-D4	—	M12 X 1,25	100	15	39	9,0	3	DIN 374	6HX
T621MF120X150R6HX-D4	T621MF120X150R6HX-D4	M12 X 1,5	100	15	39	9,0	3	DIN 374	6HX
T621M120X175R6HX-D6	T621M120X175R6HX-D6	M12 X 1,75	110	18	44	9,0	3	DIN 376	6HX
T621MF140X125R6HX-D4	—	M14 X 1,25	100	15	47	11,0	4	DIN 374	6HX
T621MF140X150R6HX-D4	T621MF140X150R6HX-D4	M14 X 1,5	100	15	47	11,0	4	DIN 374	6HX
T621M140X200R6HX-D6	T621M140X200R6HX-D6	M14 X 2	110	20	52	11,0	4	DIN 376	6HX
T621MF160X150R6HX-D4	T621MF160X150R6HX-D4	M16 X 1,5	100	15	46	12,0	4	DIN 374	6HX
T621M160X200R6HX-D6	T621M160X200R6HX-D6	M16 X 2	110	20	51	12,0	4	DIN 376	6HX
T621MF180X150R6HX-D4	T621MF180X150R6HX-D4	M18 X 1,5	110	15	50	14,0	4	DIN 374	6HX
T621M180X250R6HX-D6	T621M180X250R6HX-D6	M18 X 2,5	125	25	58	14,0	4	DIN 376	6HX

NOTE: *Made-to-order standard item. Standard pricing, manufacturing lead time, and minimum order quantity applies.

Shank Tolerance

D	tolerance h6
6	+0, -0,008
8-10	+0, -0,009
12-16	+0, -0,011

High-Performance Taps

Beyond™ Left-Hand Spiral-Flute, Right-Hand Cut HSS-E-PM Taps • Through Holes



- KP6525 TiCN + TiN for tapping steel and cast iron.

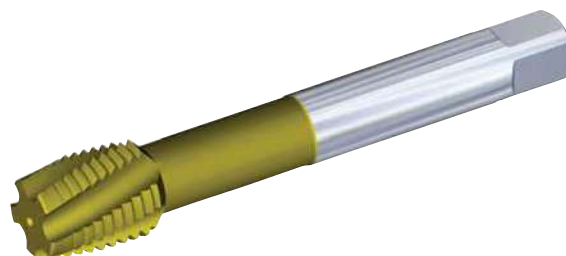
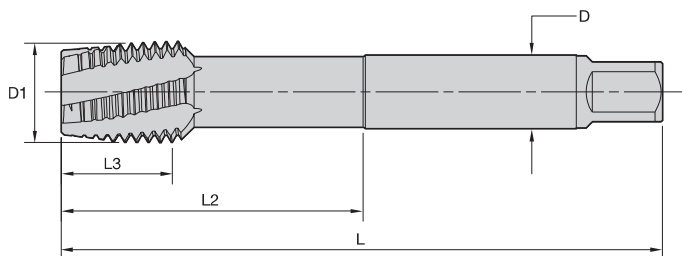

T620 • DIN 376 • Form D Plug Chamfer • Large Sizes • Metric • For Steel and Cast Iron

Tapping

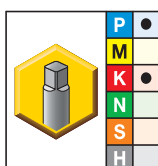

● first choice

○ alternate choice

KP6525	D1 size	L	L3	L2	D	number of flutes	dimension standard	class of fit
T620M240X300R6HX-D6	M24 X 3	160	30	77	18,0	5	DIN 376	6HX
T620M300X350R6HX-D6	M30 X 3,5	180	35	91	22,0	5	DIN 376	6HX
T620M330X350R6HX-D6	M33 X 3,5	180	35	100	25,0	5	DIN 376	6HX
T620M360X400R6HX-D6	M36 X 4	200	40	110	28,0	6	DIN 376	6HX
T620M420X450R6HX-D6	M42 X 4,5	200	45	120	32,0	6	DIN 376	6HX

Shank Tolerance

D	tolerance h6
12-18	+0, -0,011
20-30	+0, -0,013
32-36	+0, -0,016

- KP6525 TiCN + TiN for tapping steel and cast iron.

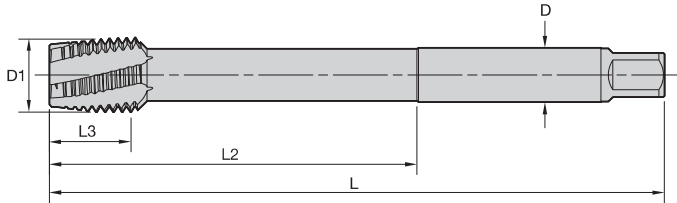

■ T620 • Extra Long • Form D Plug Chamfer • Larger Sizes • Metric • For Steel and Cast Iron

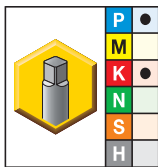

- first choice
- alternate choice

KP6525	D1 size	L	L3	L2	D	number of flutes	class of fit
T620M240X300R6H-XL	M24 X 3	200	30	120	18,0	5	6HX
T620M300X350R6H-XL	M30 X 3,5	250	35	150	22,0	5	6HX
T620M330X350R6H-XL	M33 X 3,5	250	35	150	25,0	5	6HX
T620M360X400R6H-XL	M36 X 4	250	40	150	28,0	6	6HX
T620M420X450R6H-XL	M42 X 4,5	300	45	180	32,0	6	6HX

Shank Tolerance

D	tolerance h6
12-18	+0, -0,011
20-30	+0, -0,013
32-36	+0, -0,016



High-Performance Taps

Beyond™ Left-Hand Spiral-Flute, Right-Hand Cut HSS-E-PM Taps • Through Holes



- KP6525 TiCN + TiN for steel.

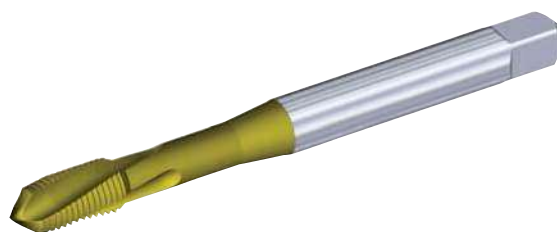
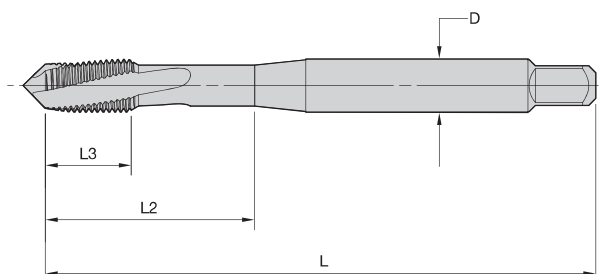

T620 • DIN 371 and 376 • Form D Plug Chamfer • Machine Screw and Fractional • For Steel and Stainless Steel

Tapping

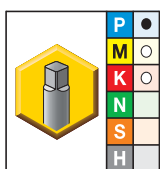

- first choice
- alternate choice

KP6525	D1 size	L	L3	L2	D	number of flutes	dimension standard	class of fit
T620NC#06-32R2BX-D1	6 - 32	56	9	20	4,0	2	DIN 371	2BX
T620NF#06-40R2BX-D1	6 - 40	56	9	20	4,0	2	DIN 371	2BX
T620NC#08-32R2BX-D1	8 - 32	63	10	21	4,5	2	DIN 371	2BX
T620NC#10-24R2BX-D1	10 - 24	70	10	25	6,0	3	DIN 371	2BX
T620NF#10-32R2BX-D1	10 - 32	70	10	25	6,0	3	DIN 371	2BX
T620NC02500-20R3BX-D1	1/4 - 20	80	13	30	7,0	3	DIN 371	3BX
T620NF02500-28R3BX-D1	1/4 - 28	80	13	30	7,0	3	DIN 371	3BX
T620NC03125-18R3BX-D1	5/16 - 18	90	13	35	8,0	3	DIN 371	3BX
T620NF03125-24R3BX-D1	5/16 - 24	90	13	35	8,0	3	DIN 371	3BX
T620NC04375-14R3BX-D6	7/16 - 14	100	15	41	8,0	3	DIN 376	3BX
T620NF04375-20R3BX-D6	7/16 - 20	100	15	41	8,0	3	DIN 376	3BX
T620NC03750-16R3BX-D1	3/8 - 16	100	16	39	10,0	3	DIN 371	3BX
T620NF03750-24R3BX-D1	3/8 - 24	100	16	39	10,0	3	DIN 371	3BX
T620NC05000-13R3BX-D6	1/2 - 13	110	20	47	9,0	3	DIN 376	3BX
T620NF05000-20R3BX-D6	1/2 - 20	110	20	47	9,0	3	DIN 376	3BX

Shank Tolerance

D fractional	tolerance h6
>3-6	+0, -0,008
>6-10	+0, -0,009
<10-18	+0, -0,011

- KP6525 TiCN + TiN for steel.

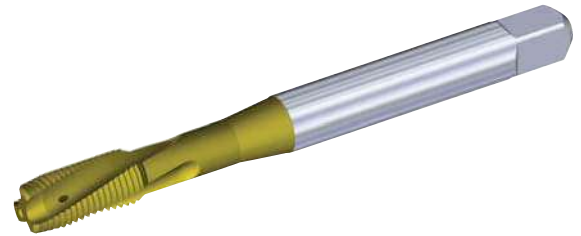
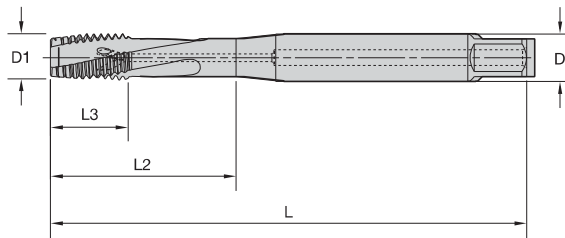

- T621 • DIN 371 and 376 • Form D Plug Chamfer • Through Coolant • Fractional • For Steel and Stainless Steel

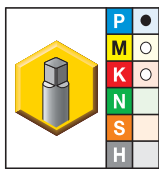

- first choice
- alternate choice

KP6525	D1 size	L	L3	L2	D	number of flutes	dimension standard	class of fit
T621NC02500-20R3BX-D1	1/4 - 20	80	13	30	7,0	3	DIN 371	3BX
T621NF02500-28R3BX-D1	1/4 - 28	80	13	30	7,0	3	DIN 371	3BX
T621NC03125-18R3BX-D1	5/16 - 18	90	13	35	8,0	3	DIN 371	3BX
T621NF03125-24R3BX-D1	5/16 - 24	90	13	35	8,0	3	DIN 371	3BX
T621NC03750-16R3BX-D1	3/8 - 16	100	16	39	10,0	3	DIN 371	3BX
T621NF03750-24R3BX-D1	3/8 - 24	100	16	39	10,0	3	DIN 371	3BX
T621NC04375-14R3BX-D6	7/16 - 14	100	15	41	8,0	3	DIN 376	3BX
T621NF04375-20R3BX-D6	7/16 - 20	100	15	41	8,0	3	DIN 376	3BX
T621NC05000-13R3BX-D6	1/2 - 13	110	20	47	9,0	3	DIN 376	3BX
T621NF05000-20R3BX-D6	1/2 - 20	110	20	47	9,0	3	DIN 376	3BX

Shank Tolerance

D fractional	tolerance h6
>3-6	+0, -0,008
>6-10	+0, -0,009
<10-18	+0, -0,011



- KSN38 DLC for tapping aluminium.

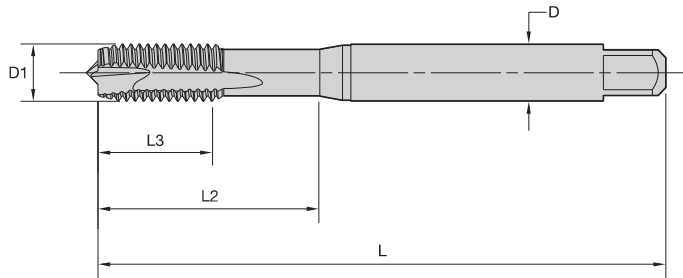

T670 • DIN 371 and 376 • Form B Plug Chamfer • Metric • For Aluminium

Tapping

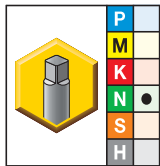

- first choice
- alternate choice

KSN38	D1 size	L	L3	L2	D	number of flutes	dimension standard	class of fit
T670M030X050R6H-D1	M3 X 0,5	56	11	18	3,5	2	DIN 371	6H
T670M040X070R6H-D1	M4 X 0,7	63	13	21	4,5	2	DIN 371	6H
T670M050X080R6H-D1	M5 X 0,8	70	15	25	6,0	2	DIN 371	6H
T670M060X100R6H-D1	M6 X 1	80	17	30	6,0	2	DIN 371	6H
T670M080X125R6H-D1 *	M8 X 1,25	90	20	35	8,0	2	DIN 371	6H
T670M100X150R6H-D1	M10 X 1,5	100	22	39	10,0	2	DIN 371	6H
T670M120X175R6H-D6	M12 X 1,75	110	24	—	9,0	3	DIN 376	6H
T670M160X200R6H-D6	M16 X 2	110	27	—	12,0	3	DIN 376	6H

NOTE: *Made-to-order standard item. Standard pricing, manufacturing lead time, and minimum order quantity applies.

Shank Tolerance

D	tolerance h9
1-3	+0, -0,025
3,5-6	+0, -0,030
7-10	+0, -0,036
11-18	+0, -0,043

- KSP21 TiN for tapping steel 32–44 HRC.

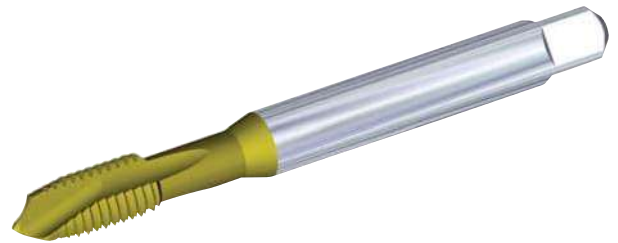
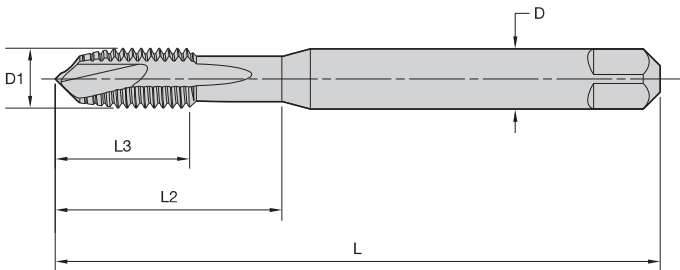

■ T600 • DIN 371, 374, and 376 • Form B Plug Chamfer • Metric • For Hard Steel

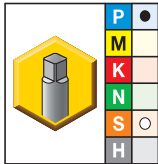

- first choice
- alternate choice

KSP21	D1 size	L	L3	L2	D	number of flutes	dimension standard	class of fit
T600M030X050R6HX-D1	M3 X 0,5	56	11	18	3,5	2	DIN 371	6HX
T600M040X070R6HX-D1	M4 X 0,7	63	13	21	4,5	2	DIN 371	6HX
T600M050X080R6HX-D1	M5 X 0,8	70	15	25	6,0	2	DIN 371	6HX
T600M060X100R6HX-D1	M6 X 1	80	17	30	6,0	3	DIN 371	6HX
T600MF080X100R6HX-D4	M8 X 1	90	17	—	6,0	3	DIN 374	6HX
T600M080X125R6HX-D1	M8 X 1,25	90	20	35	8,0	3	DIN 371	6HX
T600MF100X100R6HX-D4	M10 X 1	90	18	—	7,0	3	DIN 374	6HX
T600MF100X125R6HX-D4	M10 X 1,25	100	22	—	7,0	3	DIN 374	6HX
T600M100X150R6HX-D1	M10 X 1,5	100	22	39	10,0	3	DIN 371	6HX
T600MF120X125R6HX-D4	M12 X 1,25	100	22	—	9,0	3	DIN 374	6HX
T600MF120X150R6HX-D4	M12 X 1,5	100	22	—	9,0	3	DIN 374	6HX
T600M120X175R6HX-D6	M12 X 1,75	110	24	—	9,0	3	DIN 376	6HX
T600MF140X150R6HX-D4	M14 X 1,5	100	22	—	11,0	3	DIN 374	6HX
T600M140X200R6HX-D6	M14 X 2	110	26	—	11,0	3	DIN 376	6HX
T600MF160X150R6HX-D4	M16 X 1,5	100	22	—	12,0	4	DIN 374	6HX
T600M160X200R6HX-D6	M16 X 2	110	27	—	12,0	4	DIN 376	6HX
T600M180X250R6HX-D6	M18 X 2	125	30	—	14,0	4	DIN 376	6HX
T600M200X250R6HX-D6	M20 X 2,5	140	32	—	16,0	4	DIN 376	6HX

Shank Tolerance

D	tolerance h9
1–3	+0, -0,025
3,5–6	+0, -0,030
7–10	+0, -0,036
11–18	+0, -0,043

Multipurpose Taps

G0tap™ T820 Spiral-Point HSS-E Taps • Through Holes



- KSP32 TiCN/TiN
- KSP39 oxide

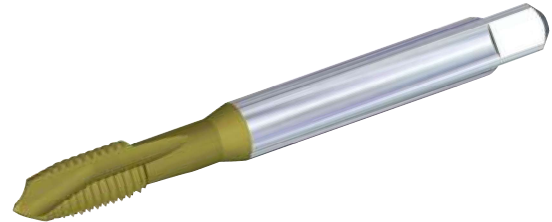
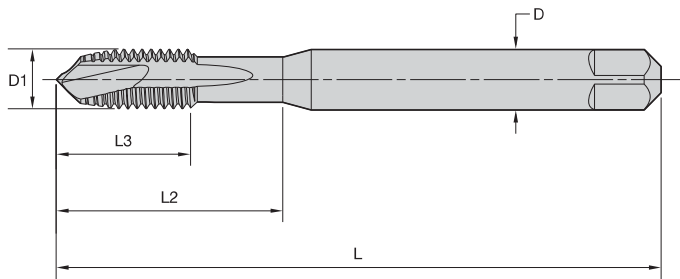

T820 • DIN 371, 374, and 376 • Form B Plug Chamfer • Metric

Tapping

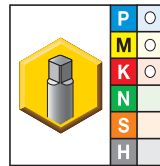
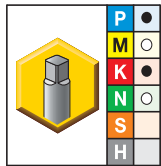

- first choice
- alternate choice

KSP32	KSP39	D1 size	L	L3	L2	D	number of flutes	dimension standard	class of fit
T820M020X040R6H-D1	T820M020X040R6H-D1	M2 X 0,4	45	7	13	2,8	2	DIN 371	6H
—	T820M020X040R6G-D1	M2 X 0,4	45	7	13	2,8	2	DIN 371	6G
—	T820M025X045R6H-D1	M2,5 X 0,45	50	7	15	2,8	2	DIN 371	6H
—	T820M025X045R6G-D1	M2,5 X 0,45	50	7	15	2,8	2	DIN 371	6G
T820M030X050R6H-D1	T820M030X050R6H-D1	M3 X 0,5	56	8	18	3,5	2	DIN 371	6H
—	T820M030X050R6G-D1	M3 X 0,5	56	8	18	3,5	2	DIN 371	6G
—	T820M035X060R6H-D1	M3,5 X 0,6	56	9	20	4,0	2	DIN 371	6H
—	T820MF040X050R6H-D4	M4 X 0,5	63	10	21	2,8	2	DIN 374	6H
T820M040X070R6H-D1	T820M040X070R6H-D1	M4 X 0,7	63	11	21	4,5	2	DIN 371	6H
—	T820M040X070R6G-D1	M4 X 0,7	63	11	21	4,5	2	DIN 371	6G
—	T820MF050X050R6H-D4	M5 X 0,5	70	12	25	3,5	2	DIN 374	6H
T820M050X080R6H-D1	T820M050X080R6H-D1	M5 X 0,8	70	12	25	6,0	2	DIN 371	6H
—	T820M050X080R6G-D1	M5 X 0,8	70	12	25	6,0	2	DIN 371	6G
—	T820MF060X050R6H-D4	M6 X 0,5	80	12	30	4,5	3	DIN 374	6H
—	T820MF060X075R6H-D4	M6 X 0,75	80	12	30	4,5	3	DIN 374	6H
—	T820M060X100R6H-D6	M6 X 1	80	12	30	4,5	3	DIN 376	6H
T820M060X100R6H-D1	T820M060X100R6H-D1	M6 X 1	80	12	30	6,0	3	DIN 371	6H
—	T820M060X100R6G-D1	M6 X 1	80	12	30	6,0	3	DIN 371	6G
T820M070X100R6H-D1	T820M070X100R6H-D1	M7 X 1	80	12	30	7,0	3	DIN 371	6H
—	T820M070X100R6G-D1	M7 X 1	80	12	30	7,0	3	DIN 371	6G
—	T820MF080X100R6H-D4	M8 X 1	90	15	35	6,0	3	DIN 374	6H
—	T820M080X125R6H-D6	M8 X 1,25	90	15	35	6,0	3	DIN 376	6H
T820M080X125R6H-D1	T820M080X125R6H-D1	M8 X 1,25	90	15	35	8,0	3	DIN 371	6H
—	T820M080X125R6G-D1	M8 X 1,25	90	15	35	8,0	3	DIN 371	6G
—	T820MF100X100R6H-D4	M10 X 1	90	15	35	7,0	3	DIN 374	6H
—	T820MF100X125R6H-D4	M10 X 1,25	100	18	39	7,0	3	DIN 374	6H
—	T820M100X150R6H-D6	M10 X 1,5	100	18	39	7,0	3	DIN 376	6H
T820M100X150R6H-D1	T820M100X150R6H-D1	M10 X 1,5	100	18	39	10,0	3	DIN 371	6H
—	T820M100X150R6G-D1	M10 X 1,5	100	18	39	10,0	3	DIN 371	6G
—	T820MF120X100R6H-D4	M12 X 1	100	21	39	9,0	3	DIN 374	6H
—	T820MF120X125R6H-D4	M12 X 1,25	100	21	39	9,0	3	DIN 374	6H
—	T820MF120X150R6H-D4	M12 X 1,5	100	21	39	9,0	3	DIN 374	6H

(continued)

(T820 • DIN 371, 374, and 376 • Form B Plug Chamfer • Metric — continued)

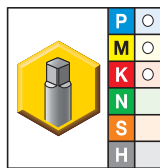
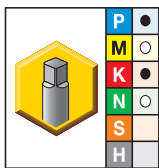

● first choice
○ alternate choice

		D1 size	L	L3	L2	D	number of flutes	dimension standard	class of fit
KSP32	KSP39								
T820M120X175R6H-D6	T820M120X175R6H-D6	M12 X 1,75	110	21	44	9,0	3	DIN 376	6H
—	T820M120X175R6G-D6	M12 X 1,75	110	21	44	9,0	3	DIN 376	6G
—	T820MF140X100R6H-D4	M14 X 1	100	21	47	11,0	3	DIN 374	6H
—	T820MF140X125R6H-D4	M14 X 1,25	100	21	47	11,0	3	DIN 374	6H
—	T820MF140X150R6H-D4	M14 X 1,5	100	21	47	11,0	3	DIN 374	6H
T820M140X200R6H-D6	T820M140X200R6H-D6	M14 X 2	110	24	52	11,0	3	DIN 376	6H
—	T820M140X200R6G-D6	M14 X 2	110	24	52	11,0	3	DIN 376	6G
—	T820MF160X100R6H-D4	M16 X 1	100	21	46	12,0	3	DIN 374	6H
—	T820MF160X150R6H-D4	M16 X 1,5	100	21	46	12,0	3	DIN 374	6H
T820M160X200R6H-D6	T820M160X200R6H-D6	M16 X 2	110	24	51	12,0	3	DIN 376	6H
—	T820M160X200R6G-D6	M16 X 2	110	24	51	12,0	3	DIN 376	6G
—	T820MF180X150R6H-D4	M18 X 1,5	110	21	50	14,0	3	DIN 374	6H
—	T820MF180X200R6H-D4	M18 X 2	125	30	58	14,0	3	DIN 374	6H
T820M180X250R6H-D6	T820M180X250R6H-D6	M18 X 2,5	125	30	58	14,0	3	DIN 376	6H
—	T820MF200X150R6H-D4	M20 X 1,5	125	24	56	16,0	3	DIN 374	6H
—	T820MF200X200R6H-D4	M20 X 2	140	30	64	16,0	3	DIN 374	6H
T820M200X250R6H-D6	T820M200X250R6H-D6	M20 X 2,5	140	30	64	16,0	3	DIN 376	6H
—	T820MF220X150R6H-D4	M22 X 1,5	125	24	62	18,0	3	DIN 374	6H
—	T820MF220X200R6H-D4	M22 X 2	140	30	70	18,0	3	DIN 374	6H
—	T820M220X250R6H-D6	M22 X 2,5	140	30	70	18,0	3	DIN 376	6H
—	T820MF240X150R6H-D4	M24 X 1,5	140	28	67	18,0	3	DIN 374	6H
—	T820M240X300R6H-D6	M24 X 3	160	36	77	18,0	3	DIN 376	6H
—	T820M270X300R6H-D6	M27 X 3	160	36	82	20,0	4	DIN 376	6H
—	T820M300X350R6H-D6	M30 X 3,5	180	42	91	22,0	4	DIN 376	6H
—	T820M330X350R6H-D6	M33 X 3,5	180	42	100	25,0	4	DIN 376	6H
—	T820M360X400R6H-D6	M36 X 4	200	48	110	28,0	4	DIN 376	6H



Shank Tolerance

D mm	tolerance h9
1-3	+0, -0,025
>3-6	+0, -0,030
>6-10	+0, -0,036
>10-18	+0, -0,043
>18-30	+0, -0,052

Multipurpose Taps

G0tap™ T820 Spiral-Point HSS-E Taps • Through Holes



• KSP39 oxide

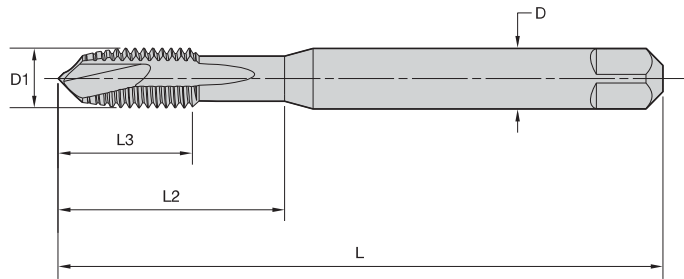

T820 • DIN 371 and 376 • Form B Plug Chamfer • UNC/UNF

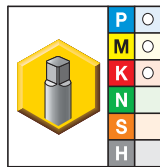

● first choice
○ alternate choice

Tapping

KSP39	metric dimensions					number of flutes	dimension standard	class of fit
	D1 size	L	L3	L2	D			
T820NC#04-40R2B-D1	4 - 40	56	8	18	3,5	2	DIN 371	2B
T820NC#05-40R2B-D1	5 - 40	56	9	20	4,0	2	DIN 371	2B
T820NC#06-32R2B-D1	6 - 32	56	9	20	4,0	2	DIN 371	2B
T820NF#06-40R2B-D1	6 - 40	56	9	20	4,0	2	DIN 371	2B
T820NC#08-32R2B-D1	8 - 32	63	11	21	4,5	2	DIN 371	2B
T820NC#10-24R2B-D1	10 - 24	70	12	25	6,0	2	DIN 371	2B
T820NF#10-32R2B-D1	10 - 32	70	12	25	6,0	2	DIN 371	2B
T820NC02500-20R2B-D1	1/4 - 20	80	15	30	7,0	3	DIN 371	2B
T820NF02500-28R2B-D1	1/4 - 28	80	15	30	7,0	3	DIN 371	2B
T820NC03125-18R2B-D1	5/16 - 18	90	15	35	8,0	3	DIN 371	2B
T820NF03125-24R2B-D1	5/16 - 24	90	15	35	8,0	3	DIN 371	2B
T820NC03750-16R2B-D1	3/8 - 16	100	19	39	10,0	3	DIN 371	2B
T820NF03750-24R2B-D1	3/8 - 24	100	19	39	10,0	3	DIN 371	2B
T820NC04375-14R2B-D6	7/16 - 14	100	18	41	8,0	3	DIN 376	2B
T820NF04375-20R2B-D6	7/16 - 20	100	18	41	8,0	3	DIN 376	2B
T820NC05000-13R2B-D6	1/2 - 13	110	23	47	9,0	3	DIN 376	2B
T820NF05000-20R2B-D6	1/2 - 20	110	23	47	9,0	3	DIN 376	2B
T820NC05625-12R2B-D6	9/16 - 12	110	25	53	11,0	3	DIN 376	2B
T820NF05625-18R2B-D6	9/16 - 18	110	25	53	11,0	3	DIN 376	2B
T820NC06250-11R2B-D6	5/8 - 11	110	24	51	12,0	3	DIN 376	2B
T820NF06250-18R2B-D6	5/8 - 18	110	24	51	12,0	3	DIN 376	2B
T820NC07500-10R2B-D6	3/4 - 10	140	30	64	16,0	3	DIN 376	2B
T820NF07500-16R2B-D6	3/4 - 16	140	30	64	16,0	3	DIN 376	2B
T820NC08750-9R2B-D6	7/8 - 9	140	34	71	18,0	3	DIN 376	2B
T820NF08750-14R2B-D6	7/8 - 14	140	34	71	18,0	3	DIN 376	2B
T820NC10000-8R2B-D6	1 - 8	160	38	81	18,0	3	DIN 376	2B
T820NF10000-12R2B-D6	1 - 12	160	38	81	18,0	3	DIN 376	2B

Shank Tolerance

D mm	tolerance h9
1-3	+0, -0,025
>3-6	+0, -0,030
>6-10	+0, -0,036
>10-18	+0, -0,043
>18-30	+0, -0,052

• KSP39 oxide

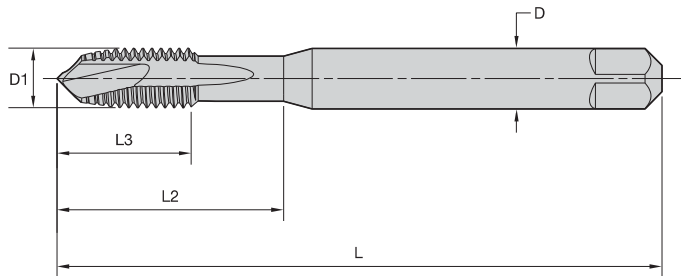

■ T820 • DIN 371 and 376 • Form B Plug Chamfer • UNJC/UNJF

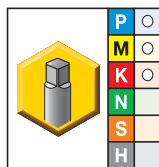

● first choice
○ alternate choice

KSP39	metric dimensions					number of flutes	dimension standard	class of fit
	D1 size	L	L3	L2	D			
T820NC#04-40R3B-D1	4 - 40	56	8	18	3,5	2	DIN 371	3B
T820NC#06-32R3B-D1	6 - 32	56	9	20	4,0	2	DIN 371	3B
T820NC#08-32R3B-D1	8 - 32	63	11	21	4,5	2	DIN 371	3B
T820NF#10-32R3B-D1	10 - 32	70	12	25	6,0	2	DIN 371	3B
T820NF02500-28R3B-D1	1/4 - 28	80	15	30	7,0	3	DIN 371	3B
T820NF03125-24R3B-D1	5/16 - 24	90	15	35	8,0	3	DIN 371	3B
T820NF03750-24R3B-D1	3/8 - 24	100	19	39	10,0	3	DIN 371	3B
T820NF04375-20R3B-D6	7/16 - 20	100	18	41	8,0	3	DIN 376	3B
T820NF05000-20R3B-D6	1/2 - 20	110	23	47	9,0	3	DIN 376	3B

NOTE: Internal UNJC/UNJF threads may be produced with ground thread UNC/UNF taps.

Shank Tolerance

D mm	tolerance h9
1-3	+0, -0,025
>3-6	+0, -0,030
>6-10	+0, -0,036
>10-18	+0, -0,043
>18-30	+0, -0,052



Multipurpose Taps

G0tap™ T820 Spiral-Point HSS-E Taps • Through Holes



- KSU31 TiN
- KSU30 bright

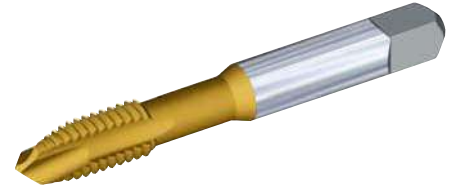
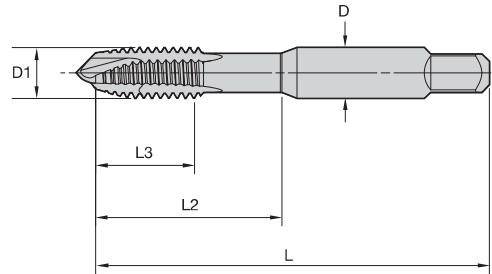

T820 • Form B Plug Chamfer • Metric • JIS

Tapping

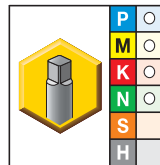
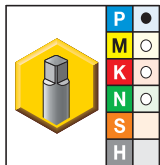

- first choice
- alternate choice

KSU31	KSU30	D1 size	L	L3	L2	D	number of flutes	dimension standard	tap class
T820M030X050R6H-J	T820M030X050R6H-J	M3 X 0,5	46	11	19	4,0	2	JIS	ISO 2
T820M040X070R6H-J	T820M040X070R6H-J	M4 X 0,7	52	13	21	5,0	2	JIS	ISO 2
T820M050X080R6H-J	T820M050X080R6H-J	M5 X 0,8	60	16	24	5,5	2	JIS	ISO 2
T820M060X100R6H-J	T820M060X100R6H-J	M6 X 1	62	19	29	6,0	3	JIS	ISO 2
T820M080X125R6H-J	T820M080X125R6H-J	M8 X 1,25	70	22	37	6,2	3	JIS	ISO 2
T820M100X150R6H-J	T820M100X150R6H-J	M10 X 1,5	75	24	41	7,0	3	JIS	ISO 2
—	T820MF120X125R6H-J	M12 X 1,25	82	29	48	8,5	3	JIS	ISO 2
—	T820MF120X150R6H-J	M12 X 1,5	82	29	48	8,5	3	JIS	ISO 2
—	T820M120X175R6H-J	M12 X 1,75	82	29	48	8,5	3	JIS	ISO 2
—	T820MF140X150R6H-J	M14 X 1,5	88	30	48	10,5	3	JIS	ISO 2
—	T820M140X200R6H-J	M14 X 2	88	30	48	10,5	3	JIS	ISO 2
—	T820MF160X150R6H-J	M16 X 1,5	95	32	52	12,5	3	JIS	ISO 2
—	T820M160X200R6H-J	M16 X 2	95	32	52	12,5	3	JIS	ISO 2
—	T820M180X250R6H-J	M18 X 2,5	100	37	55	14,0	3	JIS	ISO 2
—	T820M200X250R6H-J	M20 X 2,5	105	37	60	15,0	3	JIS	ISO 2

Shank Tolerance

D mm	tolerance h9
1-3	+0, -0,025
>3-6	+0, -0,030
>6-10	+0, -0,036
>10-18	+0, -0,043
>18-30	+0, -0,052

NOVO KNOWS SEARCH

Searching for a tool has been enhanced by Advise and Select functions from NOVO™ applications — saving you time and money.

ADVISE

Uses a rules-based approach to provide cutting tool recommendations:

- Define Machining Feature (face milling, slotting, blind hole, etc.)
- Apply Constraint Requirements (geometric, material, tolerance, etc.)
- Set Machining Sequence (single or multi-step operations, rough then finish, etc.)
- Receive Ranked Results

SELECT

A method of selecting cutting tools from a tree structure via a hierarchy or parametric search:

- If you know which product you are looking for, a quick search can be performed by just the catalogue number or product description.
- Smart filters significantly reduce the amount of potential tooling solutions.
- After the tool is selected, NOVO also provides cutting and adaptive item options that fit with your solution.

NOVO applications can ensure you have the right tools on your machines, in the right sequence. Resulting in flawless execution that accelerates every job, and maximises every shift. kennametal.com/novo

➤ Spiral-Flute Taps



High-Performance Taps for Blind-Hole Applications

- Steel and steel alloys.
- Stainless steel.
- Cast iron.
- Nickel- and cobalt-based alloys.
- Titanium and titanium alloys.
- Aluminium.
- Hard steel.

High-Performance Beyond™ Solid Carbide Taps

- Right-hand spiral flute with through coolant for efficient chip evacuation at high spindle speeds.
- Runs up to 4x faster and 4x longer than conventional high-speed steel (HSS) taps.
- Ideal for long production runs where fewer tool changes result in greater productivity.
- For use on CNC machines with synchronous or rigid controls and precision toolholders.

High-Performance Beyond™ HSS-E-PM Taps

- Right-hand spiral flutes with the flute form and helix angle optimised for material-specific applications.
- Higher strength and wider range of applications versus solid carbide taps.
- Higher tapping speed capability and longer tool life than conventional HSS-E taps.
- Can be used on either conventional or synchronous tapping machines with rigid or synchronous tap holders.



Multipurpose HSS-E GOtap™ Taps

- Advanced spiral-flute geometry designed for free cutting action and efficient chip evacuation in blind holes.
- Manufactured with high vanadium HSS-E material for exceptional wear characteristics and longer tool life.
- Advanced PVD coatings to reduce tapping torque, resulting in high-quality thread finish and longer tool life.
- For use in both synchronous and non-synchronous machines, including rigid, synchronous, and tension/compression tap holders.

High-Performance Taps

Beyond™ Solid Carbide Spiral-Flute Taps • Blind Holes



- KC7542 TiAlN + TiN for steel.

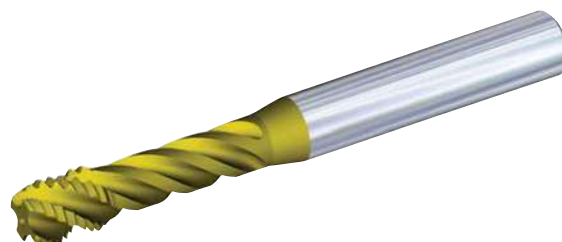
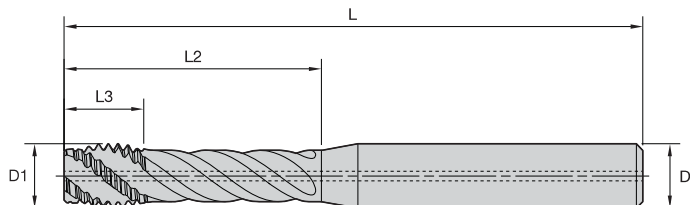

■ T331 • Form C Semi-Bottoming Chamfer • Through Coolant • Inch • Solid Carbide • For Steel

Tapping

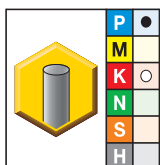

- first choice
- alternate choice

KC7542	D1 size	L	L3	L2	D	number of flutes	class of fit
T331NC2500-20R3BX	1/4 - 20	2.76	.39	.94	.250	3	3BX
T331NF2500-28R3BX	1/4 - 28	2.76	.39	.94	.250	3	3BX
T331NC3125-18R3BX	5/16 - 18	3.15	.47	1.26	.313	3	3BX
T331NC3750-16R3BX	3/8 - 16	3.54	.51	1.57	.375	4	3BX
T331NC4375-14R3BX	7/16 - 14	3.94	.59	1.73	.438	4	3BX
T331NC5000-13R3BX *	1/2 - 13	3.94	.63	1.89	.500	4	3BX

NOTE: *Made-to-order standard item. Standard pricing, manufacturing lead time, and minimum order quantity applies.

Shank Tolerance

D	tolerance h6
.250-.375	+0, -.0004
.438-.625	+0, -.0004

- KC7542 TiAlN + TiN for steel.

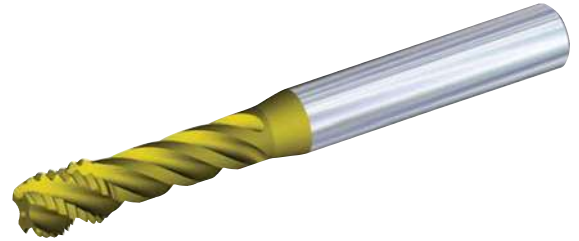
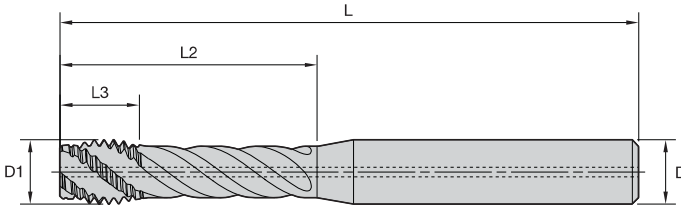

- T331 • Form C Semi-Bottoming Chamfer • Through Coolant • Metric • Solid Carbide • For Steel

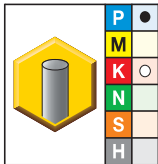

- first choice
- alternate choice

KC7542	D1 size	L	L3	L2	D	number of flutes	class of fit
T331M060X100R6HX	M6 X 1	70	8	24	6,0	3	6HX
T331M080X125R6HX	M8 X 1,25	80	10	32	8,0	3	6HX
T331M100X150R6HX	M10 X 1,5	90	12	40	10,0	4	6HX
T331MF120X150R6HX	M12 X 1,5	100	14	48	12,0	4	6HX
T331M120X175R6HX	M12 X 1,75	100	14	48	12,0	4	6HX
T331MF140X150R6HX	M14 X 1,5	110	16	56	12,0	4	6HX
T331M140X200R6HX	M14 X 2	110	16	56	12,0	4	6HX
T331M160X200R6HX	M16 X 2	110	16	64	14,0	4	6HX

NOTE: Proprietary technology.

Shank Tolerance

D	tolerance h6
6	+0, -0,008
8-10	+0, -0,009
12-16	+0, -0,011



High-Performance Taps

Beyond™ Spiral-Flute HSS-E-PM Taps • Blind Holes



- KM6515 TiN + CrC/C for stainless steel.
- KP6525 TiCN + TiN for steel.

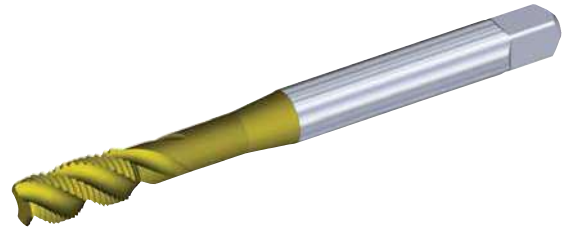
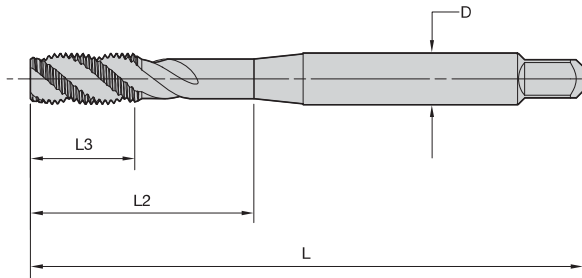
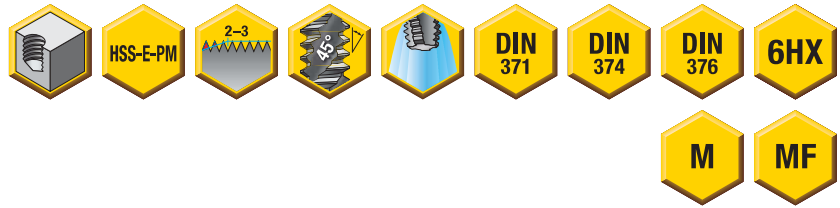

■ T630 • DIN 371, 374, and 376 • Form C Semi-Bottoming Chamfer • Metric • For Steel and Stainless Steel • Rigid and Synchronous Holders

Tapping

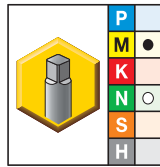
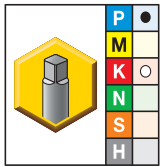

- first choice
- alternate choice

KP6525	KM6515	D1 size	L	L3	L2	D	number of flutes	dimension standard	class of fit
T630M030X050R6HX-D1	T630M030X050R6HX-D1	M3 X 0,5	56	8	18	3,5	3	DIN 371	6HX
T630M040X070R6HX-D1	T630M040X070R6HX-D1	M4 X 0,7	63	10	21	4,5	3	DIN 371	6HX
T630M050X080R6HX-D1	T630M050X080R6HX-D1	M5 X 0,8	70	10	25	6,0	3	DIN 371	6HX
T630M060X100R6HX-D1	T630M060X100R6HX-D1	M6 X 1	80	10	30	6,0	3	DIN 371	6HX
T630MF080X100R6HX-D4	T630MF080X100R6HX-D4	M8 X 1	90	13	35	6,0	3	DIN 374	6HX
T630M080X125R6HX-D1	T630M080X125R6HX-D1	M8 X 1,25	90	13	35	8,0	3	DIN 371	6HX
T630MF100X100R6HX-D4	T630MF100X100R6HX-D4	M10 X 1	90	10	35	7,0	3	DIN 374	6HX
T630MF100X125R6HX-D4	T630MF100X125R6HX-D4	M10 X 1,25	100	15	39	7,0	3	DIN 374	6HX
T630M100X150R6HX-D1	T630M100X150R6HX-D1	M10 X 1,5	100	15	39	10,0	3	DIN 371	6HX
T630MF120X150R6HX-D4	T630MF120X150R6HX-D4	M12 X 1,5	100	15	39	9,0	4	DIN 374	6HX
T630M120X175R6HX-D6	T630M120X175R6HX-D6	M12 X 1,75	110	18	44	9,0	4	DIN 376	6HX
T630MF140X150R6HX-D4	T630MF140X150R6HX-D4	M14 X 1,5	100	15	47	11,0	4	DIN 374	6HX
T630M140X200R6HX-D6	T630M140X200R6HX-D6	M14 X 2	110	20	52	11,0	4	DIN 376	6HX
T630MF160X150R6HX-D4	T630MF160X150R6HX-D4	M16 X 1,5	100	15	46	12,0	4	DIN 374	6HX
T630M160X200R6HX-D6	T630M160X200R6HX-D6	M16 X 2	110	20	51	12,0	4	DIN 376	6HX
T630MF180X150R6HX-D4	T630MF180X150R6HX-D4	M18 X 1,5	110	15	50	14,0	4	DIN 374	6HX
T630M180X250R6HX-D6	T630M180X250R6HX-D6	M18 X 2,5	125	25	58	14,0	4	DIN 376	6HX

NOTE: Suggested for use in rigid and synchronous holders.

Shank Tolerance

D	tolerance h6
6	+0, -0,008
8-10	+0, -0,009
12-16	+0, -0,011

- KM6515 TiN + CrC/C for stainless steel.
- KP6525 TiCN + TiN for steel.

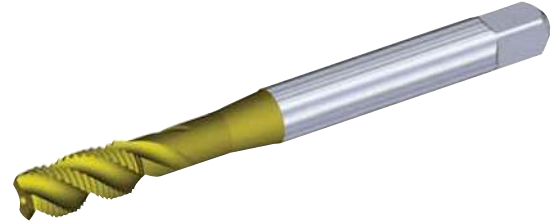
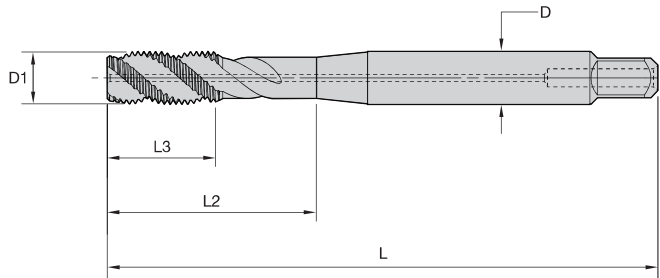
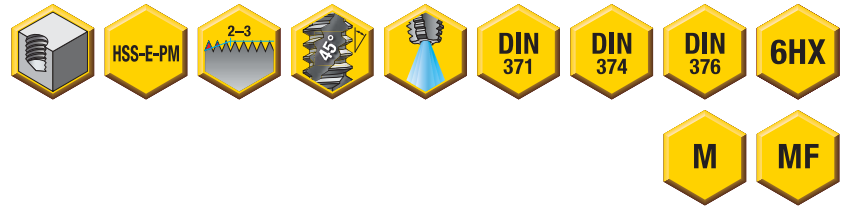

■ T631 • DIN 371, 374, and 376 • Form C Semi-Bottoming Chamfer • Through Coolant • Metric • For Steel and Stainless Steel • Rigid and Synchronous Holders

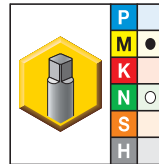
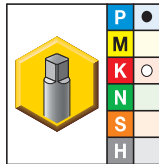

- first choice
- alternate choice

KP6525	KM6515	D1 size	L	L3	L2	D	number of flutes	dimension standard	class of fit
T631M050X080R6HX-D1	T631M050X080R6HX-D1	M5 X 0,8	70	10	25	6,0	3	DIN 371	6HX
T631M060X100R6HX-D1	T631M060X100R6HX-D1	M6 X 1	80	10	30	6,0	3	DIN 371	6HX
T631MF080X100R6HX-D4	T631MF080X100R6HX-D4	M8 X 1	90	13	35	6,0	3	DIN 374	6HX
T631M080X125R6HX-D1	T631M080X125R6HX-D1	M8 X 1,25	90	13	35	8,0	3	DIN 371	6HX
T631MF100X100R6HX-D4	T631MF100X100R6HX-D4	M10 X 1	90	10	35	7,0	3	DIN 374	6HX
T631MF100X125R6HX-D4	T631MF100X125R6HX-D4	M10 X 1,25	100	15	39	7,0	3	DIN 374	6HX
T631M100X150R6HX-D1	T631M100X150R6HX-D1	M10 X 1,5	100	15	39	10,0	3	DIN 371	6HX
T631MF120X125R6HX-D4	T631MF120X125R6HX-D4	M12 X 1,25	100	15	39	9,0	4	DIN 374	6HX
T631MF120X150R6HX-D4	T631MF120X150R6HX-D4	M12 X 1,5	100	15	39	9,0	4	DIN 374	6HX
T631M120X175R6HX-D6	T631M120X175R6HX-D6	M12 X 1,75	110	18	44	9,0	4	DIN 376	6HX
T631MF140X125R6HX-D4	T631MF140X125R6HX-D4	M14 X 1,25	100	15	47	11,0	4	DIN 374	6HX
T631MF140X150R6HX-D4	T631MF140X150R6HX-D4	M14 X 1,5	100	15	47	11,0	4	DIN 374	6HX
T631M140X200R6HX-D6	T631M140X200R6HX-D6	M14 X 2	110	20	52	11,0	4	DIN 376	6HX
T631MF160X150R6HX-D4	T631MF160X150R6HX-D4	M16 X 1,5	100	15	46	12,0	4	DIN 374	6HX
T631M160X200R6HX-D6	T631M160X200R6HX-D6	M16 X 2	110	20	51	12,0	4	DIN 376	6HX
T631MF180X150R6HX-D4	T631MF180X150R6HX-D4	M18 X 1,5	110	15	50	14,0	4	DIN 374	6HX
T631M180X250R6HX-D6	T631M180X250R6HX-D6	M18 X 2,5	125	25	58	14,0	4	DIN 376	6HX

NOTE: Suggested for use in rigid and synchronous holders.

Shank Tolerance

D	tolerance h6
6	+0, -0,008
8-10	+0, -0,009
12-16	+0, -0,011

- KP6525 TiCN + TiN for tapping steel.

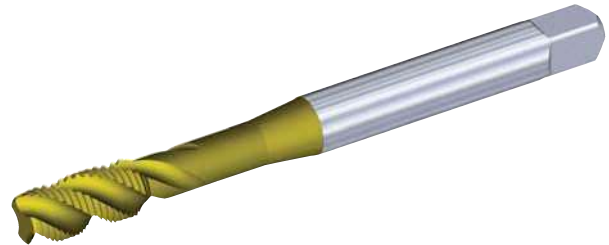
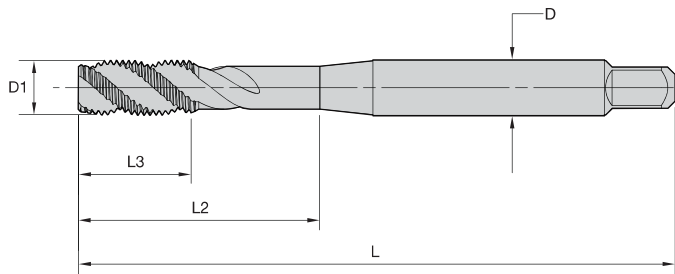

T632 • DIN 371, 374, and 376 • Form E Bottoming Chamfer • Metric • For Steel • Rigid and Synchronous Holders

Tapping

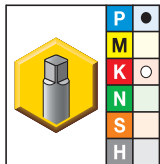

● first choice

○ alternate choice

KP6525	D1 size	L	L3	L2	D	number of flutes	dimension standard	class of fit
T632M050X080R6HX-D1	M5 X 0,8	70	10	25	6,0	3	DIN 371	6HX
T632M060X100R6HX-D1	M6 X 1	80	10	30	6,0	3	DIN 371	6HX
T632M080X125R6HX-D1	M8 X 1,25	90	13	35	8,0	3	DIN 371	6HX
T632M100X150R6HX-D1	M10 X 1,5	100	15	39	10,0	3	DIN 371	6HX
T632MF120X150R6HX-D4	M12 X 1,5	100	15	39	9,0	4	DIN 374	6HX
T632M120X175R6HX-D6	M12 X 1,75	110	18	44	9,0	4	DIN 376	6HX
T632MF140X150R6HX-D4	M14 X 1,5	100	15	47	11,0	4	DIN 374	6HX
T632M140X200R6HX-D6	M14 X 2	110	20	52	11,0	4	DIN 376	6HX
T632MF160X150R6HX-D4	M16 X 1,5	100	15	46	12,0	4	DIN 374	6HX

NOTE: Suggested for use in rigid and synchronous holders.

Shank Tolerance

D	tolerance h6
6	+0, -0,008
8-10	+0, -0,009
12-16	+0, -0,011

- KP6525 TiCN + TiN for tapping steel.

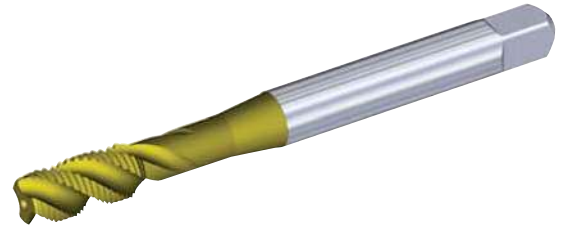
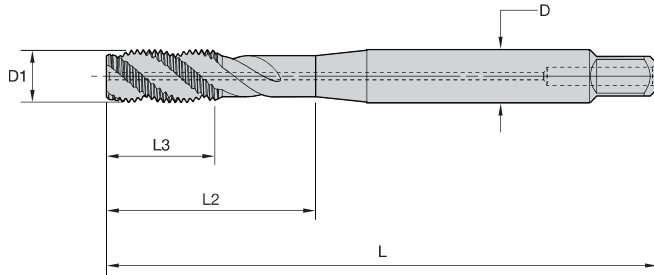

T633 • DIN 371, 374, and 376 • Form E Bottoming Chamfer • Through Coolant • Metric • For Steel • Rigid and Synchronous Holders

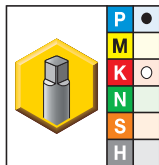

- first choice
- alternate choice

Material	D1 size	L	L3	L2	D	number of flutes	dimension standard	class of fit
KP6525								
T633M050X080R6HX-D1	M5 X 0,8	70	10	25	6,0	3	DIN 371	6HX
T633M060X100R6HX-D1	M6 X 1	80	10	30	6,0	3	DIN 371	6HX
T633M080X125R6HX-D1	M8 X 1,25	90	13	35	8,0	3	DIN 371	6HX
T633M100X150R6HX-D1	M10 X 1,5	100	15	39	10,0	3	DIN 371	6HX
T633MF120X150R6HX-D4	M12 X 1,5	100	15	39	9,0	4	DIN 374	6HX
T633M120X175R6HX-D6	M12 X 1,75	110	18	44	9,0	4	DIN 376	6HX
T633MF140X150R6HX-D4	M14 X 1,5	100	15	47	11,0	4	DIN 374	6HX
T633M140X200R6HX-D6	M14 X 2	110	20	52	11,0	4	DIN 376	6HX
T633MF160X150R6HX-D4	M16 X 1,5	100	15	46	12,0	4	DIN 374	6HX

NOTE: Suggested for use in rigid and synchronous holders.

D	tolerance h6
6	+0, -0,008
8-10	+0, -0,009
12-16	+0, -0,011

Tapping

- KP6525 TiCN + TiN for tapping steel and cast iron.

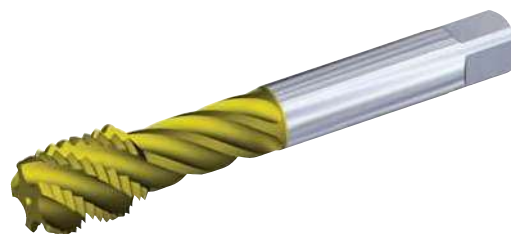
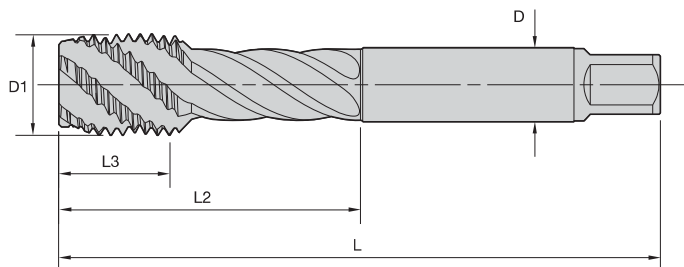

T630 • DIN 376 • Form C Semi-Bottoming Chamfer • Larger Sizes • Metric • For Steel and Cast Iron • Rigid and Synchronous Holders

Tapping

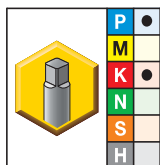

● first choice

○ alternate choice

KP6525	D1 size	L	L3	L2	D	number of flutes	dimension standard	class of fit
T630M240X300R6HX-D6	M24 X 3	160	30	77	18,0	5	DIN 376	6HX
T630M300X350R6HX-D6	M30 X 3,5	180	35	91	22,0	5	DIN 376	6HX
T630M330X350R6HX-D6	M33 X 3,5	180	35	100	25,0	5	DIN 376	6HX
T630M360X400R6HX-D6	M36 X 4	200	40	110	28,0	5	DIN 376	6HX
T630M420X450R6HX-D6	M42 X 4,5	200	45	120	32,0	5	DIN 376	6HX

NOTE: Suggested for use in rigid and synchronous holders.

Shank Tolerance

D	tolerance h6
12-18	+0, -0,011
20-30	+0, -0,013
32-36	+0, -0,016

- KP6525 TiCN + TiN for tapping steel and cast iron.

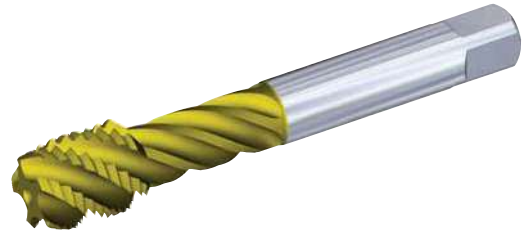
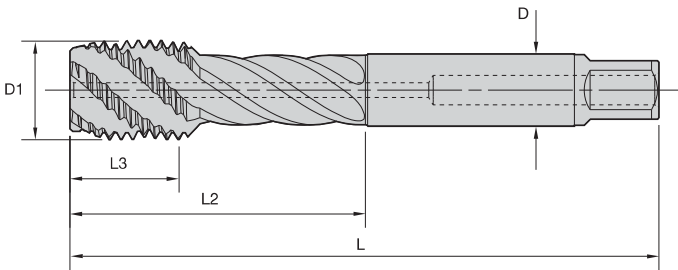

- T631 • DIN 376 • Form C Semi-Bottoming Chamfer • Through Coolant • Larger Sizes • Metric • For Steel and Cast Iron • Rigid and Synchronous Holders

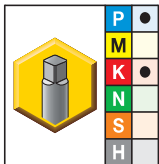

- first choice
- alternate choice

KP6525	D1 size	L	L3	L2	D	number of flutes	dimension standard	class of fit
T631M240X300R6HX-D6	M24 X 3	160	30	77	18,0	5	DIN 376	6HX
T631M300X350R6HX-D6	M30 X 3,5	180	35	91	22,0	5	DIN 376	6HX
T631M330X350R6HX-D6	M33 X 3,5	180	35	100	25,0	5	DIN 376	6HX
T631M360X400R6HX-D6	M36 X 4	200	40	110	28,0	5	DIN 376	6HX
T631M420X450R6HX-D6	M42 X 4,5	200	45	120	32,0	5	DIN 376	6HX

NOTE: Suggested for use in rigid and synchronous holders.

Shank Tolerance	
D	tolerance h6
12-18	+0, -0,011
20-30	+0, -0,013
32-36	+0, -0,016

Tapping

High-Performance Taps

Beyond™ Spiral-Flute HSS-E-PM Taps • Blind Holes



- KP6525 TiCN + TiN for tapping steel and cast iron.

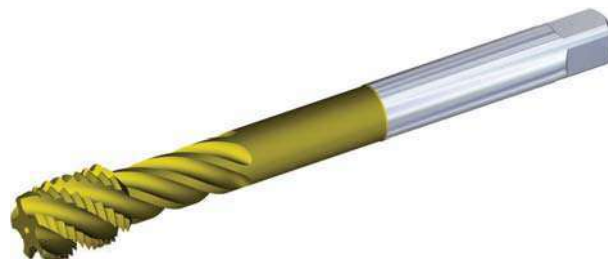
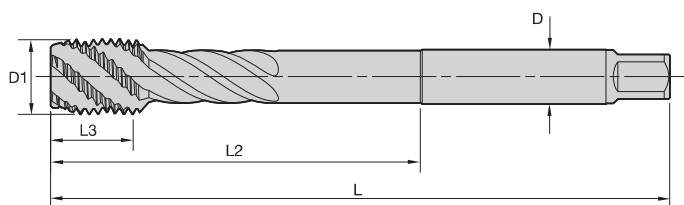

- T630 • Extra Long • Form C Semi-Bottoming Chamfer • Larger Sizes • Metric • For Steel and Cast Iron • Rigid and Synchronous Holders

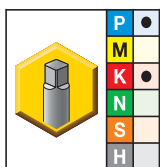

- first choice
- alternate choice

KP6525	D1 size	L	L3	L2	D	number of flutes	class of fit
T630M240X300R6HX-XL	M24 X 3	200	30	120	18,0	5	6HX
T630M300X350R6HX-XL	M30 X 3,5	250	35	150	22,0	5	6HX
T630M330X350R6HX-XL	M33 X 3,5	250	35	150	25,0	5	6HX
T630M360X400R6HX-XL	M36 X 4	250	40	150	28,0	5	6HX
T630M420X450R6HX-XL	M42 X 4,5	300	45	180	32,0	5	6HX

NOTE: Suggested for use in rigid and synchronous holders.

Shank Tolerance

D	tolerance h6
12-18	+0, -0,011
20-30	+0, -0,013
32-36	+0, -0,016

Tapping

- KP6525 TiCN + TiN for tapping steel and cast iron.

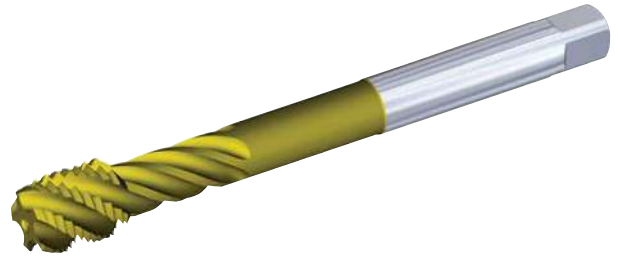
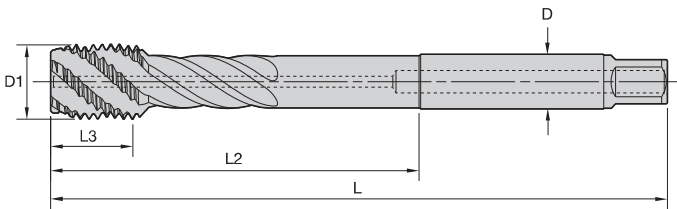

- T631 • Extra Long • Form C Semi-Bottoming Chamfer • Through Coolant • Larger Sizes • Metric • For Steel and Cast Iron • Rigid and Synchronous Holders

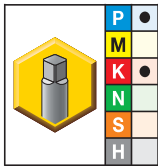

- first choice
- alternate choice

KP6525	D1 size	L	L3	L2	D	number of flutes	class of fit
T631M240X300R6HX-XL	M24 X 3	200	30	120	18,0	5	6HX
T631M300X350R6HX-XL	M30 X 3,5	250	35	150	22,0	5	6HX
T631M330X350R6HX-XL	M33 X 3,5	250	35	150	25,0	5	6HX
T631M360X400R6HX-XL	M36 X 4	250	40	150	28,0	5	6HX
T631M420X450R6HX-XL	M42 X 4,5	300	45	180	32,0	5	6HX

NOTE: Suggested for use in rigid and synchronous holders.

Shank Tolerance

D	tolerance h6
12-18	+0, -0,011
20-30	+0, -0,013
32-36	+0, -0,016

Tapping

High-Performance Taps

Beyond™ Spiral-Flute HSS-E-PM Taps • Blind Holes



- KP6525 TiCN + TiN for tapping steel and cast iron.

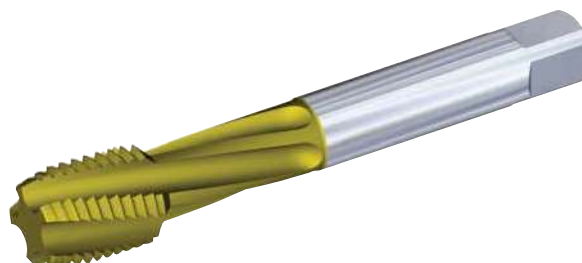
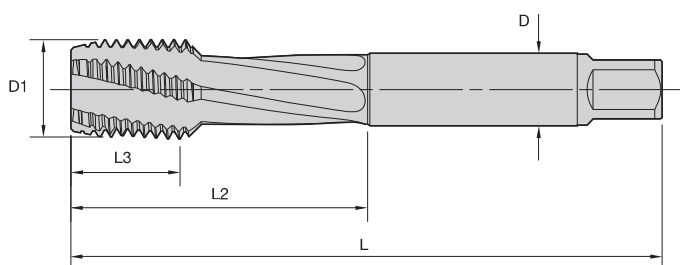

T650 • DIN 376 • Form C Semi-Bottoming Chamfer • Larger Sizes • Metric • For Steel and Cast Iron

Tapping

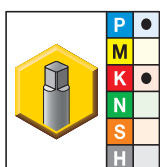

● first choice

○ alternate choice

KP6525	D1 size	L	L3	L2	D	number of flutes	dimension standard	class of fit
T650M240X300R6HX-D6	M24 X 3	160	30	77	18,0	4	DIN 376	6HX
T650M300X350R6HX-D6	M30 X 3,5	180	35	91	22,0	5	DIN 376	6HX
T650M330X350R6HX-D6	M33 X 3,5	180	35	100	25,0	5	DIN 376	6HX
T650M360X400R6HX-D6	M36 X 4	200	40	110	28,0	5	DIN 376	6HX
T650M420X450R6HX-D6	M42 X 4,5	200	45	120	32,0	6	DIN 376	6HX

Shank Tolerance

D	tolerance h6
12-18	+0, -0,011
20-30	+0, -0,013
32-36	+0, -0,016

- KP6525 TiCN + TiN for tapping steel and cast iron.

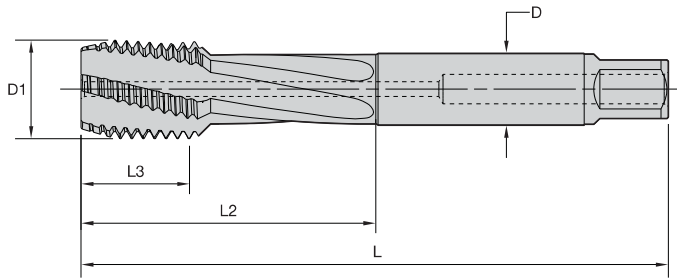

■ T651 • DIN 376 • Form C Semi-Bottoming Chamfer • Through Coolant • Larger Sizes • Metric • For Steel and Cast Iron

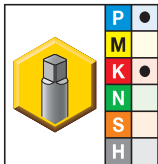

- first choice
- alternate choice

KP6525	D1 size	L	L3	L2	D	number of flutes	dimension standard	class of fit
T651M240X300R6HX-D6	M24 X 3	160	30	77	18,0	4	DIN 376	6HX
T651M300X350R6HX-D6	M30 X 3,5	180	35	91	22,0	5	DIN 376	6HX
T651M330X350R6HX-D6	M33 X 3,5	180	35	100	25,0	5	DIN 376	6HX
T651M360X400R6HX-D6	M36 X 4	200	40	110	28,0	5	DIN 376	6HX
T651M420X450R6HX-D6	M42 X 4,5	200	45	120	32,0	6	DIN 376	6HX

Shank Tolerance

D	tolerance h6
12-18	+0, -0,011
20-30	+0, -0,013
32-36	+0, -0,016



High-Performance Taps

Beyond™ Spiral-Flute HSS-E-PM Taps • Blind Holes



- KP6525 TiCN + TiN for tapping steel and cast iron.

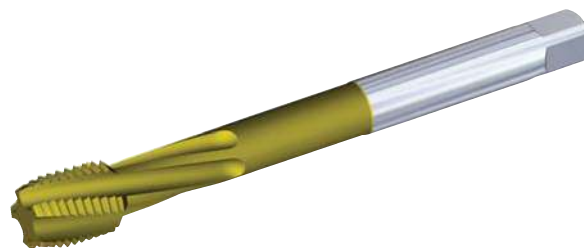
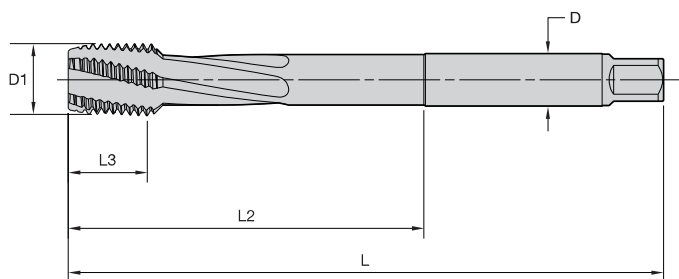

T650 • Extra Long • Form C Semi-Bottoming Chamfer • Larger Sizes • Metric • For Steel and Cast Iron

Tapping

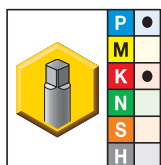

- first choice
- alternate choice

KP6525	D1 size	L	L3	L2	D	number of flutes	class of fit
T650M240X300R6HX-XL	M24 X 3	200	30	120	18,0	4	6HX
T650M300X350R6HX-XL	M30 X 3,5	250	35	150	22,0	5	6HX
T650M330X350R6HX-XL	M33 X 3,5	250	35	150	25,0	5	6HX
T650M360X400R6HX-XL	M36 X 4	250	40	150	28,0	5	6HX
T650M420X450R6HX-XL	M42 X 4,5	300	45	180	32,0	6	6HX

Shank Tolerance

D	tolerance h6
12-18	+0, -0,011
20-30	+0, -0,013
32-36	+0, -0,016

- KP6525 TiCN + TiN for tapping steel and cast iron.

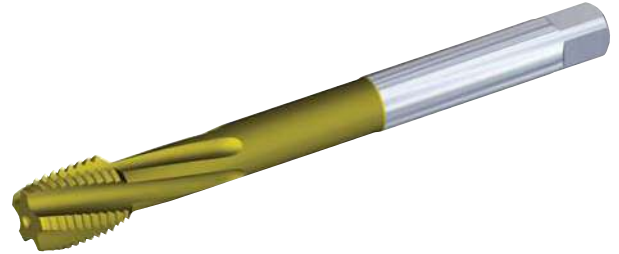
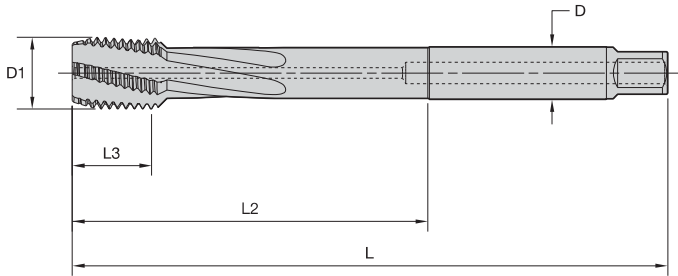

■ T651 • Extra Long • Form C Semi-Bottoming Chamfer • Through Coolant • Larger Sizes • Metric • For Steel and Cast Iron

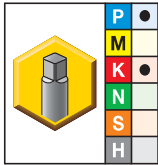

- first choice
- alternate choice

KP6525	D1 size	L	L3	L2	D	number of flutes	class of fit
T651M240X300R6HX-XL	M24 X 3	200	30	120	18,0	4	6HX
T651M300X350R6HX-XL	M30 X 3,5	250	35	150	22,0	5	6HX
T651M330X350R6HX-XL	M33 X 3,5	250	35	150	25,0	5	6HX
T651M360X400R6HX-XL	M36 X 4	250	40	150	28,0	5	6HX
T651M420X450R6HX-XL	M42 X 4,5	300	45	180	32,0	6	6HX

Shank Tolerance

D	tolerance h6
12-18	+0, -0,011
20-30	+0, -0,013
32-36	+0, -0,016



• KP6525 TiCN + TiN for steel.

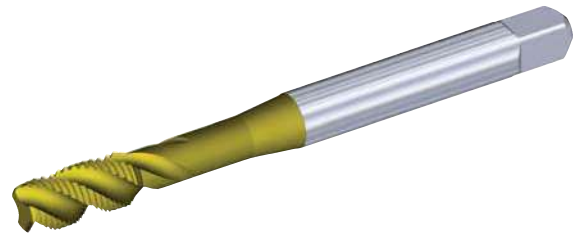
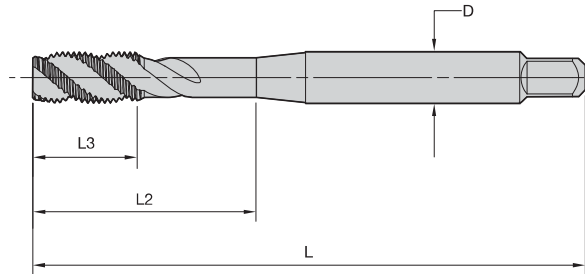
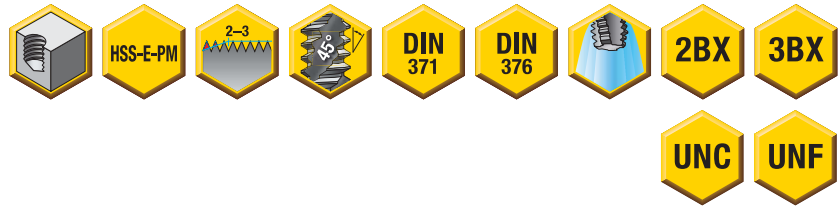

■ T630 • DIN 371 and 376 • Form C Semi-Bottoming Chamfer • Machine Screw and Fractional • For Steel • Rigid and Synchronous Holders

Tapping

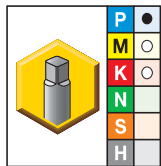

● first choice

○ alternate choice

KP6525	D1 size	L	L3	L2	D	number of flutes	dimension standard	class of fit
T630NC#06-32R2BX-D1	6 - 32	56	9	20	4,0	3	DIN 371	2BX
T630NF#06-40R2BX-D1	6 - 40	56	9	20	4,0	3	DIN 371	2BX
T630NC#08-32R2BX-D1	8 - 32	63	10	21	4,5	3	DIN 371	2BX
T630NC#10-24R2BX-D1	10 - 24	70	10	25	6,0	3	DIN 371	2BX
T630NF#10-32R2BX-D1	10 - 32	70	10	25	6,0	3	DIN 371	2BX
T630NC02500-20R3BX-D1	1/4 - 20	80	13	30	7,0	3	DIN 371	3BX
T630NF02500-28R3BX-D1	1/4 - 28	80	13	30	7,0	3	DIN 371	3BX
T630NC03125-18R3BX-D1	5/16 - 18	90	13	35	8,0	3	DIN 371	3BX
T630NF03125-24R3BX-D1	5/16 - 24	90	13	35	8,0	3	DIN 371	3BX
T630NC03750-16R3BX-D1	3/8 - 16	100	16	39	10,0	3	DIN 371	3BX
T630NF03750-24R3BX-D1	3/8 - 24	100	16	39	10,0	3	DIN 371	3BX
T630NC04375-14R3BX-D6	7/16 - 14	100	15	41	8,0	4	DIN 376	3BX
T630NF04375-20R3BX-D6	7/16 - 20	100	15	41	8,0	4	DIN 376	3BX
T630NC05000-13R3BX-D6	1/2 - 13	110	20	47	9,0	4	DIN 376	3BX
T630NF05000-20R3BX-D6	1/2 - 20	110	20	47	9,0	4	DIN 376	3BX

NOTE: Suggested for use in rigid and synchronous holders.

Shank Tolerance

D fractional	tolerance h6
>3-6	+0, -0,008
>6-10	+0, -0,009
<10-18	+0, -0,011

- KP6525 TiCN + TiN for steel.

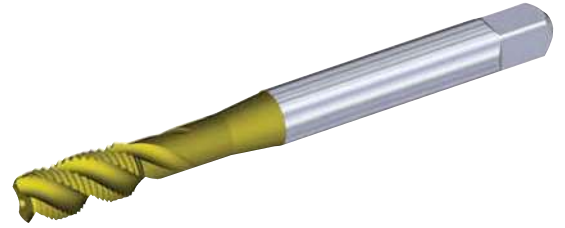
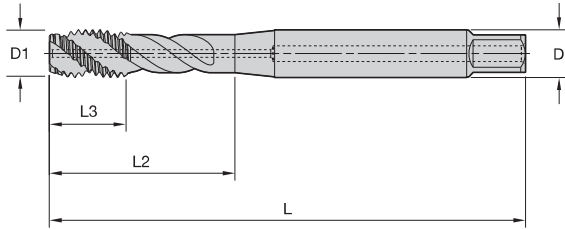

■ T631 • DIN 371 and 376 • Form C Semi-Bottoming Chamfer • Through Coolant • Fractional • For Steel • Rigid and Synchronous Holders

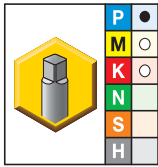

- first choice
- alternate choice

KP6525	D1 size	L	L3	L2	D	number of flutes	dimension standard	class of fit
T631NC02500-20R3BX-D1	1/4 - 20	80	13	30	7,0	3	DIN 371	3BX
T631NF02500-28R3BX-D1	1/4 - 28	80	13	30	7,0	3	DIN 371	3BX
T631NC03125-18R3BX-D1	5/16 - 18	90	13	35	8,0	3	DIN 371	3BX
T631NF03125-24R3BX-D1	5/16 - 24	90	13	35	8,0	3	DIN 371	3BX
T631NC03750-16R3BX-D1	3/8 - 16	100	16	39	10,0	3	DIN 371	3BX
T631NF03750-24R3BX-D1	3/8 - 24	100	16	39	10,0	3	DIN 371	3BX
T631NC04375-14R3BX-D6	7/16 - 14	100	15	41	8,0	4	DIN 376	3BX
T631NF04375-20R3BX-D6	7/16 - 20	100	15	41	8,0	4	DIN 376	3BX
T631NC05000-13R3BX-D6	1/2 - 13	110	20	47	9,0	4	DIN 376	3BX
T631NF05000-20R3BX-D6	1/2 - 20	110	20	47	9,0	4	DIN 376	3BX

NOTE: Suggested for use in rigid and synchronous holders.

Shank Tolerance

D fractional	tolerance h6
>3-6	+0, -0,008
>6-10	+0, -0,009
<10-18	+0, -0,011



- KSN38 DLC for tapping aluminium.

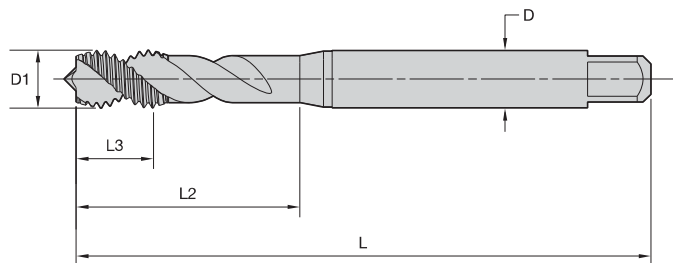

T680 • DIN 371 and 376 • Form C Semi-Bottoming Chamfer • Metric • For Aluminium

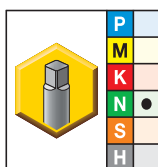

- first choice
- alternate choice

KSN38	D1 size	L	L3	L2	D	number of flutes	dimension standard	class of fit
T680M030X050R6H-D1	M3 X 0,5	56	6	18	3,5	2	DIN 371	6H
T680M040X070R6H-D1	M4 X 0,7	63	7	21	4,5	2	DIN 371	6H
T680M050X080R6H-D1	M5 X 0,8	70	8	25	6,0	2	DIN 371	6H
T680M060X100R6H-D1	M6 X 1	80	10	30	6,0	2	DIN 371	6H
T680M080X125R6H-D1	M8 X 1,25	90	14	35	8,0	2	DIN 371	6H
T680M100X150R6H-D1	M10 X 1,5	100	16	39	10,0	2	DIN 371	6H
T680M120X175R6H-D6	M12 X 1,75	110	18	—	9,0	3	DIN 376	6H
T680M160X200R6H-D6	M16 X 2	110	22	—	12,0	3	DIN 376	6H
T680M200X250R6H-D6	M20 X 2,5	140	25	—	16,0	3	DIN 376	6H

Shank Tolerance

D	tolerance h9
1-3	+0, -0,025
3,5-6	+0, -0,030
7-10	+0, -0,036
11-18	+0, -0,043

Tapping

- KSH26 TiAlN/MoS₂ for tapping steel 32–44 HRC (3 x D).

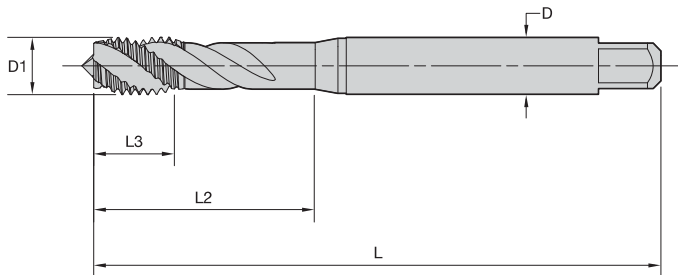
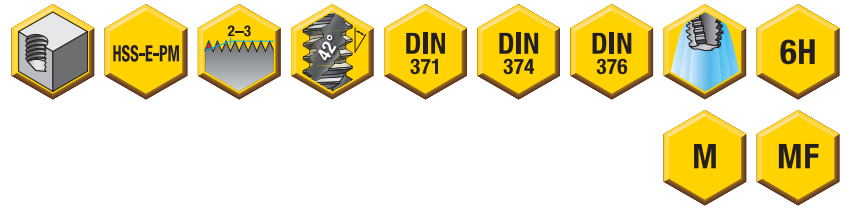

■ T604 • DIN 371, 374, and 376 • Form C Semi-Bottoming Chamfer • Metric • For Hard Steel

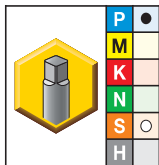

- first choice
- alternate choice

KSH26	D1 size	L	L3	L2	D	number of flutes	dimension standard	class of fit
T604M030X050R6H-D1	M3 X 0,5	56	6	18	3,5	3	DIN 371	6H
T604M040X070R6H-D1	M4 X 0,7	63	7	21	4,5	3	DIN 371	6H
T604M050X080R6H-D1	M5 X 0,8	70	8	25	6,0	3	DIN 371	6H
T604M060X100R6H-D1	M6 X 1	80	10	30	6,0	3	DIN 371	6H
T604MF080X100R6H-D4	M8 X 1	90	10	—	6,0	3	DIN 374	6H
T604M080X125R6H-D1	M8 X 1,25	90	14	35	8,0	3	DIN 371	6H
T604MF100X100R6H-D4	M10 X 1	90	10	—	7,0	3	DIN 374	6H
T604MF100X125R6H-D4	M10 X 1,25	100	16	—	7,0	3	DIN 374	6H
T604M100X150R6H-D1	M10 X 1,5	100	16	39	10,0	3	DIN 371	6H
T604MF120X125R6H-D4	M12 X 1,25	100	15	—	9,0	4	DIN 374	6H
T604MF120X150R6H-D4	M12 X 1,5	100	15	—	9,0	4	DIN 374	6H
T604M120X175R6H-D6	M12 X 1,75	110	18	—	9,0	4	DIN 376	6H
T604MF140X150R6H-D4	M14 X 1,5	100	15	—	11,0	4	DIN 374	6H
T604M140X200R6H-D6	M14 X 2	110	20	—	11,0	4	DIN 376	6H
T604MF160X150R6H-D4 *	M16 X 1,5	100	15	—	12,0	4	DIN 374	6H
T604M160X200R6H-D6	M16 X 2	110	22	—	12,0	4	DIN 376	6H
T604M180X250R6H-D6	M18 X 2,5	125	25	—	14,0	4	DIN 376	6H
T604M200X250R6H-D6	M20 X 2,5	140	25	—	16,0	4	DIN 376	6H

NOTE: *Made-to-order standard item. Standard pricing, manufacturing lead time, and minimum order quantity applies.

Shank Tolerance

D	tolerance h9
1–3	+0, -0,025
3,5–6	+0, -0,030
7–10	+0, -0,036
11–18	+0, -0,043

Multipurpose Taps

G0tap™ T830 Spiral-Flute HSS-E Taps • Blind Holes



- KSP32 TiCN/TiN
- KSP39 oxide

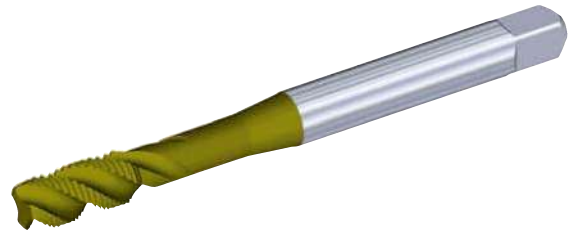
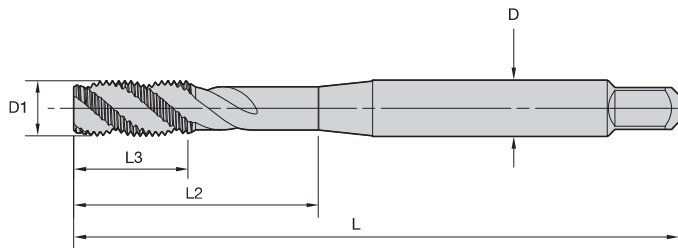

T830 • DIN 371, 374, and 376 • Form C Semi-Bottoming Chamfer • Metric • Rigid and Synchronous Holders

Tapping

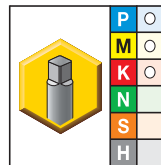
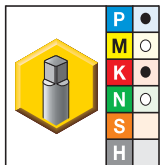

● first choice

○ alternate choice

KSP32	KSP39	D1 size	L	L3	L2	D	number of flutes	dimension standard	class of fit
—	T830M020X040R6H-D1	M2 X 0,4	45	7	13	2,8	2	DIN 371	6H
—	T830M020X040R6G-D1	M2 X 0,4	45	7	13	2,8	2	DIN 371	6G
—	T830M025X045R6H-D1	M2,5 X 0,45	50	7	15	2,8	2	DIN 371	6H
—	T830M025X045R6G-D1	M2,5 X 0,45	50	7	15	2,8	2	DIN 371	6G
T830M030X050R6H-D1	T830M030X050R6H-D1	M3 X 0,5	56	8	18	3,5	2	DIN 371	6H
—	T830M030X050R6G-D1	M3 X 0,5	56	8	18	3,5	2	DIN 371	6G
—	T830M035X060R6H-D1	M3,5 X 0,6	56	9	20	4,0	2	DIN 371	6H
T830M040X070R6H-D1	T830M040X070R6H-D1	M4 X 0,7	63	11	21	4,5	3	DIN 371	6H
—	T830M040X070R6G-D1	M4 X 0,7	63	11	21	4,5	3	DIN 371	6G
T830M050X080R6H-D1	T830M050X080R6H-D1	M5 X 0,8	70	12	25	6,0	3	DIN 371	6H
—	T830M050X080R6G-D1	M5 X 0,8	70	12	25	6,0	3	DIN 371	6G
—	T830M060X100R6H-D6	M6 X 1	80	12	30	4,5	3	DIN 376	6H
T830M060X100R6H-D1	T830M060X100R6H-D1	M6 X 1	80	12	30	6,0	3	DIN 371	6H
—	T830M060X100R6G-D1	M6 X 1	80	12	30	6,0	3	DIN 371	6G
—	T830M070X100R6H-D1	M7 X 1	80	12	30	7,0	3	DIN 371	6H
T830MF080X100R6H-D4	T830MF080X100R6H-D4	M8 X 1	90	15	35	6,0	3	DIN 374	6H
—	T830M080X125R6H-D6	M8 X 1,25	90	15	35	6,0	3	DIN 376	6H
T830M080X125R6H-D1	T830M080X125R6H-D1	M8 X 1,25	90	15	35	8,0	3	DIN 371	6H
—	T830M080X125R6G-D1	M8 X 1,25	90	15	35	8,0	3	DIN 371	6G
T830MF100X125R6H-D4	T830MF100X125R6H-D4	M10 X 1,25	100	18	39	7,0	3	DIN 374	6H
—	T830M100X150R6H-D6	M10 X 1,5	100	18	39	7,0	3	DIN 376	6H
T830M100X150R6H-D1	—	M10 X 1,5	100	18	39	10,0	3	DIN 371	6G
—	T830M100X150R6H-D1	M10 X 1,5	100	18	39	10,0	3	DIN 371	6H
—	T830M100X150R6G-D1	M10 X 1,5	100	18	39	10,0	3	DIN 371	6G
—	T830MF120X125R6H-D4	M12 X 1,25	100	21	39	9,0	3	DIN 374	6H
T830MF120X150R6H-D4	T830MF120X150R6H-D4	M12 X 1,5	100	21	39	9,0	3	DIN 374	6H
T830M120X175R6H-D6	T830M120X175R6H-D6	M12 X 1,75	110	21	44	9,0	3	DIN 376	6H
—	T830M120X175R6G-D6	M12 X 1,75	110	21	44	9,0	3	DIN 376	6G

(continued)

(T830 • DIN 371, 374, and 376 • Form C Semi-Bottoming Chamfer • Metric • Rigid and Synchronous Holders — continued)

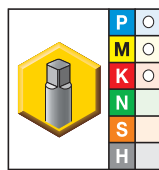
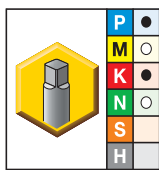

● first choice
○ alternate choice

		D1 size	L	L3	L2	D	number of flutes	dimension standard	class of fit
KSP32	KSP39								
T830MF140X150R6H-D4	T830MF140X150R6H-D4	M14 X 1,5	100	21	47	11,0	3	DIN 374	6H
T830M140X200R6H-D6	T830M140X200R6H-D6	M14 X 2	110	24	52	11,0	3	DIN 376	6H
—	T830M140X200R6G-D6	M14 X 2	110	24	52	11,0	3	DIN 376	6G
—	T830MF160X150R6H-D4	M16 X 1,5	100	21	46	12,0	3	DIN 374	6H
—	T830M160X200R6H-D6	M16 X 2	110	24	51	12,0	3	DIN 376	6H
—	T830M160X200R6G-D6	M16 X 2	110	24	51	12,0	3	DIN 376	6G
—	T830MF180X150R6H-D4	M18 X 1,5	110	21	50	14,0	4	DIN 374	6H
—	T830M180X250R6H-D6	M18 X 2,5	125	30	58	14,0	4	DIN 376	6H
—	T830M200X250R6H-D6	M20 X 2,5	140	30	64	16,0	4	DIN 376	6H
—	T830M220X250R6H-D6	M22 X 2,5	140	30	70	18,0	4	DIN 376	6H
—	T830M240X300R6H-D6	M24 X 3	160	36	77	18,0	4	DIN 376	6H
—	T830M270X300R6H-D6	M27 X 3	160	36	82	20,0	4	DIN 376	6H
—	T830M300X350R6H-D6	M30 X 3,5	180	42	91	22,0	4	DIN 376	6H
—	T830M330X350R6H-D6	M33 X 3,5	180	42	100	25,0	4	DIN 376	6H
—	T830M360X400R6H-D6	M36 X 4	200	48	110	28,0	5	DIN 376	6H

NOTE: Suggested for use in rigid and synchronous holders.

Shank Tolerance

D mm	tolerance h9
1-3	+0, -0,025
>3-6	+0, -0,030
>6-10	+0, -0,036
>10-18	+0, -0,043
>18-30	+0, -0,052



Multipurpose Taps

G0tap™ T832 Spiral-Flute HSS-E Taps • Blind Holes



- KSP32 TiCN/TiN
- KSP39 oxide

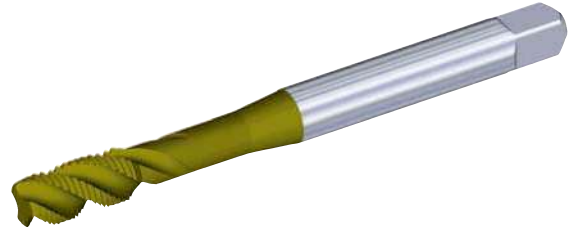
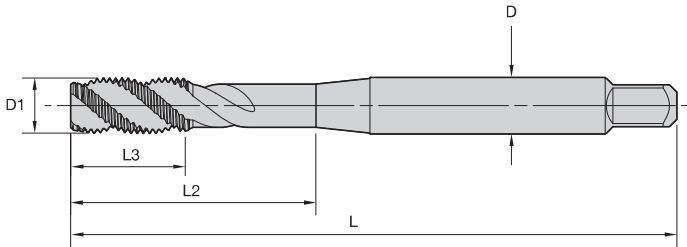

■ T832 • DIN 371, 374, and 376 • Form E Bottoming Chamfer • Metric • Rigid and Synchronous Holders

Tapping

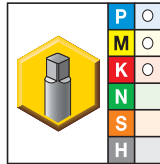
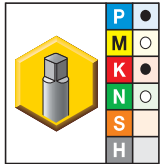

- first choice
- alternate choice

		D1 size	L	L3	L2	D	number of flutes	dimension standard	class of fit
KSP32	KSP39								
T832M030X050R6H-D1	T832M030X050R6H-D1	M3 X 0,5	56	8	18	3,5	2	DIN 371	6H
T832M040X070R6H-D1	T832M040X070R6H-D1	M4 X 0,7	63	11	21	4,5	3	DIN 371	6H
T832M050X080R6H-D1	T832M050X080R6H-D1	M5 X 0,8	70	12	25	6,0	3	DIN 371	6H
T832M060X100R6H-D1	T832M060X100R6H-D1	M6 X 1	80	12	30	6,0	3	DIN 371	6H
T832MF080X100R6H-D4	T832MF080X100R6H-D4	M8 X 1	90	15	35	6,0	3	DIN 374	6H
T832M080X125R6H-D1	T832M080X125R6H-D1	M8 X 1,25	90	15	35	8,0	3	DIN 371	6H
T832MF100X125R6H-D4	T832MF100X125R6H-D4	M10 X 1,25	100	18	39	7,0	3	DIN 374	6H
T832M100X150R6H-D1	T832M100X150R6H-D1	M10 X 1,5	100	18	39	10,0	3	DIN 371	6H
T832MF120X150R6H-D4	T832MF120X150R6H-D4	M12 X 1,5	100	21	39	9,0	3	DIN 374	6H
T832M120X175R6H-D6	T832M120X175R6H-D6	M12 X 1,75	110	21	44	9,0	3	DIN 376	6H
T832MF140X150R6H-D4	T832MF140X150R6H-D4	M14 X 1,5	100	21	47	11,0	3	DIN 374	6H
T832M140X200R6H-D6	T832M140X200R6H-D6	M14 X 2	110	24	52	11,0	3	DIN 376	6H
—	T832M160X200R6H-D6	M16 X 2	110	24	51	12,0	3	DIN 376	6H
T832M180X250R6H-D6	T832M180X250R6H-D6	M18 X 2,5	125	30	58	14,0	4	DIN 376	6H
T832M200X250R6H-D6	T832M200X250R6H-D6	M20 X 2,5	140	30	64	16,0	4	DIN 376	6H

NOTE: Suggested for use in rigid and synchronous holders.

Shank Tolerance

D mm	tolerance h9
1-3	+0, -0,025
>3-6	+0, -0,030
>6-10	+0, -0,036
>10-18	+0, -0,043
>18-30	+0, -0,052

- KSU31 TiN
- KSP39 oxide

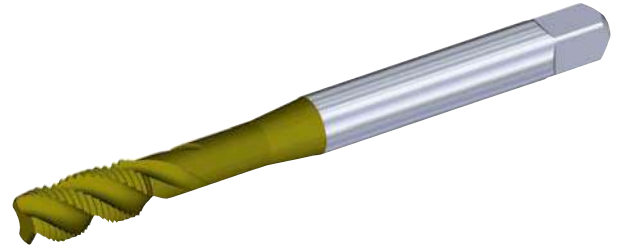
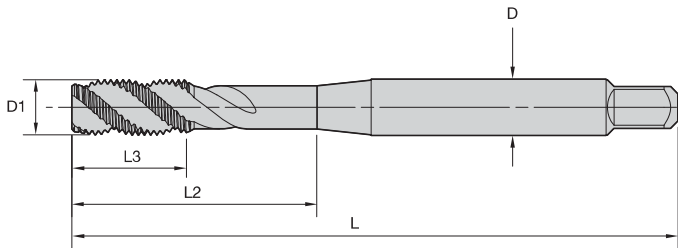

■ T838 • DIN 371, 374, and 376 • Form C Semi-Bottoming Chamfer • Metric • Tension/Compression Holders

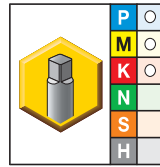
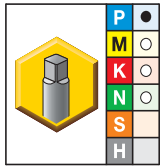

- first choice
- alternate choice

Tapping

KSU31	KSP39	D1 size	L	L3	L2	D	number of flutes	dimension standard	class of fit
T838M020X040R6H-D1	T838M020X040R6H-D1	M2 X 0,4	45	7	13	2,8	3	DIN 371	6H
T838M030X050R6H-D1	T838M030X050R6H-D1	M3 X 0,5	56	5	19	3,5	3	DIN 371	6H
T838M040X070R6H-D1	T838M040X070R6H-D1	M4 X 0,7	63	7	21	4,5	3	DIN 371	6H
T838M050X080R6H-D1	T838M050X080R6H-D1	M5 X 0,8	70	8	26	6,0	3	DIN 371	6H
T838M050X080R6H-D6	T838M050X080R6H-D6	M5 X 0,8	70	8	27	3,5	3	DIN 376	6H
T838MF060X075R6H-D4	T838MF060X075R6H-D4	M6 X 0,75	80	10	34	4,5	3	DIN 374	6H
T838M060X100R6H-D1	T838M060X100R6H-D1	M6 X 1	80	10	30	6,0	3	DIN 371	6H
T838M060X100R6H-D6	T838M060X100R6H-D6	M6 X 1	80	10	34	4,5	3	DIN 376	6H
T838MF080X075R6H-D4	T838MF080X075R6H-D4	M8 X 0,75	90	13	37	6,0	3	DIN 374	6H
T838MF080X100R6H-D4	T838MF080X100R6H-D4	M8 X 1	90	13	37	6,0	3	DIN 374	6H
T838M080X125R6H-D1	T838M080X125R6H-D1	M8 X 1,25	90	13	37	8,0	3	DIN 371	6H
T838M080X125R6H-D6	T838M080X125R6H-D6	M8 X 1,25	90	13	37	6,0	3	DIN 376	6H
T838MF100X075R6H-D4	T838MF100X075R6H-D4	M10 X 0,75	90	15	40	7,0	3	DIN 374	6H
T838MF100X100R6H-D4	T838MF100X100R6H-D4	M10 X 1	90	15	40	7,0	3	DIN 374	6H
T838MF100X125R6H-D4	T838MF100X125R6H-D4	M10 X 1,25	100	15	44	7,0	3	DIN 374	6H
T838M100X150R6H-D1	T838M100X150R6H-D1	M10 X 1,5	100	15	41	10,0	3	DIN 371	6H
T838M100X150R6H-D6	T838M100X150R6H-D6	M10 X 1,5	100	15	44	7,0	3	DIN 376	6H
T838MF120X100R6H-D4	T838MF120X100R6H-D4	M12 X 1	100	13	50	9,0	3	DIN 374	6H
T838MF120X125R6H-D4	T838MF120X125R6H-D4	M12 X 1,25	100	13	50	9,0	3	DIN 374	6H
T838MF120X150R6H-D4	T838MF120X150R6H-D4	M12 X 1,5	100	13	50	9,0	3	DIN 374	6H
T838M120X175R6H-D6	T838M120X175R6H-D6	M12 X 1,75	110	18	55	9,0	3	DIN 376	6H
T838MF140X100R6H-D4	T838MF140X100R6H-D4	M14 X 1	100	15	41	11,0	4	DIN 374	6H
T838MF140X125R6H-D4	T838MF140X125R6H-D4	M14 X 1,25	100	15	41	11,0	4	DIN 374	6H
T838MF140X150R6H-D4	T838MF140X150R6H-D4	M14 X 1,5	100	15	41	11,0	4	DIN 374	6H
T838M140X200R6H-D6	T838M140X200R6H-D6	M14 X 2	110	20	50	11,0	3	DIN 376	6H
T838MF160X150R6H-D4	T838MF160X150R6H-D4	M16 X 1,5	100	15	45	12,0	4	DIN 374	6H
T838M160X200R6H-D6	T838M160X200R6H-D6	M16 X 2	110	20	55	12,0	4	DIN 376	6H
T838MF180X150R6H-D4	T838MF180X150R6H-D4	M18 X 1,5	110	17	55	14,0	4	DIN 374	6H
T838MF180X200R6H-D4	T838MF180X200R6H-D4	M18 X 2	125	25	61	14,0	4	DIN 374	6H
T838M180X250R6H-D6	T838M180X250R6H-D6	M18 X 2,5	125	25	61	14,0	4	DIN 376	6H
T838MF200X150R6H-D4	T838MF200X150R6H-D4	M20 X 1,5	125	17	56	16,0	4	DIN 374	6H
T838MF200X200R6H-D4	T838MF200X200R6H-D4	M20 X 2	140	25	65	16,0	4	DIN 374	6H

(continued)

Multipurpose Taps

G0tap™ T838 Spiral-Flute HSS-E Taps • Blind Holes



(T838 • DIN 371, 374, and 376 • Form C Semi-Bottoming Chamfer • Metric • Tension/Compression Holders — continued)

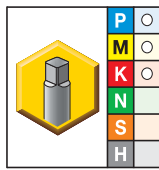
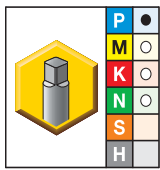

● first choice

○ alternate choice

		D1 size	L	L3	L2	D	number of flutes	dimension standard	class of fit
KSU31	KSP39								
T838M200X250R6H-D6	T838M200X250R6H-D6	M20 X 2,5	140	25	65	16,0	4	DIN 376	6H
T838MF220X150R6H-D4	T838MF220X150R6H-D4	M22 X 1,5	125	18	61	18,0	4	DIN 374	6H
T838MF220X200R6H-D4	T838MF220X200R6H-D4	M22 X 2	140	25	66	18,0	4	DIN 374	6H
T838M220X250R6H-D6	T838M220X250R6H-D6	M22 X 2,5	140	25	66	18,0	4	DIN 376	6H
T838MF240X150R6H-D4	T838MF240X150R6H-D4	M24 X 1,5	140	20	67	18,0	4	DIN 374	6H
T838MF240X200R6H-D4	T838MF240X200R6H-D4	M24 X 2	140	20	67	18,0	4	DIN 374	6H
T838M240X300R6H-D6	T838M240X300R6H-D6	M24 X 3	160	30	77	18,0	4	DIN 376	6H
T838MF270X150R6H-D4	T838MF270X150R6H-D4	M27 X 1,5	140	20	65	20,0	4	DIN 374	6H
T838M270X300R6H-D6	T838M270X300R6H-D6	M27 X 3	160	33	85	20,0	4	DIN 376	6H
T838MF300X150R6H-D4	T838MF300X150R6H-D4	M30 X 1,5	150	22	68	20,0	4	DIN 374	6H
T838MF300X200R6H-D4	T838MF300X200R6H-D4	M30 X 2	150	22	68	22,0	4	DIN 374	6H
T838M300X350R6H-D6	T838M300X350R6H-D6	M30 X 3,5	180	35	87	22,0	4	DIN 376	6H
T838M330X350R6H-D6	T838M330X350R6H-D6	M33 X 3,5	180	35	92	25,0	4	DIN 376	6H
T838M360X400R6H-D6	T838M360X400R6H-D6	M36 X 4	200	40	110	28,0	4	DIN 376	6H
T838M390X400R6H-D6	T838M390X400R6H-D6	M39 X 4	200	40	105	32,0	4	DIN 376	6H
T838M420X450R6H-D6	T838M420X450R6H-D6	M42 X 4,5	200	40	105	32,0	5	DIN 376	6H
T838M450X450R6H-D6	T838M450X450R6H-D6	M45 X 5	220	50	110	36,0	5	DIN 376	6H
T838M480X500R6H-D6	T838M480X500R6H-D6	M48 X 5	250	50	145	36,0	5	DIN 376	6H
T838M520X500R6H-D6	T838M520X500R6H-D6	M52 X 5	250	50	135	40,0	5	DIN 376	6H

NOTE: Suitable for tension/compression holders.

Shank Tolerance

D mm	tolerance h9
1-3	+0, -0,025
>3-6	+0, -0,030
>6-10	+0, -0,036
>10-18	+0, -0,043
>18-30	+0, -0,052

Tapping

- KSU31 TiN
- KSP39 oxide

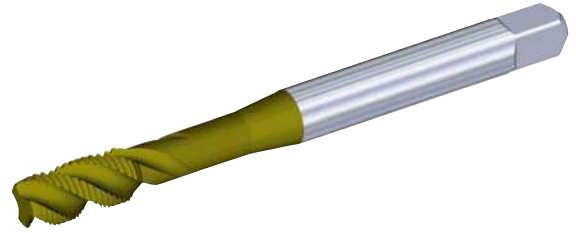
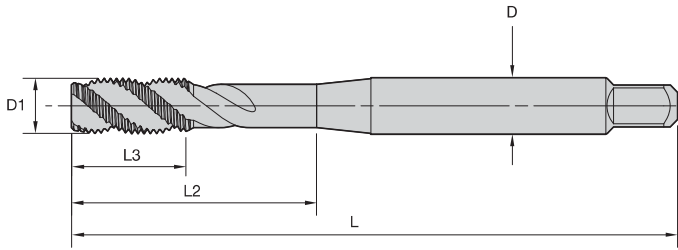

■ T839 • DIN 371 and 376 • Form E Bottoming Chamfer • Metric • Tension/Compression Holders

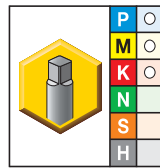
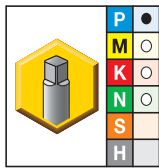

- first choice
- alternate choice

KSU31	KSP39	D1 size	L	L3	L2	D	number of flutes	dimension standard	class of fit
T839M030X050R6H-D1	T839M030X050R6H-D1	M3 X 0,5	56	5	19	3,5	3	DIN 371	6H
T839M040X070R6H-D1	T839M040X070R6H-D1	M4 X 0,7	63	7	21	4,5	3	DIN 371	6H
T839M050X080R6H-D1	T839M050X080R6H-D1	M5 X 0,8	70	8	26	6,0	3	DIN 371	6H
T839M060X100R6H-D1	T839M060X100R6H-D1	M6 X 1	80	10	30	6,0	3	DIN 371	6H
T839M080X125R6H-D1	T839M080X125R6H-D1	M8 X 1,25	90	13	37	8,0	3	DIN 371	6H
T839M100X150R6H-D1	T839M100X150R6H-D1	M10 X 1,5	100	15	42	10,0	3	DIN 371	6H
T839M120X175R6H-D6	T839M120X175R6H-D6	M12 X 1,75	110	18	55	9,0	3	DIN 376	6H
T839M140X200R6H-D6	T839M140X200R6H-D6	M14 X 2	110	20	50	11,0	3	DIN 376	6H
T839M160X200R6H-D6	T839M160X200R6H-D6	M16 X 2	110	20	55	12,0	4	DIN 376	6H
T839M180X250R6H-D6	T839M180X250R6H-D6	M18 X 2,5	125	25	61	14,0	4	DIN 376	6H
T839M200X250R6H-D6	T839M200X250R6H-D6	M20 X 2,5	140	25	65	16,0	4	DIN 376	6H

NOTE: Suitable for tension/compression holders.

Shank Tolerance

D mm	tolerance h9
1-3	+0, -0,025
>3-6	+0, -0,030
>6-10	+0, -0,036
>10-18	+0, -0,043
>18-30	+0, -0,052



• KSP39 oxide

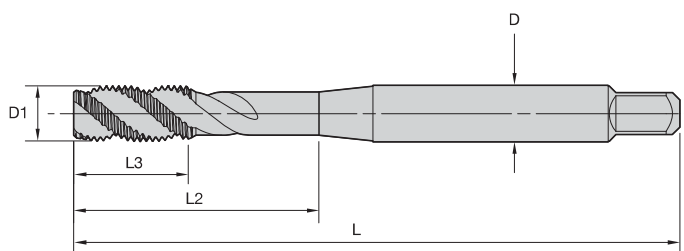

■ T830 • DIN 371 and 376 • Form C Semi-Bottoming Chamfer • UNC/UNF • Rigid and Synchronous Holders

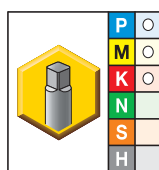

● first choice

○ alternate choice

Tapping

KSP39	metric dimensions					number of flutes	dimension standard	class of fit
	D1 size	L	L3	L2	D			
T830NC#04-40R2B-D1	4 - 40	56	8	18	3,5	2	DIN 371	2B
T830NC#05-40R2B-D1	5 - 40	56	9	20	4,0	2	DIN 371	2B
T830NC#06-32R2B-D1	6 - 32	56	9	20	4,0	2	DIN 371	2B
T830NF#06-40R2B-D1	6 - 40	56	9	20	4,0	2	DIN 371	2B
T830NC#08-32R2B-D1	8 - 32	63	11	21	4,5	3	DIN 371	2B
T830NC#10-24R2B-D1	10 - 24	70	12	25	6,0	3	DIN 371	2B
T830NF#10-32R2B-D1	10 - 32	70	12	25	6,0	3	DIN 371	2B
T830NC02500-20R2B-D1	1/4 - 20	80	15	30	7,0	3	DIN 371	2B
T830NF02500-28R2B-D1	1/4 - 28	80	15	30	7,0	3	DIN 371	2B
T830NC03125-18R2B-D1	5/16 - 18	90	15	35	8,0	3	DIN 371	2B
T830NF03125-24R2B-D1	5/16 - 24	90	15	35	8,0	3	DIN 371	2B
T830NC03750-16R2B-D1	3/8 - 16	100	19	39	10,0	3	DIN 371	2B
T830NF03750-24R2B-D1	3/8 - 24	100	19	39	10,0	3	DIN 371	2B
T830NC04375-14R2B-D6	7/16 - 14	100	18	41	8,0	3	DIN 376	2B
T830NF04375-20R2B-D6	7/16 - 20	100	18	41	8,0	3	DIN 376	2B
T830NC05000-13R2B-D6	1/2 - 13	110	23	47	9,0	3	DIN 376	2B
T830NF05000-20R2B-D6	1/2 - 20	110	23	47	9,0	3	DIN 376	2B
T830NC05625-12R2B-D6	9/16 - 12	110	25	53	11,0	3	DIN 376	2B
T830NF05625-18R2B-D6	9/16 - 18	110	25	53	11,0	3	DIN 376	2B
T830NC06250-11R2B-D6	5/8 - 11	110	24	51	12,0	3	DIN 376	2B
T830NF06250-18R2B-D6	5/8 - 18	110	24	51	12,0	3	DIN 376	2B
T830NC07500-10R2B-D6	3/4 - 10	140	30	64	16,0	4	DIN 376	2B
T830NF07500-16R2B-D6	3/4 - 16	140	30	64	16,0	4	DIN 376	2B
T830NF08750-9R2B-D6	7/8 - 9	140	34	71	18,0	4	DIN 376	2B
T830NF08750-14R2B-D6	7/8 - 14	140	34	71	18,0	4	DIN 376	2B
T830NC10000-8R2B-D6	1 - 8	160	38	81	18,0	4	DIN 376	2B
T830NF10000-12R2B-D6	1 - 12	160	38	81	18,0	4	DIN 376	2B

NOTE: Suggested for use in rigid and synchronous holders.

Shank Tolerance

D mm	tolerance h9
1-3	+0, -0,025
>3-6	+0, -0,030
>6-10	+0, -0,036
>10-18	+0, -0,043
>18-30	+0, -0,052

- KSU31 TiN
- KSP39 oxide

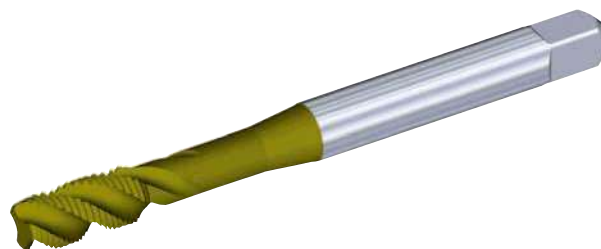
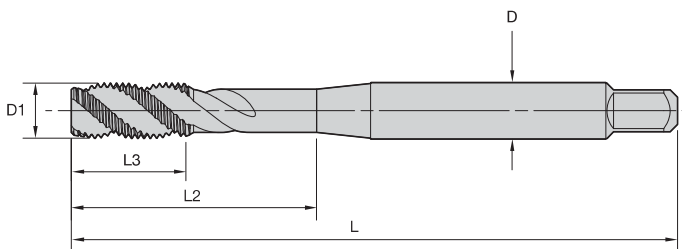

■ T838 • DIN 371, 374, and 376 • Form C Semi-Bottoming Chamfer • UNC/UNF • Tension/Compression Holders

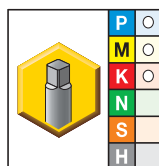
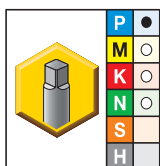

- first choice
- alternate choice

KSU31	KSP39	D1 size	L	L3	L2	D	number of flutes	dimension standard	class of fit
T838NC#06-32R2B-D1	T838NC#06-32R2B-D1	6 - 32	56	7	21	4,0	3	DIN 371	2B
T838NF#06-40R2B-D1	T838NF#06-40R2B-D1	6 - 40	56	7	21	4,0	3	DIN 371	2B
T838NC#08-32R2B-D1	T838NC#08-32R2B-D1	8 - 32	63	7	21	4,5	3	DIN 371	2B
T838NF#08-36R2B-D1	T838NF#08-36R2B-D1	8 - 36	63	7	21	4,5	3	DIN 371	2B
T838NC#10-24R2B-D1	T838NC#10-24R2B-D1	10 - 24	70	8	25	6,0	3	DIN 371	2B
T838NF#10-32R2B-D1	T838NF#10-32R2B-D1	10 - 32	70	8	25	6,0	3	DIN 371	2B
T838NC#12-24R2B-D1	T838NC#12-24R2B-D1	12 - 24	80	10	30	6,0	3	DIN 371	2B
T838NF#12-28R2B-D1	T838NF#12-28R2B-D1	12 - 28	80	10	30	6,0	3	DIN 371	2B
T838NC02500-20R2B-D1	T838NC02500-20R2B-D1	1/4 - 20	80	10	29	7,0	3	DIN 371	2B
T838NC02500-20R2B-D6	T838NC02500-20R2B-D6	1/4 - 20	80	10	36	4,5	3	DIN 376	2B
T838NF02500-28R2B-D1	T838NF02500-28R2B-D1	1/4 - 28	80	10	29	7,0	3	DIN 371	2B
T838NF02500-28R2B-D4	T838NF02500-28R2B-D4	1/4 - 28	80	10	36	4,5	3	DIN 374	2B
T838NC03125-18R2B-D1	T838NC03125-18R2B-D1	5/16 - 18	90	13	37	8,0	3	DIN 371	2B
T838NC03125-18R2B-D6	T838NC03125-18R2B-D6	5/16 - 18	90	13	37	6,0	3	DIN 376	2B
T838NF03125-24R2B-D4	T838NF03125-24R2B-D4	5/16 - 24	90	13	37	6,0	3	DIN 374	2B
T838NC03750-16R2B-D1	T838NC03750-16R2B-D1	3/8 - 16	100	15	42	10,0	3	DIN 371	2B
T838NC03750-16R2B-D6	T838NC03750-16R2B-D6	3/8 - 16	100	15	45	7,0	3	DIN 376	2B
T838NF03750-24R2B-D4	T838NF03750-24R2B-D4	3/8 - 24	90	15	40	7,0	3	DIN 374	2B
T838NC04375-14R2B-D6	T838NC04375-14R2B-D6	7/16 - 14	100	15	47	8,0	3	DIN 376	2B
T838NF04375-20R2B-D4	T838NF04375-20R2B-D4	7/16 - 20	100	15	47	8,0	3	DIN 374	2B
T838NC05000-13R2B-D6	T838NC05000-13R2B-D6	1/2 - 13	110	18	50	9,0	3	DIN 376	2B
T838NF05000-20R2B-D4	T838NF05000-20R2B-D4	1/2 - 20	100	13	44	9,0	3	DIN 374	2B
T838NC05625-12R2B-D6	T838NC05625-12R2B-D6	9/16 - 12	110	20	55	11,0	4	DIN 376	2B
T838NF05625-18R2B-D4	T838NF05625-18R2B-D4	9/16 - 18	100	15	44	11,0	4	DIN 374	2B
T838NC06250-11R2B-D6	T838NC06250-11R2B-D6	5/8 - 11	110	20	55	12,0	4	DIN 376	2B
T838NF06250-18R2B-D4	T838NF06250-18R2B-D4	5/8 - 18	100	15	45	12,0	4	DIN 374	2B
T838NC07500-10R2B-D6	T838NC07500-10R2B-D6	3/4 - 10	125	25	65	14,0	4	DIN 376	2B
T838NF07500-16R2B-D4	T838NF07500-16R2B-D4	3/4 - 16	110	17	55	14,0	4	DIN 374	2B
T838NC08750-9R2B-D6	T838NC08750-9R2B-D6	7/8 - 9	140	25	68	18,0	4	DIN 376	2B
T838NF08750-14R2B-D4	T838NF08750-14R2B-D4	7/8 - 14	125	18	57	18,0	4	DIN 374	2B
T838NC10000-8R2B-D6	T838NC10000-8R2B-D6	1 - 8	160	30	89	18,0	4	DIN 376	2B
T838NF10000-12R2B-D4	T838NF10000-12R2B-D4	1 - 12	140	22	63	18,0	4	DIN 374	2B

(continued)

Multipurpose Taps

GOtap™ T838 Spiral-Flute HSS-E Taps • Blind Holes



(T838 • DIN 371, 374, and 376 • Form C Semi-Bottoming Chamfer • UNC/UNF • Tension/Compression Holders — continued)

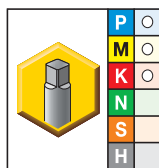
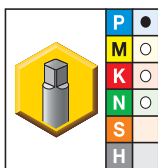

● first choice

○ alternate choice

		D1 size	L	L3	L2	D	number of flutes	dimension standard	class of fit
KSU31	KSP39								
T838NC11250-7R2B-D6	T838NC11250-7R2B-D6	1 1/8 - 7	180	35	90	22,0	4	DIN 376	2B
T838NF11250-12R2B-D4	T838NF11250-12R2B-D4	1 1/8 - 12	150	22	70	22,0	4	DIN 374	2B
T838NC12500-7R2B-D6	T838NC12500-7R2B-D6	1 1/4 - 7	180	35	95	22,0	4	DIN 376	2B
T838NF12500-12R2B-D4	T838NF12500-12R2B-D4	1 1/4 - 12	150	22	67	22,0	5	DIN 374	2B
T838NC13750-6R2B-D6	T838NC13750-6R2B-D6	1 3/8 - 6	200	40	100	28,0	4	DIN 376	2B
T838NF13750-12R2B-D4	T838NF13750-12R2B-D4	1 3/8 - 12	170	24	80	28,0	5	DIN 374	2B
T838NC15000-6R2B-D6	T838NC15000-6R2B-D6	1 1/2 - 6	200	40	100	28,0	4	DIN 376	2B
T838NF15000-12R2B-D4	T838NF15000-12R2B-D4	1 1/2 - 12	170	24	72	28,0	6	DIN 374	2B
T838NC17500-5R2B-D6	T838NC17500-5R2B-D6	1 3/4 - 5	220	50	108	36,0	5	DIN 376	2B
T838NC20000-4,5R2B-D6	T838NC20000-4,5R2B-D6	2 - 4 1/2	250	55	140	40,0	5	DIN 376	2B

NOTE: Suitable for tension/compression holders.

Shank Tolerance

D mm	tolerance h9
1-3	+0, -0,025
>3-6	+0, -0,030
>6-10	+0, -0,036
>10-18	+0, -0,043
>18-30	+0, -0,052

Tapping

• KSP39 oxide

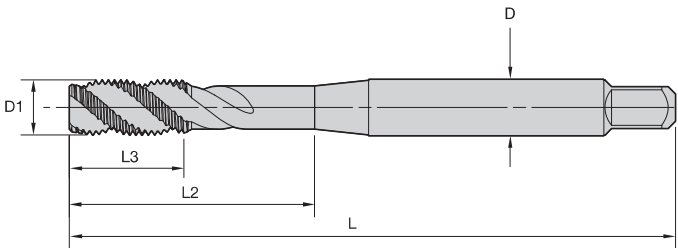

■ T830 • DIN 371 and 376 • Form C Semi-Bottoming Chamfer • UNJC/UNJF • Rigid and Synchronous Holders

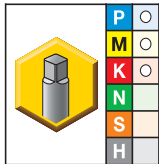

● first choice
 ○ alternate choice

KSP39	metric dimensions					number of flutes	dimension standard	class of fit
	D1 size	L	L3	L2	D			
T830NC#04-40R3B-D1	4 - 40	56	8	18	3,5	2	DIN 371	3B
T830NC#06-32R3B-D1	6 - 32	56	9	20	4,0	2	DIN 371	3B
T830NC#08-32R3B-D1	8 - 32	63	11	21	4,5	3	DIN 371	3B
T830NF#10-32R3B-D1	10 - 32	70	12	25	6,0	3	DIN 371	3B
T830NF02500-28R3B-D1	1/4 - 28	80	15	30	7,0	3	DIN 371	3B
T830NF03125-24R3B-D1	5/16 - 24	90	15	35	8,0	3	DIN 371	3B
T830NF03750-24R3B-D1	3/8 - 24	100	19	39	10,0	3	DIN 371	3B
T830NF04375-20R3B-D6	7/16 - 20	100	18	41	8,0	3	DIN 376	3B
T830NF05000-20R3B-D6	1/2 - 20	110	23	47	9,0	3	DIN 376	3B

NOTE: Internal UNJC/UNJF threads may be produced with ground thread UNC/UNF taps.

NOTE: Suggested for use in rigid and synchronous holders.

Shank Tolerance

D mm	tolerance h9
1-3	+0, -0,025
>3-6	+0, -0,030
>6-10	+0, -0,036
>10-18	+0, -0,043
>18-30	+0, -0,052



Multipurpose Taps

G0tap™ T830 Spiral-Flute HSS-E Taps • Blind Holes



- KSU31 TiN
- KSU30 bright

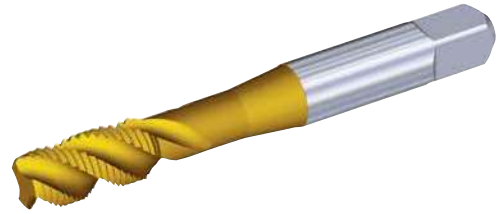
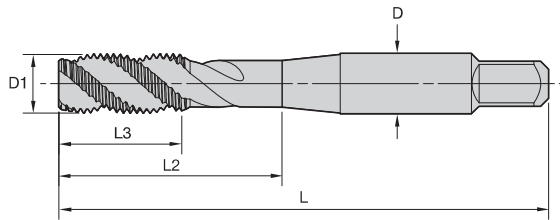

■ T830 • Form C Semi-Bottoming Chamfer • Metric • JIS • Rigid and Synchronous Holders

Tapping

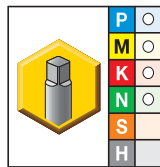
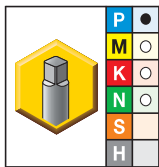

- first choice
- alternate choice

		metric dimensions					number of flutes	dimension standard	tap class
KSU31	KSU30	D1 size	L	L3	L2	D			
T830M030X050R6H-J	T830M030X050R6H-J	M3 X 0,5	46	11	19	4,0	2	JIS	ISO 2
T830M040X070R6H-J	T830M040X070R6H-J	M4 X 0,7	52	13	21	5,0	3	JIS	ISO 2
T830M050X080R6H-J	T830M050X080R6H-J	M5 X 0,8	60	16	24	5,5	3	JIS	ISO 2
T830M060X100R6H-J	T830M060X100R6H-J	M6 X 1	62	19	29	6,0	3	JIS	ISO 2
T830M080X125R6H-J	T830M080X125R6H-J	M8 X 1,25	70	22	37	6,2	3	JIS	ISO 2
T830M100X150R6H-J	T830M100X150R6H-J	M10 X 1,5	75	24	41	7,0	3	JIS	ISO 2
—	T830MF120X125R6H-J	M12 X 1,25	82	29	48	8,5	3	JIS	ISO 2
—	T830MF120X150R6H-J	M12 X 1,5	82	29	48	8,5	3	JIS	ISO 2
—	T830M120X175R6H-J	M12 X 1,75	82	29	48	8,5	3	JIS	ISO 2
—	T830MF140X150R6H-J	M14 X 1,5	88	30	48	10,5	3	JIS	ISO 2
—	T830M140X200R6H-J	M14 X 2	88	30	48	10,5	3	JIS	ISO 2
—	T830MF160X150R6H-J	M16 X 1,5	95	32	52	12,5	3	JIS	ISO 2
—	T830M160X200R6H-J	M16 X 2	95	32	52	12,5	3	JIS	ISO 2
—	T830M180X250R6H-J	M18 X 2,5	100	37	55	14,0	4	JIS	ISO 2
—	T830M200X250R6H-J	M20 X 2,5	105	37	60	15,0	4	JIS	ISO 2

NOTE: Suggested for use in rigid and synchronous holders.

Shank Tolerance

D mm	tolerance h9
1-3	+0, -0,025
>3-6	+0, -0,030
>6-10	+0, -0,036
>10-18	+0, -0,043
>18-30	+0, -0,052

Mobile App

The Kennametal mobile app makes it easy to access product information, calculators, and much more from iPhone® and Android™ devices.



FEATURES

Scan a Kennametal tool package barcode or search a product catalog number to access complete product information.

Product information includes tool image, dimensions, grades, and product highlights.

View product availability at global locations.

Get speed and feed information in inch and metric values for all metalcutting products.

View tech tips for helpful solutions to common machining questions.

Contact Customer Support directly from the app.

MACHING CALCULATORS

View data for milling and drilling applications.

Inch and metric values calculated.

ORDERING

Login using your Konnect credentials to complete a purchase.

WHERE TO FIND IT

Download the free app today from iTunes® or the Google Play™ store.



➤ Straight-Flute Taps

High-Performance Taps for Through-Hole and Blind-Hole Applications

- Cast iron.
- Cast aluminium.



High-Performance Beyond™ Solid Carbide Taps

- Straight-flute design for through- and blind-hole tapping in cast iron, cast aluminium, and hard steels.
- Runs up to 4x faster and 4x longer than conventional high-speed steel (HSS) taps.
- Ideal for long production runs where fewer tool changes result in greater productivity.
- For use on CNC machines with synchronous or rigid controls and precision toolholders.

High-Performance Beyond™ HSS-E-PM Taps

- Straight-flute design for through- and blind-hole tapping in cast iron and cast aluminium.
- Higher strength and wider range of applications versus solid carbide taps.
- Higher tapping speed capability and longer tool life than conventional HSS-E taps.
- Can be used on either conventional or synchronous tapping machines with rigid or synchronous tap holders.



High-Performance Taps

Beyond™ Solid Carbide Straight-Flute Taps • Through Holes



- KCK17 AICrTiN for cast iron.

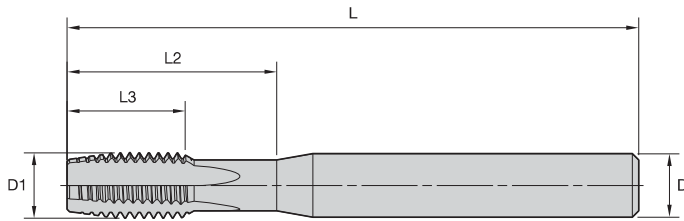

T340 • Form D Plug • Inch • Solid Carbide • For Cast Iron



Tapping

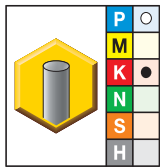

- first choice
- alternate choice

KCK17	D1 size	L	L3	L2	D	number of flutes	class of fit
T340NC#6-32R3BX	6 - 32	2.36	.28	.55	.2500	3	3BX
T340NC#8-32R3BX *	8 - 32	2.36	.28	.63	.2500	3	3BX
T340NC#10-24R3BX	10 - 24	2.36	.35	.79	.2500	3	3BX
T340NF#10-32R3BX	10 - 32	2.36	.35	.79	.2500	3	3BX
T340NC02500-20R3BX	1/4 - 20	2.76	.59	.94	.2500	4	3BX
T340NC03125-18R3BX	5/16 - 18	3.15	.67	1.26	.3125	4	3BX
T340NC03750-16R3BX	3/8 - 16	3.54	.75	1.57	.3750	4	3BX
T340NF03750-24R3BX	3/8 - 24	3.54	.75	1.57	.3750	4	3BX
T340NC05000-13R3BX	1/2 - 13	3.94	.94	1.89	.5000	4	3BX
T340NF05000-20R3BX	1/2 - 20	3.94	.94	1.89	.5000	4	3BX
T340NF05625-18R3BX	9/16 - 18	4.33	1.02	2.21	.5000	4	3BX

NOTE: *Made-to-order standard item. Standard pricing, manufacturing lead time, and minimum order quantity applies.

Shank Tolerance

D	tolerance h6
.250-.375	+0, -.0004
.438-.625	+0, -.0004

- KCK17 AlCrTiN for cast iron.

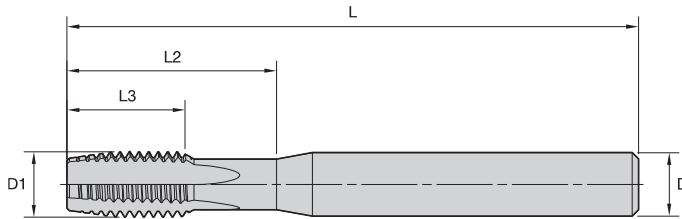

■ T340 • Form D Plug • Metric • Solid Carbide • For Cast Iron

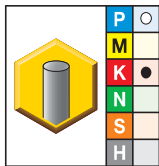

- first choice
- alternate choice

KCK17	D1 size	L	L3	L2	D	number of flutes	class of fit
T340M040X070R6HX	M4 X 0,7	60	6	16	6,0	3	6HX
T340M050X080R6HX	M5 X 0,8	60	7	20	6,0	3	6HX
T340M060X100R6HX	M6 X 1	70	12	24	6,0	4	6HX
T340M080X125R6HX	M8 X 1,25	80	15	32	8,0	4	6HX
T340MF100X100R6HX	M10 X 1	90	18	40	10,0	4	6HX
T340M100X150R6HX	M10 X 1,5	90	18	40	10,0	4	6HX
T340MF120X150R6HX	M12 X 1,5	100	21	48	12,0	4	6HX
T340M120X175R6HX	M12 X 1,75	100	21	48	12,0	4	6HX
T340MF140X150R6HX	M14 X 1,5	110	24	56	12,0	4	6HX
T340M140X200R6HX	M14 X 2	110	24	56	12,0	4	6HX
T340M160X200R6HX	M16 X 2	110	24	64	14,0	4	6HX
T340M200X250R6HX	M20 X 2,5	140	30	80	18,0	5	6HX

Shank Tolerance

D	tolerance h6
6	+0, -0,008
8-10	+0, -0,009
12-16	+0, -0,011



High-Performance Taps

Beyond™ Solid Carbide Straight-Flute Taps • Blind Holes



- KCK17 AICrTiN for cast iron.

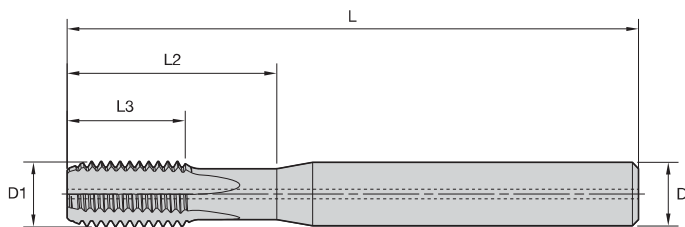

T351 • Form E Bottoming Chamfer • Through Coolant 1/4" and Larger • Inch • Solid Carbide • For Cast Iron

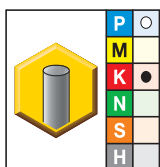

● first choice

○ alternate choice

KCK17	D1 size	L	L3	L2	D	number of flutes	class of fit
T351NC#6-32R3BX *	6 - 32	2.36	.28	.55	.2500	3	3BX
T351NC#8-32R3BX	8 - 32	2.36	.28	.63	.2500	3	3BX
T351NF#10-32R3BX *	10 - 32	2.36	.35	.79	.2500	3	3BX
T351NC02500-20R3BX	1/4 - 20	2.76	.59	.95	.2500	4	3BX
T351NC03125-18R3BX	5/16 - 18	3.15	.67	1.26	.3125	4	3BX
T351NC03750-16R3BX	3/8 - 16	3.54	.75	1.57	.3750	4	3BX
T351NC04375-14R3BX	7/16 - 14	3.94	.87	1.73	.4375	4	3BX
T351NC05000-13R3BX	1/2 - 13	3.94	.94	1.89	.5000	4	3BX
T351NC06250-11R3BX	5/8 - 11	4.33	1.10	2.52	.5625	5	3BX
T351NC07500-10R3BX	3/4 - 10	4.92	1.22	3.01	.6250	5	3BX

NOTE: *Made-to-order standard item. Standard pricing, manufacturing lead time, and minimum order quantity applies.

Shank Tolerance

D	tolerance h6
.250-.375	+0, -.0004
.438-.625	+0, -.0004

Tapping

- KCK17 AlCrTiN for cast iron.

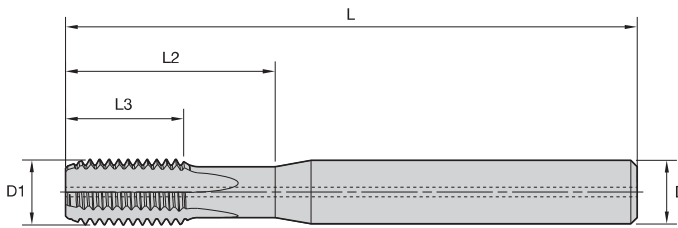

■ T351 • Form E Bottoming Chamfer • Through Coolant M6 and Larger • Metric • Solid Carbide • For Cast Iron

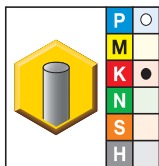

- first choice
- alternate choice

KCK17	D1 size	L	L3	L2	D	number of flutes	class of fit
T351M040X070R6HX *	M4 X 0,7	60	6	16	6,0	3	6HX
T351M050X080R6HX	M5 X 0,8	60	7	20	6,0	3	6HX
T351M060X100R6HX	M6 X 1	70	12	24	6,0	4	6HX
T351M080X125R6HX	M8 X 1,25	80	15	32	8,0	4	6HX
T351MF100X100R6HX	M10 X 1	90	18	40	10,0	4	6HX
T351M100X150R6HX	M10 X 1,5	90	18	40	10,0	4	6HX
T351MF120X150R6HX	M12 X 1,5	100	21	48	12,0	4	6HX
T351M120X175R6HX	M12 X 1,75	100	21	48	12,0	4	6HX
T351MF140X150R6HX	M14 X 1,5	110	24	56	12,0	4	6HX
T351M140X200R6HX	M14 X 2	110	24	56	12,0	4	6HX
T351M160X200R6HX	M16 X 2	110	24	64	14,0	4	6HX

NOTE: *Made-to-order standard item. Standard pricing, manufacturing lead time, and minimum order quantity applies.

Shank Tolerance

D	tolerance h6
6	+0, -0,008
8-10	+0, -0,009
12-16	+0, -0,011



High-Performance Taps

Beyond™ Solid Carbide Straight-Flute Taps • Blind Holes



• KCK17 AICrTiN for cast iron.

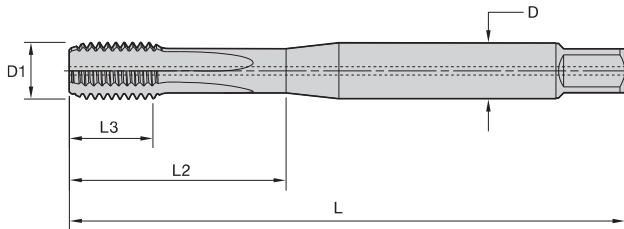
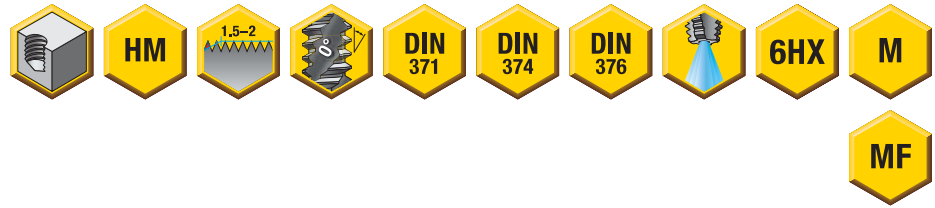

beyond

■ T351 • DIN 371, 374, and 376 • Form E Bottoming Chamfer • Through Coolant • Metric • Solid Carbide • For Cast Iron

Tapping

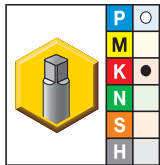

● first choice
○ alternate choice

KCK17	D1 size	L	L3	L2	D	number of flutes	dimension standard	class of fit
T351M060X100R6HX-D1	M6 X 1	80	10	30	6,0	4	DIN 371	6HX
T351M070X100R6HX-D1	M7 X 1	80	10	30	7,0	4	DIN 371	6HX
T351M080X125R6HX-D1	M8 X 1,25	90	13	35	8,0	4	DIN 371	6HX
T351M090X125R6HX-D1	M9 X 1,25	90	13	35	9,0	4	DIN 371	6HX
T351MF100X100R6HX-D4	M10 X 1	90	10	35	7,0	4	DIN 374	6HX
T351MF100X125R6HX-D4	M10 X 1,25	100	15	39	7,0	4	DIN 374	6HX
T351M100X150R6HX-D1	M10 X 1,5	100	15	39	10,0	4	DIN 371	6HX
T351MF120X125R6HX-D4	M12 X 1,25	100	15	39	9,0	4	DIN 374	6HX
T351MF120X150R6HX-D4	M12 X 1,50	100	15	39	9,0	4	DIN 374	6HX
T351M120X175R6HX-D6	M12 X 1,75	110	18	44	9,0	4	DIN 376	6HX
T351MF140X125R6HX-D4	M14 X 1,25	100	15	47	11,0	4	DIN 374	6HX
T351MF140X150R6HX-D4	M14 X 1,5	100	15	47	11,0	4	DIN 374	6HX
T351M140X200RHX-D6	M14 X 2	110	20	52	11,0	4	DIN 376	6HX

Shank Tolerance

D	tolerance h6
3-6	+0, -0,008
>6-10	+0, -0,009
>10-18	+0, -0,011
>18-30	+0, -0,013
>30-50	+0, -0,016

- KCK17 AlCrTiN for cast iron.

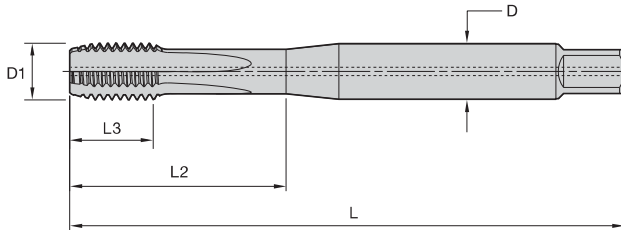

- T353 • DIN 371 and 376 • Form C Semi-Bottoming Chamfer • Through Coolant M6 and Larger • Metric • Solid Carbide • For Cast Iron

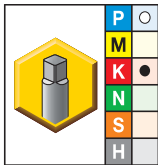

- first choice
- alternate choice

KCK17	D1 size	L	L3	L2	D	number of flutes	dimension standard	class of fit
T353M040X070R6HX-D1	M4 X 0,7	63	10	21	4,5	3	DIN 371	6HX
T353M050X080R6HX-D1	M5 X 0,8	70	10	25	6,0	3	DIN 371	6HX
T353M060X100R6HX-D1	M6 X 1	80	10	30	6,0	4	DIN 371	6HX
T353M080X125R6HX-D1	M8 X 1,25	90	13	35	8,0	4	DIN 371	6HX
T353M100X150R6HX-D1	M10 X 1,5	100	15	39	10,0	4	DIN 371	6HX
T353M120X175R6HX-D6	M12 X 1,75	110	18	44	9,0	4	DIN 376	6HX
T353M140X200R6HX-D6	M14 X 2	110	20	52	11,0	4	DIN 376	6HX

Shank Tolerance

D	tolerance h6
3-6	+0, -0,008
>6-10	+0, -0,009
>10-18	+0, -0,011
>18-30	+0, -0,013
>30-50	+0, -0,016



High-Performance Taps

Beyond™ Solid Carbide Straight-Flute Taps • Blind Holes



- KCN14 TiN + CrC/C for aluminium.

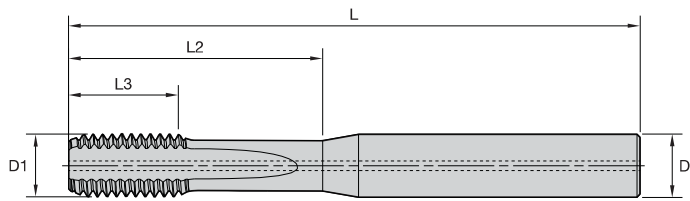

T471 • Form E Bottoming Chamfer • Through Coolant • Metric • Solid Carbide • For Aluminium

Tapping

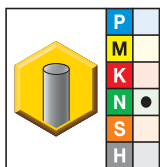

- first choice
- alternate choice

KCN14	D1 size	L	L3	L2	D	number of flutes	class of fit
T471M060X100R6HX	M6 X 1	70	12	24	6,0	3	6HX
T471M080X125R6HX	M8 X 1,25	80	15	32	8,0	3	6HX
T471M100X150R6HX	M10 X 1,5	90	18	40	10,0	3	6HX
T471M120X175R6HX	M12 X 1,75	100	21	48	12,0	3	6HX
T471M140X200R6HX	M14 X 2	110	24	56	12,0	4	6HX

Shank Tolerance

D	tolerance h6
6	+0, -0,008
8-10	+0, -0,009
12-16	+0, -0,011

- KCN14 TiN + CrC/C for aluminium.

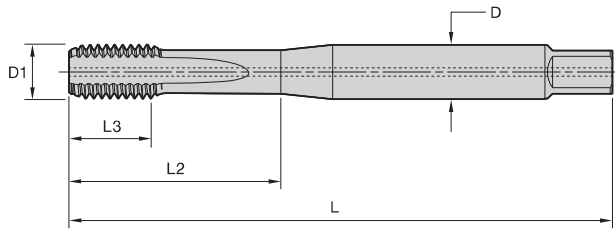

- T471 • DIN 371 • Form E Bottoming Chamfer • Through Coolant • Metric • Solid Carbide • For Aluminium

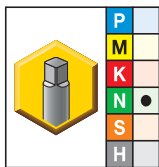

- first choice
- alternate choice

KCN14	D1 size	L	L3	L2	D	number of flutes	dimension standard	class of fit
T471M060X100R6HX-D1	M6 X 1	80	10	30	6,0	3	DIN 371	6HX
T471M080X125R6HX-D1	M8 X 1,25	90	10	35	8,0	3	DIN 371	6HX
T471M100X150R6HX-D1	M10 X 1,5	100	15	39	10,0	3	DIN 371	6HX

Shank Tolerance

D	tolerance h6
3-6	+0, -0,008
>6-10	+0, -0,009
>10-18	+0, -0,011
>18-30	+0, -0,013
>30-50	+0, -0,016



High-Performance Taps

Beyond™ Solid Carbide Straight-Flute Taps • Blind and Through Holes



- KCU36 TiAlN/MoS₂ for tapping steel 55–63 HRC.

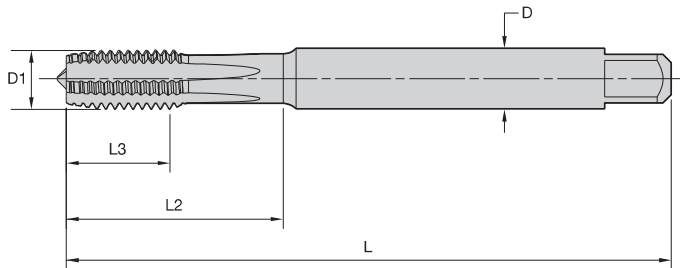
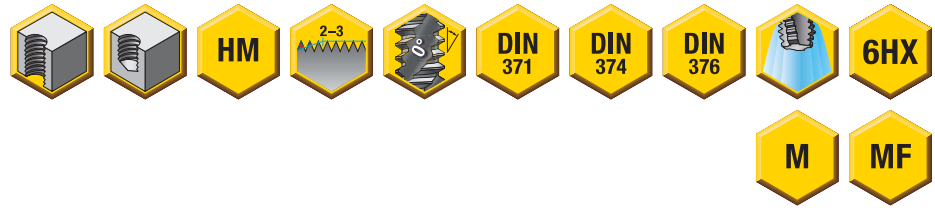

T410 • DIN 371, 374, and 376 • Form C Semi-Bottoming Chamfer • Metric • Solid Carbide • For Hard Steel

Tapping

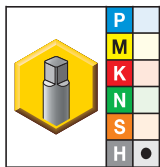

- first choice
- alternate choice

KCU36	D1 size	L	L3	L2	D	number of flutes	dimension standard	class of fit
T410M030X050R6HX-D1	M3 X 0,5	63	6	18	4,5	4	DIN 371	6HX
T410M040X070R6HX-D1	M4 X 0,7	63	8	20	4,5	4	DIN 371	6HX
T410M050X080R6HX-D1	M5 X 0,8	70	10	26	6,0	4	DIN 371	6HX
T410M060X100R6HX-D1	M6 X 1	80	12	28	6,0	4	DIN 371	6HX
T410MF080X100R6HX-D4 *	M8 X 1	90	15	35	8,0	5	DIN 374	6HX
T410M080X125R6HX-D1	M8 X 1,25	90	15	35	8,0	5	DIN 371	6HX
T410MF100X100R6HX-D4 *	M10 X 1	100	18	38	10,0	5	DIN 374	6HX
T410M100X150R6HX-D1	M10 X 1,5	100	18	38	10,0	5	DIN 371	6HX
T410MF120X150R6HX-D4	M12 X 1,5	110	21	41	12,0	5	DIN 374	6HX
T410M120X175R6HX-D6	M12 X 1,75	110	21	41	12,0	5	DIN 376	6HX
T410MF140X150R6HX-D4	M14 X 1,5	110	24	44	14,0	5	DIN 374	6HX
T410M140X200R6HX-D6	M14 X 2	110	24	44	14,0	6	DIN 376	6HX
T410MF160X150R6HX-D4	M16 X 1,5	110	24	44	16,0	5	DIN 374	6HX

NOTE: *Made-to-order standard item. Standard pricing, manufacturing lead time, and minimum order quantity applies.

Shank Tolerance

D	tolerance h9
1–3	+0, -0,025
3,5–6	+0, -0,030
7–10	+0, -0,036
11–18	+0, -0,043

- KP6525 TiCN + TiN for cast iron and cast aluminium.

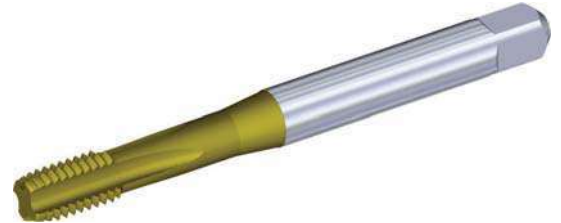
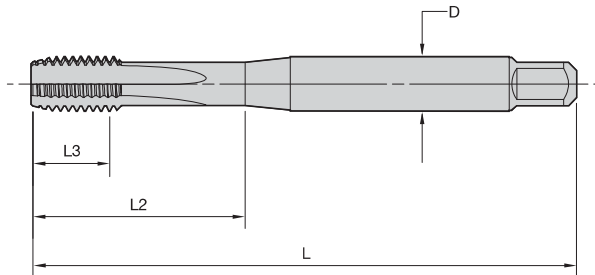
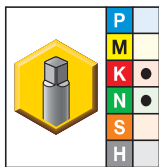
T640 • DIN 371 and 376 • Form C Semi-Bottoming Chamfer • Metric • For Cast Iron and Cast Aluminium

- first choice
- alternate choice

KP6525	D1 size	L	L3	L2	D	number of flutes	dimension standard	class of fit
T640M040X070R6HX-D1	M4 X 0,7	63	10	21	4,5	3	DIN 371	6HX
T640M050X080R6HX-D1	M5 X 0,8	70	10	25	6,0	3	DIN 371	6HX
T640M060X100R6HX-D1	M6 X 1	80	10	30	6,0	4	DIN 371	6HX
T640M080X125R6HX-D1	M8 X 1,25	90	13	35	8,0	4	DIN 371	6HX
T640M100X150R6HX-D1	M10 X 1,5	100	15	39	10,0	4	DIN 371	6HX
T640M120X175R6HX-D6	M12 X 1,75	110	18	44	9,0	4	DIN 376	6HX
T640M140X200R6HX-D6	M14 X 2	110	20	52	11,0	4	DIN 376	6HX
T640M160X200R6HX-D6	M16 X 2	110	20	51	12,0	4	DIN 376	6HX
T640M180X250R6HX-D6	M18 X 2,5	125	25	58	14,0	4	DIN 376	6HX
T640M200X250R6HX-D6	M20 X 2,5	140	25	64	16,0	4	DIN 376	6HX
T640M220X250R6HX-D6	M22 X 2,5	140	25	70	18,0	4	DIN 376	6HX

Shank Tolerance

D	tolerance h6
6	+0, -0,008
8-10	+0, -0,009
12-16	+0, -0,011



- KP6525 TiCN + TiN for cast iron and cast aluminium.

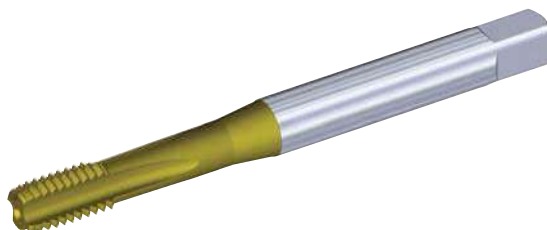
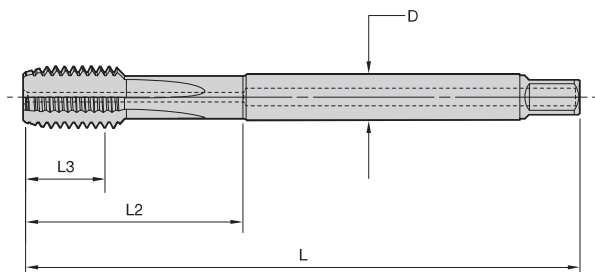

T641 • DIN 371 and 376 • Form C Semi-Bottoming Chamfer • Through Coolant • Metric • For Cast Iron and Cast Aluminium

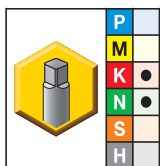

- first choice
- alternate choice

KP6525	D1 size	L	L3	L2	D	number of flutes	dimension standard	class of fit
T641M050X080R6HX-D1	M5 X 0,8	70	10	25	6,0	3	DIN 371	6HX
T641M060X100R6HX-D1	M6 X 1	80	10	30	6,0	4	DIN 371	6HX
T641M080X125R6HX-D1	M8 X 1,25	90	13	35	8,0	4	DIN 371	6HX
T641M100X150R6HX-D1	M10 X 1,5	100	15	39	10,0	4	DIN 371	6HX
T641M120X175R6HX-D6	M12 X 1,75	110	18	44	9,0	4	DIN 376	6HX
T641M140X200R6HX-D6	M14 X 2	110	20	52	11,0	4	DIN 376	6HX
T641M160X200R6HX-D6	M16 X 2	110	20	51	12,0	4	DIN 376	6HX
T641M180X250R6HX-D6	M18 X 2,5	125	25	58	14,0	4	DIN 376	6HX
T641M200X250R6HX-D6	M20 X 2,5	140	25	64	16,0	4	DIN 376	6HX

Shank Tolerance

D	tolerance h6
6	+0, -0,008
8-10	+0, -0,009
12-16	+0, -0,011

Tapping

- KP6525 TiCN + TiN for cast iron and cast silicon aluminium.

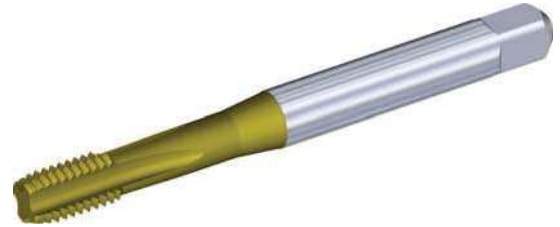
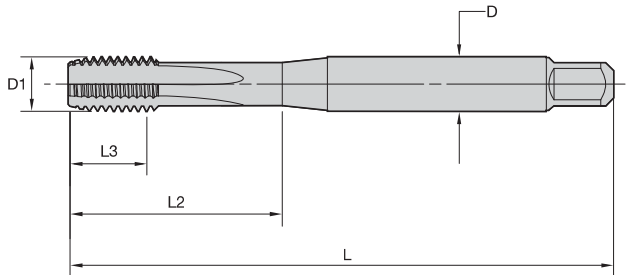

■ T642 • DIN 371, 374, and 376 • Form E Bottoming Chamfer • Metric • For Cast Iron and Cast Silicon Aluminium

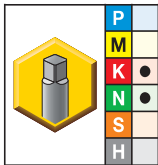

- first choice
- alternate choice

KP6525	D1 size	L	L3	L2	D	number of flutes	dimension standard	class of fit
T642M050X080R6HX-D1	M5 X 0,8	70	10	25	6,0	3	DIN 371	6HX
T642M060X100R6HX-D1	M6 X 1	80	10	30	6,0	4	DIN 371	6HX
T642M080X125R6HX-D1	M8 X 1,25	90	13	35	8,0	4	DIN 371	6HX
T642M100X150R6HX-D1	M10 X 1,5	100	15	39	10,0	4	DIN 371	6HX
T642MF120X150R6HX-D4	M12 X 1,5	100	15	39	9,0	4	DIN 374	6HX
T642M120X175R6HX-D6	M12 X 1,75	110	18	44	9,0	4	DIN 376	6HX
T642MF140X150R6HX-D4	M14 X 1,5	100	15	47	11,0	4	DIN 374	6HX
T642M140X200R6HX-D6	M14 X 2	110	20	52	11,0	4	DIN 376	6HX
T642MF160X150R6HX-D4	M16 X 1,5	100	15	46	12,0	4	DIN 374	6HX

Shank Tolerance

D	tolerance h6
6	+0, -0,008
8-10	+0, -0,009
12-16	+0, -0,011



Tapping

High-Performance Taps

Beyond™ Straight-Flute HSS-E-PM Taps • Threading Close to the Bottom in Blind Holes



- KP6525 TiCN + TiN for tapping cast iron and cast silicon aluminium.

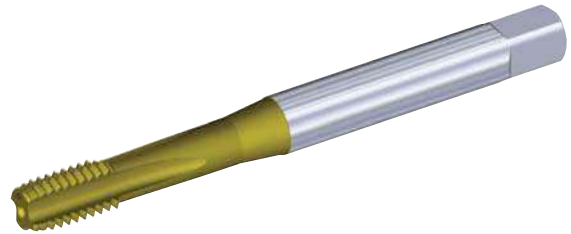
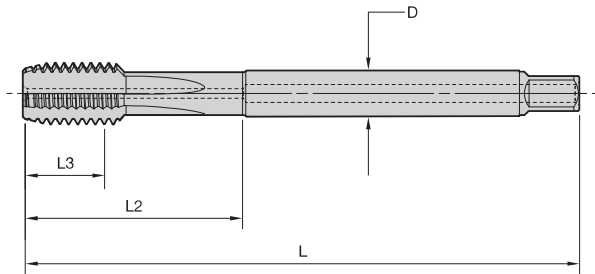
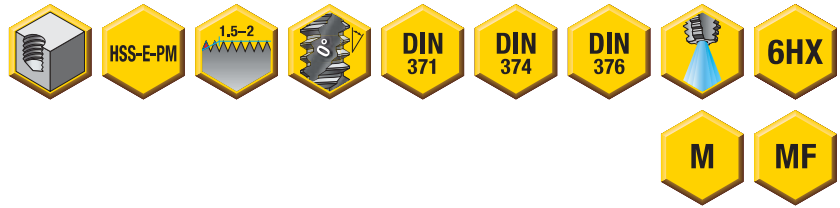

■ T643 • DIN 371, 374, and 376 • Form E Bottoming Chamfer • Through Coolant • Metric • For Cast Iron and Cast Silicon Aluminium

Tapping

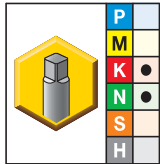

- first choice
- alternate choice

KP6525	D1 size	L	L3	L2	D	number of flutes	dimension standard	class of fit
T643M050X080R6HX-D1	M5 X 0,8	70	10	25	6,0	3	DIN 371	6HX
T643M060X100R6HX-D1	M6 X 1	80	10	30	6,0	4	DIN 371	6HX
T643M080X125R6HX-D1	M8 X 1,25	90	13	35	8,0	4	DIN 371	6HX
T643M100X150R6HX-D1	M10 X 1,5	100	15	39	10,0	4	DIN 371	6HX
T643MF120X150R6HX-D4	M12 X 1,5	100	15	39	9,0	4	DIN 374	6HX
T643M120X175R6HX-D6	M12 X 1,75	110	18	44	9,0	4	DIN 376	6HX
T643MF140X150R6HX-D4	M14 X 1,5	100	15	47	11,0	4	DIN 374	6HX
T643M140X200R6HX-D6	M14 X 2	110	20	52	11,0	4	DIN 376	6HX
T643MF160X150R6HX-D4	M16 X 1,5	100	15	46	12,0	4	DIN 374	6HX

Shank Tolerance

D	tolerance h6
6	+0, -0,008
8-10	+0, -0,009
12-16	+0, -0,011

- KP6525 TiCN + TiN for cast iron and cast aluminium.

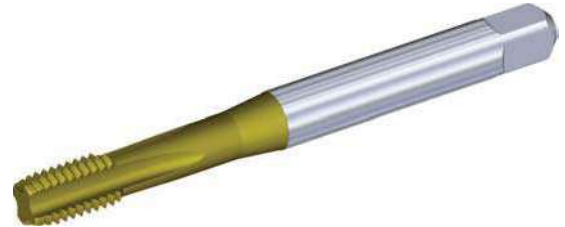
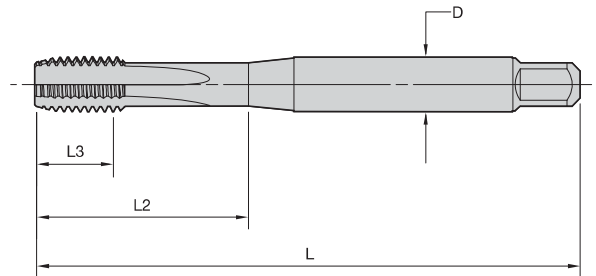
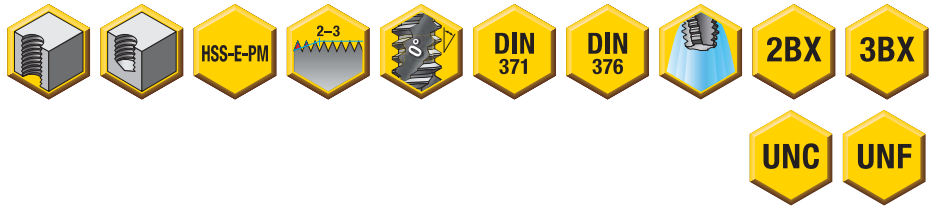

■ **T640 • DIN 371 and 376 • Form C Semi-Bottoming Chamfer • Machine Screw and Fractional • For Cast Iron and Cast Aluminium**

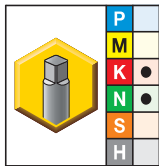

- first choice
- alternate choice

KP6525	D1 size	L	L3	L2	D	number of flutes	dimension standard	class of fit
T640NC#06-32R2BX-D1	6 - 32	56	9	20	4,0	3	DIN 371	2BX
T640NF#06-40R2BX-D1 *	6 - 40	56	9	20	4,0	3	DIN 371	2BX
T640NC#08-32R2BX-D1	8 - 32	63	10	21	4,5	3	DIN 371	2BX
T640NC#10-24R2BX-D1	10 - 24	70	10	25	6,0	3	DIN 371	2BX
T640NF#10-32R2BX-D1	10 - 32	70	10	25	6,0	3	DIN 371	2BX
T640NC02500-20R3BX-D1	1/4 - 20	80	13	30	7,0	4	DIN 371	3BX
T640NF02500-28R3BX-D1	1/4 - 28	80	13	30	7,0	4	DIN 371	3BX
T640NC03125-18R3BX-D1	5/16 - 18	90	13	35	8,0	4	DIN 371	3BX
T640NF03125-24R3BX-D1	5/16 - 24	90	13	35	8,0	4	DIN 371	3BX
T640NC03750-16R3BX-D1	3/8 - 16	100	16	39	10,0	4	DIN 371	3BX
T640NF03750-24R3BX-D1	3/8 - 24	100	16	39	10,0	4	DIN 371	3BX
T640NC04375-14R3BX-D6	7/16 - 14	100	15	41	8,0	4	DIN 376	3BX
T640NF04375-20R3BX-D6	7/16 - 20	100	15	41	8,0	4	DIN 376	3BX
T640NC05000-13R3BX-D6	1/2 - 13	110	20	47	9,0	4	DIN 376	3BX
T640NF05000-20R3BX-D6	1/2 - 20	110	20	47	9,0	4	DIN 376	3BX

NOTE: *Made-to-order standard item. Standard pricing, manufacturing lead time, and minimum order quantity applies.

Shank Tolerance

D fractional	tolerance h6
>3-6	+0, -0,008
>6-10	+0, -0,009
<10-18	+0, -0,011

- KP6525 TiCN + TiN for cast iron and cast aluminium.

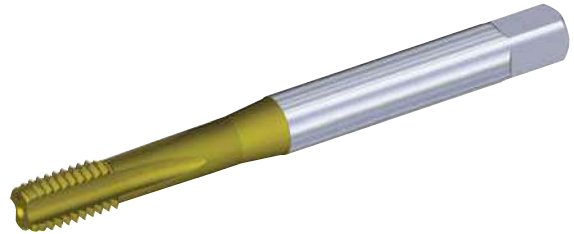
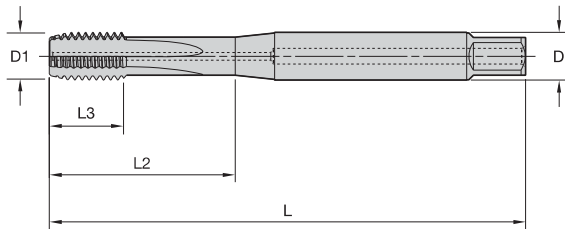

T641 • DIN 371 and 376 • Form C Semi-Bottoming Chamfer • Through Coolant • Fractional • For Cast Iron and Cast Aluminium

Tapping

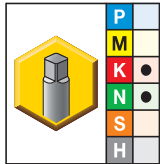

- first choice
- alternate choice

KP6525	D1 size	L	L3	L2	D	number of flutes	dimension standard	class of fit
T641NC02500-20R3BX-D1	1/4 - 20	80	13	30	7,0	4	DIN 371	3BX
T641NF02500-28R3BX-D1	1/4 - 28	80	13	30	7,0	4	DIN 371	3BX
T641NC03125-18R3BX-D1	5/16 - 18	90	13	35	8,0	4	DIN 371	3BX
T641NF03125-24R3BX-D1	5/16 - 24	90	13	35	8,0	4	DIN 371	3BX
T641NC03750-16R3BX-D1	3/8 - 16	100	16	39	10,0	4	DIN 371	3BX
T641NF03750-24R3BX-D1	3/8 - 24	100	16	39	10,0	4	DIN 371	3BX
T641NC04375-14R3BX-D6	7/16 - 14	100	15	41	8,0	4	DIN 376	3BX
T641NF04375-20R3BX-D6	7/16 - 20	100	15	41	8,0	4	DIN 376	3BX
T641NC05000-13R3BX-D6	1/2 - 13	110	20	47	9,0	4	DIN 376	3BX
T641NF05000-20R3BX-D6	1/2 - 20	110	20	47	9,0	4	DIN 376	3BX

Shank Tolerance

D fractional	tolerance h6
>3-6	+0, -0,008
>6-10	+0, -0,009
<10-18	+0, -0,011

Kennametal on the Web

kennametal.com

FIND THE LATEST PRODUCT INFORMATION

Whether your operation is turning, milling, or holemaking, Kennametal brands are the high-performance tooling you need. We offer standard and custom solutions for a wide range of applications.

Find information about our most current campaigns and catalogs.

Register on Konnect for the full functionality of the Kennametal online ordering website.



CONTACT US

Our customers are important to us. We want to provide you the best customer service in the industry. If you have a comment or question, please send it to us. We strive to respond to all inquiries within 24 hours.

FIND A LOCAL AUTHORISED DISTRIBUTOR IN YOUR AREA

Kennametal offers world-class products and services globally. Our distributors know us, and more importantly, they know you. They know better than anyone in the industry how to put the global power of Kennametal to work for you — in your industry, in your region, and for your business.

➤ Forming Taps



High-Performance Forming Taps for Through-Hole and Blind-Hole Applications

- Steel and steel alloys.
- Aluminium.

High-Performance Beyond™ Solid Carbide Taps

- Grade and geometry optimised for form tapping blind holes in aluminium.
- Runs up to 4x faster and 4x longer than conventional HSS taps.
- Ideal for long production runs where fewer tool changes result in greater productivity.
- For use on CNC machines with synchronous or rigid controls and precision toolholders.

High-Performance Beyond HSS-E-PM Taps

- High-performance forming taps for through- and blind-hole applications in steel, stainless steel, and aluminium.
- Higher strength and wider range of applications versus solid carbide taps.
- Higher tapping speed capability and longer tool life than conventional HSS-E taps.
- Can be used on either conventional or synchronous tapping machines.



• KCN14 TiN + CrC/C for aluminium.

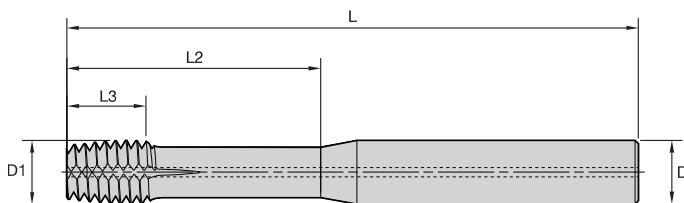

■ T491 • Form E Bottoming Entry Taper • Through Coolant M6 and Larger • Metric • Solid Carbide • For Aluminium

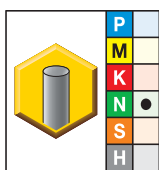

● first choice
○ alternate choice

Tapping

KCN14	D1 size	L	L3	L2	D	number of lube grooves	class of fit
T491M050X080R6HX	M5 X 0,8	60	7	20	6,0	2	6HX
T491M060X100R6HX	M6 X 1	70	8	24	6,0	2	6HX
T491M080X125R6HX	M8 X 1,25	80	10	32	8,0	2	6HX
T491M100X150R6HX	M10 X 1,5	90	12	40	10,0	3	6HX
T491M120X175R6HX	M12 X 1,75	100	14	48	12,0	3	6HX

Shank Tolerance

D	tolerance h6
6	+0, -0,008
8-10	+0, -0,009
12-16	+0, -0,011

• KCN14 TiN + CrC/C for aluminium.

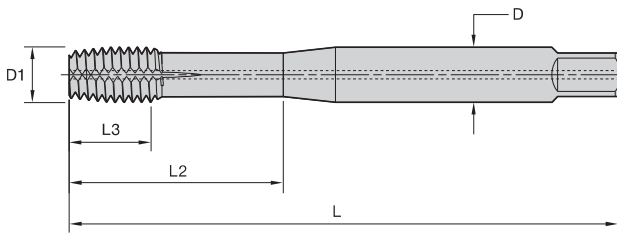

■ T491 • DIN 2174 • Form E Bottoming Chamfer • Through Coolant • Metric • Solid Carbide • For Aluminium

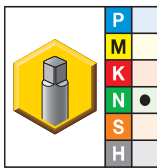

● first choice
○ alternate choice

KCN14	D1 size	L	L3	L2	D	number of lube grooves	dimension standard	class of fit
T491M060X100R6HX-D74	M6 X 1	80	10	30	6,0	2	DIN 2174	6HX
T491M080X125R6HX-D74	M8 X 1,25	90	13	35	8,0	2	DIN 2174	6HX
T491M100X150R6HX-D74	M10 X 1,5	100	15	39	10,0	3	DIN 2174	6HX

Shank Tolerance

D	tolerance h6
3-6	+0, -0,008
>6-10	+0, -0,009
>10-18	+0, -0,011
>18-30	+0, -0,013
>30-50	+0, -0,016



- KSP21 TiN for tapping steel.
- KSN28 DLC for tapping aluminium.

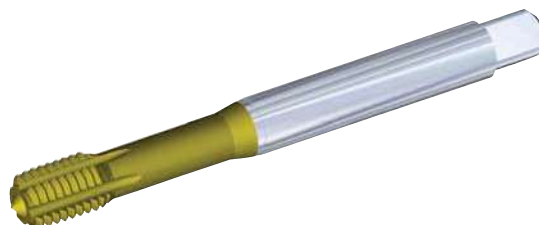
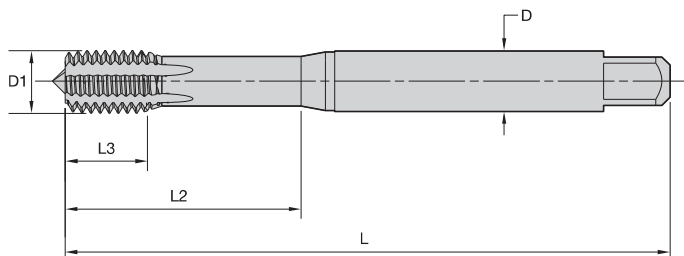

T622 • DIN 2174 • Form C Semi-Bottoming Entry Taper • Metric • For Steel and Aluminium

Tapping

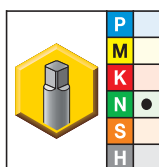
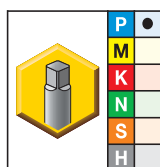

- first choice
- alternate choice

		D1 size	L	L3	L2	D	number of lube grooves	dimension standard	class of fit
KSP21	KSN28								
T622M030X050R6HX-D74	T622M030X050R6HX-D74	M3 X 0,5	56	6	18	3,5	4	DIN 2174	6HX
T622M040X070R6HX-D74	T622M040X070R6HX-D74	M4 X 0,7	63	7	21	4,5	4	DIN 2174	6HX
T622M050X080R6HX-D74	T622M050X080R6HX-D74	M5 X 0,8	70	8	25	6,0	4	DIN 2174	6HX
T622M060X100R6HX-D74	T622M060X100R6HX-D74	M6 X 1	80	10	30	6,0	5	DIN 2174	6HX
T622MF080X100R6HX-D74	T622MF080X100R6HX-D74	M8 X 1	90	10	35	8,0	5	DIN 2174	6HX
T622M080X125R6HX-D74	T622M080X125R6HX-D74	M8 X 1,25	90	14	35	8,0	5	DIN 2174	6HX
T622MF100X100R6HX-D74	T622MF100X100R6HX-D74 *	M10 X 1	90	10	35	10,0	5	DIN 2174	6HX
T622MF100X125R6HX-D74	T622MF100X125R6HX-D74	M10 X 1,25	100	16	39	10,0	5	DIN 2174	6HX
T622M100X150R6HX-D74	T622M100X150R6HX-D74	M10 X 1,5	100	16	39	10,0	5	DIN 2174	6HX
T622MF120X125R6HX-D74	T622MF120X125R6HX-D74	M12 X 1,25	100	15	39	9,0	6	DIN 2174	6HX
T622MF120X150R6HX-D74	T622MF120X150R6HX-D74	M12 X 1,5	100	15	39	9,0	6	DIN 2174	6HX
T622M120X175R6HX-D74	T622M120X175R6HX-D74	M12 X 1,75	110	18	44	9,0	6	DIN 2174	6HX
T622MF140X150R6HX-D74	T622MF140X150R6HX-D74	M14 X 1,5	100	15	47	11,0	6	DIN 2174	6HX
T622MF160X150R6HX-D74	T622MF160X150R6HX-D74	M16 X 1,5	100	15	46	12,0	6	DIN 2174	6HX
T622M160X200R6HX-D74	T622M160X200R6HX-D74	M16 X 2	110	22	51	12,0	6	DIN 2174	6HX

NOTE: *Made-to-order standard item. Standard pricing, manufacturing lead time, and minimum order quantity applies.

Shank Tolerance

D	tolerance h9
1-3	+0, -0,025
3,5-6	+0, -0,030
7-10	+0, -0,036
11-18	+0, -0,043

- KSP21 TiN for tapping steel.
- KSN28 DLC for tapping aluminium.

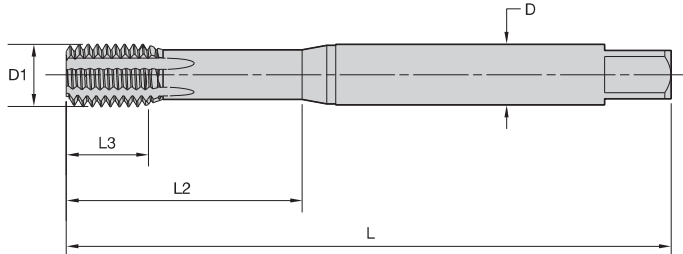

T623 • DIN 2174 • Form C Semi-Bottoming Entry Taper • Through Coolant • Metric • For Steel and Aluminium

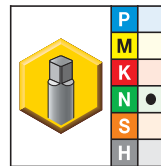
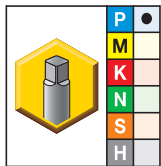

- first choice
- alternate choice

KSP21	KSN28	D1 size	L	L3	L2	D	number of lube grooves	dimension standard	class of fit
T623M050X080R6HX-D74	T623M050X080R6HX-D74	M5 X 0,8	70	8	25	6,0	4	DIN 2174	6HX
T623M060X100R6HX-D74	T623M060X100R6HX-D74	M6 X 1	80	10	30	6,0	5	DIN 2174	6HX
T623MF080X100R6HX-D74	T623MF080X100R6HX-D74 *	M8 X 1	90	10	35	8,0	5	DIN 2174	6HX
T623M080X125R6HX-D74	T623M080X125R6HX-D74	M8 X 1,25	90	14	35	8,0	5	DIN 2174	6HX
T623MF100X100R6HX-D74	T623MF100X100R6HX-D74	M10 X 1	90	10	35	10,0	5	DIN 2174	6HX
T623M100X150R6HX-D74	T623M100X150R6HX-D74	M10 X 1,5	100	16	39	10,0	5	DIN 2174	6HX
T623MF120X150R6HX-D74	T623MF120X150R6HX-D74	M12 X 1,5	100	15	27	9,0	6	DIN 2174	6HX
T623M120X175R6HX-D74	T623M120X175R6HX-D74	M12 X 1,75	110	18	30	9,0	6	DIN 2174	6HX
T623MF140X150R6HX-D74	T623MF140X150R6HX-D74	M14 X 1,5	100	15	29	11,0	6	DIN 2174	6HX
T623MF160X150R6HX-D74	T623MF160X150R6HX-D74	M16 X 1,5	100	15	31	12,0	6	DIN 2174	6HX
T623M160X200R6HX-D74	T623M160X200R6HX-D74	M16 X 2	110	22	38	12,0	6	DIN 2174	6HX

NOTE: *Made-to-order standard item. Standard pricing, manufacturing lead time, and minimum order quantity applies.

Shank Tolerance

D	tolerance h9
1-3	+0, -0,025
3,5-6	+0, -0,030
7-10	+0, -0,036
11-18	+0, -0,043

➤ Pipe Taps



High-Performance Pipe Taps for Through-Hole and Blind-Hole Applications

- Steel and steel alloys.
- Aluminium.

Multipurpose HSS-E GOtap™ Taps

- NPT and NPTF taper pipe taps with standard projections and standard chamfers for ductile materials and mould steels.
- DIN EN ISO 228 G straight pipe taps with Whitworth thread form for ductile materials.
- Manufactured with high-vanadium HSS-E material for exceptional wear characteristics and longer tool life.
- Advanced PVD coatings to reduce tapping torque, resulting in high-quality thread finish and longer tool life.
- For use in both synchronous and non-synchronous machines, including rigid, synchronous, and tension/compression tap holders.



Multipurpose Taps

G0tap™ Spiral-Point HSS-E ISO Pipe Taps • Through Holes



- KSU31 TiN
- KSP39 oxide

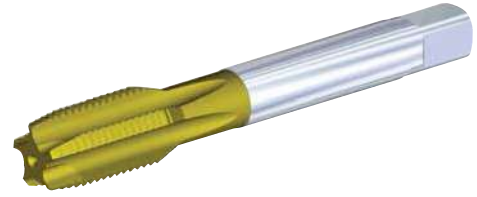
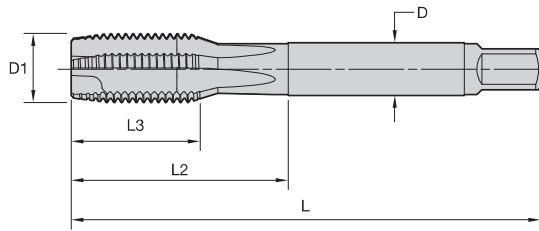

■ T877 • (G) Whitworth Pipe Thread • DIN EN ISO 228 • Form B

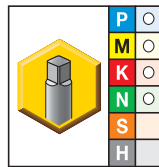
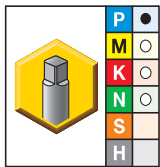

- first choice
- alternate choice

	KSU31	KSP39	D1 size	L	L3	L2	D	number of flutes	thread type
	T877G01250-28R-D56	T877G01250-28R-D56	1/8 - 28	90	15	35	7	3	G
	T877G02500-19R-D56	T877G02500-19R-D56	1/4 - 19	100	22	44	11	3	G
	T877G03750-19R-D56	T877G03750-19R-D56	3/8 - 19	100	22	47	12	4	G
	T877G05000-14R-D56	T877G05000-14R-D56	1/2 - 14	125	25	55	16	4	G
	T877G06250-14R-D56	T877G06250-14R-D56	5/8 - 14	125	25	61	18	4	G
	T877G07500-14R-D56	T877G07500-14R-D56	3/4 - 14	140	25	60	20	4	G
	T877G08750-14R-D56	T877G08750-14R-D56	7/8 - 14	150	28	68	22	4	G
	T877G10000-11R-D56	T877G10000-11R-D56	1 - 11	160	30	68	25	5	G

Tapping

G0tap™ Spiral-Flute HSS-E ISO Pipe Taps • Blind Holes

- KSU31 TiN
- KSP39 oxide

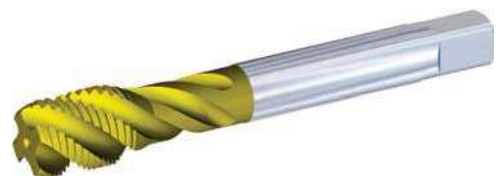
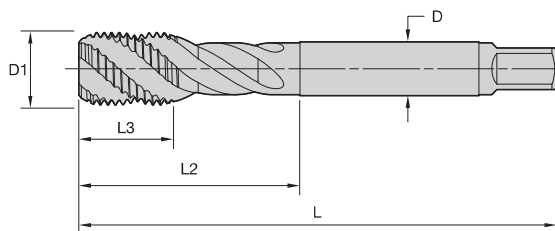

■ T857 • (G) Whitworth Pipe Thread • DIN EN ISO 228 • Form C • Tension/Compression Holders

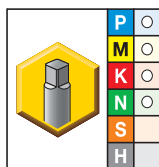
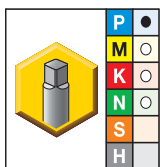

- first choice
- alternate choice

	KSU31	KSP39	D1 size	L	L3	L2	D	number of flutes	thread type
	T857G01250-28R-D56	T857G01250-28R-D56	1/8 - 28	90	15	37	7	3	G
	T857G02500-19R-D56	T857G02500-19R-D56	1/4 - 19	100	15	44	11	3	G
	T857G03750-19R-D56	T857G03750-19R-D56	3/8 - 19	100	15	47	12	4	G
	T857G05000-14R-D56	T857G05000-14R-D56	1/2 - 14	125	18	55	16	4	G
	T857G06250-14R-D56	T857G06250-14R-D56	5/8 - 14	125	18	61	18	4	G
	T857G07500-14R-D56	T857G07500-14R-D56	3/4 - 14	140	20	65	20	4	G
	T857G08750-14R-D56	T857G08750-14R-D56	7/8 - 14	150	22	68	22	4	G
	T857G10000-11R-D56	T857G10000-11R-D56	1 - 11	160	24	74	25	5	G

NOTE: Suitable for tension/compression holders.

• KSU30 bright

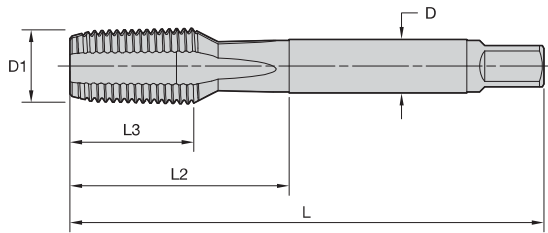

■ T848 • NPT and NPTF • Standard Projection • Form C

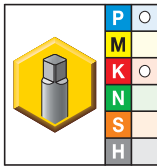

● first choice
○ alternate choice

KSU30	D1 size	L	L3	L2	D	number of flutes	thread type
T848NPT00625-27R-D56	1/16 - 27	90	13	35	6	3	NPT
T848NPTF00625-27R-D56	1/16 - 27	90	13	35	6	3	NPTF
T848NPT01250-27R-D56	1/8 - 27	90	13	36	7	4	NPT
T848NPTF01250-27R-D56	1/8 - 27	90	13	36	7	4	NPTF
T848NPT02500-18R-D56	1/4 - 18	100	20	39	11	4	NPT
T848NPTF02500-18R-D56	1/4 - 18	100	20	39	11	4	NPTF
T848NPT03750-18R-D56	3/8 - 18	110	20	39	12	4	NPT
T848NPTF03750-18R-D56	3/8 - 18	110	20	39	12	4	NPTF
T848NPT05000-14R-D56	1/2 - 14	125	26	56	16	4	NPT
T848NPTF05000-14R-D56	1/2 - 14	125	26	56	16	4	NPTF
T848NPT07500-14R-D56	3/4 - 14	140	26	55	20	4	NPT
T848NPTF07500-14R-D56	3/4 - 14	140	26	55	20	4	NPTF
T848NPT10000-11,5R-D56	1 - 11 1/2	160	32	71	25	5	NPT
T848NPTF10000-11,5R-D56	1 - 11 1/2	160	32	71	25	5	NPTF



➤ High-Performance Solid Carbide Thread Mills

Our solid carbide thread mills are designed to deliver high-quality internal threading on 3-axis CNC machines. Because these mills are made of carbide, they are capable of easily cutting most difficult materials up to 63 HRC. Thread mills make interrupted cuts and short chips.

The combination of these design elements offers a range of benefits to improve overall thread quality and tool production. Short, easily evacuated chips generate less heat and friction, so there is a lower risk of damage to threading. Also, the superior carbide grades make threading easier and machining times shorter.

Features and Benefits

System Requirements

- 3-axis CNC machine.
- Good clamping for tool and workpiece.
- Internal coolant supply.

Features

- Interrupted cut.
- Short chips.
- Optimised carbide grades.
- Drill, thread, chamfer.

Advantages

- Versatile.
- Better surface quality.
- No chip problems.
- No need to reverse the spindle.
- More production safety.





Through and Blind Holes (2 x D)

		Thread Mill	Thread Mill and Chamfer	Drill, Thread Mill, and Chamfer	Mill, Thread Mill, and Chamfer
P	<35 HRC	TM711	TM721	—	TM741_RHSF
	35–43 HRC	—	TM721	—	TM741_RHSF
M		TM711	TM721	—	TM741_RHSF
K		TM711	TM721	TM731	TM741_RHSF
N	Wrought	TM711	TM721	—	TM731
	Cast	TM711	TM721	TM731	TM741_RHSF
S		TM711	TM721	—	TM741_LHSF
H	44–63 HRC	—	—	—	TM741_RHSF TM741_LHSF

Solid Thread Mills Identification System

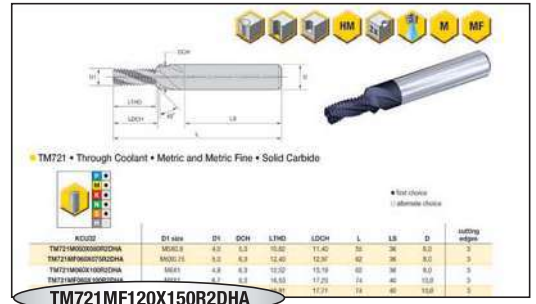

TM721MF120X150R2DHA

TM721

Thread Mill Design

MF

Type of Thread

120

Nominal Diameter of Thread

mm or inch (depending on type)

X

150

Pitch

mm or TPI (depending on type)

R

Cutting Direction

2D

Depth of Cut

HA

Shank

- M** = Metric coarse-pitch thread (ISO form)
- MF** = Metric fine-pitch thread (ISO form)
- NC** = Unified coarse series thread
- NF** = Unified fine series thread

- DIN 6535**
- HA** = Plain Shank
 - HB** = Weldon® Shank
 - HE** = Whistle Notch Shank

Style

- TM711** = Solid Thread Mill; Through Coolant
- TM721** = Solid Thread Mill and Chamfer; Through Coolant
- TM731** = Solid Thread Mill, Chamfer, and Drill; Through Coolant
- TM741** = Solid Thread Mill, Chamfer, and Mill; Through Coolant

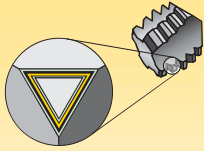

Coatings are designed for optimised tapping performance in specific materials.

P	Steel
M	Stainless Steel
K	Cast Iron
N	Non-Ferrous
S	High-Temp Alloys
H	Hardened Materials

wear resistance ← → toughness

Grade	Coating	Grade Description	Material Group																					
				05	10	15	20	25	30	35	40	45												
KCU32		Coated carbide. PVD — Fine-grain carbide substrate with high hardness TiCN coating. Universal grade for thread milling most materials.	P																					
			M																					
			K																					
			N																					
			S																					
			H																					
KCU33		Coated carbide. PVD — Carbide substrate with heat-resistant TiAlN coating. Universal grade for thread milling most materials.	P																					
			M																					
			K																					
			N																					
			S																					
			H																					
KCU36		Coated carbide. PVD — two-layer coating with heat-resistant TiAlN base layer and low-friction MoS ₂ top layer over carbide substrate. Use for thread milling most materials including high hardness materials.	P																					
			M																					
			K																					
			N																					
			S																					
			H																					

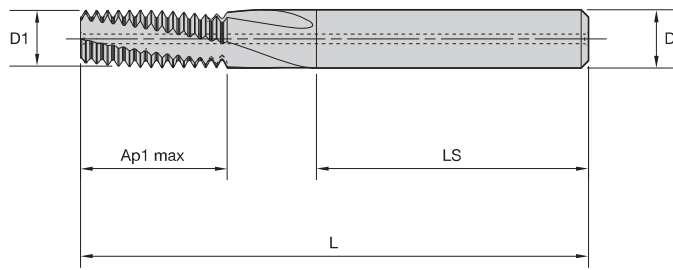

■ **TM711 • Through Coolant • Metric and Metric Fine • Solid Carbide**

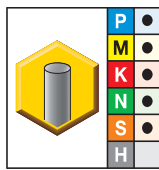

● first choice
○ alternate choice

SKU	D1 size	D1	Ap1 max	L	LS	D	cutting edges
TM711M030X050R2DHA	M3 X 0.5	2,4	—	42	28	4,0	3
TM711MF040X050R2DHA	M4 X 0.5	3,4	8,2	55	36	6,0	3
TM711M040X070R2DHA	M4 X 0.7	3,2	—	55	36	6,0	3
TM711MF050X050R2DHA	M5 X 0.5	4,3	10,2	55	36	6,0	3
TM711M050X080R2DHA	M5 X 0.8	4,0	—	55	36	6,0	3
TM711MF060X075R2DHA	M6 X 0.75	5,0	12,0	55	36	6,0	3
TM711M060X100R2DHA	M6 X 1	4,8	12,0	55	36	6,0	3
TM711MF080X075R2DHA	M8 X 0.75	6,0	16,8	63	36	6,0	3
TM711MF080X100R2DHA	M8 X 1.0	6,0	16,4	63	36	6,0	3
TM711M080X125R2DHA	M8 X 1.25	5,9	16,0	63	36	6,0	3
TM711MF100X100R2DHA	M10 X 1.0	8,0	20,5	70	36	8,0	3
TM711M100X150R2DHA	M10 X 1.5	8,0	20,2	70	36	8,0	3
TM711MF120X100R2DHA	M12 X 1.0	10,0	24,5	80	40	10,0	4
TM711MF120X150R2DHA	M12 X 1.5	10,0	24,7	80	40	10,0	4
TM711M120X175R2DHA	M12 X 1.75	10,0	25,3	80	40	10,0	4
TM711MF140X150R2DHA	M14 X 1.5	10,0	29,2	80	40	10,0	4
TM711M140X200R2DHA	M14 X 2.0	11,6	28,0	90	45	12,0	4
TM711MF160X150R2DHA	M16 X 1.5	12,0	32,2	90	45	12,0	4
TM711M160X200R2DHA	M16 X 2.0	12,0	32,9	90	45	12,0	4
TM711MF180X150R2DHA	M18 X 1.5	14,0	36,7	90	45	14,0	4
TM711M180X250R2DHA	M18 X 2.5	14,0	38,7	90	45	14,0	4
TM711MF200X150R2DHA	M20 X 1.5	14,0	41,2	90	45	14,0	4
TM711M200X250R2DHA	M20 X 2.5	14,0	41,2	90	45	14,0	4

Shank Tolerance

D	tolerance h6
6	+0, -0,008
8-10	+0, -0,009
12-18	+0, -0,011
20-30	+0, -0,013



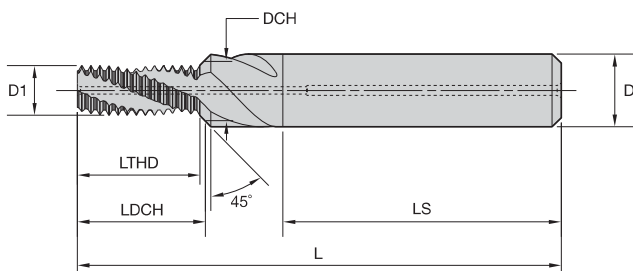

■ **TM721 • UNC • Through Coolant • Inch • Solid Carbide**

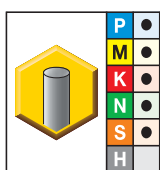

● first choice
○ alternate choice

Tapping

Material	D1 size	D1	DCH	LTHD	LDCH	L	LS	D	cutting edges
● KCU32									
● TM721NC2500-20R2DHA	1/4-20	4,7	6,7	13,36	14,23	62	36	8,0	3
● TM721NC3125-18R2DHA	5/16-18	6,2	8,3	16,26	17,19	74	40	10,0	3
● TM721NC3750-16R2DHA	3/8-16	7,7	9,8	19,89	20,85	80	45	12,0	3
● TM721NC4375-14R2DHA	7/16-14	9,0	11,4	22,72	23,79	80	45	12,0	3
● TM721NC0500-13R2DHA	1/2-13	10,4	13,0	26,43	27,60	90	45	14,0	4
● TM721NC5625-12R2DHA	9/16-12	11,8	14,6	30,75	31,99	100	48	16,0	4
● TM721NC0625-11R2DHA	5/8-11	13,1	16,2	33,54	34,89	102	48	18,0	4

Shank Tolerance

D	tolerance h6
6	+0, -0,008
8-10	+0, -0,009
12-18	+0, -0,011
20-30	+0, -0,013

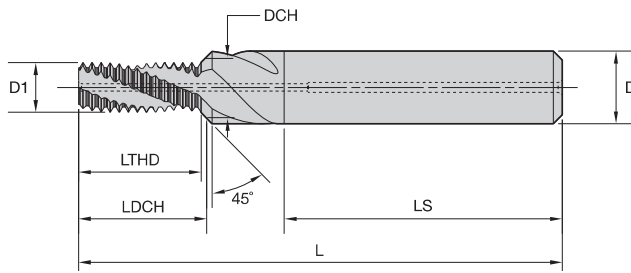

■ **TM721 • Through Coolant • Metric and Metric Fine • Solid Carbide**

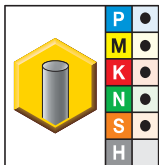

● first choice
○ alternate choice

KCU32	D1 size	D1	DCH	LTHD	LDCH	L	LS	D	cutting edges
TM721M060X100R2DHA	M6X1	4,8	6,3	12,52	13,19	62	36	8,0	3
TM721MF080X100R2DHA	M8X1	6,7	8,3	16,53	17,23	74	40	10,0	3
TM721M080X125R2DHA	M8X1.25	6,5	8,3	16,91	17,71	74	40	10,0	3
TM721M100X150R2DHA	M10X1.5	8,2	10,3	20,29	21,22	80	45	12,0	3
TM721MF120X125R2DHA	M12X1.25	10,4	12,3	24,43	25,24	90	45	14,0	4
TM721M120X175R2DHA	M12X1.75	9,9	12,3	25,42	26,48	90	45	14,0	4
TM721MF140X150R2DHA	M14X1.5	12,1	14,3	29,31	30,25	100	48	16,0	4
TM721M140X200R2DHA	M14X2	11,6	14,3	29,05	30,24	100	48	16,0	4
TM721M160X200R2DHA	M16X2	13,6	16,3	33,05	34,24	102	48	18,0	4

Shank Tolerance

D	tolerance h6
6	+0, -0,008
8-10	+0, -0,009
12-18	+0, -0,011
20-30	+0, -0,013

Tapping

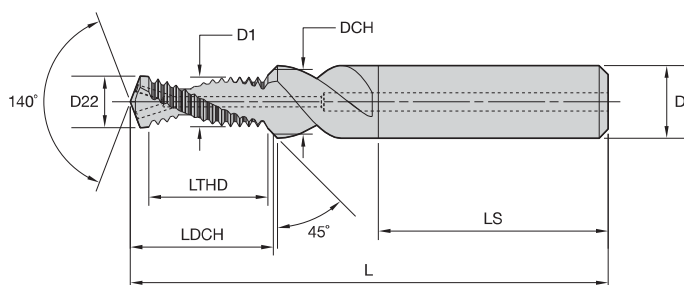

■ **TM731 • Through Coolant • Metric and Metric Fine • Solid Carbide**

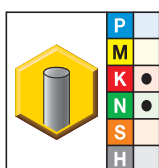

- first choice
- alternate choice

Tapping

KCU32	D1 size	D22	D1	DCH	LTHD	LDCH	L	LS	D	cutting edges
TM731M040X070R2DHA	M4X0.7	3,3	3,2	4,3	7,74	9,59	49	36	6,0	2
TM731M050X080R2DHA	M5X0.8	4,2	4,0	5,3	9,65	11,82	55	36	6,0	2
TM731M060X100R2DHA	M6X1	5,0	4,8	6,3	12,06	14,69	62	36	8,0	2
TM731MF080X100R2DHA	M8X1	7,0	6,8	8,3	16,09	19,10	74	40	10,0	2
TM731M080X125R2DHA	M8X1.25	6,8	6,5	8,3	15,08	18,42	74	40	10,0	2
TM731M100X150R2DHA	M10X1.5	8,5	8,2	10,3	19,59	23,65	79	45	12,0	2
TM731M120X175R2DHA	M12X1.7w5	10,3	9,9	12,3	22,86	27,63	89	45	14,0	2
TM731M160X200R2DHA	M16X2	14,0	13,6	16,3	32,13	38,00	102	48	18,0	2

Shank Tolerance

D	tolerance h6
6	+0, -0,008
8-10	+0, -0,009
12-18	+0, -0,011
20-30	+0, -0,013

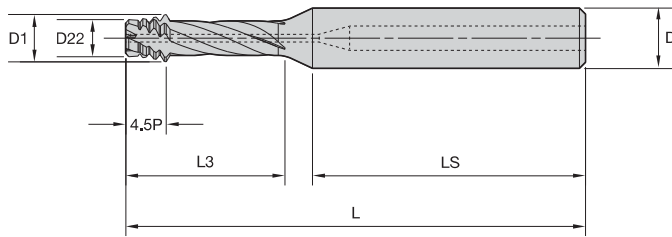

■ **TM741 • UNC and UNF • Through Coolant • Right Hand • Inch • Solid Carbide**

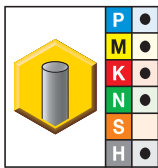

● first choice
○ alternate choice

Material	D1 size	D1	D22	L3	L	LS	D	cutting edges
● KCU36	1/4-20	4,64	3,34	17,0	60	36	8,0	3
●	1/4-28	4,66	3,62	17,0	60	36	8,0	3
●	5/16-18	5,64	4,12	21,9	76	40	10,0	4
●	5/16-24	5,64	4,48	21,9	76	40	10,0	4
●	3/8-16	7,16	5,42	26,3	76	40	10,0	4
●	3/8-24	7,14	6,00	26,3	76	40	10,0	4
●	1/2-13	10,08	7,95	33,4	86	45	12,0	4
●	1/2-20	8,45	7,06	33,0	86	45	12,0	4
●	5/8-18	12,38	10,83	42,0	98	48	16,0	4
●	3/4-10	15,50	12,77	51,3	111	50	20,0	5
●	3/4-16	15,38	13,65	51,3	111	50	20,0	5

Shank Tolerance

D	tolerance h6
6	+0, -0,008
8-10	+0, -0,009
12-18	+0, -0,011
20-30	+0, -0,013



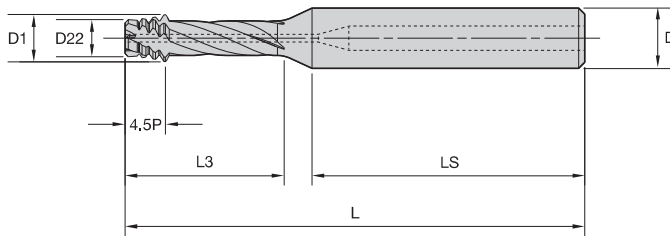

■ **TM741 • Through Coolant • Right Hand • Metric and Metric Fine • Solid Carbide**

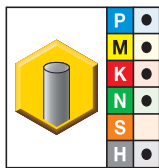



● first choice
○ alternate choice

Tapping

KCU36	D1 size	D1	D22	L3	L	LS	D	cutting edges
TM741M060X100R2DHA	M6X1	4,51	3,41	16,5	60	36	8,0	3
TM741MF080X100R2DHA	M8X1	6,23	5,13	21,9	71	40	10,0	4
TM741M080X125R2DHA	M8X1.25	6,23	4,91	21,9	71	40	10,0	4
TM741MF100X100R2DHA	M10X1	6,23	5,13	21,9	71	40	10,0	4
TM741MF100X125R2DHA	M10X1.25	6,23	4,91	21,9	71	40	10,0	4
TM741M100X150R2DHA	M10X1.5	7,75	6,11	26,3	76	40	10,0	4
TM741MF120X150R2DHA	M12X1.5	7,75	6,11	26,3	76	40	10,0	4
TM741M120X175R2DHA	M12X1.75	9,16	7,21	32,4	86	45	12,0	4
TM741M140X200R2DHA	M14X2	11,08	8,91	41,0	98	48	16,0	4
TM741M160X200R2DHA	M16X2	11,08	8,91	41,0	98	48	16,0	4
TM741M180X250R2DHA	M18X2.5	14,38	11,71	51,3	111	50	20,0	5
TM741M200X250R2DHA	M20X2.5	14,38	11,71	51,3	111	50	20,0	5

Shank Tolerance

D	tolerance h6
6	+0, -0,008
8-10	+0, -0,009
12-18	+0, -0,011
20-30	+0, -0,013

		 Thread Mill TM711					 Thread Mill and Chamfer TM721						
Material Group		Cutting Speed — vc Range — m/min			Feed/Tooth by Diameter			Cutting Speed — vc Range — m/min			Feed/Tooth by Diameter		
		min	Starting Value	max		<10mm	>10mm	min	Starting Value	max		<10mm	>10mm
		P	1	90	115	150	mm/r	0,05	0,08	140	185	240	mm/r
2	90		115	150	mm/r	0,05	0,08	140	185	240	mm/r	0,06	0,10
3	40		50	70	mm/r	0,02	0,03	70	90	120	mm/r	0,03	0,04
4	—		—	—	—	—	—	70	90	120	mm/r	0,03	0,04
5	60		80	100	mm/r	0,04	0,06	70	90	120	mm/r	0,05	0,08
6	—		—	—	—	—	—	—	—	—	—	—	—
M	1	60	80	100	mm/r	0,04	0,06	70	90	120	mm/r	0,05	0,08
	2	60	80	100	mm/r	0,04	0,06	70	90	120	mm/r	0,05	0,08
	3	—	—	—	—	—	—	—	—	—	—	—	—
K	1	120	150	200	mm/r	0,06	0,10	130	170	220	mm/r	0,06	0,11
	2	120	150	200	mm/r	0,06	0,10	130	170	220	mm/r	0,06	0,11
	3	90	115	150	mm/r	0,05	0,07	110	140	180	mm/r	0,05	0,07
N	1	250	275	300	mm/r	0,07	0,09	270	300	330	mm/r	0,08	0,16
	2	200	225	250	mm/r	0,05	0,06	270	300	330	mm/r	0,08	0,16
	3	170	190	210	mm/r	0,04	0,05	160	175	190	mm/r	0,08	0,16
	4	250	275	300	mm/r	0,07	0,09	270	300	330	mm/r	0,08	0,16
	5	270	300	330	mm/r	0,12	0,13	250	275	300	mm/r	0,11	0,20
	6	170	190	210	mm/r	0,05	0,06	90	100	110	mm/r	0,11	0,20
S	1	60	80	100	mm/r	0,04	0,06	70	90	120	mm/r	0,05	0,08
	2	50	65	80	mm/r	0,03	0,04	50	60	80	mm/r	0,03	0,05
	3	50	65	80	mm/r	0,03	0,04	50	60	80	mm/r	0,03	0,05
	4	50	65	80	mm/r	0,03	0,04	50	60	80	mm/r	0,03	0,05



		 Drill, Chamfer, and Thread Mill TM731										
Material Group		Cutting Speed — vc Range — m/min			Drilling Recommended Feed by Diameter			Milling Feed/Tooth by Diameter				
		min	Starting Value	max		<6mm	6–10mm	10–16mm		<6mm	6–10mm	10–16mm
		K	1	130	175	230	mm/r	0,10	0,16	0,30	mm/r	0,05
2	270		300	330	mm/r	0,15	0,25	0,34	mm/r	0,06	0,08	0,12
N	3	140	150	170	mm/r	0,15	0,25	0,34	mm/r	0,06	0,08	0,12
	4	270	300	330	mm/r	0,15	0,25	0,34	mm/r	0,06	0,08	0,12
	5	110	120	130	mm/r	0,12	0,20	0,32	mm/r	0,06	0,08	0,12

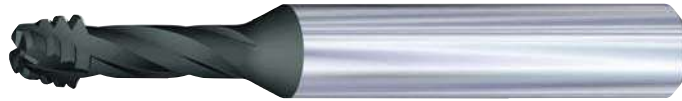

Mill, Chamfer, and Thread Mill TM741

Material Group	TM Style	Grade	Cutting Speed – vc			Feed/Tooth by Diameter			
			Range – m/min			<10mm	>10mm		
			min	Starting Value	max				
P	1	TM741 R	KCU36	170	225	290	mm/r	0,05	0,08
	2	TM741 R	KCU36	170	225	290	mm/r	0,05	0,08
	3	TM741 R	KCU36	120	150	200	mm/r	0,03	0,05
	4	TM741 R	KCU36	100	125	160	mm/r	0,03	0,05
	5	TM741 R	KCU36	120	150	200	mm/r	0,03	0,04
	6	TM741 R	KCU36	60	80	100	mm/r	0,03	0,04
M	1	TM741 R	KCU36	120	150	200	mm/r	0,03	0,04
	2	TM741 R	KCU36	120	150	200	mm/r	0,03	0,04
	3	TM741 R	KCU36	120	150	200	mm/r	0,03	0,04
K	1	TM741 R	KCU36	190	250	330	mm/r	0,06	0,10
	2	TM741 R	KCU36	190	250	330	mm/r	0,06	0,10
	3	TM741 R	KCU36	140	185	240	mm/r	0,04	0,07
N	1	–	–	–	–	–	–	–	–
	2	–	–	–	–	–	–	–	–
	3	TM741 R	KCU36	180	230	300	mm/r	0,06	0,07
	4	TM741 R	KCU36	210	275	360	mm/r	0,06	0,07
	5	–	–	–	–	–	–	–	–
	6	TM741 R	KCU36	210	275	360	mm/r	0,06	0,07
S	1	TM741 L	KCU36	120	150	200	mm/r	0,025	0,045
	2	TM741 L	KCU36	50	60	80	mm/r	0,015	0,025
	3	TM741 L	KCU36	50	60	80	mm/r	0,015	0,025
	4	TM741 L	KCU36	70	90	120	mm/r	0,025	0,035
H	1	TM741	KCU36	80	100	130	mm/r	0,030	0,050
	2	TM741	KCU36	80	100	130	mm/r	0,030	0,050
	3	TM741	KCU36	50	65	80	mm/r	0,020	0,030
	4	TM741	KCU36	50	65	80	mm/r	0,020	0,030

NOTE: For thread depths over 2 x D up to 3 x D, reduce speed and feed by 25%.

Tapping

Milling Methods

Climb Milling

Properties:

- Tool rotation direction clockwise
 - Tool moves anti-clockwise
 - Pitch "upwards"
- ↓
- Right-hand thread

Climb milling is always when the cutting edge goes out of the material with a chip thickness $h = 0$

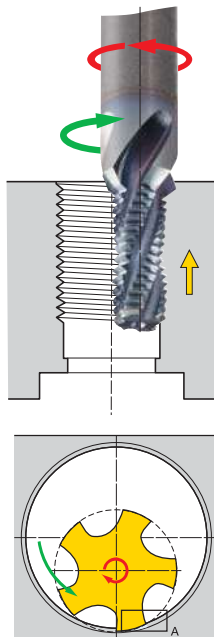
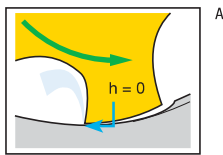

Conventional Milling

Properties:

- Tool rotation direction clockwise
 - Tool moves clockwise
 - Pitch "downwards"
- ↓
- Right-hand thread

Conventional milling is always when the cutting edge goes out of the material with a chip thickness $h = \text{max}$

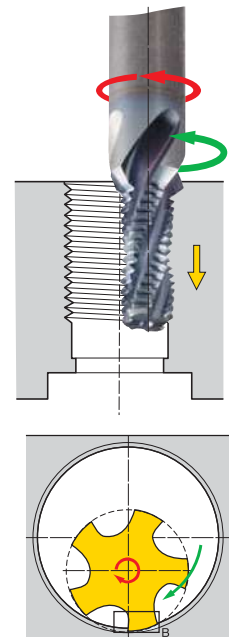
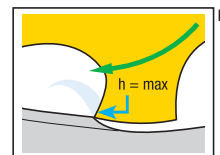

Counter Feed F_k

$$F_k = n \cdot f_z \cdot Z \text{ [mm/min]}$$

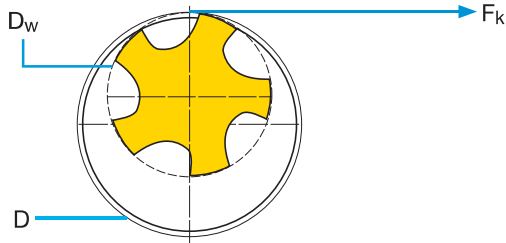

Centre Point Feed F_m

$$F_m = \frac{F_k \cdot (D - D_w)}{D} \text{ [mm/min]}$$

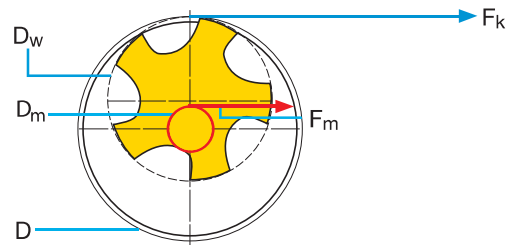

Counter Feed (F_k)

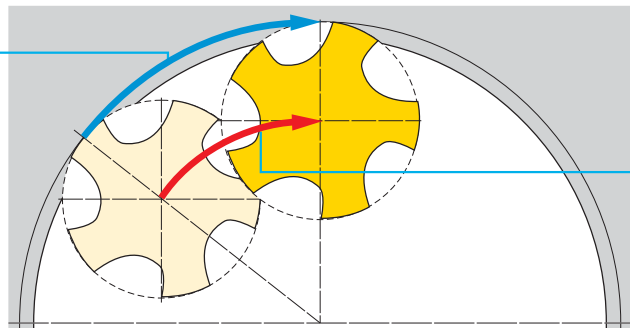

Centre Point Feed (F_m)

- D_w = Tool diameter [mm]
- n = RPM [min^{-1}]
- f_z = Feed per tooth [mm]
- Z = Number of teeth on tool (radial)
- D = Nominal diameter of thread = Diameter of external contour [mm]
- D_m = Diameter of the centre point ($D - D_w$) [mm]

Drill Thread Mill TM741 • Right Hand

Preparation

None

Process Principle

Milling thread and core hole, countersinking (conventional milling)

Cycle

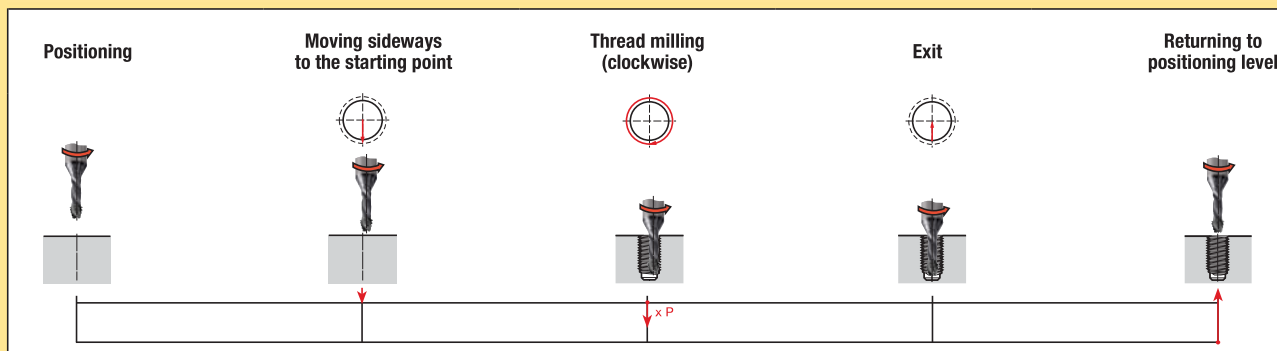

Required Specification Values

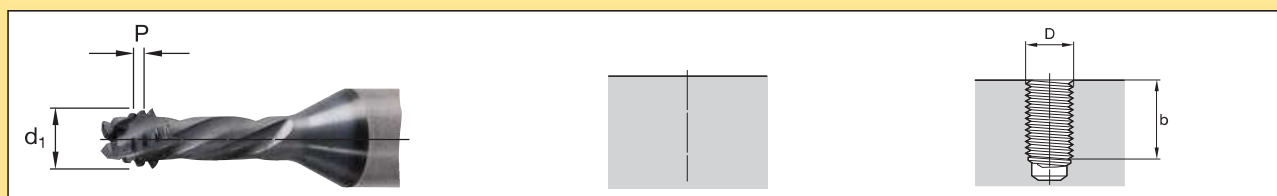

Example

Size — M10-6H Thread diameter D 10mm Pitch P 1,5mm Core hole diameter D_1 8,5mm Material — Hard steel, 50 HRC Grade — KCU36	Tool — TM741 Right Hand Catalogue number TM741M100X150R2DHA Number of teeth Z 4 Tool diameter d_1 7,75mm* Tool radius compensation k_1 0,08mm** Tool radius to be programmed ² 3,795mm*** Thread depth b^3 20mm Cutting speed v_c 100 m/min Feed (milling) f_z 0,04 mm/tooth Number of turns ⁵ 17	$N = \frac{v_c \cdot 1000}{d_1 \cdot \pi} \quad S = 4109$ $v_f = f_z \cdot Z \cdot n \quad F = 657 \text{ (contour)}$ $N = \frac{v_f \text{ contour} \cdot (D - d_1)}{D} \quad F = 148 \text{ (centre point)}$
---	---	--

* (measured on the cutting part) ** (0.01 x D; adjust to application) *** (1/2 $d_1 - k$)

Programme to DIN 66025 (conventional milling, on the contour, incremental)

Positioning the tool	N 10 G 54 G 90 G 00 X... Y... Z 1.500 S 4109 T01 ² M03
Incremental programming	N 20 G 91
Moving sideways to the starting point	N 30 G 42 G 01 X 0 Y -5 F 657 (contour) [F 148] ⁴ (centre point)
Thread milling	N 40 G 02 X 0 Y 0 Z -1.500 I 0 J 5.000
Repeat thread milling	... ⁵
Exit	N 50 G 40 G 01 X 0 Y 5
Retracting tool to positioning level	N 70 G 90 G 00 Z 2

Cutting time t_h

51,6 seconds

NOTES:

- ¹ The cutter radius measured over the tooth crests of the threaded part must be reduced by the amount of the cutter radius compensation. This is necessary to achieve a depth of cut to the middle of the 6H/ISO2 nut tolerance. Please note, however, that this also depends on the radial deflection of the tool (tensile strength of the material, projecting length of the tool).
- ² The cutter radius to be programmed is normally included in the tool memory.
- ³ The thread depth b must be divisible by the thread pitch P .
- ⁴ The feed values in brackets must be used for controllers, which do not calculate the centre point feed themselves.
- ⁵ Set N40 must be repeated with the number of threads. Repetitions N = thread depth b /pitch P (rounded up to the nearest integer).

Drill Thread Mill TM741 • Left Hand

Preparation

None

Process Principle

Milling thread and core hole, countersinking (climb milling)

Cycle

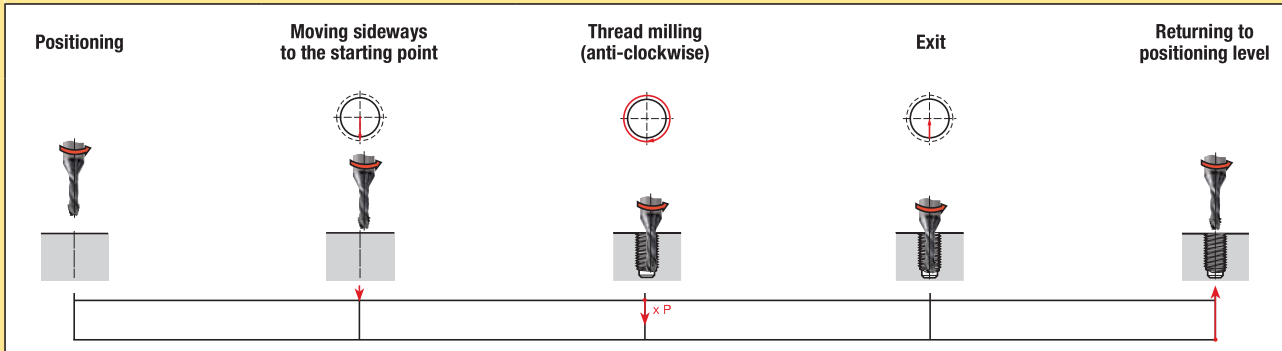

Required Specification Values

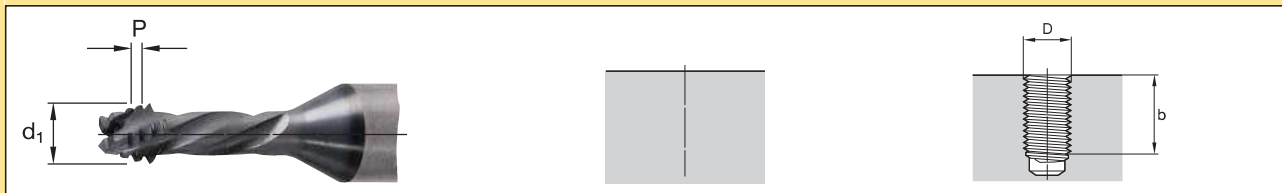

Example

Size — M10-6H	Tool — TM741 Left Hand	
Thread diameter D.....10mm	Catalogue number.....TM741M100X150L2DHA	$N = \frac{V_c \cdot 1000}{d_1 \cdot \pi} \quad S = 4109$
Pitch P.....1,5mm	Number of teeth Z.....4	$v_f = f_z \cdot Z \cdot n \quad F = 493$ (contour)
Core hole diameter D ₁8,5mm	Tool diameter d ₁7,75mm*	$v_f = \frac{v_f \text{ contour} \cdot (D - d_1)}{D} \quad F = 111$ (centre point)
Material — TiAl6V4 titanium	Tool radius compensation k ¹0,08mm**	
Grade — KCU36	Tool radius to be programmed ²3,795mm***	
	Drilling/countersink depth l _E20mm	
	Cutting speed v _c100 m/min	
	Feed (milling) f _z0,03 mm/tooth	
	Number of turns ⁵17	

*(measured on the cutting part)

** $(0.01 \times D)$

*** $(1/2 d_1 - k)$

Programme to DIN 66025 (climb milling, on the contour, incremental)

Positioning the tool	N10 G54 G90 G00 X... Y... Z 1.500 S 4109 T01 ² M04
Incremental programming	N20 G91
Moving sideways to the starting point	N30 G42 G01 X0 Y-5 F 493 (contour) [F 111] ⁴ (centre point)
Thread milling	N40 G02 X0 Y0 Z-1.500 I0 J 5.000
Repeat thread milling	... ⁵
Exit	N50 G40 G01 X0 Y5
Retracting tool to positioning level	N70 G90 G00 Z2

Cutting time t_h

68,8 seconds

NOTES:

¹ The cutter radius measured over the tooth crests of the threaded part must be reduced by the amount of the cutter radius compensation. This is necessary to achieve a depth of cut to the middle of the 6H/ISO2 nut tolerance. Please note, however, that this also depends on the radial deflection of the tool (tensile strength of the material, projecting length of the tool).

² The cutter radius to be programmed is normally included in the tool memory.

³ The thread depth b must be divisible by the thread pitch P.

⁴ The feed values in brackets must be used for controllers, which do not calculate the centre point feed themselves.

⁵ Set N40 must be repeated with the number of threads. Repetitions N = thread depth b/pitch P (rounded up to the nearest integer).

Drill Thread Mill TM731

Preparation

None

Process Principle

Drilling, countersinking, thread milling (climb milling)

Cycle

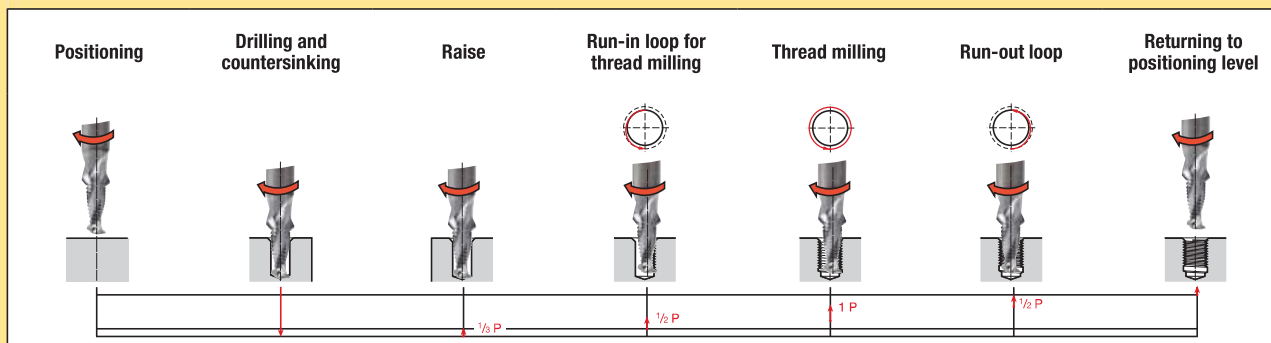

Required Specification Values

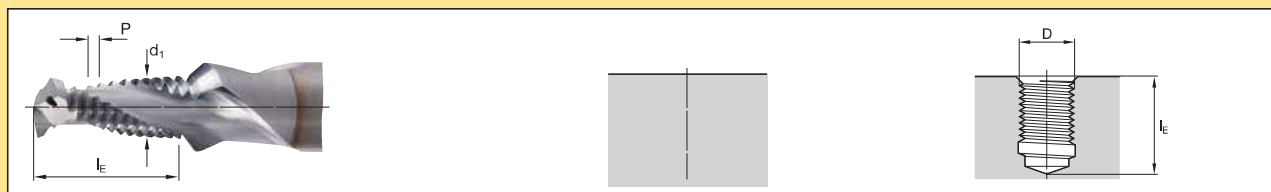

Example

Size — M10-6H Thread diameter D 10mm Pitch P 1,5mm Core hole diameter D_1 8,5mm Material — Grey cast iron Grade — KCU32	Tool — TM731 Catalogue number TM731M100X150R2DHA Number of teeth Z 2 Tool diameter d_1 8,2mm* Tool radius compensation k_1 0,1mm** Tool radius to be programmed ² 4mm*** Drilling/countersink depth l_E 19,11mm Cutting speed v_c 250 m/min Feed (drilling, countersinking) f_b 0,25 mm/U Feed (milling) f_z 0,1 mm/tooth	$N = \frac{v_c \cdot 1000}{d_1 \cdot \pi} \quad S = 9709$ $v_b = f_b \cdot n \quad F = 2427 \text{ (drilling, countersinking)}$ $v_f = f_z \cdot Z \cdot n \quad F = 1942 \text{ (contour)}$ $v_f = \frac{v_f \text{ contour} \cdot (D-d_1)}{D} \quad F = 350 \text{ (centre point)}$
---	--	---

* (measured on the cutting part) ** (0.01 x D) *** (1/2 d_1 - k)

Programme to DIN 66025 (climb milling, on the contour, incremental)

Positioning the tool	N 10 G 54 G 90 G 00 X... Y... Z 2 S 9709 T01 ² M03
Drilling and countersinking	N 20 G 91 G 01 Z-21.110 F 2427 (drill, countersink)
Raise	N 30 G 01 Z 0.500
Moving sideways to the starting point	N 40 G 41 Y-4.250 F 971 (milling, 1/2 contour) [F 175] ³ (1/2 centre point)
Run-in loop in arc	N 50 G 03 X 0 Y 9.250 Z 0.750 I 0 J 4.625
Thread milling	N 60 G 03 X 0 Y 0 Z 1.500 I 0 J -5.000 F 1942 [F 350] ³ (centre point)
Run-out loop in arc	N 70 G 03 X 0 Y-9.250 Z 0.750 I 0 J- 4.625
Exit	N 80 G 00 G 40 X 0 Y 4.250
Retracting tool to positioning level	N 90 G 90 Z 2

Cutting time t_h

2,3 seconds

NOTES:

- The cutter radius measured over the tooth crests of the threaded part must be reduced by the amount of the cutter radius compensation. This is necessary to achieve a depth of cut to the middle of the 6H/ISO2 nut tolerance. Please note, however, that this also depends on the radial deflection of the tool (tensile strength of the material, projecting length of the tool).
- The cutter radius to be programmed is normally included in the tool memory.
- The feed values in brackets must be used for controllers, which do not calculate the centre point feed themselves.

Thread Mill TM721

Preparation

Drilling of thread hole

Process Principle

Countersinking, thread milling (conventional milling)

Cycle

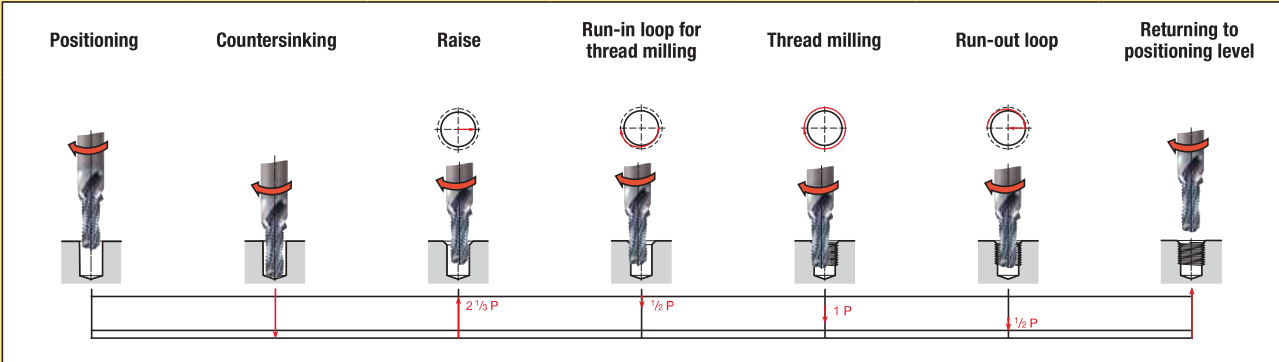

Required Specification Values

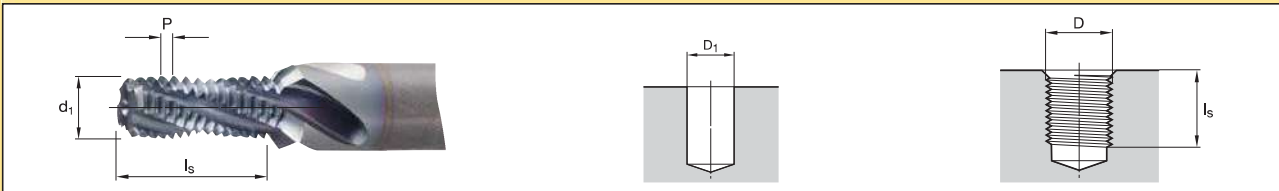

Example

Size — M10-6H
 Thread diameter D 10mm
 Pitch P 1,5mm
 Core hole diameter D₁ 8,5mm
Material — Cast aluminium
Grade — KCU32

Tool — TM721
 Catalogue number TM721M100X150R2DHA
 Number of teeth Z 3
 Tool diameter d₁ 8,2mm*
 Tool radius compensation k¹ 0,1mm**
 Tool radius to be programmed² 4mm***
 Countersink depth l_s 21,2mm
 Cutting speed v_c 250 m/min
 Feed (countersinking) f_s 0,3 mm/U
 Feed (milling) f_z 0,09 mm/tooth

$$N = \frac{v_c \cdot 1000}{d_1 \cdot \pi} \quad S = 9709$$

$$v_s = f_s \cdot n \quad F = 2913 \text{ (countersinking)}$$

$$v_f = f_z \cdot Z \cdot n \quad F = 2622 \text{ (contour)}$$

$$v_f = \frac{v_f \text{ contour} \cdot (D - d_1)}{D} \quad F = 472 \text{ (centre point)}$$

*(measured on the cutting part)

** $(0.01 \times D)$

*** $(1/2 d_1 - k)$

Programme to DIN 66025 (conventional milling, on the contour, incremental)

Positioning the tool	N 10 G 54 G 90 G 00 X... Y... Z 2 S 9709 T01 ² M03
Advancing tool to full thread depth	N 20 G 91 Z-21.200
Countersinking	N 30 G 01 Z-2 F 2913 (countersink)
Raise	N 40 G 00 Z 3.450
Moving sideways to the starting point	N 50 G 42 G01 X 4.250 F 1311 (milling, 1/2 contour) [F 236] ³ (milling, 1/2 centre point)
Run-in loop in arc	N 60 G 02 X-9.25 Y 0.000 Z-0.750 I-4.625 J 0
Thread milling	N 70 G 02 X 0 Y 0 Z-1.500 I 5 J 0.000 F 2622 [F 472] ³ (centre point)
Run-out loop in arc	N 80 G 02 X 9.25 Y 0.000 Z-0.750 I 4.625 J 0
Exit	N 90 G 40 G 01 X-4.25
Retracting tool to positioning level	N 100 G 90 G 00 Z 2

Cutting time t_h

1,4 seconds

NOTES:

¹ The cutter radius measured over the tooth crests of the threaded part must be reduced by the amount of the cutter radius compensation. This is necessary to achieve a depth of cut to the middle of the 6H/ISO2 nut tolerance. Please note, however, that this also depends on the radial deflection of the tool (tensile strength of the material, projecting length of the tool).

² The cutter radius to be programmed is normally included in the tool memory.

³ The feed values in brackets must be used for controllers, which do not calculate the centre point feed themselves.

High-Performance Taps • Carbide • Metric

Material Group	 Through Holes					 Blind Holes					
	Tap Style	Grade	Range — m/min			Tap Style	Grade	Range — m/min			
			min	Starting Value	max			min	Starting Value	max	
	P	1	T320, T321	KC7542	60	100	130	T331	KC7542	50	70
2		T320, T321	KC7542	60	90	120	T331	KC7542	40	60	80
3		T320, T321	KC7542	50	80	100	T331	KC7542	40	60	80
K	1	T340, T353	KC7542, KCK17	70	105	140	T351, T353	KC7542, KCK17	50	70	90
	2	T340, T353	KC7542, KCK17	60	100	130	T351, T353	KC7542, KCK17	50	70	90
	3	T340, T353	KC7542, KCK17	60	90	120	T351, T353	KC7542, KCK17	40	60	80
N	2	–	–	–	–	–	T471, T491	KCN14	60	80	100
	3	–	–	–	–	–	T471, T491	KCN14	50	70	90
	4	–	–	–	–	–	T471, T491	KCN14	40	60	80
H	1	T410	KCU36	1,2	1,5	2,0	T410	KCU36	0,8	1,1	1,4
	2	T410	KCU36	0,6	0,8	1,0	T410	KCU36	0,4	0,5	0,7

NOTE: Increase speed of T321 coolant taps by up to 25% of speeds listed for non-coolant T320 taps.

High-Performance Taps • HSS-E-PM • Metric

Material Group	 Through Holes					 Blind Holes					
	Tap Style	Grade	Range — m/min			Tap Style	Grade	Range — m/min			
			min	Starting Value	max			min	Starting Value	max	
	P	1	T620	KP6525	20	30	45	T630, T632, T650	KP6525	14	21
T622			KSP21	18	30	50	T622	KSP21	13	21	35
2		T620	KP6525	17	25	38	T630, T632, T650	KP6525	12	18	26
		T622	KSP21	15	25	42	T622	KSP21	10	18	29
3		T620	KP6525	12	15	20	T630, T632, T650	KP6525	8	11	14
4		T600	KSP21	5	6	8	T604	KSH26	3	4	5
M	5	T620	KP6525	12	15	20	T630, T632, T650	KP6525	8	11	14
	6	T600	KSP21	6	8	10	T604	KSH26	4	6	7
	1	T620	KM6515	12	15	20	T630, T632, T650	KM6515	8	11	14
K	2	T620	KM6515	9	12	16	T630, T632, T650	KM6515	6	8	11
	3	T620	KM6515	8	10	13	T630, T632, T650	KM6515	5	7	9
	1	T640	KP6525	27	35	46	T640, T642	KP6525	19	25	32
N	2	T640	KP6525	23	30	39	T640, T642	KP6525	16	21	27
	3	T640	KP6525	19	25	33	T640, T642	KP6525	13	18	23
	1	T670	KSN38	42	55	72	T680	KSN38	30	39	50
		T622	KSN28	37	55	72	T622	KSN28	26	39	50
2	T640	KP6525	30	45	59	T640, T642	KP6525	21	32	41	
	T622	KSN28	33	50	65	T622	KSN28	23	35	46	
S	4	T640	KP6525	7	10	15	T640, T642	KP6525	5	7	11
	1	T620	KP6525	8	12	18	T630, T632	KP6525	6	8	13

NOTE: Increase speed by up to 25% when using coolant taps (T621, T623, T625, T627, T631, T633, T641, T643, T651).

Tapping

GOtap™ • Metric

Material Group												
	Through Holes					Blind Holes						
	Range — m/min					Range — m/min						
	Tap Style	Grade	min	Starting Value	max	Tap Style	Grade	min	Starting Value	max		
P	1	T820	KSU31, KSP32	23	30	38	T830, T832, T838, T839	KSU31, KSP32	15	21	30	
		T820	KSP39, KSU30	11	15	19	T830, T832, T838, T839	KSP39, KSU30	7	11	15	
		T854	KSU31	6	8	10	T854	KSU31	6	8	10	
		T854	KSP39	5	6	8	T854	KSP39	5	6	8	
		T877	KSU31	17	22	28	T857	KSU31	11	15	22	
		T877	KSP39	8	10	13	T857	KSP39	5	7	10	
	2	T848	KSU30	5	6	8	T848	KSU30	3	4	6	
		T820	KSU31, KSP32	18	24	30	T830, T832, T838, T839	KSU31, KSP32	12	17	24	
	3	T820	KSP39, KSU30	11	14	18	T830, T832, T838, T839	KSP39, KSU30	7	10	14	
		T820	KSU31, KSP32	17	22	28	T830, T832, T838, T839	KSU31, KSP32	11	15	22	
		T820	KSP39, KSU30	9	12	15	T830, T832, T838, T839	KSP39, KSU30	6	8	12	
		T846	KSU31	6	8	10	T846	KSU31	6	8	10	
M	1	T846	KSU30	4	5	6	T846	KSU30	4	5	6	
		T820	KSMN34, KSP32	14	18	23	T830, T832, T838, T839	KSMN34, KSP32	9	13	18	
		T820	KSP39, KSU30	8	10	13	T830, T832, T838, T839	KSP39, KSU30	5	7	10	
		T854	KSU31	6	8	10	T854	KSU31	6	8	10	
		T854	KSP39	4	5	6	T854	KSP39	4	5	6	
		T877	KSU31	9	12	15	T857	KSU31	6	8	11	
	3	T877	KSP39	5	7	9	T857	KSP39	4	5	7	
		T848	KSU30	4	5	6	T848	KSU30	3	4	6	
	1	T820	KSMN34, KSP32	11	15	19	T830, T832, T838, T839	KSMN34, KSP32	7	11	15	
		T820	KSP39, KSU30	7	9	11	T830, T832, T838, T839	KSP39, KSU30	4	6	9	
	K	1	T846	KSU31	11	15	19	T846	KSU31	11	15	19
			T846	KSU30	6	8	10	T846	KSU30	6	8	10
2		T820	KSU31, KSP32	16	21	26	T830, T832, T838, T839	KSU31, KSP32	10	15	21	
		T820	KSP39, KSU30	9	12	15	T830, T832, T838, T839	KSP39, KSU30	6	8	12	
		T877	KSU31	14	18	23	T857	KSU31	9	13	18	
		T877	KSP39	7	9	11	T857	KSP39	4	6	9	
N	1	T848	KSU30	4	5	6	T848	KSU30	2	4	5	
		T820	KSMN34, KSP32	37	49	61	T830, T832, T838, T839	KSMN34, KSP32	24	34	49	
	2	T820	KSU30	20	27	34	T830, T832	KSU30	13	19	27	
		T820	KSMN34, KSP32	30	40	50	T830, T832, T838, T839	KSMN34, KSP32	20	28	40	
		T820	KSU30	16	21	26	T830, T832	KSU30	10	15	21	
		T877	KSU31	17	22	27	T857	KSU31	11	15	22	
		T877	KSP39	8	10	12	T857	KSP39	5	7	10	
		T848	KSU30	10	13	16	T848	KSU30	6	9	13	
	4	T820	KSMN34, KSP32	37	49	61	T830, T832, T838, T839	KSMN34, KSP32	24	34	49	
		T820	KSU30	20	27	33	T830, T832	KSU30	13	19	27	



KSU30 = Bright
 KSP39 = Oxide
 KSU31 = TiN
 KSP32 = TiCN/TiN
 KSMN34 = TiN + CrC/C

Taps and Thread Milling

Technical Information

Use the technical information offered here to assist with tapping and thread milling operations. This tech data includes information about tap dimensions and recommendations, as well as how to solve basic tapping and thread milling problems.

Included in This Section:

- Illustrations of tap terms.
- Explanations of tap chamfers.
- Dimensional information for various tap styles and lengths.
- Tap limitation data.
- Chip handling methods for different tap styles.
- Tap recommendations.
- Descriptions of screw thread tolerance and tolerance information.
- Information regarding surface treatments and coatings.
- Guidelines and tables for determining tapping speeds.
- Troubleshooting charts.
- Hardness conversion table.
- Taps custom order worksheet.
- Thread milling application sheet.
- Tap drill size charts.

This section will help you learn more about tapping and thread milling applications to maximise the performance of your tools.

How to Apply This Technical Information

Below is an example of how the technical information in this catalogue can be useful:

Problem

- Thread holes are oversized and taps are experiencing decreased tool life when used in stainless steel materials.

Solution

- Consult the troubleshooting portion of the technical information section to discover ways to correct the issue.



Definitions and Angles, Centres, and Flute Forms

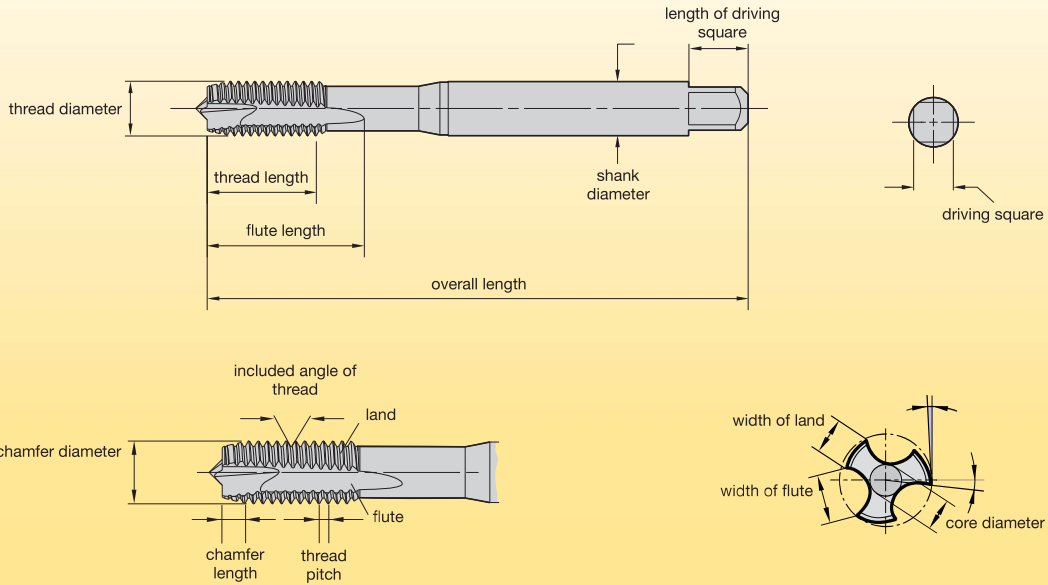

Flute Forms



Straight-flute, form C plug chamfer without spiral point



Right-hand spiral flute



Straight-flute, form B plug chamfer with spiral point



Left-hand spiral flute

Types of Centres (Standard to DIN 2197/DIN 2175)

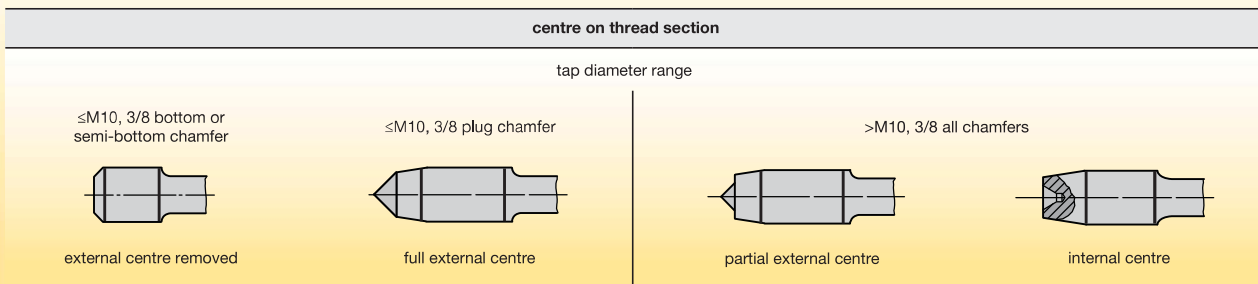

Coolant Hole Types



Axial coolant delivery with axial coolant exit hole



Axial coolant delivery with radial coolant hole exiting in the flutes

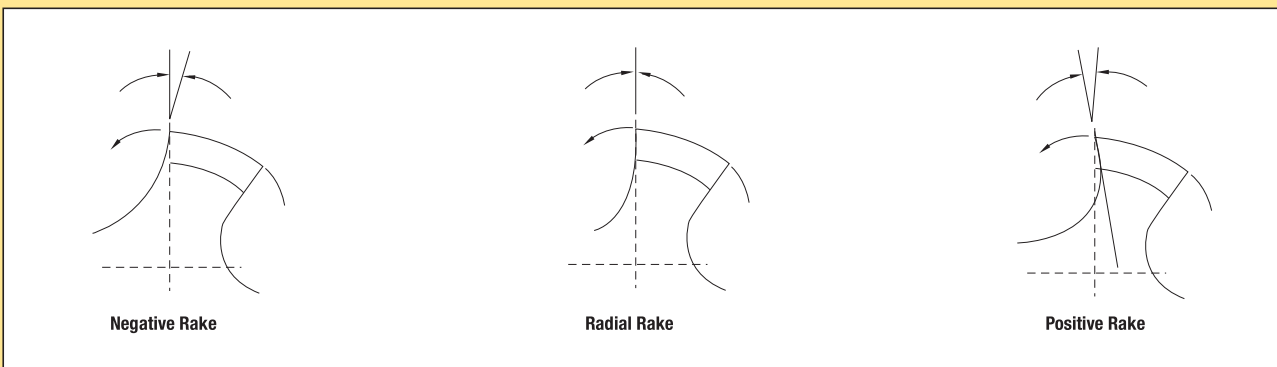
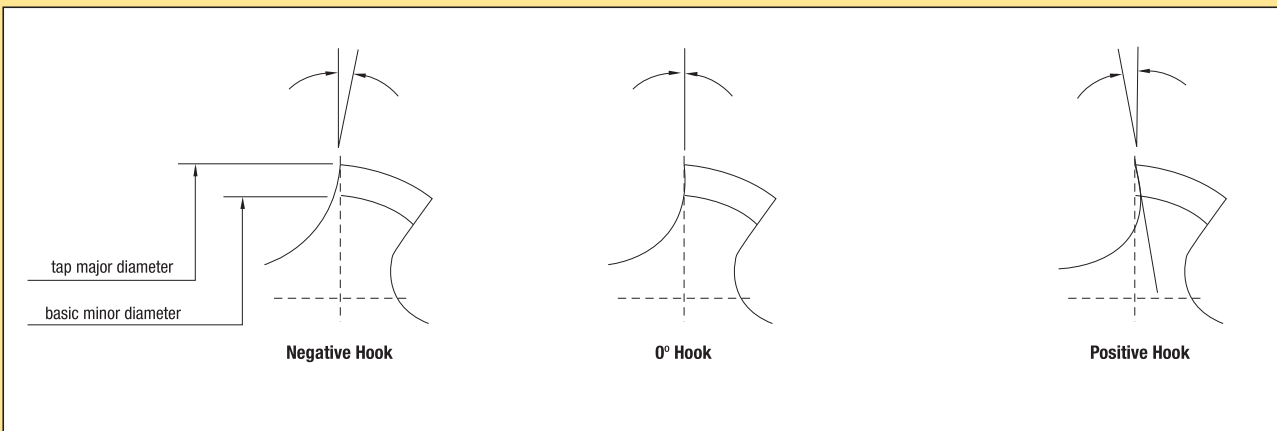
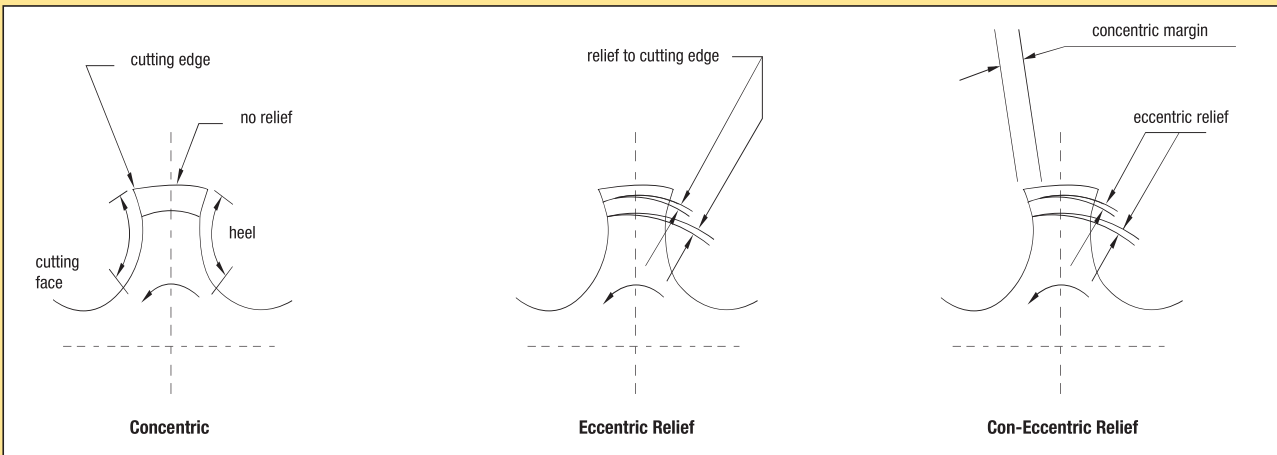
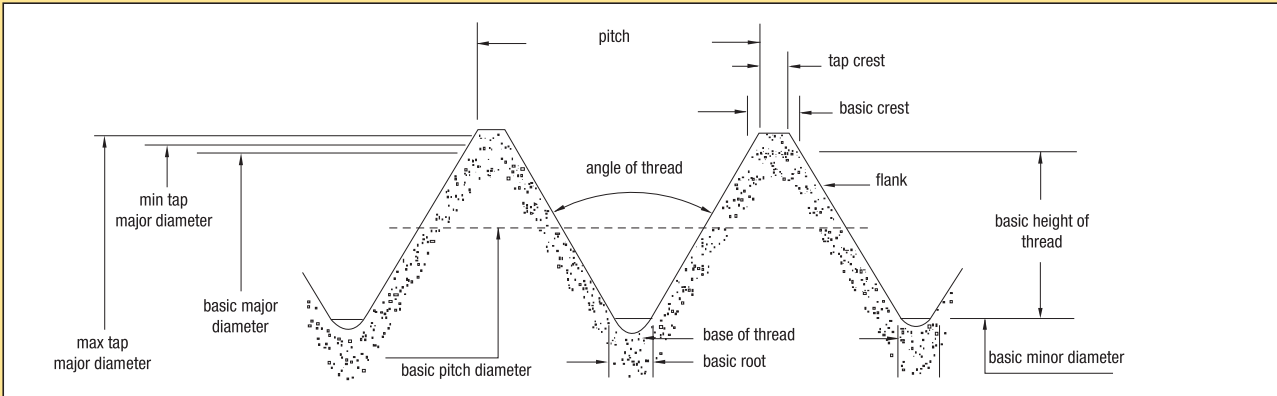

Reprinted with permission from United States Cutting Tool Institute (USCTI). Published by Kennametal Inc. © 2014. All rights reserved.

■ Tap Chamfers • DIN Taps

Taper Chamfer
7–10 Pitches

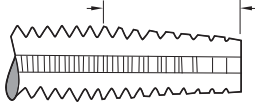

Plug Chamfer
3–5 Pitches

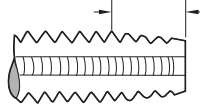

Modified Bottoming Chamfer
2–2.5 Pitches

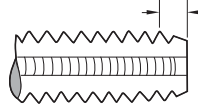

Full Bottoming Chamfer
1–2 Pitches

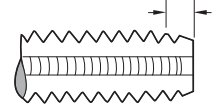

Hand Tap Chamfers

Form A (6–8 pitches)

The Form A chamfer has the longest standard chamfer ensuring easier starting. It requires less tapping torque because of more working teeth.

Form B/D (3.5–5 pitches)

The most common chamfers for use by hand or machine in through or blind holes. Form B applies to spiral-point taps and Form D applies to straight-flute and spiral-flute taps. This chamfer is more efficient than Form E or Form C chamfers.

Form C (2–2.5 pitches)

This short chamfer enables threading close to the bottom of blind holes. Due to the slightly longer chamfer and more working teeth, this chamfer is more efficient than a Form E chamfer.

Form E (1.5–2 pitches)

For threading close to the bottom of blind holes, the Form E chamfer is the least efficient chamfer available.

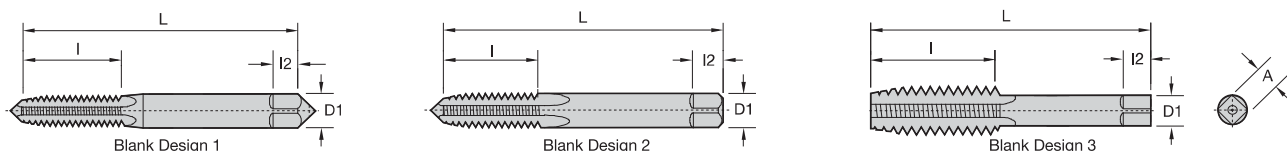

nominal diameter range (in)	machine screw size number (in)	nominal fractional diameter (in)	nominal metric diameter mm (in)	blank design number	overall length L	thread length l	square length l2	shank diameter D1	square size A
.052-.065	0 (.0600)	—	M1.6 (.0630)	1	1.63	.31	.19	.1410	.110
.065-.078	1 (.0730)	—	M1.8 (.0709)	1	1.69	.38	.19	.1410	.110
.078-.091	2 (.0860)	—	M2 (0787), M2.2 (.0866)	1	1.75	.44	.19	.1410	.110
.091-.104	3 (.0990)	—	M2.5 (.0984)	1	1.81	.50	.19	.1410	.110
.104-.117	4 (.1120)	—	—	1	1.88	.56	.19	.1410	.110
.117-.130	5 (.1250)	—	M3 (.1181)	1	1.94	.63	.19	.1410	.110
.130-.145	6 (.1380)	—	M3.5 (.1378)	1	2.00	.69	.19	.1410	.110
.145-.171	8 (.1640)	—	M4 (.1575)	1	2.13	.75	.25	.1680	.131
.171-.197	10 (.1900)	—	M4.5 (.1772), M5 (.1969)	1	2.38	.88	.25	.1940	.152
.197-.223	12 (.2160)	—	—	1	2.38	.94	.28	.2200	.165
.223-.260	—	1/4 (.2500)	M6 (.2362)	2	2.50	1.00	.31	.2550	.191
.260-.323	—	5/16 (.3125)	M7 (.2756), M8 (.3150)	2	2.72	1.13	.38	.3180	.238
.323-.395	—	3/8 (.3750)	M10 (.3937)	2	2.94	1.25	.44	.3810	.286
.395-.448	—	7/16 (.4375)	—	3	3.16	1.44	.41	.3230	.242
.448-.510	—	1/2 (.5000)	M12 (.4724)	3	3.38	1.66	.44	.3670	.275
.510-.573	—	9/16 (.5625)	M14 (.5512)	3	3.59	1.66	.50	.4290	.322
.573-.635	—	5/8 (.6250)	M16 (.6299)	3	3.81	1.81	.56	.4800	.360
.635-.709	—	11/16 (.6875)	M18 (.7087)	3	4.03	1.81	.63	.5420	.406
.709-.760	—	3/4 (.7500)	—	3	4.25	2.00	.69	.5900	.442
.760-.823	—	13/16 (.8125)	M20 (.7874)	3	4.47	2.00	.69	.6520	.489
.823-.885	—	7/8 (.8750)	M22 (.8661)	3	4.69	2.22	.75	.6970	.523
.885-.948	—	15/16 (.9375)	M24 (.9449)	3	4.91	2.22	.75	.7600	.570
.948-1.010	—	1 (1.0000)	M25 (.9843)	3	5.13	2.50	.81	.8000	.600
1.010-1.073	—	1-1/16 (1.0625)	M27 (1.0630)	3	5.13	2.50	.88	.8960	.672
1.073-1.135	—	1-1/8 (1.1250)	—	3	5.44	2.56	.88	.8960	.672
1.135-1.198	—	1-3/16 (1.1875)	M30 (1.1811)	3	5.44	2.56	1.00	1.0210	.766
1.198-1.260	—	1-1/4 (1.2500)	—	3	5.75	2.56	1.00	1.0210	.766
1.260-1.323	—	1-5/16 (1.3125)	M33 (1.2992)	3	5.75	2.56	1.06	1.1080	.831
1.323-1.385	—	1-3/8 (1.3750)	—	3	6.06	3.00	1.06	1.1080	.831
1.358-1.448	—	1-7/16 (1.4375)	M36 (1.4173)	3	6.06	3.00	1.13	1.2330	.925
1.448-1.510	—	1-1/2 (1.5000)	—	3	6.38	3.00	1.13	1.2330	.925
1.510-1.635	—	1-5/8 (1.6250)	M39 (1.5354)	3	6.69	3.19	1.13	1.3050	.979
1.635-1.760	—	1-3/4 (1.7500)	M42 (1.6535)	3	7.00	3.19	1.25	1.4300	1.072
1.760-1.885	—	1-7/8 (1.8750)	—	3	7.31	3.56	1.25	1.5190	1.139
1.885-2.010	—	2 (2.0000)	M48 (1.8898)	3	7.63	3.56	1.38	1.6440	1.233
2.010-2.135	—	2-1/8 (2.1250)	—	3	8.00	3.56	1.38	1.7690	1.327
2.135-2.260	—	2-1/4 (2.2500)	M56 (2.2047)	3	8.25	3.56	1.44	1.8940	1.420
2.260-2.385	—	2-3/8 (2.3750)	—	3	8.50	4.00	1.44	2.0190	1.514
2.385-2.510	—	2-1/2 (2.5000)	—	3	8.75	4.00	1.50	2.1000	1.575
2.510-2.635	—	2-5/8 (2.6250)	M64 (2.5197)	3	8.75	4.00	1.50	2.2250	1.669
2.635-2.760	—	2-3/4 (2.7500)	—	3	9.25	4.00	1.56	2.3500	1.762
2.760-2.885	—	2-7/8 (2.8750)	M72 (2.8346)	3	9.25	4.00	1.56	2.4750	1.856
2.885-3.010	—	3 (3.0000)	—	3	9.75	4.56	1.63	2.5430	1.907
3.010-3.135	—	3-1/8 (3.1250)	—	3	9.75	4.56	1.63	2.6680	2.001
3.135-3.260	—	3-1/4 (3.2500)	M80 (3.1496)	3	10.00	4.56	1.75	2.7930	2.095
3.260-3.385	—	3-3/8 (3.3750)	—	3	10.00	4.56	1.75	2.8830	2.162
3.385-3.510	—	3-1/2 (3.5000)	—	3	10.25	4.94	2.00	3.0080	2.256
3.510-3.635	—	3-5/8 (3.6250)	M90 (3.5433)	3	10.25	4.94	2.00	3.1330	2.350
3.635-3.760	—	3-3/4 (3.7500)	—	3	10.50	5.31	2.13	3.2170	2.413
3.760-3.885	—	3-7/8 (3.8750)	—	3	10.50	5.31	2.13	3.3420	2.506
3.885-4.010	—	4 (4.0000)	M100 (3.9370)	3	10.75	5.31	2.25	3.4670	2.600

Reprinted with permission from United States Cutting Tool Institute (USCTI). Published by Kennametal Inc. © 2014. All rights reserved.

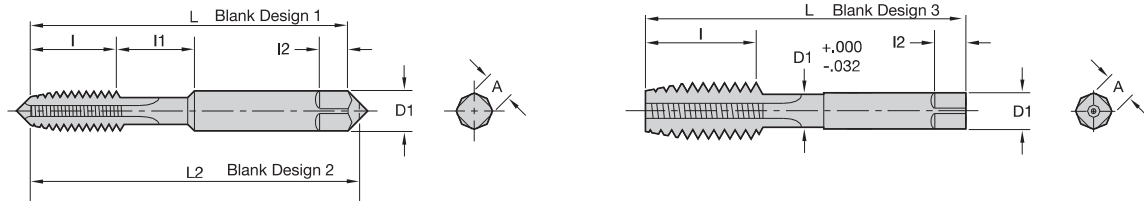

General Dimensions

Tap Dimensions — Inches

nominal diameter range (in)	machine screw size number (in)	nominal fractional diameter (in)	nominal metric diameter mm (in)	blank design number	overall length L	thread length I	neck length I1	square length I2	shank diameter D1	square size A
.104 .117	4 (.1120)	—	—	1	1.88	.31	.25	.19	.1410	.110
.117 .130	5 (.1250)	—	M3 (.1181)	1	1.94	.31	.31	.19	.1410	.110
.130 .145	6 (.1380)	—	M3.5 (.1378)	1	2.00	.38	.31	.19	.1410	.110
.145 .171	8 (.1640)	—	M4 (.1575)	1	2.13	.38	.38	.25	.1680	.131
.171 .197	10 (.1900)	—	M4.5 (.1772)	1	2.38	.50	.38	.25	.1940	.152
— —	— —	—	M5 (.1969)	—	—	—	—	—	—	—
.197 .223	12 (.2160)	—	—	1	2.38	.50	.44	.28	.2200	.165
.223 .260	—	1/4 (.2500)	M6 (.2362)	2	2.50	.63	.38	.31	.2550	.191
.260 .323	—	5/16 (.3125)	M7, M8 (.2756), (.3150)	2	2.72	.69	.44	.38	.3180	.238
.323 .395	—	3/8 (.3750)	M10 (.3937)	2	2.94	.75	.50	.44	.3810	.286
.395 .448	—	7/16 (.4375)	—	3	3.16	.88	—	.41	.3230	.242
.448 .510	—	1/2 (.5000)	M12 (.4724)	3	3.38	.94	—	.44	.3670	.275
.510 .573	—	9/16 (.5625)	M14 (.5541)	3	3.59	1.00	—	.50	.4290	.322
.573 .635	—	5/8 (.6250)	M16 (.6299)	3	3.81	1.09	—	.56	.4800	.360
.635 .709	—	11/16 (.6875)	M18 (.7087)	3	4.03	1.09	—	.63	.5420	.406
.709 .760	—	3/4 (.7500)	—	3	4.25	1.22	—	.69	.5900	.442
.760 .823	—	13/16 (.8125)	M20 (.7874)	3	4.47	1.22	—	.69	.6520	.489
.823 .885	—	7/8 (.8750)	M22 (.8661)	3	4.69	1.34	—	.75	.3670	.523
.885 .948	—	15/16 (.9375)	M24 (.9449)	3	4.91	1.34	—	.75	.7600	.570
.948 1.010	—	1 (1.0000)	M25 (.9843)	3	5.13	1.50	—	.81	.8000	.600

Reprinted with permission from United States Cutting Tool Institute (USCTI). Published by Kennametal Inc. © 2014. All rights reserved.

NOTE: Thread length I is based on a length of 12 pitches of the UNC thread series. Thread length “I” is a minimum value and has no tolerance. When thread length “I” is added to neck length “I1”, the total shall be no less than the minimum USCTI Table 302 thread length “I”. Unless otherwise specified, all tolerances are in accordance with USCTI Table 302. For eccentricity tolerances, see USCTI Table 317. Table 302 is provided for reference only. The Kennametal tap dimensions may differ.

Tolerances

element	nominal diameter range (in)	direction	tolerance (in)
length overall — L	.0520–1.0100	plus or minus	.031
	1.0100–4.0100	plus or minus	.063
length of thread — I	.0520–.2230	plus or minus	.047
	.2230–.5100	plus or minus	.063
	.5100–1.5100	plus or minus	.094
	1.5100–4.0100	plus or minus	.125
length of square — I2	.0520–1.0100	plus or minus	.031
	1.0100–4.0100	plus or minus	.063
diameter of shank — d1	.0520–.2230	minus	.0015
	.2230–.6350	minus	.0015
	.6350–1.0100	minus	.0020
	1.0100–1.5100	minus	.0020
	1.5100–2.0100	minus	.0030
	2.0100–4.0100	minus	.0030
size of square — a	.0520–.5100	minus	.004
	.5100–1.0100	minus	.006
	1.0100–2.0100	minus	.008
	2.0100–4.0100	minus	.010

Reprinted with permission from United States Cutting Tool Institute (USCTI). Published by Kennametal Inc. © 2014. All rights reserved.

Special Taps

Unless otherwise specified: Special taps over 1.010–1.510" diameter inclusive, having 14 or more threads per inch or 1,75mm pitch and finer, and sizes over 1.510" diameter with 10 or more threads per inch or 2,5mm pitch and finer, are made to general dimensions shown in USCTI Table 303. Special tap thread limits are determined using the formulas shown in USCTI Table 331 for Unified Inch Screw Threads and USCTI Table 341 for metric m-profile screw threads.

NOTE: Tap sizes .395" and smaller have an external center on the thread end (may be removed on bottoming taps). Sizes .125" and smaller have an external centre on the shank end. Sizes .224–.395" have truncated partial cone centres on the shank end (length of cone approximately 1/4 of diameter of shank). Sizes over .395" have internal centres on both the thread and shank ends.

For standard thread limits and tolerances for Unified Inch Screw Threads, see USCTI Table 327, and for metric threads, see USCTI Table 337.

For eccentricity tolerances of tap elements, see USCTI Table 317.



Technical Information

Standard Pipe Tap Dimensions • Straight and Taper • Ground Thread •
Reference USCTI Table 311

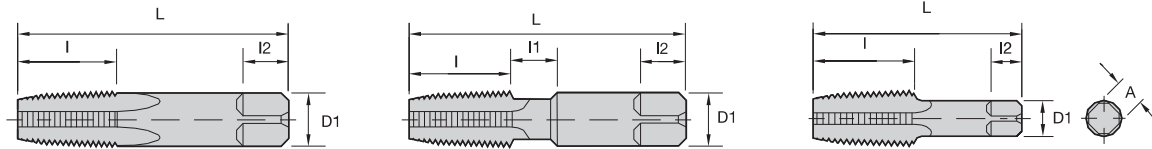

General Dimensions

nominal size (in)	dimensions (in)					
	overall length L	thread length l	square length l2	shank diameter D1	square size A	optional neck length l1
1/16	2.13	.69	.38	.3125	.234	.375
1/8	2.13	.75	.38	.3125	.234	-
1/8	2.13	.75	.38	.4375	.328	.375
1/4	2.44	1.06	.44	.5625	.421	.375
3/8	2.56	1.06	.50	.7000	.531	.375
1/2	3.13	1.38	.63	.6875	.515	-
3/4	3.25	1.38	.69	.9063	.679	-
1	3.75	1.75	.81	1.1250	.843	-
1-1/4	4.00	1.75	.94	1.3125	.984	-
1-1/2	4.25	1.75	1.00	1.5000	1.125	-
2	4.25	1.75	1.13	1.8750	1.406	-
2-1/2	5.50	2.56	1.25	2.2500	1.687	-
3	6.00	2.63	1.38	2.6250	1.968	-
3-1/2	6.50	2.69	1.50	2.8125	2.108	-
4	6.75	2.75	1.56	3.0000	2.250	-

Tolerances

element	range	direction	tolerance
length overall — L	1/16–3/4 inc.	plus/minus	.031
	1–4 inc.	plus/minus	.063
length of thread — l	1/16–3/4 inc.	plus/minus	.063
	1–1-1/4 inc.	plus/minus	.094
length of square — l2	1-1/2–4	plus/minus	.125
	1/16–3/4 inc.	plus/minus	.031
diameter of shank — d1	1–4 inc.	plus/minus	.063
	1/4–1 inc.	minus	.0020
size of square — a	1-1/4–4 inc.	minus	.0030
	1/16–1/8	minus	.004
	1/4–3/4 inc.	minus	.006
	1–4 inc.	minus	.008

Reprinted with permission from United States Cutting Tool Institute (USCTI). Published by Kennametal Inc. © 2014. All rights reserved.

Tapping

American National Standard Taper Pipe Thread Form (NPT)
 Aeronautical National Taper Pipe Thread Form (ANPT)
 Dryseal American National Standard Taper Pipe Thread Form (NPFT)

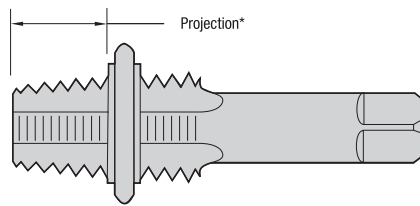

nominal size (in)	threads per inch	projection* (in)	projection tolerance + / -	taper per foot limits		length L1	tap drill size** NPT, ANPT, NPFT
				min	max		
1/16	27	.312	.063	.719	.781	.160	C
1/8	27	.312	.063	.719	.781	.1615	Q
1/4	18	.459	.063	.719	.781	.2278	7/16
3/8	18	.454	.063	.719	.781	.240	9/16
1/2	14	.579	.063	.719	.781	.320	45/64
3/4	14	.565	.063	.719	.781	.339	29/32
1	11-1/2	.678	.094	.719	.781	.400	1-9/64
1-1/4	11-1/2	.686	.094	.719	.781	.420	1-31/64
1-1/2	11-1/2	.699	.094	.719	.781	.420	1-23/32
2	11-1/2	.667	.094	.719	.781	.436	2-3/16
2-1/2	8	.925	.094	.734	.781	.682	2-39/64
3	8	.925	.094	.734	.781	.766	3-15/64
3-1/2	8	.938	.125	.734	.781	.821	—
4	8	.950	.125	.734	.781	.844	—

*Distance from small end of tap projects through L1 taper thread ring gage.

**Recommended size given permits direct tapping without reaming the hole, but only gives a full thread for approximately the L1 length.

Reprinted with permission from United States Cutting Tool Institute (USCTI). Published by Kennametal Inc. © 2014. All rights reserved.

■ Pipe Taps

General-purpose pipe taps are appropriate for threading a wide variety of materials, both ferrous and non-ferrous.

Ground thread pipe taps are standard in American Standard Pipe Form (NPT) and American Standard Dryseal Pipe Form (NPFT). NPT threads require the use of a sealer, like Teflon® tape or pipe compound. Dryseal taps are used to tap fittings, which will give a pressure-tight joint without the use of a sealer.

The nominal size of a pipe tap is that of the pipe fitting to be tapped, not the actual size of the tap. The thread tapers 3/4" per foot.

All pipe taps are furnished with 2-1/2–3-1/2 thread chamfer.

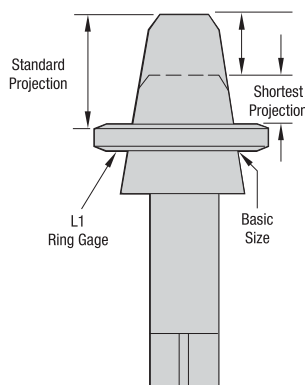

Short projection pipe taps are made with a projection shorter than standard for taper pipe tapping where the depth of tapping is limited.

Special short projection taper pipe taps can be furnished with American National Standard Taper Pipe thread (ANPT) or Dryseal American National Standard Taper Pipe thread (NPFT, PTF-SAE Short, or PTF-SPL Extra Short).

For information on short projection pipe taps and hole preparation for NPT, NPFT, and ANPT internal pipe threads, consult Kennametal Technical Bulletins.

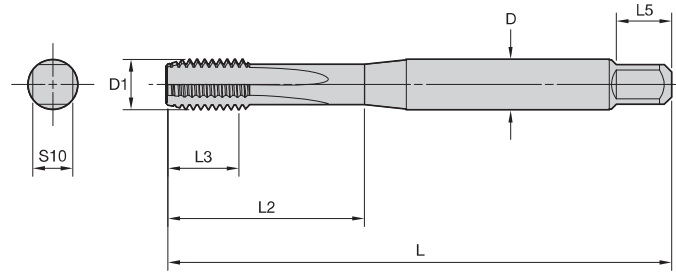

■ DIN 371

D1	pitch	D	L	L3*	L2	L5	S10
M3	0,5	3,5	56	11	18	6	2,7
M3,5	0,6	4	56	12	20	6	3
M4	0,7	4,5	63	13	21	6	3,4
M4,5	0,75	6	70	16	25	8	4,9
M5	0,8	6	70	16	25	8	4,9
M6	1	6	80	19	30	8	4,9
M7	1	7	80	19	30	8	5,5
M8	0,75	8	80	18	30	9	6,2
M8	1,25	8	90	22	35	9	6,2
M9	0,75	9	80	18	30	10	7
M9	1,25	9	90	22	35	10	7
M10	1	10	90	20	35	11	8
M10	1,5	10	100	24	39	11	8

*Maximum

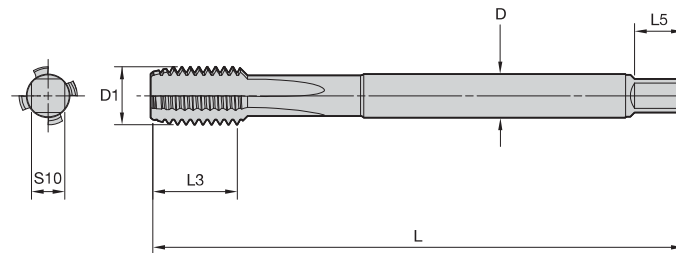

■ DIN 376

D1	pitch	D	L	L3*	L5	S10
M8	1,25	6	90	22	8	4,9
M9	1,25	7	90	22	8	5,5
M10	1,5	7	100	24	8	5,5
M11	1,5	8	100	24	9	6,2
M12	1,75	9	110	28	10	7
M14	2	11	110	30	12	9
M16	2	12	110	32	12	9
M18	2,5	14	125	34	14	11
M20	2,5	16	140	34	15	12
M22	2,5	18	140	34	17	14,5
M24	3	18	160	38	17	14,5
M27	3	20	160	38	19	16
M30	3,5	22	180	45	21	18
M33	3,5	25	180	50	23	20
M36	4	28	200	56	25	22
M39	4	32	200	60	27	24
M42	4,5	32	200	60	27	24
M45	4,5	36	220	65	32	29

*Maximum

Tapping

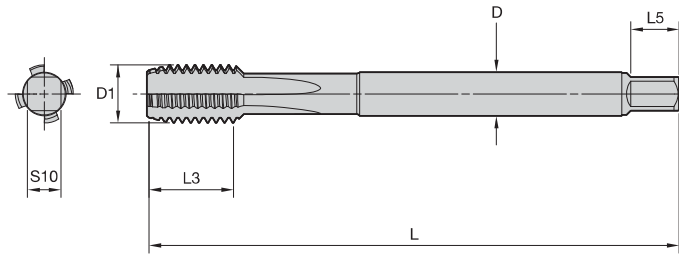

■ DIN 374

D1	pitch		D	L	L3*	L5	S10
	minimum	maximum					
M8	0,2	0,75	6	80	18	8	4,9
M8	—	1	6	90	22	8	4,9
M9	0,2	0,75	7	80	18	8	5,5
M9	—	1	7	90	22	8	5,5
M10	0,2	1	7	90	20	8	5,5
M10	—	1,25	7	100	24	8	5,5
M11	0,35	1	8	90	20	9	6,2
M12	0,35	1,5	9	100	22	10	7
M14	0,35	1,5	11	100	22	12	9
M16	0,35	1,5	12	100	22	12	9
M16	—	2	12	110	32	12	9
M18	0,35	1,5	14	110	25	14	11
M18	—	2	14	125	34	14	11
M20	0,35	1,5	16	125	25	15	12
M20	—	2	16	140	34	15	12
M22	0,35	1,5	18	125	25	17	14,5
M22	—	2	18	140	34	17	14,5
M24	0,35	2	18	140	28	17	14,5
M27	0,35	2	20	140	28	19	16
M30	0,35	2	22	150	28	21	18
M30	—	3	22	180	45	21	18

*Maximum



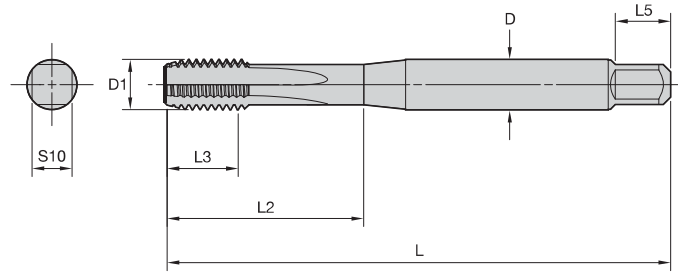

■ JIS Type 2 Metric Coarse

metric dimensions							
D1	pitch	D	L	L3	L2	L5	S10
M3	0,5	4	46	11	19	6	3,2
M3,5	0,6	4	48	13	20	6	3,2
M4	0,7	5	52	13	21	7	4
M4,5	0,75	5	55	13	21	7	4
M5	0,8	5,5	60	16	24	7	4,5
M6	1	6	62	19	29	7	4,5

Tapping

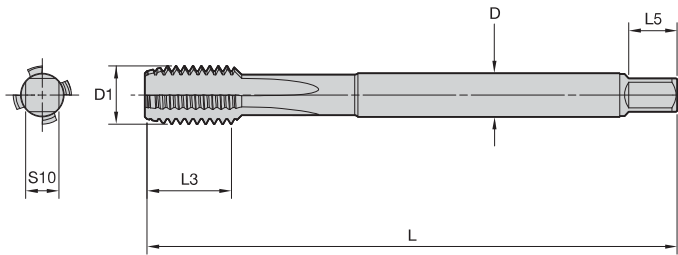

■ JIS Type 3 Metric Coarse

metric dimensions							
D1	pitch	D	L	L3	L5	S10	
M8	1,25	6,2	70	22	8	5	
M9	1,25	7	72	22	8	5,5	
M10	1,5	7	75	24	8	5,5	
M11	1,5	8	80	25	9	6	
M12	1,75	8,5	82	29	9	6,5	
M14	2	10,5	88	30	11	8	
M16	2	12,5	95	32	13	10	
M18	2,5	14	100	37	14	11	
M20	2,5	15	105	37	15	12	
M22	2,5	17	115	38	16	13	
M24	3	19	120	45	18	15	

■ Thread Forming • M and MF

tap size	pitch		65% thread						70% thread						75% thread					
			Metric			Inch			Metric			Inch			Metric			Inch		
	M	MF	smallest drill	theoretical	largest drill	smallest drill	theoretical	largest drill	smallest drill	theoretical	largest drill	smallest drill	theoretical	largest drill	smallest drill	theoretical	largest drill	smallest drill	theoretical	largest drill
M1.6	0.35	-	1.40	1.45	1.50	0.0551	0.0571	0.0591	1.40	1.43	1.50	0.0551	0.0563	0.0591	1.40	1.42	1.50	0.0551	0.0559	0.0591
M1.7	0.35	-	1.50	1.58	1.60	0.0591	0.0623	0.0630	1.50	1.57	1.60	0.0591	0.0620	0.0630	1.50	1.56	1.60	0.0591	0.0617	0.0630
M1.8	0.35	-	1.60	1.65	1.70	0.0630	0.0650	0.0669	1.60	1.63	1.70	0.0630	0.0642	0.0669	1.60	1.62	1.70	0.0630	0.0638	0.0669
M2	0.4	-	1.80	1.82	1.90	0.0709	0.0717	0.0748	1.80	1.81	1.90	0.0709	0.0713	0.0748	1.80	1.80	1.80	0.0709	0.0709	0.0709
M2.2	0.45	-	2.00	2.00	2.00	0.0787	0.0787	0.0787	1.98	1.99	2.00	0.0781	0.0783	0.0787	1.90	1.97	1.98	0.0748	0.0776	0.0781
M2.5	0.45	-	2.30	2.30	2.30	0.0906	0.0906	0.0906	2.20	2.29	2.30	0.0866	0.0902	0.0906	2.20	2.27	2.30	0.0866	0.0894	0.0906
M2.6	0.45	-	2.40	2.43	2.44	0.0945	0.0957	0.0960	2.40	2.42	2.44	0.0945	0.0953	0.0960	2.40	2.41	2.44	0.0945	0.0949	0.0960
M3	0.5	-	2.78	2.78	2.80	0.1094	0.1094	0.1094	2.71	2.76	2.78	0.1065	0.1087	0.1094	2.71	2.75	2.78	0.1065	0.1083	0.1094
M3.5	0.6	-	3.20	3.23	3.26	0.1260	0.1272	0.1285	3.20	3.21	3.26	0.1260	0.1264	0.1285	3.18	3.19	3.20	0.1250	0.1256	0.1260
M4	0.7	-	3.66	3.69	3.70	0.1440	0.1453	0.1457	3.66	3.67	3.70	0.1440	0.1445	0.1457	3.60	3.64	3.66	0.1417	0.1433	0.1440
M4.5	0.75	-	4.10	4.17	4.20	0.1614	0.1642	0.1654	4.10	4.14	4.20	0.1614	0.1630	0.1654	4.10	4.12	4.20	0.1614	0.1622	0.1654
M5	0.8	-	4.62	4.65	4.70	0.1820	0.1831	0.1850	4.60	4.62	4.62	0.1811	0.1819	0.1820	4.50	4.59	4.60	0.1772	0.1807	0.1811
M6	1	-	5.56	5.56	5.60	0.2188	0.2189	0.2205	5.50	5.52	5.56	0.2165	0.2173	0.2188	5.41	5.49	5.50	0.2130	0.2161	0.2165
M7	1	-	6.53	6.56	6.60	0.2570	0.2583	0.2598	6.50	6.52	6.53	0.2559	0.2567	0.2570	6.40	6.49	6.50	0.2520	0.2555	0.2559
M8	1.25	-	7.40	7.45	7.50	0.2913	0.2933	0.2953	7.40	7.41	7.50	0.2913	0.2917	0.2953	7.30	7.36	7.40	0.2874	0.2898	0.2913
M10	1.5	-	9.30	9.34	9.35	0.3661	0.3677	0.3680	9.20	9.29	9.30	0.3622	0.3657	0.3661	9.20	9.24	9.30	0.3622	0.3638	0.3661
M12	1.75	-	11.20	11.23	11.30	0.4409	0.4421	0.4449	11.15	11.17	11.20	0.4375	0.4398	0.4409	11.10	11.11	11.15	0.4370	0.4374	0.4375
M14	2	-	13.10	13.12	13.50	0.5157	0.5165	0.5315	13.00	13.05	13.10	0.5118	0.5138	0.5157	12.80	12.98	13.00	0.5039	0.5110	0.5118
M16	2	-	15.10	15.12	15.50	0.5945	0.5953	0.6102	15.00	15.05	15.10	0.5906	0.5925	0.5945	14.50	14.98	15.00	0.5709	0.5898	0.5906
M18	2.5	-	16.50	16.90	17.00	0.6496	0.6654	0.6693	16.50	16.81	17.00	0.6496	0.6618	0.6693	16.50	16.73	17.00	0.6496	0.6587	0.6693
M20	2.5	-	18.50	18.90	19.00	0.7283	0.7441	0.7480	18.50	18.81	19.00	0.7283	0.7406	0.7480	18.50	18.73	19.00	0.7283	0.7374	0.7480
M22	3	-	20.50	20.90	21.00	0.8071	0.8228	0.8268	20.50	20.81	21.00	0.8071	0.8193	0.8268	20.50	20.73	21.00	0.8071	0.8161	0.8268
M24	3	-	22.50	22.67	22.77	0.8858	0.8925	0.8965	22.50	22.57	22.77	0.8858	0.8886	0.8965	22.44	22.47	22.50	0.8840	0.8846	0.8858



■ Pipe Taps

pipe tap size	NPT and NPTF		NPSM	NPSC	NPSF
	without reamer	with reamer			
1/16-27	0.2420	0.2344	—	0.2500	0.2460
1/8-27	0.3320	0.3281	0.3580	0.3320	0.3390
1/4-18	0.4375	0.4219	0.4688	0.4375	0.4375
3/8-18	0.5625	0.5625	0.6030	0.5781	0.5781
1/2-14	0.7031	0.6875	0.7480	0.7087	0.7087
3/4-14	0.9063	0.8906	0.9531	0.9219	0.9219
1-11 1/2	1.1406	1.1250	1.2031	1.1563	1.1563
1 1/4-11 1/2	1.4844	1.4688	1.5460	1.5000	—
1 1/2-11 1/2	1.7188	1.7031	1.7813	1.7344	—
2-11 1/2	2.1875	2.1719	2.2500	2.2031	—



Tapping

**Through Holes
Push Chips**



Spiral Point

LHSF



- Spiral point or LHSF (Left-Hand Spiral Flute).
- Ideal for materials with long chips.

**Blind Holes
Pull Chips**



RHSF



- RHSF (Right-Hand Spiral Flute).
- Ideal for materials with long chips.

**Blind or Through Holes
Store Chips**



STFL



- STFL (Straight Flute).
- Ideal for materials with short chips.

**Blind or Through Holes
No Chips**



Forming Tap



- Forming.
- Ideal for ductile materials <32 HRC.

■ Unified Inch Screw Threads

thread size/pitch	recommended tap limits ¹		min all classes (Basic)	internal thread pitch diameter limits	
	class 2B	class 3B		max class 2B	max class 3B
0 - 80	H2	H2	0.0519	0.0542	0.0536
1 - 64	H2	H2	0.0629	0.0655	0.0648
1 - 72	H2	H2	0.0640	0.0665	0.0659
2 - 56	H2	H2	0.0744	0.0772	0.0765
2 - 64	H2	H2	0.0759	0.0786	0.0779
3 - 48	H3	H2	0.0855	0.0885	0.0877
3 - 56	H2	H2	0.0874	0.0902	0.0895
4 - 40	H3	H2	0.0958	0.0991	0.0982
4 - 48	H3	H2	0.0985	0.1016	0.1008
5 - 40	H3	H2	0.1088	0.1121	0.1113
5 - 44	H3	H2	0.1102	0.1134	0.1126
6 - 32	H3	H2	0.1177	0.1214	0.1204
6 - 40	H3	H2	0.1218	0.1252	0.1243
8 - 32	H3	H3	0.1437	0.1475	0.1465
8 - 36	H3	H3	0.1460	0.1496	0.1487
10 - 24	H3	H3	0.1629	0.1672	0.1661
10 - 32	H3	H3	0.1697	0.1736	0.1726
12 - 24	H3	H3	0.1889	0.1933	0.1922
12 - 28	H3	H3	0.1928	0.1970	0.1959
1/4 - 20	H5	H3	0.2175	0.2224	0.2211
1/4 - 28	H4	H3	0.2268	0.2311	0.2300
5/16 - 18	H5	H3	0.2764	0.2817	0.2803
5/16 - 24	H4	H3	0.2854	0.2902	0.2890
3/8 - 16	H5	H3	0.3344	0.3401	0.3387
3/8 - 24	H4	H3	0.3479	0.3528	0.3516
7/16 - 14	H5	H3	0.3911	0.3972	0.3957
7/16 - 20	H5	H3	0.4050	0.4104	0.4091
1/2 - 13	H5	H4	0.4500	0.4565	0.4548
1/2 - 20	H5	H3	0.4675	0.4731	0.4717
9/16 - 12	H5	H4	0.5084	0.5152	0.5135
9/16 - 18	H5	H3	0.5264	0.5323	0.5308
5/8 - 11	H5	H4	0.5660	0.5732	0.5714
5/8 - 18	H5	H3	0.5889	0.5949	0.5934
3/4 - 10	H5	H4	0.6850	0.6927	0.6907

(continued)

¹Tap H limit selected for 3B will also produce thread to 2B.

NOTE: The above recommended taps normally produce the class of thread indicated in average materials when used with reasonable care. However, if the specified tap does not provide a satisfactory gage fit, choose an alternate tap limit.



■ Unified Inch Screw Threads *(continued)*

thread size/pitch	recommended tap limits ¹		internal thread pitch diameter limits		
	class 2B	class 3B	min all classes (Basic)	max class 2B	max class 3B
3/4 - 16	H5	H4	0.7094	0.7159	0.7143
7/8 - 9	H6	H4	0.8028	0.8110	0.8089
7/8 - 14	H6	H4	0.8286	0.8356	0.8339
1" - 8	H6	H5	0.9188	0.9276	0.9254
1" - 12	H6	H4	0.9459	0.9535	0.9516
1-1/8 - 7	H8	H6	1.0322	1.0416	1.0393
1-1/8 - 8	H8	H6	1.0438	1.0528	1.0505
1-1/8 - 12	H6	H5	1.0709	1.0787	1.0768
1-1/4 - 7	H8	H6	1.1572	1.1668	1.1644
1-1/4 - 8	H8	H6	1.1688	1.1780	1.1757
1-1/4 - 12	H6	H5	1.1959	1.2039	1.2019
1-3/8 - 6	H8	H6	1.2667	1.2771	1.2745
1-3/8 - 8	H8	H6	1.2938	1.3031	1.3008
1-3/8 - 12	H6	H5	1.3209	1.3291	1.3270
1-1/2 - 6	H8	H6	1.3917	1.4022	1.3996
1-1/2 - 8	H8	H6	1.4188	1.4283	1.4259
1-1/2 - 12	H6	H5	1.4459	1.4542	1.4522
1-3/4 - 5	H8	H7	1.6201	1.6317	1.6288
2 - 4 1/2	H8	H7	1.8557	1.8681	1.8650

¹Tap H limit selected for 3B will also produce thread to 2B.



■ Tap Recommendations for Class 6H Metric Screw Threads

thread size		recommended tap limit number	internal thread product limits — class 6H			
nominal diameter (mm)	pitch (mm)		pitch diameter (mm)		pitch diameter (in)	
		min	max	min	max	
1,6	0,35	D3	1,373	1,458	.05406	.05740
2	0,4	D3	1,740	1,830	.06850	.07205
2,5	0,45	D3	2,208	2,303	.08693	.09067
3	0,5	D3	2,675	2,775	.10531	.10925
3,5	0,6	D4	3,110	3,222	.12244	.12685
4	0,7	D4	3,545	3,663	.13957	.14421
4,5	0,75	D4	4,013	4,131	.15789	.16264
5	0,8	D4	4,480	4,605	.17638	.18130
6	1	D5	5,350	5,500	.21063	.21654
7	1	D5	6,350	6,500	.25000	.25591
8	1,25	D5	7,188	7,348	.28299	.28929
10	1,5	D6	9,026	9,206	.35535	.36244
12	1,75	D6	10,863	11,063	.42768	.43555
14	2	D7	12,701	12,913	.50004	.50839
16	2	D7	14,701	14,913	.57878	.58713
20	2,5	D7	18,376	18,600	.72346	.73228
24	3	D8	22,051	22,316	.86815	.87858
30	3,5	D9	27,727	28,007	1.09161	1.10264
36	4	D9	33,402	33,702	1.31504	1.32685

In addition to the nominal size and pitch of a tap, there is another important dimensional factor to be considered when selecting a ground thread tap for a given job. This factor is the pitch diameter tap limit, "H" and "L". "H" represents (high) above basic pitch diameter; "L" (low) is below basic pitch diameter. Tap limits have been established to provide a choice in the selection of the tap size best suited to produce the class of thread desired.

Figure 1 illustrates the numbering system and the .0005" diameter increment separation between successive limits. Because the starting point is basic pitch diameter, dividing the limit number by two establishes, in thousandths of an inch, the amount the maximum tap pitch diameter is above basic in the "H" series and the amount the minimum tap pitch diameter is under basic in the "L" series.

Figure 2 illustrates the positioning of the tap limits in relation to the various classes of threads for a 1/4-20 size.

Figure 1

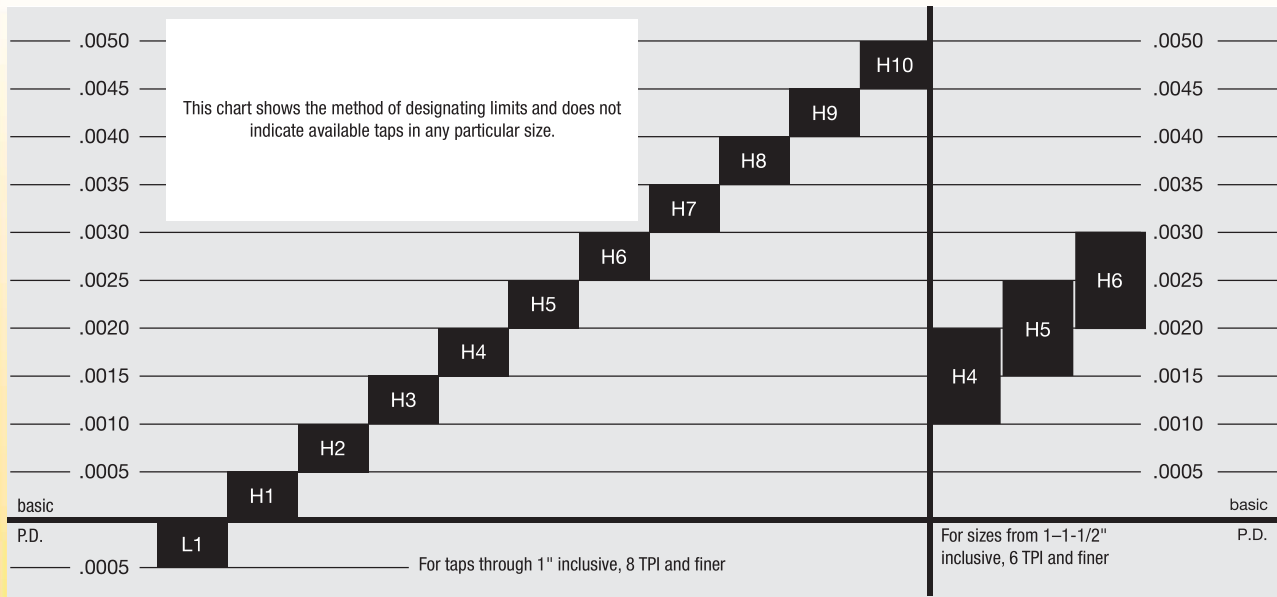
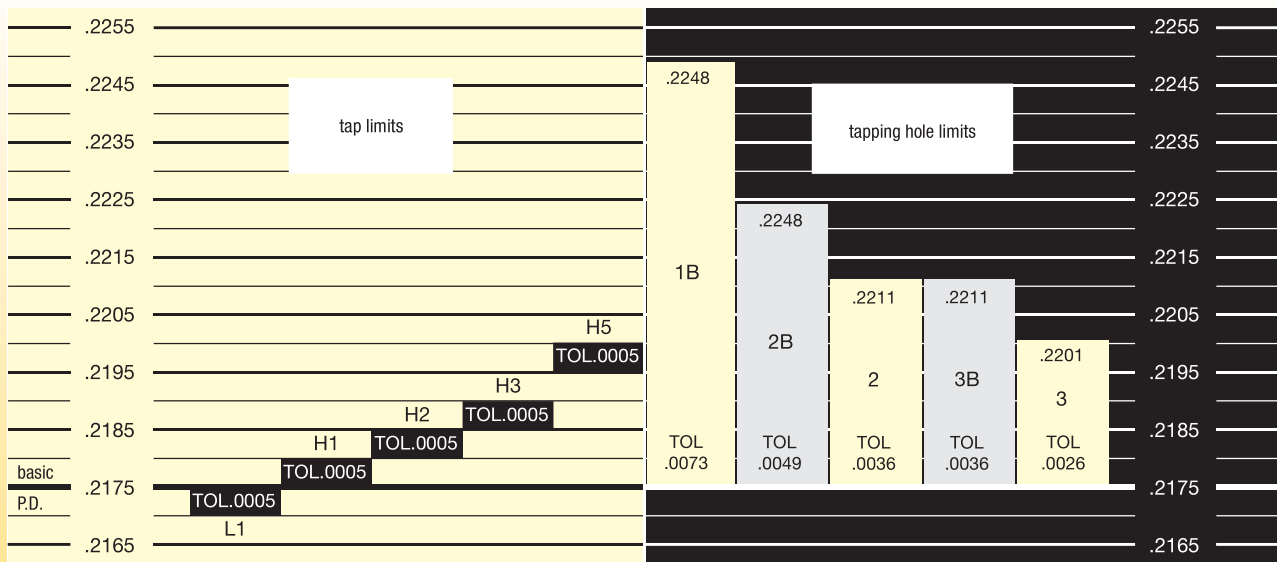

Figure 2

Class of Thread – 1/4-20 UNC and NC



+ μm

Internal Unified Thread

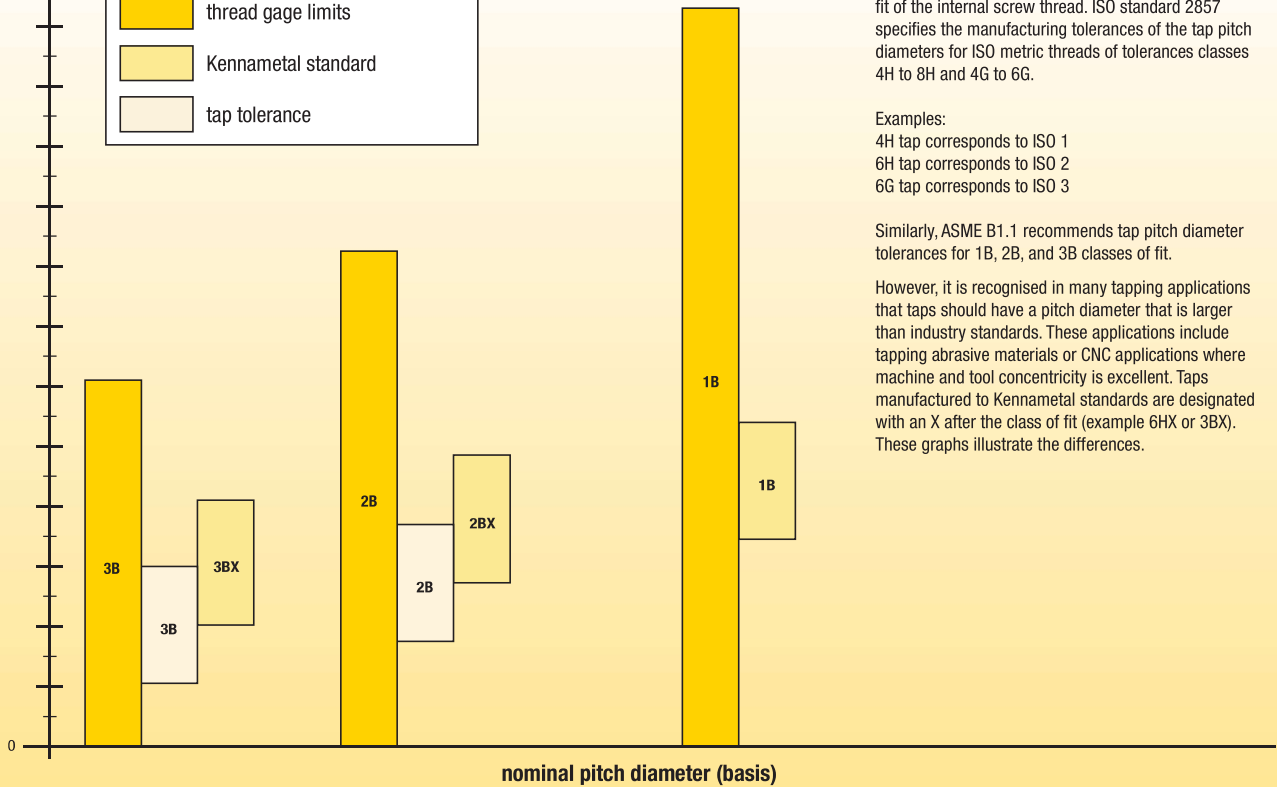
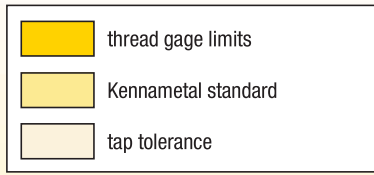

For the tap user's convenience, new generation Kennametal taps are sized for the intended class of fit of the internal screw thread. ISO standard 2857 specifies the manufacturing tolerances of the tap pitch diameters for ISO metric threads of tolerances classes 4H to 8H and 4G to 6G.

Examples:
 4H tap corresponds to ISO 1
 6H tap corresponds to ISO 2
 6G tap corresponds to ISO 3

Similarly, ASME B1.1 recommends tap pitch diameter tolerances for 1B, 2B, and 3B classes of fit.

However, it is recognised in many tapping applications that taps should have a pitch diameter that is larger than industry standards. These applications include tapping abrasive materials or CNC applications where machine and tool concentricity is excellent. Taps manufactured to Kennametal standards are designated with an X after the class of fit (example 6HX or 3BX). These graphs illustrate the differences.

+ μm

Internal Metric Thread

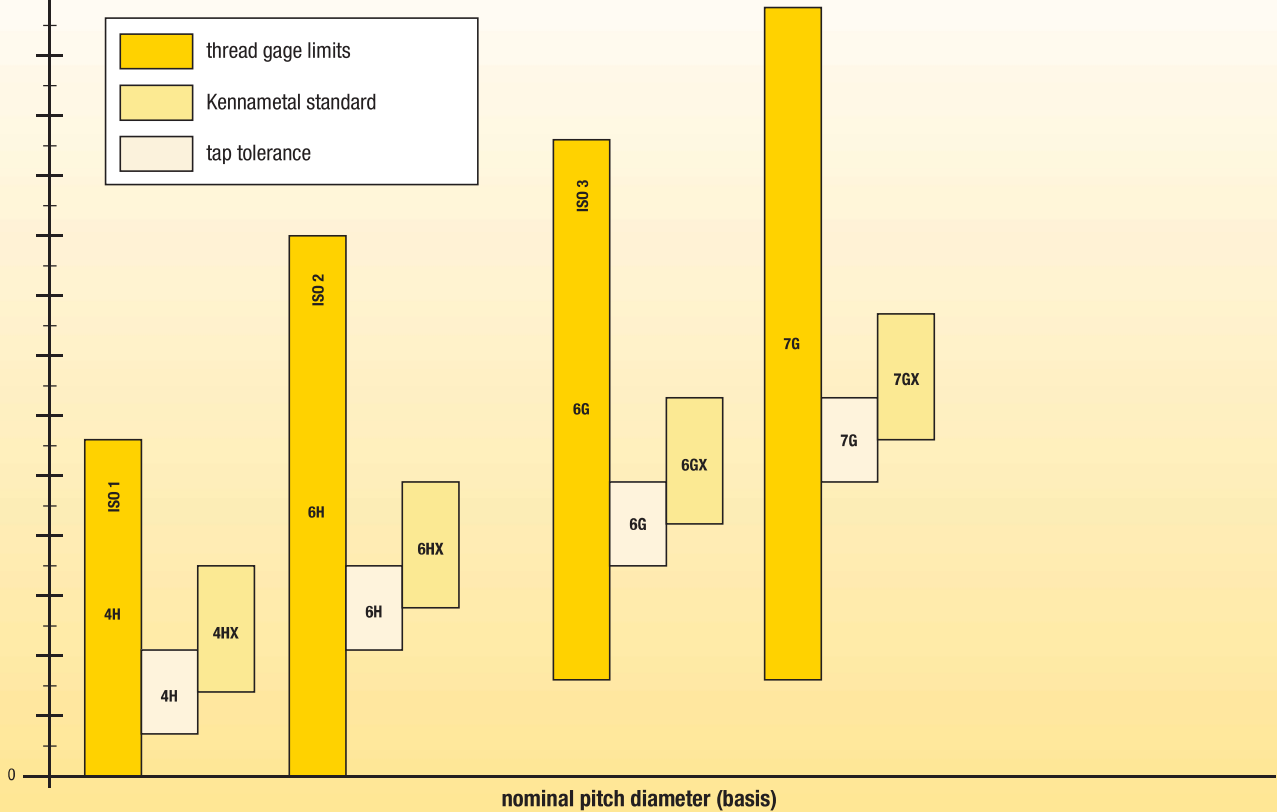
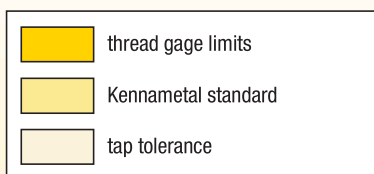

It is generally recognised that, in mass production, it is impossible to reproduce in exact detail the theoretically perfect product as laid out on the drawing board. The allowed slight variation between the theoretically perfect product drawing and each unit of the actual product is called the tolerance.

Allowance

An intentional difference in correlated dimensions of mating parts. It is the minimum clearance or maximum interference between such parts.

Angle of Thread

The angle included between the flanks of the thread measured in an axial plane.

Half Angle of Thread

The angle included between a flank of the thread and the normal (90°) to the axis, measured in an axial plane.

Lead of Thread

The distance a screw thread advances axially in one turn. On a single-thread screw, the lead and pitch are identical. On a double thread, the lead is 2x pitch; on a triple thread, the lead is 3x pitch, etc.

Major Diameter

The largest diameter of a straight-screw thread.

Minor Diameter

The smallest diameter of a straight-screw thread.

Pitch

The distance from a point on a screw thread to a corresponding point on the next thread measured parallel to the axis.

The pitch in inches = $\frac{1}{\text{number of threads per inch}}$

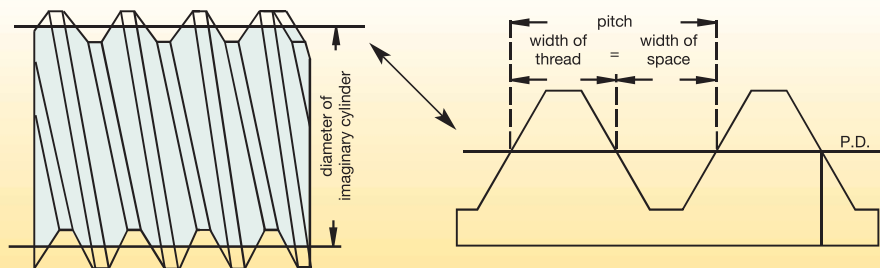
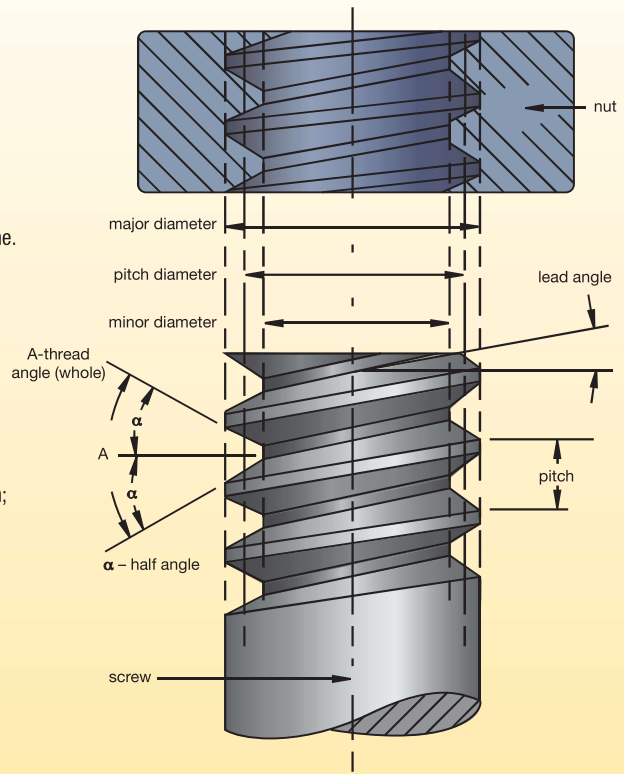

Pitch Diameter

On a straight-screw thread, the diameter of an imaginary cylinder that would pass through the threads at such points as to make equal the width of the threads and the width of the spaces cut by the surface of the cylinder.

A thread system is available for aerospace and other applications where high fatigue strength is required. The UNJ thread form is defined by ASME B1.15 and is similar to Military Specification MIL-S-8879. Screw thread assemblies consist of external and internal threads. In order to minimise the stress on the external UNJ thread, a controlled root radius is required that is equal to $0.15011P$ to $0.18042P$, where P is the thread pitch. Internal UNJ threads are not required to have a radius at either the major or minor diameters.

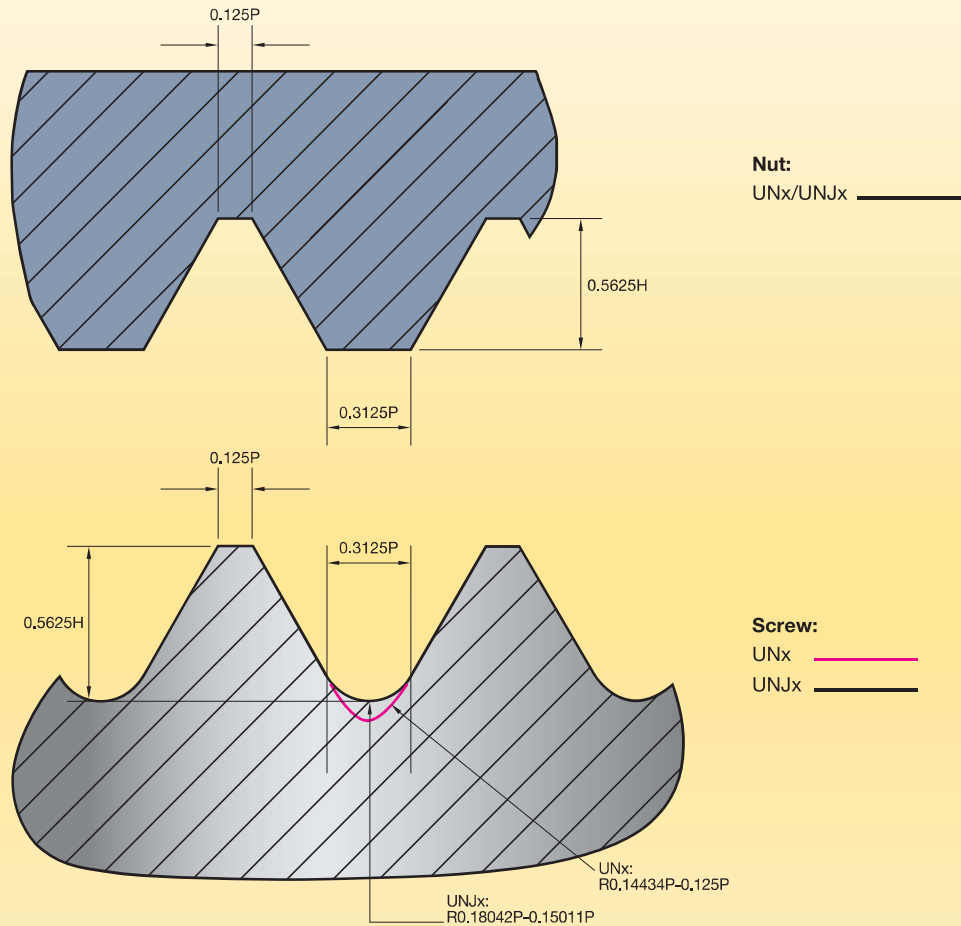

Because external UNJ threads must be produced with a defined root radius, standard UN tooling may not be used. However, internal UNF threads may be produced with ground thread UN taps sized to produce the proper class of fit. The tap does not need to be marked with a letter J. Attention must be paid to the tap drill since the minor diameter has to be specified so as to provide clearance with the root radius on the external thread.

For UNJ thread specifications, the reader is referred to ASME B1.15. Please note this standard includes Class 3 and Class 2 UNJ screw threads. However, only Class 3 UNJ threads meet the requirements of Military Specification MIL-S-8879. For Unified Inch (UN) thread specifications, refer to ASME B1.1.

Unlike cutting taps, which remove material, forming taps generate an internal screw thread by displacing material and forming it into the V-shaped thread. A common misconception is that a thread rolling action occurs. Instead, the threads are formed over the tapered entry

section of the tap as the tap rotates into the hole. A succession of deeper penetrating lobes over the entry plastically displaces material radially between the tap's thread flanks until the entry length is reached. At this point, the thread is fully formed at the correct thread height.

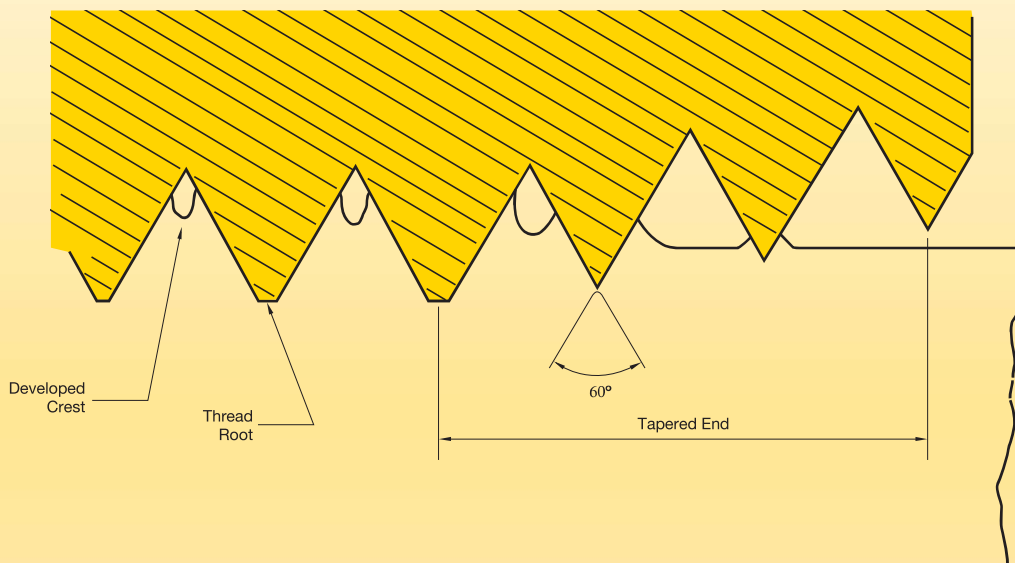

Forming taps have numerous advantages over cutting taps. The most obvious advantage is that forming taps do not create chips. There are no chip removal problems. Bird nesting is a situation that occurs when chips wrap around the shank of spiral-fluted taps when tapping blind holes in long chipping materials. Forming taps help this to be avoided. Since forming taps avoid this problem, they are stronger and more resistant to breakage. Another misconception is that forming taps produce stronger threads. Although the forming process strain hardens the thread flanks, it has very little effect on the major diameter, the location where internal threads strip.

Forming taps can only be used in ductile materials. Due to increased friction relative to cutting, forming taps require higher torque than cutting taps. In some situations, oil-based lubrications are required, and this might not be convenient on CNC machining centres that use water soluble coolant. In this situation, the lubricant concentration should be increased.

Since forming taps displace material, larger diameter pre-tap holes are required. This is especially important when converting from cutting taps to forming taps. If a cutting tap hole size is used, the displaced material will over-fill the tap's threads and breakage will result. Please consult hole size charts for forming taps.

coating	properties and application	precautions
Titanium Nitride (TiN)	Proprietary TiN coating (hardness 2300 Vickers) offers significantly improved wear life and thread finish, often at higher tapping speeds, in a broad range of materials, especially steels, irons, and plastics. Golden colour.	Use with caution in non-ferrous materials such as aluminium because of tendency to gall.
Titanium Carbonitride (TiCN)	Proprietary TiCN coating (hardness 3000 Vickers) is harder, tougher, and more wear resistant than TiN under conditions of moderate cutting temperatures. Like TiN, TiCN may be used at higher cutting speeds in a broad range of materials, especially steels and irons. Blue-grey colour.	Use with caution in non-ferrous materials such as aluminium because of tendency to gall. TiAlN is a better choice when used at extreme temperatures.
Titanium Nitride + Chromium Carbide Carbon (TiN + CrC/C)	Proprietary coating (hardness 2300 Vickers) that combines the wear resistance of smooth TiN coating with a lubricious top layer of chromium carbide carbon. Effective in stainless steel and non-ferrous materials including aluminium and titanium. Ideal choice for 300 series stainless steels, wrought, and die cast aluminiums. Black/grey colour.	Effective in both ferrous and non-ferrous materials.
Titanium Aluminium Nitride (TiAlN)	Nanolayer TiAlN coating (hardness 3300 Vickers) offers improved wear life and thread finish, especially in conditions where high temperatures can be generated. Use for PH stainless steels and nickel-based alloys like INCONEL®. Violet/grey colour.	Use with caution in non-ferrous materials because of tendency to gall.
Chromium Nitride (CrN)	CrN is medium hard (hardness 1800 Vickers) and has a lower wear resistance than TiN, TiCN, and TiAlN. However, unlike these coatings, CrN does not gall when used in some non-ferrous work materials. Use for brass, bronze, zinc alloys, and magnesium alloys. Silver colour.	Ineffective in ferrous materials.
Nitride	Hardened case extends wear life in abrasive materials. Use for aluminium and other non-ferrous materials.	Avoid on taper pipe, fast spiral, and small diameter (<#6) or fine pitch taps due to tendency for thread chipping.
Oxide	Helps prevent galling in ferrous (iron-based) materials. For free machining steel. Use for steels, stainless steels, and irons.	Has a tendency to cause galling in non-ferrous materials such as aluminium.
Nitride and Oxide	Combines the benefits of nitride and oxide surface treatments. For steels, stainless steels, and nickel alloys.	See precautions for nitride and oxide surface treatments.

Factors when trying to determine the best tapping speeds:

- Material to be tapped
- Length of chamfer on tap
- Percentage of full thread to be cut
- Length of hole (depth of thread)
- Pitch of thread
- Cutting fluids
- Machine equipment
- Horizontal or vertical tapping

The best and most efficient operating speeds for taps cannot be calculated with the same certainty, as for many other metalcutting tools.

With other tools, the feed per revolution can be set at any desired point and can be varied as conditions demand. Taps, on the other hand, must always be advanced at a rate equal to one pitch for every revolution. The style of tap may vary the conditions.

For example, with a bottoming tap, the first thread on each land cuts the full height of thread, while, with a taper or starting tap, a number of threads do their share of the cutting before the full height of thread is reached.

The depth of thread also varies, depending on the pitch. The coarser the thread, the greater the advance of the tap per revolution and the greater the amount of material removed.

The method of feeding the tap, and the type of equipment for driving, also influences the permissible speeds. If taps are mechanically fed at the proper rate of advance, they can be operated at higher speeds than if they are required to feed themselves and pull some part of the machine along with them.

Speeds may be modified to take into account any or all of these factors:

- Speeds must be lowered as length of thread increases because, in deep thread holes, the accumulated chips increase friction and interfere with lubrication.
- Bottoming taps must be run slower than plug taps.
- Tapping full height of thread calls for slower speed than if the commercial 75% height only is required.
- Coarse-thread taps in the larger diameters should be run more slowly than fine-thread taps of the same diameters.
- The quantity and quality of cutting fluid may affect the permissible speeds as much as 100%.
- Taper threaded taps, such as pipe taps, should be operated from 1/2–3/4 the speed of a straight thread tap of comparable major diameter.

■ RPM Formulas

SFM = Surface Feet per Minute
 RPM = Revolutions per Minute
 IPM = Inches per Minute
 TPI = Threads per Inch

S m/min = Surface Metres per Minute
 $\pi = 3.1416$
 mm/min = millimetres per minute
 P = Pitch (1/number of threads per inch)

Inch Sizes

SFM	=	$\frac{\text{RPM} \times \text{tool diameter}}{3.82}$	or	$0.26 \times \text{RPM} \times \text{tool diameter}$
RPM	=	$\frac{3.82 \times \text{SFM}}{\text{tool diameter}}$		
IPM	=	$\frac{\text{RPM}}{\text{TPI}^*}$	or	$*P \times \text{RPM}$

Metric Sizes

S m/min	=	$\frac{\pi \times \text{tool diameter} \times \text{RPM}}{1000}$
RPM	=	$\frac{\text{mm/min} \times 1000}{\pi \times \text{tool diameter}}$
mm/min	=	mm P x RPM

Partial List of Solutions to Tapping Problems

application	symptom	common cause	remedy
general	gage out of limits	tap size and gage mismatch	select tap size for gage
	oversize thread	alignment, spindle feed	correct
	oversize at top	runout or alignment	correct
	go gage binds part way	worn tool, tap cuts off lead	replace tap, synchronous holder
	thread shaving	feed error, high axial force	programme, synchronous holder
	chipping	high cutting force, worn tap	tap geometry, replace tap
	breakage	chip jamming flutes	tap geometry, tapping depth
	—	worn tool, high torque	replace tap with new tool
	short life, low speed	excessive wear	SC or HSS-E-PM HP taps
steel	birdnest blind hole	long, ductile chips	T630 KP6505 (oxide), peck feed
	chipping	high material hardness	T600, T602 KSP21 (TiN)
	breakage in blind holes	hole depth >2D, chip jamming	T604 KHS26 (TiN/MoS ₂)
stainless steel	oversize thread, low life	galling	T620, T630 KM6515 (TiN-CrC/C)
	short life	work hardened core hole	replace drill
cast iron	excessive wear	abrasion	T640 KP6525 (TiCN)
aluminium, cast	excessive wear	high silicon	T640 KP6525 (TiCN)
aluminium, wrought	oversize thread	galling	T672, T682, T686 KSMN34 (TiN-CrC/C)
nickel, cobalt alloys	short life	high cutting temperature	T690, T692, T694 KSP27 (AlCrTiN)
titanium	short life	high cutting temperature	T660, T662 KSSM24 (TiN-CrC/C)

Thread Mills

	vibration marks	major crest wear	edge chipping	cone-shaped thread	entry marks
cutting speed	check	reduce	—	—	—
feed per tooth	check	increase	reduce	—	—
workpiece clamping	improve	improve	improve	—	improve
machine tool stability	improve	improve	improve	—	improve
cantilever arm	shorten	shorten	—	—	shorten
helix angle	increase	reduce	—	—	—
radial runout	check	check	—	—	—
coating	—	improve	improve	—	—
milling operation	—	climb mill	climb mill	climb mill	—
line feed/entry ramp	check	check	—	—	improve
coolant pressure	—	check (>20 bar, 290 psi)	check (>20 bar, 290 psi)	—	—

drill size	decimal (in)	drill size	decimal (in)	drill size	decimal (in)	drill size	decimal (in)	drill size	decimal (in)	drill size	decimal (in)
0,30mm	.0118	54	.0550	3,10mm	.1220	5,50mm	.2165	8,50mm	.3346	9/16	.5625
0,32mm	.0126	1,40mm	.0551	1/18	.1250	7/32	.2188	8,60mm	.3386	14,50mm	.5709
80	.0135	1,45mm	.0571	3,20mm	.1260	5,60mm	.2205	R	.3390	37/64	.5781
0,35mm	.0138	1,50mm	.0591	30	.1285	2	.2210	8,70mm	.3425	14,75mm	.5807
79	.0145	53	.0595	3,30mm	.1299	5,70mm	.2244	11/32	.3438	15,00mm	.5906
0,38mm	.0150	1,55mm	.0610	3,40mm	.1339	1	.2280	8,80mm	.3465	19/32	.5938
1/64	.0156	1/16	.0625	29	.1360	5,80mm	.2283	S	.3480	15,25mm	.6004
0,40mm	.0157	1,60mm	.0630	3,50mm	.1378	5,90mm	.2323	8,90mm	.3504	39/64	.6094
78	.0160	52	.0635	28	.1405	A	.2340	9,00mm	.3543	15,50mm	.6102
0,42mm	.0165	1,65mm	.0650	9/64	.1406	15/64	.2344	T	.3580	15,75mm	.6201
0,45mm	.0177	1,70mm	.0669	3,60mm	.1417	6,00mm	.2362	9,10mm	.3583	5/8	.6250
77	.0180	51	.0670	27	.1440	B	.2380	23/64	.3594	16,00mm	.6299
0,48mm	.0189	1,75mm	.0689	3,70mm	.1457	6,10mm	.2402	9,20mm	.3622	16,25mm	.6398
0,50mm	.0197	50	.0700	26	.1470	C	.2420	9,30mm	.3661	41/64	.6406
76	.0200	1,80mm	.0709	25	.1495	6,20mm	.2441	U	.3680	16,50mm	.6496
75	.0210	1,85mm	.0728	3,80mm	.1496	D	.2460	9,40mm	.3701	21/32	.6562
0,55mm	.0217	49	.0730	24	.1520	6,30mm	.2480	9,50mm	.3740	16,75mm	.6594
74	.0225	1,90mm	.0748	3,90mm	.1535	1/4, E	.2500	3/8	.3750	17,00mm	.6693
0,60mm	.0236	48	.0760	23	.1540	6,40mm	.2520	V	.3770	43/64	.6719
73	.0240	1,95mm	.0768	5/32	.1562	6,50mm	.2559	9,60mm	.3780	17,25mm	.6791
0,62mm	.0244	5/64	.0781	22	.1570	F	.2570	9,70mm	.3819	11/16	.6875
72	.0250	47	.0785	4,00mm	.1575	6,60mm	.2598	9,80mm	.3858	17,50mm	.6890
0,65mm	.0256	2,00mm	.0787	21	.1590	G	.2610	W	.3860	45/64	.7031
71	.0260	2,05mm	.0807	20	.1610	6,70mm	.2638	9,90mm	.3898	18,00mm	.7087
0,70mm	.0276	46	.0810	4,10mm	.1614	17/64	.2656	25/64	.3906	23/32	.7188
70	.0280	45	.0820	4,20mm	.1654	H	.2660	10,00mm	.3937	18,50mm	.7283
69	.0292	2,10mm	.0827	19	.1660	6,80mm	.2677	X	.3970	47/64	.7344
0,75mm	.0295	2,15mm	.0846	4,30mm	.1693	6,90mm	.2717	10,20mm	.4016	19,00mm	.7480
68	.0310	44	.0860	18	.1695	I	.2720	Y	.4040	3/4	.7500
1/32	.0312	2,20mm	.0866	11/64	.1719	7,00mm	.2756	13/32	.4062	49/64	.7656
0,80mm	.0315	2,25mm	.0886	17	.1730	J	.2770	Z	.4130	19,50mm	.7677
67	.0320	43	.0890	4,40mm	.1732	7,10mm	.2795	10,50mm	.4134	25/32	.7812
66	.0330	2,30mm	.0906	16	.1770	K	.2810	27/64	.4219	20,00mm	.7874
0,85mm	.0335	2,35mm	.0925	4,50mm	.1772	9/32	.2812	10,80mm	.4252	51/64	.7969
65	.0350	42	.0935	15	.1800	7,20mm	.2835	11,00mm	.4331	20,50mm	.8071
0,90mm	.0354	3/32	.0938	4,60mm	.1811	7,30mm	.2874	7/16	.4375	13/16	.8125
64	.0360	2,40mm	.0945	14	.1820	L	.2900	11,20mm	.4409	21,00mm	.8268
63	.0370	41	.0960	4,70mm, 13	.1850	7,40mm	.2913	11,50mm	.4528	53/64	.8281
0,95mm	.0374	2,45mm	.0965	3/16	.1875	M	.2950	29/64	.4531	27/32	.8438
62	.0380	40	.0980	4,80mm, 12	.1890	7,50mm	.2953	11,80mm	.4646	21,50mm	.8465
61	.0390	2,50mm	.0984	11	.1910	19/64	.2969	15/32	.4688	55/64	.8594
1,00mm	.0394	39	.0995	4,90mm	.1929	7,60mm	.2992	12,00mm	.4724	22,00mm	.8661
60	.0400	38	.1015	10	.1935	N	.3020	12,20mm	.4803	7/8	.8750
59	.0410	2,60mm	.1024	9	.1960	7,70mm	.3031	31/64	.4844	22,50mm	.8858
1,05mm	.0413	37	.1040	5,00mm	.1969	7,80mm	.3071	12,50mm	.4921	57/64	.8906
58	.0420	2,70mm	.1063	8	.1990	7,90mm	.3110	1/2	.5000	23,00mm	.9055
57	.0430	36	.1065	5,10mm	.2008	5/16	.3125	12,80mm	.5039	29/32	.9062
1,10mm	.0433	7/64	.1094	7	.2010	8,00mm	.3150	13,00mm	.5118	59/64	.9219
1,15mm	.0453	35	.1100	13/64	.2031	O	.3160	33/64	.5156	23,50mm	.9252
56	.0465	2,80mm	.1102	6	.2040	8,10mm	.3189	13,20mm	.5197	15/16	.9375
3/64	.0469	34	.1110	5,20mm	.2047	8,20mm	.3228	17/32	.5312	24,00mm	.9449
1,20mm	.0472	33	.1130	5	.2055	P	.3230	13,50mm	.5315	61/64	.9531
1,25mm	.0492	2,90mm	.1142	5,30mm	.2087	8,30mm	.3268	13,80mm	.5433	24,50mm	.9646
1,30mm	.0512	32	.1160	4	.2090	21/64	.3281	35/64	.5469	31/32	.9688
55	.0520	3,00mm	.1181	5,40mm	.2126	8,40mm	.3307	14,00mm	.5512	25,00mm	.9843
1,35mm	.0531	31	.1200	3	.2130	Q	.3320	14,25mm	.5610	63/64	.9844
—	—	—	—	—	—	—	—	—	—	1"	1.0000

■ Metric
 ■ Fractional
 ■ Wire gage
 ■ Letter size

Tap Custom-Order Worksheet

Use this Custom-Order Worksheet to modify an existing product to meet your specifications. If your custom requirements do not fall into these categories, simply contact your Kennametal Distributor.

Trust our experienced distributors and Kennametal engineering team to design the best solution for you.

1. Start with the standard product most similar to your specifications:

catalogue number

grade/coating

2. Type of tap needed:

solid carbide high-performance HSS general purpose spiral point
 hand forming spiral flute
 _____ pipe (and style) _____ other

3. Direction of cut (circle one):

left hand

right hand

4. Material overview:

ANSI DIN JIS other

5. Desired dimension:

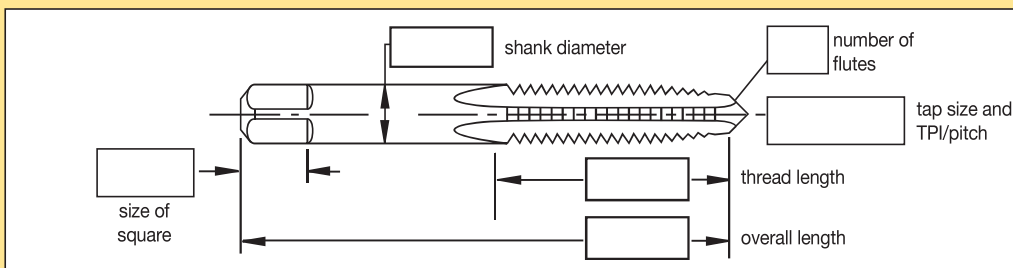

6. Choose one:

through hole:

hole diameter _____
 hole depth _____

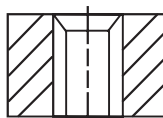

blind hole:

hole diameter _____
 hole depth _____

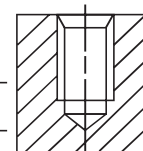

7. Chamfer:

taper: 7-10 pitch plug: 3-5 pitch semi-bottom: 2-3 pitch bottom: 1-2 pitch

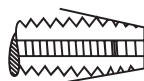

8. Class of fit:

H limit

metric D limit

diameter pitch limit

9. Workpiece material:

10. Hardness:

11. Number of taps required:

12. Price

Contact your Authorised Kennametal Distributor partners.

13. Other comments or special characteristics:

customer company name	date
address	phone number
city, state, zip	fax number
customer contact	customer email address
sales representative	

■ Application Sheet for Thread Milling

Test form thread data:		Date:	
Customer Data			
Company:		Department:	
Street:		Position:	
Postal code:		Telephone:	
City:		Fax:	
Country:		E-mail:	
Tool Data			
Engaged Kennametal tool:		Tool life:	
Competitive tool:			
Workpiece Data			
Thread size:		Name of workpiece:	
Class of fit:		Picture, sketch...	
Thread depth: mm			
Thread type: <input type="checkbox"/> Through hole <input type="checkbox"/> Blind hole			
Drill hole ø: mm			
Depth of drill hole: mm			
Type of drilled hole: <input type="checkbox"/> Drilled <input type="checkbox"/> No hole			
Material:			
Hardness:			
Machine Data			
Manufacturer:		Description:	
CNC-machine type: <input type="checkbox"/> Turning machine <input type="checkbox"/> Milling machine		Working direction: <input type="checkbox"/> Horizontal <input type="checkbox"/> Vertical	
Control type: <input type="checkbox"/> DIN <input type="checkbox"/> Heidenhain		Coolant: <input type="checkbox"/> Emulsion <input type="checkbox"/> MQL <input type="checkbox"/> Compressed air <input type="checkbox"/> Dry	
Coolant supply type: <input type="checkbox"/> Internal <input type="checkbox"/> External		Coolant pressure: Bar	
Revolutions max: <input type="checkbox"/> 1/min		Spindle power: kW	
Clamping device: <input type="checkbox"/> Weldon® <input type="checkbox"/> Collet <input type="checkbox"/> Shrinking <input type="checkbox"/> Hydraulic expansion			
Cutting Conditions			
Cutting speed vc: m/min		Revolutions: 1/min	
Feed fz: mm/tooth		Programmed feed: mm/min	
Milling direction: <input type="checkbox"/> Climb milling <input type="checkbox"/> Down milling		Type of feed: <input type="checkbox"/> Feed on contour <input type="checkbox"/> Feed on center	
Allocated cut over depth of thread: <input type="checkbox"/> Yes <input type="checkbox"/> No		Allocated cut over profile: <input type="checkbox"/> By depth of profile <input type="checkbox"/> By thread depth	
Number of cuts:		Number of cuts:	

Knowing the hardness of the work material to be tapped is essential in selecting the best tap for the job.

10 mm/min ball 3000 kg	120° cone 150 kg	1/16" ball 100 kg	model C	1000 lb per sq. in.	10 mm/min ball 3000 kg	120° cone 150 kg	1/16" ball 100 kg	model C	1000 lb per sq. in.
Brinell	Rockwell C	Rockwell B	Shore Scleroscope	tensile strength	Brinell	Rockwell C	Rockwell B	Shore Scleroscope	tensile strength
800	72	-	100	-	276	30	105	42	136
780	71	-	99	-	269	29	104	41	132
760	70	-	98	-	261	28	103	40	129
745	68	-	97	367	258	27	102	39	127
725	67	-	96	357	255	26	102	39	125
712	66	-	95	350	249	25	101	38	123
682	65	-	93	337	245	24	100	37	119
668	64	-	91	326	240	23	99	36	117
652	63	-	89	318	237	23	99	35	115
626	62	-	87	306	229	22	98	34	113
614	61	-	85	299	224	21	97	33	110
601	60	-	83	292	217	20	96	33	107
590	59	-	81	290	211	19	95	32	104
576	57	-	79	281	206	18	94	32	102
552	56	-	76	270	203	17	94	31	100
545	55	-	75	268	200	16	93	31	98
529	54	-	74	259	196	15	92	30	96
514	53	120	72	254	191	14	92	30	94
502	52	119	70	247	187	13	91	29	92
495	51	119	69	244	185	12	91	29	91
477	49	118	67	233	183	11	90	28	90
461	48	117	66	227	180	10	89	28	89
451	47	117	65	223	175	9	88	27	86
444	46	116	64	219	170	7	87	27	84
427	46	115	62	209	167	6	87	27	82
415	44	115	60	204	165	5	86	26	81
401	43	114	58	196	163	4	85	26	80
388	42	114	57	191	160	3	84	25	78
375	41	113	55	184	156	2	83	25	76
370	40	112	54	182	154	1	82	25	75
362	39	111	53	179	152	-	82	24	74
351	38	111	51	173	150	-	81	24	74
346	37	110	50	170	147	-	80	24	72
341	37	110	49	168	145	-	79	23	71
331	36	109	47	163	143	-	79	23	70
323	35	109	46	158	141	-	78	23	69
311	34	108	46	153	140	-	77	22	69
301	33	107	45	148	135	-	75	22	67
293	32	106	44	144	130	-	72	22	65
285	31	105	43	140	-	-	-	-	-

Tapping

High-Performance Multipurpose HSS-E GOtap™

GOtap is the solution for high-performance multipurpose tapping. GOtap includes optimised flute geometries and PVD coatings capable of tapping a broad assortment of ductile materials, such as stainless steels, carbon and alloy steels, cast aluminium, and ductile iron. The unmatched versatility of GOtap means lower inventory costs with no loss of productivity, consistent tool life, and high-quality thread finish.

ADVANCED TECHNOLOGY

- Manufactured with high-vanadium HSS-E material for exceptional wear characteristics and longer tool life.
- Optimised geometries for efficient chip evacuation in both through and blind holes.
- Advanced PVD coatings to reduce tapping torque resulting in high-quality thread finish and longer tool life.

Experience the advantages at your Authorised Kennametal Distributor or at kennametal.com.

