



Modular Drills

Introduction	H2–H5
KenTIP FS	H6–H23
KenTIP	H24–H37
KSEM	H38–H77
Tube Sheet Grooving Tool	H74–H77
KSEM PLUS.....	H78–H106

modular drills with internal coolant channel		grade/series	standard*						hole tolerance	standard range		
			● first choice ○ alternate choice							diameter range		
			P	M	K	N	S	H		D1 mm min-max	D1 inch min-max	drilling depth L/D1
KenTIP™ FS For smaller diameters. Easy front clamping and disposable inserts.												
	KenTIP FS inserts	KCP15A HPG	●	○				IT9-IT11	6,00-26,00	.2362-1.0236	—	
		KC7410 HPC		●								
		KCMS15 HPL		●								
	KenTIP FS bodies	SS SF SCF	—						—	6,00 ≤ Ø < 9,50	.2362 ≤ Ø < .3740	1.5-12 x D
			9,50 ≤ Ø < 11,00	.3740 ≤ Ø < .4331								
			11,00 ≤ Ø < 12,50	.4331 ≤ Ø < .4921								
			12,50 ≤ Ø < 14,00	.4921 ≤ Ø < .5512								
			14,00 ≤ Ø < 15,50	.5512 ≤ Ø < .6102								
			15,50 ≤ Ø < 16,50	.6102 ≤ Ø < .6496								
			16,50 ≤ Ø < 20,00	.6496 ≤ Ø < .7874								
			20,00 ≤ Ø < 21,00	.7874 ≤ Ø < .8268								
	21,00 ≤ Ø < 26,00	.8268 ≤ Ø < 1.0236	SCF shank only									
KenTIP™												
	KenTIP inserts	KCP15 HP	●	○			IT9-IT11	7,94-27,99	.3125-1.1020	—		
		KCPM45™ FEG	●	○				7,94-27,99	.3125-.7874			
	FAS chamfering inserts	KC7014 FAS-GD	○	○	○	●	IT9-IT11	Made-to-order toolholders required. Also available for KenTIP FS.				
		KC7215 FAS-GD	●	○	○	●						
	CFM tangential chamfering and counterboring	KCU40 CFM-HP	●	○	○	●	●					
	KenTIP bodies	SS SCF	—						—	7,94 ≤ Ø < 9,50	.3125 ≤ Ø < .3740	1.5-12 x D
			9,50 ≤ Ø < 11,00	.3740 ≤ Ø < .4331								
			11,00 ≤ Ø < 12,50	.4331 ≤ Ø < .4921								
			12,50 ≤ Ø < 14,00	.4921 ≤ Ø < .5512								
			14,00 ≤ Ø < 15,50	.5512 ≤ Ø < .6102								
			15,50 ≤ Ø < 16,50	.6102 ≤ Ø < .6496								
			16,50 ≤ Ø < 20,50	.6496 ≤ Ø < .8071								
			20,50 ≤ Ø < 21,00	.8071 ≤ Ø < .8268								
	21,00 ≤ Ø < 27,99	.8268 ≤ Ø < 1.1020										

■ Standard Product
□ Engineered Solutions

engineered solution range			coolant	drilling	inclined exit	stacked plates	flat bottom	countersinking	counterboring	cross hole	2 flute 2 margin cooled	2 flute 4 margin cooled	corner chamfer	plain shank $\leq H6$	Whistle Notch 2°	WD shank	flat shank	SSF shank	KM™ shank	HSK shank	page(s)
D1 mm min-max	D1 inch min-max	max drilling depth																			
KenTIP™ FS For smaller diameters. Easy front clamping and disposable inserts. <i>(continued)</i>																					
6,00–26,00	.2362–1.0236	—	■	■	■	■	□	□	■	■	□	□	□	□	□	□	□	□	□	□	H8
6,00 $\leq\phi$ <9,50	.2362 $\leq\phi$ <.3740	12 x D	■	■	■	■	□	□	■	■	□	□	□	■	□	□	■	□	□	□	H16
9,50 $\leq\phi$ <11,00	.3740 $\leq\phi$ <.4331	13 x D	■	■	■	■	□	□	■	■	□	□	□	■	□	□	■	□	□	□	
11,00 $\leq\phi$ <12,50	.4331 $\leq\phi$ <.4921	14 x D	■	■	■	■	□	□	■	■	□	□	□	■	□	□	■	□	□	□	
12,50 $\leq\phi$ <14,00	.4921 $\leq\phi$ <.5512	15 x D	■	■	■	■	□	□	■	■	□	□	□	■	□	□	■	□	□	□	
14,00 $\leq\phi$ <15,50	.5512 $\leq\phi$ <.6102	16 x D	■	■	■	■	□	□	■	■	□	□	□	■	□	□	■	□	□	□	
15,50 $\leq\phi$ <16,50	.6102 $\leq\phi$ <.6496	17 x D	■	■	■	■	□	□	■	■	□	□	□	■	□	□	■	□	□	□	
16,50 $\leq\phi$ <20,00	.6496 $\leq\phi$ <.7874	18 x D	■	■	■	■	□	□	■	■	□	□	□	■	□	□	■	□	□	□	
20,00 $\leq\phi$ <21,00	.7874 $\leq\phi$ <.8268	20 x D	■	■	■	■	□	□	■	■	□	□	□	■	□	□	■	□	□	□	
21,00 $\leq\phi$ <26,00	.8268 $\leq\phi$ <1.0236	550mm	■	■	■	■	□	□	■	■	□	□	□	■	□	□	■	□	□	□	
KenTIP™ (continued)																					
7,94–27,99	.3125–1.1020	—	■	■	□	■	□	□	■	■	□	□	□	■	□	□	■	□	□	□	H26
12,50–36,01	.4921–1.4177	—	■	■	■	■	□	□	■	■	□	□	□	■	□	□	■	□	□	□	H33
10,00–31,20	.3937–1.2283	—	■	■	■	■	□	□	■	■	□	□	□	■	□	□	■	□	□	□	H34
7,94 $\leq\phi$ <9,50	.3125 $\leq\phi$ <.3740	12 x D	■	■	■	■	□	□	■	■	□	□	□	■	□	□	■	□	□	□	H31
9,50 $\leq\phi$ <11,00	.3740 $\leq\phi$ <.4331	13 x D	■	■	■	■	□	□	■	■	□	□	□	■	□	□	■	□	□	□	
11,00 $\leq\phi$ <12,50	.5424 $\leq\phi$ <.4921	14 x D	■	■	■	■	□	□	■	■	□	□	□	■	□	□	■	□	□	□	
12,50 $\leq\phi$ <14,00	.4921 $\leq\phi$ <.5512	15 x D	■	■	■	■	□	□	■	■	□	□	□	■	□	□	■	□	□	□	
14,00 $\leq\phi$ <15,00	.5512 $\leq\phi$ <.6102	16 x D	■	■	■	■	□	□	■	■	□	□	□	■	□	□	■	□	□	□	
15,50 $\leq\phi$ <16,50	.6102 $\leq\phi$ <.6496	17 x D	■	■	■	■	□	□	■	■	□	□	□	■	□	□	■	□	□	□	
16,50 $\leq\phi$ <20,50	.6496 $\leq\phi$ <.8070	18 x D	■	■	■	■	□	□	■	■	□	□	□	■	□	□	■	□	□	□	
20,50 $\leq\phi$ <21,00	.8070 $\leq\phi$ <.8267	20 x D	■	■	■	■	□	□	■	■	□	□	□	■	□	□	■	□	□	□	
21,00 $\leq\phi$ <28,00	.8267 $\leq\phi$ <1.1024	550mm	■	■	■	■	□	□	■	■	□	□	□	■	□	□	■	□	□	□	

modular drills with internal coolant channel		grade/series	standard*						hole tolerance	standard range		
			● first choice ○ alternate choice							diameter range		
			P	M	K	N	S	H		D1 mm min-max	D1 inch min-max	drilling depth L/D1
KSEM™ For larger diameters. Very robust pocket and regrindable inserts.												
	KSEM inserts	KC7315 HP/HPG	●	○	○	○	○	○	IT9-IT11	12,50-40,00	.4921-1.5748	—
		KCPM45 HPG	●	○	○	○	○	○		12,50-40,00	.4921-1.5748	
		KC7410 HPCCL	○	○	●	○	○	○		12,70-40,00	.5000-1.5748	
		KC7320 HPL	○	○	●	○	○	○		12,50-40,00	.4921-1.5748	
		KCMS35 SPL	○	●	○	○	○	○		12,50-40,00	.4921-1.5748	
		KCPM45 FEG	●	○	○	○	○	○		16,00-40,00	.6230-1.5748	
		KC7135 PC	●	○	○	○	○	○		12,50-40,00	.4921-1.5748	
	chamfering inserts	KC7015 TPGX-GD	○	○	○	○	○	IT9-IT11	12,50-40,00	.4921-1.5748	—	
		KC7140 TPGX-GD	○	○	○	○	○					
		KC7315™ TPGX-GD	○	○	○	○	○					
	KSEM bodies	WN (Metric), SS (inch), SSF (inch)	—						—	12,50≤Ø<16,50	.4921≤Ø<.6496	1-10 x D (SSF only up to 8 x D) (WN only up to Ø32mm)
		WD (Metric)	—							16,50≤Ø<20,00	.6496≤Ø<.7874	
		20,00≤Ø≤32,00	—							.7874≤Ø≤1.2598		
		WN, SSF with chamfer	—							12,50≤Ø<16,50	.4921≤Ø<.6496	1 x D
		16,50≤Ø<20,00	—							.6496≤Ø<.7874		
		20,00≤Ø≤32,00	—							.7874≤Ø≤1.2598		
WD, SSF with chamfer	—						32,00<Ø≤40,00	1.2598<Ø<1.5748	1 x D			
KSEM PLUS™ High-performance drilling for the largest diameters.												
	KSEM PLUS heads	A1 style	○	○	○	○	○	IT9-IT11	28,00<Ø≤101,40	1.1020<Ø≤4.0000	—	
		B1 style	○	○	○	○	○					
	KSEM PLUS centre inserts	KSEMP KC7315 HPG	●	○	○	○	○	IT9-IT11	13,00-40,00 mm PDD reference only	—	—	
		KSEM KC7410 HPCCL	○	○	●	○	○					
		KSEM KC7135 PC	○	○	○	○	○					
	DFR™ inserts	KCU25 DFR-GD	●	○	○	○	○	IT9-IT11	28,00-31,00	1.1024-1.2204	—	
		KCU40 DFR-GD	●	○	○	○	○					
		KC7140 DFR-MD	●	○	○	○	○					
		KC7225 DFR-LD	○	○	○	○	○					
	DFT™ inserts	KCU25 DFT-HP	●	○	○	○	○	IT9-IT11	31,75-101,40	1.2500-4.0000	—	
		KCU40 DFT-HP	●	○	○	○	○					
		KCU40 DFC-DS	●	○	○	○	○					
		KC7140 DFT-MD	●	○	○	○	○					
	DFC™ inserts (B1 Heads)	KCU25 DFC-HP	●	○	○	○	○	IT9-IT11	28,00-101,40	1.1024-4.0000	—	
		KCU40 DFC-HP	●	○	○	○	○					
		KCU40 DFC-DS	●	○	○	○	○					
		KC7140 DFC-MD	●	○	○	○	○					
	DPA guide pads (B1 Heads)	KCU40 DPA	—						IT9-IT11	Available for all standard B1 Head Diameters		
		—	—							—	—	—
	KSEM PLUS bodies	WD (Metric)	—						IT9-IT11	28,00≤Ø≤70,00	1.1024≤Ø≤2.7560	1.5-10 x D
		SSF (Inch)	—							70,00≤Ø≤101,40	2.7560≤Ø≤4.0000	1.5-5 x D

* Apart from our standard drills, we can offer you a wide variety of special coating solutions and edge preparations to fulfill all your needs. If a specific drill is not suitable for your workpiece material, please contact our **Engineered Solutions Department**.

■ Standard Product
□ Engineered Solutions

engineered solution range			coolant	drilling	inclined exit	stacked plates	flat bottom	countersinking	counterboring	cross hole	2 flute 2 margin cooled	2 flute 4 margin cooled	corner chamfer	plain shank $\leq H6$	Whistle Notch 2°	WD shank	flat shank	SSF shank	KM™ shank	HSK shank	page(s)
diameter range																					
D1 mm min-max	D1 inch min-max	max drilling depth																			
KSEM™ For larger diameters. Very robust pocket and regrindable inserts. <i>(continued)</i>																					
12,50-40,00	.4921-1.5748	—			■	■	■				■	■	□	□							H40
12,50-40,00	.4921-1.5748	—							■												H63
12,50≤Ø<16,50	.4921≤Ø<.6496	15 x D	■						□	□	□			■	■	□	□	■	□	□	H58
16,50≤Ø<20,00	.6496≤Ø<.7874	18 x D	■						□	□	□			■	■	□	□	■	□	□	
20,00≤Ø≤40,00	.7874≤Ø≤1.5748	20 x D	■						□	□	□			■	■	□	□	■	□	□	
32,00<Ø≤40,00	1.2598<Ø≤1.5748	20 x D (max 800mm)	■						□	□	□			□	□	■	□	□	□	□	H58
12,50≤Ø<16,50	.4921≤Ø<.6496	chamfer step drills available as custom solutions in various lengths	■						■	□	□			□	■	□	□	□	□	□	
16,50≤Ø<20,00	.6496≤Ø<.7874		■							■	□	□			□	■	□	□	□	□	
20,00≤Ø≤32,00	.7874≤Ø≤1.2598		■							■	□	□			□	■	□	□	■	□	
32,00<Ø≤40,00	1.2598<Ø≤1.5748		■							■	□	□			□		■	□	■	□	
KSEM PLUS™ High-performance drilling for the largest diameters. <i>(continued)</i>																					
28,00<Ø≤127,00	1.1020<Ø≤5.0000	—	■	■				□	□	□	■	□	(DPA)								H91
13,00-40,00 mm PDD reference only			■	■	■	■	□	□	□	■	■										H87
DFR inserts for A1 Heads with FDS28																					
28,00≤Ø<31,75	1.1024≤Ø<1.2500	—																			H89
DFT inserts for A1 Heads FDS32 and above																					
31,75≤Ø≤127,00	1.2500≤Ø≤5.0000	—																			H88
DFC inserts for B1 Heads, all FDS sizes																					
28,00≤Ø≤127,00	1.1024≤Ø≤5.0000	—																			H90
DPA are supporting various solutions																					
28,00≤Ø≤127,00	1.1020≤Ø≤5.0000	3-20 x D (max 1250mm)	■			■	■	□			■			□		■	□	■	□	□	H102

** Alternative chamfering solutions are available in combination with SEFAS™ or BF; see page I1.
Please use this table for orientation purposes only. Detailed information on available products (inserts, toolholders, etc.) can be found on the indicated pages of this catalogue.

> KenTIP™ FS

The Perfect Fusion of a Solid Carbide and an Indexable Drill

The new modular drill KenTIP FS covers more applications and provides better performance than any other modular system, delivering substantial cost savings and process simplifications on your shop floor.

3-point geometries, 3 high-performance grades, 3 different shank styles.

This modular drilling system covers a 6–26mm diameter range.

Up to 12 x D drilling depths.

Applicable in steel, stainless steel, and cast iron.

Intelligent Interface

 Taper interface uniquely designed for highest rigidity clamping.

 Retention lock prevents insert pullout.

 Large bearing surface positioned for transmission of highest torsional loads without pocket deformation.

 Large face contact surface.

Maximum performance and long tool life, even in unstable conditions.

Quick Release

Every drill body comes with a KenTIP smart wrench. Insert exchange in the machine becomes easy and saves idle time. And that saves money.

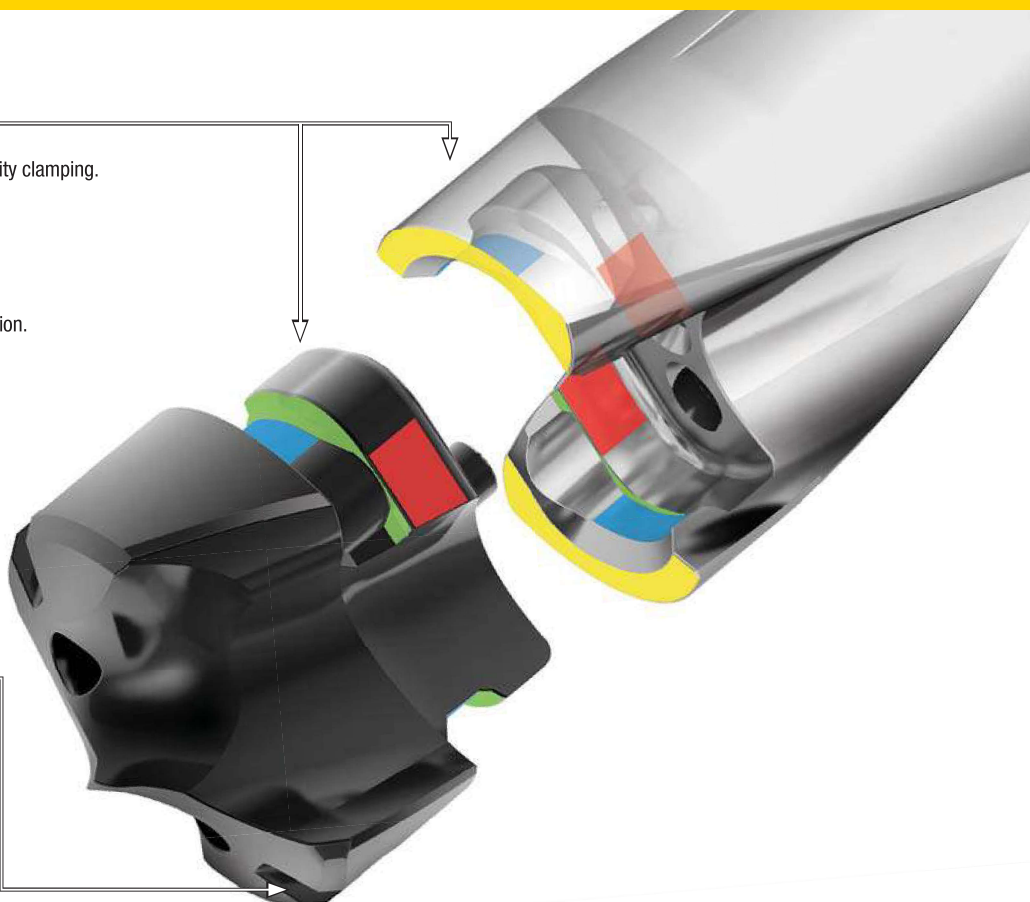

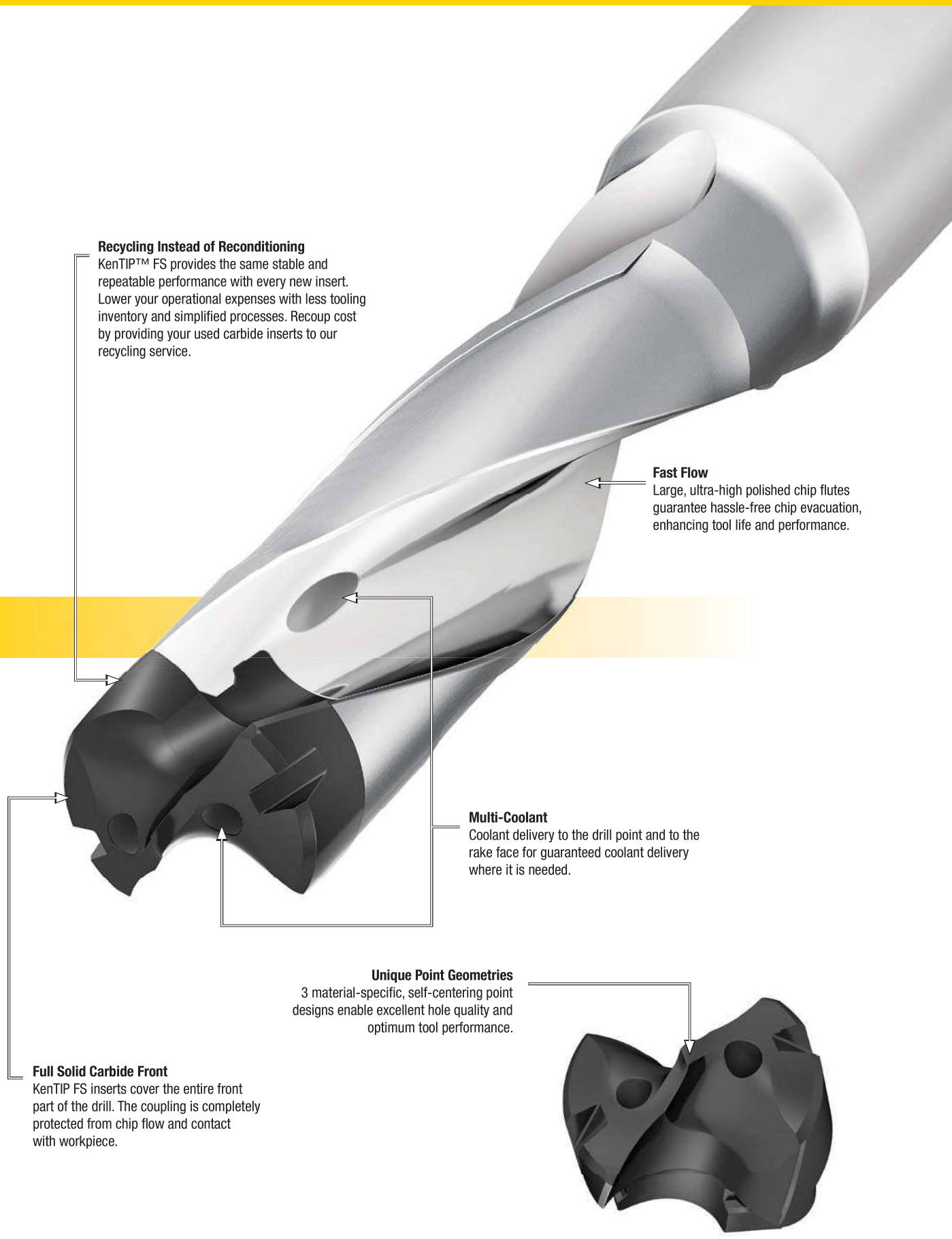

Recycling Instead of Reconditioning
KenTIP™ FS provides the same stable and repeatable performance with every new insert. Lower your operational expenses with less tooling inventory and simplified processes. Recoup cost by providing your used carbide inserts to our recycling service.

Fast Flow
Large, ultra-high polished chip flutes guarantee hassle-free chip evacuation, enhancing tool life and performance.

Multi-Coolant
Coolant delivery to the drill point and to the rake face for guaranteed coolant delivery where it is needed.

Unique Point Geometries
3 material-specific, self-centering point designs enable excellent hole quality and optimum tool performance.

Full Solid Carbide Front
KenTIP FS inserts cover the entire front part of the drill. The coupling is completely protected from chip flow and contact with workpiece.



- HPG-point geometry for steels.
- Great positioning and centring capabilities for drilling without precentring, even in deeper holes.
- KCP15A™ is an AlTiN PVD monolayer coating.
- Enhanced thermal stability.
- Excellent balance between toughness and wear resistance.
- Without internal coolant.

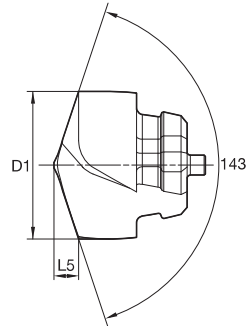
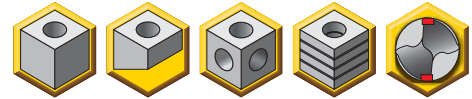

Modular Drills

■ KenTIP FS Inserts • HPG KCP15A • No Internal Coolant Channels



KCP15A	D1		L5		seat size
	mm	in	mm	in	
KTFSS06000HPGM	6,000	.2362	1,370	.0539	A
KTFSS06100HPGM	6,100	.2402	1,380	.0543	A
KTFSS06200HPGM	6,200	.2441	1,400	.0551	A
KTFSS06300HPGM	6,300	.2480	1,440	.0567	B
KTFSS06350HPGM	6,350	.2500	1,450	.0571	B
KTFSS06400HPGM *	6,400	.2520	1,450	.0571	B
KTFSS06500HPGM	6,500	.2559	1,470	.0579	B
KTFSS06530HPGM	6,530	.2571	1,480	.0583	B
KTFSS06600HPGM	6,600	.2598	1,490	.0587	C
KTFSS06629HPGM *	6,629	.2610	1,500	.0591	C
KTFSS06700HPGM	6,700	.2638	1,510	.0594	C
KTFSS06746HPGM	6,746	.2656	1,520	.0598	C
KTFSS06800HPGM	6,800	.2677	1,530	.0602	C
KTFSS06900HPGM *	6,900	.2717	1,540	.0606	C
KTFSS06909HPGM	6,909	.2720	1,540	.0606	C
KTFSS07000HPGM	7,000	.2756	1,590	.0626	D
KTFSS07100HPGM *	7,100	.2795	1,610	.0634	D
KTFSS07145HPGM	7,145	.2813	1,610	.0634	D
KTFSS07200HPGM *	7,200	.2835	1,620	.0638	D
KTFSS07366HPGM	7,366	.2900	1,650	.0650	D
KTFSS07400HPGM	7,400	.2913	1,660	.0654	D
KTFSS07500HPGM	7,500	.2953	1,680	.0661	E
KTFSS07541HPGM	7,541	.2969	1,690	.0665	E
KTFSS07600HPGM *	7,600	.2992	1,700	.0669	E
KTFSS07700HPGM *	7,700	.3031	1,710	.0673	E
KTFSS07800HPGM *	7,800	.3071	1,730	.0681	E
KTFSS07900HPGM *	7,900	.3110	1,750	.0689	E
KTFSS07938HPGM	7,938	.3125	1,750	.0689	E
KTFSS08000HPGM	8,000	.3150	1,800	.0709	F
KTFSS08100HPGM	8,100	.3189	1,820	.0717	F
KTFSS08164HPGM	8,164	.3214	1,830	.0720	F
KTFSS08204HPGM	8,204	.3230	1,840	.0724	F
KTFSS08300HPGM	8,300	.3268	1,850	.0728	F
KTFSS08334HPGM	8,334	.3281	1,860	.0732	F
KTFSS08400HPGM	8,400	.3307	1,870	.0736	F
KTFSS08433HPGM	8,433	.3320	1,870	.0736	F
KTFSS08500HPGM	8,500	.3346	1,890	.0744	G
KTFSS08600HPGM	8,600	.3386	1,910	.0752	G
KTFSS08611HPGM *	8,611	.3390	1,910	.0752	G
KTFSS08700HPGM	8,700	.3425	1,920	.0756	G



● first choice
○ alternate choice

KCP15A	D1		L5		seat size
	mm	in	mm	in	
KTFSS08733HPGM	8,732	.3438	1,930	.0760	G
KTFSS08800HPGM	8,800	.3465	1,940	.0764	G
KTFSS08839HPGM *	8,839	.3480	1,950	.0768	G
KTFSS08900HPGM *	8,900	.3504	1,960	.0772	G
KTFSS09000HPGM	9,000	.3543	2,010	.0791	H
KTFSS09093HPGM *	9,093	.3580	2,030	.0799	H
KTFSS09100HPGM	9,100	.3583	2,030	.0799	H
KTFSS09129HPGM *	9,129	.3594	2,030	.0799	H
KTFSS09200HPGM	9,200	.3622	2,040	.0803	H
KTFSS09300HPGM	9,300	.3661	2,060	.0811	H
KTFSS09347HPGM	9,347	.3680	2,070	.0815	H
KTFSS09400HPGM	9,400	.3701	2,080	.0819	H
KTFSS09500HPGM	9,500	.3740	2,100	.0827	I
KTFSS09525HPGM	9,525	.3750	2,110	.0831	I
KTFSS09558HPGM	9,558	.3763	2,110	.0831	I
KTFSS09600HPGM	9,600	.3780	2,120	.0835	I
KTFSS09700HPGM	9,700	.3819	2,130	.0839	I
KTFSS09800HPGM	9,800	.3858	2,150	.0846	I
KTFSS09900HPGM	9,900	.3898	2,170	.0854	I
KTFSS09921HPGM	9,921	.3906	2,170	.0854	I
KTFSS10000HPGM	10,000	.3937	2,220	.0874	J
KTFSS10023HPGM *	10,023	.3946	2,220	.0874	J
KTFSS10084HPGM *	10,084	.3970	2,230	.0878	J
KTFSS10100HPGM	10,100	.3976	2,240	.0882	J
KTFSS10200HPGM	10,200	.4016	2,250	.0886	J
KTFSS10262HPGM *	10,262	.4040	2,260	.0890	J
KTFSS10300HPGM	10,300	.4055	2,270	.0894	J
KTFSS10320HPGM	10,320	.4063	2,270	.0894	J
KTFSS10400HPGM	10,400	.4094	2,290	.0902	J
KTFSS10490HPGM	10,490	.4130	2,300	.0906	J
KTFSS10500HPGM	10,500	.4134	2,310	.0909	K
KTFSS10600HPGM	10,600	.4173	2,330	.0917	K
KTFSS10700HPGM	10,700	.4213	2,340	.0921	K
KTFSS10716HPGM	10,716	.4219	2,350	.0925	K
KTFSS10800HPGM	10,800	.4252	2,360	.0929	K
KTFSS10900HPGM	10,900	.4291	2,380	.0937	K
KTFSS11000HPGM	11,000	.4331	2,430	.0957	L
KTFSS11100HPGM	11,100	.4370	2,450	.0965	L
KTFSS11113HPGM	11,112	.4375	2,450	.0965	L
KTFSS11200HPGM	11,200	.4409	2,460	.0969	L

(continued)

(KenTIP FS Inserts • HPG KCP15A™ • No Internal Coolant Channels — continued)



● first choice
○ alternate choice

KCP15A	D1		L5		seat size	KCP15A	D1		L5		seat size
	mm	in	mm	in			mm	in	mm	in	
KTFSS11300HPGM	11,300	.4449	2,480	.0976	L	KTFSS15500HPGM	15,500	.6102	3,340	.1315	T
KTFSS11400HPGM	11,400	.4488	2,500	.0984	L	KTFSS15600HPGM	15,600	.6142	3,360	.1323	T
KTFSS11500HPGM	11,500	.4528	2,520	.0992	M	KTFSS15700HPGM	15,700	.6181	3,380	.1331	T
KTFSS11509HPGM	11,509	.4531	2,520	.0992	M	KTFSS15800HPGM	15,800	.6220	3,390	.1335	T
KTFSS11600HPGM	11,600	.4567	2,540	.1000	M	KTFSS15875HPGM	15,875	.6250	3,410	.1343	T
KTFSS11700HPGM	11,700	.4606	2,550	.1004	M	KTFSS15900HPGM *	15,900	.6260	3,410	.1343	T
KTFSS11800HPGM	11,800	.4646	2,570	.1012	M	KTFSS16000HPGM	16,000	.6299	3,480	.1370	U
KTFSS11900HPGM	11,900	.4685	2,590	.1020	M	KTFSS16027HPGM *	16,027	.6310	3,490	.1374	U
KTFSS11908HPGM	11,908	.4688	2,590	.1020	M	KTFSS16080HPGM *	16,080	.6331	3,490	.1374	U
KTFSS12000HPGM	12,000	.4724	2,640	.1039	N	KTFSS16100HPGM	16,100	.6339	3,500	.1378	U
KTFSS12100HPGM	12,100	.4764	2,650	.1043	N	KTFSS16104HPGM	16,104	.6340	3,500	.1378	U
KTFSS12200HPGM	12,200	.4803	2,670	.1051	N	KTFSS16200HPGM	16,200	.6378	3,510	.1382	U
KTFSS12304HPGM	12,304	.4844	2,690	.1059	N	KTFSS16271HPGM	16,271	.6406	3,530	.1390	U
KTFSS12400HPGM	12,400	.4882	2,700	.1063	N	KTFSS16300HPGM	16,300	.6417	3,530	.1390	U
KTFSS12474HPGM	12,474	.4911	2,720	.1071	N	KTFSS16400HPGM	16,400	.6457	3,550	.1398	U
KTFSS12500HPGM	12,500	.4921	2,730	.1075	O	KTFSS16500HPGM	16,500	.6496	3,570	.1406	U
KTFSS12600HPGM	12,600	.4961	2,740	.1079	O	KTFSS16600HPGM	16,600	.6535	3,580	.1409	U
KTFSS12700HPGM	12,700	.5000	2,760	.1087	O	KTFSS16670HPGM	16,670	.6563	3,590	.1413	U
KTFSS12800HPGM	12,800	.5039	2,780	.1094	O	KTFSS16700HPGM	16,700	.6575	3,600	.1417	U
KTFSS12900HPGM	12,900	.5079	2,790	.1098	O	KTFSS16800HPGM	16,800	.6614	3,620	.1425	U
KTFSS13000HPGM	13,000	.5118	2,850	.1122	P	KTFSS16900HPGM	16,900	.6654	3,630	.1429	U
KTFSS13096HPGM	13,096	.5156	2,860	.1126	P	KTFSS17000HPGM	17,000	.6693	3,660	.1441	V
KTFSS13200HPGM	13,200	.5197	2,880	.1134	P	KTFSS17066HPGM	17,066	.6719	3,670	.1445	V
KTFSS13280HPGM	13,280	.5228	2,890	.1138	P	KTFSS17100HPGM	17,100	.6732	3,670	.1445	V
KTFSS13300HPGM	13,300	.5236	2,900	.1142	P	KTFSS17200HPGM	17,200	.6772	3,690	.1453	V
KTFSS13380HPGM	13,380	.5268	2,910	.1146	P	KTFSS17300HPGM *	17,300	.6811	3,710	.1461	V
KTFSS13400HPGM	13,400	.5276	2,910	.1146	P	KTFSS17400HPGM	17,400	.6850	3,720	.1465	V
KTFSS13492HPGM	13,492	.5312	2,930	.1154	P	KTFSS17463HPGM	17,462	.6875	3,740	.1472	V
KTFSS13500HPGM	13,500	.5315	2,930	.1154	Q	KTFSS17480HPGM	17,480	.6882	3,740	.1472	V
KTFSS13600HPGM	13,600	.5354	2,950	.1161	Q	KTFSS17500HPGM	17,500	.6890	3,740	.1472	V
KTFSS13700HPGM	13,700	.5394	2,970	.1169	Q	KTFSS17600HPGM	17,600	.6929	3,760	.1480	V
KTFSS13800HPGM	13,800	.5433	2,980	.1173	Q	KTFSS17700HPGM	17,700	.6969	3,770	.1484	V
KTFSS13891HPGM	13,891	.5469	3,000	.1181	Q	KTFSS17800HPGM	17,800	.7008	3,790	.1492	V
KTFSS13896HPGM *	13,896	.5471	3,000	.1181	Q	KTFSS17859HPGM	17,859	.7031	3,800	.1496	V
KTFSS13940HPGM	13,940	.5488	3,010	.1185	Q	KTFSS17900HPGM	17,900	.7047	3,810	.1500	V
KTFSS14000HPGM	14,000	.5512	3,050	.1201	R	KTFSS18000HPGM	18,000	.7087	3,890	.1531	W
KTFSS14100HPGM	14,100	.5551	3,070	.1209	R	KTFSS18100HPGM	18,100	.7126	3,910	.1539	W
KTFSS14200HPGM	14,200	.5591	3,090	.1217	R	KTFSS18200HPGM	18,200	.7165	3,930	.1547	W
KTFSS14288HPGM	14,288	.5625	3,100	.1220	R	KTFSS18258HPGM	18,258	.7188	3,940	.1551	W
KTFSS14300HPGM	14,300	.5630	3,100	.1220	R	KTFSS18300HPGM	18,300	.7205	3,940	.1551	W
KTFSS14400HPGM	14,400	.5669	3,120	.1228	R	KTFSS18400HPGM	18,400	.7244	3,960	.1559	W
KTFSS14500HPGM	14,500	.5709	3,140	.1236	S	KTFSS18500HPGM	18,500	.7283	3,980	.1567	W
KTFSS14600HPGM	14,600	.5748	3,160	.1244	S	KTFSS18600HPGM	18,600	.7323	3,990	.1571	W
KTFSS14666HPGM *	14,666	.5774	3,170	.1248	S	KTFSS18654HPGM	18,654	.7344	4,000	.1575	W
KTFSS14684HPGM	14,684	.5781	3,170	.1248	S	KTFSS18700HPGM	18,700	.7362	4,010	.1579	W
KTFSS14700HPGM	14,700	.5787	3,170	.1248	S	KTFSS18800HPGM	18,800	.7402	4,030	.1587	W
KTFSS14800HPGM	14,800	.5827	3,190	.1256	S	KTFSS18900HPGM	18,900	.7441	4,040	.1591	W
KTFSS14900HPGM *	14,900	.5866	3,210	.1264	S	KTFSS19000HPGM	19,000	.7480	4,070	.1602	X
KTFSS15000HPGM	15,000	.5906	3,260	.1283	T	KTFSS19050HPGM	19,050	.7500	4,080	.1606	X
KTFSS15083HPGM	15,082	.5938	3,270	.1287	T	KTFSS19100HPGM	19,100	.7520	4,090	.1610	X
KTFSS15100HPGM	15,100	.5945	3,280	.1291	T	KTFSS19200HPGM	19,200	.7559	4,100	.1614	X
KTFSS15200HPGM	15,200	.5984	3,290	.1295	T	KTFSS19228HPGM	19,228	.7570	4,110	.1618	X
KTFSS15300HPGM	15,300	.6024	3,310	.1303	T	KTFSS19253HPGM *	19,253	.7580	4,110	.1618	X
KTFSS15380HPGM	15,380	.6055	3,320	.1307	T	KTFSS19279HPGM	19,279	.7590	4,120	.1622	X
KTFSS15400HPGM	15,400	.6063	3,330	.1311	T	KTFSS19300HPGM	19,300	.7598	4,120	.1622	X
KTFSS15479HPGM	15,479	.6094	3,340	.1315	T	KTFSS19355HPGM *	19,355	.7620	4,130	.1626	X

(continued)

(KenTIP FS Inserts • HPG KCP15A™ • No Internal Coolant Channels — continued)



● first choice
○ alternate choice

Modular Drills

KCP15A	D1		L5		seat size
	mm	in	mm	in	
KTFSS19400HPGM	19,400	.7638	4,140	.1630	X
KTFSS19446HPGM	19,446	.7656	4,140	.1630	X
KTFSS19460HPGM	19,460	.7661	4,150	.1634	X
KTFSS19500HPGM	19,500	.7677	4,150	.1634	X
KTFSS19600HPGM	19,600	.7717	4,170	.1642	X
KTFSS19700HPGM	19,700	.7756	4,190	.1650	X
KTFSS19800HPGM	19,800	.7795	4,200	.1654	X
KTFSS19845HPGM	19,845	.7813	4,210	.1657	X
KTFSS19900HPGM	19,900	.7835	4,220	.1661	X
KTFSS20000HPGM	20,000	.7874	4,310	.1697	Y
KTFSS20100HPGM	20,100	.7913	4,320	.1701	Y
KTFSS20200HPGM	20,200	.7953	4,340	.1709	Y
KTFSS20241HPGM *	20,241	.7969	4,350	.1713	Y
KTFSS20300HPGM	20,300	.7992	4,360	.1717	Y
KTFSS20500HPGM	20,500	.8071	4,390	.1728	Y
KTFSS20600HPGM	20,600	.8110	4,410	.1736	Y
KTFSS20638HPGM	20,638	.8125	4,410	.1736	Y
KTFSS20700HPGM *	20,700	.8150	4,420	.1740	Y
KTFSS20800HPGM	20,800	.8189	4,440	.1748	Y
KTFSS20900HPGM *	20,900	.8228	4,460	.1756	Y
KTFSS20990HPGM *	20,990	.8264	4,470	.1760	Y
KTFSS21000HPGM	21,000	.8268	4,480	.1764	Z
KTFSS21100HPGM *	21,100	.8307	4,500	.1772	Z
KTFSS21200HPGM	21,200	.8346	4,510	.1776	Z
KTFSS21300HPGM *	21,300	.8386	4,530	.1783	Z
KTFSS21400HPGM *	21,400	.8425	4,550	.1791	Z
KTFSS21433HPGM	21,432	.8438	4,550	.1791	Z
KTFSS21500HPGM	21,500	.8465	4,560	.1795	Z
KTFSS21700HPGM	21,700	.8543	4,600	.1811	Z
KTFSS21800HPGM *	21,800	.8583	4,610	.1815	Z
KTFSS21829HPGM	21,829	.8594	4,620	.1819	Z
KTFSS21900HPGM *	21,900	.8622	4,630	.1823	Z
KTFSS22000HPGM	22,000	.8661	4,720	.1858	ZA
KTFSS22100HPGM *	22,100	.8701	4,730	.1862	ZA
KTFSS22200HPGM *	22,200	.8740	4,750	.1870	ZA
KTFSS22225HPGM	22,225	.8750	4,750	.1870	ZA
KTFSS22400HPGM *	22,400	.8819	4,780	.1882	ZA
KTFSS22500HPGM	22,500	.8858	4,800	.1890	ZA
KTFSS22600HPGM *	22,600	.8898	4,820	.1898	ZA
KTFSS22700HPGM *	22,700	.8937	4,830	.1902	ZA

KTFSS KCP15A	D1		L5		seat size
	mm	in	mm	in	
KTFSS22800HPGM	22,800	.8976	4,850	.1909	ZA
KTFSS22900HPGM *	22,900	.9016	4,870	.1917	ZA
KTFSS23000HPGM	23,000	.9055	4,890	.1925	ZB
KTFSS23100HPGM	23,100	.9094	4,910	.1933	ZB
KTFSS23200HPGM *	23,200	.9134	4,920	.1937	ZB
KTFSS23300HPGM	23,300	.9173	4,940	.1945	ZB
KTFSS23400HPGM *	23,400	.9213	4,960	.1953	ZB
KTFSS23416HPGM	23,416	.9219	4,960	.1953	ZB
KTFSS23500HPGM	23,500	.9252	4,980	.1961	ZB
KTFSS23600HPGM *	23,600	.9291	4,990	.1965	ZB
KTFSS23700HPGM *	23,700	.9331	5,010	.1972	ZB
KTFSS23800HPGM *	23,800	.9370	5,030	.1980	ZB
KTFSS23813HPGM	23,812	.9375	5,030	.1980	ZB
KTFSS23900HPGM *	23,900	.9409	5,040	.1984	ZB
KTFSS24000HPGM	24,000	.9449	5,130	.2020	ZC
KTFSS24100HPGM *	24,100	.9488	5,140	.2024	ZC
KTFSS24200HPGM *	24,200	.9528	5,160	.2031	ZC
KTFSS24300HPGM	24,300	.9567	5,180	.2039	ZC
KTFSS24400HPGM *	24,400	.9606	5,190	.2043	ZC
KTFSS24500HPGM	24,500	.9646	5,210	.2051	ZC
KTFSS24600HPGM *	24,600	.9685	5,230	.2059	ZC
KTFSS24608HPGM	24,608	.9688	5,230	.2059	ZC
KTFSS24700HPGM *	24,700	.9724	5,240	.2063	ZC
KTFSS24800HPGM *	24,800	.9764	5,260	.2071	ZC
KTFSS24900HPGM *	24,900	.9803	5,280	.2079	ZC
KTFSS25000HPGM	25,000	.9843	5,300	.2087	ZD
KTFSS25100HPGM *	25,100	.9882	5,320	.2094	ZD
KTFSS25200HPGM *	25,200	.9921	5,330	.2098	ZD
KTFSS25250HPGM *	25,250	.9941	5,340	.2102	ZD
KTFSS25300HPGM *	25,300	.9961	5,350	.2106	ZD
KTFSS25400HPGM	25,400	1.0000	5,370	.2114	ZD
KTFSS25500HPGM *	25,500	1.0039	5,380	.2118	ZD
KTFSS25540HPGM	25,540	1.0055	5,390	.2122	ZD
KTFSS25600HPGM	25,600	1.0079	5,400	.2126	ZD
KTFSS25679HPGM	25,679	1.0110	5,410	.2130	ZD
KTFSS25700HPGM *	25,700	1.0118	5,420	.2134	ZD
KTFSS25800HPGM *	25,800	1.0157	5,440	.2142	ZD
KTFSS25806HPGM	25,806	1.0160	5,440	.2142	ZD
KTFSS25900HPGM *	25,900	1.0197	5,450	.2146	ZD
KTFSS26000HPGM	26,000	1.0236	5,470	.2154	ZD

NOTE: *Made-to-order standard item. Standard pricing, manufacturing lead time, and minimum order quantity applies.
Products with D1 ≥ 20mm will be available by January 1st, 2018.

KenTIP FS HPG Geometry

Tolerance	
D1 metric	tolerance k8
6	0,000/+0,018
>6-10	0,000/+0,022
>10-18	0,000/+0,027
>18-26	0,000/+0,033

- Modular Drill Carbide Insert Blades • KenTIP™ FS • HPG Geometry • Grade KCP15A™ • No Internal Coolant Channels on the Insert • Through Coolant on the Body • Metric

Material Group	Cutting Speed – vc Range – m/min			Metric							
	min	Starting Value	max	Recommended Feed Rate per Rev							
					8,0	10,0	12,0	14,0	16,0	20,0	
P	1	90	130	170	mm/r	0,11–0,22	0,13–0,28	0,14–0,34	0,17–0,43	0,19–0,50	0,25–0,53
	2	100	140	180	mm/r	0,11–0,26	0,13–0,32	0,14–0,36	0,17–0,40	0,19–0,50	0,25–0,53
	3	60	100	130	mm/r	0,11–0,31	0,12–0,39	0,16–0,41	0,21–0,51	0,23–0,51	0,30–0,56
	4	60	100	130	mm/r	0,11–0,31	0,12–0,39	0,16–0,41	0,17–0,51	0,18–0,51	0,23–0,51
	5	60	70	100	mm/r	0,10–0,22	0,10–0,25	0,10–0,28	0,14–0,32	0,16–0,35	0,20–0,46
	6	60	70	70	mm/r	0,10–0,22	0,10–0,25	0,10–0,28	0,14–0,32	0,16–0,35	0,20–0,46
K	1	80	120	170	mm/r	0,15–0,32	0,16–0,35	0,17–0,39	0,21–0,46	0,25–0,53	0,31–0,65
	2	80	110	120	mm/r	0,15–0,32	0,16–0,33	0,17–0,36	0,21–0,45	0,25–0,53	0,31–0,65
	3	50	80	100	mm/r	0,16–0,33	0,17–0,36	0,18–0,40	0,20–0,45	0,21–0,48	0,23–0,53



- HPC-point geometry for all cast irons.
- 4-margin lands ensure hole straightness.
- Large corner radius prevents chipping and reduces exit burs when drilling through holes.
- KC7410™ is an AlCr PVD multilayer coating.
- Superb wear resistance.
- With internal coolant.

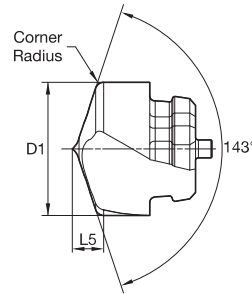
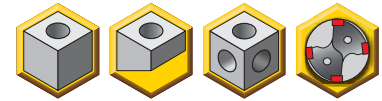

HPC Geometry

■ KenTIP FS Inserts • HPC KC7410 • With Internal Coolant Channels



KC7410	D1		L5		seat size
	mm	in	mm	in	
KTFST06000HPCM	6,000	.2362	1,410	.0555	A
KTFST06200HPCM	6,200	.2441	1,440	.0567	A
KTFST06350HPCM	6,350	.2500	1,490	.0587	B
KTFST06500HPCM	6,500	.2559	1,510	.0594	B
KTFST06530HPCM	6,530	.2571	1,520	.0598	B
KTFST06700HPCM	6,700	.2638	1,570	.0618	C
KTFST06746HPCM	6,746	.2656	1,570	.0618	C
KTFST06800HPCM	6,800	.2677	1,580	.0622	C
KTFST07000HPCM	7,000	.2756	1,640	.0646	D
KTFST07145HPCM	7,145	.2813	1,670	.0657	D
KTFST07300HPCM	7,300	.2874	1,690	.0665	D
KTFST07500HPCM	7,500	.2953	1,760	.0693	E
KTFST07600HPCM	7,600	.2992	1,780	.0701	E
KTFST07800HPCM	7,800	.3071	1,810	.0713	E
KTFST07938HPCM	7,938	.3125	1,830	.0720	E
KTFST08000HPCM	8,000	.3150	1,880	.0740	F
KTFST08100HPCM *	8,100	.3189	1,890	.0744	F
KTFST08204HPCM *	8,204	.3230	1,910	.0752	F
KTFST08500HPCM	8,500	.3346	1,990	.0783	G
KTFST08600HPCM *	8,600	.3386	2,010	.0791	G
KTFST08700HPCM *	8,700	.3425	2,030	.0799	G
KTFST08733HPCM *	8,732	.3438	2,030	.0799	G
KTFST09000HPCM	9,000	.3543	2,110	.0831	H
KTFST09100HPCM *	9,100	.3583	2,130	.0839	H
KTFST09500HPCM	9,500	.3740	2,230	.0878	I
KTFST09525HPCM	9,525	.3750	2,230	.0878	I
KTFST09600HPCM *	9,600	.3780	2,250	.0886	I
KTFST09700HPCM *	9,700	.3819	2,260	.0890	I
KTFST09800HPCM *	9,800	.3858	2,280	.0898	I
KTFST09921HPCM	9,921	.3906	2,300	.0906	I
KTFST10000HPCM	10,000	.3937	2,350	.0925	J
KTFST10023HPCM *	10,023	.3946	2,350	.0925	J
KTFST10200HPCM	10,200	.4016	2,380	.0937	J
KTFST10300HPCM	10,300	.4055	2,400	.0945	J
KTFST10320HPCM *	10,320	.4063	2,400	.0945	J
KTFST10500HPCM	10,500	.4134	2,460	.0969	K



- first choice
- alternate choice

KC7410	D1		L5		seat size
	mm	in	mm	in	
KTFST10600HPCM *	10,600	.4173	2,480	.0976	K
KTFST10700HPCM *	10,700	.4213	2,500	.0984	K
KTFST10716HPCM	10,716	.4219	2,500	.0984	K
KTFST10800HPCM	10,800	.4252	2,510	.0988	K
KTFST11000HPCM	11,000	.4331	2,580	.1016	L
KTFST11100HPCM	11,100	.4370	2,600	.1024	L
KTFST11113HPCM	11,112	.4375	2,600	.1024	L
KTFST11400HPCM	11,400	.4488	2,650	.1043	L
KTFST11500HPCM	11,500	.4528	2,700	.1063	M
KTFST11800HPCM *	11,800	.4646	2,750	.1083	M
KTFST11908HPCM *	11,908	.4688	2,770	.1091	M
KTFST12000HPCM	12,000	.4724	2,820	.1110	N
KTFST12304HPCM *	12,304	.4844	2,870	.1130	N
KTFST12500HPCM	12,500	.4921	2,930	.1154	O
KTFST12700HPCM	12,700	.5000	2,970	.1169	O
KTFST13000HPCM	13,000	.5118	3,050	.1201	P
KTFST13096HPCM	13,096	.5156	3,070	.1209	P
KTFST13200HPCM *	13,200	.5197	3,080	.1213	P
KTFST13300HPCM	13,300	.5236	3,100	.1220	P
KTFST13492HPCM	13,492	.5312	3,130	.1232	P
KTFST13500HPCM	13,500	.5315	3,170	.1248	Q
KTFST13600HPCM	13,600	.5354	3,180	.1252	Q
KTFST13800HPCM	13,800	.5433	3,220	.1268	Q
KTFST13891HPCM	13,891	.5469	3,230	.1272	Q
KTFST14000HPCM	14,000	.5512	3,290	.1295	R
KTFST14100HPCM *	14,100	.5551	3,300	.1299	R
KTFST14288HPCM	14,288	.5625	3,330	.1311	R
KTFST14500HPCM	14,500	.5709	3,400	.1339	S
KTFST14600HPCM *	14,600	.5748	3,420	.1346	S
KTFST14684HPCM *	14,684	.5781	3,430	.1350	S
KTFST14800HPCM *	14,800	.5827	3,450	.1358	S
KTFST15000HPCM	15,000	.5906	3,520	.1386	T
KTFST15083HPCM *	15,082	.5938	3,530	.1390	T
KTFST15100HPCM	15,100	.5945	3,540	.1394	T
KTFST15200HPCM *	15,200	.5984	3,550	.1398	T
KTFST15300HPCM *	15,300	.6024	3,570	.1406	T

(continued)

(KenTIP FS Inserts • HPC KC7410™ • With Internal Coolant Channels — continued)



● first choice
○ alternate choice

KC7410	D1		L5		seat size
	mm	in	mm	in	
KTFST15500HPCM	15,500	.6102	3,600	.1417	T
KTFST15600HPCM *	15,600	.6142	3,620	.1425	T
KTFST15800HPCM	15,800	.6220	3,650	.1437	T
KTFST15875HPCM *	15,875	.6250	3,670	.1445	T
KTFST16000HPCM	16,000	.6299	3,750	.1476	U
KTFST16100HPCM	16,100	.6339	3,770	.1484	U
KTFST16104HPCM *	16,104	.6340	3,770	.1484	U
KTFST16200HPCM *	16,200	.6378	3,790	.1492	U
KTFST16271HPCM *	16,271	.6406	3,800	.1496	U
KTFST16300HPCM *	16,300	.6417	3,800	.1496	U
KTFST16500HPCM	16,500	.6496	3,840	.1512	U
KTFST16550HPCM *	16,550	.6516	3,850	.1516	U
KTFST16600HPCM	16,600	.6535	3,850	.1516	U
KTFST16670HPCM	16,670	.6563	3,870	.1524	U
KTFST17000HPCM	17,000	.6693	3,990	.1571	V
KTFST17066HPCM *	17,066	.6719	4,000	.1575	V
KTFST17100HPCM *	17,100	.6732	4,010	.1579	V
KTFST17200HPCM	17,200	.6772	4,020	.1583	V
KTFST17300HPCM	17,300	.6811	4,040	.1591	V
KTFST17463HPCM *	17,462	.6875	4,070	.1602	V
KTFST17500HPCM	17,500	.6890	4,070	.1602	V
KTFST17550HPCM *	17,550	.6909	4,080	.1606	V
KTFST17600HPCM	17,600	.6929	4,090	.1610	V
KTFST17700HPCM *	17,700	.6969	4,110	.1618	V
KTFST17800HPCM	17,800	.7008	4,120	.1622	V
KTFST18000HPCM	18,000	.7087	4,220	.1661	W
KTFST18100HPCM *	18,100	.7126	4,240	.1669	W
KTFST18258HPCM *	18,258	.7188	4,270	.1681	W
KTFST18500HPCM	18,500	.7283	4,310	.1697	W
KTFST18600HPCM	18,600	.7323	4,320	.1701	W
KTFST18700HPCM *	18,700	.7362	4,340	.1709	W
KTFST19000HPCM	19,000	.7480	4,460	.1756	X

KC7410	D1		L5		seat size
	mm	in	mm	in	
KTFST19050HPCM	19,050	.7500	4,470	.1760	X
KTFST19279HPCM *	19,279	.7590	4,500	.1772	X
KTFST19446HPCM *	19,446	.7656	4,530	.1783	X
KTFST19500HPCM	19,500	.7677	4,540	.1787	X
KTFST19800HPCM *	19,800	.7795	4,590	.1807	X
KTFST20000HPCM	20,000	.7874	4,690	.1846	Y
KTFST20241HPCM	20,241	.7969	4,730	.1862	Y
KTFST20300HPCM *	20,300	.7992	4,740	.1866	Y
KTFST20500HPCM	20,500	.8071	4,780	.1882	Y
KTFST20638HPCM	20,638	.8125	4,800	.1890	Y
KTFST21000HPCM	21,000	.8268	4,930	.1941	Z
KTFST21433HPCM *	21,432	.8438	5,000	.1969	Z
KTFST21500HPCM *	21,500	.8465	5,010	.1972	Z
KTFST22000HPCM	22,000	.8661	5,160	.2031	ZA
KTFST22225HPCM *	22,225	.8750	5,200	.2047	ZA
KTFST22440HPCM *	22,440	.8835	5,240	.2063	ZA
KTFST22500HPCM *	22,500	.8858	5,250	.2067	ZA
KTFST23000HPCM	23,000	.9055	5,400	.2126	ZB
KTFST23416HPCM *	23,416	.9219	5,470	.2154	ZB
KTFST23500HPCM *	23,500	.9252	5,480	.2157	ZB
KTFST23813HPCM *	23,812	.9375	5,530	.2177	ZB
KTFST24000HPCM	24,000	.9449	5,630	.2217	ZC
KTFST24500HPCM *	24,500	.9646	5,720	.2252	ZC
KTFST24608HPCM *	24,608	.9688	5,730	.2256	ZC
KTFST25000HPCM	25,000	.9843	5,870	.2311	ZD
KTFST25070HPCM *	25,070	.9870	5,880	.2315	ZD
KTFST25400HPCM	25,400	1.0000	5,930	.2335	ZD
KTFST25500HPCM *	25,500	1.0039	5,950	.2343	ZD
KTFST25679HPCM *	25,679	1.0110	5,980	.2354	ZD
KTFST25806HPCM *	25,806	1.0160	6,000	.2362	ZD
KTFST26000HPCM	26,000	1.0236	6,030	.2374	ZD

NOTE: *Made-to-order standard item. Standard pricing, manufacturing lead time, and minimum order quantity applies.
 Products with D1 ≤ 19,999mm will be available in November 2017.
 Products with D1 ≥ 20mm will be available by January 1st, 2018.

KenTIP FS HPC Geometry

Tolerance

D1 metric	tolerance k8
6	0,000/+0,018
>6-10	0,000/+0,022
>10-18	0,000/+0,027
>18-26	0,000/+0,033

Application Data

Modular Drill Carbide Insert Blades • KenTIP™ FS • HPC Geometry • Grade KC7410™ • Through Coolant • Metric

Material Group	Cutting Speed – vc			Metric							
	Range – m/min			Recommended Feed Rate per Rev							
	min	Starting Value	max	8,0	10,0	12,0	14,0	16,0	20,0		
K	1	100	175	200	mm/r	0,14–0,34	0,16–0,39	0,19–0,45	0,23–0,50	0,26–0,58	0,3–0,64
	2	100	160	180	mm/r	0,14–0,34	0,16–0,39	0,19–0,45	0,23–0,50	0,26–0,58	0,3–0,64
	3	70	85	120	mm/r	0,13–0,27	0,15–0,33	0,17–0,37	0,19–0,42	0,21–0,46	0,28–0,54



- HPL-point geometry for stainless steels.
- Forms 2 chips per cutting edge for an uninterrupted and smooth chip flow.
- KCMS15™ is an AlTiN PVD monolayer coating.
- Prevents edge built-up, which delivers superior hole quality.
- Very high metal removal rates.
- With internal coolant.

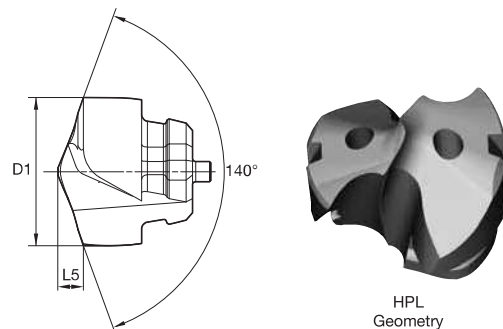
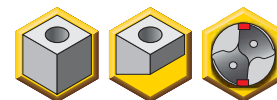

■ KenTIP FS Inserts • HPL KCMS15 • With Internal Coolant Channels



KCMS15	D1		L5		seat size
	mm	in	mm	in	
KTFST06000HPLM	6,000	.2362	1,340	.0528	A
KTFST06350HPLM	6,350	.2500	1,400	.0551	B
KTFST06500HPLM	6,500	.2559	1,430	.0563	B
KTFST06629HPLM	6,629	.2610	1,460	.0575	C
KTFST06800HPLM	6,800	.2677	1,490	.0587	C
KTFST07000HPLM	7,000	.2756	1,530	.0602	D
KTFST07500HPLM	7,500	.2953	1,630	.0642	E
KTFST07800HPLM	7,800	.3071	1,680	.0661	E
KTFST07938HPLM	7,938	.3125	1,710	.0673	E
KTFST08000HPLM	8,000	.3150	1,720	.0677	F
KTFST08100HPLM *	8,100	.3189	1,740	.0685	F
KTFST08204HPLM *	8,204	.3230	1,760	.0693	F
KTFST08334HPLM *	8,334	.3281	1,790	.0705	F
KTFST08400HPLM *	8,400	.3307	1,800	.0709	F
KTFST08500HPLM	8,500	.3346	1,820	.0717	G
KTFST08600HPLM *	8,600	.3386	1,840	.0724	G
KTFST08700HPLM *	8,700	.3425	1,860	.0732	G
KTFST08800HPLM *	8,800	.3465	1,880	.0740	G
KTFST08900HPLM	8,900	.3504	1,900	.0748	G
KTFST09000HPLM	9,000	.3543	1,930	.0760	H
KTFST09100HPLM *	9,100	.3583	1,950	.0768	H
KTFST09200HPLM	9,200	.3622	1,970	.0776	H
KTFST09400HPLM *	9,400	.3701	2,000	.0787	H
KTFST09500HPLM	9,500	.3740	2,030	.0799	I
KTFST09558HPLM *	9,558	.3763	2,040	.0803	I
KTFST09600HPLM	9,600	.3780	2,050	.0807	I
KTFST09700HPLM *	9,700	.3819	2,070	.0815	I
KTFST09800HPLM	9,800	.3858	2,090	.0823	I
KTFST09900HPLM	9,900	.3898	2,110	.0831	I
KTFST10000HPLM	10,000	.3937	2,130	.0839	J
KTFST10100HPLM	10,100	.3976	2,150	.0846	J
KTFST10200HPLM	10,200	.4016	2,170	.0854	J
KTFST10300HPLM	10,300	.4055	2,190	.0862	J
KTFST10320HPLM	10,320	.4063	2,190	.0862	J
KTFST10400HPLM *	10,400	.4094	2,210	.0870	J
KTFST10500HPLM	10,500	.4134	2,230	.0878	K



KCMS15	D1		L5		seat size
	mm	in	mm	in	
KTFST10600HPLM *	10,600	.4173	2,250	.0886	K
KTFST10700HPLM	10,700	.4213	2,270	.0894	K
KTFST10800HPLM *	10,800	.4252	2,290	.0902	K
KTFST10900HPLM *	10,900	.4291	2,310	.0909	K
KTFST11000HPLM	11,000	.4331	2,340	.0921	L
KTFST11100HPLM	11,100	.4370	2,350	.0925	L
KTFST11113HPLM	11,112	.4375	2,360	.0929	L
KTFST11200HPLM *	11,200	.4409	2,370	.0933	L
KTFST11400HPLM *	11,400	.4488	2,410	.0949	L
KTFST11500HPLM	11,500	.4528	2,440	.0961	M
KTFST11600HPLM *	11,600	.4567	2,460	.0969	M
KTFST11800HPLM *	11,800	.4646	2,490	.0980	M
KTFST11908HPLM	11,908	.4688	2,520	.0992	M
KTFST12000HPLM	12,000	.4724	2,540	.1000	N
KTFST12200HPLM *	12,200	.4803	2,580	.1016	N
KTFST12304HPLM	12,304	.4844	2,600	.1024	N
KTFST12500HPLM	12,500	.4921	2,640	.1039	O
KTFST12700HPLM	12,700	.5000	2,680	.1055	O
KTFST12800HPLM *	12,800	.5039	2,700	.1063	O
KTFST12900HPLM *	12,900	.5079	2,720	.1071	O
KTFST13000HPLM	13,000	.5118	2,740	.1079	P
KTFST13096HPLM	13,096	.5156	2,760	.1087	P
KTFST13200HPLM *	13,200	.5197	2,780	.1094	P
KTFST13492HPLM *	13,492	.5312	2,840	.1118	P
KTFST13500HPLM	13,500	.5315	2,840	.1118	Q
KTFST13800HPLM *	13,800	.5433	2,900	.1142	Q
KTFST13891HPLM *	13,891	.5469	2,920	.1150	Q
KTFST13896HPLM *	13,896	.5471	2,920	.1150	Q
KTFST14000HPLM	14,000	.5512	2,950	.1161	R
KTFST14100HPLM *	14,100	.5551	2,960	.1165	R
KTFST14200HPLM *	14,200	.5591	2,980	.1173	R
KTFST14288HPLM	14,288	.5625	3,000	.1181	R
KTFST14300HPLM	14,300	.5630	3,000	.1181	R
KTFST14400HPLM *	14,400	.5669	3,020	.1189	R
KTFST14500HPLM	14,500	.5709	3,050	.1201	S
KTFST14684HPLM *	14,684	.5781	3,080	.1213	S

- first choice
- alternate choice

(continued)

(KenTIP FS Inserts • HPL KCMS15™ • With Internal Coolant Channels — continued)



● first choice
○ alternate choice

KCMS15	D1		L5		seat size	KCMS15	D1		L5		seat size
	mm	in	mm	in			mm	in	mm	in	
KTFST14800HPLM *	14,800	.5827	3,100	.1220	S	KTFST19355HPLM *	19,355	.7620	4,020	.1583	X
KTFST15000HPLM	15,000	.5906	3,150	.1240	T	KTFST19446HPLM	19,446	.7656	4,040	.1591	X
KTFST15100HPLM *	15,100	.5945	3,170	.1248	T	KTFST19460HPLM *	19,460	.7661	4,040	.1591	X
KTFST15200HPLM *	15,200	.5984	3,190	.1256	T	KTFST19500HPLM	19,500	.7677	4,050	.1594	X
KTFST15500HPLM	15,500	.6102	3,240	.1276	T	KTFST19845HPLM	19,845	.7813	4,120	.1622	X
KTFST15875HPLM	15,875	.6250	3,310	.1303	T	KTFST19850HPLM *	19,850	.7815	4,120	.1622	X
KTFST16000HPLM	16,000	.6299	3,350	.1319	U	KTFST20000HPLM	20,000	.7874	4,160	.1638	Y
KTFST16100HPLM *	16,100	.6339	3,370	.1327	U	KTFST20500HPLM	20,500	.8071	4,250	.1673	Y
KTFST16104HPLM	16,104	.6340	3,370	.1327	U	KTFST20638HPLM	20,638	.8125	4,280	.1685	Y
KTFST16150HPLM	16,150	.6358	3,380	.1331	U	KTFST21000HPLM	21,000	.8268	4,360	.1717	Z
KTFST16271HPLM	16,271	.6406	3,400	.1339	U	KTFST21150HPLM *	21,150	.8327	4,390	.1728	Z
KTFST16500HPLM	16,500	.6496	3,450	.1358	U	KTFST21500HPLM	21,500	.8465	4,450	.1752	Z
KTFST16670HPLM	16,670	.6563	3,480	.1370	U	KTFST22000HPLM	22,000	.8661	4,560	.1795	ZA
KTFST17000HPLM	17,000	.6693	3,550	.1398	V	KTFST22225HPLM	22,225	.8750	4,600	.1811	ZA
KTFST17463HPLM *	17,462	.6875	3,640	.1433	V	KTFST22500HPLM	22,500	.8858	4,660	.1835	ZA
KTFST17480HPLM	17,480	.6882	3,640	.1433	V	KTFST23000HPLM	23,000	.9055	4,760	.1874	ZB
KTFST17500HPLM	17,500	.6890	3,650	.1437	V	KTFST23500HPLM	23,500	.9252	4,860	.1913	ZB
KTFST17700HPLM *	17,700	.6969	3,690	.1453	V	KTFST23813HPLM	23,812	.9375	4,920	.1937	ZB
KTFST18000HPLM	18,000	.7087	3,760	.1480	W	KTFST24000HPLM	24,000	.9449	4,960	.1953	ZC
KTFST18258HPLM *	18,258	.7188	3,800	.1496	W	KTFST24500HPLM	24,500	.9646	5,060	.1992	ZC
KTFST18500HPLM	18,500	.7283	3,850	.1516	W	KTFST25000HPLM	25,000	.9843	5,170	.2035	ZD
KTFST18654HPLM *	18,654	.7344	3,880	.1528	W	KTFST25400HPLM	25,400	1.0000	5,240	.2063	ZD
KTFST19000HPLM	19,000	.7480	3,960	.1559	X	KTFST25500HPLM	25,500	1.0039	5,260	.2071	ZD
KTFST19050HPLM	19,050	.7500	3,970	.1563	X	KTFST25600HPLM	25,600	1.0079	5,280	.2079	ZD
KTFST19200HPLM *	19,200	.7559	3,990	.1571	X	KTFST25650HPLM	25,650	1.0098	5,290	.2083	ZD
KTFST19228HPLM *	19,228	.7570	4,000	.1575	X	KTFST25679HPLM	25,679	1.0110	5,290	.2083	ZD
KTFST19253HPLM	19,253	.7580	4,000	.1575	X	KTFST25806HPLM	25,806	1.0160	5,320	.2094	ZD
KTFST19279HPLM	19,279	.7590	4,010	.1579	X	KTFST26000HPLM	26,000	1.0236	5,370	.2114	ZD

NOTE: *Made-to-order standard item. Standard pricing, manufacturing lead time, and minimum order quantity applies.
Products with D1 ≥ 20mm will be available by January 1st, 2018.

KenTIP FS HPL Geometry

Tolerance	
D1 metric	tolerance k8
6	0,000/+0,018
>6-10	0,000/+0,022
>10-18	0,000/+0,027
>18-26	0,000/+0,033

Application Data

Modular Drill Carbide Insert Blades • KenTIP™ FS • HPL Geometry • Grade KCMS15™ • Through Coolant • Metric

Material Group	Cutting Speed — vc				Metric						
	Range — m/min				Recommended Feed Rate per Rev						
	min	Starting Value	max		8,0	10,0	12,0	14,0	16,0	20,0	
M	1	50	60	90	mm/r	0,08-0,15	0,09-0,18	0,11-0,20	0,12-0,22	0,13-0,24	0,16-0,28
	2	30	60	90	mm/r	0,08-0,15	0,09-0,18	0,11-0,20	0,12-0,22	0,13-0,24	0,16-0,28
	3	20	50	60	mm/r	0,08-0,15	0,09-0,18	0,11-0,20	0,12-0,22	0,13-0,24	0,16-0,28



- KenTIP FS toolholder with straight cylindrical round metric shank.
- 12 x D holders feature a flanged shank for improved stiffness.
- Multi-coolant provides an advanced coolant channel layout with four coolant exits in each holder.
- Each tool body is shipped with related insert wrench.



Modular Drills

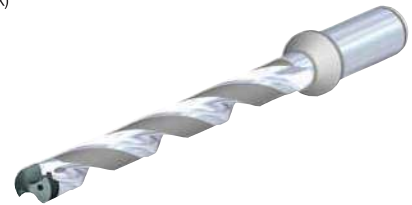
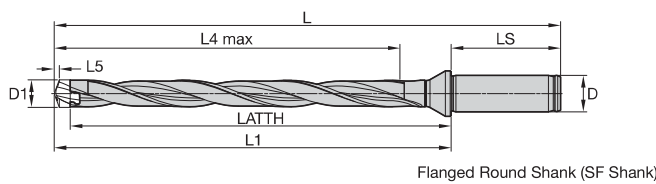
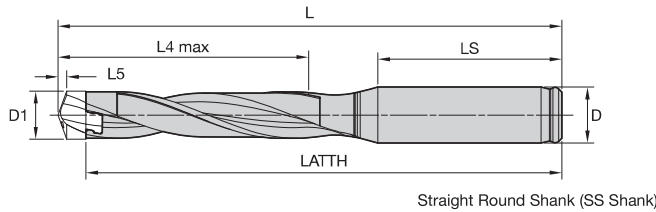

■ KenTIP FS Round Shank • 1.5 x D/3 x D/5 x D/8 x D/12 x D • Metric



	1.5 x D SS	3 x D SS	5 x D SS	8 x D SS	12 x D SF	D1		D1 max		seat size	KenTIP wrench
						mm	in	mm	in		
	KTFS060R01SS8M	KTFS060R03SS8M	KTFS060R05SS8M	KTFS060R08SS8M	KTFS060R12SF12M	6,000	.2363	6,299	.2480	A	170.319
	KTFS063R01SS8M	KTFS063R03SS8M	KTFS063R05SS8M	KTFS063R08SS8M	KTFS063R12SF12M	6,300	.2481	6,599	.2598	B	170.319
	KTFS066R01SS8M	KTFS066R03SS8M	KTFS066R05SS8M	KTFS066R08SS8M	KTFS066R12SF12M	6,600	.2599	6,999	.2755	C	170.319
	KTFS070R01SS8M	KTFS070R03SS8M	KTFS070R05SS8M	KTFS070R08SS8M	KTFS070R12SF12M	7,000	.2756	7,499	.2952	D	170.319
	KTFS075R01SS8M	KTFS075R03SS8M	KTFS075R05SS8M	KTFS075R08SS8M	KTFS075R12SF12M	7,500	.2953	7,999	.3149	E	170.319
	KTFS080R01SS10M	KTFS080R03SS10M	KTFS080R05SS10M	KTFS080R08SS10M	KTFS080R12SF12M	8,000	.3150	8,499	.3346	F	170.306
	KTFS085R01SS10M	KTFS085R03SS10M	KTFS085R05SS10M	KTFS085R08SS10M	KTFS085R12SF12M	8,500	.3346	8,999	.3543	G	170.306
	KTFS090R01SS10M	KTFS090R03SS10M	KTFS090R05SS10M	KTFS090R08SS10M	KTFS090R12SF12M	9,000	.3544	9,499	.3739	H	170.306
	KTFS095R01SS10M	KTFS095R03SS10M	KTFS095R05SS10M	KTFS095R08SS10M	KTFS095R12SF12M	9,500	.3740	9,999	.3936	I	170.306
	KTFS100R01SS12M	KTFS100R03SS12M	KTFS100R05SS12M	KTFS100R08SS12M	KTFS100R12SF16M	10,000	.3937	10,499	.4133	J	170.307
	KTFS105R01SS12M	KTFS105R03SS12M	KTFS105R05SS12M	KTFS105R08SS12M	KTFS105R12SF16M	10,500	.4134	10,999	.4330	K	170.307
	KTFS110R01SS12M	KTFS110R03SS12M	KTFS110R05SS12M	KTFS110R08SS12M	KTFS110R12SF16M	11,000	.4331	11,499	.4527	L	170.307
	KTFS115R01SS12M	KTFS115R03SS12M	KTFS115R05SS12M	KTFS115R08SS12M	KTFS115R12SF16M	11,500	.4528	11,999	.4724	M	170.307
	KTFS120R01SS14M	KTFS120R03SS14M	KTFS120R05SS14M	KTFS120R08SS14M	KTFS120R12SF16M	12,000	.4725	12,499	.4921	N	170.308
	KTFS125R01SS14M	KTFS125R03SS14M	KTFS125R05SS14M	KTFS125R08SS14M	KTFS125R12SF16M	12,500	.4922	12,999	.5117	O	170.308
	KTFS130R01SS14M	KTFS130R03SS14M	KTFS130R05SS14M	KTFS130R08SS14M	KTFS130R12SF16M	13,000	.5118	13,499	.5314	P	170.308
	KTFS135R01SS14M	KTFS135R03SS14M	KTFS135R05SS14M	KTFS135R08SS14M	KTFS135R12SF16M	13,500	.5315	13,999	.5511	Q	170.308
	KTFS140R01SS16M	KTFS140R03SS16M	KTFS140R05SS16M	KTFS140R08SS16M	KTFS140R12SF16M	14,000	.5512	14,499	.5708	R	170.309
	KTFS145R01SS16M	KTFS145R03SS16M	KTFS145R05SS16M	KTFS145R08SS16M	KTFS145R12SF16M	14,500	.5709	14,999	.5905	S	170.309
	KTFS150R01SS16M	KTFS150R03SS16M	KTFS150R05SS16M	KTFS150R08SS16M	KTFS150R12SF20M	15,000	.5906	15,999	.6299	T	170.309
	KTFS160R01SS16M	KTFS160R03SS16M	KTFS160R05SS16M	KTFS160R08SS16M	KTFS160R12SF20M	16,000	.6300	16,999	.6692	U	170.309
	KTFS170R01SS20M	KTFS170R03SS20M	KTFS170R05SS20M	KTFS170R08SS20M	KTFS170R12SF20M	17,000	.6693	17,999	.7086	V	170.314
	KTFS180R01SS20M	KTFS180R03SS20M	KTFS180R05SS20M	KTFS180R08SS20M	KTFS180R12SF25M	18,000	.7087	18,999	.7479	W	170.314
	KTFS190R01SS20M	KTFS190R03SS20M	KTFS190R05SS20M	KTFS190R08SS20M	KTFS190R12SF25M	19,000	.7480	19,999	.7873	X	170.314

- KenTIP FS toolholder with flanged shank and 90° flat metric shank.
- Multi-coolant provides an advanced coolant channel layout with four coolant exits in each holder.
- Each tool body is shipped with related insert wrench.

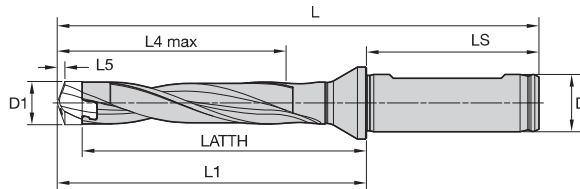

Flanged Shank with Flat (SCF Shank)

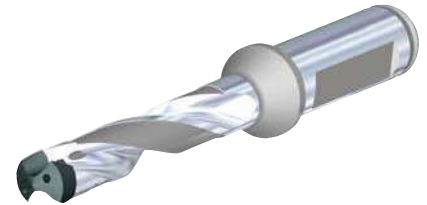

Modular Drills

■ KenTIP FS Flanged Shank with Flat • 1.5 x D/3 x D/5 x D/8 x D/12 x D • Metric



	1.5 x D SCF	3 x D SCF	5 x D SCF	8 x D SCF	12 x D SCF	D1		D1 max		seat size	KenTIP wrench
						mm	in	mm	in		
-		KTFS080R03SCF12M	KTFS080R05SCF12M	KTFS080R08SCF12M	-	8,000	.3150	8,499	.3346	F	170.306
-		KTFS085R03SCF12M	KTFS085R05SCF12M	KTFS085R08SCF12M	-	8,500	.3346	8,999	.3543	G	170.306
-		KTFS090R03SCF12M	KTFS090R05SCF12M	KTFS090R08SCF12M	-	9,000	.3544	9,499	.3739	H	170.306
-		KTFS095R03SCF12M	KTFS095R05SCF12M	KTFS095R08SCF12M	-	9,500	.3740	9,999	.3936	I	170.306
-		KTFS100R03SCF16M	KTFS100R05SCF16M	KTFS100R08SCF16M	-	10,000	.3937	10,499	.4133	J	170.307
-		KTFS105R03SCF16M	KTFS105R05SCF16M	KTFS105R08SCF16M	-	10,500	.4134	10,999	.4330	K	170.307
-		KTFS110R03SCF16M	KTFS110R05SCF16M	KTFS110R08SCF16M	-	11,000	.4331	11,499	.4527	L	170.307
-		KTFS115R03SCF16M	KTFS115R05SCF16M	KTFS115R08SCF16M	-	11,500	.4528	11,999	.4724	M	170.307
-		KTFS120R03SCF16M	KTFS120R05SCF16M	KTFS120R08SCF16M	-	12,000	.4725	12,499	.4921	N	170.308
-		KTFS125R03SCF16M	KTFS125R05SCF16M	KTFS125R08SCF16M	-	12,500	.4922	12,999	.5117	O	170.308
-		KTFS130R03SCF16M	KTFS130R05SCF16M	KTFS130R08SCF16M	-	13,000	.5118	13,499	.5314	P	170.308
-		KTFS135R03SCF16M	KTFS135R05SCF16M	KTFS135R08SCF16M	-	13,500	.5315	13,999	.5511	Q	170.308
-		KTFS140R03SCF16M	KTFS140R05SCF16M	KTFS140R08SCF16M	-	14,000	.5512	14,499	.5708	R	170.309
-		KTFS145R03SCF16M	KTFS145R05SCF16M	KTFS145R08SCF16M	-	14,500	.5709	14,999	.5905	S	170.309
-		KTFS150R03SCF20M	KTFS150R05SCF20M	KTFS150R08SCF20M	-	15,000	.5906	15,999	.6299	T	170.309
-		KTFS160R03SCF20M	KTFS160R05SCF20M	KTFS160R08SCF20M	-	16,000	.6300	16,999	.6692	U	170.309
-		KTFS170R03SCF20M	KTFS170R05SCF20M	KTFS170R08SCF20M	-	17,000	.6693	17,999	.7086	V	170.314
-		KTFS180R03SCF25M	KTFS180R05SCF25M	KTFS180R08SCF25M	-	18,000	.7087	18,999	.7479	W	170.314
-		KTFS190R03SCF25M	KTFS190R05SCF25M	KTFS190R08SCF25M	-	19,000	.7480	19,999	.7873	X	170.314
KTFS200R01SCF25M	KTFS200R03SCF25M	KTFS200R05SCF25M	KTFS200R08SCF25M	KTFS200R12SCF25M		20,000	.7874	20,999	.8267	Y	170.314
KTFS210R01SCF25M	KTFS210R03SCF25M	KTFS210R05SCF25M	KTFS210R08SCF25M	KTFS210R12SCF25M		21,000	.8268	21,999	.8661	Z	170.314
KTFS220R01SCF25M	KTFS220R03SCF25M	KTFS220R05SCF25M	KTFS220R08SCF25M	KTFS220R12SCF25M		22,000	.8662	22,999	.9054	ZA	170.314
KTFS230R01SCF25M	KTFS230R03SCF25M	KTFS230R05SCF25M	KTFS230R08SCF25M	KTFS230R12SCF25M		23,000	.9055	23,999	.9448	ZB	170.314
KTFS240R01SCF25M	KTFS240R03SCF25M	KTFS240R05SCF25M	KTFS240R08SCF25M	KTFS240R12SCF25M		24,000	.9449	24,999	.9842	ZC	170.314
KTFS250R01SCF25M	KTFS250R03SCF25M	KTFS250R05SCF25M	KTFS250R08SCF25M	KTFS250R12SCF25M		25,000	.9843	25,999	1.0236	ZD	170.314

NOTE: Products with D1 ≥ 20mm will be available by January 1st, 2018.

Modular Drills • Dimension Tables

■ Straight Round Shank • Metric

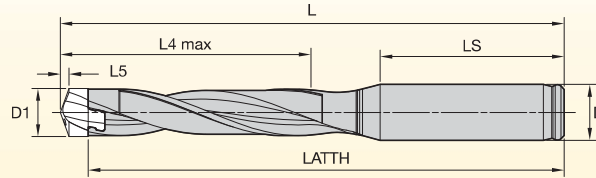

D1 min	D1 max	Seat	LS	round D	1.5 x D SS			3 x D SS			5 x D SS			8 x D SS		
					LATTH	L	L4 max	LATTH	L	L4 max	LATTH	L	L4 max	LATTH	L	L4 max
6,000	6,299	A	37	8	53,5	57	9	63,5	67	19	76,5	80	32	94,5	98	50
6,300	6,599	B	37	8	54,3	58	10	64,3	68	20	77,3	81	33	97,3	101	53
6,600	6,999	C	37	8	55,2	59	10	66,2	70	21	80,2	84	35	101,2	105	56
7,000	7,499	D	37	8	55,9	60	11	66,9	71	22	82,9	87	38	104,9	109	60
7,500	7,999	E	37	8	56,7	61	12	68,7	73	24	84,7	89	40	108,7	113	64
8,000	8,499	F	41	10	63,4	68	13	76,4	81	26	92,4	97	42	118,4	123	68
8,500	8,999	G	41	10	64,1	69	14	77,1	82	27	95,1	100	45	122,1	127	72
9,000	9,499	H	41	10	63,8	69	14	77,8	83	28	97,8	103	48	125,8	131	76
9,500	9,999	I	41	10	64,5	70	15	79,5	85	30	99,5	105	50	129,5	135	80
10,000	10,499	J	46	12	72,2	78	16	88,2	94	32	108,2	114	52	140,2	146	84
10,500	10,999	K	46	12	71,9	78	16	88,9	95	33	110,9	117	55	143,9	150	88
11,000	11,499	L	46	12	72,6	79	17	89,6	96	34	113,6	120	58	147,6	154	92
11,500	11,999	M	46	12	73,3	80	18	91,3	98	36	115,3	122	60	151,3	158	96
12,000	12,499	N	46	14	76,0	83	19	95,0	102	38	119,0	126	62	157,0	164	100
12,500	12,999	O	46	14	76,8	84	20	95,8	103	39	121,8	129	65	160,8	168	104
13,000	13,499	P	46	14	76,5	84	20	96,5	104	40	124,5	132	68	164,5	172	108
13,500	13,999	Q	46	14	77,2	85	21	98,2	106	42	126,2	134	70	168,2	176	112
14,000	14,499	R	49	16	81,9	90	22	103,9	112	44	131,9	140	72	175,9	184	116
14,500	14,999	S	49	16	81,6	90	22	104,6	113	45	134,6	143	75	179,6	188	120
15,000	15,999	T	49	16	83,3	92	24	107,3	116	48	139,3	148	80	187,3	196	128
16,000	16,999	U	49	16	84,7	94	26	109,7	119	51	143,7	153	85	194,7	204	136
17,000	17,999	V	51	20	90,1	100	27	117,1	127	54	153,1	163	90	207,1	217	144
18,000	18,999	W	51	20	90,6	101	28	119,6	130	57	157,6	168	95	214,6	225	152
19,000	19,999	X	51	20	92,0	103	30	122,0	133	60	162,0	173	100	222,0	233	160

NOTE: Toolholder dimensions:
 L: Total length of drill
 L4: Max. drilling depth
 L5: Protruding length (Insert specific. See related insert pages)
 LATTH: Pocket seat reference length
 LS: Shank length

(continued)

Modular Drills • Dimension Tables *(continued)*

■ Flanged Round Shank • Metric

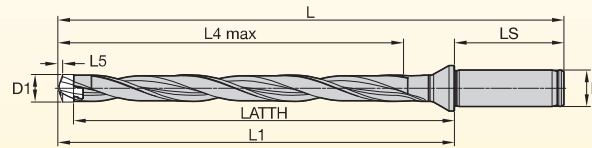

D1		Seat	12 x D SF					
min	max		LS	flanged D	LATTH	L	L1	L4 max
6,000	6,299	A	45	12	92,5	141	96	76
6,300	6,599	B	45	12	95,3	144	99	79
6,600	6,999	C	45	12	101,2	150	105	84
7,000	7,499	D	45	12	106,9	156	111	90
7,500	7,999	E	45	12	112,7	162	117	96
8,000	8,499	F	45	12	118,4	168	123	102
8,500	8,999	G	45	12	124,1	174	129	108
9,000	9,499	H	45	12	129,8	180	135	114
9,500	9,999	I	45	12	135,5	186	141	120
10,000	10,499	J	48	16	144,2	198	150	126
10,500	10,999	K	48	16	149,9	204	156	132
11,000	11,499	L	48	16	155,6	210	162	138
11,500	11,999	M	48	16	161,3	216	168	144
12,000	12,499	N	48	16	167,0	222	174	150
12,500	12,999	O	48	16	172,8	228	180	156
13,000	13,499	P	48	16	178,5	234	186	162
13,500	13,999	Q	48	16	184,2	240	192	168
14,000	14,499	R	48	16	189,9	246	198	174
14,500	14,999	S	48	16	195,6	252	204	180
15,000	15,999	T	50	20	210,3	269	219	192
16,000	16,999	U	50	20	221,7	281	231	204
17,000	17,999	V	50	20	233,1	293	243	216
18,000	18,999	W	56	25	247,6	314	258	228
19,000	19,999	X	56	25	259,0	326	270	240

NOTE: Toolholder dimensions:
 L: Total length of drill
 L1: Drill length including flange
 L4: Max. drilling depth
 L5: Protruding length (Insert specific. See related insert pages)
 LATTH: Pocket seat reference length
 LS: Shank length

(continued)

Modular Drills • Dimension Tables *(continued)*

■ Flanged Shank with Flat • Metric

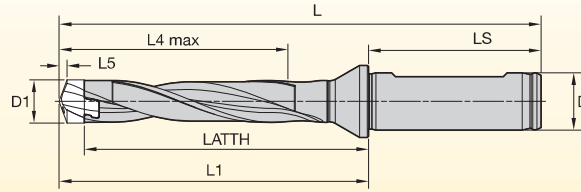

D1 min	D1 max	Seat	flanged		1.5 x D SCF				3 x D SCF				5 x D SCF				8 x D SCF				12 x D SCF			
			LS	D	LATTH	L	L1	L4 max	LATTH	L	L1	L4 max	LATTH	L	L1	L4 max	LATTH	L	L1	L4 max	LATTH	L	L1	L4 max
8,000	8,499	F	45	12	—	—	—	—	42,4	92	2	26	58,4	108	2	42	84,4	134	4	68	—	—	—	—
8,500	8,999	G	45	12	—	—	—	—	43,1	93	2	27	61,1	111	3	45	88,1	138	4	72	—	—	—	—
9,000	9,499	H	45	12	—	—	—	—	43,8	94	2	28	63,8	114	3	48	91,8	142	4	76	—	—	—	—
9,500	9,999	I	45	12	—	—	—	—	45,5	96	2	30	65,5	116	3	50	95,5	146	4	80	—	—	—	—
10,000	10,499	J	48	16	—	—	—	—	50,2	104	2	32	70,2	124	3	52	102,2	156	4	84	—	—	—	—
10,500	10,999	K	48	16	—	—	—	—	50,9	105	2	33	72,9	127	3	55	105,9	160	4	88	—	—	—	—
11,000	11,499	L	48	16	—	—	—	—	51,6	106	2	34	75,6	130	3	58	109,6	164	5	92	—	—	—	—
11,500	11,999	M	48	16	—	—	—	—	53,3	108	2	36	77,3	132	3	60	113,3	168	5	96	—	—	—	—
12,000	12,499	N	48	16	—	—	—	—	55,0	110	2	38	79,0	134	3	62	117,0	172	5	100	—	—	—	—
12,500	12,999	O	48	16	—	—	—	—	55,8	111	2	39	81,8	137	4	65	120,8	176	5	104	—	—	—	—
13,000	13,499	P	48	16	—	—	—	—	56,5	112	3	40	84,5	140	4	68	124,5	180	5	108	—	—	—	—
13,500	13,999	Q	48	16	—	—	—	—	58,2	114	3	42	86,2	142	4	70	128,2	184	5	112	—	—	—	—
14,000	14,499	R	48	16	—	—	—	—	59,9	116	3	44	87,9	144	4	72	131,9	188	6	116	—	—	—	—
14,500	14,999	S	48	16	—	—	—	—	60,6	117	3	45	90,6	147	4	75	135,6	192	6	120	—	—	—	—
15,000	15,999	T	50	20	—	—	—	—	66,3	125	3	48	98,3	157	4	80	146,3	205	6	128	—	—	—	—
16,000	16,999	U	50	20	—	—	—	—	68,7	128	3	51	102,7	162	4	85	153,7	213	6	136	—	—	—	—
17,000	17,999	V	50	20	—	—	—	—	71,1	131	3	54	107,1	167	5	90	161,1	221	7	144	—	—	—	—
18,000	18,999	W	56	25	—	—	—	—	76,6	143	3	57	114,6	181	5	95	171,6	238	7	152	—	—	—	—
19,000	19,999	X	56	25	—	—	—	—	79,0	146	4	60	119,0	186	5	100	179,0	246	7	160	—	—	—	—
20,000	20,999	Y	56	25	50,4	118	2	32	81,4	149	4	63	123,4	191	5	105	186,4	254	8	168	270,4	338	11	252
21,000	21,999	Z	56	25	50,8	119	2	33	83,8	152	4	66	127,8	196	6	110	193,8	262	8	176	281,8	350	12	264
22,000	22,999	ZA	56	25	51,2	120	3	34	86,2	155	4	69	132,2	201	6	115	201,2	270	8	184	293,2	362	12	276
23,000	23,999	ZB	56	25	52,7	122	3	36	88,7	158	4	72	136,7	206	6	120	208,7	278	9	192	304,7	374	13	288
24,000	24,999	ZC	56	25	54,1	124	3	38	91,1	161	4	75	141,1	211	6	125	216,1	286	9	200	316,1	386	13	300
25,000	25,999	ZD	56	25	54,5	125	3	39	93,5	164	4	78	145,5	216	6	130	223,5	294	9	208	327,5	398	13	312

NOTE: Toolholder dimensions:
 L: Total length of drill
 L1: Drill length including flange
 L4: Max. drilling depth
 L5: Protruding length (Insert specific. See related insert pages)
 LATTH: Pocket seat reference length
 LS: Shank length

Mounting

1

1. Protect your eyes and hands. Fix holder. Clean pocket with air blast.

2

2. Put insert into pocket seat so it rests firmly on the holder.

3

3. Turn slightly in clockwise direction using your fingers.

4 Mini-Wrench • Ø 6–7,999mm

4

4. Set wrench properly onto insert: Wrench noses must fit firmly into the chip grooves.

5

*For unmounting, firmly press wrench on insert to avoid slipping.

4 K-Wrench and Multi-Wrench • Ø 8–26mm

4

4. Set wrench properly onto insert: Wrench blade must fit firmly into slots on insert flanks.

Available Smart Wrenches

Mini-Wrench
Wrench noses must fit into the chip grooves.

K-Wrench
Wrench blades must fit into insert slots.

Multi-Wrench

Coolant

Internal coolant is recommended for all applications.

Flood coolant only for drilling depth $\leq 3 \times D$.

Dry cutting is not recommended. MQL ability is limited.

Core Deviation

Machining Center

max 0,02mm

Stationary Drill/Lathe

max 0,02mm

Rotating Applications

KenTIP FS holders with straight cylindrical SS and SF shanks (no flats) are designed for rotating applications where the drill rotates while the workpiece remains stationary. The shank to drill-point location of these drills is held to an extremely close tolerance. To maintain accuracy and gain maximum performance, please use the approved toolholding method shown below.



ERICKSON™ ER collet chucks



ERICKSON Hydrochuck HP Line



ERICKSON Shrink Fit toolholders for general purpose

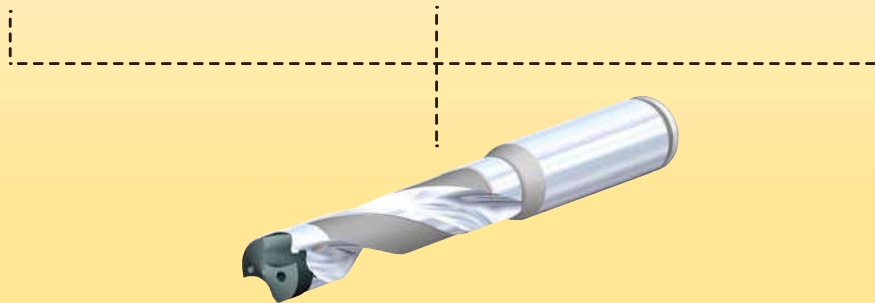

Rotating and Stationary Applications

KenTIP FS holders with SCF shanks (Cylindrical with 90° flat and flange) are reducing deflections and represent a stiffer holder solution. As the shank is compatible with End Mill adaptors, these holders are very flexible in use. SCF shanks can be used in any rotating applications and are suited for lathe and other settings where the tool is stationary.



EM adaptors

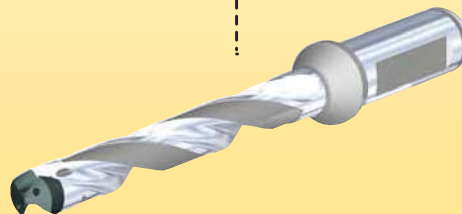

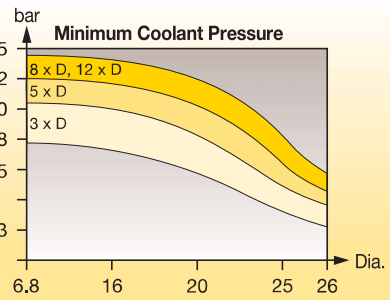
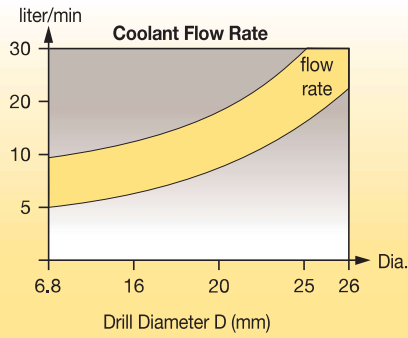

Drive Power (kW)

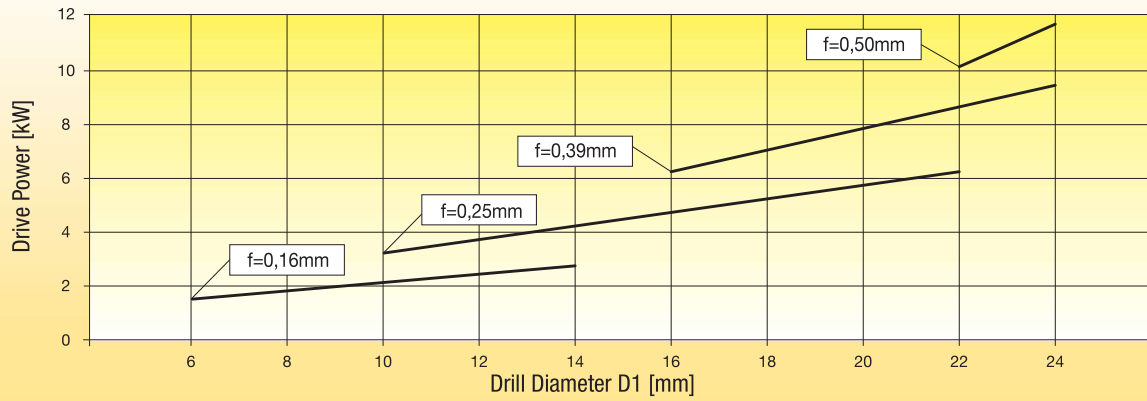

Feed Force (N)

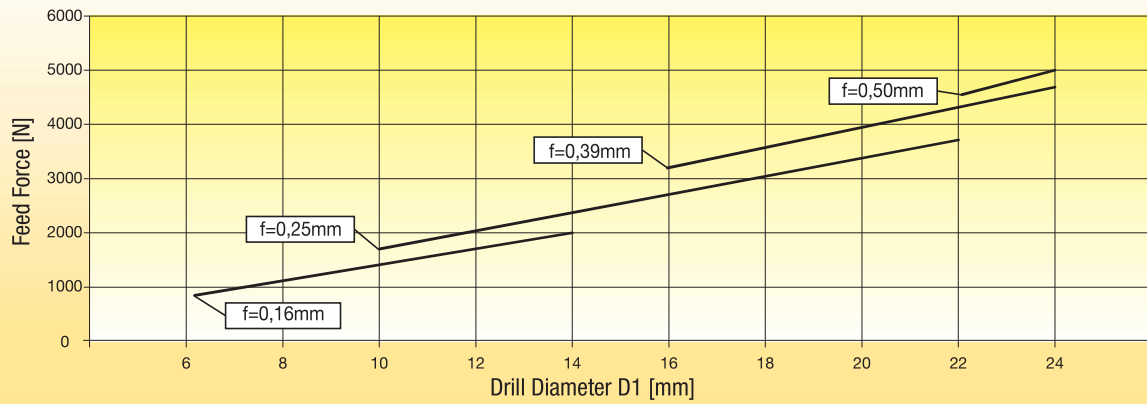

Torque (Nm)

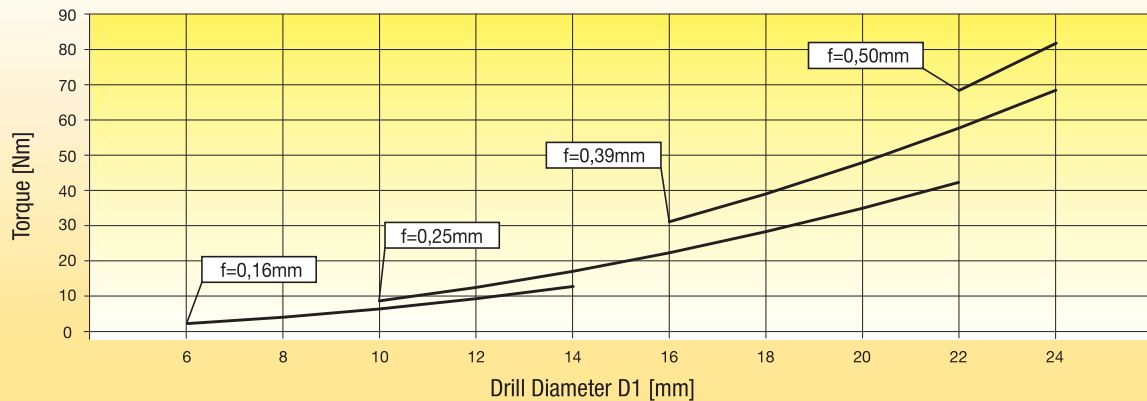

NOTE: The diagrams above are used to determine the drive power, feed force, and torque. They are based on cutting force measurement in tempered steels with a tensile strength: $R_m = 750 \text{ N/mm}^2$. The base cutting speed used is: $v_c = 80 \text{ m/min}$.

KenTIP™ Modular Drill System

Primary Application

The KenTIP modular drill system offers performance levels commonly achieved with solid carbide drills. The proprietary locking system enables inserts to be changed inside the machine tool. Use KenTIP in steel, cast iron, ductile iron, and stainless steel applications. KenTIP modular drills are available up to diameter 27,99mm (1.1020"). Change drilling inserts within the machine without taking the body off, saving setup time and manufacturing costs.

With our new FEG Flat bottom E-shape inserts, the KenTIP modular drill system now offers an easy and very reliable solution to drill blind holes that performs on a very wide range of difficult applications.

Features and Benefits

Advanced Interface

- Strong pocket seats on all inserts and bodies.
- Long tip and body life in unstable conditions, especially when side loads occur.

HP Drill-Point Design

- Very high feed rates possible.
- Low thrust prevents workpiece flexing.
- Excellent centring capabilities.

Easy Insert Change

- Locking method requires no screws or clamps.
- Insert blades can be changed with a simple provided tool and do not require drill body removal from the machine or holder.

Disposable Inserts

- No reconditioning costs.
- Consistent performance.
- Eliminates number of tools waiting for reconditioning, providing significant cost savings.

Tailored Grades and Geometries

- KCP15™ grade has a new PVD coating enabling longer tool life in all steel applications.
- KCPM45™ grade combines a very tough, fine-grain carbide substrate with a TiAlN PVD coating. It is used on our FEG flat-bottom inserts.
- For applications in cast iron and stainless steel, we recommend to use our new KenTIP FS modular drill. Please see page H6 for drills.
- For further availability on KC7320™ HPL and KC7410™ HPC inserts for KenTIP, please refer to NOVO™ or contact your sales representative.

NEW!

FEG Style, E-shape Flat-Bottom Inserts

KenTIP™ FEG inserts create blind holes, through holes, and countersinks. These inserts are focused on versatility and will support you in many essential drilling applications.



Drill Body Portfolio

- Standard 12 x D holders with round shanks available, inch and metric. This covers the complete KenTIP diameter range.
- Standard 3, 5, and 8 x D tool bodies with round and flanged shank available, inch and metric.
- Standard 1.5 x D bodies available, especially for piloting operations on metric drill bodies.

Customisation

- Intermediate diameters available as semi-standards.
- Close tolerance tips available for precision holes.
- Chamfering insert pockets available.
- Multiple steps possible.
- CounterFix Micro tangential inserts for small diameter step drills.



NEW!

CounterFix Micro Tangential Inserts

- KenTIP KCP15™ HP cutting edges enable high metal removal rates and superior tool life for steel applications.
- KenTIP HP geometry works with low cutting and feed forces and provides very good centring. Reinforced cutting edges and good chip forming improve tool life due to high wear and edge chipping resistance.
- KCP15 is a fine grain carbide with a TiAlN-based PVD nanolayer coating with greatly improved layer bonding for higher tool life. Its increased Al content provides better thermal and chemical stability, which makes it more suitable for higher cutting speeds.
- KenTIP KCP15 HP cutting edges are perfectly suited to drill alloyed and high alloy steels.
- Use KenTIP KCP15 HP cutting edges as an alternative in cast iron materials.

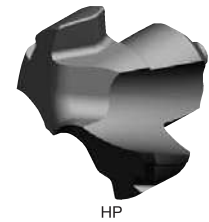
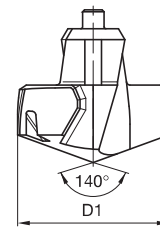
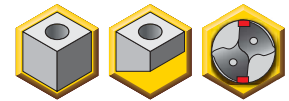

■ KenTIP Inserts • HP KCP15



- first choice
- alternate choice

KCP15	D1		seat size
	mm	in	
KTIP0794HPM	7,938	.3125	F
KTIP0800HPM	8,000	.3150	F
KTIP0810HPM	8,100	.3189	F
KTIP0816HPM	8,164	.3214	F
KTIP0820HPM	8,204	.3230	F
KTIP0830HPM	8,300	.3268	F
KTIP0833HPM	8,334	.3281	F
KTIP0840HPM	8,400	.3307	F
KTIP0843HPM	8,433	.3320	F
KTIP0850HPM	8,500	.3346	G
KTIP0860HPM	8,600	.3386	G
KTIP0861HPM	8,611	.3390	G
KTIP0870HPM	8,700	.3425	G
KTIP0873HPM	8,733	.3438	G
KTIP0880HPM	8,800	.3465	G
KTIP0884HPM	8,839	.3480	G
KTIP0890HPM	8,900	.3504	G
KTIP0900HPM	9,000	.3543	H
KTIP0909HPM	9,093	.3580	H
KTIP0910HPM	9,100	.3583	H
KTIP0913HPM	9,129	.3594	H
KTIP0920HPM	9,200	.3622	H
KTIP0930HPM	9,300	.3661	H
KTIP0935HPM	9,347	.3680	H
KTIP0940HPM	9,400	.3701	H
KTIP0950HPM	9,500	.3740	I
KTIP0953HPM	9,525	.3750	I
KTIP0956HPM	9,558	.3763	I
KTIP0958HPM	9,576	.3770	I
KTIP0960HPM	9,600	.3780	I
KTIP0970HPM	9,703	.3820	I
KTIP0980HPM	9,804	.3860	I

KCP15	D1		seat size
	mm	in	
KTIP0983HPM	9,830	.3870	I
KTIP0990HPM	9,900	.3898	I
KTIP0992HPM	9,921	.3906	I
KTIP1000HPM	10,000	.3937	J
KTIP1002HPM	10,023	.3946	J
KTIP1008HPM	10,084	.3970	J
KTIP1010HPM	10,100	.3976	J
KTIP1020HPM	10,200	.4016	J
KTIP1026HPM	10,262	.4040	J
KTIP1030HPM	10,300	.4055	J
KTIP1032HPM	10,320	.4063	J
KTIP1040HPM	10,400	.4094	J
KTIP1049HPM	10,490	.4130	J
KTIP1050HPM	10,500	.4134	K
KTIP1060HPM	10,600	.4173	K
KTIP1070HPM	10,700	.4213	K
KTIP1072HPM	10,716	.4219	K
KTIP1080HPM	10,800	.4252	K
KTIP1090HPM	10,900	.4291	K
KTIP1100HPM	11,000	.4331	L
KTIP1110HPM	11,100	.4370	L
KTIP1111HPM	11,113	.4375	L
KTIP1120HPM	11,200	.4409	L
KTIP1130HPM	11,300	.4449	L
KTIP1140HPM	11,400	.4488	L
KTIP1150HPM	11,500	.4528	M
KTIP1151HPM	11,509	.4531	M
KTIP1160HPM	11,600	.4567	M
KTIP1161HPM	11,610	.4571	M
KTIP1170HPM	11,700	.4606	M
KTIP1180HPM	11,800	.4646	M
KTIP1190HPM	11,900	.4685	M

(continued)

(KenTIP Inserts • HP KCP15™ — continued)

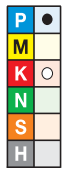

● first choice
○ alternate choice

KCP15	D1		seat size	KCP15	D1		seat size
	mm	in			mm	in	
KTIP1191HPM	11,908	.4688	M	KTIP1588HPM	15,875	.6250	T
KTIP1200HPM	12,000	.4724	N	KTIP1600HPM	16,000	.6299	U
KTIP1210HPM	12,100	.4764	N	KTIP1603HPM	16,027	.6310	U
KTIP1220HPM	12,200	.4803	N	KTIP1608HPM	16,078	.6330	U
KTIP1230HPM	12,304	.4844	N	KTIP1610HPM	16,100	.6339	U
KTIP1240HPM	12,400	.4882	N	KTIP1620HPM	16,200	.6378	U
KTIP1247HPM	12,474	.4911	N	KTIP1627HPM	16,271	.6406	U
KTIP1250HPM	12,500	.4921	O	KTIP1630HPM	16,300	.6417	U
KTIP1260HPM	12,600	.4961	O	KTIP1640HPM	16,400	.6457	U
KTIP1270HPM	12,700	.5000	O	KTIP1650HPM	16,500	.6496	U
KTIP1280HPM	12,800	.5039	O	KTIP1660HPM	16,600	.6535	U
KTIP1290HPM	12,903	.5080	O	KTIP1667HPM	16,670	.6563	U
KTIP1300HPM	13,000	.5118	P	KTIP1670HPM	16,700	.6575	U
KTIP1310HPM	13,096	.5156	P	KTIP1680HPM	16,800	.6614	U
KTIP1320HPM	13,200	.5197	P	KTIP1690HPM	16,900	.6654	U
KTIP1328HPM	13,280	.5228	P	KTIP1700HPM	17,000	.6693	V
KTIP1330HPM	13,300	.5236	P	KTIP1707HPM	17,066	.6719	V
KTIP1338HPM	13,380	.5268	P	KTIP1710HPM	17,100	.6732	V
KTIP1340HPM	13,400	.5276	P	KTIP1720HPM	17,200	.6772	V
KTIP1349HPM	13,494	.5313	P	KTIP1730HPM	17,300	.6811	V
KTIP1350HPM	13,500	.5315	Q	KTIP1740HPM	17,400	.6850	V
KTIP1360HPM	13,600	.5354	Q	KTIP1748HPM	17,463	.6875	V
KTIP1370HPM	13,700	.5394	Q	KTIP1750HPM	17,500	.6890	V
KTIP1380HPM	13,800	.5433	Q	KTIP1760HPM	17,600	.6929	V
KTIP1389HPM	13,891	.5469	Q	KTIP1770HPM	17,700	.6969	V
KTIP1390HPM	13,896	.5471	Q	KTIP1780HPM	17,800	.7008	V
KTIP1394HPM	13,940	.5488	Q	KTIP1786HPM	17,859	.7031	V
KTIP1400HPM	14,000	.5512	R	KTIP1790HPM	17,900	.7047	V
KTIP1410HPM	14,100	.5551	R	KTIP1800HPM	18,000	.7087	W
KTIP1420HPM	14,200	.5591	R	KTIP1810HPM	18,100	.7126	W
KTIP1429HPM	14,288	.5625	R	KTIP1820HPM	18,200	.7165	W
KTIP1430HPM	14,300	.5630	R	KTIP1826HPM	18,258	.7188	W
KTIP1440HPM	14,400	.5669	R	KTIP1830HPM	18,300	.7205	W
KTIP1450HPM	14,500	.5709	S	KTIP1840HPM	18,400	.7244	W
KTIP1460HPM	14,600	.5748	S	KTIP1850HPM	18,500	.7283	W
KTIP1467HPM	14,666	.5774	S	KTIP1860HPM	18,600	.7323	W
KTIP1468HPM	14,684	.5781	S	KTIP1865HPM	18,654	.7344	W
KTIP1470HPM	14,700	.5787	S	KTIP1870HPM	18,700	.7362	W
KTIP1480HPM	14,800	.5827	S	KTIP1880HPM	18,800	.7402	W
KTIP1490HPM	14,900	.5866	S	KTIP1890HPM	18,900	.7441	W
KTIP1500HPM	15,000	.5906	T	KTIP1900HPM	19,000	.7480	X
KTIP1508HPM	15,083	.5938	T	KTIP1905HPM	19,050	.7500	X
KTIP1510HPM	15,100	.5945	T	KTIP1910HPM	19,100	.7520	X
KTIP1520HPM	15,200	.5984	T	KTIP1920HPM	19,200	.7559	X
KTIP1530HPM	15,300	.6024	T	KTIP1923HPM	19,228	.7570	X
KTIP1538HPM	15,380	.6055	T	KTIP1925HPM	19,253	.7580	X
KTIP1540HPM	15,400	.6063	T	KTIP1930HPM	19,300	.7598	X
KTIP1548HPM	15,479	.6094	T	KTIP1935HPM	19,350	.7620	X
KTIP1550HPM	15,500	.6102	T	KTIP1940HPM	19,400	.7638	X
KTIP1560HPM	15,600	.6142	T	KTIP1946HPM	19,446	.7656	X
KTIP1570HPM	15,700	.6181	T	KTIP1950HPM	19,500	.7677	X
KTIP1580HPM	15,800	.6220	T	KTIP1960HPM	19,600	.7717	X

(continued)



(KenTIP Inserts • HP KCP15™ — continued)



● first choice
○ alternate choice

Modular Drills

KCP15	D1		seat size
	mm	in	
KTIP1970HPM	19,700	.7756	X
KTIP1980HPM	19,800	.7795	X
KTIP1984HPM	19,844	.7813	X
KTIP1990HPM	19,900	.7835	X
KTIP2000HPM	20,000	.7874	Y
KTIP2010HPM	20,100	.7913	Y
KTIP2020HPM	20,200	.7953	Y
KTIP2024HPM	20,241	.7969	Y
KTIP2030HPM	20,300	.7992	Y
KTIP2050HPM	20,500	.8071	Y
KTIP2060HPM	20,600	.8110	Y
KTIP2064HPM	20,638	.8125	Y
KTIP2070HPM	20,700	.8150	Y
KTIP2080HPM	20,800	.8189	Y
KTIP2090HPM	20,900	.8228	Y
KTIP2099HPM	20,990	.8264	Y
KTIP2100HPM	21,000	.8268	Z
KTIP2110HPM	21,100	.8307	Z
KTIP2143HPM	21,432	.8438	Z
KTIP2150HPM	21,500	.8465	Z
KTIP2200HPM	22,000	.8661	ZA
KTIP2223HPM	22,225	.8750	ZA
KTIP2250HPM	22,500	.8858	ZA
KTIP2280HPM	22,800	.8976	ZA

KCP15	D1		seat size
	mm	in	
KTIP2300HPM	23,000	.9055	ZB
KTIP2350HPM	23,500	.9252	ZB
KTIP2381HPM	23,813	.9375	ZB
KTIP2400HPM	24,000	.9449	ZC
KTIP2450HPM	24,500	.9646	ZC
KTIP2461HPM	24,608	.9688	ZC
KTIP2500HPM	25,000	.9843	ZD
KTIP2540HPM	25,400	1.0000	ZD
KTIP2550HPM	25,500	1.0039	ZD
KTIP2567HPM	25,679	1.0110	ZD
KTIP2581HPM	25,806	1.0160	ZD
KTIP2599HPM	25,990	1.0232	ZD
KTIP2600HPM	26,000	1.0236	ZE
KTIP2619HPM	26,187	1.0310	ZE
KTIP2650HPM	26,500	1.0433	ZE
KTIP2659HPM	26,590	1.0469	ZE
KTIP2700HPM	27,000	1.0630	ZE
KTIP2750HPM	27,500	1.0827	ZE
KTIP2778HPM	27,780	1.0938	ZE
KTIP2799HPM	27,990	1.1020	ZE

KenTIP HP Geometry

Tolerance

D1 metric	tolerance k8
8-10	0,000/+0,022
>10-17	0,000/+0,027
>17-18	0,000/+0,027
>18-28	0,000/+0,033

Application Data

■ Modular Drill Carbide Insert Blades • KenTIP™ • HP Geometry • Grade KCP15™ • Through Coolant • Metric

Material Group	Cutting Speed — vc				Metric								
	Range — m/min				Recommended Feed Rate (f) by Diameter								
	min	Starting Value	max		8,0	10,0	12,0	14,0	16,0	20,0	24,0	28,0	
P	1	90	130	180	mm/r	0,12-0,21	0,14-0,26	0,15-0,33	0,18-0,41	0,20-0,47	0,26-0,50	0,27-0,51	0,30-0,54
	2	110	150	190	mm/r	0,12-0,25	0,14-0,30	0,15-0,35	0,18-0,38	0,20-0,47	0,26-0,50	0,27-0,51	0,30-0,54
	3	50	80	110	mm/r	0,12-0,29	0,13-0,37	0,17-0,39	0,22-0,48	0,24-0,48	0,32-0,54	0,32-0,54	0,35-0,56
	4	50	80	110	mm/r	0,12-0,29	0,13-0,37	0,17-0,39	0,18-0,48	0,19-0,48	0,24-0,48	0,35-0,46	0,27-0,46
K	1	60	100	180	mm/r	0,16-0,30	0,17-0,34	0,18-0,37	0,22-0,44	0,26-0,50	0,33-0,62	0,35-0,65	0,40-0,70
	2	60	80	90	mm/r	0,16-0,30	0,17-0,32	0,18-0,35	0,22-0,43	0,26-0,50	0,33-0,62	0,35-0,65	0,40-0,70
	3	40	70	90	mm/r	0,17-0,32	0,18-0,35	0,19-0,38	0,21-0,43	0,22-0,46	0,24-0,50	0,25-0,51	0,40-0,70

- KenTIP FEG flat-bottom inserts create 180° flat holes — only a small cavity remains in the centre of the hole ground. KenTIP offers easy-to-change disposable inserts and low cutting forces for your flat-bottom applications.
- Whether it is a blind hole, a through hole, or if you need to countersink, these inserts are focused on versatility and will support you in many essential drilling applications.
- KenTIP FEG inserts feature a small centring point as well as double margin lands for improved guidance and hole straightness. A corner chamfer serves to reduce bur formation and to improve tool life.
- KCPM45™ combines a very tough, fine-grain carbide substrate with an advanced multilayer TiAlN coating. It is capable of machining steel even in the most demanding conditions.
- Use KenTIP FEG KCPM45 cutting edges as an effective alternative in cast iron and stainless steel.

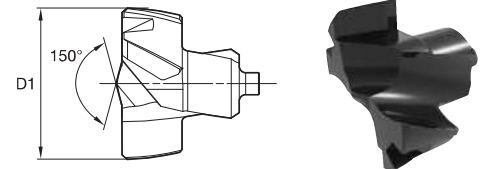
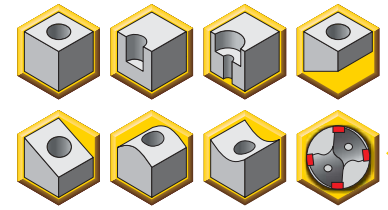

Modular Drills

KenTIP Inserts • FEG (Flat Bottom)



KCPM45	D1		seat size
	mm	in	
KTIP0794FEGM	7,938	.3125	F
KTIP0800FEGM	8,000	.3150	F
KTIP0850FEGM	8,500	.3346	G
KTIP0852FEGM	8,520	.3354	G
KTIP0900FEGM	9,000	.3543	H
KTIP0913FEGM	9,130	.3594	H
KTIP0950FEGM	9,500	.3740	I
KTIP1000FEGM	10,000	.3937	J
KTIP1010FEGM	10,100	.3976	J
KTIP1050FEGM	10,500	.4134	K
KTIP1080FEGM	10,800	.4252	K
KTIP1100FEGM	11,000	.4331	L
KTIP1150FEGM	11,500	.4528	M
KTIP1170FEGM	11,700	.4606	M
KTIP1200FEGM	12,000	.4724	N
KTIP1250FEGM	12,500	.4921	O
KTIP1270FEGM	12,700	.5000	O
KTIP1300FEGM	13,000	.5118	P
KTIP1350FEGM	13,500	.5315	Q
KTIP1400FEGM	14,000	.5512	R



- first choice
- alternate choice

KCPM45	D1		seat size
	mm	in	
KTIP1450FEGM	14,500	.5709	S
KTIP1490FEGM	14,900	.5866	S
KTIP1500FEGM	15,000	.5906	T
KTIP1550FEGM	15,500	.6102	T
KTIP1595FEGM	15,950	.6280	T
KTIP1600FEGM	16,000	.6299	U
KTIP1650FEGM	16,500	.6496	U
KTIP1700FEGM	17,000	.6693	V
KTIP1750FEGM	17,500	.6890	V
KTIP1770FEGM	17,700	.6969	V
KTIP1800FEGM	18,000	.7087	W
KTIP1850FEGM	18,500	.7283	W
KTIP1900FEGM	19,000	.7480	X
KTIP1905FEGM	19,050	.7500	X
KTIP1950FEGM	19,500	.7677	X
KTIP2000FEGM	20,000	.7874	Y

KenTIP FEG Geometry Tolerance

D1 metric	tolerance s7
8-10	+0,023/+0,038
>10-18	+0,028/+0,046
>18-28	+0,035/+0,056

■ Modular Drill Carbide Insert Blades • KenTIP™ • FEG Geometry • Grade KCPM45™ • Through Coolant • Metric

Modular Drills

Material Group	Cutting Speed – vc			Metric									
	Range – m/min			Recommended Feed Rate (f) by Diameter									
	min	Starting Value	max		8,0	10,0	12,0	14,0	16,0	20,0	24,0	28,0	
P	1	110	140	170	mm/r	0,14–0,23	0,14–0,23	0,14–0,23	0,14–0,23	0,17–0,25	0,19–0,29	0,23–0,38	0,23–0,38
	2	100	120	140	mm/r	0,17–0,23	0,17–0,23	0,17–0,23	0,17–0,23	0,19–0,25	0,22–0,29	0,29–0,38	0,29–0,38
	3	80	100	120	mm/r	0,14–0,20	0,14–0,20	0,14–0,20	0,14–0,20	0,15–0,23	0,17–0,25	0,23–0,34	0,23–0,34
	4	70	90	110	mm/r	0,11–0,20	0,11–0,20	0,11–0,20	0,11–0,20	0,13–0,23	0,14–0,25	0,18–0,34	0,18–0,34
M	1	40	60	80	mm/r	0,09–0,14	0,09–0,14	0,09–0,14	0,09–0,14	0,11–0,17	0,13–0,20	0,16–0,25	0,16–0,25
	2	35	55	70	mm/r	0,09–0,14	0,09–0,14	0,09–0,14	0,09–0,14	0,11–0,17	0,13–0,20	0,16–0,25	0,16–0,25
K	1	90	135	175	mm/r	0,18–0,24	0,18–0,24	0,18–0,24	0,18–0,24	0,21–0,28	0,23–0,31	0,28–0,37	0,28–0,37
	2	80	120	140	mm/r	0,18–0,24	0,18–0,24	0,18–0,24	0,18–0,24	0,21–0,28	0,23–0,31	0,28–0,37	0,28–0,37
	3	70	110	125	mm/r	0,15–0,24	0,15–0,24	0,15–0,24	0,15–0,24	0,18–0,26	0,21–0,29	0,23–0,37	0,23–0,37

- Tool body shipped with insert wrench.

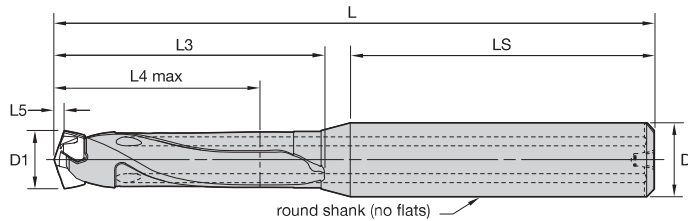

For information on L, L3, and L4 max, see the Modular Drills Dimension Tables on page H35.



Modular Drills

■ KenTIP Round Shank • 1.5 x D/3 x D/5 x D/8 x D/12 x D • Metric

					D1		D1 max			KenTIP wrench
1.5 x D	3 x D	5 x D	8 x D	12 x D	mm	in	mm	in		
KTIP080R1SS10M	KTIP080R3SS10M	KTIP080R5SS10M	KTIP080R8SS10M	KTIP080R12SS10M	8,000	.3150	8,499	.3346	F	170.306
KTIP085R1SS10M	KTIP085R3SS10M	KTIP085R5SS10M	KTIP085R8SS10M	KTIP085R12SS10M	8,500	.3346	8,999	.3543	G	170.306
KTIP090R1SS10M	KTIP090R3SS10M	KTIP090R5SS10M	KTIP090R8SS10M	KTIP090R12SS10M	9,000	.3543	9,499	.3740	H	170.306
KTIP095R1SS10M	KTIP095R3SS10M	KTIP095R5SS10M	KTIP095R8SS10M	KTIP095R12SS10M	9,500	.3740	9,999	.3937	I	170.306
KTIP100R1SS12M	KTIP100R3SS12M	KTIP100R5SS12M	KTIP100R8SS12M	KTIP100R12SS12M	10,000	.3937	10,499	.4133	J	170.307
KTIP105R1SS12M	KTIP105R3SS12M	KTIP105R5SS12M	KTIP105R8SS12M	KTIP105R12SS12M	10,500	.4134	10,999	.4330	K	170.307
KTIP110R1SS12M	KTIP110R3SS12M	KTIP110R5SS12M	KTIP110R8SS12M	KTIP110R12SS12M	11,000	.4331	11,499	.4527	L	170.307
KTIP115R1SS12M	KTIP115R3SS12M	KTIP115R5SS12M	KTIP115R8SS12M	KTIP115R12SS12M	11,500	.4528	11,999	.4724	M	170.307
KTIP120R1SS14M	KTIP120R3SS14M	KTIP120R5SS14M	KTIP120R8SS14M	KTIP120R12SS14M	12,000	.4724	12,499	.4921	N	170.308
KTIP125R1SS14M	KTIP125R3SS14M	KTIP125R5SS14M	KTIP125R8SS14M	KTIP125R12SS14M	12,500	.4921	12,999	.5118	O	170.308
KTIP130R1SS14M	KTIP130R3SS14M	KTIP130R5SS14M	KTIP130R8SS14M	KTIP130R12SS14M	13,000	.5118	13,499	.5315	P	170.308
KTIP135R1SS14M	KTIP135R3SS14M	KTIP135R5SS14M	KTIP135R8SS14M	KTIP135R12SS14M	13,500	.5315	13,999	.5511	Q	170.308
KTIP140R1SS16M	KTIP140R3SS16M	KTIP140R5SS16M	KTIP140R8SS16M	KTIP140R12SS16M	14,000	.5512	14,499	.5708	R	170.309
KTIP145R1SS16M	KTIP145R3SS16M	KTIP145R5SS16M	KTIP145R8SS16M	KTIP145R12SS16M	14,500	.5709	14,999	.5905	S	170.309
KTIP150R1SS16M	KTIP150R3SS16M	KTIP150R5SS16M	KTIP150R8SS16M	KTIP150R12SS16M	15,000	.5906	15,999	.6299	T	170.309
KTIP160R1SS18M	KTIP160R3SS18M	KTIP160R5SS18M	KTIP160R8SS18M	KTIP160R12SS18M	16,000	.6299	16,999	.6693	U	170.309
KTIP170R1SS18M	KTIP170R3SS18M	KTIP170R5SS18M	KTIP170R8SS18M	KTIP170R12SS18M	17,000	.6693	17,999	.7086	V	170.314
KTIP180R1SS20M	KTIP180R3SS20M	KTIP180R5SS20M	KTIP180R8SS20M	KTIP180R12SS20M	18,000	.7087	18,999	.7480	W	170.314
KTIP190R1SS20M	KTIP190R3SS20M	KTIP190R5SS20M	KTIP190R8SS20M	KTIP190R12SS20M	19,000	.7480	19,999	.7874	X	170.314
KTIP200R1SS25M	KTIP200R3SS25M	KTIP200R5SS25M	KTIP200R8SS25M	KTIP200R12SS25M	20,000	.7874	20,999	.8267	Y	170.314
KTIP210R1SS25M	KTIP210R3SS25M	KTIP210R5SS25M	KTIP210R8SS25M	KTIP210R12SS25M	21,000	.8268	21,999	.8661	Z	170.314
KTIP220R1SS25M	KTIP220R3SS25M	KTIP220R5SS25M	KTIP220R8SS25M	KTIP220R12SS25M	22,000	.8661	22,999	.9055	ZA	170.314
KTIP230R1SS25M	KTIP230R3SS25M	KTIP230R5SS25M	KTIP230R8SS25M	KTIP230R12SS25M	23,000	.9055	23,999	.9448	ZB	170.314
KTIP240R1SS25M	KTIP240R3SS25M	KTIP240R5SS25M	KTIP240R8SS25M	KTIP240R12SS25M	24,000	.9449	24,999	.9842	ZC	170.314
KTIP250R1SS32M	KTIP250R3SS32M	KTIP250R5SS32M	KTIP250R8SS32M	KTIP250R12SS32M	25,000	.9843	25,999	1.0236	ZD	170.314
KTIP260R1SS32M	KTIP260R3SS32M	KTIP260R5SS32M	KTIP260R8SS32M	KTIP260R12SS32M	26,000	1.0236	26,999	1.0630	ZE	170.314
KTIP270R1SS32M	KTIP270R3SS32M	KTIP270R5SS32M	KTIP270R8SS32M	KTIP270R12SS32M	27,000	1.0630	27,999	1.1023	ZE	170.314

- Tool body shipped with insert wrench.

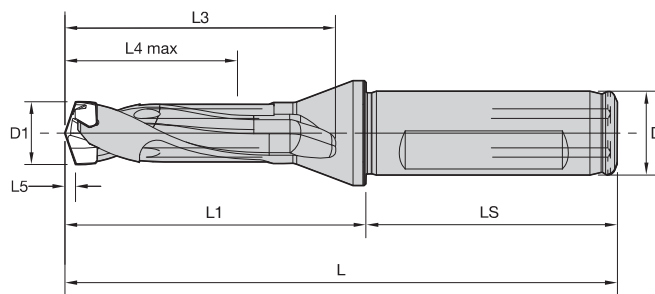

round shank (no flats)
For information on L, L3, and L4 max, see the Modular Drills Dimension Tables on page H36.

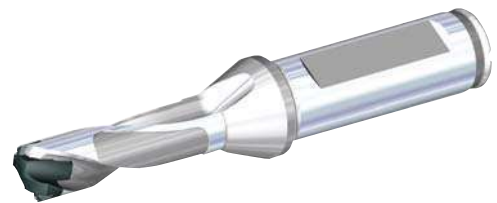

Modular Drills

■ KenTIP Flanged Shank • 1.5 x D/3 x D/5 x D/8 x D • Metric

1.5 x D	3 x D	5 x D	8 x D	D1		D1 max		seat size	KenTIP wrench
				mm	in	mm	in		
KTIP080R1SCF12M	KTIP080R3SCF12M	KTIP080R5SCF12M	KTIP080R8SCF12M	8,000	.3150	8,499	.3346	F	170.306
KTIP085R1SCF12M	KTIP085R3SCF12M	KTIP085R5SCF12M	KTIP085R8SCF12M	8,500	.3346	8,999	.3543	G	170.306
KTIP090R1SCF12M	KTIP090R3SCF12M	KTIP090R5SCF12M	KTIP090R8SCF12M	9,000	.3543	9,499	.3740	H	170.306
KTIP095R1SCF12M	KTIP095R3SCF12M	KTIP095R5SCF12M	KTIP095R8SCF12M	9,500	.3740	9,999	.3937	I	170.306
KTIP100R1SCF16M	KTIP100R3SCF16M	KTIP100R5SCF16M	KTIP100R8SCF16M	10,000	.3937	10,499	.4133	J	170.307
KTIP105R1SCF16M	KTIP105R3SCF16M	KTIP105R5SCF16M	KTIP105R8SCF16M	10,500	.4134	10,999	.4330	K	170.307
KTIP110R1SCF16M	KTIP110R3SCF16M	KTIP110R5SCF16M	KTIP110R8SCF16M	11,000	.4331	11,499	.4527	L	170.307
KTIP115R1SCF16M	KTIP115R3SCF16M	KTIP115R5SCF16M	KTIP115R8SCF16M	11,500	.4528	11,999	.4724	M	170.307
KTIP120R1SCF16M	KTIP120R3SCF16M	KTIP120R5SCF16M	KTIP120R8SCF16M	12,000	.4724	12,499	.4921	N	170.308
KTIP125R1SCF16M	KTIP125R3SCF16M	KTIP125R5SCF16M	KTIP125R8SCF16M	12,500	.4921	12,999	.5118	O	170.308
KTIP130R1SCF16M	KTIP130R3SCF16M	KTIP130R5SCF16M	KTIP130R8SCF16M	13,000	.5118	13,499	.5315	P	170.308
KTIP135R1SCF16M	KTIP135R3SCF16M	KTIP135R5SCF16M	KTIP135R8SCF16M	13,500	.5315	13,999	.5511	Q	170.308
KTIP140R1SCF16M	KTIP140R3SCF16M	KTIP140R5SCF16M	KTIP140R8SCF16M	14,000	.5512	14,499	.5708	R	170.309
KTIP145R1SCF16M	KTIP145R3SCF16M	KTIP145R5SCF16M	KTIP145R8SCF16M	14,500	.5709	14,999	.5905	S	170.309
KTIP150R1SCF20M	KTIP150R3SCF20M	KTIP150R5SCF20M	KTIP150R8SCF20M	15,000	.5906	15,999	.6299	T	170.309
KTIP160R1SCF20M	KTIP160R3SCF20M	KTIP160R5SCF20M	KTIP160R8SCF20M	16,000	.6299	16,999	.6693	U	170.309
KTIP170R1SCF20M	KTIP170R3SCF20M	KTIP170R5SCF20M	KTIP170R8SCF20M	17,000	.6693	17,999	.7086	V	170.314
KTIP180R1SCF25M	KTIP180R3SCF25M	KTIP180R5SCF25M	KTIP180R8SCF25M	18,000	.7087	18,999	.7480	W	170.314
KTIP190R1SCF25M	KTIP190R3SCF25M	KTIP190R5SCF25M	KTIP190R8SCF25M	19,000	.7480	19,999	.7874	X	170.314
KTIP200R1SCF25M	KTIP200R3SCF25M	KTIP200R5SCF25M	KTIP200R8SCF25M	20,000	.7874	20,999	.8267	Y	170.314
KTIP210R1SCF25M	KTIP210R3SCF25M	KTIP210R5SCF25M	KTIP210R8SCF25M	21,000	.8268	21,999	.8661	Z	170.314
KTIP220R1SCF25M	KTIP220R3SCF25M	KTIP220R5SCF25M	KTIP220R8SCF25M	22,000	.8661	22,999	.9055	ZA	170.314
KTIP230R1SCF25M	KTIP230R3SCF25M	KTIP230R5SCF25M	KTIP230R8SCF25M	23,000	.9055	23,999	.9448	ZB	170.314
KTIP240R1SCF25M	KTIP240R3SCF25M	KTIP240R5SCF25M	KTIP240R8SCF25M	24,000	.9449	24,999	.9842	ZC	170.314
KTIP250R1SCF25M	KTIP250R3SCF25M	KTIP250R5SCF25M	KTIP250R8SCF25M	25,000	.9843	25,999	1.0236	ZD	170.314
KTIP260R1SCF25M	KTIP260R3SCF25M	KTIP260R5SCF25M	KTIP260R8SCF25M	26,000	1.0236	26,999	1.0630	ZE	170.314
KTIP270R1SCF25M	KTIP270R3SCF25M	KTIP270R5SCF25M	KTIP270R8SCF25M	27,000	1.0630	27,999	1.1023	ZE	170.314

- Drilling and chamfering in one operation using the KenTIP drilling system.
- Low setup time — no height adjustment required.
- Use standard chamfering inserts with our universal -GD geometry style.
- Selection of two grade choices:
 - KC7215 offering the highest level of wear resistance for higher cutting speeds in stable conditions.
 - KC7015 for medium cutting speeds and normal conditions.
- Tool bodies with chamfer pockets available as custom solutions.



Modular Drills

P	●	○	●
M	●	○	○
K	●	○	●
N	●	○	○
S	○	○	●
H	○	○	○

● first choice
○ alternate choice

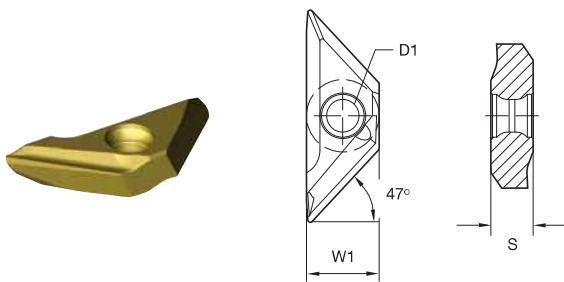

■ FAS-GD • Chamfering Insert

catalogue number	W1		D1		S		KC7215	KC7015
	mm	in	mm	in	mm	in		
FAS100302GD	6,35	.250	2,85	.112	3,48	.137	●	●



Made-to-order KenTIP holders with chamfering step using standard FAS inserts. Also available for KenTIP FS upon request.

- Very small incremental diameter changes for step drills.
- Best reliability and hole quality.
- Improved chip control and very low tendency for chattering.
- High tool life per edge; 2x indexable.
- Can be used with KenTIP and KSEM™ as well as Drill Fix™ indexable made-to-order step drills.
- CFM inserts are perfectly suited for usage on made-to-order indexable countersinking tools.

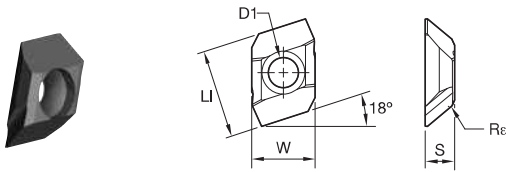

- first choice
- alternate choice

P	●
M	○
K	○
N	●
S	●
H	

■ CounterFix Micro • Tangential Chamfer and Counterboring Inserts

catalogue number	D1	LI	W	S	Rε	KCU40
CFM0402R00RHP	2,05	6,000	4,25	1,98	0,20	●
CFM0402R30RHP	2,05	6,000	4,25	1,98	0,20	●
CFM0402R45RHP	2,05	6,000	4,25	1,98	0,20	●

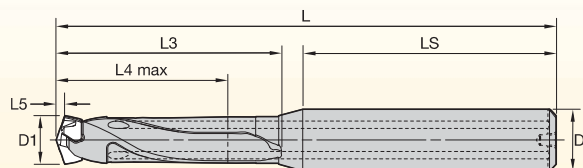

Made-to-order KenTIP holder with two very small counterboring steps using CounterFix Micro Inserts. Also available for KenTIP FS upon request.

Modular Drills • Dimension Tables
■ Dimensions for KenTIP™ Modular Drills • Round Shank • Metric

D1 mm	D1 max seat		L5	LS	round D	1.5 x D L	L3	L4 max	3 x D L	L3	L4 max	5 x D L	L3	L4 max	8 x D L	L3	L4 max	12 x D L	L3	L4 max	wrench
8,000	8,499	F	1,4	41	10	67	23	13	79	35	26	97	53	43	123	79	68	157	113	102	170.306
8,500	8,999	G	1,5	41	10	68	24	14	81	37	27	100	56	45	127	83	72	163	119	108	170.306
9,000	9,499	H	1,6	41	10	69	25	14	83	39	29	103	58	48	132	88	76	170	126	114	170.306
9,500	9,999	I	1,6	41	10	70	26	15	85	41	30	107	63	50	137	92	80	177	133	120	170.306
10,000	10,499	J	1,7	46	12	77	28	16	92	43	32	115	66	53	147	98	84	189	140	126	170.307
10,500	10,999	K	1,8	46	12	78	29	17	94	45	33	118	68	55	151	101	88	195	146	132	170.307
11,000	11,499	L	1,9	46	12	79	30	17	96	47	35	121	71	58	156	105	92	202	153	138	170.307
11,500	11,999	M	2,0	46	12	80	31	18	98	49	36	124	75	60	160	110	96	208	159	144	170.307
12,000	12,499	N	2,1	46	14	83	34	19	101	52	38	127	78	63	165	116	100	215	166	150	170.308
12,500	12,999	O	2,2	46	14	84	35	20	103	54	39	130	81	65	169	120	104	221	172	156	170.308
13,000	13,499	P	2,2	46	14	85	36	20	105	56	41	133	84	68	174	125	108	228	179	162	170.308
13,500	13,999	Q	2,3	46	14	86	37	21	107	58	42	137	88	70	179	130	112	235	186	168	170.308
14,000	14,499	R	2,4	49	16	91	39	22	112	60	44	143	91	73	187	135	116	245	193	174	170.309
14,500	14,999	S	2,5	49	16	92	40	23	114	62	45	146	94	75	191	139	120	251	199	180	170.309
15,000	15,999	T	2,6	49	16	94	42	24	118	66	48	152	100	80	200	148	128	264	212	192	170.309
16,000	16,999	U	2,8	49	18	97	45	26	122	70	51	158	106	85	209	157	136	277	225	204	170.309
17,000	17,999	V	2,9	49	18	100	48	27	127	75	54	165	113	90	219	167	144	291	239	216	170.314
18,000	18,999	W	3,1	51	20	105	51	29	133	79	57	173	119	95	230	176	152	306	252	228	170.314
19,000	19,999	X	3,3	51	20	107	53	30	137	83	60	179	125	100	239	185	160	319	265	240	170.314
20,000	20,999	Y	3,5	57	25	116	56	32	147	87	63	191	131	105	254	200	168	344	284	252	170.314
21,000	21,999	Z	3,6	57	25	118	58	33	151	91	66	198	138	110	264	204	176	352	292	264	170.314
22,000	22,999	ZA	3,8	57	25	122	62	35	156	96	69	204	144	115	273	213	184	365	305	276	170.314
23,000	23,999	ZB	4,0	57	25	124	64	36	160	100	72	210	150	120	282	222	192	378	318	288	170.314
24,000	24,999	ZC	4,1	57	25	127	67	38	164	104	75	216	156	125	291	231	200	391	331	300	170.314
25,000	25,999	ZD	4,3	61	32	133	69	39	172	108	78	227	163	130	305	241	208	409	345	312	170.314
26,000	26,999	ZE	4,5	61	32	138	74	41	178	114	81	232	168	135	315	251	216	423	359	324	170.314
27,000	27,999	ZE	4,7	61	32	139	75	42	181	117	84	239	175	140	323	259	224	435	371	336	170.314

(continued)

Modular Drills • Dimension Tables *(continued)*

■ Dimensions for KenTIP™ Modular Drills • Flanged Shank • Metric

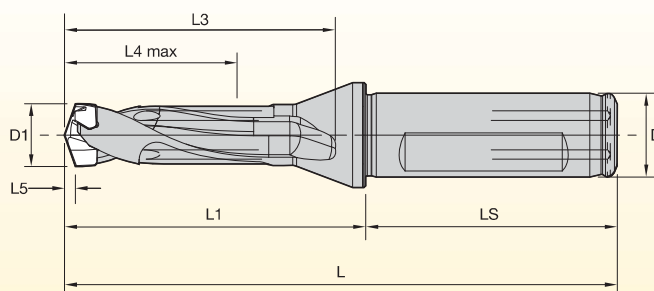

D1 mm	D1 max	seat	L5	LS	Flanged D	1.5 x D L	L3	L4 max	3 x D L	L3	L4 max	5 x D L	L3	L4 max	8 x D L	L3	L4 max	wrench
8,000	8,490	F	1,4	45	12	73	23	13	86	35	26	104	53	43	129	79	68	170.306
8,500	8,990	G	1,5	45	12	74	24	14	88	37	27	107	56	45	134	83	72	170.306
9,000	9,490	H	1,6	45	12	76	25	14	90	39	29	110	59	48	138	88	76	170.306
9,500	9,990	I	1,6	45	12	77	26	15	92	41	30	114	63	50	144	93	80	170.306
10,000	10,490	J	1,7	48	16	81	28	16	97	43	32	120	66	53	151	97	84	170.307
10,500	10,990	K	1,8	48	16	82	29	17	99	45	33	123	69	55	156	102	88	170.307
11,000	11,490	L	1,9	48	16	84	30	17	101	47	35	126	72	58	160	107	92	170.307
11,500	11,990	M	2,0	48	16	85	31	18	103	49	36	129	75	60	165	111	96	170.307
12,000	12,490	N	2,1	48	16	87	34	19	106	52	38	132	78	63	169	116	100	170.308
12,500	12,990	O	2,2	48	16	88	35	20	108	54	39	135	81	65	174	120	104	170.308
13,000	13,490	P	2,2	48	16	90	36	20	110	56	41	138	84	68	178	124	108	170.308
13,500	13,990	Q	2,3	48	16	91	37	21	112	58	42	142	88	70	184	130	112	170.308
14,000	14,490	R	2,4	48	16	92	39	22	114	60	44	145	91	73	188	134	116	170.309
14,500	14,990	S	2,5	48	16	93	40	23	116	62	45	148	94	75	193	139	120	170.309
15,000	15,990	T	2,6	50	20	98	42	24	122	66	48	156	100	80	204	148	128	170.309
16,000	16,990	U	2,8	50	20	100	45	26	126	70	51	162	106	85	213	157	136	170.309
17,000	17,990	V	2,9	50	20	104	48	27	131	75	54	169	113	90	223	167	144	170.314
18,000	18,990	W	3,1	56	25	112	51	29	141	79	57	181	119	95	238	176	152	170.314
19,000	19,990	X	3,3	56	25	115	53	30	144	83	60	187	125	100	247	185	160	170.314
20,000	20,990	Y	3,5	56	25	117	56	32	149	87	63	193	131	105	256	194	168	170.314
21,000	21,990	Z	3,6	56	25	120	58	33	153	91	66	200	138	110	266	204	176	170.314
22,000	22,990	ZA	3,8	56	25	123	62	35	158	96	69	206	144	115	275	213	184	170.314
23,000	23,990	ZB	4,0	56	25	126	64	36	162	100	72	212	150	120	284	222	192	170.314
24,000	24,990	ZC	4,1	56	25	128	67	38	166	104	75	218	156	125	293	231	200	170.314
25,000	25,990	ZD	4,3	56	25	131	69	39	170	108	78	225	163	130	303	241	208	170.314
26,000	26,990	ZE	4,5	56	25	135	74	41	176	114	81	230	168	135	313	251	216	170.314
27,000	27,990	ZE	4,7	56	25	137	75	42	179	117	84	237	175	140	321	259	224	170.314

Mounting the KenTIP Inserts



1) Fix drill holder on arbour. For insert exchange, fix arbour on the machine or set on tool presetter.



2) Remove dust using air blast.



3) Put insert into drill holder (use gloves to protect your hands).



4) Turn lightly in a clockwise direction (use gloves to protect your hands).



5) Set the wrench properly.



6) Make sure the wrench fits with the insert slot (check size and alignment of wrench and insert slots to avoid injury).



7) Slowly turn the wrench in a clockwise direction.



8) Complete.

Cooling the KenTIP Drill

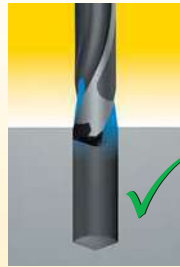

1) Internal coolant is recommended.

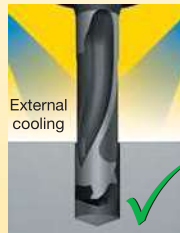

2) In case of external coolant, cutting depth must be 3 x D or less.

Only when using the 3 x D tool bodies



3) Dry cutting is not recommended. Limited applicability in cast iron materials, MQL strongly recommended.

Dry machining

Usage Precautions Core Deviation

1) For Turning Machines

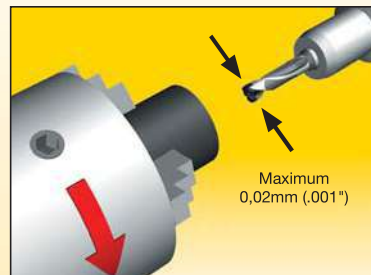

Set deviation amount under 0,02mm between workpiece and drill.

2) For Machining Centres

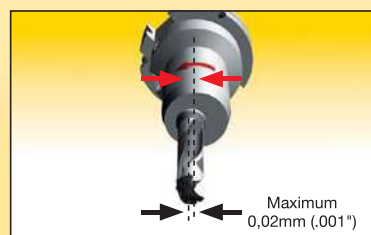

Do not use any arbour with a damaged attachment surface. Centre of arbour deviation must be within 0,02mm.

KSEM™ Modular Drill System

Primary Application

The KSEM™ modular drill system offers extended length and drilling diameters beyond the KenTIP™ modular drill system. The KSEM system enables very aggressive feed rates in many applications to enable very high productivity levels. It offers a very robust pocket for its exchangeable inserts to increase tool life for both steel holder and carbide tip. This makes the KSEM system a very economic and reliable system for drilling in the intermediate diameter range.

Hole depths of 10 x D and drilling diameters from 12,5–40mm (.4921–1.5748") are covered by our standard tooling range. Various grades are available for drilling applications in almost any materials.

Features and Benefits

HP Drill-Point styles

- Low thrust prevents workpiece flexing.
- Excellent centring capabilities.
- Application specific selection of geometries for unmatched performance.

Strong Pocket, Easy Insert Change

- Robust pocket design for increased insert and holder life.
- Four-wall pocket provides insert stability.
- Requires only a simple wrench for insert removal.

Regrindable Inserts

- All geometries except SPL can be reconditioned to improve tool economy.
- Quick and reliable regrinding services offered by Kennametal and our partners.

Tailored Grades

- KC7315™ grade TiAlN-based PVD multilayer coating for high cutting speeds, primarily in steel applications.
- KCPM45™ grade multilayer TiAlN coated, very tough carbide substrate. Improved chipping resistance in demanding machining conditions.
- KC7320™ grade AlTiN-based PVD coating for the demands of drilling stainless steels.
- KCMS35™ grade with high Al content TiAlN PVD coating specifically for M3 and S-type materials.
- KC7410™ grade contains multiple layers of PVD coating offering outstanding wear resistance for drilling cast irons.
- KC7135™ grade with thin TiCN-TiN PVD coating for universal usage in all materials.

NEW!



KSEM™ SPL inserts offer extraordinary drilling performance in stainless steels, super alloys, and other demanding environments.

NEW!



KSEM FEG inserts create blind holes, through holes, and countersinks. These inserts are focused on versatility and will support you in many essential drilling applications.



Drill Body Portfolio

- Standard 1, 3, 5, 7, and 10 x D tool bodies with round shanks (inch) and Whistle Notch shanks (metric) available.
- Flanged shanks with 2 flats and entry for external coolant supply in 1, 3, 5, and 8 x D.
- KSEM mountable chamfering ring with FAS carbide chamfer inserts.

Customisation

- Intermediate diameters available as semi-standards.
- Extensive step drill capabilities to support advanced applications and for one-shot counterboring and chamfering drills.
- Nearly all shank styles for toolholders available as semi-standards.
- Very high L x D ratios possible up to 25 x D and even higher (depending on drill diameter).

Need to create very small diameter steps for chamfering and counterboring?

CFM inserts fit KSEM made-to-order step drills perfectly. Find them in the KentIP™ modular drill system section page H34

NEW!



- KSEM KC7315™ HP cutting edges enable high metal removal rates and superior tool life for steel applications.
- HP geometry offers a wide and strong HP-style chiseled edge that prevents material quenching in the centre, enabling high feed rates. Sickle shaped, honed cutting edges provide excellent chip forming and tool life, even in long chipping materials.
- KC7315 is a fine-grain carbide with a TiAlN-based PVD multilayer coating. Its high wear resistance enables very high cutting speeds in stable conditions.
- KC7315 HP cutting edges are perfectly suited to drill alloyed and high-alloy steels.
- Use KC7315 HP cutting edges as an alternative to cast iron materials.

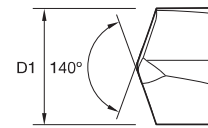
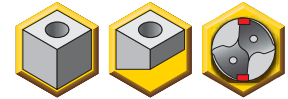

HP

Modular Drills

■ KSEM Inserts • HP KC7315



KC7315	D1		seat size
	mm	in	
KSEM1250HPM	12,500	.4921	C
KSEM1270HPM	12,700	.5000	C
KSEM1280HPM	12,800	.5039	C
KSEM1300HPM	13,000	.5118	C
KSEM1310HPM	13,100	.5160	C
KSEM1320HPM	13,200	.5197	C
KSEM1350HPM	13,500	.5310	C
KSEM1370HPM	13,700	.5394	B
KSEM1380HPM	13,800	.5433	B
KSEM1389HPM	13,890	.5470	B
KSEM1400HPM	14,000	.5512	B
KSEM1410HPM	14,100	.5551	B
KSEM1420HPM	14,200	.5591	B
KSEM1429HPM	14,290	.5630	B
KSEM1440HPM	14,400	.5669	B
KSEM1450HPM	14,500	.5709	B
KSEM1468HPM	14,680	.5780	A
KSEM1480HPM	14,800	.5827	A
KSEM1500HPM	15,000	.5906	A
KSEM1508HPM	15,080	.5940	A
KSEM1530HPM	15,300	.6024	A
KSEM1550HPM	15,500	.6102	A
KSEM1560HPM	15,600	.6142	A
KSEM1570HPM	15,700	.6181	A
KSEM1580HPM	15,800	.6220	A
KSEM1588HPM	15,880	.6250	1
KSEM1600HPM	16,000	.6299	1
KSEM1609HPM	16,090	.6340	1
KSEM1620HPM	16,200	.6378	1
KSEM1627HPM	16,270	.6410	1
KSEM1650HPM	16,500	.6496	1
KSEM1667HPM	16,670	.6560	1
KSEM1700HPM	17,000	.6693	1
KSEM1707HPM	17,070	.6720	1
KSEM1746HPM	17,460	.6875	1
KSEM1750HPM	17,500	.6890	1



- first choice
- alternate choice

KC7315	D1		seat size
	mm	in	
KSEM1786HPM	17,860	.7030	1
KSEM1800HPM	18,000	.7087	1
KSEM1826HPM	18,260	.7190	2
KSEM1850HPM	18,500	.7283	2
KSEM1865HPM	18,650	.7340	2
KSEM1900HPM	19,000	.7480	2
KSEM1905HPM	19,050	.7500	2
KSEM1923HPM	19,228	.7570	2
KSEM1927HPM	19,270	.7590	2
KSEM1945HPM	19,450	.7660	2
KSEM1950HPM	19,500	.7677	2
KSEM1984HPM	19,840	.7810	2
KSEM2000HPM	20,000	.7874	3
KSEM2024HPM	20,240	.7970	3
KSEM2050HPM	20,500	.8071	3
KSEM2064HPM	20,640	.8125	3
KSEM2100HPM	21,000	.8268	3
KSEM2143HPM	21,430	.8440	3
KSEM2150HPM	21,500	.8460	3
KSEM2183HPM	21,830	.8590	3
KSEM2200HPM	22,000	.8661	3
KSEM2223HPM	22,230	.8750	4
KSEM2244HPM	22,440	.8840	4
KSEM2250HPM	22,500	.8858	4
KSEM2300HPM	23,000	.9055	4
KSEM2342HPM	23,420	.9220	4
KSEM2350HPM	23,500	.9252	4
KSEM2381HPM	23,810	.9375	4
KSEM2400HPM	24,000	.9449	4
KSEM2450HPM	24,500	.9646	5
KSEM2461HPM	24,610	.9690	5
KSEM2500HPM	25,000	.9843	5
KSEM2540HPM	25,400	1.0000	5
KSEM2550HPM	25,500	1.0039	5
KSEM2560HPM	25,610	1.0080	5
KSEM2567HPM	25,670	1.0110	5

(continued)

(KSEM Inserts • HP KC7315™ — continued)

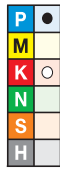

● first choice
○ alternate choice

KC7315	D1		seat size
	mm	in	
KSEM2600HPM	26,000	1.0236	5
KSEM2619HPM	26,190	1.0310	6
KSEM2650HPM	26,500	1.0433	6
KSEM2659HPM	26,590	1.0470	6
KSEM2700HPM	27,000	1.0630	6
KSEM2750HPM	27,500	1.0827	6
KSEM2778HPM	27,780	1.0940	6
KSEM2800HPM	28,000	1.1024	6
KSEM2818HPM	28,180	1.1090	7
KSEM2850HPM	28,500	1.1220	7
KSEM2858HPM	28,580	1.1250	7
KSEM2900HPM	29,000	1.1417	7
KSEM2937HPM	29,370	1.1563	7
KSEM2950HPM	29,500	1.1614	7
KSEM2977HPM	29,770	1.1720	7
KSEM3000HPM	30,000	1.1811	7
KSEM3016HPM	30,160	1.1875	8
KSEM3050HPM	30,500	1.2008	8
KSEM3096HPM	30,960	1.2190	8
KSEM3100HPM	31,000	1.2205	8

KC7315	D1		seat size
	mm	in	
KSEM3150HPM	31,500	1.2402	8
KSEM3175HPM	31,750	1.2500	8
KSEM3200HPM	32,000	1.2598	8
KSEM3250HPM	32,500	1.2795	9
KSEM3300HPM	33,000	1.2992	9
KSEM3334HPM	33,340	1.3130	9
KSEM3400HPM	34,000	1.3386	9
KSEM3413HPM	34,130	1.3440	9
KSEM3493HPM	34,930	1.3750	9
KSEM3500HPM	35,000	1.3780	9
KSEM3550HPM	35,500	1.3976	9
KSEM3600HPM	36,000	1.4173	9
KSEM3750HPM	37,500	1.4764	10
KSEM3800HPM	38,000	1.4961	10
KSEM3810HPM	38,100	1.5000	10
KSEM3850HPM	38,500	1.5157	10
KSEM3900HPM	39,000	1.5354	10
KSEM3950HPM	39,500	1.5551	10
KSEM4000HPM	40,000	1.5748	10

Tolerance HP • Metric

D1 metric	tolerance h8
12,5–18	+0,000/-0,027
>18–30	+0,000/-0,033
>30–40	+0,000/-0,039

Application Data

■ Modular Drill Carbide Insert Blades • KSEM • HP Geometry • Grade KC7315 • Through Coolant • Metric

Material Group	Cutting Speed – vc			Metric							
	Range – m/min			Recommended Feed Rate (f) by Diameter							
	min	Starting Value	max		12,5	16,0	20,0	25,4	32,0	40,0	
P	1	70	90	110	mm/r	0,15–0,31	0,17–0,36	0,19–0,41	0,25–0,53	0,29–0,60	0,33–0,69
	2	80	100	120	mm/r	0,15–0,31	0,17–0,36	0,19–0,41	0,25–0,53	0,29–0,60	0,33–0,69
	3	65	75	80	mm/r	0,15–0,28	0,17–0,31	0,19–0,36	0,25–0,46	0,23–0,53	0,33–0,60
	4	50	65	75	mm/r	0,12–0,28	0,14–0,31	0,16–0,36	0,20–0,46	0,23–0,53	0,30–0,60
	5	45	50	65	mm/r	0,09–0,15	0,11–0,18	0,12–0,21	0,15–0,25	0,17–0,29	0,20–0,33
	6	45	50	65	mm/r	0,12–0,23	0,14–0,26	0,16–0,29	0,20–0,38	0,23–0,43	0,26–0,54



- KSEM KC7315™ HPG cutting edges enable high metal removal rates and superior tool life for steel applications.
- HPG geometry works with low cutting and feed forces and provides very good centring. Reinforced cutting edges and good chip forming improve tool life due to high wear and edge chipping resistance.
- KC7315 is a fine-grain carbide with a TiAlN-based PVD multilayer coating. Its high wear resistance enables very high cutting speeds in stable conditions.
- KC7315 HPG cutting edges are perfectly suited to drill alloyed and high-alloy steels.
- Use KC7315 HPG cutting edges as an alternative to cast iron materials.

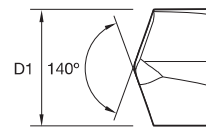
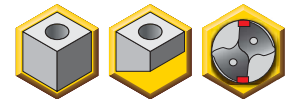

HPG

Modular Drills

■ KSEM Inserts • HPG KC7315



KC7315	D1		seat size
	mm	in	
KSEM1250HPGM	12,500	.4921	C
KSEM1260HPGM	12,600	.4961	C
KSEM1270HPGM	12,700	.5000	C
KSEM1280HPGM	12,800	.5039	C
KSEM1293HPGM	12,930	.5090	C
KSEM1300HPGM	13,000	.5118	C
KSEM1310HPGM	13,100	.5160	C
KSEM1320HPGM	13,200	.5197	C
KSEM1350HPGM	13,500	.5310	C
KSEM1360HPGM	13,600	.5354	B
KSEM1370HPGM	13,700	.5394	B
KSEM1380HPGM	13,800	.5433	B
KSEM1389HPGM	13,890	.5470	B
KSEM1400HPGM	14,000	.5512	B
KSEM1410HPGM	14,100	.5551	B
KSEM1420HPGM	14,200	.5591	B
KSEM1429HPGM	14,290	.5630	B
KSEM1440HPGM	14,400	.5669	B
KSEM1450HPGM	14,500	.5709	B
KSEM1460HPGM	14,600	.5748	A
KSEM1468HPGM	14,680	.5780	A
KSEM1480HPGM	14,800	.5827	A
KSEM1500HPGM	15,000	.5906	A
KSEM1508HPGM	15,080	.5940	A
KSEM1530HPGM	15,300	.6024	A
KSEM1548HPGM	15,480	.6090	A
KSEM1550HPGM	15,500	.6102	A
KSEM1560HPGM	15,600	.6142	A
KSEM1570HPGM	15,700	.6181	A
KSEM1580HPGM	15,800	.6220	A
KSEM1588HPGM	15,880	.6250	1
KSEM1600HPGM	16,000	.6299	1
KSEM1604HPGM	16,040	.6315	1
KSEM1609HPGM	16,090	.6340	1
KSEM1619HPGM	16,190	.6374	1
KSEM1620HPGM	16,200	.6378	1



- first choice
- alternate choice

KC7315	D1		seat size
	mm	in	
KSEM1627HPGM	16,270	.6410	1
KSEM1650HPGM	16,500	.6496	1
KSEM1660HPGM	16,600	.6535	1
KSEM1667HPGM	16,670	.6560	1
KSEM1700HPGM	17,000	.6693	1
KSEM1707HPGM	17,070	.6720	1
KSEM1735HPGM	17,350	.6831	1
KSEM1746HPGM	17,460	.6875	1
KSEM1750HPGM	17,500	.6890	1
KSEM1760HPGM	17,600	.6929	1
KSEM1770HPGM	17,700	.6969	1
KSEM1786HPGM	17,860	.7030	1
KSEM1800HPGM	18,000	.7087	1
KSEM1826HPGM	18,260	.7190	2
KSEM1850HPGM	18,500	.7283	2
KSEM1860HPGM	18,600	.7323	2
KSEM1865HPGM	18,650	.7340	2
KSEM1880HPGM	18,800	.7402	2
KSEM1900HPGM	19,000	.7480	2
KSEM1905HPGM	19,050	.7500	2
KSEM1925HPGM	19,250	.7579	2
KSEM1927HPGM	19,270	.7590	2
KSEM1932HPGM	19,320	.7606	2
KSEM1935HPGM	19,350	.7618	2
KSEM1945HPGM	19,450	.7660	2
KSEM1950HPGM	19,500	.7677	2
KSEM1970HPGM	19,700	.7756	2
KSEM1984HPGM	19,840	.7810	2
KSEM2000HPGM	20,000	.7874	3
KSEM2024HPGM	20,240	.7969	3
KSEM2050HPGM	20,500	.8071	3
KSEM2064HPGM	20,640	.8125	3
KSEM2070HPGM	20,700	.8150	3
KSEM2100HPGM	21,000	.8268	3
KSEM2110HPGM	21,100	.8307	3
KSEM2120HPGM	21,200	.8346	3

(continued)

(KSEM Inserts • HPG KC7315™ — continued)



● first choice
○ alternate choice

KC7315	D1		seat size
	mm	in	
KSEM2133HPGM	21,330	.8398	3
KSEM2143HPGM	21,430	.8440	3
KSEM2150HPGM	21,500	.8460	3
KSEM2170HPGM	21,700	.8543	3
KSEM2183HPGM	21,830	.8590	3
KSEM2200HPGM	22,000	.8661	3
KSEM2210HPGM	22,100	.8701	4
KSEM2215HPGM	22,150	.8720	4
KSEM2223HPGM	22,230	.8750	4
KSEM2244HPGM	22,440	.8840	4
KSEM2250HPGM	22,500	.8858	4
KSEM2262HPGM	22,620	.8906	4
KSEM2300HPGM	23,000	.9055	4
KSEM2305HPGM	23,050	.9075	4
KSEM2310HPGM	23,100	.9094	4
KSEM2325HPGM	23,250	.9154	4
KSEM2330HPGM	23,300	.9173	4
KSEM2342HPGM	23,420	.9220	4
KSEM2350HPGM	23,500	.9252	4
KSEM2381HPGM	23,810	.9375	4
KSEM2400HPGM	24,000	.9449	4
KSEM2430HPGM	24,300	.9567	5
KSEM2450HPGM	24,500	.9646	5
KSEM2461HPGM	24,610	.9690	5
KSEM2470HPGM	24,700	.9724	5
KSEM2500HPGM	25,000	.9843	5
KSEM2540HPGM	25,400	1.0000	5
KSEM2550HPGM	25,500	1.0039	5
KSEM2554HPGM	25,540	1.0055	5
KSEM2560HPGM	25,600	1.0080	5
KSEM2565HPGM	25,654	1.0100	5
KSEM2567HPGM	25,670	1.0110	5
KSEM2600HPGM	26,000	1.0236	5
KSEM2619HPGM	26,190	1.0310	6
KSEM2650HPGM	26,500	1.0433	6
KSEM2653HPGM	26,530	1.0445	6
KSEM2659HPGM	26,590	1.0470	6
KSEM2670HPGM	26,700	1.0512	6
KSEM2700HPGM	27,000	1.0630	6
KSEM2750HPGM	27,500	1.0827	6
KSEM2778HPGM	27,780	1.0940	6
KSEM2800HPGM	28,000	1.1024	6
KSEM2818HPGM	28,180	1.1090	7
KSEM2850HPGM	28,500	1.1220	7
KSEM2858HPGM	28,580	1.1250	7
KSEM2900HPGM	29,000	1.1417	7
KSEM2937HPGM	29,370	1.1563	7
KSEM2950HPGM	29,500	1.1614	7

KC7315	D1		seat size
	mm	in	
KSEM2955HPGM	29,550	1.1634	7
KSEM2973HPGM	29,730	1.1705	7
KSEM2977HPGM	29,770	1.1720	7
KSEM3000HPGM	30,000	1.1811	7
KSEM3016HPGM	30,160	1.1875	8
KSEM3050HPGM	30,500	1.2008	8
KSEM3056HPGM	30,560	1.2030	8
KSEM3096HPGM	30,960	1.2190	8
KSEM3100HPGM	31,000	1.2205	8
KSEM3125HPGM	31,250	1.2303	8
KSEM3150HPGM	31,500	1.2402	8
KSEM3175HPGM	31,750	1.2500	8
KSEM3200HPGM	32,000	1.2598	8
KSEM3220HPGM	32,200	1.2677	9
KSEM3234HPGM	32,340	1.2732	9
KSEM3250HPGM	32,500	1.2795	9
KSEM3254HPGM	32,540	1.2810	9
KSEM3294HPGM	32,940	1.2970	9
KSEM3300HPGM	33,000	1.2992	9
KSEM3334HPGM	33,340	1.3130	9
KSEM3350HPGM	33,500	1.3189	9
KSEM3373HPGM	33,730	1.3280	9
KSEM3400HPGM	34,000	1.3386	9
KSEM3413HPGM	34,130	1.3440	9
KSEM3450HPGM	34,500	1.3583	9
KSEM3493HPGM	34,930	1.3750	9
KSEM3500HPGM	35,000	1.3780	9
KSEM3550HPGM	35,500	1.3976	9
KSEM3572HPGM	35,720	1.4060	9
KSEM3600HPGM	36,000	1.4173	9
KSEM3612HPGM	36,120	1.4220	10
KSEM3650HPGM	36,500	1.4375	10
KSEM3651HPGM	36,510	1.4375	10
KSEM3700HPGM	37,000	1.4567	10
KSEM3731HPGM	37,310	1.4690	10
KSEM3750HPGM	37,500	1.4764	10
KSEM3800HPGM	38,000	1.4961	10
KSEM3810HPGM	38,100	1.5000	10
KSEM3846HPGM	38,460	1.5142	10
KSEM3850HPGM	38,500	1.5157	10
KSEM3900HPGM	39,000	1.5354	10
KSEM3950HPGM	39,500	1.5551	10
KSEM3975HPGM	39,750	1.5650	10
KSEM4000HPGM	40,000	1.5748	10

Tolerance HPG • Metric

D1 metric	tolerance h8
12,5–18	+0,000/-0,027
>18–30	+0,000/-0,033
>30–40	+0,000/-0,039

■ Modular Drill Carbide Insert Blades • KSEM™ • HPG Geometry • Grade KC7315™ • Through Coolant • Metric

Modular Drills

Material Group	Cutting Speed – vc			Metric							
	Range – m/min			Recommended Feed Rate (f) by Diameter							
	min	Starting Value	max		12,5	16,0	20,0	25,4	32,0	40,0	
P	1	75	110	140	mm/r	0,15–0,34	0,17–0,40	0,19–0,45	0,25–0,58	0,29–0,66	0,33–0,76
	2	90	120	150	mm/r	0,15–0,34	0,17–0,40	0,19–0,45	0,25–0,58	0,29–0,66	0,33–0,76
	3	50	75	100	mm/r	0,15–0,28	0,17–0,34	0,19–0,40	0,25–0,51	0,29–0,58	0,33–0,66
	4	55	75	95	mm/r	0,12–0,31	0,14–0,34	0,16–0,40	0,20–0,51	0,23–0,58	0,26–0,66
	5	50	65	80	mm/r	0,09–0,17	0,11–0,20	0,12–0,23	0,15–0,28	0,17–0,32	0,20–0,36
	6	50	65	80	mm/r	0,12–0,25	0,14–0,29	0,16–0,32	0,20–0,42	0,23–0,47	0,26–0,54
K	1	90	135	175	mm/r	0,17–0,35	0,21–0,42	0,25–0,48	0,31–0,59	0,37–0,70	0,43–0,81
	2	90	110	125	mm/r	0,17–0,33	0,21–0,41	0,25–0,48	0,31–0,59	0,37–0,70	0,43–0,81
	3	40	95	125	mm/r	0,18–0,36	0,20–0,41	0,21–0,44	0,23–0,48	0,25–0,53	0,27–0,57

- KSEM KCPM45™ HPG cutting edges provide increased productivity and improved tool life in steel in difficult conditions.
- HPG geometry works with low cutting and feed forces and provides very good centring. Reinforced cutting edges and good chip forming improve tool life due to high wear and edge chipping resistance.
- KCPM45 combines a very tough, fine-grain carbide substrate with an advanced multilayer TiAlN coating. It is capable of machining steel even in the most demanding conditions.
- Material snap back, stacked plates, cross holes, and inclined exits are some examples of where KCPM45 HPG edges will do a great job in your operations.
- Use KCPM45 HPG cutting edges as an effective alternative in stainless steel as well.

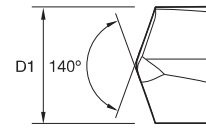
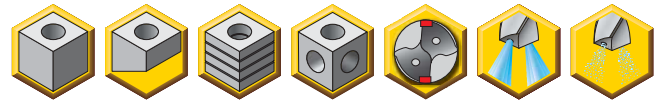

HPG



■ KSEM Inserts • HPG KCPM45



KCPM45	D1		seat size
	mm	in	
KSEM1250HPGM	12,500	.4921	C
KSEM1270HPGM	12,700	.5000	C
KSEM1280HPGM	12,800	.5039	C
KSEM1293HPGM	12,930	.5090	C
KSEM1300HPGM	13,000	.5118	C
KSEM1350HPGM	13,500	.5310	C
KSEM1360HPGM	13,600	.5354	B
KSEM1380HPGM	13,800	.5433	B
KSEM1389HPGM	13,890	.5470	B
KSEM1400HPGM	14,000	.5512	B
KSEM1410HPGM	14,100	.5551	B
KSEM1429HPGM	14,290	.5630	B
KSEM1450HPGM	14,500	.5709	B
KSEM1468HPGM	14,680	.5780	A
KSEM1500HPGM	15,000	.5906	A
KSEM1508HPGM	15,080	.5940	A
KSEM1550HPGM	15,500	.6102	A
KSEM1580HPGM	15,800	.6220	A
KSEM1588HPGM	15,880	.6250	1
KSEM1600HPGM	16,000	.6299	1
KSEM1609HPGM	16,090	.6340	1
KSEM1620HPGM	16,200	.6378	1
KSEM1627HPGM	16,270	.6410	1
KSEM1650HPGM	16,500	.6496	1
KSEM1667HPGM	16,670	.6560	1
KSEM1700HPGM	17,000	.6693	1
KSEM1707HPGM	17,070	.6720	1
KSEM1746HPGM	17,460	.6875	1
KSEM1750HPGM	17,500	.6890	1
KSEM1786HPGM	17,860	.7030	1
KSEM1800HPGM	18,000	.7087	1
KSEM1826HPGM	18,260	.7190	2



- first choice
- alternate choice

KCPM45	D1		seat size
	mm	in	
KSEM1850HPGM	18,500	.7283	2
KSEM1865HPGM	18,650	.7340	2
KSEM1900HPGM	19,000	.7480	2
KSEM1905HPGM	19,050	.7500	2
KSEM1920HPGM	19,200	.7559	2
KSEM1923HPGM	19,228	.7570	2
KSEM1925HPGM	19,250	.7579	2
KSEM1927HPGM	19,270	.7590	2
KSEM1945HPGM	19,450	.7660	2
KSEM1950HPGM	19,500	.7677	2
KSEM1965HPGM	19,650	.7736	2
KSEM1984HPGM	19,840	.7810	2
KSEM2000HPGM	20,000	.7874	3
KSEM2024HPGM	20,240	.7969	3
KSEM2050HPGM	20,500	.8071	3
KSEM2064HPGM	20,640	.8125	3
KSEM2100HPGM	21,000	.8268	3
KSEM2143HPGM	21,430	.8440	3
KSEM2150HPGM	21,500	.8460	3
KSEM2183HPGM	21,830	.8590	3
KSEM2200HPGM	22,000	.8661	3
KSEM2223HPGM	22,230	.8750	4
KSEM2244HPGM	22,440	.8840	4
KSEM2250HPGM	22,500	.8858	4
KSEM2300HPGM	23,000	.9055	4
KSEM2342HPGM	23,420	.9220	4
KSEM2350HPGM	23,500	.9252	4
KSEM2360HPGM	23,600	.9291	4
KSEM2370HPGM	23,700	.9331	4
KSEM2381HPGM	23,810	.9375	4
KSEM2400HPGM	24,000	.9449	4
KSEM2450HPGM	24,500	.9646	5

(continued)

(KSEM Inserts • HPG KCPM45™ — continued)



● first choice
○ alternate choice

Modular Drills

KCPM45	D1		seat size
	mm	in	
KSEM2461HPGM	24,610	.9690	5
KSEM2500HPGM	25,000	.9843	5
KSEM2540HPGM	25,400	1.0000	5
KSEM2550HPGM	25,500	1.0039	5
KSEM2560HPGM	25,600	1.0080	5
KSEM2565HPGM	25,654	1.0100	5
KSEM2567HPGM	25,670	1.0106	5
KSEM2581HPGM	25,810	1.0161	5
KSEM2600HPGM	26,000	1.0236	5
KSEM2619HPGM	26,190	1.0310	6
KSEM2650HPGM	26,500	1.0433	6
KSEM2659HPGM	26,590	1.0470	6
KSEM2700HPGM	27,000	1.0630	6
KSEM2750HPGM	27,500	1.0827	6
KSEM2778HPGM	27,780	1.0940	6
KSEM2800HPGM	28,000	1.1024	6
KSEM2818HPGM	28,180	1.1090	7
KSEM2835HPGM	28,350	1.1161	7
KSEM2850HPGM	28,500	1.1220	7
KSEM2858HPGM	28,580	1.1250	7
KSEM2900HPGM	29,000	1.1417	7
KSEM2937HPGM	29,370	1.1563	7
KSEM2950HPGM	29,500	1.1614	7
KSEM2977HPGM	29,770	1.1720	7
KSEM3000HPGM	30,000	1.1811	7
KSEM3016HPGM	30,160	1.1875	8
KSEM3050HPGM	30,500	1.2008	8
KSEM3096HPGM	30,960	1.2190	8

KCPM45	D1		seat size
	mm	in	
KSEM3100HPGM	31,000	1.2205	8
KSEM3115HPGM	31,150	1.2264	8
KSEM3150HPGM	31,500	1.2402	8
KSEM3175HPGM	31,750	1.2500	8
KSEM3200HPGM	32,000	1.2598	8
KSEM3250HPGM	32,500	1.2795	9
KSEM3254HPGM	32,540	1.2810	9
KSEM3300HPGM	33,000	1.2992	9
KSEM3334HPGM	33,340	1.3130	9
KSEM3350HPGM	33,500	1.3189	9
KSEM3400HPGM	34,000	1.3386	9
KSEM3450HPGM	34,500	1.3583	9
KSEM3493HPGM	34,930	1.3750	9
KSEM3500HPGM	35,000	1.3780	9
KSEM3600HPGM	36,000	1.4173	9
KSEM3651HPGM	36,510	1.4375	10
KSEM3700HPGM	37,000	1.4567	10
KSEM3731HPGM	37,310	1.4690	10
KSEM3750HPGM	37,500	1.4764	10
KSEM3800HPGM	38,000	1.4961	10
KSEM3810HPGM	38,100	1.5000	10
KSEM3846HPGM	38,460	1.5142	10
KSEM3900HPGM	39,000	1.5354	10
KSEM4000HPGM	40,000	1.5748	10

Tolerance HPG • Metric

D1 metric	tolerance h8
12,5–18	+0,000/-0,027
>18–30	+0,000/-0,033
>30–40	+0,000/-0,039

■ Modular Drill Carbide Insert Blades • KSEM™ • HPG Geometry • Grade KCPM45™ • Through Coolant • Metric

Material Group	Cutting Speed – vc			Metric							
	Range – m/min			Recommended Feed Rate (f) by Diameter							
	min	Starting Value	max		12,5	16,0	20,0	25,4	32,0	40,0	
P	1	100	110	120	mm/r	0,15–0,31	0,17–0,36	0,19–0,41	0,25–0,53	0,29–0,60	0,33–0,69
	2	80	95	110	mm/r	0,15–0,31	0,17–0,36	0,19–0,41	0,25–0,53	0,29–0,60	0,33–0,69
	3	65	70	80	mm/r	0,15–0,31	0,17–0,36	0,19–0,41	0,25–0,53	0,29–0,60	0,33–0,69
M	1	30	60	90	mm/r	0,09–0,14	0,11–0,17	0,13–0,20	0,16–0,25	0,18–0,28	0,21–0,31
	2	30	50	90	mm/r	0,09–0,14	0,11–0,17	0,13–0,20	0,16–0,25	0,18–0,28	0,21–0,31
	3	20	40	60	mm/r	0,09–0,14	0,11–0,17	0,13–0,20	0,16–0,25	0,18–0,28	0,21–0,31



Modular Drills

■ Modular Drill Carbide Insert Blades • KSEM • HPG Geometry • Grade KCPM45 • MQL* • Metric

Material Group	Cutting Speed – vc			Metric							
	Range – m/min			Recommended Feed Rate (f) by Diameter							
	min	Starting Value	max		12,5	16,0	20,0	25,4	32,0	40,0	
P	1	60	70	80	mm/r	0,15–0,31	0,17–0,36	0,19–0,41	0,25–0,53	0,29–0,60	0,33–0,69
	2	50	60	70	mm/r	0,15–0,31	0,17–0,36	0,19–0,41	0,25–0,53	0,29–0,60	0,33–0,69
	3	65	45	80	mm/r	0,15–0,31	0,17–0,36	0,19–0,41	0,25–0,53	0,29–0,60	0,33–0,69
M	1	30	40	50	mm/r	0,09–0,14	0,11–0,17	0,13–0,20	0,16–0,25	0,18–0,28	0,21–0,31
	2	25	30	35	mm/r	0,09–0,14	0,11–0,17	0,13–0,20	0,16–0,25	0,18–0,28	0,21–0,31
	3	20	25	30	mm/r	0,09–0,14	0,11–0,17	0,13–0,20	0,16–0,25	0,18–0,28	0,21–0,31

 *Recommended for drilling depths $\leq 1.5 \times D$.

- KSEM KC7410™ HPCCL focuses on tool life and process reliability in cast iron materials in all cast iron materials. It offers increased feed forces in increases your productivity.
- HPCCL geometry offers a wide and strong HP-style chiseled edge that prevents material quenching in the centre, enabling high feed rates. With a corner chamfer and strong edges, it creates high quality holes and increased tool life.
- KC7410 is a multilayer AlCr-based coating over fine-grain carbide. It is extraordinarily wear resistant in cast iron applications due to its high hot hardness.
- Use KC7410 HPCCL in all cast iron applications, especially when working in difficult conditions and CGI or ADI irons.

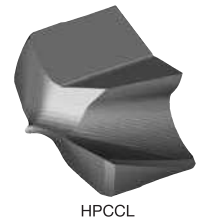
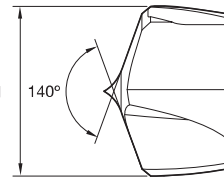
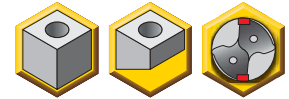

HPCCL

Modular Drills

■ KSEM Inserts • HPCCL KC7410



KC7410	D1		seat size
	mm	in	
KSEM1250HPCCLM	12,500	.4921	C
KSEM1270HPCCLM *	12,700	.5000	C
KSEM1293HPCCLM	12,930	.5091	C
KSEM1300HPCCLM	13,000	.5118	C
KSEM1310HPCCLM	13,100	.5157	C
KSEM1350HPCCLM	13,500	.5315	C
KSEM1389HPCCLM	13,890	.5469	B
KSEM1400HPCCLM	14,000	.5512	B
KSEM1429HPCCLM	14,290	.5626	B
KSEM1450HPCCLM	14,500	.5709	B
KSEM1468HPCCLM	14,680	.5780	A
KSEM1500HPCCLM	15,000	.5906	A
KSEM1548HPCCLM *	15,480	.6094	A
KSEM1550HPCCLM	15,500	.6102	A
KSEM1588HPCCLM *	15,880	.6252	1
KSEM1600HPCCLM	16,000	.6299	1
KSEM1609HPCCLM	16,090	.6335	1
KSEM1627HPCCLM	16,270	.6406	1
KSEM1650HPCCLM	16,500	.6496	1
KSEM1667HPCCLM	16,670	.6563	1
KSEM1700HPCCLM	17,000	.6693	1
KSEM1707HPCCLM	17,070	.6720	1
KSEM1746HPCCLM	17,460	.6874	1
KSEM1750HPCCLM	17,500	.6890	1
KSEM1760HPCCLM	17,600	.6929	1
KSEM1800HPCCLM	18,000	.7087	1
KSEM1826HPCCLM	18,260	.7189	2
KSEM1850HPCCLM	18,500	.7283	2
KSEM1900HPCCLM	19,000	.7480	2
KSEM1905HPCCLM	19,050	.7500	2
KSEM1927HPCCLM *	19,270	.7587	2
KSEM1945HPCCLM *	19,450	.7657	2



- first choice
- alternate choice

KC7410	D1		seat size
	mm	in	
KSEM1950HPCCLM	19,500	.7677	2
KSEM1984HPCCLM	19,840	.7811	2
KSEM2000HPCCLM	20,000	.7874	3
KSEM2024HPCCLM	20,240	.7969	3
KSEM2050HPCCLM	20,500	.8071	3
KSEM2064HPCCLM	20,640	.8126	3
KSEM2100HPCCLM	21,000	.8268	3
KSEM2143HPCCLM	21,430	.8437	3
KSEM2150HPCCLM	21,500	.8465	3
KSEM2200HPCCLM	22,000	.8661	3
KSEM2210HPCCLM	22,100	.8701	4
KSEM2223HPCCLM	22,230	.8752	4
KSEM2244HPCCLM	22,440	.8835	4
KSEM2250HPCCLM	22,500	.8858	4
KSEM2300HPCCLM	23,000	.9055	4
KSEM2342HPCCLM	23,420	.9220	4
KSEM2350HPCCLM	23,500	.9252	4
KSEM2381HPCCLM	23,810	.9374	4
KSEM2400HPCCLM	24,000	.9449	4
KSEM2450HPCCLM	24,500	.9646	5
KSEM2461HPCCLM	24,610	.9689	5
KSEM2500HPCCLM	25,000	.9843	5
KSEM2540HPCCLM	25,400	1.0000	5
KSEM2550HPCCLM	25,500	1.0039	5
KSEM2567HPCCLM	25,670	1.0106	5
KSEM2600HPCCLM	26,000	1.0236	5
KSEM2619HPCCLM	26,190	1.0311	6
KSEM2650HPCCLM	26,500	1.0433	6
KSEM2659HPCCLM	26,590	1.0469	6
KSEM2700HPCCLM	27,000	1.0630	6
KSEM2750HPCCLM	27,500	1.0827	6
KSEM2778HPCCLM	27,780	1.0937	6

(continued)

(KSEM Inserts • HPCCL KC7410™ — continued)



KC7410	D1		seat size
	mm	in	
KSEM2800HPCCLM	28,000	1.1024	6
KSEM2818HPCCLM *	28,180	1.0940	7
KSEM2850HPCCLM	28,500	1.1220	7
KSEM2858HPCCLM	28,580	1.1250	7
KSEM2900HPCCLM	29,000	1.1417	7
KSEM2937HPCCLM	29,370	1.1563	7
KSEM2950HPCCLM *	29,500	1.1614	7
KSEM2977HPCCLM	29,770	1.1720	7
KSEM3000HPCCLM	30,000	1.1811	7
KSEM3016HPCCLM	30,160	1.1875	8
KSEM3050HPCCLM	30,500	1.2008	8
KSEM3100HPCCLM	31,000	1.2205	8



● first choice
○ alternate choice

KC7410	D1		seat size
	mm	in	
KSEM3175HPCCLM	31,750	1.2500	8
KSEM3200HPCCLM	32,000	1.2598	8
KSEM3300HPCCLM	33,000	1.2992	9
KSEM3400HPCCLM *	34,000	1.3386	9
KSEM3500HPCCLM	35,000	1.3780	9
KSEM3600HPCCLM	36,000	1.4173	9
KSEM3700HPCCLM	37,000	1.4567	10
KSEM3800HPCCLM	38,000	1.4961	10
KSEM3900HPCCLM	39,000	1.5354	10
KSEM3920HPCCLM	39,200	1.5433	10
KSEM4000HPCCLM *	40,000	1.5748	10

NOTE: *Made-to-order standard item. Standard pricing, manufacturing lead time, and minimum order quantity applies.

Tolerance HPCCL • Metric

D1	tolerance h8
12,5–18	+0,000/-0,027
>18–30	+0,000/-0,033
>30–40	+0,000/-0,039

Application Data

Modular Drill Carbide Insert Blades • KSEM™ • HPCCL Geometry • Grade KC7410™ • Through Coolant • Metric

Material Group	Cutting Speed — vc				Metric						
	Range — m/min				Recommended Feed Rate (f) by Diameter						
	min	Starting Value	max		12,5	16,0	20,0	25,4	32,0	40,0	
K	1	100	175	200	mm/r	0,17–0,35	0,21–0,42	0,25–0,48	0,31–0,59	0,37–0,70	0,43–0,81
	2	100	160	180	mm/r	0,17–0,33	0,21–0,41	0,25–0,48	0,31–0,59	0,37–0,70	0,43–0,81
	3	70	85	100	mm/r	0,18–0,36	0,20–0,41	0,21–0,44	0,23–0,48	0,25–0,53	0,27–0,57



- KSEM KC7320™ HPL cutting edges provide perfect results and very high productivity in stainless steel.
- HPL geometry forms two chips per cutting edge for an uninterrupted, smooth chip flow. Very high metal removal rates and a reliable drilling process up to 10 x D makes HPL the superior solution for drilling in stainless steels.
- Grade KC7320 features a high Al content TiAlN coating on a universal fine-grain carbide. Its excellent oxidation stability and carbide toughness enables a high level of wear resistance in austenitic and other stainless steels.

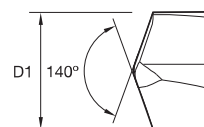
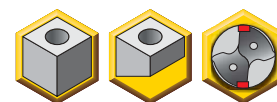

HPL

Modular Drills

■ KSEM Inserts • HPL KC7320



KC7320	D1		seat size
	mm	in	
KSEM1250HPLM	12,500	.4921	C
KSEM1270HPLM	12,700	.5000	C
KSEM1280HPLM	12,800	.5039	C
KSEM1293HPLM	12,930	.5090	C
KSEM1300HPLM	13,000	.5118	C
KSEM1311HPLM	13,100	.5157	C
KSEM1350HPLM	13,500	.5310	C
KSEM1360HPLM	13,600	.5354	B
KSEM1380HPLM	13,800	.5433	B
KSEM1389HPLM	13,890	.5470	B
KSEM1400HPLM	14,000	.5512	B
KSEM1410HPLM	14,100	.5551	B
KSEM1415HPLM	14,150	.5571	B
KSEM1420HPLM	14,200	.5591	B
KSEM1429HPLM	14,290	.5630	B
KSEM1450HPLM	14,500	.5709	B
KSEM1460HPLM	14,600	.5748	A
KSEM1468HPLM	14,680	.5780	A
KSEM1480HPLM	14,800	.5827	A
KSEM1500HPLM	15,000	.5906	A
KSEM1508HPLM	15,080	.5940	A
KSEM1548HPLM	15,480	.6090	A
KSEM1550HPLM	15,500	.6102	A
KSEM1560HPLM	15,600	.6142	A
KSEM1588HPLM	15,880	.6250	1
KSEM1600HPLM	16,000	.6299	1
KSEM1609HPLM	16,090	.6340	1
KSEM1610HPLM	16,100	.6339	1
KSEM1615HPLM	16,150	.6358	1
KSEM1620HPLM	16,200	.6378	1
KSEM1627HPLM	16,270	.6410	1
KSEM1650HPLM	16,500	.6496	1
KSEM1667HPLM	16,670	.6560	1
KSEM1700HPLM	17,000	.6693	1
KSEM1707HPLM	17,070	.6720	1
KSEM1746HPLM	17,460	.6875	1
KSEM1750HPLM	17,500	.6890	1
KSEM1775HPLM	17,750	.6988	1
KSEM1780HPLM	17,800	.7008	1
KSEM1786HPLM	17,860	.7030	1
KSEM1790HPLM	17,900	.7047	1
KSEM1800HPLM	18,000	.7087	1
KSEM1826HPLM	18,260	.7190	2
KSEM1850HPLM	18,500	.7283	2



- first choice
- alternate choice

KC7320	D1		seat size
	mm	in	
KSEM1860HPLM	18,600	.7323	2
KSEM1865HPLM	18,650	.7340	2
KSEM1890HPLM	18,900	.7441	2
KSEM1900HPLM	19,000	.7480	2
KSEM1905HPLM	19,050	.7500	2
KSEM1920HPLM	19,200	.7559	2
KSEM1923HPLM	19,228	.7570	2
KSEM1925HPLM	19,250	.7579	2
KSEM1927HPLM	19,270	.7590	2
KSEM1935HPLM	19,350	.7618	2
KSEM1936HPLM	19,360	.7622	2
KSEM1938HPLM	19,380	.7630	2
KSEM1945HPLM	19,450	.7660	2
KSEM1950HPLM	19,500	.7677	2
KSEM1984HPLM	19,840	.7810	2
KSEM2000HPLM	20,000	.7874	3
KSEM2010HPLM	20,100	.7913	3
KSEM2024HPLM	20,240	.7970	3
KSEM2035HPLM	20,350	.8012	3
KSEM2050HPLM	20,500	.8071	3
KSEM2064HPLM	20,640	.8125	3
KSEM2100HPLM	21,000	.8268	3
KSEM2115HPLM	21,150	.8327	3
KSEM2133HPLM	21,330	.8398	3
KSEM2143HPLM	21,430	.8440	3
KSEM2150HPLM	21,500	.8460	3
KSEM2183HPLM	21,830	.8590	3
KSEM2200HPLM	22,000	.8661	3
KSEM2223HPLM	22,230	.8750	4
KSEM2244HPLM	22,440	.8840	4
KSEM2250HPLM	22,500	.8858	4
KSEM2277HPLM	22,770	.8965	4
KSEM2300HPLM	23,000	.9055	4
KSEM2342HPLM	23,420	.9220	4
KSEM2350HPLM	23,500	.9252	4
KSEM2381HPLM	23,810	.9375	4
KSEM2400HPLM	24,000	.9449	4
KSEM2450HPLM	24,500	.9646	5
KSEM2461HPLM	24,610	.9690	5
KSEM2500HPLM	25,000	.9843	5
KSEM2507HPLM	25,070	.9870	5
KSEM2540HPLM	25,400	1.0000	5
KSEM2550HPLM	25,500	1.0039	5
KSEM2560HPLM	25,600	1.0080	5

(continued)

(KSEM Inserts • HPL KC7320™ – continued)



● first choice
○ alternate choice

KC7320	D1		seat size
	mm	in	
KSEM2565HPLM	25,650	1.0098	5
KSEM2567HPLM	25,670	1.0110	5
KSEM2581HPLM	25,810	1.0161	5
KSEM2600HPLM	26,000	1.0236	5
KSEM2619HPLM	26,190	1.0310	6
KSEM2650HPLM	26,500	1.0433	6
KSEM2659HPLM	26,590	1.0470	6
KSEM2670HPLM	26,700	1.0512	6
KSEM2700HPLM	27,000	1.0630	6
KSEM2750HPLM	27,500	1.0827	6
KSEM2779HPLM	27,780	1.0940	6
KSEM2800HPLM	28,000	1.1024	6
KSEM2810HPLM	28,100	1.1063	7
KSEM2817HPLM	28,180	1.1090	7
KSEM2850HPLM	28,500	1.1220	7
KSEM2858HPLM	28,580	1.1250	7
KSEM2900HPLM	29,000	1.1417	7
KSEM2937HPLM	29,370	1.1563	7
KSEM2950HPLM	29,500	1.1614	7
KSEM2977HPLM	29,770	1.1720	7

KC7320	D1		seat size
	mm	in	
KSEM3000HPLM	30,000	1.1811	7
KSEM3016HPLM	30,160	1.1875	8
KSEM3050HPLM	30,500	1.2008	8
KSEM3100HPLM	31,000	1.2205	8
KSEM3150HPLM	31,500	1.2402	8
KSEM3175HPLM	31,750	1.2500	8
KSEM3200HPLM	32,000	1.2598	8
KSEM3254HPLM	32,540	1.2810	9
KSEM3300HPLM	33,000	1.2992	9
KSEM3335HPLM	33,400	1.3130	9
KSEM3400HPLM	34,000	1.3386	9
KSEM3493HPLM	34,930	1.3750	9
KSEM3500HPLM	35,000	1.3780	9
KSEM3571HPLM	35,720	1.4060	9
KSEM3600HPLM	36,000	1.4173	9
KSEM3700HPLM	37,000	1.4567	10
KSEM3750HPLM	37,500	1.4764	10
KSEM3800HPLM	38,000	1.4961	10
KSEM3810HPLM	38,100	1.5000	10
KSEM3846HPLM	38,460	1.5140	10
KSEM3900HPLM	39,000	1.5354	10
KSEM4000HPLM	40,000	1.5748	10

Tolerance HPL • Metric

D1 metric	tolerance h8
12,5–18	+0,000/-0,027
>18–30	+0,000/-0,033
>30–40	+0,000/-0,039

Application Data

Modular Drill Carbide Insert Blades • KSEM • HPL Geometry • Grade KC7320 • Through Coolant • Metric

Material Group	Cutting Speed – vc			Metric							
	Range – m/min			Recommended Feed Rate (f) by Diameter							
	min	Starting Value	max		12,5	16,0	20,0	25,4	32,0	40,0	
M	1	30	60	90	mm/r	0,09–0,14	0,11–0,17	0,13–0,20	0,16–0,25	0,18–0,28	0,21–0,31
	2	30	50	90	mm/r	0,09–0,14	0,11–0,17	0,13–0,20	0,16–0,25	0,18–0,28	0,21–0,31
	3	20	40	60	mm/r	0,09–0,14	0,11–0,17	0,13–0,20	0,16–0,25	0,18–0,28	0,21–0,31



- KSEM SPL geometry was made to offer extraordinary drilling performance in stainless steels, super alloys, and other demanding environments.
- KSEM SPL provides process reliability, ensuring longer tool life and productivity in difficult-to-machine materials. Its advanced-point geometry and web design greatly reduces cutting forces.
- KCMS35™ is based on a very tough, fine-grain carbide substrate with a high Al content TiAlN PVD coating. It offers a high level of wear resistance and oxidation stability in parallel with chipping resistance for centre point and cutting edges.
- This insert style is ideally suited to drill heavy-duty and corrosion-resistant tube end sheets and other heat exchanger components (especially from M3 and type S materials).
- Use KSEM KCMS35 SPL inserts as an effective alternative for plain and alloyed steels, as well as in the most important Al and Cu applications.

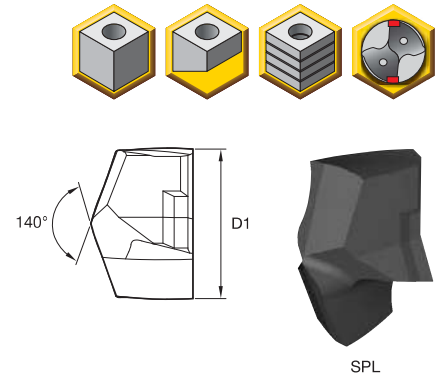

■ KSEM Inserts • SPL KCMS35



KCMS35	D1		seat size
	mm	in	
KSEM1250SPLM	12,500	.4921	C
KSEM1270SPLM	12,700	.5000	C
KSEM1300SPLM	13,000	.5118	C
KSEM1350SPLM	13,500	.5315	C
KSEM1400SPLM	14,000	.5512	B
KSEM1429SPLM	14,290	.5626	B
KSEM1450SPLM	14,500	.5709	B
KSEM1500SPLM	15,000	.5906	A
KSEM1550SPLM	15,500	.6102	A
KSEM1588SPLM	15,880	.6252	1
KSEM1600SPLM	16,000	.6299	1
KSEM1609SPLM	16,090	.6335	1
KSEM1615SPLM	16,150	.6358	1
KSEM1627SPLM	16,270	.6406	1
KSEM1650SPLM	16,500	.6496	1
KSEM1667SPLM	16,670	.6563	1
KSEM1700SPLM	17,000	.6693	1
KSEM1746SPLM	17,460	.6874	1
KSEM1750SPLM	17,500	.6890	1
KSEM1800SPLM	18,000	.7087	1
KSEM1830SPLM	18,300	.7205	2
KSEM1850SPLM	18,500	.7283	2
KSEM1900SPLM	19,000	.7480	2
KSEM1905SPLM	19,050	.7500	2
KSEM1920SPLM	19,200	.7559	2
KSEM1923SPLM	19,230	.7571	2
KSEM1925SPLM	19,250	.7579	2
KSEM1927SPLM	19,270	.7587	2
KSEM1935SPLM	19,350	.7618	2
KSEM1945SPLM	19,450	.7657	2
KSEM1950SPLM	19,500	.7677	2
KSEM1984SPLM	19,840	.7811	2



- first choice
- alternate choice

KCMS35	D1		seat size
	mm	in	
KSEM2000SPLM	20,000	.7874	3
KSEM2024SPLM	20,240	.7969	3
KSEM2050SPLM	20,500	.8071	3
KSEM2064SPLM	20,640	.8126	3
KSEM2100SPLM	21,000	.8268	3
KSEM2150SPLM	21,500	.8465	3
KSEM2200SPLM	22,000	.8661	3
KSEM2223SPLM	22,230	.8752	4
KSEM2250SPLM	22,500	.8858	4
KSEM2300SPLM	23,000	.9055	4
KSEM2350SPLM	23,500	.9252	4
KSEM2381SPLM	23,810	.9374	4
KSEM2400SPLM	24,000	.9449	4
KSEM2450SPLM	24,500	.9646	5
KSEM2500SPLM	25,000	.9843	5
KSEM2525SPLM	25,250	.9941	5
KSEM2530SPLM	25,300	.9961	5
KSEM2540SPLM	25,400	1.0000	5
KSEM2550SPLM	25,500	1.0039	5
KSEM2560SPLM	25,600	1.0079	5
KSEM2565SPLM	25,650	1.0098	5
KSEM2567SPLM	25,670	1.0106	5
KSEM2581SPLM	25,810	1.0161	5
KSEM2600SPLM	26,000	1.0236	5
KSEM2619SPLM	26,190	1.0311	6
KSEM2630SPLM	26,300	1.0354	6
KSEM2650SPLM	26,500	1.0433	6
KSEM2659SPLM	26,590	1.0469	6
KSEM2700SPLM	27,000	1.0630	6
KSEM2750SPLM	27,500	1.0827	6
KSEM2800SPLM	28,000	1.1024	6
KSEM2850SPLM	28,500	1.1220	7

(continued)

(KSEM Inserts • SPL KCMS35™ — continued)

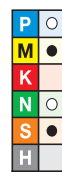

● first choice
○ alternate choice

KCMS35	D1		seat size
	mm	in	
KSEM2858SPLM	28,580	1.1252	7
KSEM2900SPLM	29,000	1.1417	7
KSEM2950SPLM	29,500	1.1614	7
KSEM3000SPLM	30,000	1.1811	7
KSEM3050SPLM	30,500	1.2008	8
KSEM3100SPLM	31,000	1.2205	8
KSEM3150SPLM	31,500	1.2402	8
KSEM3175SPLM	31,750	1.2500	8
KSEM3200SPLM	32,000	1.2598	8
KSEM3250SPLM	32,500	1.2795	9
KSEM3350SPLM	33,500	1.3189	9
KSEM3400SPLM	34,000	1.3386	9

KCMS35	D1		seat size
	mm	in	
KSEM3450SPLM	34,500	1.3583	9
KSEM3500SPLM	35,000	1.3780	9
KSEM3550SPLM	35,500	1.3976	9
KSEM3600SPLM	36,000	1.4173	9
KSEM3650SPLM	36,500	1.4370	10
KSEM3700SPLM	37,000	1.4567	10
KSEM3750SPLM	37,500	1.4764	10
KSEM3800SPLM	38,000	1.4961	10
KSEM3846SPLM	38,460	1.5142	10
KSEM3850SPLM	38,500	1.5157	10
KSEM3900SPLM	39,000	1.5354	10
KSEM3950SPLM	39,500	1.5551	10
KSEM4000SPLM	40,000	1.5748	10

Tolerance SPL • Metric

D1 metric	tolerance h8
12,5-18	+0,000/-0,027
>18-30	+0,000/-0,033
>30-40	+0,000/-0,039

Application Data

■ Modular Drill Carbide Insert Blades • KSEM™ • SPL Geometry • Grade KCMS35™ • Through Coolant • Metric

Material Group	Cutting Speed — vc				Metric						
	Range — m/min				Recommended Feed Rate (f) by Diameter						
	min	Starting Value	max		12,5	16,0	20,0	25,4	32,0	40,0	
P	1	110	140	170	mm/r	0,15-0,31	0,17-0,36	0,19-0,41	0,25-0,53	0,29-0,60	0,33-0,69
	2	100	120	140	mm/r	0,15-0,31	0,17-0,36	0,19-0,41	0,25-0,53	0,29-0,60	0,33-0,69
	3	80	100	120	mm/r	0,15-0,31	0,17-0,36	0,19-0,41	0,25-0,53	0,29-0,60	0,33-0,69
M	1	40	60	80	mm/r	0,09-0,14	0,11-0,17	0,13-0,20	0,16-0,25	0,18-0,28	0,21-0,31
	2	35	55	70	mm/r	0,09-0,14	0,11-0,17	0,13-0,20	0,16-0,25	0,18-0,28	0,21-0,31
	3	20	40	60	mm/r	0,09-0,14	0,11-0,17	0,13-0,20	0,16-0,25	0,18-0,28	0,21-0,31
N	1	90	155	220	mm/r	0,19-0,40	0,25-0,50	0,28-0,56	0,32-0,63	0,32-0,70	0,32-0,70
	2	90	155	220	mm/r	0,19-0,40	0,25-0,50	0,28-0,56	0,32-0,63	0,32-0,70	0,32-0,70
	3	80	120	160	mm/r	0,19-0,40	0,25-0,50	0,28-0,56	0,32-0,63	0,32-0,70	0,32-0,70
	4	90	155	220	mm/r	0,19-0,40	0,25-0,50	0,28-0,56	0,32-0,63	0,32-0,70	0,32-0,70
S	1	20	40	60	mm/r	0,05-0,10	0,07-0,12	0,09-0,14	0,11-0,17	0,13-0,20	0,16-0,25
	2	15	30	45	mm/r	0,05-0,10	0,07-0,12	0,09-0,14	0,11-0,17	0,13-0,20	0,16-0,25
	3	15	30	45	mm/r	0,05-0,10	0,07-0,12	0,09-0,14	0,11-0,17	0,13-0,20	0,16-0,25
	4	10	25	40	mm/r	0,05-0,10	0,07-0,12	0,13-0,20	0,16-0,25	0,18-0,28	0,21-0,31

Application recommendation: We recommend pre-centring when drilling with SPL inserts >5 x D. For deeper holes (> = 10 x D), and for drilling M1 and M2 materials in general, we recommend using KSEM HPL inserts as a first choice.



- KSEM FEG flat-bottom inserts create 180° flat holes — only a small cavity remains in the centre of the hole ground. KSEM offers an extraordinarily strong pocket seat for your demanding flat-bottom applications.
- Whether it is a blind hole, a through hole, or if you need to countersink, these inserts are focused on versatility and will support you in many essential drilling applications.
- KSEM FEG inserts feature a small centring point as well as double margin lands for improved guidance and hole straightness. A corner chamfer serves to reduce bur formation and to improve tool life.
- KCPM45™ combines a very tough, fine-grain carbide substrate with an advanced multilayer TiAlN coating. It is capable of machining steel even in the most demanding conditions.
- Use KSEM FEG KCPM45 cutting edges as an effective alternative in cast iron, stainless steel, and high-temp alloys.

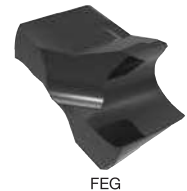
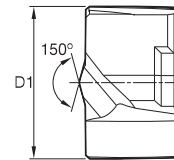
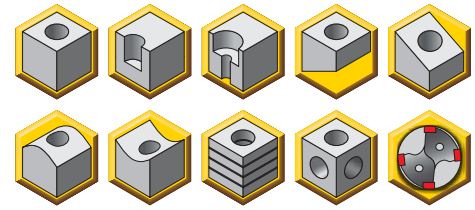

■ KSEM Inserts • FEG KCPM45



KCPM45	D1		seat size
	mm	in	
KSEM1600FEGM	16,000	.6299	1
KSEM1650FEGM	16,500	.6496	1
KSEM1700FEGM	17,000	.6693	1
KSEM1750FEGM	17,500	.6890	1
KSEM1800FEGM	18,000	.7087	1
KSEM1850FEGM	18,500	.7283	2
KSEM1900FEGM	19,000	.7480	2
KSEM1905FEGM	19,050	.7500	2
KSEM1950FEGM	19,500	.7677	2
KSEM1984FEGM	19,840	.7811	2
KSEM2000FEGM	20,000	.7874	3
KSEM2050FEGM	20,500	.8071	3
KSEM2100FEGM	21,000	.8268	3
KSEM2150FEGM	21,500	.8465	3
KSEM2200FEGM	22,000	.8661	3
KSEM2250FEGM	22,500	.8858	4
KSEM2300FEGM	23,000	.9055	4
KSEM2350FEGM	23,500	.9252	4
KSEM2400FEGM	24,000	.9449	4
KSEM2450FEGM	24,500	.9646	5
KSEM2500FEGM	25,000	.9843	5
KSEM2540FEGM	25,400	1.0000	5
KSEM2550FEGM	25,500	1.0039	5
KSEM2580FEGM	25,800	1.0157	5



● first choice
○ alternate choice

KCPM45	D1		seat size
	mm	in	
KSEM2581FEGM	25,810	1.0161	5
KSEM2600FEGM	26,000	1.0236	5
KSEM2619FEGM	26,190	1.0311	6
KSEM2650FEGM	26,500	1.0433	6
KSEM2670FEGM	26,700	1.0512	6
KSEM2700FEGM	27,000	1.0630	6
KSEM2750FEGM	27,500	1.0827	6
KSEM2800FEGM	28,000	1.1024	6
KSEM2850FEGM	28,500	1.1220	7
KSEM2900FEGM	29,000	1.1417	7
KSEM2950FEGM	29,500	1.1614	7
KSEM3000FEGM	30,000	1.1811	7
KSEM3050FEGM	30,500	1.2008	8
KSEM3100FEGM	31,000	1.2205	8
KSEM3150FEGM	31,500	1.2402	8
KSEM3175FEGM	31,750	1.2500	8
KSEM3200FEGM	32,000	1.2598	8
KSEM3250FEGM	32,500	1.2795	9
KSEM3300FEGM	33,000	1.2992	9
KSEM3350FEGM	33,500	1.3189	9
KSEM3400FEGM	34,000	1.3386	9
KSEM3450FEGM	34,500	1.3583	9
KSEM3500FEGM	35,000	1.3780	9
KSEM3550FEGM	35,500	1.3976	9

(continued)

(KSEM Inserts • FEG KCPM45™ — continued)



● first choice
○ alternate choice

KCPM45	D1		seat size
	mm	in	
KSEM3600FEGM	36,000	1.4173	9
KSEM3650FEGM	36,500	1.4370	10
KSEM3700FEGM	37,000	1.4567	10
KSEM3750FEGM	37,500	1.4764	10
KSEM3800FEGM	38,000	1.4961	10
KSEM3810FEGM	38,100	1.5000	10
KSEM3850FEGM	38,500	1.5157	10
KSEM3900FEGM	39,000	1.5354	10
KSEM3950FEGM	39,500	1.5551	10
KSEM4000FEGM	40,000	1.5748	10

Tolerance FEG • Metric

D1 metric	tolerance k7
12,5–18	+0,001/+ 0,019
>18–30	+0,002/+ 0,023
>30–40	+0,002/+ 0,027

Application Data

■ Modular Drill Carbide Insert Blades • KSEM™ • FEG Geometry • Grade KCPM45™ • Through Coolant • Metric

Material Group		Cutting Speed – vc		Metric							
		Range – m/min		Recommended Feed Rate (f) by Diameter							
		min	Starting Value	max	12,5	16,0	20,0	25,4	32,0	40,0	
P	1	110	140	170	mm/r	0,14–0,23	0,17–0,25	0,19–0,29	0,23–0,38	0,26–0,43	0,33–0,76
	2	100	120	140	mm/r	0,17–0,23	0,19–0,25	0,22–0,29	0,29–0,38	0,32–0,43	0,33–0,76
	3	80	100	120	mm/r	0,14–0,20	0,15–0,23	0,17–0,25	0,23–0,34	0,26–0,38	0,33–0,66
	4	70	90	110	mm/r	0,11–0,20	0,13–0,23	0,14–0,25	0,18–0,34	0,21–0,38	0,26–0,66
M	1	40	60	80	mm/r	0,09–0,14	0,11–0,17	0,13–0,20	0,16–0,25	0,18–0,28	0,21–0,31
	2	35	55	70	mm/r	0,09–0,14	0,11–0,17	0,13–0,20	0,16–0,25	0,18–0,28	0,21–0,31
	3	20	40	60	mm/r	0,09–0,14	0,11–0,17	0,13–0,20	0,16–0,25	0,18–0,28	0,21–0,31
K	1	90	135	175	mm/r	0,17–0,23	0,19–0,25	0,22–0,29	0,29–0,38	0,32–0,43	0,33–0,76
	2	80	120	140	mm/r	0,17–0,23	0,19–0,25	0,22–0,29	0,29–0,38	0,32–0,43	0,33–0,76
	3	70	110	125	mm/r	0,15–0,24	0,18–0,26	0,21–0,29	0,23–0,37	0,25–0,42	0,27–0,57
S	1	20	40	60	mm/r	0,09–0,14	0,11–0,17	0,13–0,20	0,16–0,25	0,18–0,28	0,21–0,31
	3	15	30	45	mm/r	0,09–0,14	0,11–0,17	0,13–0,20	0,16–0,25	0,18–0,28	0,21–0,31



- KSEM PC cutting edges serve mainly as precentering inserts, but can also be used in demanding conditions.
- Steep 150° degree angle with a light corner chamfer. Very good centering capability and edge chipping resistance.
- KC7135™ is a very resistant grade featuring a TiCN-TiN PVD coating.

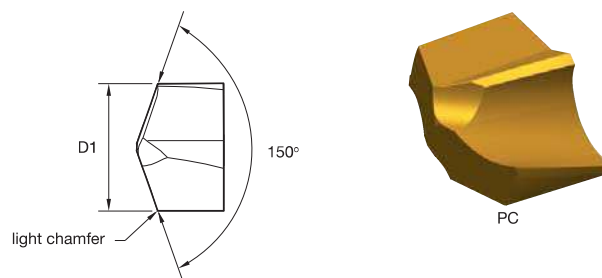
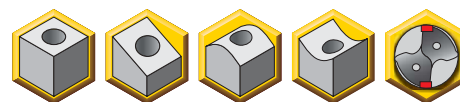

Modular Drills

■ KSEM Inserts • PC KC7135



KC7135	D1		seat size
	mm	in	
KSEM1250PCM	12,500	.4921	C
KSEM1280PCM	12,800	.5039	C
KSEM1300PCM	13,000	.5118	C
KSEM1350PCM	13,500	.5310	C
KSEM1380PCM	13,800	.5433	B
KSEM1400PCM	14,000	.5512	B
KSEM1410PCM	14,100	.5551	B
KSEM1450PCM	14,500	.5709	B
KSEM1460PCM	14,600	.5748	A
KSEM1480PCM	14,800	.5827	A
KSEM1500PCM	15,000	.5906	A
KSEM1550PCM	15,500	.6102	A
KSEM1560PCM	15,600	.6142	A
KSEM1580PCM	15,800	.6220	A
KSEM1600PCM	16,000	.6299	1
KSEM1620PCM	16,200	.6378	1
KSEM1650PCM	16,500	.6496	1
KSEM1700PCM	17,000	.6693	1
KSEM1750PCM	17,500	.6890	1
KSEM1800PCM	18,000	.7087	1
KSEM1850PCM	18,500	.7283	2
KSEM1900PCM	19,000	.7480	2
KSEM1950PCM	19,500	.7677	2
KSEM2000PCM	20,000	.7874	3
KSEM2050PCM	20,500	.8071	3
KSEM2100PCM	21,000	.8268	3
KSEM2150PCM	21,500	.8460	3
KSEM2200PCM	22,000	.8661	3



- first choice
- alternate choice

KC7135	D1		seat size
	mm	in	
KSEM2250PCM	22,500	.8858	4
KSEM2300PCM	23,000	.9055	4
KSEM2350PCM	23,500	.9252	4
KSEM2400PCM	24,000	.9449	4
KSEM2450PCM	24,500	.9646	5
KSEM2500PCM	25,000	.9843	5
KSEM2550PCM	25,500	1.0039	5
KSEM2600PCM	26,000	1.0236	5
KSEM2650PCM	26,500	1.0433	6
KSEM2700PCM	27,000	1.0630	6
KSEM2800PCM	28,000	1.1024	6
KSEM2850PCM	28,500	1.1220	7
KSEM2900PCM	29,000	1.1417	7
KSEM2950PCM	29,500	1.1614	7
KSEM3000PCM	30,000	1.1811	7
KSEM3050PCM	30,500	1.2008	8
KSEM3100PCM	31,000	1.2205	8
KSEM3200PCM	32,000	1.2598	8
KSEM3300PCM	33,000	1.2992	9
KSEM3400PCM	34,000	1.3386	9
KSEM3500PCM	35,000	1.3780	9
KSEM3600PCM	36,000	1.4173	9
KSEM3700PCM	37,000	1.4567	10
KSEM3800PCM	38,000	1.4961	10
KSEM3900PCM	39,000	1.5354	10
KSEM4000PCM	40,000	1.5748	10

Tolerance PC • Metric

D1 metric	tolerance k7
12,5-18	+0,001/+0,019
>18-30	+0,002/+0,023
>30-40	+0,002/+0,027

■ Modular Drill Carbide Insert Blades • KSEM™ • PC Geometry • Grade KC7135™ • Through Coolant • Metric

Material Group	Cutting Speed – vc			Metric						
	Range – m/min			Recommended Feed Rate (f) by Diameter						
	min	Starting Value	max		12,5	16,0	20,0	25,4	32,0	
P	1	90	100	110	mm/r	0,14–0,23	0,17–0,25	0,19–0,29	0,23–0,38	0,26–0,43
	2	80	90	100	mm/r	0,17–0,23	0,19–0,25	0,22–0,29	0,29–0,38	0,32–0,43
	3	55	65	75	mm/r	0,14–0,20	0,15–0,23	0,17–0,25	0,23–0,34	0,26–0,38
	4	50	60	70	mm/r	0,11–0,20	0,13–0,23	0,14–0,25	0,18–0,34	0,21–0,38
	5	45	50	60	mm/r	0,08–0,11	0,10–0,13	0,11–0,14	0,14–0,18	0,15–0,20
	6	45	55	65	mm/r	0,11–0,17	0,13–0,18	0,14–0,20	0,18–0,28	0,21–0,31
K	1	60	60	90	mm/r	0,08–0,24	0,09–0,28	0,11–0,31	0,14–0,43	0,15–0,48
	2	60	60	75	mm/r	0,18–0,24	0,21–0,28	0,23–0,31	0,28–0,37	0,32–0,42
	3	40	40	75	mm/r	0,15–0,24	0,18–0,26	0,21–0,29	0,23–0,37	0,25–0,42



Modular Drills

- Use designated insert blade with each drill body.
- For alternatives, see insert blade fitment chart on page H68–H69.
- Drill shipped with central lock screw, wrench, and side pipe plug.
- Order insert blade separately; see pages H38–H57.



Modular Drills

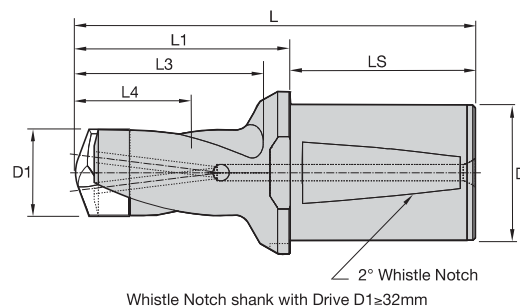
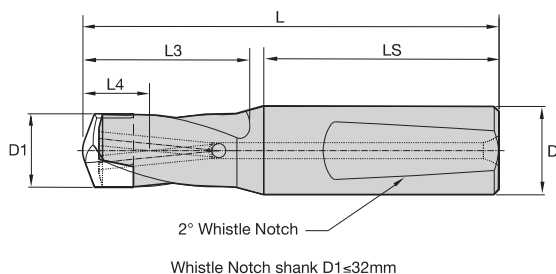

■ KSEM WN/WD50 Shank • 1 x D • Metric

1 x D	D1		D1 max		L	L1	L4 max	L5	LS	D	seat size	central lock screw	wrench
	mm	in	mm	in									
KSEM125R1WN16M	12,500	.4921	13,500	.5314	78	—	14	2,0	48	16	C	364.017	170.294
KSEM136R1WN16M	13,510	.5319	14,500	.5708	81	—	15	2,2	48	16	B	364.016	170.289
KSEM146R1WN20M	14,510	.5713	15,874	.6249	85	—	16	2,3	50	20	A	364.016	170.289
KSEM160R1WN20M	16,000	.6299	18,000	.7086	88	—	18	2,5	50	20	1	364.010	170.270
KSEM181R1WN25M	18,010	.7091	19,999	.7873	99	—	20	2,9	56	25	2	364.010	170.270
KSEM200R1WN25M	20,000	.7874	22,000	.8661	102	—	22	3,2	56	25	3	364.011	170.272
KSEM221R1WN25M	22,010	.8665	24,000	.9448	107	—	24	3,5	56	25	4	364.011	170.272
KSEM241R1WN32M	24,010	.9453	26,000	1.0236	115	—	26	3,8	60	32	5	364.012	170.274
KSEM261R1WN32M	26,010	1.0240	28,000	1.1023	119	—	28	4,0	60	32	6	364.012	170.274
KSEM281R1WN32M	28,016	1.1030	30,000	1.1811	123	—	30	4,3	60	32	7	364.013	170.276
KSEM301R1WN32M	30,010	1.1815	32,000	1.2598	127	—	32	4,6	60	32	8	364.013	170.276
KSEM321R1WD50M	32,010	1.2602	36,000	1.4173	147	79	36	4,9	68	50	9	364.015	170.276
KSEM361R1WD50M	36,010	1.4177	40,000	1.5748	155	87	40	5,5	68	50	10	364.015	170.276



- Use designated insert blade with each drill body.
- For alternatives, see insert blade fitment chart on page H68–H69.
- Drill shipped with central lock screw, wrench, and side pipe plug.
- Order insert blade separately; see pages H38–H57.

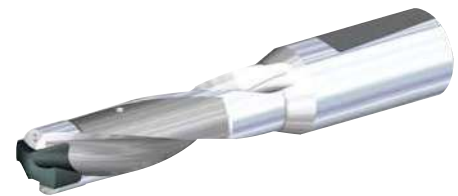
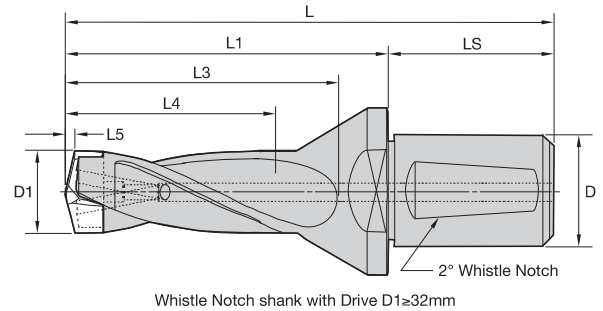
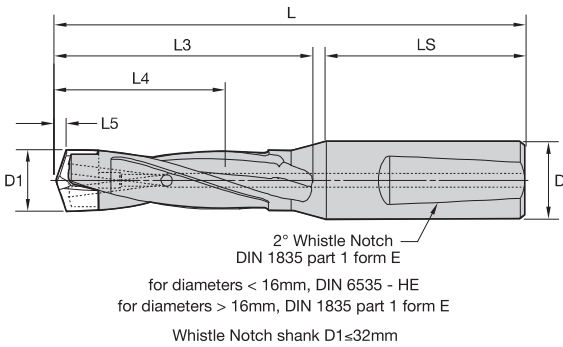

■ KSEM WN/WD50 Shank • 3 x D/5 x D • Metric

3 x D	5 x D	D1		D1 max		L5	LS	D	seat size	central lock screw
		mm	in	mm	in					
KSEM125R3WN16M	KSEM125R5WN16M	12,500	.4921	13,000	.5118	2,0	48	16	C	364.017
KSEM130R3WN16M	KSEM130R5WN16M	13,000	.5118	13,500	.5314	2,1	48	16	C	364.017
KSEM135R3WN16M	KSEM135R5WN16M	13,500	.5315	13,500	.5314	2,1	48	16	C	364.017
KSEM136R3WN16M	KSEM136R5WN16M	13,510	.5319	14,000	.5512	2,2	48	16	B	364.016
KSEM140R3WN16M	KSEM140R5WN16M	14,000	.5512	14,500	.5708	2,2	48	16	B	364.016
KSEM145R3WN20M	KSEM145R5WN20M	14,500	.5709	14,500	.5708	2,3	50	20	B	364.016
KSEM146R3WN20M	KSEM146R5WN20M	14,510	.5713	15,000	.5906	2,3	50	20	A	364.016
KSEM150R3WN20M	KSEM150R5WN20M	15,000	.5906	15,500	.6102	2,4	50	20	A	364.016
KSEM155R3WN20M	KSEM155R5WN20M	15,500	.6102	15,874	.6249	2,5	50	20	A	364.016
KSEM160R3WN20M	KSEM160R5WN20M	16,000	.6299	16,500	.6496	2,5	50	20	1	364.010
KSEM165R3WN20M	KSEM165R5WN20M	16,500	.6496	17,000	.6693	2,6	50	20	1	364.010
KSEM170R3WN20M	KSEM170R5WN20M	17,000	.6693	17,500	.6890	2,7	50	20	1	364.010
KSEM175R3WN20M	KSEM175R5WN20M	17,500	.6890	18,000	.7086	2,8	50	20	1	364.010
KSEM180R3WN20M	KSEM180R5WN20M	18,000	.7087	18,000	.7086	2,9	50	20	1	364.010
—	KSEM181R5WN25M	18,010	.7091	18,500	.7283	2,9	56	25	2	364.010
KSEM185R3WN25M	KSEM185R5WN25M	18,500	.7283	19,000	.7480	2,9	56	25	2	364.010
KSEM190R3WN25M	KSEM190R5WN25M	19,000	.7480	19,500	.7677	3,0	56	25	2	364.010
KSEM195R3WN25M	KSEM195R5WN25M	19,500	.7677	19,999	.7873	3,1	56	25	2	364.010
KSEM200R3WN25M	KSEM200R5WN25M	20,000	.7874	20,500	.8071	3,2	56	25	3	364.011
KSEM205R3WN25M	KSEM205R5WN25M	20,500	.8071	21,000	.8268	3,3	56	25	3	364.011
KSEM210R3WN25M	KSEM210R5WN25M	21,000	.8268	21,500	.8465	3,3	56	25	3	364.011
KSEM215R3WN25M	KSEM215R5WN25M	21,500	.8465	22,000	.8661	3,4	56	25	3	364.011
KSEM220R3WN25M	KSEM220R5WN25M	22,000	.8661	22,000	.8661	3,5	56	25	3	364.011
—	KSEM221R5WN25M	22,010	.8665	22,500	.8858	3,5	56	25	4	364.011

(continued)



Modular Drills

KSEM™ 2° Whistle Notch Shank Bodies





(KSEM WN/WD50 Shank • 3 x D/5 x D • Metric — continued)

Modular Drills

			D1		D1 max		L5	LS	D	seat size	central lock screw
	3 x D	5 x D	mm	in	mm	in					
											
KSEM225R3WN25M	KSEM225R5WN25M	22,500	.8858	23,000	.9055	3,6	56	25	4	364.011	
KSEM230R3WN25M	KSEM230R5WN25M	23,000	.9055	23,500	.9252	3,7	56	25	4	364.011	
KSEM235R3WN25M	KSEM235R5WN25M	23,500	.9252	24,000	.9448	3,7	56	25	4	364.011	
KSEM240R3WN25M	KSEM240R5WN25M	24,000	.9449	24,000	.9448	3,8	56	25	4	364.011	
—	KSEM241R5WN32M	24,010	.9453	24,500	.9646	3,8	60	32	5	364.012	
KSEM245R3WN32M	KSEM245R5WN32M	24,500	.9646	25,000	.9843	3,9	60	32	5	364.012	
KSEM250R3WN32M	KSEM250R5WN32M	25,000	.9843	25,500	1.0039	3,8	60	32	5	364.012	
KSEM255R3WN32M	KSEM255R5WN32M	25,500	1.0039	26,000	1.0236	3,9	60	32	5	364.012	
KSEM260R3WN32M	KSEM260R5WN32M	26,000	1.0236	26,000	1.0236	4,0	60	32	5	364.012	
—	KSEM261R5WN32M	26,010	1.0240	26,500	1.0433	4,0	60	32	6	364.012	
KSEM265R3WN32M	KSEM265R5WN32M	26,500	1.0433	27,000	1.0630	4,1	60	32	6	364.012	
KSEM270R3WN32M	KSEM270R5WN32M	27,000	1.0630	27,500	1.0827	4,2	60	32	6	364.012	
KSEM275R3WN32M	KSEM275R5WN32M	27,500	1.0827	28,000	1.1023	4,2	60	32	6	364.012	
KSEM280R3WN32M	KSEM280R5WN32M	28,000	1.1024	28,000	1.1023	4,3	60	32	6	364.012	
—	KSEM281R5WN32M	28,016	1.1030	28,500	1.1220	4,3	60	32	7	364.013	
KSEM285R3WN32M	KSEM285R5WN32M	28,500	1.1220	29,000	1.1417	4,4	60	32	7	364.013	
KSEM290R3WN32M	KSEM290R5WN32M	29,000	1.1417	29,500	1.1614	4,5	60	32	7	364.013	
KSEM295R3WN32M	KSEM295R5WN32M	29,500	1.1614	30,000	1.1811	4,5	60	32	7	364.013	
KSEM300R3WN32M	KSEM300R5WN32M	30,000	1.1811	30,000	1.1811	4,6	60	32	7	364.013	
—	KSEM301R5WN32M	30,010	1.1815	30,500	1.2008	4,6	60	32	8	364.013	
KSEM305R3WN32M	KSEM305R5WN32M	30,500	1.2008	31,000	1.2205	4,7	60	32	8	364.013	
KSEM310R3WN32M	KSEM310R5WN32M	31,000	1.2205	31,500	1.2402	4,8	60	32	8	364.013	
KSEM315R3WN32M	KSEM315R5WN32M	31,500	1.2402	32,000	1.2598	4,8	60	32	8	364.013	
KSEM320R3WN32M	KSEM320R5WN32M	32,000	1.2598	32,000	1.2598	4,9	60	32	8	364.013	
KSEM321R3WD50M	KSEM321R5WD50M	32,010	1.2602	33,000	1.2992	4,9	68	50	9	364.015	
KSEM330R3WD50M	KSEM330R5WD50M	33,000	1.2992	34,000	1.3386	5,1	68	50	9	364.015	
KSEM340R3WD50M	KSEM340R5WD50M	34,000	1.3386	35,000	1.3780	5,2	68	50	9	364.015	
KSEM350R3WD50M	KSEM350R5WD50M	35,000	1.3780	36,000	1.4173	5,4	68	50	9	364.015	
KSEM360R3WD50M	KSEM360R5WD50M	36,000	1.4173	36,000	1.4173	5,5	68	50	9	364.015	
KSEM361R3WD50M	KSEM361R5WD50M	36,010	1.4177	37,000	1.4567	5,5	68	50	10	364.015	
KSEM370R3WD50M	KSEM370R5WD50M	37,000	1.4567	38,000	1.4961	5,7	68	50	10	364.015	
KSEM380R3WD50M	KSEM380R5WD50M	38,000	1.4961	39,000	1.5354	5,8	68	50	10	364.015	
KSEM390R3WD50M	KSEM390R5WD50M	39,000	1.5354	40,000	1.5748	6,0	68	50	10	364.015	
KSEM400R3WD50M	KSEM400R5WD50M	40,000	1.5748	40,000	1.5748	6,2	68	50	10	364.015	



■ KSEM WD40 Shank • 3 x D/5 x D • Metric

			D1		L5	LS	D	seat size	central lock screw
	3 x D	5 x D	mm	in					
									
KSEM321R3WD40M	KSEM321R5WD40M	32,010	1.2602	5,6	68	40	9	364.015	
KSEM330R3WD40M	KSEM330R5WD40M	33,000	1.2992	5,8	68	40	9	364.015	
KSEM340R3WD40M	KSEM340R5WD40M	34,000	1.3386	6,0	68	40	9	364.015	
KSEM350R3WD40M	KSEM350R5WD40M	35,000	1.3780	6,1	68	40	9	364.015	
KSEM360R3WD40M	KSEM360R5WD40M	36,000	1.4173	6,3	68	40	9	364.015	
KSEM361R3WD40M	KSEM361R5WD40M	36,010	1.4177	6,3	68	40	10	364.015	
KSEM370R3WD40M	KSEM370R5WD40M	37,000	1.4567	6,5	68	40	10	364.015	
KSEM380R3WD40M	KSEM380R5WD40M	38,000	1.4961	6,7	68	40	10	364.015	
KSEM390R3WD40M	KSEM390R5WD40M	39,000	1.5354	6,9	68	40	10	364.015	
KSEM400R3WD40M	KSEM400R5WD40M	40,000	1.5748	7,0	68	40	10	364.015	



- Use designated insert blade with each drill body.
- For alternatives, see insert blade fitment chart on page H68–H69.
- Drill shipped with central lock screw, wrench, and side pipe plug.
- Order insert blade separately; see pages H38–H57.

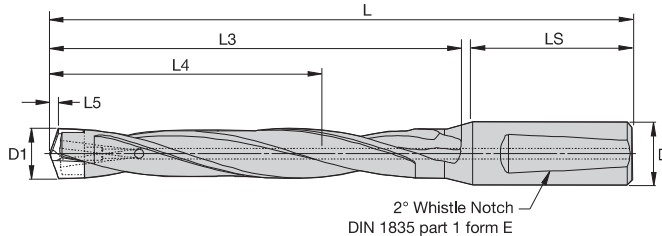

for diameter <16mm DIN 6535 — HE
for diameter >16mm DIN 1835 part 1 form E
For information on L, L3, and L4 max, see the Modular Drills Dimension Tables on page H72–H73.



■ KSEM WN Shank • 7 x D/10 x D • Metric



7 x D	10 x D	D1		D1 max		L5	LS	D	seat size	central lock screw
		mm	in	mm	in					
KSEM125R7WN16M	KSEM125R10WN16M	12,500	.4921	13,000	.5118	2,0	48	16	C	364.017
KSEM130R7WN16M	KSEM130R10WN16M	13,000	.5118	13,500	.5314	2,1	48	16	C	364.017
KSEM135R7WN16M	KSEM135R10WN16M	13,500	.5315	13,500	.5314	2,1	48	16	C	364.017
KSEM136R7WN16M	KSEM136R10WN16M	13,510	.5319	14,000	.5512	2,2	48	16	B	364.016
KSEM140R7WN16M	KSEM140R10WN16M	14,000	.5512	14,500	.5708	2,2	48	16	B	364.016
KSEM145R7WN20M	KSEM145R10WN20M	14,500	.5709	14,500	.5708	2,3	50	20	B	364.016
KSEM146R7WN20M	KSEM146R10WN20M	14,510	.5713	15,000	.5906	2,3	50	20	A	364.016
KSEM150R7WN20M	KSEM150R10WN20M	15,000	.5906	15,500	.6102	2,4	50	20	A	364.016
KSEM155R7WN20M	KSEM155R10WN20M	15,500	.6102	15,874	.6249	2,5	50	20	A	364.016
KSEM160R7WN20M	KSEM160R10WN20M	16,000	.6299	16,500	.6496	2,5	50	20	1	364.010
KSEM165R7WN20M	KSEM165R10WN20M	16,500	.6496	17,000	.6693	2,6	50	20	1	364.010
KSEM170R7WN20M	KSEM170R10WN20M	17,000	.6693	17,500	.6890	2,7	50	20	1	364.010
KSEM175R7WN20M	KSEM175R10WN20M	17,500	.6890	18,000	.7086	2,8	50	20	1	364.010
KSEM180R7WN20M	KSEM180R10WN20M	18,000	.7087	18,000	.7086	2,9	50	20	1	364.010
—	KSEM181R10WN25M	18,010	.7091	18,500	.7283	2,9	56	25	2	364.010
KSEM185R7WN25M	KSEM185R10WN25M	18,500	.7283	19,000	.7480	2,9	56	25	2	364.010
KSEM190R7WN25M	KSEM190R10WN25M	19,000	.7480	19,500	.7677	3,0	56	25	2	364.010
KSEM195R7WN25M	KSEM195R10WN25M	19,500	.7677	19,999	.7873	3,1	56	25	2	364.010
KSEM200R7WN25M	KSEM200R10WN25M	20,000	.7874	20,500	.8071	3,2	56	25	3	364.011
KSEM205R7WN25M	KSEM205R10WN25M	20,500	.8071	21,000	.8268	3,3	56	25	3	364.011
KSEM210R7WN25M	KSEM210R10WN25M	21,000	.8268	21,500	.8465	3,3	56	25	3	364.011
KSEM215R7WN25M	KSEM215R10WN25M	21,500	.8465	22,000	.8661	3,4	56	25	3	364.011
KSEM220R7WN25M	KSEM220R10WN25M	22,000	.8661	22,000	.8661	3,5	56	25	3	364.011
—	KSEM221R10WN25M	22,010	.8665	22,500	.8858	3,5	56	25	4	364.011
KSEM225R7WN25M	KSEM225R10WN25M	22,500	.8858	23,000	.9055	3,6	56	25	4	364.011
KSEM230R7WN25M	KSEM230R10WN25M	23,000	.9055	23,500	.9252	3,7	56	25	4	364.011
KSEM235R7WN25M	KSEM235R10WN25M	23,500	.9252	24,000	.9448	3,7	56	25	4	364.011
KSEM240R7WN25M	KSEM240R10WN25M	24,000	.9449	24,000	.9448	3,8	56	25	4	364.011
—	KSEM241R10WN32M	24,010	.9453	24,500	.9646	3,8	60	32	5	364.012
KSEM245R7WN32M	KSEM245R10WN32M	24,500	.9646	25,000	.9843	3,9	60	32	5	364.012
KSEM250R7WN32M	KSEM250R10WN32M	25,000	.9843	25,500	1.0039	3,8	60	32	5	364.012
KSEM255R7WN32M	KSEM255R10WN32M	25,500	1.0039	26,000	1.0236	3,9	60	32	5	364.012

(continued)

Modular Drills

KSEM™ 2° Whistle Notch Shank Bodies



(KSEM WN Shank • 7 x D/10 x D • Metric — continued)



Modular Drills

	7 x D	10 x D	D1		D1 max		L5	LS	D	seat size	central lock screw
			mm	in	mm	in					
	KSEM260R7WN32M	KSEM260R10WN32M	26,000	1.0236	26,000	1.0236	4,0	60	32	5	364.012
	—	KSEM261R10WN32M	26,010	1.0240	26,500	1.0433	4,0	60	32	6	364.012
	KSEM265R7WN32M	KSEM265R10WN32M	26,500	1.0433	27,000	1.0630	4,1	60	32	6	364.012
	KSEM270R7WN32M	KSEM270R10WN32M	27,000	1.0630	27,500	1.0827	4,2	60	32	6	364.012
	KSEM275R7WN32M	KSEM275R10WN32M	27,500	1.0827	28,000	1.1023	4,2	60	32	6	364.012
	KSEM280R7WN32M	KSEM280R10WN32M	28,000	1.1024	28,000	1.1023	4,3	60	32	6	364.012
	—	KSEM281R10WN32M	28,016	1.1030	28,500	1.1220	4,3	60	32	7	364.013
	KSEM285R7WN32M	KSEM285R10WN32M	28,500	1.1220	29,000	1.1417	4,4	60	32	7	364.013
	KSEM290R7WN32M	KSEM290R10WN32M	29,000	1.1417	29,500	1.1614	4,5	60	32	7	364.013
	KSEM295R7WN32M	KSEM295R10WN32M	29,500	1.1614	30,000	1.1811	4,5	60	32	7	364.013
	KSEM300R7WN32M	KSEM300R10WN32M	30,000	1.1811	30,000	1.1811	4,6	60	32	7	364.013
	—	KSEM301R10WN32M	30,010	1.1815	30,500	1.2008	4,6	60	32	8	364.013
	KSEM305R7WN32M	—	30,500	1.2008	31,000	1.2205	4,7	60	32	8	364.013
	KSEM310R7WN32M	KSEM310R10WN32M	31,000	1.2205	31,500	1.2402	4,8	60	32	8	364.013
	KSEM315R7WN32M	—	31,500	1.2402	32,000	1.2598	4,8	60	32	8	364.013
	KSEM320R7WN32M	KSEM320R10WN32M	32,000	1.2598	32,000	1.2598	4,9	60	32	8	364.013

- The NEW chamfering rings for KSEM are available in a diameter range of 12,5–32mm.
- The KSEM SEF ring is double-edged, features a more rigid design to withstand high feed rates, and reduces time-consuming deburring and small chamfer operations.
- Reduce machining time – combine drilling and chamfering in one operation.
- Short-term availability – standard tooling off-the-shelf – KSEM body and inserts, SEF ring, and SEFAS™ inserts.
- Flexibility – adjustable drilling depth.

- For speed and feed recommendations, please refer to catalogue recommendations based on geometry and tool body length of the carrying KSEM tool.
- Small chamfers up to 1mm do not need further feed reduction.
- At deeper chamfers, a feed rate reduction of 50% is highly recommended to avoid vibrations and movement of the ring during operation.
- For inserts, please refer to SEFAS System.



Modular Drills

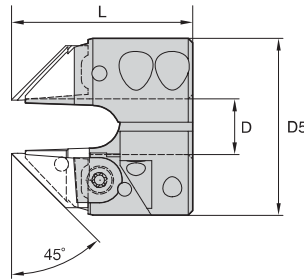

■ KSEM Chamfer Rings



catalogue number	D		L		D5		clamp assembly	chip deflector	chip deflector screw	drill clamp screw
	mm	in	mm	in	mm	in				
KSEM125SEFM	12,5	.4921	40	1.57	39	1.54	360.551	360.660	128.508	191.726
KSEM130SEFM	13,0	.5118	40	1.57	39	1.54	360.551	360.660	128.508	191.726
KSEM135SEFM	13,5	.5315	40	1.57	39	1.54	360.551	360.660	128.508	191.726
KSEM140SEFM	14,0	.5512	40	1.57	40	1.57	360.551	360.661	128.508	199.123
KSEM145SEFM	14,5	.5709	40	1.57	40	1.57	360.551	360.661	128.508	199.123
KSEM150SEFM	15,0	.5906	40	1.57	40	1.57	360.551	360.662	128.508	199.123
KSEM155SEFM	15,5	.6102	40	1.57	40	1.57	360.551	360.662	128.508	199.123
KSEM160SEFM	16,0	.6299	42	1.65	43	1.69	360.551	360.663	128.508	199.123
KSEM165SEFM	16,5	.6496	42	1.65	43	1.69	360.551	360.663	128.508	199.123
KSEM170SEFM	17,0	.6693	42	1.65	43	1.69	360.551	360.663	128.508	199.123
KSEM175SEFM	17,5	.6890	42	1.65	43	1.69	360.551	360.663	128.508	199.123
KSEM180SEFM	18,0	.7087	42	1.65	43	1.69	360.551	360.663	128.508	199.123
KSEM185SEFM	18,5	.7283	42	1.65	43	1.69	360.551	360.664	128.508	199.123
KSEM190SEFM	19,0	.7480	42	1.65	43	1.69	360.551	360.664	128.508	199.123
KSEM195SEFM	19,5	.7677	42	1.65	43	1.69	360.551	360.664	128.508	199.123
KSEM200SEFM	20,0	.7874	48	1.89	50	1.97	360.551	360.665	128.510	199.123
KSEM205SEFM	20,5	.8071	48	1.89	50	1.97	360.551	360.665	128.510	199.123
KSEM210SEFM	21,0	.8268	48	1.89	50	1.97	360.551	360.665	128.510	199.123
KSEM215SEFM	21,5	.8465	48	1.89	50	1.97	360.551	360.665	128.510	199.123
KSEM220SEFM	22,0	.8661	48	1.89	50	1.97	360.551	360.665	128.510	199.123
KSEM225SEFM	22,5	.8858	50	1.97	50	1.97	360.551	360.666	128.510	—
KSEM230SEFM	23,0	.9055	50	1.97	50	1.97	360.551	360.666	128.510	—
KSEM235SEFM	23,5	.9252	50	1.97	50	1.97	360.551	360.666	128.510	—
KSEM240SEFM	24,0	.9449	50	1.97	50	1.97	360.551	360.666	128.510	—
KSEM245SEFM	24,5	.9646	54	2.13	55	2.17	360.551	360.667	128.510	—
KSEM250SEFM	25,0	.9843	54	2.13	55	2.17	360.551	360.667	128.510	—
KSEM255SEFM	25,5	1.0039	54	2.13	55	2.17	360.551	360.667	128.510	—
KSEM260SEFM	26,0	1.0236	54	2.13	55	2.17	360.551	360.667	128.510	—
KSEM265SEFM	26,5	1.0433	56	2.20	55	2.17	360.551	360.668	128.510	—
KSEM270SEFM	27,0	1.0630	56	2.20	55	2.17	360.551	360.668	128.510	—
KSEM275SEFM	27,5	1.0827	56	2.20	55	2.17	360.551	360.668	128.510	—
KSEM280SEFM	28,0	1.1024	56	2.20	55	2.17	360.551	360.668	128.510	—
KSEM285SEFM	28,5	1.1220	61	2.40	60	2.36	360.551	360.669	128.510	—
KSEM290SEFM	29,0	1.1417	61	2.40	60	2.36	360.551	360.669	128.510	—
KSEM295SEFM	29,5	1.1614	61	2.40	60	2.36	360.551	360.669	128.510	—
KSEM300SEFM	30,0	1.1811	61	2.40	60	2.36	360.551	360.669	128.510	—
KSEM305SEFM	30,5	1.2008	61	2.40	60	2.36	360.551	360.670	128.510	—
KSEM310SEFM	31,0	1.2205	61	2.40	60	2.36	360.551	360.670	128.510	—
KSEM315SEFM	31,5	1.2402	61	2.40	60	2.36	360.551	360.670	128.510	—
KSEM320SEFM	32,0	1.2598	61	2.40	60	2.36	360.551	360.670	128.510	—

NOTE: Order inserts separately; see the SEFAS system on page I27.

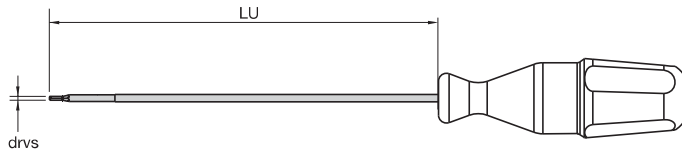

■ KSEM Wrenches

order number	catalogue number	central lock screw		DRVS	LU	
		D1<32mm	D1≥32mm		mm	in
1126021	170.270	364.010	—	1.5 mm	185,00	7
1126032	170.271	364.010	—	1.5 mm	225,00	9
1510773	170.281	364.010	—	1.5 mm	297,00	12
1255899	170.285	364.010	—	1.5 mm	351,00	14
1126040	170.272	364.011	—	2 mm	210,00	8
1126049	170.273	364.011	—	2 mm	260,00	10
1510776	170.282	364.011	—	2 mm	343,00	14
1255900	170.286	364.011	—	2 mm	405,00	16
1126066	170.274	364.012	—	2.5 mm	240,00	9
1126072	170.275	364.012	—	2.5 mm	295,00	12
1510779	170.283	364.012	—	2.5 mm	393,00	15
1255901	170.287	364.012	—	2.5 mm	459,00	18
1126079	170.276	364.101	364.015	3 mm	265,00	10
1126088	170.277	364.101	364.015	3 mm	330,00	13
1510781	170.284	364.101	364.015	3 mm	439,00	17
1255902	170.288	364.101	364.015	3 mm	513,00	20
1834819	170.294	364.017	—	T5	156,00	6
1836470	170.295	364.017	—	T5	188,00	7
1836471	170.296	364.017	—	T5	290,00	11
1795811	170.289	364.016	—	T6	156,00	6
1795956	170.290	364.016	—	T6	188,00	7
1795960	170.291	364.016	—	T6	290,00	11

Mounting the Inserts

1.

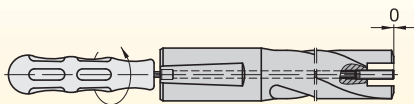

2.

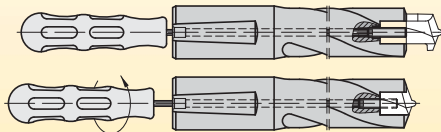

Inserts (<32mm) without Connector Pin

- 1) Use the screwdriver to set the threaded pin:
 - For inserts up to Ø 32mm, flush with the drill face.
 - For inserts bigger Ø 32mm, set 2mm below the drill face.
- 2) Tighten the insert using the screwdriver to fit securely in the insert seat.

To change the insert, turn the clamping screw anti-clockwise until the insert is released.

Repair of Damaged Threaded Pin

In the event that the central threaded pin becomes damaged, it can be removed after severing it in the tool body. To do this, drill beneath the insert seat in the tool body. The insert and threaded pin can then be removed. For information regarding the position and diameter of this repair hole, please refer to the manual (sheet 290.001 D/GB) supplied with the tool body.

NOTE: For inserts without a connector pin, avoid jamming during mounting through precise positioning.

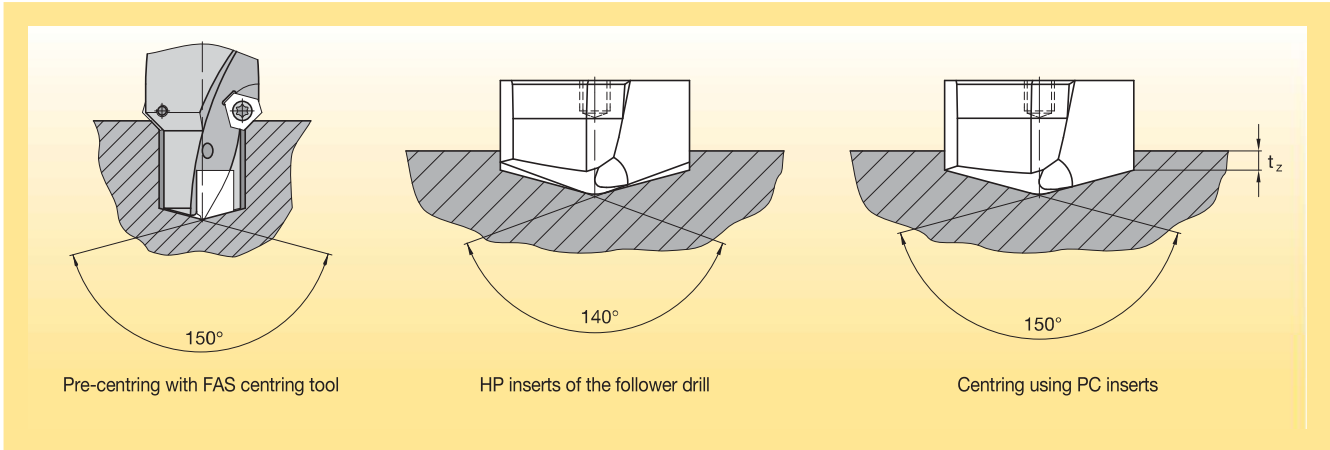

Why is pre-centring necessary?

- Generally speaking, for drilling depths 5x the nominal diameter and above (5 x D).
- In unstable conditions (workpiece and tool clamping).

Why pre-centre using PC inserts?

- Soft-cut entry of follower drill due to 150° point angle of the PC insert.
- No extension of the follower drill in the entry area.
- Prevent chipping and breaking on the cutting edges.
- To avoid deflection, it is recommended to pre-centre with PC inserts using toolholders as short as possible (1 x D).

What happens if...

...a centre cannot be used for technical reasons?

- Spot drill with normal insert at normal and reduced cutting data (approximately 1/2 vc and approximately 1/2 vf), then continue drilling with regular cutting data without lifting off/stopping.

...there is no suitable PC cutting insert in the standard range (ø)?

- Use a made-to-order PC insert with k7 tolerance in the required nominal diameter.

OR

- Pre-centre, using the same cutting insert as used for the follower drill but without the cutting edges penetrating the workpiece (spot drill ø approximately 90% of drill ø D1).

...only one tool body is required?

- Enter the workpiece with 50% feed until the cutting edges and the heels have penetrated the hole, then continue drilling without lifting off/stopping using regular cutting data.

Rotating Applications

KSEM inch drills with round shanks (no flats) are specifically designed for rotating applications where the drill rotates and the workpiece remains stationary. The shank to drill-point location of these drills is held to an extremely close tolerance. To maintain accuracy, and get maximum performance from the KSEM drill, use only the approved toolholding method shown below.

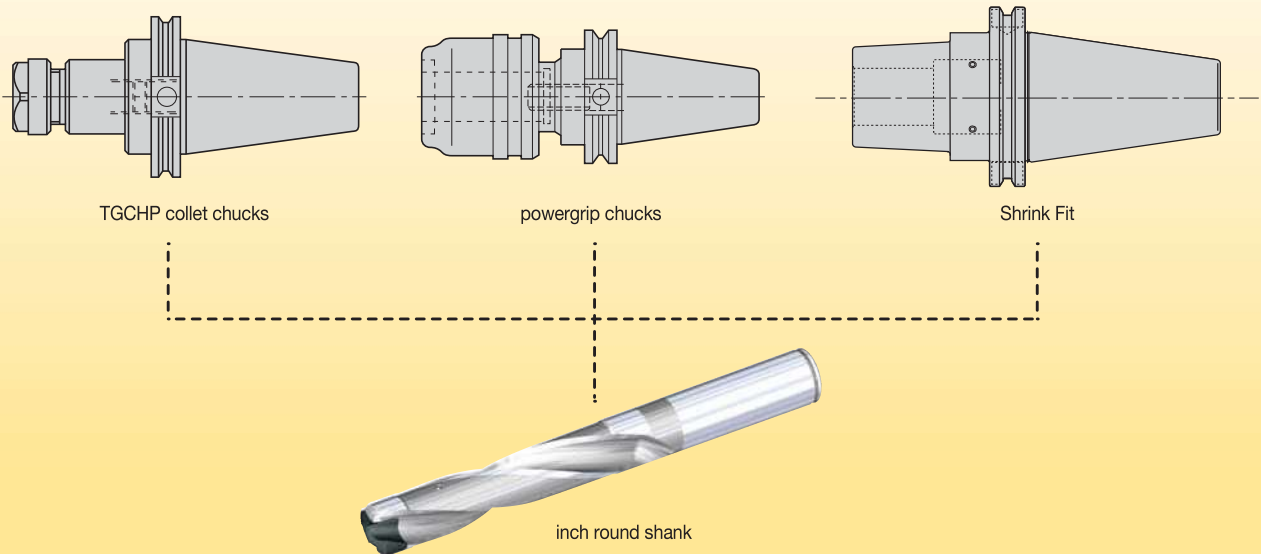

Inch Drill Bodies with Flange

KSEM inch drills with a flange can be used in rotating applications where the drill rotates and the workpiece remains stationary. To maintain accuracy and get maximum performance from the drill, use only the approved toolholding method shown here.

Metric Drill Bodies with a 2° Whistle Notch

KSEM metric drills come equipped with 2° Whistle Notch shanks. The 20mm, 25mm, and 32mm diameter shanks use WN adaptors. The 50mm shank uses a WD adaptor. Choose the correct adaptor to minimise runout and securely hold the drill.

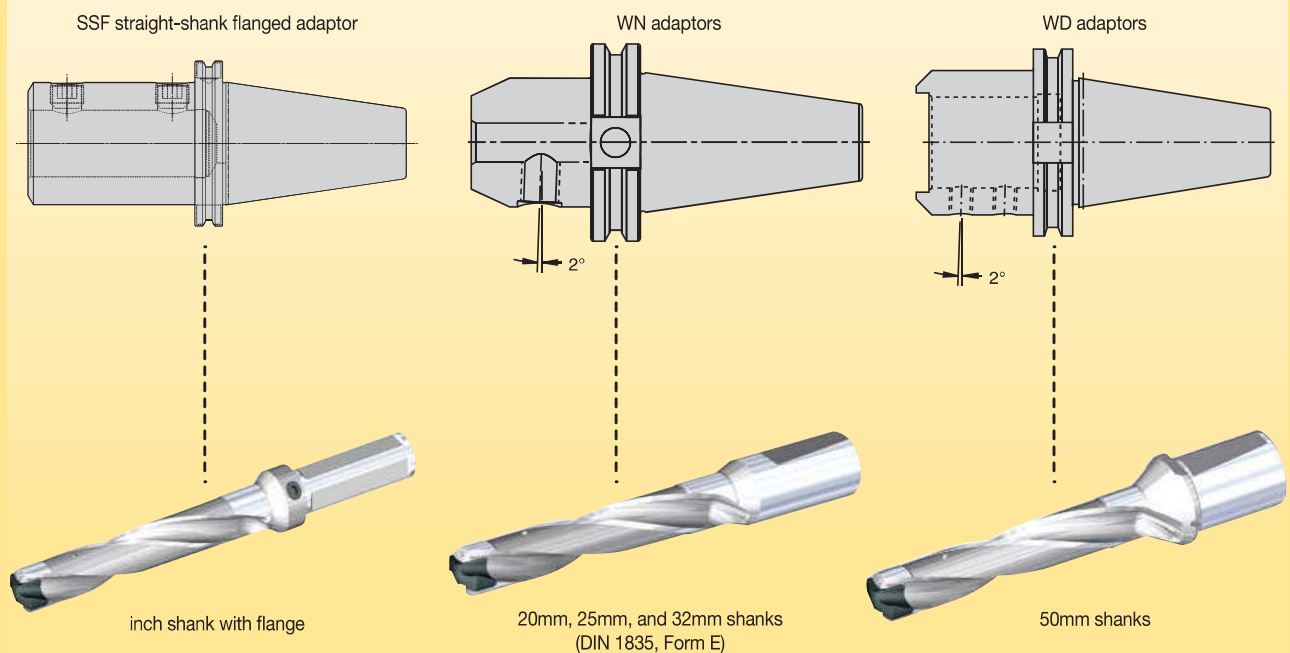

Insert blades may be used, within limits, on different drill bodies. The insert blade must be of the same seat size. Overhang (see Figure 1) must be kept under 0,250mm (.0098") per side. For best drilling performance, rigidity, and efficient chip evacuation, always use the first-choice steel body. Performance may be compromised by using alternatives. In some applications, chips may bind between the drill body and the hole wall — especially when machining long-chipping materials like austenitic stainless steel and low-carbon steel.

(does not apply to stub length drills)

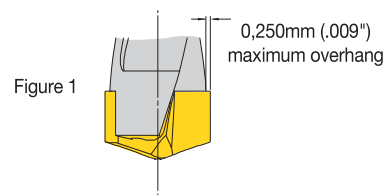

Figure 1

diameter D

inch	mm	insert blade	seat size	first choice	alternate body 1	alternate body 2	alternate body 3	alternate body 4
.492	12,50	KSEM1250	C	KSEM125..M	-	-	-	-
.500	12,70	KSEM0500	C	KSEM0500..	KSEM125..M	-	-	-
.509	12,93	KSEM0509	C	KSEM0509..	KSEM0500..	KSEM125..M	-	-
.512	13,00	KSEM1300	C	KSEM130..M	KSEM0509..	KSEM0500..	KSEM125..M	-
.516	13,10	KSEM0516	C	KSEM0516..	KSEM130..M	KSEM0509..	KSEM0500..	-
.531	13,50	KSEM1350	C	KSEM135..M	KSEM0531..	KSEM0516..	KSEM130..M	-
.547	13,89	KSEM0547	B	KSEM0547..	KSEM136..M	-	-	-
.551	14,00	KSEM1400	B	KSEM140..M	KSEM136..M	KSEM0547..	-	-
.563	14,29	KSEM0563	B	KSEM0563..	KSEM140..M	KSEM0547..	-	-
.571	14,50	KSEM1450	B	KSEM145..M	KSEM0563..	KSEM140..M	-	-
.578	14,68	KSEM0578	A	KSEM0578..	KSEM146..M	-	-	-
.591	15,00	KSEM1500	A	KSEM150..M	KSEM146..M	KSEM0578..	-	-
.594	15,08	KSEM0594	A	KSEM0594..	KSEM150..M	KSEM0578..	-	-
.609	15,48	KSEM0609	A	KSEM0609..	KSEM0594..	KSEM150..M	-	-
.610	15,50	KSEM1550	A	KSEM155..M	KSEM0609..	KSEM0594..	KSEM150..M	-
.625	15,88	KSEM0625	1	KSEM0625..	-	-	-	-
.630	16,00	KSEM1600	1	KSEM160..M	KSEM0625..	-	-	-
.634	16,09	KSEM0634	1	KSEM0634..	KSEM160..M	KSEM0625..	-	-
.641	16,27	KSEM0641	1	KSEM0641..	KSEM0634..	KSEM160..M	KSEM0625..	-
.650	16,50	KSEM1650	1	KSEM165..M	KSEM0641..	KSEM0634..	-	-
.656	16,67	KSEM0656	1	KSEM0656..	KSEM165..M	KSEM0641..	-	-
.669	17,00	KSEM1700	1	KSEM170..M	KSEM0656..	KSEM165..M	-	-
.672	17,07	KSEM0672	1	KSEM0672..	KSEM170..M	KSEM0656..	-	-
.688	17,46	KSEM0688	1	KSEM0688..	KSEM0672..	KSEM170..M	-	-
.689	17,50	KSEM1750	1	KSEM175..M	KSEM0688..	KSEM0672..	KSEM170..M	-
.700	17,78	KSEM0700	1	N/A	KSEM175..M	KSEM0688..	-	-
.703	17,86	KSEM0703	1	KSEM0703..	KSEM175..M	KSEM0688..	-	-
.709	18,00	KSEM1800	1	KSEM180..M	KSEM0703..	KSEM175..M	-	-
.719	18,26	KSEM0719	2	KSEM0719..	KSEM181..M	-	-	-
.728	18,50	KSEM1850	2	KSEM185..M	KSEM0719..	KSEM181..M	-	-
.734	18,65	KSEM0734	2	KSEM0734..	KSEM185..M	KSEM0719..	-	-
.748	19,00	KSEM1900	2	KSEM190..M	KSEM0734..	KSEM185..M	-	-
.750	19,05	KSEM0750	2	KSEM0750..	KSEM190..M	KSEM0734..	-	-
.759	19,27	KSEM0759	2	KSEM0759..	KSEM0750..	KSEM190..M	-	-
.766	19,45	KSEM0766	2	KSEM0766..	KSEM0759..	KSEM0750..	KSEM190..M	-
.768	19,50	KSEM1950	2	KSEM195..M	KSEM0766..	KSEM0759..	KSEM0750..	KSEM190..M
.781	19,84	KSEM0781	2	KSEM0781..	KSEM195..M	KSEM0766..	-	-
.787	20,00	KSEM2000	3	KSEM200..M	-	-	-	-
.797	20,24	KSEM0797	3	KSEM0797..	KSEM200..M	-	-	-
.800	20,32	KSEM0800	3	N/A	KSEM0797..	KSEM200..M	-	-
.807	20,50	KSEM2050	3	KSEM205..M	KSEM0797..	KSEM200..M	-	-
.813	20,64	KSEM0813	3	KSEM0813..	KSEM205..M	KSEM0797..	-	-
.827	21,00	KSEM2100	3	KSEM210..M	KSEM0813..	KSEM205..M	-	-
.844	21,43	KSEM0844	3	KSEM0844..	KSEM210..M	-	-	-
.847	21,50	KSEM2150	3	KSEM215..M	KSEM0844..	KSEM210..M	-	-
.859	21,83	KSEM0859	3	KSEM0859..	KSEM215..M	KSEM0844..	-	-
.866	22,00	KSEM2200	3	KSEM220..M	KSEM0859..	KSEM215..M	-	-
.875	22,23	KSEM0875	4	KSEM0875..	KSEM221..M	-	-	-
.884	22,44	KSEM0884	4	KSEM0884..	KSEM0875..	KSEM221..M	-	-
.886	22,50	KSEM2250	4	KSEM225..M	KSEM0884..	KSEM0875..	KSEM221..M	-
.906	23,00	KSEM2300	4	KSEM230..M	KSEM0906..	KSEM225..M	-	-
.922	23,42	KSEM0922	4	KSEM0922..	KSEM230..M	-	-	-
.925	23,50	KSEM2350	4	KSEM235..M	KSEM0922..	KSEM230..M	-	-
.938	23,81	KSEM0938	4	KSEM0938..	KSEM235..M	KSEM0922..	-	-
.945	24,00	KSEM2400	4	KSEM240..M	KSEM0938..	KSEM235..M	-	-

(continued)

(continued)

diameter D		insert blade	seat size	first choice	alternate body 1	alternate body 2	alternate body 3	alternate body 4
inch	mm							
.965	24,50	KSEM2450	5	KSEM245..M	KSEM241..M	-	-	-
.969	24,61	KSEM0969	5	KSEM0969..	KSEM245..M	-	-	-
.984	25,00	KSEM2500	5	KSEM250..M	KSEM0984..	KSEM0969..	KSEM245..M	-
1.000	25,40	KSEM1000	5	KSEM1000..	KSEM250..M	-	-	-
1.004	25,50	KSEM2550	5	KSEM255..M	KSEM1000..	KSEM250..M	-	-
1.011	25,67	KSEM1011	5	KSEM1011..	KSEM255..M	-	-	-
1.024	26,00	KSEM2600	5	KSEM260..M	KSEM1011..	KSEM255..M	-	-
1.031	26,19	KSEM1031	6	KSEM1031..	KSEM261..M	-	-	-
1.043	26,50	KSEM2650	6	KSEM265..M	KSEM1031..	KSEM261..M	-	-
1.047	26,59	KSEM1047	6	KSEM1047..	KSEM265..M	KSEM1031..	KSEM261..M	-
1.063	27,00	KSEM2700	6	KSEM270..M	KSEM1063..	KSEM1047..	KSEM265..M	-
1.083	27,50	KSEM2750	6	KSEM275..M	KSEM270..M	KSEM1063..	-	-
1.094	27,78	KSEM1094	6	KSEM1094..	KSEM275..M	-	-	-
1.102	28,00	KSEM2800	6	KSEM280..M	KSEM1094..	KSEM275..M	-	-
1.109	28,18	KSEM1109	7	KSEM1109..	KSEM281..M	-	-	-
1.122	28,50	KSEM2850	7	KSEM285..M	KSEM1109..	KSEM281..M	-	-
1.125	28,58	KSEM1125	7	KSEM1125..	KSEM285..M	KSEM1109..	KSEM281..M	-
1.142	29,00	KSEM2900	7	KSEM290..M	KSEM1125..	KSEM285..M	-	-
1.156	29,37	KSEM1156	7	KSEM1156..	KSEM290..M	-	-	-
1.161	29,50	KSEM2950	7	KSEM295..M	KSEM1156..	KSEM290..M	-	-
1.172	29,77	KSEM1172	7	KSEM1172..	KSEM295..M	KSEM1156..	-	-
1.181	30,00	KSEM3000	7	KSEM300..M	KSEM1172..	KSEM295..M	-	-
1.188	30,16	KSEM1188	8	KSEM1188..	KSEM301..M	-	-	-
1.201	30,50	KSEM3050	8	KSEM305..M	KSEM1188..	KSEM301..M	-	-
1.203	30,56	KSEM1203	8	KSEM1203..	KSEM305..M	KSEM1188..	KSEM301..M	-
1.219	30,96	KSEM1219	8	KSEM1219..	KSEM1203..	KSEM305..M	-	-
1.220	31,00	KSEM3100	8	KSEM310..M	KSEM1219..	KSEM1203..	KSEM305..M	-
1.240	31,50	KSEM3150	8	KSEM315..M	KSEM310..M	-	-	-
1.250	31,75	KSEM1250	8	KSEM1250..	KSEM315..M	-	-	-
1.260	32,00	KSEM3200	8	KSEM320..M	KSEM1250..	KSEM315..M	-	-
1.280	32,50	KSEM3250	9	-	KSEM321..M	-	-	-
1.281	32,54	KSEM1281	9	KSEM1281..	KSEM321..M	-	-	-
1.297	32,94	KSEM1297	9	KSEM1297..	KSEM1281..	-	-	-
1.299	33,00	KSEM3300	9	KSEM330..M	KSEM1297..	KSEM1281..	-	-
1.313	33,34	KSEM1313	9	KSEM1313..	KSEM330..M	KSEM1297..	-	-
1.319	33,50	KSEM3350	9	-	-	KSEM1313..	KSEM330..M	-
1.328	33,73	KSEM1328	9	KSEM1328..	KSEM1313..	-	-	-
1.339	34,00	KSEM3400	9	KSEM340..M	KSEM1328..	-	-	-
1.344	34,13	KSEM1344	9	KSEM1344..	KSEM340..M	KSEM1328..	-	-
1.358	34,50	KSEM3450	9	-	-	KSEM1344..	KSEM340..M	-
1.375	34,93	KSEM1375	9	KSEM1375..	-	-	-	-
1.378	35,00	KSEM3500	9	KSEM350..M	KSEM1375..	-	-	-
1.398	35,50	KSEM3550	9	-	-	KSEM350..M	-	-
1.406	35,72	KSEM1406	9	KSEM1406..	-	-	-	-
1.417	36,00	KSEM3600	9	KSEM360..M	KSEM1406..	-	-	-
1.422	36,12	KSEM1422	10	KSEM1422..	KSEM361..M	-	-	-
1.437	36,50	KSEM3650	10	-	-	KSEM1422..	KSEM361..M	-
1.438	36,51	KSEM1438	10	KSEM1438..	KSEM1422..	KSEM361..M	-	-
1.457	37,00	KSEM3700	10	KSEM370..M	KSEM1438..	-	-	-
1.469	37,31	KSEM1469	10	KSEM1469..	KSEM370..M	-	-	-
1.476	37,50	KSEM3750	10	-	-	KSEM1469..	KSEM370..M	-
1.496	38,00	KSEM3800	10	KSEM380..M	-	-	-	-
1.500	38,10	KSEM1500	10	KSEM1500..	KSEM380..M	-	-	-
1.514	38,46	KSEM1514	10	KSEM1514..	KSEM1500..	KSEM380..M	-	-
1.516	38,50	KSEM3850	10	-	-	KSEM1514..	KSEM1500..	KSEM380..M
1.535	39,00	KSEM3900	10	KSEM390..M	-	-	-	-
1.555	39,50	KSEM3950	10	-	-	KSEM390..M	-	-
1.575	40,00	KSEM4000	10	KSEM400..M	-	-	-	-



Modular Drills

Drive Power (kW)

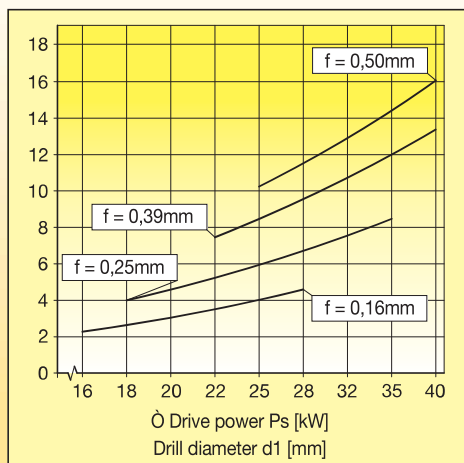

Feed Force (kN)

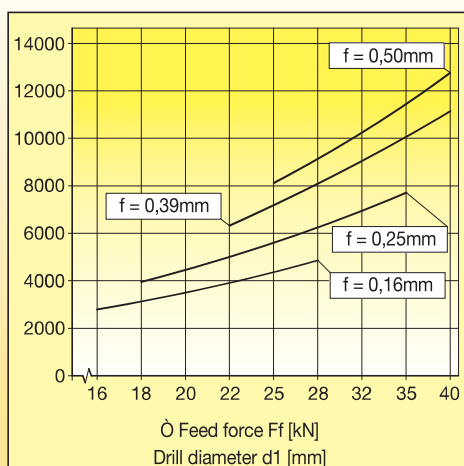

Torque (Nm)

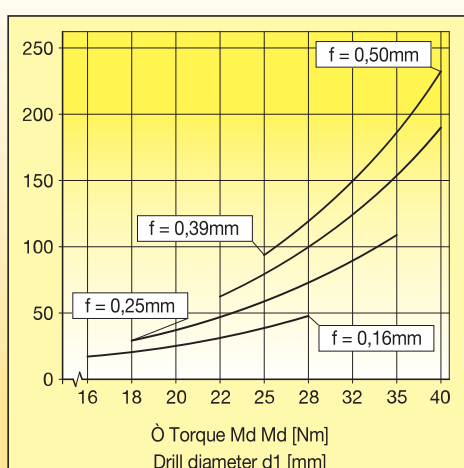

NOTE: The diagrams above are used to determine the drive power, feed force, and torque. They are based on cutting force measurement in tempered steels in Cgr. 6. Tensile strength: $R_m = 600 \text{ N/mm}^2$. The base cutting speed used is: $vc = 80 \text{ m/min}$.

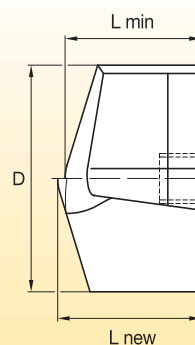

The following coolant pressure is recommended:

relative drilling depth	coolant pressure
1–3 x D	8 bars
5 x D	12 bars
7 x D	20 bars
10 x D	30 bars

insert seat size	diameter range D (mm)	L min. (mm)	L new (mm)
C	12,50–13,50	8,5	9,6
B	13,51–14,50	8,9	10,1
A	14,51–15,88	9,4	10,6
1	15,88–18,00	10,3	11,6
2	18,01–19,99	11,2	12,6
3	20,00–22,00	12,1	13,6
4	22,01–24,00	13,0	14,6
5	24,01–26,00	13,9	15,6
6	26,01–28,00	14,8	16,6
7	28,01–30,00	15,7	17,6
8	30,01–32,00	16,6	18,6
9	32,01–36,00	18,4	20,6
10	36,01–40,00	20,2	22,6

A Natural Fit...

Tube Sheet Finishing with Kennametal

Our advanced drilling and hole finishing solutions provide the performance and reliability you need to succeed in your challenging business. We offer a complete holemaking range for working with tube sheets, support baffles, and many other components.

RHR™ Reaming System

- For H7 fits in tube sheets.
- Very fast and economical with a replaceable head disc reamer.
- New KCU05 grade for a great finish and long tool life.

Find RHR Reamers on pages K24, K27–K28, and K36.

Experience the advantages at your Authorised Kennametal Distributor or at kennametal.com.



kennametal.com



Modular Drills • Dimension Tables

■ Dimensions for KSEM™ Whistle Notch Shank • WN/WD 3 x D to 10 x D • Metric

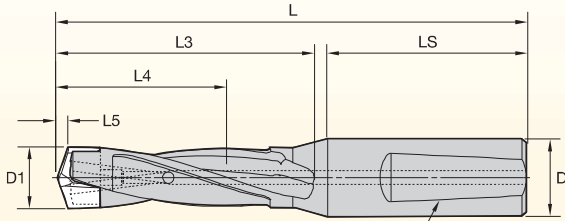

2° Whistle Notch
DIN 1835 part 1 form E
for diameters <math>< 16\text{mm}</math>, DIN 6535 - HE
for diameters >math>16\text{mm}</math>, DIN 1835 part 1 form E
Whistle Notch shank

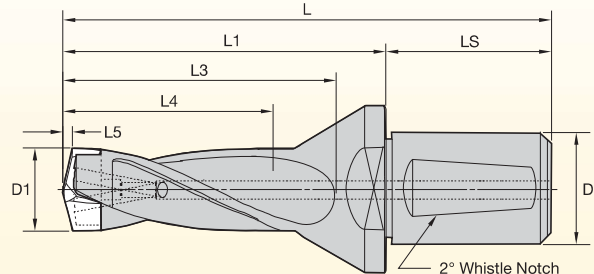

Whistle Notch shank with Drive

D1		WN/WD Shank Metric								WN Shank Metric					
		3 x D				5 x D				7 x D			10 x D		
mm	inch	L	L1	L4 max	wrench	L	L1	L4 max	wrench	L	L4 max	wrench	L	L4 max	wrench
12,50	.4921	111	—	42	170.294	139	—	70	170.294	167	98	170.295	195	125	170.296
13,00	.5118	111	—	42	170.294	139	—	70	170.294	167	98	170.295	200	130	170.296
13,50	.5315	111	—	42	170.294	139	—	70	170.294	167	98	170.295	205	135	170.296
13,51	.5319	111	—	42	170.289	139	—	70	170.289	167	98	170.290	205	135	170.291
14,00	.5512	111	—	42	170.289	139	—	70	170.289	167	98	170.290	210	140	170.291
14,50	.5709	122	—	48	170.289	154	—	80	170.289	186	112	170.290	220	145	170.291
14,51	.5713	122	—	48	170.289	154	—	80	170.289	186	112	170.290	220	145	170.291
15,00	.5906	122	—	48	170.289	154	—	80	170.289	186	112	170.290	225	150	170.291
15,50	.6102	122	—	48	170.289	154	—	80	170.289	186	112	170.290	230	155	170.291
16,00	.6299	122	—	48	170.270	154	—	80	170.270	186	112	170.270	234	160	170.271
16,50	.6496	130	—	54	170.270	166	—	90	170.270	202	126	170.271	241	165	170.281
17,00	.6693	130	—	54	170.270	166	—	90	170.270	202	126	170.271	246	170	170.281
17,50	.6890	130	—	54	170.270	166	—	90	170.270	202	126	170.271	251	175	170.281
18,00	.7087	130	—	54	170.270	166	—	90	170.270	202	126	170.271	256	180	170.281
18,01	.7091	—	—	—	—	184	—	100	170.270	—	—	170.271	269	185	170.281
18,50	.7283	144	—	60	170.270	184	—	100	170.270	224	140	170.271	269	185	170.281
19,00	.7480	144	—	60	170.270	184	—	100	170.270	224	140	170.271	274	190	170.281
19,50	.7677	144	—	60	170.270	184	—	100	170.270	224	140	170.271	279	195	170.281
20,00	.7874	153	—	60	170.272	197	—	100	170.272	241	140	170.273	297	200	170.282
20,50	.8071	153	—	66	170.272	197	—	110	170.272	241	154	170.273	297	205	170.282
21,00	.8268	153	—	66	170.272	197	—	110	170.272	241	154	170.273	297	210	170.282
21,50	.8465	153	—	66	170.272	197	—	110	170.272	241	154	170.273	307	215	170.282
22,00	.8661	153	—	66	170.272	197	—	110	170.272	241	154	170.273	307	220	170.282
22,01	.8665	—	—	—	—	209	—	120	170.272	—	—	170.273	319	225	170.282
22,50	.8858	161	—	72	170.272	209	—	120	170.272	257	168	170.273	319	225	170.282
23,00	.9055	161	—	72	170.272	209	—	120	170.272	257	168	170.273	319	230	170.282
23,50	.9252	161	—	72	170.272	209	—	120	170.272	257	168	170.273	329	235	170.282
24,00	.9449	161	—	72	170.272	209	—	120	170.272	257	168	170.273	329	240	170.282
24,01	.9453	—	—	—	—	226	—	130	170.274	—	—	—	346	245	170.283
24,50	.9646	174	—	78	170.274	226	—	130	170.274	278	182	170.275	346	245	170.283
25,00	.9843	174	—	78	170.274	226	—	130	170.274	278	182	170.275	346	250	170.283
25,50	10,039	174	—	78	170.274	226	—	130	170.274	278	182	170.275	356	255	170.283
26,00	10,236	174	—	78	170.274	226	—	130	170.274	278	182	170.275	356	260	170.283
26,01	10,240	—	—	—	—	238	—	140	170.274	—	—	170.275	363	265	170.283
26,50	10,433	182	—	84	170.274	238	—	140	170.274	294	196	170.275	363	265	170.283

(continued)

Modular Drills • Dimension Tables *(continued)*

■ **Dimensions for KSEM™ Whistle Notch Shank • WN/WD 3 x D to 10 x D • Metric**



D1		WN/WD Shank Metric								WN Shank Metric					
		3 x D				5 x D				7 x D			10 x D		
mm	inch	L	L1	L4 max	wrench	L	L1	L4 max	wrench	L	L4 max	wrench	L	L4 max	wrench
27,00	10.630	182	—	84	170.274	238	—	140	170.274	294	196	170.275	368	270	170.283
27,50	10.827	182	—	84	170.274	238	—	140	170.274	294	196	170.275	378	275	170.283
28,00	11.024	182	—	84	170.274	238	—	140	170.274	294	196	170.275	378	280	170.283
28,02	11.028	—	—	—	—	250	—	150	170.276	—	—	—	390	285	170.284
28,50	11.220	190	—	90	170.276	250	—	150	170.276	310	210	170.277	390	285	170.284
29,00	11.417	190	—	90	170.276	250	—	150	170.276	310	210	170.277	390	290	170.284
29,50	11.614	190	—	90	170.276	250	—	150	170.276	310	210	170.277	400	295	170.284
30,00	11.811	190	—	90	170.276	250	—	150	170.276	310	210	170.277	400	300	170.284
30,01	11.815	—	—	—	—	264	—	160	170.276	—	—	170.277	414	305	170.284
30,50	12.008	200	—	96	170.276	264	—	160	170.276	328	224	170.277	—	—	—
31,00	12.205	200	—	96	170.276	264	—	160	170.276	328	224	170.277	414	310	170.284
31,50	12.402	200	—	96	170.276	264	—	160	170.276	328	224	170.277	—	—	—
32,00	12.598	200	—	96	170.276	264	—	160	170.276	328	224	170.277	424	320	170.284
32,01	12.602	220	159	99	170.276	293	225	165	170.277	—	—	—	—	—	—
33,00	12.992	227	159	99	170.276	293	225	165	170.277	—	—	—	—	—	—
34,00	13.386	225	157	102	170.276	293	225	170	170.277	—	—	—	—	—	—
35,00	13.780	235	167	105	170.276	305	237	175	170.277	—	—	—	—	—	—
36,00	14.173	233	165	108	170.276	305	237	180	170.277	—	—	—	—	—	—
36,01	14.177	237	176	111	170.276	318	250	185	170.277	—	—	—	—	—	—
37,00	14.567	244	176	111	170.276	318	250	185	170.277	—	—	—	—	—	—
38,00	14.961	242	174	114	170.276	318	250	190	170.277	—	—	—	—	—	—
39,00	15.354	252	184	117	170.276	330	262	195	170.277	—	—	—	—	—	—
40,00	15.748	250	182	120	170.276	330	262	200	170.277	—	—	—	—	—	—

➤ KGEM Tube Sheet Grooving Tool

Primary Application

The new Kennametal grooving tool features a unique approach for manufacturing two grooves simultaneously in minimal time, especially in heat exchanger manufacturing. All tubes need a finish operation to connect them. This new grooving insert features a geometry designed for bur-free cutting and is made with KCU45™, a special grade for machining a wide variety of materials in the heat exchanger industry, including A516-grade 70 low-carbon steel, 304 stainless steel, duplex, and Hastelloy™. The minimal amount of tungsten carbide in the insert eliminates the need for refurbishment, enabling the tool to work faster with a lower cost per hole.

Features and Benefits

Higher Productivity and Profitability

- Two edges per insert.
- Up to four inserts working at the same time.
- Rigid tool body design for highest productivity and grooving quality.
- Milling tool for maximum flexibility in hole diameter and interrupted cut for chip control.
- KCU45 grade for machining a variety of materials used for heat exchangers.
- Internal coolant supply for optimal tool life, groove quality, and chip evacuation.
- One-path-to-finish tool.
- Flexibility in groove position.





Modular Drills

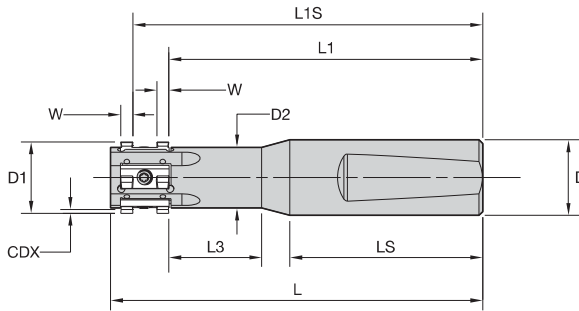

■ KGEM Groover Body • Metric



order number	catalogue number	D1	D2	D	L	LS	L1	L1S	L3	CDX	insert screw
5408657	KGEM1588R1WN20M	15,88	13,50	20,00	101,00	51,00	85,00	94,52	25,63	1,00	MS1861
5134143	KGEM1905R1WN20M	18,87	16,00	20,00	98,42	50,80	83,03	92,55	24,58	1,00	MS1861
5134145	KGEM1905R3WN20M	18,87	16,00	20,00	123,82	50,80	108,44	117,96	49,99	1,00	MS1861

NOTE: The above dimensions are used when ordering engineered-solution reamers on this page unless otherwise specified.

KSEM™ Support Tooling • KGEM™ Tube Sheet Groover Insert

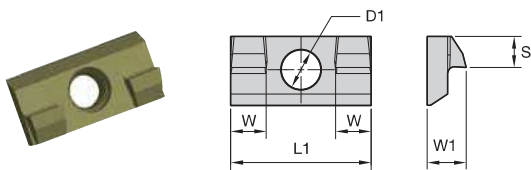

- first choice
- alternative choice

P	●
M	●
K	●
N	○
S	●
H	○

■ KGEM Groover Insert

order number	catalogue number	D1		W1		W		S		KCU45
		mm	in	mm	in	mm	in	mm	in	
5134141	KGIP0125N0189GD	2,80	.110	3,56	.140	3,18	.125	2,82	.111	●
5986819	KGIP0300N0189GD	2,80	.110	3,56	.140	3,00	.118	2,82	.111	●

P	A516-Grade70
M	304SS/Duplex
S	Hastelloy

■ **KGEM Tube Sheet Groover • KGIP GD Geometry • Grade KCU45™ • Through Coolant • Metric**

Material Group	fz (mm/tooth)	tooth	RPM	vc (m/min)	VFC (mm/min)	VFL (mm/min)	DH (mm)	DT (mm)
P	0,05–0,075	4	1300–1500	77–89	2,46–4,27	264–457	19,05	18,87
M	0,05–0,075	4	600–900	35–53	1,70–2,57	183–274	19,05	18,87
S	0,05–0,075	4	250–300	15–18	0,48–0,86	51–91	19,05	18,87

Nomenclature:

fz: feed per tooth

VFL: linear feed rate = fz x number of tooth x RPM

VFC: compensated feed = VFL x (DH - DT)/DH

DT: tool diameter

DH: hole diameter

NOTE: Choose low-feed (fz) for long tools and less rigid machine tools.
 Choose low RPM for lower coolant.

➤ KSEM PLUS™ Modular Drill System

Our KSEM PLUS drill concept is simple but effective. It combines the benefits of the KSEM™ modular drill (high feeds and length-to-diameter [L/D] ratios) with the benefits of an indexable drill (high speeds and low consumable costs). The KSEM PLUS system is a modular drilling platform, offering a pre-mountable HSS head with pocket seats for carbide inserts. The KSEM PLUS modular drill system features two head styles that are interchangeable on fitting tool bodies with our flexible FDS interface.

Primary Application

The KSEM PLUS system performs in steel, cast iron, stainless steel, and advanced materials. It is perfectly suited to exchange older HSS tools or low performance indexable drills for a very high performance drilling solution. The KSEM PLUS range comprises 28–101 mm (1.102–4") from 1.5–10 x D. There is a wide range of applications in the energy market, and in general engineering (e.g., bearing rings for windmills, hydraulic manifolds, large engine parts, generator housings, etc.). This tool will deliver vast improvements in productivity, and greatly attribute to increasing your machining capacity.

Features and Benefits

Replaceable Heads with FDS-Interface Coupling

- Quickly and easily replace inserts or drill heads without removing tool bodies from the machine.
- Save money and reduce tool stock by replacing just the worn drill head.
- Use one tool body for different sizes and styles of drill head (a head fits any drill body of the same FDS size).

KSEM PLUS A1 Heads

- High metal removal rates.
- Very stable in normal cutting conditions.
- Cost-effective indexable Drill Fix™ DFT inserts.

KSEM PLUS B1 Heads

- High-speed drilling in difficult conditions.
- Drills stacked plates and cored holes.
- Capable of machining through cross holes.
- Works with slanted exits up to 15°.

Two Effective Cutting Edges

- The KSEM PLUS system has two full cutting edges in action when operating.
- Achieve up to 100% increased productivity versus an indexable drill of the same diameter.
- High L/D ratios possible from 1.5 x D up to 10 x D as stocked standards. Longer drills are possible as custom solutions.

KSEM PLUS Pilot Insert

- Very high feed rates, comparable to modular drills.
- Very long tool life of KSEM PLUS centre inserts and modular heads due to better chip flow.
- No precentring necessary for drill depths up to 5 x D.

DFR™/DFT™/DFC™ Outboard Inserts

- Very high cutting speeds for high metal removal rates.
- Improved stability in all cutting conditions.
- Indexable inserts provide good surface finish and hole diameter accuracy.

KSEM PLUS™ A1 Heads
Economic, high-performance drilling.



NEW! All KSEMP Heads >70mm now available in 1mm and 1/8" pitch as standard product.

KSEM PLUS B1 Heads
High-performance drilling in difficult conditions.



NEW! DS geometry for long chipping materials.

NEW! 1.5 x D toolholders now available with WD and SSF shanks.



Tailored Grades

Centre Inserts

- KC7315™ grade — TiAlN-based PVD grade for superior performance in steel and stainless steel applications.
- KC7410™ grade — multilayered PVD coating for outstanding wear resistance when drilling cast irons.
- KC7135™ grade — chip-resistant universal grade with a TiCN-TiN PVD coating for challenging applications in steel and stainless steel materials.

Drill Fix™ Lateral Inserts

- KCU25™ grade — high metal removal rates, advanced TiCN-Al-CVD coating, and superior tool life in stable working conditions.
- KCU40™ grade — multilayered TiAlN-PVD coating with high wear resistance and reliability in most materials at medium cutting speeds.
- KC7140™ grade — TiCN-based, PVD-coated alloyed carbide for machining alloyed steel and stainless steel on KSEM PLUS systems.
- KC7225™ grade — TiAlN PVD-coated fine-grain carbide offers extreme process safety for non-ferrous materials, super alloys, and titanium.

NEW! **DFT™ and DFC™ Lateral Inserts with DS Geometry**

- Excellent performance and process stability in applications with long-chipping materials.
- Use for low carbon steel, difficult stainless steel, and non-ferrous materials where long chips can be an issue.
- Available in the KCU40™ grade.

Customisation

- Heads are available in intermediate diameters, and up to Ø 127mm as semi-standards.
- Tool bodies available in all popular shank styles up to shank length of 1200mm. Some restrictions with L/D ratios over 20 x D apply.
- Toolholders can be designed with helical chip flutes for better chip evacuation (e.g. drilling in cast iron).
- Heads for use with reground center inserts are available as semi-standards.
- The KSEM PLUS system features a high level of available customisation. Please contact us about for your individual metalcutting applications.

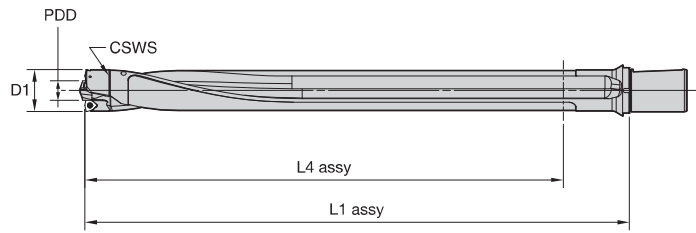

D1		available KSEM PLUS heads		requested insert size reference per head		available tool bodies per CSWS connecting size 3 x D, 5 x D, 8 x D, 10 x D (metric and inch bodies)					
mm	in	KSEM PLUS head order number	KSEM PLUS head ANSI catalogue number	PDD (mm)	outboard insert Drill Fix™ DFR/DFT	CSWS	KSEM PLUS body order number	KSEM PLUS body ANSI catalogue number	L/D ratio	L4 assembly (mm)	L1 assembly (mm)
28.000	1.1024	4000408	KSEMP2800FDS28A1M	14.000	DFR040304D28	28	6123570	WD32FDS28076M	1.5 x D	57	101
28.575	1.1250	4047811	KSEMP1125FDS28A1	15.000	DFR040304D28		4000409	WD32FDS28128M	3 x D	96	153
29.000	1.1417	4047812	KSEMP2900FDS28A1M	15.000	DFR040304D28		4051136	WD32FDS28190M	5 x D	158	215
29.362	1.1563	4047823	KSEMP1156FDS28A1	16.000	DFR040304D28		4051137	WD32FDS28283M	8 x D	251	308
30.000	1.1811	4047824	KSEMP3000FDS28A1M	16.000	DFR040304D28		4000411	WD32FDS28345M	10 x D	313	370
30.175	1.1875	4047825	KSEMP1188FDS28A1	17.000	DFR040304D28		6123582	SSF150FDS280299	1.5 x D	57	101
30.963	1.2188	4047826	KSEMP1219FDS28A1	17.000	DFR040304D28		4051138	SSF150FDS280502	3 x D	96	153
31.000	1.2205	4047827	KSEMP3100FDS28A1M	17.000	DFR040304D28		4051139	SSF150FDS280746	5 x D	158	215
							4051140	SSF150FDS281112	8 x D	251	308
							4051141	SSF150FDS281356	10 x D	313	370
31.750	1.2500	3794916	KSEMP1250FDS32A1	15.000	DFT05T308D32	32	6123571	WD32FDS32082M	1.5 x D	59	107
32.000	1.2598	3794291	KSEMP3200FDS32A1M	15.000	DFT05T308D32		3950219	WD32FDS32146M	3 x D	110	171
33.000	1.2992	3742210	KSEMP3300FDS32A1M	16.000	DFT05T308D33		3794428	WD32FDS32216M	5 x D	180	241
33.200	1.3071	3793949	KSEMP3320FDS32A1M	16.000	DFT05T308D33		3742293	WD32FDS32321M	8 x D	285	346
33.350	1.3130	3794917	KSEMP1313FDS32A1	17.000	DFT05T308D33		3794429	WD32FDS32391M	10 x D	355	416
34.000	1.3386	3794292	KSEMP3400FDS32A1M	17.000	DFT05T308D33		6123583	SSF150FDS320323	1.5 x D	59	107
34.925	1.3750	3794918	KSEMP1375FDS32A1	18.000	DFT05T308D33		3952192	SSF150FDS320573	3 x D	110	171
35.000	1.3780	3794393	KSEMP3500FDS32A1M	18.000	DFT05T308D33		3794835	SSF150FDS320850	5 x D	180	241
							3794836	SSF150FDS321263	8 x D	285	346
							3794837	SSF150FDS321539	10 x D	355	416
36.000	1.4173	3794394	KSEMP3600FDS36A1M	13.000	DFT06T308D36	36	6123572	WD32FDS36092M	1.5 x D	65	117
36.525	1.4380	3794919	KSEMP1438FDS36A1	14.000	DFT06T308D36		3950220	WD32FDS36166M	3 x D	122	191
37.000	1.4567	3794395	KSEMP3700FDS36A1M	14.000	DFT06T308D36		3794430	WD32FDS36244M	5 x D	200	269
37.500	1.4764	3794427	KSEMP3750FDS36A1M	15.000	DFT06T308D36		3794431	WD32FDS36361M	8 x D	317	386
38.000	1.4961	3794396	KSEMP3800FDS36A1M	15.000	DFT06T308D36		3794432	WD32FDS36439M	10 x D	395	464
38.100	1.5000	3794920	KSEMP1500FDS36A1	15.000	DFT06T308D36		6123584	SSF150FDS360362	1.5 x D	65	117
39.000	1.5354	3794397	KSEMP3900FDS36A1M	16.000	DFT06T308D39		3952343	SSF150FDS360652	3 x D	122	191
39.200	1.5433	3793950	KSEMP3920FDS36A1M	16.000	DFT06T308D39		3794838	SSF150FDS360960	5 x D	200	269
39.700	1.5630	3794921	KSEMP1563FDS36A1	17.000	DFT06T308D39		3794839	SSF150FDS361421	8 x D	317	386
							3794840	SSF150FDS361728	10 x D	395	464
40.000	1.5748	3794398	KSEMP4000FDS40A1M	17.000	DFT06T308D39	40	6123573	WD50FDS40100M	1.5 x D	73	125
41.000	1.6142	3794399	KSEMP4100FDS40A1M	18.000	DFT06T308D39		3872075	WD50FDS40183M	3 x D	137	213
41.275	1.6250	3794922	KSEMP1625FDS40A1	18.000	DFT06T308D39		3794443	WD50FDS40271M	5 x D	225	301
42.000	1.6535	3794400	KSEMP4200FDS40A1M	19.000	DFT06T308D39		3794444	WD50FDS40403M	8 x D	357	433
43.000	1.6929	3794401	KSEMP4300FDS40A1M	20.000	DFT06T308D39		3794445	WD50FDS40491M	10 x D	445	521
44.000	1.7323	3794402	KSEMP4400FDS40A1M	21.000	DFT06T308D44		6123585	SSF200FDS400394	1.5 x D	73	125
44.450	1.7500	3794933	KSEMP1750FDS40A1	22.000	DFT06T308D44		3952344	SSF200FDS400721	3 x D	137	213
							3794841	SSF200FDS401066	5 x D	225	301
							3794842	SSF200FDS401586	8 x D	357	433
							3794903	SSF200FDS401933	10 x D	445	521

(continued)

(KSEM PLUS Overview and Assembly for Systems Using A1 Heads — continued)

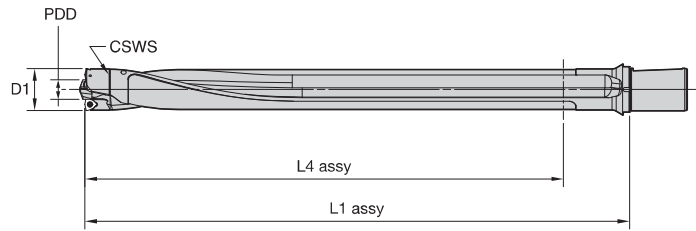

available KSEM PLUS heads				requested insert size reference per head		available tool bodies per CSWS connecting size 3 x D, 5 x D, 8 x D, 10 x D (metric and inch bodies)					
D1		KSEM PLUS head order number	KSEM PLUS head ANSI catalogue number	PDD (mm)	outboard insert	CSWS	KSEM PLUS body order number	KSEM PLUS body ANSI catalogue number	L/D ratio	L4 assembly (mm)	L1 assembly (mm)
mm	in			centre insert size reference	Drill Fix™ DFC DPA guiding pads						
45.000	1.7717	3794403	KSEMP4500FDS45A1M	18.000	DFT070408D45	45	6123575	WD50FDS45112M	1.5 x D	85	147
46.000	1.8110	3794404	KSEMP4600FDS45A1M	19.000	DFT070408D45		3872709	WD50FDS45206M	3 x D	152	236
47.000	1.8504	3794405	KSEMP4700FDS45A1M	20.000	DFT070408D45		3794446	WD50FDS45304M	5 x D	250	334
47.625	1.8750	3794934	KSEMP1875FDS45A1	21.000	DFT070408D45		3794447	WD50FDS45451M	8 x D	397	481
48.000	1.8898	3794406	KSEMP4800FDS45A1M	21.000	DFT070408D45		3794448	WD50FDS45549M	10 x D	495	579
49.000	1.9291	3794407	KSEMP4900FDS45A1M	22.000	DFT070408D45		6123586	SSF200FDS450441	1.5 x D	85	147
							3952345	SSF200FDS450809	3 x D	152	236
							3794904	SSF200FDS451196	5 x D	250	334
						3794905	SSF200FDS451775	8 x D	397	481	
						3794906	SSF200FDS452161	10 x D	495	579	
50.000	1.9685	3742211	KSEMP5000FDS50A1M	23.000	DFT070408D50	50	6123576	WD50FDS50122M	1.5 x D	89	157
50.800	2.0000	3794935	KSEMP2000FDS50A1	24.000	DFT070408D50		3950221	WD50FDS50228M	3 x D	170	263
51.000	2.0079	3794408	KSEMP5100FDS50A1M	24.000	DFT070408D50		3794449	WD50FDS50338M	5 x D	280	373
52.000	2.0472	3794409	KSEMP5200FDS50A1M	25.000	DFT070408D50		3742294	WD50FDS50503M	8 x D	445	538
53.000	2.0866	3794410	KSEMP5300FDS50A1M	26.000	DFT070408D50		3794450	WD50FDS50613M	10 x D	555	648
53.975	2.1250	3794936	KSEMP2125FDS50A1	27.000	DFT070408D50		6123587	SSF200FDS500480	1.5 x D	89	157
54.000	2.1260	3794411	KSEMP5400FDS50A1M	27.000	DFT070408D50		3952346	SSF200FDS500896	3 x D	170	263
55.000	2.1654	3794412	KSEMP5500FDS50A1M	28.000	DFT070408D50		3794907	SSF200FDS501330	5 x D	280	373
						3794908	SSF200FDS501980	8 x D	445	538	
						3794909	SSF200FDS502413	10 x D	555	648	
56.000	2.2047	3794413	KSEMP5600FDS56A1M	20.000	DFT090508D56	56	6123577	WD50FDS56140M	1.5 x D	130	175
57.000	2.2441	3794414	KSEMP5700FDS56A1M	21.000	DFT090508D56		3950222	WD50FDS56259M	3 x D	191	294
57.150	2.2500	3794937	KSEMP2250FDS56A1	21.000	DFT090508D56		3794451	WD50FDS56383M	5 x D	315	418
58.000	2.2835	3794415	KSEMP5800FDS56A1M	22.000	DFT090508D56		3794452	WD50FDS56569M	8 x D	501	604
59.000	2.3228	3794416	KSEMP5900FDS56A1M	23.000	DFT090508D56		3794453	WD50FDS56693M	10 x D	625	728
60.000	2.3622	3794417	KSEMP6000FDS56A1M	24.000	DFT090508D56		6123588	SSF200FDS560551	1.5 x D	130	175
60.330	2.3750	3794938	KSEMP2375FDS56A1	24.000	DFT090508D56		3952347	SSF200FDS561020	3 x D	191	294
61.000	2.4016	3794418	KSEMP6100FDS56A1M	25.000	DFT090508D56		3794910	SSF200FDS561507	5 x D	315	418
62.000	2.4409	3794419	KSEMP6200FDS56A1M	26.000	DFT090508D56	3794911	SSF200FDS562240	8 x D	501	604	
						3794912	SSF200FDS562783	10 x D	625	728	
63.000	2.4803	3794420	KSEMP6300FDS63A1M	27.000	DFT090508D63	63	6123578	WD50FDS63154M	1.5 x D	111	194
63.500	2.5000	3794939	KSEMP2500FDS63A1	28.000	DFT090508D63		3950333	WD50FDS63289M	3 x D	214	329
64.000	2.5197	3794421	KSEMP6400FDS63A1M	28.000	DFT090508D63		3794454	WD50FDS63429M	5 x D	354	469
65.000	2.5591	3794422	KSEMP6500FDS63A1M	29.000	DFT090508D63		3794455	WD50FDS63639M	8 x D	564	679
66.000	2.5984	3794423	KSEMP6600FDS63A1M	30.000	DFT090508D63		3742296	WD50FDS63779M	10 x D	704	819
66.680	2.6250	3794940	KSEMP2625FDS63A1	31.000	DFT090508D63		6123589	SSF200FDS630606	1.5 x D	111	194
67.000	2.6378	3794424	KSEMP6700FDS63A1M	31.000	DFT090508D63		3952348	SSF200FDS631138	3 x D	214	329
68.000	2.6772	3794425	KSEMP6800FDS63A1M	32.000	DFT090508D63		3794913	SSF200FDS631688	5 x D	354	469
69.000	2.7165	3794426	KSEMP6900FDS63A1M	33.000	DFT090508D63	3794914	SSF200FDS632515	8 x D	564	679	
69.850	2.7500	3794941	KSEMP2750FDS63A1	34.000	DFT090508D63	3794915	SSF200FDS633066	10 x D	704	819	
70.000	2.7559	3742212	KSEMP7000FDS63A1M	34.000	DFT090508D63						

(continued)

(KSEM PLUS Overview and Assembly for Systems Using A1 Heads — continued)

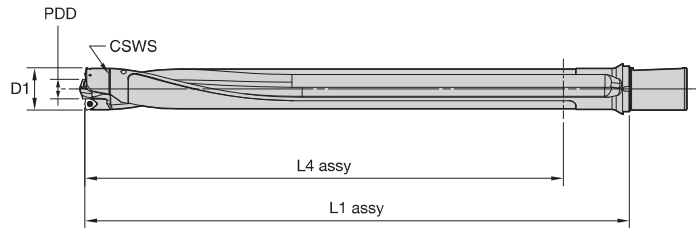

Modular Drills

D1		available KSEM PLUS heads		requested insert size reference per head		available tool bodies per CSWS connecting size 3 x D, 5 x D, 8 x D, 10 x D (metric and inch bodies)							
mm	in	KSEM PLUS head order number	KSEM PLUS head ANSI catalogue number	PDD (mm) centre insert size reference	outboard insert Drill Fix™ DFC DPA guiding pads	CSWS	KSEM PLUS body order number	KSEM PLUS body ANSI catalogue number	L/D ratio	L4 assembly (mm)	L1 assembly (mm)		
71.000	2.7950	6041904	KSEMP7100FDS71A1M	26.000	4x DFT06T308D44	71	6123579	WD50FDS71172M	1.5 x D	128	217		
72.000	2.8350	5397513	KSEMP7200FDS71A1M	27.000			5397942	WD50FDS71292M	3 x D	241	333		
73.000	2.8740	6041906	KSEMP7300FDS71A1M	28.000			5397943	WD50FDS71452M	5 x D	401	493		
73.025	2.8750	6041931	KSEMP2875FDS71A1	28.000			6123590	SSF200FDS710677	1.5 x D	128	217		
74.000	2.9130	5397514	KSEMP7400FDS71A1M	29.000			5397948	SSF200FDS711150	3 x D	241	333		
75.000	2.9530	6041907	KSEMP7500FDS71A1M	30.000			5397949	SSF200FDS711780	5 x D	401	493		
76.000	2.9920	5397515	KSEMP7600FDS71A1M	31.000									
76.200	3.0000	5397516	KSEMP3000FDS71A1	31.000									
77.000	3.0310	6041908	KSEMP7700FDS71A1M	32.000									
78.000	3.0710	5397517	KSEMP7800FDS71A1M	33.000									
79.000	3.1100	6041909	KSEMP7900FDS71A1M	34.000									
79.375	3.1250	6041932	KSEMP3125FDS80A1	31.000			2x DFT06T308D44 & 2x DFT070408D50	80	6123580	WD50FDS80192M	1.5 x D	145	247
80.000	3.1500	5397518	KSEMP8000FDS80A1M	31.000					5397944	WD50FDS80327M	3 x D	271	373
81.000	3.1890	6041910	KSEMP8100FDS80A1M	32.000					5397945	WD50FDS80507M	5 x D	451	553
82.000	3.2280	5397519	KSEMP8200FDS80A1M	33.000	6123591	SSF200FDS800756			1.5 x D	145	247		
83.000	3.2680	6041921	KSEMP8300FDS80A1M	34.000	5398010	SSF200FDS801287			3 x D	271	373		
82.550	3.2500	5397550	KSEMP3250FDS80A1	34.000	5398011	SSF200FDS801996			5 x D	451	553		
84.000	3.3070	5397551	KSEMP8400FDS80A1M	35.000									
85.000	3.3070	6041922	KSEMP8500FDS80A1M	36.000									
85.725	3.3750	6041933	KSEMP3375FDS80A1	37.000									
86.000	3.3860	5397552	KSEMP8600FDS80A1M	37.000									
87.000	3.4250	6041923	KSEMP8700FDS80A1M	38.000									
88.000	3.4650	5397553	KSEMP8800FDS80A1M	39.000									
88.900	3.5000	5397554	KSEMP3500FDS80A1	40.000									
89.000	3.5040	6041924	KSEMP8900FDS80A1M	40.000									
90.000	3.5430	5397555	KSEMP9000FDS90A1M	37.000	4x DFT070408D50	90	6123581	WD50FDS90212M	1.5 x D	160	272		
91.000	3.5830	6041925	KSEMP9100FDS90A1M	38.000			5397946	WD50FDS90362M	3 x D	302	414		
92.000	3.6220	5397556	KSEMP9200FDS90A1M	39.000			5397947	WD50FDS90562M	5 x D	502	614		
92.075	3.6250	6041934	KSEMP3625FDS90A1	39.000			6123592	SSF200FDS900835	1.5 x D	160	272		
93.000	3.6610	6041926	KSEMP9300FDS90A1M	40.000			5398012	SSF200FDS901425	3 x D	302	414		
							5398013	SSF200FDS902213	5 x D	502	614		
94.000	3.7010	5397557	KSEMP9400FDS90A1M	26.000	6x DFT06T308D44	90							
95.000	3.7400	6041927	KSEMP9500FDS90A1M	27.000									
95.250	3.7500	5397558	KSEMP3750FDS90A1	27.000									
96.000	3.7800	5397559	KSEMP9600FDS90A1M	28.000									
97.000	3.8190	6041928	KSEMP9700FDS90A1M	29.000									
98.000	3.8580	5397560	KSEMP9800FDS90A1M	30.000									
98.425	3.8750	6041935	KSEMP3875FDS90A1	31.000									
99.000	3.8980	6041929	KSEMP9900FDS90A1M	31.000									
100.000	3.9370	6041930	KSEMP10000FDS90A1M	32.000									
101.600	4.0000	5397561	KSEMP4000FDS90A1	34.000									

Keep it Short and Simple...

Achieve short chips in long-chipping materials with our new DS/LP geometries for indexable drills and KSEM PLUS™.

- High metal removal rates without long chips, especially in low-carbon steel applications.
- Improved control of chip flow, chip breakage, and chip curling. Eliminates chip jamming by providing excellent chip forming and chipbreaking capabilities.
- Avoid bird nesting and long, stringy chips to reduce idle time and improve process stability.

See pages J4–J50 for Drill Fix™ Indexable Drills.

See pages H80–H82, H84–H101, and H106 for KSEM PLUS A1 and B1 head systems.



Experience the advantages at your Authorised Kennametal Distributor or at kennametal.com.



kennametal.com

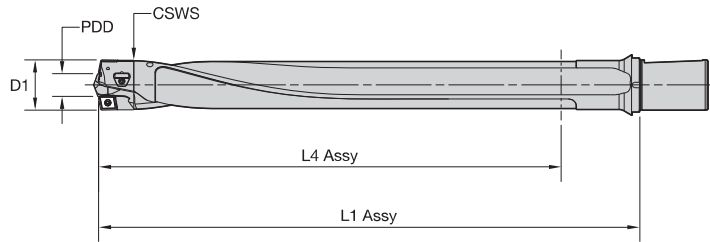

Modular Drills

D1		available KSEM PLUS heads		requested insert size reference per head		available tool bodies per CSWS connecting size 3 x D, 5 x D, 8 x D, 10 x D (metric and inch bodies)					
mm	in	KSEM PLUS head order number	KSEM PLUS head ANSI catalogue number	PDD (mm)	outboard insert	CSWS	KSEM PLUS body order number	KSEM PLUS body ANSI catalogue number	L/D ratio	L4 assembly (mm)	L1 assembly (mm)
				centre insert size reference	Drill Fix™ DFC DPA guiding pads						
28.000	1.1020	5115736	KSEMP2800FDS28B1M	14.000	DFC inserts DFC040310D28 DPA guiding pads DPA07T3D25	28	6123570	WD32FDS28076M	1.5 x D	54	98
28.575	1.1250	5115737	KSEMP1125FDS28B1	15.000			4000409	WD32FDS28128M	3 x D	93	150
29.000	1.1420	5115738	KSEMP2900FDS28B1M	15.000			4051136	WD32FDS28190M	5 x D	155	212
29.362	1.1560	5115739	KSEMP1156FDS28B1	16.000			4051137	WD32FDS28283M	8 x D	248	305
30.000	1.1810	5116010	KSEMP3000FDS28B1M	16.000			4000411	WD32FDS28345M	10 x D	310	367
30.175	1.1880	5116011	KSEMP1188FDS28B1	17.000			6123582	SSF150FDS280299	1.5 x D	54	98
30.963	1.2190	5116012	KSEMP1219FDS28B1	17.000			4051138	SSF150FDS280502	3 x D	93	150
31.000	1.2200	5116013	KSEMP3100FDS28B1M	17.000			4051139	SSF150FDS280746	5 x D	155	212
							4051140	SSF150FDS281112	8 x D	248	305
							4051141	SSF150FDS281356	10 x D	310	367
31.750	1.2500	5116014	KSEMP1250FDS32B1	15.000	DFC inserts DFC05T312D32 DPA guiding pads DPA09T4D32	32	6123571	WD32FDS32082M	1.5 x D	54	102
32.000	1.2600	5116015	KSEMP3200FDS32B1M	15.000			3950219	WD32FDS32146M	3 x D	105	166
33.000	1.2990	5116016	KSEMP3300FDS32B1M	16.000			3794428	WD32FDS32216M	5 x D	175	236
33.200	1.3070	5116017	KSEMP3320FDS32B1M	16.000			3742293	WD32FDS32321M	8 x D	280	341
33.350	1.3130	5116018	KSEMP1313FDS32B1	17.000			3794429	WD32FDS32391M	10 x D	350	411
34.000	1.3390	5116019	KSEMP3400FDS32B1M	17.000			6123583	SSF150FDS320323	1.5 x D	54	102
34.925	1.3750	5116030	KSEMP1375FDS32B1	18.000			3952192	SSF150FDS320573	3 x D	105	166
35.000	1.3780	5116031	KSEMP3500FDS32B1M	18.000			3794835	SSF150FDS320850	5 x D	175	236
							3794836	SSF150FDS321263	8 x D	280	341
							3794837	SSF150FDS321539	10 x D	350	411
36.000	1.4170	5116032	KSEMP3600FDS36B1M	13.000	DFC inserts DFC06T312D36 DPA guiding pads DPA09T4D32	36	6123572	WD32FDS36092M	1.5 x D	60	112
36.525	1.4380	5116033	KSEMP1438FDS36B1	14.000			3950220	WD32FDS36166M	3 x D	117	186
37.000	1.4570	5116034	KSEMP3700FDS36B1M	14.000			3794430	WD32FDS36244M	5 x D	195	264
37.500	1.4760	5116035	KSEMP3750FDS36B1M	15.000			3794431	WD32FDS36361M	8 x D	312	381
38.000	1.4960	5116036	KSEMP3800FDS36B1M	15.000			3794432	WD32FDS36439M	10 x D	390	459
38.100	1.5000	5116037	KSEMP1500FDS36B1	15.000			6123584	SSF150FDS360362	1.5 x D	60	112
39.000	1.5350	5116038	KSEMP3900FDS36B1M	16.000			3952343	SSF150FDS360652	3 x D	117	186
39.200	1.5430	5116039	KSEMP3920FDS36B1M	16.000			3794838	SSF150FDS360960	5 x D	195	264
39.700	1.5630	5116040	KSEMP1563FDS36B1	17.000			3794839	SSF150FDS361421	8 x D	312	381
							3794840	SSF150FDS361728	10 x D	390	459
40.000	1.5750	5116041	KSEMP4000FDS40B1M	17.000	DFC inserts DFC06T312D36 DPA guiding pads DPA09T4D32	40	6123573	WD50FDS40100M	1.5 x D	68	120
41.000	1.6140	5116042	KSEMP4100FDS40B1M	18.000			3872075	WD50FDS40183M	3 x D	132	208
41.275	1.6250	5116043	KSEMP1625FDS40B1	18.000			3794443	WD50FDS40271M	5 x D	220	296
42.000	1.6540	5116044	KSEMP4200FDS40B1M	19.000			3794444	WD50FDS40403M	8 x D	352	428
43.000	1.6930	5116045	KSEMP4300FDS40B1M	20.000			3794445	WD50FDS40491M	10 x D	440	516
44.000	1.7320	5116046	KSEMP4400FDS40B1M	21.000			6123585	SSF200FDS400394	1.5 x D	68	120
44.450	1.7500	5116047	KSEMP1750FDS40B1	22.000			3952344	SSF200FDS400721	3 x D	132	208
							3794841	SSF200FDS401066	5 x D	220	296
							3794842	SSF200FDS401586	8 x D	352	428
							3794903	SSF200FDS401933	10 x D	440	516

(continued)

(KSEM PLUS Overview and Assembly for Systems Using B1 Heads — continued)

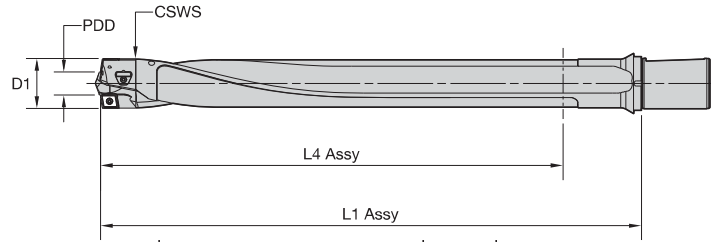

available KSEM PLUS heads				requested insert size reference per head		available tool bodies per CSWS connecting size 3 x D, 5 x D, 8 x D, 10 x D (metric and inch bodies)							
D1		KSEM PLUS head order number	KSEM PLUS head ANSI catalogue number	PDD (mm)	outboard insert	CSWS	KSEM PLUS body order number	KSEM PLUS body ANSI catalogue number	L/D ratio	L4 assembly (mm)	L1 assembly (mm)		
mm	in			centre insert size reference	Drill Fix™ DFC DPA guiding pads								
45.000	1.7720	5116098	KSEMP4500FDS45B1M	18.000	DFC inserts DFC070416D45 DPA guiding pads DPA09T4D32	45	6123575	WD50FDS45112M	1.5 x D	80	142		
46.000	1.8110	5116099	KSEMP4600FDS45B1M	19.000			3872709	WD50FDS45206M	3 x D	147	231		
47.000	1.8500	5116110	KSEMP4700FDS45B1M	20.000			3794446	WD50FDS45304M	5 x D	245	329		
47.625	1.8750	5116111	KSEMP1875FDS45B1	21.000			3794447	WD50FDS45451M	8 x D	392	476		
48.000	1.8900	5116112	KSEMP4800FDS45B1M	21.000			3794448	WD50FDS45549M	10 x D	490	574		
49.000	1.9290	5116113	KSEMP4900FDS45B1M	22.000			6123586	SSF200FDS450441	1.5 x D	80	142		
							3952345	SSF200FDS450809	3 x D	147	231		
					3794904	SSF200FDS451196	5 x D	245	329				
					3794905	SSF200FDS451775	8 x D	392	476				
					3794906	SSF200FDS452161	10 x D	490	574				
50.000	1.9690	5116114	KSEMP5000FDS50B1M	23.000	DFC inserts DFC070416D45 DPA guiding pads DPA13T5D50	50	6123576	WD50FDS50122M	1.5 x D	84	152		
50.800	2.0000	5116115	KSEMP2000FDS50B1	24.000			3950221	WD50FDS50228M	3 x D	165	258		
51.000	2.0080	5116116	KSEMP5100FDS50B1M	24.000			3794449	WD50FDS50338M	5 x D	275	368		
52.000	2.0470	5116117	KSEMP5200FDS50B1M	25.000			3742294	WD50FDS50503M	8 x D	440	533		
53.000	2.0870	5116118	KSEMP5300FDS50B1M	26.000			3794450	WD50FDS50613M	10 x D	550	643		
53.975	2.1250	5116119	KSEMP2125FDS50B1	27.000			6123587	SSF200FDS500480	1.5 x D	84	152		
54.000	2.1260	5116120	KSEMP5400FDS50B1M	27.000			3952346	SSF200FDS500896	3 x D	165	258		
55.000	2.1650	5116121	KSEMP5500FDS50B1M	28.000			3794907	SSF200FDS501330	5 x D	275	368		
							3794908	SSF200FDS501980	8 x D	440	533		
							3794909	SSF200FDS502413	10 x D	550	643		
56.000	2.2050	5116122	KSEMP5600FDS56B1M	20.000	DFC inserts DFC090520D56 DPA guiding pads DPA13T5D50	56	6123577	WD50FDS56140M	1.5 x D	125	170		
57.000	2.2440	5116123	KSEMP5700FDS56B1M	21.000			3950222	WD50FDS56259M	3 x D	186	289		
57.150	2.2500	5116124	KSEMP2250FDS56B1	21.000			3794451	WD50FDS56383M	5 x D	310	413		
58.000	2.2830	5116125	KSEMP5800FDS56B1M	22.000			3794452	WD50FDS56569M	8 x D	496	599		
59.000	2.3230	5116126	KSEMP5900FDS56B1M	23.000			3794453	WD50FDS56693M	10 x D	620	723		
60.000	2.3620	5116127	KSEMP6000FDS56B1M	24.000			6123588	SSF200FDS560551	1.5 x D	125	170		
60.330	2.3750	5116128	KSEMP2375FDS56B1	24.000			3952347	SSF200FDS561020	3 x D	186	289		
61.000	2.4020	5116129	KSEMP6100FDS56B1M	25.000			3794910	SSF200FDS561507	5 x D	310	413		
62.000	2.4410	5116130	KSEMP6200FDS56B1M	26.000			3794911	SSF200FDS562240	8 x D	496	599		
							3794912	SSF200FDS562783	10 x D	620	723		
63.000	2.4800	5116131	KSEMP6300FDS63B1M	27.000			DFC inserts DFC090520D56 DPA guiding pads DPA13T5D50	63	6123578	WD50FDS63154M	1.5 x D	107	190
63.500	2.5000	5116132	KSEMP2500FDS63B1	28.000					3950333	WD50FDS63289M	3 x D	210	325
64.000	2.5200	5116133	KSEMP6400FDS63B1M	28.000					3794454	WD50FDS63429M	5 x D	350	465
65.000	2.5590	5116134	KSEMP6500FDS63B1M	29.000	3794455	WD50FDS63639M			8 x D	560	675		
66.000	2.5980	5116135	KSEMP6600FDS63B1M	30.000	3742296	WD50FDS63779M			10 x D	700	815		
66.680	2.6250	5116136	KSEMP2625FDS63B1	31.000	6123589	SSF200FDS630606			1.5 x D	107	190		
67.000	2.6380	5116137	KSEMP6700FDS63B1M	31.000	3952348	SSF200FDS631138			3 x D	210	325		
68.000	2.6770	5116138	KSEMP6800FDS63B1M	32.000	3794913	SSF200FDS631688			5 x D	350	465		
69.000	2.7170	5116139	KSEMP6900FDS63B1M	33.000	3794914	SSF200FDS632515			8 x D	560	675		
69.850	2.7500	5116140	KSEMP2750FDS63B1	34.000	3794915	SSF200FDS633066			10 x D	700	815		
70.000	2.7560	5116141	KSEMP7000FDS63B1M	34.000									

(continued)

(KSEM PLUS Overview and Assembly for Systems Using B1 Heads — continued)

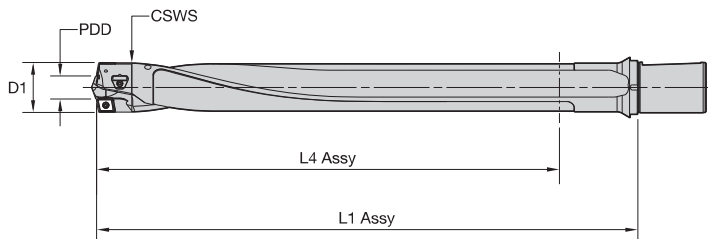

Modular Drills

D1		available KSEM PLUS heads		requested insert size reference per head		CSWS	available tool bodies per CSWS connecting size 3 x D, 5 x D, 8 x D, 10 x D (metric and inch bodies)					
mm	in	KSEM PLUS head order number	KSEM PLUS head ANSI catalogue number	PDD (mm)	outboard insert Drill Fix™ DFC DPA guiding pads		KSEM PLUS body order number	KSEM PLUS body ANSI catalogue number	L/D ratio	L4 assembly (mm)	L1 assembly (mm)	
71.000	2.7950	6041937	KSEMP7100FDS71B1M	26.000	DFC inserts 4x DFC06T312D36 DPA guiding pads DPA13T5D50	71	6123579	WD50FDS71172M	1.5 x D	127	216	
72.000	2.8350	6041797	KSEMP7200FDS71B1M	27.000			5397942	WD50FDS71292M	3 x D	240	332	
73.000	2.8740	6041938	KSEMP7300FDS71B1M	28.000			5397943	WD50FDS71452M	5 x D	400	492	
73.025	2.8750	6042002	KSEMP2875FDS71B1	28.000			6123590	SSF200FDS710677	1.5 x D	127	216	
74.000	2.9130	6041798	KSEMP7400FDS71B1M	29.000			5397948	SSF200FDS711150	3 x D	240	332	
75.000	2.9530	6041939	KSEMP7500FDS71B1M	30.000			5397949	SSF200FDS711780	5 x D	400	492	
76.000	2.9920	6041799	KSEMP7600FDS71B1M	31.000								
77.000	3.0310	6041940	KSEMP7700FDS71B1M	32.000								
76.200	3.0000	5397562	KSEMP3000FDS71B1	31.000								
78.000	3.0710	6041800	KSEMP7800FDS71B1M	33.000								
79.000	3.1100	6041991	KSEMP7900FDS71B1M	34.000								
79.375	3.1250	6042003	KSEMP3125FDS80B1	31.000	DFC inserts 2x DFC06T312D36 & 2x DFC070416D45 DPA guiding pads DPA13T5D50	80	6123580	WD50FDS80192M	1.5 x D	144	246	
80.000	3.1500	6041881	KSEMP8000FDS80B1M	31.000			5397944	WD50FDS80327M	3 x D	270	372	
81.000	3.1890	6041992	KSEMP8100FDS80B1M	32.000			5397945	WD50FDS80507M	5 x D	450	552	
82.000	3.2280	6041882	KSEMP8200FDS80B1M	33.000			6123591	SSF200FDS800756	1.5 x D	144	246	
82.550	3.2500	5397563	KSEMP3250FDS80B1	34.000			5398010	SSF200FDS801287	3 x D	270	372	
83.000	3.2680	6041993	KSEMP8300FDS80B1M	34.000			5398011	SSF200FDS801996	5 x D	450	552	
84.000	3.3070	6041883	KSEMP8400FDS80B1M	35.000								
85.000	3.3460	6041994	KSEMP8500FDS80B1M	36.000								
85.725	3.3750	6042004	KSEMP3375FDS80B1	37.000								
86.000	3.3860	6041884	KSEMP8600FDS80B1M	37.000								
87.000	3.4250	6041995	KSEMP8700FDS80B1M	38.000								
88.000	3.4650	6041885	KSEMP8800FDS80B1M	39.000								
88.900	3.5000	5397564	KSEMP3500FDS80B1	40.000								
89.000	3.5040	6041996	KSEMP8900FDS80B1M	40.000								
90.000	3.5430	6041886	KSEMP9000FDS90B1M	37.000	DFC inserts 4x DFC070416D45 DPA guiding pads DPA13T5D50	90	6123581	WD50FDS90212M	1.5 x D	158	270	
91.000	3.5830	6041997	KSEMP9100FDS90B1M	38.000			5397946	WD50FDS90362M	3 x D	300	412	
92.000	3.6220	6041887	KSEMP9200FDS90B1M	39.000			5397947	WD50FDS90562M	5 x D	500	612	
92.075	3.6250	6042005	KSEMP3625FDS90B1	39.000			6123592	SSF200FDS900835	1.5 x D	158	270	
93.000	3.6610	6041998	KSEMP9300FDS90B1M	40.000			5398012	SSF200FDS901425	3 x D	300	412	
94.000	3.7010	6041888	KSEMP9400FDS90B1M	26.000	DFC inserts 6x DFC06T312D36 DPA guiding pads DPA13T5D50	90	5398013	SSF200FDS902213	5 x D	500	612	
95.000	3.7400	6041999	KSEMP9500FDS90B1M	27.000								
95.250	3.7500	5397565	KSEMP3750FDS90B1	27.000								
96.000	3.7800	6041889	KSEMP9600FDS90B1M	28.000								
97.000	3.8190	6042000	KSEMP9700FDS90B1M	29.000								
98.000	3.8580	6041890	KSEMP9800FDS90B1M	30.000								
98.425	3.8750	6042006	KSEMP3875FDS90B1	31.000								
99.000	3.8980	6042001	KSEMP9900FDS90B1M	31.000								
100.000	3.9370	6041901	KSEMP10000FDS90B1M	32.000								
101.600	4.0000	5397566	KSEMP4000FDS90B1	34.000								

- To ensure 100% system stability, KSEM™ inserts used for KSEM PLUS should not be reground.
- The callout D1 (mm) = PDD. PDD is used in reference to the KSEM PLUS heads.
- Please refer to KSEMP insert recommendation on page H106 to configure your insert setup depending on the application.

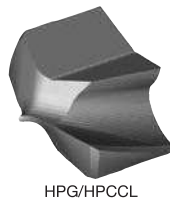

HPG/HPCCl

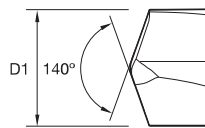

D1 (mm) = PDD



PC

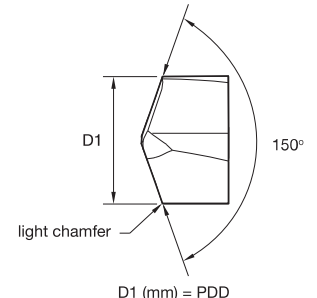

D1 (mm) = PDD

■ KSEM PLUS Centre Inserts



- first choice
- alternate choice

			D1		seat size
			mm	in	
HPG • KC7315	HPCCL • KC7410	PC • KC7135			
KSEMP1300HPGM	KSEM1300HPCClM	KSEM1300PCM	13,000	.5118	C
KSEMP1400HPGM	KSEM1400HPCClM	KSEM1400PCM	14,000	.5512	B
KSEMP1500HPGM	KSEM1500HPCClM	KSEM1500PCM	15,000	.5906	A
KSEMP1600HPGM	KSEM1600HPCClM	KSEM1600PCM	16,000	.6299	1
KSEMP1700HPGM	KSEM1700HPCClM	KSEM1700PCM	17,000	.6693	1
KSEMP1800HPGM	KSEM1800HPCClM	KSEM1800PCM	18,000	.7087	1
KSEMP1900HPGM	KSEM1900HPCClM	KSEM1900PCM	19,000	.7480	2
KSEMP2000HPGM	KSEM2000HPCClM	KSEM2000PCM	20,000	.7874	3
KSEMP2100HPGM	KSEM2100HPCClM	KSEM2100PCM	21,000	.8268	3
KSEMP2200HPGM	KSEM2200HPCClM	KSEM2200PCM	22,000	.8661	3
KSEMP2300HPGM	KSEM2300HPCClM	KSEM2300PCM	23,000	.9055	4
KSEMP2400HPGM	KSEM2400HPCClM	KSEM2400PCM	24,000	.9449	4
KSEMP2500HPGM	KSEM2500HPCClM	KSEM2500PCM	25,000	.9843	5
KSEMP2600HPGM	KSEM2600HPCClM	KSEM2600PCM	26,000	1.0236	5
KSEMP2700HPGM	KSEM2700HPCClM	KSEM2700PCM	27,000	1.0630	6
KSEMP2800HPGM	KSEM2800HPCClM	KSEM2800PCM	28,000	1.1024	6
KSEMP2900HPGM	KSEM2900HPCClM	KSEM2900PCM	29,000	1.1417	7
KSEMP3000HPGM	KSEM3000HPCClM	KSEM3000PCM	30,000	1.1811	7
KSEMP3100HPGM	KSEM3100HPCClM	KSEM3100PCM	31,000	1.2205	8
KSEMP3200HPGM	KSEM3200HPCClM	KSEM3200PCM	32,000	1.2598	8
KSEMP3300HPGM	KSEM3300HPCClM	KSEM3300PCM	33,000	1.2992	9
KSEMP3400HPGM	KSEM3400HPCClM	KSEM3400PCM	34,000	1.3386	9
KSEMP3500HPGM	KSEM3500HPCClM	KSEM3500PCM	35,000	1.3780	9
KSEMP3600HPGM	KSEM3600HPCClM	KSEM3600PCM	36,000	1.4173	9
KSEMP3700HPGM	KSEM3700HPCClM	KSEM3700PCM	37,000	1.4567	10
KSEMP3800HPGM	KSEM3800HPCClM	KSEM3800PCM	38,000	1.4961	10
KSEMP3900HPGM	KSEM3900HPCClM	KSEM3900PCM	39,000	1.5354	10
KSEMP4000HPGM	KSEM4000HPCClM	KSEM4000PCM	40,000	1.5748	10

Tolerance KSEMP HPG • KSEM HPCCL
• Metric

D1	tolerance h8
12,5-18	+0,000/-0,027
>18-30	+0,000/-0,033
>30-40	+0,000/-0,039

Tolerance KSEM PC • Metric

D1 metric	tolerance k7
12,5-18	+0,001/+ 0,019
>18-30	+0,002/+ 0,023
>30-40	+0,002/+ 0,027

Modular Drills

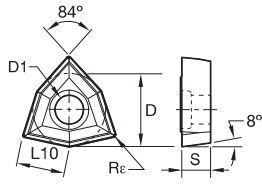

● first choice
○ alternate choice

P	●	●
M	○	○
K	●	○
N	○	○
S	○	●
H	○	○

■ DFT-HP

catalogue number	L10	D	D1	S	Rε	KCU25	KCU40
DFT05T308D32HP	5,29	8,00	3,40	3,75	0,80	●	●
DFT05T308D33HP	5,29	8,00	3,40	3,75	0,80	●	●
DFT06T308D36HP	6,62	10,00	4,40	3,75	0,80	●	●
DFT06T308D39HP	6,62	10,00	4,40	3,75	0,80	●	●
DFT06T308D44HP	6,62	10,00	4,40	3,75	0,80	●	●
DFT070408D45HP	7,94	12,00	4,40	4,75	0,80	●	●
DFT070408D50HP	7,94	12,00	4,40	4,75	0,80	●	●
DFT090508D56HP	9,92	15,00	5,50	5,25	0,80	●	●
DFT090508D63HP	9,92	15,00	5,50	5,25	0,80	●	●

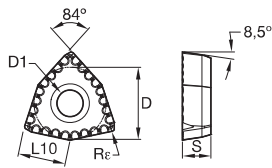
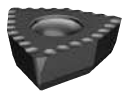

● first choice
○ alternate choice

P	●
M	○
K	○
N	○
S	○
H	○

■ DFT • DS

catalogue number	L10	D	D1	S	Rε	KCU40
DFT05T308D32DS	5,29	8,00	3,40	3,75	0,80	●
DFT05T308D33DS	5,29	8,00	3,40	3,75	0,80	●
DFT06T308D36DS	6,62	10,00	4,40	3,75	0,80	●
DFT06T308D39DS	6,62	10,00	4,40	3,75	0,80	●
DFT06T308D44DS	6,62	10,00	4,40	3,75	0,80	●
DFT070408D45DS	7,94	12,00	4,40	4,75	0,80	●
DFT070408D50DS	7,94	12,00	4,40	4,75	0,80	●
DFT090508D56DS	9,92	15,00	5,50	5,25	0,80	●
DFT090508D63DS	9,92	15,00	5,50	5,25	0,80	●

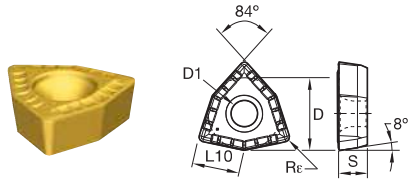

- first choice
- alternate choice

P	●
M	●
K	○
N	○
S	○
H	○



Modular Drills

■ DFT-MD

catalogue number	L10	D	D1	S	Rε	KC7140
DFT05T308D32MD	5,29	8,00	3,40	3,75	0,80	●
DFT05T308D33MD	5,29	8,00	3,40	3,75	0,80	●
DFT06T308D36MD	6,62	10,00	4,40	3,75	0,80	●
DFT06T308D39MD	6,62	10,00	4,40	3,75	0,80	●
DFT06T308D44MD	6,62	10,00	4,40	3,75	0,80	●
DFT070408D45MD	7,94	12,00	4,40	4,75	0,80	●
DFT070408D50MD	7,94	12,00	4,40	4,75	0,80	●
DFT090508D56MD	9,92	15,00	5,50	5,25	0,80	●
DFT090508D63MD	9,92	15,00	5,50	5,25	0,80	●

KSEM PLUS A1 Heads • Drill Fix DFR™ Inserts

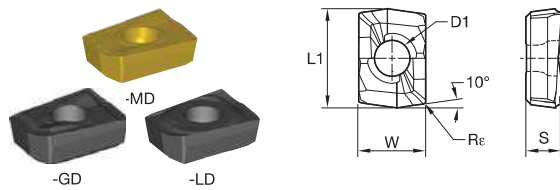

- first choice
- alternate choice

P	●	○	○	○
M	●	○	○	○
K	○	●	○	○
N	○	○	○	○
S	○	○	○	○
H	○	○	○	○

■ DFR-GD, -MD, -LD

catalogue number	LI	W	D1	S	Rε	KC7140	KC7225	KCU25	KCU40
DFR040304D28GD	10,76	7,26	2,85	3,79	0,40	—	—	●	●
DFR040304D28LD	10,76	7,26	2,85	3,78	0,40	—	●	—	—
DFR040304D28MD	10,76	7,26	2,85	3,79	0,40	●	—	—	—

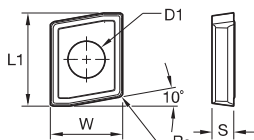

● first choice
○ alternate choice

P	●	○
M	○	○
K	○	○
N	○	○
S	○	○
H	○	○

DFC-HP

catalogue number	LI	W	D1	S	Re	KCU25	KCU40
DFC040310D28HP	10,00	7,60	2,85	3,18	0,50	●	●
DFC05T312D32HP	12,00	9,40	3,40	3,75	0,80	●	●
DFC06T312D36HP	16,00	12,40	4,40	3,75	0,80	●	●
DFC070416D45HP	18,00	14,50	4,40	4,75	0,80	●	●
DFC090520D56HP	24,00	19,00	5,50	5,25	0,80	●	●

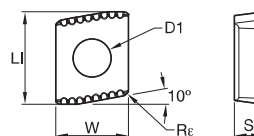

● first choice
○ alternate choice

P	●	○
M	○	○
K	○	○
N	○	○
S	○	○
H	○	○

DFC-DS

catalogue number	LI	W	D1	S	Re	KCU40
DFC040310D28DS	10,00	7,60	2,85	3,18	0,50	●
DFC05T312D32DS	12,00	9,40	3,40	3,75	0,80	●
DFC06T312D36DS	16,00	12,40	4,40	3,75	0,80	●
DFC070416D45DS	18,00	14,50	4,40	4,75	0,80	●
DFC090520D56DS	24,00	19,00	5,50	5,25	0,80	●

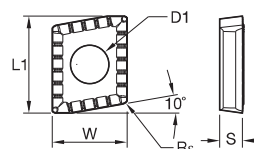
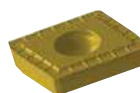

● first choice
○ alternate choice

P	●	○
M	○	○
K	○	○
N	○	○
S	○	○
H	○	○

DFC-MD

catalogue number	LI	W	D1	S	Re	KCU40	KCU7140
DFC040310D28MD	10,00	7,60	2,85	3,18	0,50	●	●
DFC05T312D32MD	12,00	9,40	3,40	3,75	0,80	●	●
DFC06T312D36MD	16,00	12,40	4,40	3,75	0,80	●	●
DFC070416D45MD	18,00	14,50	4,40	4,75	0,80	●	●
DFC090520D56MD	24,00	19,00	5,50	5,25	0,80	●	●

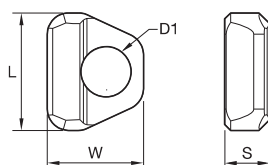
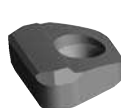

● first choice
○ alternate choice

P	●	○
M	○	○
K	○	○
N	○	○
S	○	○
H	○	○

DPA Guiding Pads

catalogue number	L		W		D1		S		KCU40
	mm	in	mm	in	mm	in	mm	in	
DPA07T3D25	8,60	.3390	7,00	.2760	2,85	.1120	3,50	.1380	●
DPA09T4D32	11,00	.4330	9,00	.3540	3,40	.1340	4,20	.1650	●
DPA13T5D50	16,00	.6300	13,00	.5120	4,40	.1730	5,20	.2050	●



- To ensure 100% system stability, KSEM™ inserts used for KSEM PLUS should not be reground.
- KSEM PLUS heads are shipped with all insert screws.
- KSEM PLUS heads are shipped with two wrenches, one for the KSEM insert and one to be used for the DFT™/DFR™ inserts as well as for the assembly of the body to the head.
- Order KSEM PLUS shanks using connection coupling size (CSMS) to determine which heads go with each shank.
- PDD in the callout drawing refers to the D1 of the KSEM HPG and HPCCL inserts for use with KSEM PLUS.
- Order inserts (KSEM, DFT, and DFR) for KSEM PLUS separately.

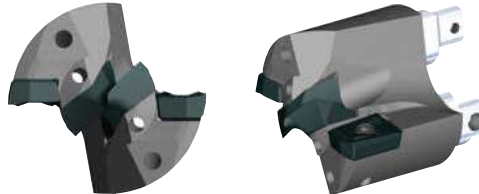
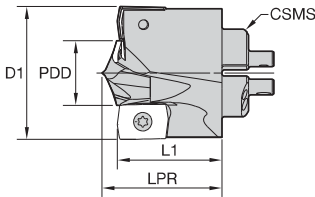

2 x DFR
diameter: 28–31,75mm

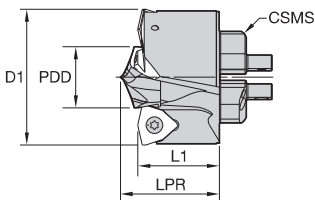

2 x DFT
diameter: 31,75–70,34mm

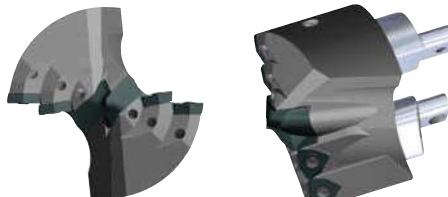
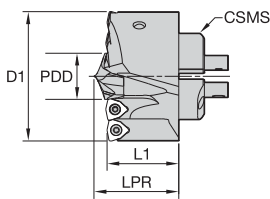

4 x DFT
diameter: 70,35–93,34mm

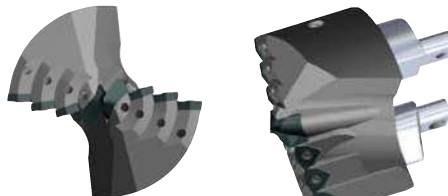
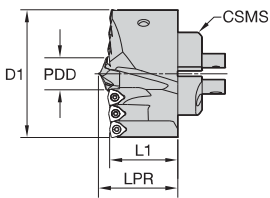

6 x DFT
diameter: 93,35–127mm

■ KSEM PLUS A1 Heads 28–101,60mm (1.102–4")

order number	ISO catalogue number	ANSI catalogue number	D1		PDD		LPR		L1		CSMS system size
			mm	in	mm	in	mm	in	mm	in	
4000408	KSEMP2800FDS28A1M	KSEMP2800FDS28A1M	28,00	1.102	14,00	.5512	24,9	.980	22,0	.866	FDS28
4047811	KSEMP2858FDS28A1M	KSEMP1125FDS28A1	28,58	1.125	15,00	.5906	25,0	.984	22,0	.866	FDS28
4047812	KSEMP2900FDS28A1M	KSEMP2900FDS28A1M	29,00	1.142	15,00	.5906	25,0	.984	22,0	.866	FDS28
4047823	KSEMP2937FDS28A1M	KSEMP1156FDS28A1	29,36	1.156	16,00	.6299	25,2	.992	22,0	.866	FDS28
4047824	KSEMP3000FDS28A1M	KSEMP3000FDS28A1M	30,00	1.181	16,00	.6299	25,2	.992	22,0	.866	FDS28
4047825	KSEMP3017FDS28A1M	KSEMP1188FDS28A1	30,18	1.188	17,00	.6693	25,4	1.000	22,0	.866	FDS28
4047826	KSEMP3096FDS28A1M	KSEMP1219FDS28A1	30,96	1.219	17,00	.6693	25,4	1.000	22,0	.866	FDS28
4047827	KSEMP3100FDS28A1M	KSEMP3100FDS28A1M	31,00	1.221	17,00	.6693	25,4	1.000	22,0	.866	FDS28
3794916	KSEMP3175FDS32A1M	KSEMP1250FDS32A1	31,75	1.250	15,00	.5906	23,0	.907	20,0	.787	FDS32
3794291	KSEMP3200FDS32A1M	KSEMP3200FDS32A1M	32,00	1.260	15,00	.5906	23,0	.907	20,0	.787	FDS32
3742210	KSEMP3300FDS32A1M	KSEMP3300FDS32A1M	33,00	1.299	16,00	.6299	23,2	.913	20,0	.787	FDS32
3793949	KSEMP3320FDS32A1M	KSEMP3320FDS32A1M	33,20	1.307	16,00	.6299	23,2	.913	20,0	.787	FDS32
3794917	KSEMP3334FDS32A1M	KSEMP1313FDS32A1	33,35	1.313	17,00	.6693	23,4	.920	20,0	.787	FDS32
3794292	KSEMP3400FDS32A1M	KSEMP3400FDS32A1M	34,00	1.339	17,00	.6693	23,4	.920	20,0	.787	FDS32
3794918	KSEMP3493FDS32A1M	KSEMP1375FDS32A1	34,93	1.375	18,00	.7087	23,6	.928	20,0	.787	FDS32
3794393	KSEMP3500FDS32A1M	KSEMP3500FDS32A1M	35,00	1.378	18,00	.7087	23,6	.928	20,0	.787	FDS32

(continued)

(KSEM PLUS A1 Heads 28–101,60mm (1.102–4") — continued)

Modular Drills

order number	ISO		ANSI		D1		PDD		LPR		L1		CSMS system size
	catalogue number	catalogue number	catalogue number	catalogue number	mm	in	mm	in	mm	in	mm	in	
3794394	KSEMP3600FDS36A1M	KSEMP3600FDS36A1M	KSEMP3600FDS36A1M	KSEMP3600FDS36A1M	36,00	1.417	13,00	.5118	22,7	.893	20,0	.787	FDS36
3794919	KSEMP3651FDS36A1M	KSEMP1438FDS36A1	KSEMP1438FDS36A1	KSEMP1438FDS36A1	36,53	1.438	14,00	.5512	22,9	.900	20,0	.787	FDS36
3794395	KSEMP3700FDS36A1M	KSEMP3700FDS36A1M	KSEMP3700FDS36A1M	KSEMP3700FDS36A1M	37,00	1.457	14,00	.5512	22,9	.900	20,0	.787	FDS36
3794427	KSEMP3750FDS36A1M	KSEMP3750FDS36A1M	KSEMP3750FDS36A1M	KSEMP3750FDS36A1M	37,50	1.476	15,00	.5906	23,0	.907	20,0	.787	FDS36
3794396	KSEMP3800FDS36A1M	KSEMP3800FDS36A1M	KSEMP3800FDS36A1M	KSEMP3800FDS36A1M	38,00	1.496	15,00	.5906	23,0	.907	20,0	.787	FDS36
3794920	KSEMP3810FDS36A1M	KSEMP1500FDS36A1	KSEMP1500FDS36A1	KSEMP1500FDS36A1	38,10	1.500	15,00	.5906	23,0	.907	20,0	.787	FDS36
3794397	KSEMP3900FDS36A1M	KSEMP3900FDS36A1M	KSEMP3900FDS36A1M	KSEMP3900FDS36A1M	39,00	1.535	16,00	.6299	23,2	.913	20,0	.787	FDS36
3793950	KSEMP3920FDS36A1M	KSEMP3920FDS36A1M	KSEMP3920FDS36A1M	KSEMP3920FDS36A1M	39,20	1.543	16,00	.6299	23,2	.913	20,0	.787	FDS36
3794921	KSEMP3970FDS36A1M	KSEMP1563FDS36A1	KSEMP1563FDS36A1	KSEMP1563FDS36A1	39,70	1.563	17,00	.6693	23,4	.920	20,0	.787	FDS36
3794398	KSEMP4000FDS40A1M	KSEMP4000FDS40A1M	KSEMP4000FDS40A1M	KSEMP4000FDS40A1M	40,00	1.575	17,00	.6693	28,6	1.125	25,0	.984	FDS40
3794399	KSEMP4100FDS40A1M	KSEMP4100FDS40A1M	KSEMP4100FDS40A1M	KSEMP4100FDS40A1M	41,00	1.614	18,00	.7087	28,8	1.132	25,0	.984	FDS40
3794922	KSEMP4128FDS40A1M	KSEMP1625FDS40A1	KSEMP1625FDS40A1	KSEMP1625FDS40A1	41,28	1.625	18,00	.7087	28,8	1.132	25,0	.984	FDS40
3794400	KSEMP4200FDS40A1M	KSEMP4200FDS40A1M	KSEMP4200FDS40A1M	KSEMP4200FDS40A1M	42,00	1.654	19,00	.7480	28,9	1.139	25,0	.984	FDS40
3794401	KSEMP4300FDS40A1M	KSEMP4300FDS40A1M	KSEMP4300FDS40A1M	KSEMP4300FDS40A1M	43,00	1.693	20,00	.7874	29,1	1.146	25,0	.984	FDS40
3794402	KSEMP4400FDS40A1M	KSEMP4400FDS40A1M	KSEMP4400FDS40A1M	KSEMP4400FDS40A1M	44,00	1.732	21,00	.8268	29,3	1.153	25,0	.984	FDS40
3794933	KSEMP4445FDS40A1M	KSEMP1750FDS40A1	KSEMP1750FDS40A1	KSEMP1750FDS40A1	44,45	1.750	22,00	.8661	29,5	1.160	25,0	.984	FDS40
3794403	KSEMP4500FDS45A1M	KSEMP4500FDS45A1M	KSEMP4500FDS45A1M	KSEMP4500FDS45A1M	45,00	1.772	18,00	.7087	28,8	1.132	25,0	.984	FDS45
3794404	KSEMP4600FDS45A1M	KSEMP4600FDS45A1M	KSEMP4600FDS45A1M	KSEMP4600FDS45A1M	46,00	1.811	19,00	.7480	28,9	1.139	25,0	.984	FDS45
3794405	KSEMP4700FDS45A1M	KSEMP4700FDS45A1M	KSEMP4700FDS45A1M	KSEMP4700FDS45A1M	47,00	1.850	20,00	.7874	29,1	1.146	25,0	.984	FDS45
3794934	KSEMP4763FDS45A1M	KSEMP1875FDS45A1	KSEMP1875FDS45A1	KSEMP1875FDS45A1	47,63	1.875	21,00	.8268	29,3	1.153	25,0	.984	FDS45
3794406	KSEMP4800FDS45A1M	KSEMP4800FDS45A1M	KSEMP4800FDS45A1M	KSEMP4800FDS45A1M	48,00	1.890	21,00	.8268	29,3	1.153	25,0	.984	FDS45
3794407	KSEMP4900FDS45A1M	KSEMP4900FDS45A1M	KSEMP4900FDS45A1M	KSEMP4900FDS45A1M	49,00	1.929	22,00	.8661	29,5	1.160	25,0	.984	FDS45
3742211	KSEMP5000FDS50A1M	KSEMP5000FDS50A1M	KSEMP5000FDS50A1M	KSEMP5000FDS50A1M	50,00	1.969	23,00	.9055	34,8	1.372	30,0	1.181	FDS50
3794935	KSEMP5080FDS50A1M	KSEMP2000FDS50A1	KSEMP2000FDS50A1	KSEMP2000FDS50A1	50,80	2.000	24,00	.9449	35,0	1.379	30,0	1.181	FDS50
3794408	KSEMP5100FDS50A1M	KSEMP5100FDS50A1M	KSEMP5100FDS50A1M	KSEMP5100FDS50A1M	51,00	2.008	24,00	.9449	35,0	1.379	30,0	1.181	FDS50
3794409	KSEMP5200FDS50A1M	KSEMP5200FDS50A1M	KSEMP5200FDS50A1M	KSEMP5200FDS50A1M	52,00	2.047	25,00	.9843	35,2	1.386	30,0	1.181	FDS50
3794410	KSEMP5300FDS50A1M	KSEMP5300FDS50A1M	KSEMP5300FDS50A1M	KSEMP5300FDS50A1M	53,00	2.087	26,00	1.0236	35,4	1.392	30,0	1.181	FDS50
3794936	KSEMP5398FDS50A1M	KSEMP2125FDS50A1	KSEMP2125FDS50A1	KSEMP2125FDS50A1	53,98	2.125	27,00	1.0630	35,6	1.399	30,0	1.181	FDS50
3794411	KSEMP5400FDS50A1M	KSEMP5400FDS50A1M	KSEMP5400FDS50A1M	KSEMP5400FDS50A1M	54,00	2.126	27,00	1.0630	35,6	1.399	30,0	1.181	FDS50
3794412	KSEMP5500FDS50A1M	KSEMP5500FDS50A1M	KSEMP5500FDS50A1M	KSEMP5500FDS50A1M	55,00	2.165	28,00	1.1024	35,7	1.406	30,0	1.181	FDS50
3794413	KSEMP5600FDS56A1M	KSEMP5600FDS56A1M	KSEMP5600FDS56A1M	KSEMP5600FDS56A1M	56,00	2.205	20,00	.7874	34,3	1.351	30,0	1.181	FDS56
3794414	KSEMP5700FDS56A1M	KSEMP5700FDS56A1M	KSEMP5700FDS56A1M	KSEMP5700FDS56A1M	57,00	2.244	21,00	.8268	34,5	1.358	30,0	1.181	FDS56
3794937	KSEMP5715FDS56A1M	KSEMP2250FDS56A1	KSEMP2250FDS56A1	KSEMP2250FDS56A1	57,15	2.250	21,00	.8268	34,5	1.358	30,0	1.181	FDS56
3794415	KSEMP5800FDS56A1M	KSEMP5800FDS56A1M	KSEMP5800FDS56A1M	KSEMP5800FDS56A1M	58,00	2.284	22,00	.8661	34,7	1.365	30,0	1.181	FDS56
3794416	KSEMP5900FDS56A1M	KSEMP5900FDS56A1M	KSEMP5900FDS56A1M	KSEMP5900FDS56A1M	59,00	2.323	23,00	.9055	34,8	1.372	30,0	1.181	FDS56
3794417	KSEMP6000FDS56A1M	KSEMP6000FDS56A1M	KSEMP6000FDS56A1M	KSEMP6000FDS56A1M	60,00	2.362	24,00	.9449	35,0	1.379	30,0	1.181	FDS56
3794938	KSEMP6033FDS56A1M	KSEMP2375FDS56A1	KSEMP2375FDS56A1	KSEMP2375FDS56A1	60,33	2.375	24,00	.9449	35,0	1.379	30,0	1.181	FDS56
3794418	KSEMP6100FDS56A1M	KSEMP6100FDS56A1M	KSEMP6100FDS56A1M	KSEMP6100FDS56A1M	61,00	2.402	25,00	.9843	35,2	1.386	30,0	1.181	FDS56
3794419	KSEMP6200FDS56A1M	KSEMP6200FDS56A1M	KSEMP6200FDS56A1M	KSEMP6200FDS56A1M	62,00	2.441	26,00	1.0236	35,4	1.392	30,0	1.181	FDS56
3794420	KSEMP6300FDS63A1M	KSEMP6300FDS63A1M	KSEMP6300FDS63A1M	KSEMP6300FDS63A1M	63,00	2.480	27,00	1.0630	41,8	1.643	36,0	1.417	FDS63
3794939	KSEMP6350FDS63A1M	KSEMP2500FDS63A1	KSEMP2500FDS63A1	KSEMP2500FDS63A1	63,50	2.500	28,00	1.1024	41,9	1.650	36,0	1.417	FDS63
3794421	KSEMP6400FDS63A1M	KSEMP6400FDS63A1M	KSEMP6400FDS63A1M	KSEMP6400FDS63A1M	64,00	2.520	28,00	1.1024	41,9	1.650	36,0	1.417	FDS63
3794422	KSEMP6500FDS63A1M	KSEMP6500FDS63A1M	KSEMP6500FDS63A1M	KSEMP6500FDS63A1M	65,00	2.559	29,00	1.1417	42,1	1.657	36,0	1.417	FDS63
3794423	KSEMP6600FDS63A1M	KSEMP6600FDS63A1M	KSEMP6600FDS63A1M	KSEMP6600FDS63A1M	66,00	2.598	30,00	1.1811	42,3	1.664	36,0	1.417	FDS63
3794940	KSEMP6668FDS63A1M	KSEMP2625FDS63A1	KSEMP2625FDS63A1	KSEMP2625FDS63A1	66,68	2.625	31,00	1.2205	42,5	1.671	36,0	1.417	FDS63
3794424	KSEMP6700FDS63A1M	KSEMP6700FDS63A1M	KSEMP6700FDS63A1M	KSEMP6700FDS63A1M	67,00	2.638	31,00	1.2205	42,5	1.671	36,0	1.417	FDS63
3794425	KSEMP6800FDS63A1M	KSEMP6800FDS63A1M	KSEMP6800FDS63A1M	KSEMP6800FDS63A1M	68,00	2.677	32,00	1.2598	42,6	1.678	36,0	1.417	FDS63
3794426	KSEMP6900FDS63A1M	KSEMP6900FDS63A1M	KSEMP6900FDS63A1M	KSEMP6900FDS63A1M	69,00	2.717	33,00	1.2992	42,8	1.685	36,0	1.417	FDS63
3794941	KSEMP6985FDS63A1M	KSEMP2750FDS63A1	KSEMP2750FDS63A1	KSEMP2750FDS63A1	69,85	2.750	34,00	1.3386	43,0	1.692	36,0	1.417	FDS63
3742212	KSEMP7000FDS63A1M	KSEMP7000FDS63A1M	KSEMP7000FDS63A1M	KSEMP7000FDS63A1M	70,00	2.756	34,00	1.3386	43,0	1.692	36,0	1.417	FDS63
6041904	KSEMP7100FDS71A1M	KSEMP7100FDS71A1M	KSEMP7100FDS71A1M	KSEMP7100FDS71A1M	71,00	2.795	26,00	1.0240	46,8	1.842	46,8	1.842	FDS71
5397513	KSEMP7200FDS71A1M	KSEMP7200FDS71A1M	KSEMP7200FDS71A1M	KSEMP7200FDS71A1M	72,00	2.835	27,00	1.0630	47,0	1.849	47,0	1.849	FDS71
6041906	KSEMP7300FDS71A1M	KSEMP7300FDS71A1M	KSEMP7300FDS71A1M	KSEMP7300FDS71A1M	73,00	2.874	28,00	1.1020	47,1	1.855	47,1	1.855	FDS71
6041931	KSEMP7303FDS71A1M	KSEMP2875FDS71A1	KSEMP2875FDS71A1	KSEMP2875FDS71A1	73,03	2.875	28,00	1.1020	47,1	1.855	47,1	1.855	FDS71
5397514	KSEMP7400FDS71A1M	KSEMP7400FDS71A1M	KSEMP7400FDS71A1M	KSEMP7400FDS71A1M	74,00	2.913	29,00	1.1420	47,3	1.863	47,3	1.863	FDS71
6041907	KSEMP7500FDS71A1M	KSEMP7500FDS71A1M	KSEMP7500FDS71A1M	KSEMP7500FDS71A1M	75,00	2.953	30,00	1.1810	47,5	1.869	47,5	1.869	FDS71

(continued)

(KSEM PLUS A1 Heads 28–101,60mm (1.102–4") — continued)

order number	ISO		ANSI		D1		PDD		LPR		L1		CSMS system size
	catalogue number	catalogue number	catalogue number	catalogue number	mm	in	mm	in	mm	in	mm	in	
5397515	KSEMP7600FDS71A1M	KSEMP7600FDS71A1M	KSEMP7600FDS71A1M	KSEMP7600FDS71A1M	76,00	2.992	31,00	1.2200	47,7	1.876	47,7	1.876	FDS71
5397516	KSEMP7620FDS71A1M	KSEMP3000FDS71A1	KSEMP3000FDS71A1	KSEMP3000FDS71A1	76,20	3.000	31,00	1.2200	47,7	1.876	47,7	1.876	FDS71
6041908	KSEMP7700FDS71A1M	KSEMP7700FDS71A1M	KSEMP7700FDS71A1M	KSEMP7700FDS71A1M	77,00	3.031	32,00	1.2600	47,8	1.883	47,8	1.883	FDS71
5397517	KSEMP7800FDS71A1M	KSEMP7800FDS71A1M	KSEMP7800FDS71A1M	KSEMP7800FDS71A1M	78,00	3.071	33,00	1.2990	48,0	1.890	48,0	1.890	FDS71
6041909	KSEMP7900FDS71A1M	KSEMP7900FDS71A1M	KSEMP7900FDS71A1M	KSEMP7900FDS71A1M	79,00	3.110	34,00	1.3390	48,2	1.897	48,2	1.897	FDS71
6041932	KSEMP7938FDS80A1M	KSEMP3125FDS80A1	KSEMP3125FDS80A1	KSEMP3125FDS80A1	79,38	3.125	31,00	1.2200	52,8	2.077	52,8	2.077	FDS80
5397518	KSEMP8000FDS80A1M	KSEMP8000FDS80A1M	KSEMP8000FDS80A1M	KSEMP8000FDS80A1M	80,00	3.150	31,00	1.2200	52,8	2.077	52,8	2.077	FDS80
6041910	KSEMP8100FDS80A1M	KSEMP8100FDS80A1M	KSEMP8100FDS80A1M	KSEMP8100FDS80A1M	81,00	3.189	32,00	1.2600	52,9	2.085	52,9	2.085	FDS80
5397519	KSEMP8200FDS80A1M	KSEMP8200FDS80A1M	KSEMP8200FDS80A1M	KSEMP8200FDS80A1M	82,00	3.228	33,00	1.2992	53,1	2.091	53,1	2.091	FDS80
5397550	KSEMP8255FDS80A1M	KSEMP3250FDS80A1	KSEMP3250FDS80A1	KSEMP3250FDS80A1	82,55	3.250	34,00	1.3386	53,3	2.098	53,3	2.098	FDS80
6041921	KSEMP8300FDS80A1M	KSEMP8300FDS80A1M	KSEMP8300FDS80A1M	KSEMP8300FDS80A1M	83,00	3.268	34,00	1.3390	53,3	2.098	53,3	2.098	FDS80
5397551	KSEMP8400FDS80A1M	KSEMP8400FDS80A1M	KSEMP8400FDS80A1M	KSEMP8400FDS80A1M	84,00	3.307	35,00	1.3780	53,5	2.105	53,5	2.105	FDS80
6041922	KSEMP8500FDS80A1M	KSEMP8500FDS80A1M	KSEMP8500FDS80A1M	KSEMP8500FDS80A1M	85,00	3.346	36,00	1.4170	53,6	2.112	53,6	2.112	FDS80
6041933	KSEMP8573FDS80A1M	KSEMP3375FDS80A1	KSEMP3375FDS80A1	KSEMP3375FDS80A1	85,73	3.375	37,00	1.4570	53,8	2.119	53,8	2.119	FDS80
5397552	KSEMP8600FDS80A1M	KSEMP8600FDS80A1M	KSEMP8600FDS80A1M	KSEMP8600FDS80A1M	86,00	3.386	37,00	1.4567	53,8	2.119	53,8	2.119	FDS80
6041923	KSEMP8700FDS80A1M	KSEMP8700FDS80A1M	KSEMP8700FDS80A1M	KSEMP8700FDS80A1M	87,00	3.425	38,00	1.4960	54,0	2.126	54,0	2.126	FDS80
5397553	KSEMP8800FDS80A1M	KSEMP8800FDS80A1M	KSEMP8800FDS80A1M	KSEMP8800FDS80A1M	88,00	3.465	39,00	1.5354	54,2	2.133	54,2	2.133	FDS80
5397554	KSEMP8890FDS80A1M	KSEMP3500FDS80A1	KSEMP3500FDS80A1	KSEMP3500FDS80A1	88,90	3.500	40,00	1.5748	54,3	2.140	54,3	2.140	FDS80
6041924	KSEMP8900FDS80A1M	KSEMP8900FDS80A1M	KSEMP8900FDS80A1M	KSEMP8900FDS80A1M	89,00	3.504	40,00	1.5750	54,3	2.140	54,3	2.140	FDS80
5397555	KSEMP9000FDS90A1M	KSEMP9000FDS90A1M	KSEMP9000FDS90A1M	KSEMP9000FDS90A1M	90,00	3.543	37,00	1.4567	59,2	2.332	59,2	2.332	FDS90
6041925	KSEMP9100FDS90A1M	KSEMP9100FDS90A1M	KSEMP9100FDS90A1M	KSEMP9100FDS90A1M	91,00	3.583	38,00	1.4960	59,4	2.339	59,4	2.339	FDS90
5397556	KSEMP9200FDS90A1M	KSEMP9200FDS90A1M	KSEMP9200FDS90A1M	KSEMP9200FDS90A1M	92,00	3.622	39,00	1.5354	59,6	2.346	59,6	2.346	FDS90
6041934	KSEMP9208FDS90A1M	KSEMP3625FDS90A1	KSEMP3625FDS90A1	KSEMP3625FDS90A1	92,08	3.625	39,00	1.5350	59,6	2.346	59,6	2.346	FDS90
6041926	KSEMP9300FDS90A1M	KSEMP9300FDS90A1M	KSEMP9300FDS90A1M	KSEMP9300FDS90A1M	93,00	3.661	40,00	1.5750	59,7	2.352	59,7	2.352	FDS90
5397557	KSEMP9400FDS90A1M	KSEMP9400FDS90A1M	KSEMP9400FDS90A1M	KSEMP9400FDS90A1M	94,00	3.701	26,00	1.0236	58,0	2.283	58,0	2.283	FDS90
6041927	KSEMP9500FDS90A1M	KSEMP9500FDS90A1M	KSEMP9500FDS90A1M	KSEMP9500FDS90A1M	95,00	3.740	27,00	1.0630	58,2	2.290	58,2	2.290	FDS90
5397558	KSEMP9525FDS90A1M	KSEMP3750FDS90A1	KSEMP3750FDS90A1	KSEMP3750FDS90A1	95,25	3.750	27,00	1.0630	58,3	2.297	58,3	2.297	FDS90
5397559	KSEMP9600FDS90A1M	KSEMP9600FDS90A1M	KSEMP9600FDS90A1M	KSEMP9600FDS90A1M	96,00	3.780	28,00	1.1024	58,3	2.297	58,3	2.297	FDS90
6041928	KSEMP9700FDS90A1M	KSEMP9700FDS90A1M	KSEMP9700FDS90A1M	KSEMP9700FDS90A1M	97,00	3.819	29,00	1.1420	58,5	2.304	58,5	2.304	FDS90
5397560	KSEMP9800FDS90A1M	KSEMP9800FDS90A1M	KSEMP9800FDS90A1M	KSEMP9800FDS90A1M	98,00	3.858	30,00	1.1811	58,7	2.311	58,7	2.311	FDS90
6041935	KSEMP9843FDS90A1M	KSEMP3875FDS90A1	KSEMP3875FDS90A1	KSEMP3875FDS90A1	98,43	3.875	31,00	1.2200	58,9	2.317	58,9	2.317	FDS90
6041929	KSEMP9900FDS90A1M	KSEMP9900FDS90A1M	KSEMP9900FDS90A1M	KSEMP9900FDS90A1M	99,00	3.898	31,00	1.2200	58,9	2.317	58,9	2.317	FDS90
6041930	KSEMP10000FDS90A1M	KSEMP10000FDS90A1M	KSEMP10000FDS90A1M	KSEMP10000FDS90A1M	100,00	3.937	32,00	1.2600	59,0	2.324	59,0	2.324	FDS90
5397561	KSEMP10160FDS90A1M	KSEMP4000FDS90A1	KSEMP4000FDS90A1	KSEMP4000FDS90A1	101,60	4.000	34,00	1.3390	59,4	2.338	59,4	2.338	FDS90





- To ensure 100% system stability, KSEM™ inserts used for KSEM PLUS should not be reground.
- KSEM PLUS heads are shipped with all insert screws.
- KSEM PLUS B1 heads are shipped with two or three wrenches, one for the KSEM insert, one for DFC™ inserts and DPA guiding pads, as well as for assembling the head onto the tool body. One additional wrench might be added depending on the size of the guiding pad.
- Order KSEM PLUS shanks using connection coupling size (CSMS) to determine which heads go with each shank.
- PDD in the callout drawing refers to the D1 of the KSEM, HPGM, and HPCM inserts for use with KSEM PLUS.
- Order inserts (KSEM, DFC) for KSEM PLUS separately.

Modular Drills

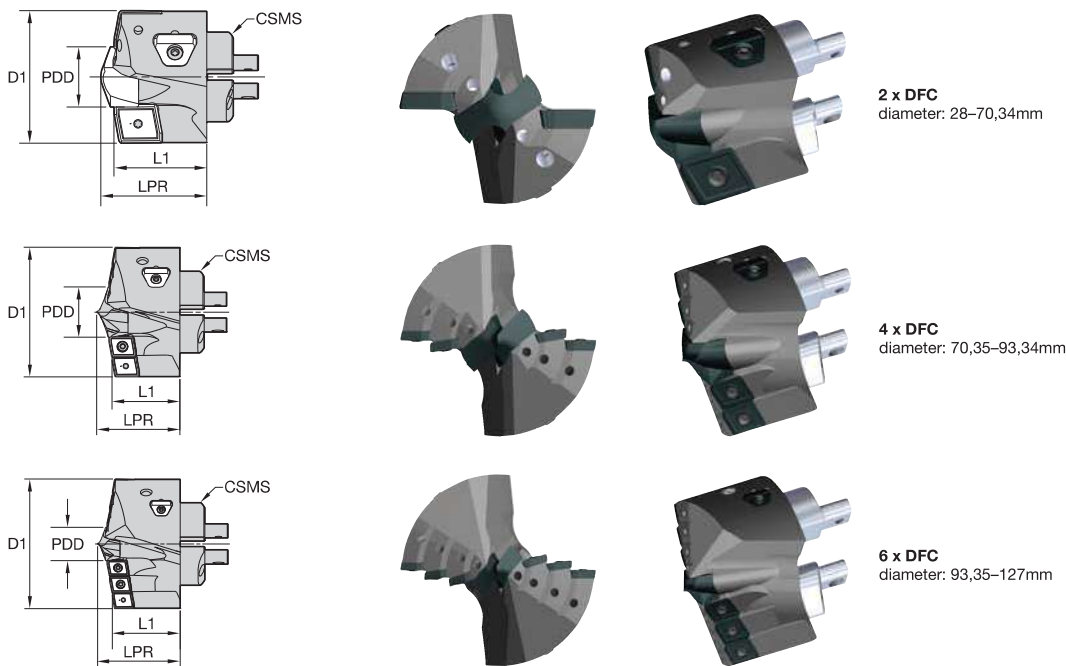

■ KSEM PLUS B1 Heads 28–101,60mm (1.102–4")

order number	ISO catalogue number	ANSI catalogue number	D1		PDD		LPR		L1		CSMS system size
			mm	in	mm	in	mm	in	mm	in	
5115736	KSEMP2800FDS28B1M	KSEMP2800FDS28B1M	28,00	1.102	14,00	.5512	28,1	1.105	25,0	.984	FDS28
5115737	KSEMP2858FDS28B1M	KSEMP1125FDS28B1	28,58	1.125	15,00	.5906	28,2	1.110	25,0	.984	FDS28
5115738	KSEMP2900FDS28B1M	KSEMP2900FDS28B1M	29,00	1.142	15,00	.5906	28,2	1.111	25,0	.984	FDS28
5115739	KSEMP2937FDS28B1M	KSEMP1156FDS28B1	29,36	1.156	16,00	.6299	28,4	1.118	25,0	.984	FDS28
5116010	KSEMP3000FDS28B1M	KSEMP3000FDS28B1M	30,00	1.181	16,00	.6299	28,4	1.118	25,0	.984	FDS28
5116011	KSEMP3017FDS28B1M	KSEMP1188FDS28B1	30,18	1.188	17,00	.6693	28,6	1.125	25,0	.984	FDS28
5116012	KSEMP3096FDS28B1M	KSEMP1219FDS28B1	30,96	1.219	17,00	.6693	28,6	1.125	25,0	.984	FDS28
5116013	KSEMP3100FDS28B1M	KSEMP3100FDS28B1M	31,00	1.220	17,00	.6693	28,6	1.125	25,0	.984	FDS28
5116014	KSEMP3175FDS32B1M	KSEMP1250FDS32B1	31,75	1.250	15,00	.5906	28,2	1.111	25,0	.984	FDS32
5116015	KSEMP3200FDS32B1M	KSEMP3200FDS32B1M	32,00	1.260	15,00	.5906	28,2	1.111	25,0	.984	FDS32
5116016	KSEMP3300FDS32B1M	KSEMP3300FDS32B1M	33,00	1.299	16,00	.6299	28,4	1.118	25,0	.984	FDS32
5116017	KSEMP3320FDS32B1M	KSEMP3320FDS32B1M	33,20	1.307	16,00	.6299	28,4	1.118	25,0	.984	FDS32
5116018	KSEMP3334FDS32B1M	KSEMP1313FDS32B1	33,35	1.313	17,00	.6693	28,6	1.125	25,0	.984	FDS32
5116019	KSEMP3400FDS32B1M	KSEMP3400FDS32B1M	34,00	1.339	17,00	.6693	28,6	1.125	25,0	.984	FDS32
5116030	KSEMP3493FDS32B1M	KSEMP1375FDS32B1	34,93	1.375	18,00	.7087	28,8	1.132	25,0	.984	FDS32
5116031	KSEMP3500FDS32B1M	KSEMP3500FDS32B1M	35,00	1.378	18,00	.7087	28,8	1.132	25,0	.984	FDS32
5116032	KSEMP3600FDS36B1M	KSEMP3600FDS36B1M	36,00	1.417	13,00	.5118	27,9	1.098	25,0	.984	FDS36
5116033	KSEMP3651FDS36B1M	KSEMP1438FDS36B1	36,53	1.438	14,00	.5512	28,1	1.105	25,0	.984	FDS36
5116034	KSEMP3700FDS36B1M	KSEMP3700FDS36B1M	37,00	1.457	14,00	.5512	28,1	1.105	25,0	.984	FDS36
5116035	KSEMP3750FDS36B1M	KSEMP3750FDS36B1M	37,50	1.476	15,00	.5906	28,2	1.111	25,0	.984	FDS36

(continued)

(KSEM PLUS B1 Heads 28–101,60mm (1.102–4") — continued)

order number	ISO catalogue number	ANSI catalogue number	D1		PDD		LPR		L1		CSMS system size
			mm	in	mm	in	mm	in	mm	in	
5116036	KSEMP3800FDS36B1M	KSEMP3800FDS36B1M	38,00	1.496	15,00	.5906	28,2	1.111	25,0	.984	FDS36
5116037	KSEMP3810FDS36B1M	KSEMP1500FDS36B1	38,10	1.500	15,00	.5906	28,2	1.111	25,0	.984	FDS36
5116038	KSEMP3900FDS36B1M	KSEMP3900FDS36B1M	39,00	1.535	16,00	.6299	28,4	1.118	25,0	.984	FDS36
5116039	KSEMP3920FDS36B1M	KSEMP3920FDS36B1M	39,20	1.543	16,00	.6299	28,4	1.118	25,0	.984	FDS36
5116040	KSEMP3970FDS36B1M	KSEMP1563FDS36B1	39,70	1.563	17,00	.6693	28,6	1.125	25,0	.984	FDS36
5116041	KSEMP4000FDS40B1M	KSEMP4000FDS40B1M	40,00	1.575	17,00	.6693	33,8	1.330	30,0	1.181	FDS40
5116042	KSEMP4100FDS40B1M	KSEMP4100FDS40B1M	41,00	1.614	18,00	.7087	34,0	1.337	30,0	1.181	FDS40
5116043	KSEMP4128FDS40B1M	KSEMP1625FDS40B1	41,28	1.625	18,00	.7087	34,0	1.337	30,0	1.181	FDS40
5116044	KSEMP4200FDS40B1M	KSEMP4200FDS40B1M	42,00	1.654	19,00	.7480	34,1	1.344	30,0	1.181	FDS40
5116045	KSEMP4300FDS40B1M	KSEMP4300FDS40B1M	43,00	1.693	20,00	.7874	34,3	1.351	30,0	1.181	FDS40
5116046	KSEMP4400FDS40B1M	KSEMP4400FDS40B1M	44,00	1.732	21,00	.8268	34,5	1.358	30,0	1.181	FDS40
5116047	KSEMP4445FDS40B1M	KSEMP1750FDS40B1	44,45	1.750	22,00	.8661	34,7	1.365	30,0	1.181	FDS40
5116098	KSEMP4500FDS45B1M	KSEMP4500FDS45B1M	45,00	1.772	18,00	.7087	34,0	1.337	30,0	1.181	FDS45
5116099	KSEMP4600FDS45B1M	KSEMP4600FDS45B1M	46,00	1.811	19,00	.7480	34,1	1.344	30,0	1.181	FDS45
5116110	KSEMP4700FDS45B1M	KSEMP4700FDS45B1M	47,00	1.850	20,00	.7874	34,3	1.351	30,0	1.181	FDS45
5116111	KSEMP4763FDS45B1M	KSEMP1875FDS45B1	47,63	1.875	21,00	.8268	34,5	1.358	30,0	1.181	FDS45
5116112	KSEMP4800FDS45B1M	KSEMP4800FDS45B1M	48,00	1.890	21,00	.8268	34,5	1.358	30,0	1.181	FDS45
5116113	KSEMP4900FDS45B1M	KSEMP4900FDS45B1M	49,00	1.929	22,00	.8661	34,7	1.365	30,0	1.181	FDS45
5116114	KSEMP5000FDS50B1M	KSEMP5000FDS50B1M	50,00	1.969	23,00	.9055	40,0	1.577	35,0	1.378	FDS50
5116115	KSEMP5080FDS50B1M	KSEMP2000FDS50B1	50,80	2.000	24,00	.9449	40,2	1.584	35,0	1.378	FDS50
5116116	KSEMP5100FDS50B1M	KSEMP5100FDS50B1M	51,00	2.008	24,00	.9449	40,2	1.584	35,0	1.378	FDS50
5116117	KSEMP5200FDS50B1M	KSEMP5200FDS50B1M	52,00	2.047	25,00	.9843	40,4	1.590	35,0	1.378	FDS50
5116118	KSEMP5300FDS50B1M	KSEMP5300FDS50B1M	53,00	2.087	26,00	1.0236	40,6	1.597	35,0	1.378	FDS50
5116119	KSEMP5398FDS50B1M	KSEMP2125FDS50B1	53,98	2.125	27,00	1.0630	40,8	1.604	35,0	1.378	FDS50
5116120	KSEMP5400FDS50B1M	KSEMP5400FDS50B1M	54,00	2.126	27,00	1.0630	40,8	1.604	35,0	1.378	FDS50
5116121	KSEMP5500FDS50B1M	KSEMP5500FDS50B1M	55,00	2.165	28,00	1.1024	40,9	1.611	35,0	1.378	FDS50
5116122	KSEMP5600FDS56B1M	KSEMP5600FDS56B1M	56,00	2.205	20,00	.7874	39,5	1.556	35,0	1.378	FDS56
5116123	KSEMP5700FDS56B1M	KSEMP5700FDS56B1M	57,00	2.244	21,00	.8268	39,7	1.563	35,0	1.378	FDS56
5116124	KSEMP5715FDS56B1M	KSEMP2250FDS56B1	57,15	2.250	21,00	.8268	39,7	1.563	35,0	1.378	FDS56
5116125	KSEMP5800FDS56B1M	KSEMP5800FDS56B1M	58,00	2.283	22,00	.8661	39,9	1.570	35,0	1.378	FDS56
5116126	KSEMP5900FDS56B1M	KSEMP5900FDS56B1M	59,00	2.323	23,00	.9055	40,0	1.577	35,0	1.378	FDS56
5116127	KSEMP6000FDS56B1M	KSEMP6000FDS56B1M	60,00	2.362	24,00	.9449	40,2	1.584	35,0	1.378	FDS56
5116128	KSEMP6033FDS56B1M	KSEMP2375FDS56B1	60,33	2.375	24,00	.9449	40,2	1.584	35,0	1.378	FDS56
5116129	KSEMP6100FDS56B1M	KSEMP6100FDS56B1M	61,00	2.402	25,00	.9843	40,4	1.590	35,0	1.378	FDS56
5116130	KSEMP6200FDS56B1M	KSEMP6200FDS56B1M	62,00	2.441	26,00	1.0236	40,6	1.597	35,0	1.378	FDS56
5116131	KSEMP6300FDS63B1M	KSEMP6300FDS63B1M	63,00	2.480	27,00	1.0630	46,0	1.809	40,0	1.575	FDS63
5116132	KSEMP6350FDS63B1M	KSEMP2500FDS63B1	63,50	2.500	28,00	1.1024	46,1	1.816	40,0	1.575	FDS63
5116133	KSEMP6400FDS63B1M	KSEMP6400FDS63B1M	64,00	2.520	28,00	1.1024	46,1	1.816	40,0	1.575	FDS63
5116134	KSEMP6500FDS63B1M	KSEMP6500FDS63B1M	65,00	2.559	29,00	1.1417	46,3	1.823	40,0	1.575	FDS63
5116135	KSEMP6600FDS63B1M	KSEMP6600FDS63B1M	66,00	2.598	30,00	1.1811	46,5	1.830	40,0	1.575	FDS63
5116136	KSEMP6668FDS63B1M	KSEMP2625FDS63B1	66,68	2.625	31,00	1.2205	46,7	1.837	40,0	1.575	FDS63
5116137	KSEMP6700FDS63B1M	KSEMP6700FDS63B1M	67,00	2.638	31,00	1.2205	46,7	1.837	40,0	1.575	FDS63
5116138	KSEMP6800FDS63B1M	KSEMP6800FDS63B1M	68,00	2.677	32,00	1.2598	46,8	1.844	40,0	1.575	FDS63
5116139	KSEMP6900FDS63B1M	KSEMP6900FDS63B1M	69,00	2.717	33,00	1.2992	47,0	1.851	40,0	1.575	FDS63
5116140	KSEMP6985FDS63B1M	KSEMP2750FDS63B1	69,85	2.750	34,00	1.3386	47,2	1.858	40,0	1.575	FDS63
5116141	KSEMP7000FDS63B1M	KSEMP7000FDS63B1M	70,00	2.756	34,00	1.3386	47,2	1.858	40,0	1.575	FDS63
6041937	KSEMP7100FDS71B1M	KSEMP7100FDS71B1M	71,00	2.795	26,00	1.0240	47,9	1.885	40,0	1.575	FDS71
6041797	KSEMP7200FDS71B1M	KSEMP7200FDS71B1M	72,00	2.835	27,00	1.0630	48,1	1.892	40,0	1.575	FDS71
6041938	KSEMP7300FDS71B1M	KSEMP7300FDS71B1M	73,00	2.874	28,00	1.1020	48,2	1.899	40,0	1.575	FDS71
6042002	KSEMP7303FDS71B1M	KSEMP2875FDS71B1	73,03	2.875	28,00	1.1020	48,2	1.899	40,0	1.575	FDS71
6041798	KSEMP7400FDS71B1M	KSEMP7400FDS71B1M	74,00	2.913	29,00	1.1420	48,4	1.906	40,0	1.575	FDS71
6041939	KSEMP7500FDS71B1M	KSEMP7500FDS71B1M	75,00	2.953	30,00	1.1810	48,6	1.913	40,0	1.575	FDS71
6041799	KSEMP7600FDS71B1M	KSEMP7600FDS71B1M	76,00	2.992	31,00	1.2200	48,8	1.919	40,0	1.575	FDS71
5397562	KSEMP7620FDS71B1M	KSEMP3000FDS71B1	76,20	3.000	31,00	1.2200	48,8	1.919	48,8	1.919	FDS71
6041940	KSEMP7700FDS71B1M	KSEMP7700FDS71B1M	77,00	3.031	32,00	1.2600	48,9	1.927	40,0	1.575	FDS71
6041800	KSEMP7800FDS71B1M	KSEMP7800FDS71B1M	78,00	3.071	33,00	1.2990	49,1	1.933	40,0	1.575	FDS71

(continued)

(KSEM PLUS B1 Heads 28–101,60mm (1.102–4") — continued)

Modular Drills

order number	ISO catalogue number	ANSI catalogue number	D1		PDD		LPR		L1		CSMS system size
			mm	in	mm	in	mm	in	mm	in	
6041991	KSEMP7900FDS71B1M	KSEMP7900FDS71B1M	79,00	3.110	34,00	1.3390	49,3	1.940	40,0	1.575	FDS71
6042003	KSEMP7938FDS80B1M	KSEMP3125FDS80B1	79,38	3.125	31,00	1.2200	54,1	2.128	45,0	1.772	FDS80
6041881	KSEMP8000FDS80B1M	KSEMP8000FDS80B1M	80,00	3.150	31,00	1.2200	54,1	2.128	45,0	1.772	FDS80
6041992	KSEMP8100FDS80B1M	KSEMP8100FDS80B1M	81,00	3.189	32,00	1.2600	54,2	2.135	45,0	1.772	FDS80
6041882	KSEMP8200FDS80B1M	KSEMP8200FDS80B1M	82,00	3.228	33,00	1.2990	54,4	2.142	45,0	1.772	FDS80
5397563	KSEMP8255FDS80B1M	KSEMP3250FDS80B1	82,55	3.250	34,00	1.3386	54,6	2.149	54,6	2.149	FDS80
6041993	KSEMP8300FDS80B1M	KSEMP8300FDS80B1M	83,00	3.268	34,00	1.3390	54,6	2.149	45,0	1.772	FDS80
6041883	KSEMP8400FDS80B1M	KSEMP8400FDS80B1M	84,00	3.307	35,00	1.3780	54,8	2.156	45,0	1.772	FDS80
6041994	KSEMP8500FDS80B1M	KSEMP8500FDS80B1M	85,00	3.346	36,00	1.4170	54,9	2.163	45,0	1.772	FDS80
6042004	KSEMP8573FDS80B1M	KSEMP3375FDS80B1	85,73	3.375	37,00	1.4570	55,1	2.170	45,0	1.772	FDS80
6041884	KSEMP8600FDS80B1M	KSEMP8600FDS80B1M	86,00	3.386	37,00	1.4570	55,1	2.170	45,0	1.772	FDS80
6041995	KSEMP8700FDS80B1M	KSEMP8700FDS80B1M	87,00	3.425	38,00	1.4960	55,3	2.177	45,0	1.772	FDS80
6041885	KSEMP8800FDS80B1M	KSEMP8800FDS80B1M	88,00	3.465	39,00	1.5350	55,5	2.184	45,0	1.772	FDS80
5397564	KSEMP8890FDS80B1M	KSEMP3500FDS80B1	88,90	3.500	40,00	1.5748	55,6	2.190	55,6	2.190	FDS80
6041996	KSEMP8900FDS80B1M	KSEMP8900FDS80B1M	89,00	3.504	40,00	1.5750	55,6	2.190	45,0	1.772	FDS80
6041886	KSEMP9000FDS90B1M	KSEMP9000FDS90B1M	90,00	3.543	37,00	1.4570	60,3	2.375	50,0	1.969	FDS90
6041997	KSEMP9100FDS90B1M	KSEMP9100FDS90B1M	91,00	3.583	38,00	1.4960	60,5	2.382	50,0	1.969	FDS90
6041887	KSEMP9200FDS90B1M	KSEMP9200FDS90B1M	92,00	3.622	39,00	1.5350	60,7	2.389	50,0	1.969	FDS90
6042005	KSEMP9208FDS90B1M	KSEMP3625FDS90B1	92,08	3.625	39,00	1.5350	60,7	2.389	50,0	1.969	FDS90
6041998	KSEMP9300FDS90B1M	KSEMP9300FDS90B1M	93,00	3.661	40,00	1.5750	60,8	2.395	50,0	1.969	FDS90
6041888	KSEMP9400FDS90B1M	KSEMP9400FDS90B1M	94,00	3.701	26,00	1.0240	60,4	2.376	50,0	1.968	FDS90
6041999	KSEMP9500FDS90B1M	KSEMP9500FDS90B1M	95,00	3.740	27,00	1.0630	60,6	2.383	50,0	1.968	FDS90
5397565	KSEMP9525FDS90B1M	KSEMP3750FDS90B1	95,25	3.750	27,00	1.0630	60,6	2.383	60,6	2.383	FDS90
6041889	KSEMP9600FDS90B1M	KSEMP9600FDS90B1M	96,00	3.780	28,00	1.1020	60,7	2.390	50,0	1.968	FDS90
6042000	KSEMP9700FDS90B1M	KSEMP9700FDS90B1M	97,00	3.819	29,00	1.1420	60,9	2.398	50,0	1.968	FDS90
6041890	KSEMP9800FDS90B1M	KSEMP9800FDS90B1M	98,00	3.858	30,00	1.1810	61,1	2.404	50,0	1.968	FDS90
6042006	KSEMP9843FDS90B1M	KSEMP3875FDS90B1	98,43	3.875	31,00	1.2200	61,3	2.411	50,0	1.968	FDS90
6042001	KSEMP9900FDS90B1M	KSEMP9900FDS90B1M	99,00	3.898	31,00	1.2200	61,3	2.412	50,0	1.969	FDS90
6041901	KSEMP10000FDS90B1M	KSEMP10000FDS90B1M	100,00	3.937	32,00	1.2600	61,4	2.418	50,0	1.968	FDS90
5397566	KSEMP10160FDS90B1M	KSEMP4000FDS90B1	101,60	4.000	34,00	1.3390	61,8	2.432	61,8	2.432	FDS90

NOTE: When one screw is listed, it is for both insert and guiding pad. When two screws are listed, the first one is for the insert screw, and the second one is for the guiding pad. Find complete KSEM PLUS B1 product overview on pages H84-H86.

- The following pages consolidate required spare parts for KSEM PLUS heads.
- Tables show each spare part followed by required screw driver (if applicable).
- Adjustment shims for DPA guide pads on KSEM PLUS B1 heads come as easy-to-use shim packs.
- Please find reference for spare part location below.

KSEM PLUS A1 Heads • Spare Parts

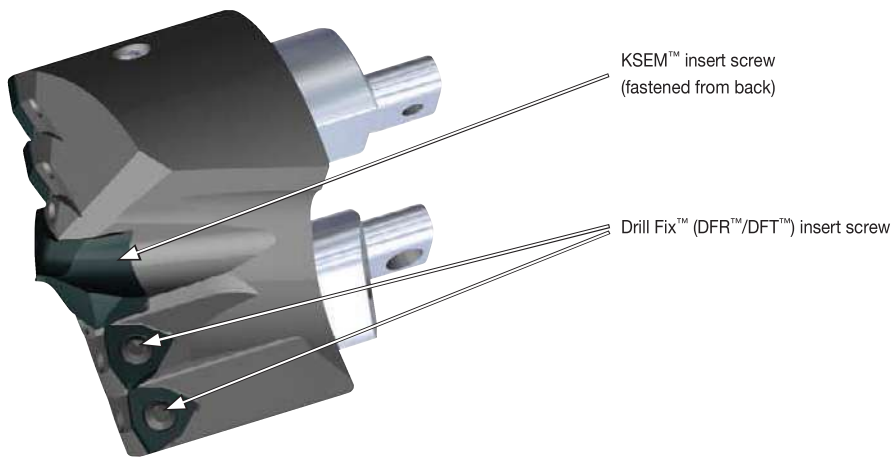



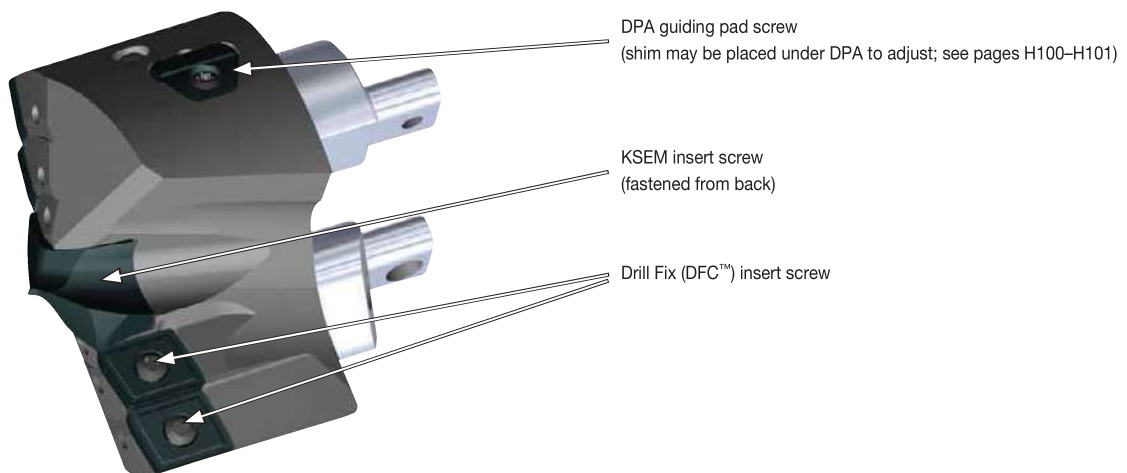

KSEM PLUS B1 Heads • Spare Parts







■ KSEM PLUS A1 Heads 28–101,60mm (1.102–4") • Spare Parts

Modular Drills

D1		PDD						
mm	in	mm	in	CSMS system size	KSEM insert screw	KSEM wrench	Drill Fix insert screw	Drill Fix wrench
28,00	1.102	14,00	.551	FDS28	364.016	170.350	192.432	170.352
28,58	1.125	15,00	.591	FDS28	364.016	170.350	192.432	170.352
29,00	1.142	15,00	.591	FDS28	364.016	170.350	192.432	170.352
29,36	1.156	16,00	.630	FDS28	364.010	170.345	192.432	170.352
30,00	1.181	16,00	.630	FDS28	364.010	170.345	192.432	170.352
30,18	1.188	17,00	.669	FDS28	364.010	170.345	192.432	170.352
30,96	1.219	17,00	.669	FDS28	364.010	170.345	192.432	170.352
31,00	1.221	17,00	.669	FDS28	364.010	170.345	192.432	170.352
31,75	1.250	15,00	.591	FDS32	364.016	170.350	191.924	170.353
32,00	1.260	15,00	.591	FDS32	364.016	170.350	191.924	170.353
33,00	1.299	16,00	.630	FDS32	364.010	170.345	191.924	170.353
33,20	1.307	16,00	.630	FDS32	364.010	170.345	191.924	170.353
33,35	1.313	17,00	.669	FDS32	364.010	170.345	191.924	170.353
34,00	1.339	17,00	.669	FDS32	364.010	170.345	191.924	170.353
34,93	1.375	18,00	.709	FDS32	364.010	170.345	191.924	170.353
35,00	1.378	18,00	.709	FDS32	364.010	170.345	191.924	170.353
36,00	1.417	13,00	.512	FDS36	364.016	170.350	191.916	170.355
36,53	1.438	14,00	.551	FDS36	364.016	170.350	191.916	170.355
37,00	1.457	14,00	.551	FDS36	364.016	170.350	191.916	170.355
37,50	1.476	15,00	.591	FDS36	364.016	170.350	191.916	170.355
38,00	1.496	15,00	.591	FDS36	364.016	170.350	191.916	170.355
38,10	1.500	15,00	.591	FDS36	364.016	170.350	191.916	170.355
39,00	1.535	16,00	.630	FDS36	364.010	170.345	191.916	170.355
39,20	1.543	16,00	.630	FDS36	364.010	170.345	191.916	170.355
39,70	1.563	17,00	.669	FDS36	364.010	170.345	191.916	170.355
40,00	1.575	17,00	.669	FDS40	364.010	170.345	191.916	170.355
41,00	1.614	18,00	.709	FDS40	364.010	170.345	191.916	170.355
41,28	1.625	18,00	.709	FDS40	364.010	170.345	191.916	170.355
42,00	1.654	19,00	.748	FDS40	364.010	170.345	191.916	170.355
43,00	1.693	20,00	.787	FDS40	364.011	170.346	191.916	170.355
44,00	1.732	21,00	.827	FDS40	364.011	170.346	191.916	170.355
44,45	1.750	22,00	.866	FDS40	364.011	170.346	191.916	170.355
45,00	1.772	18,00	.709	FDS45	364.010	170.345	191.698	170.355
46,00	1.811	19,00	.748	FDS45	364.010	170.345	191.698	170.355
47,00	1.850	20,00	.787	FDS45	364.011	170.346	191.698	170.355
47,63	1.875	21,00	.827	FDS45	364.011	170.346	191.698	170.355
48,00	1.890	21,00	.827	FDS45	364.011	170.346	191.698	170.355
49,00	1.929	22,00	.866	FDS45	364.011	170.346	191.698	170.355
50,00	1.969	23,00	.906	FDS50	364.011	170.346	191.698	170.355
50,80	2.000	24,00	.945	FDS50	364.011	170.346	191.698	170.355
51,00	2.008	24,00	.945	FDS50	364.011	170.346	191.698	170.355
52,00	2.047	25,00	.984	FDS50	364.012	170.347	191.698	170.355
53,00	2.087	26,00	1.024	FDS50	364.012	170.347	191.698	170.355
53,98	2.125	27,00	1.063	FDS50	364.012	170.347	191.698	170.355
54,00	2.126	27,00	1.063	FDS50	364.012	170.347	191.698	170.355
55,00	2.165	28,00	1.102	FDS50	364.012	170.347	191.698	170.355
56,00	2.205	20,00	.787	FDS56	364.011	170.346	191.726	170.356
57,00	2.244	21,00	.827	FDS56	364.011	170.346	191.726	170.356
57,15	2.250	21,00	.827	FDS56	364.011	170.346	191.726	170.356
58,00	2.284	22,00	.866	FDS56	364.011	170.346	191.726	170.356
59,00	2.323	23,00	.906	FDS56	364.011	170.346	191.726	170.356
60,00	2.362	24,00	.945	FDS56	364.011	170.346	191.726	170.356
60,33	2.375	24,00	.945	FDS56	364.011	170.346	191.726	170.356
61,00	2.402	25,00	.984	FDS56	364.012	170.347	191.726	170.356
62,00	2.441	26,00	1.024	FDS56	364.012	170.347	191.726	170.356
63,00	2.480	27,00	1.063	FDS63	364.012	170.347	191.726	170.356

(continued)

(KSEM PLUS A1 Heads 28–101,60mm (1.102–4") • Spare Parts — continued)

D1		PDD							
mm	in	mm	in	CSMS system size	KSEM insert screw	KSEM wrench	Drill Fix insert screw	Drill Fix wrench	
63,50	2.500	28,00	1.102	FDS63	364.012	170.347	191.726	170.356	
64,00	2.520	28,00	1.102	FDS63	364.012	170.347	191.726	170.356	
65,00	2.559	29,00	1.142	FDS63	364.013	170.348	191.726	170.356	
66,00	2.598	30,00	1.181	FDS63	364.013	170.348	191.726	170.356	
66,68	2.625	31,00	1.221	FDS63	364.013	170.348	191.726	170.356	
67,00	2.638	31,00	1.221	FDS63	364.013	170.348	191.726	170.356	
68,00	2.677	32,00	1.260	FDS63	364.013	170.348	191.726	170.356	
69,00	2.717	33,00	1.299	FDS63	364.015	170.348	191.726	170.356	
69,85	2.750	34,00	1.339	FDS63	364.015	170.348	191.726	170.356	
70,00	2.756	34,00	1.339	FDS63	364.015	170.348	191.726	170.356	
71,00	2.795	26,00	1.024	FDS71	364.012	170.347	191.916	170.355	
72,00	2.835	27,00	1.063	FDS71	364.012	170.347	191.916	170.355	
73,00	2.874	28,00	1.102	FDS71	364.012	170.347	191.916	170.355	
73,03	2.875	28,00	1.102	FDS71	364.012	170.347	191.916	170.355	
74,00	2.913	29,00	1.142	FDS71	364.013	170.365	191.916	170.355	
75,00	2.953	30,00	1.181	FDS71	364.013	170.365	191.916	170.355	
76,00	2.992	31,00	1.220	FDS71	364.013	170.365	191.916	170.355	
76,20	3.000	31,00	1.220	FDS71	364.013	170.365	191.916	170.355	
77,00	3.031	32,00	1.260	FDS71	364.013	170.365	191.916	170.355	
78,00	3.071	33,00	1.299	FDS71	364.015	170.365	191.916	170.355	
79,00	3.110	34,00	1.339	FDS71	364.015	170.365	191.916	170.355	
79,38	3.125	31,00	1.220	FDS80	364.013	170.365	191.916	170.355	
80,00	3.150	31,00	1.220	FDS80	364.013	170.365	191.916	170.355	
81,00	3.189	32,00	1.260	FDS80	364.013	170.365	191.916	170.355	
82,00	3.228	33,00	1.299	FDS80	364.015	170.365	191.916	170.355	
82,55	3.250	34,00	1.339	FDS80	364.015	170.365	191.916	170.355	
83,00	3.268	34,00	1.339	FDS80	364.015	170.365	191.916	170.355	
84,00	3.307	35,00	1.378	FDS80	364.015	170.365	191.916	170.355	
85,00	3.346	36,00	1.417	FDS80	364.015	170.365	191.916	170.355	
85,73	3.375	37,00	1.457	FDS80	364.015	170.365	191.916	170.355	
86,00	3.386	37,00	1.457	FDS80	364.015	170.365	191.916	170.355	
87,00	3.425	38,00	1.496	FDS80	364.015	170.365	191.916	170.355	
88,00	3.465	39,00	1.535	FDS80	364.015	170.365	191.916	170.355	
88,90	3.500	40,00	1.575	FDS80	364.015	170.365	191.916	170.355	
89,00	3.504	40,00	1.575	FDS80	364.015	170.365	191.916	170.355	
90,00	3.543	37,00	1.457	FDS90	364.015	170.365	191.916	170.355	
91,00	3.583	38,00	1.496	FDS90	364.015	170.365	191.916	170.355	
92,00	3.622	39,00	1.535	FDS90	364.015	170.365	191.916	170.355	
92,08	3.625	39,00	1.535	FDS90	364.015	170.365	191.916	170.355	
93,00	3.661	40,00	1.575	FDS90	364.015	170.365	191.916	170.355	
94,00	3.701	26,00	1.024	FDS90	364.012	170.355	191.916	170.355	
95,00	3.740	27,00	1.063	FDS90	364.012	170.355	191.916	170.355	
95,25	3.750	27,00	1.063	FDS90	364.012	170.355	191.916	170.355	
96,00	3.780	28,00	1.102	FDS90	364.012	170.355	191.916	170.355	
97,00	3.819	29,00	1.142	FDS90	364.013	170.365	191.916	170.355	
98,00	3.858	30,00	1.181	FDS90	364.013	170.365	191.916	170.355	
98,43	3.875	31,00	1.220	FDS90	364.013	170.365	191.916	170.355	
99,00	3.898	31,00	1.220	FDS90	364.013	170.365	191.916	170.355	
100,00	3.937	32,00	1.260	FDS90	364.013	170.365	191.916	170.355	
101,60	4.000	34,00	1.339	FDS90	364.015	170.365	191.916	170.355	



Modular Drills







■ KSEM PLUS B1 Heads 28–101,60mm (1.102–4") • Spare Parts

Modular Drills

D1		PDD										
mm	in	mm	in	CSMS system size	KSEM insert screw	Torx wrench	DFC insert screw	Torx wrench	DPA guiding pad screw	Torx wrench	shim pack	
28,00	1.102	14,00	.551	FDS28	364.016	170.350	192.432	170.352	192.432	170.352	193.554	
28,58	1.125	15,00	.591	FDS28	364.016	170.350	192.432	170.352	192.432	170.352	193.554	
29,00	1.142	15,00	.591	FDS28	364.016	170.350	192.432	170.352	192.432	170.352	193.554	
29,36	1.156	16,00	.630	FDS28	364.010	170.345	192.432	170.352	192.432	170.352	193.554	
30,00	1.181	16,00	.630	FDS28	364.010	170.345	192.432	170.352	192.432	170.352	193.554	
30,18	1.188	17,00	.669	FDS28	364.010	170.345	192.432	170.352	192.432	170.352	193.554	
30,96	1.219	17,00	.669	FDS28	364.010	170.345	192.432	170.352	192.432	170.352	193.554	
31,00	1.220	17,00	.669	FDS28	364.010	170.345	192.432	170.352	192.432	170.352	193.554	
31,75	1.250	15,00	.591	FDS32	364.016	170.350	191.924	170.353	191.924	170.353	193.555	
32,00	1.260	15,00	.591	FDS32	364.016	170.350	191.924	170.353	191.924	170.353	193.555	
33,00	1.299	16,00	.630	FDS32	364.010	170.345	191.924	170.353	191.924	170.353	193.555	
33,20	1.307	16,00	.630	FDS32	364.010	170.345	191.924	170.353	191.924	170.353	193.555	
33,35	1.313	17,00	.669	FDS32	364.010	170.345	191.924	170.353	191.924	170.353	193.555	
34,00	1.339	17,00	.669	FDS32	364.010	170.345	191.924	170.353	191.924	170.353	193.555	
34,93	1.375	18,00	.709	FDS32	364.010	170.345	191.924	170.353	191.924	170.353	193.555	
35,00	1.378	18,00	.709	FDS32	364.010	170.345	191.924	170.353	191.924	170.353	193.555	
36,00	1.417	13,00	.512	FDS36	364.016	170.350	191.916	170.355	191.924	170.353	193.555	
36,53	1.438	14,00	.551	FDS36	364.016	170.350	191.916	170.355	191.924	170.353	193.555	
37,00	1.457	14,00	.551	FDS36	364.016	170.350	191.916	170.355	191.924	170.353	193.555	
37,50	1.476	15,00	.591	FDS36	364.016	170.350	191.916	170.355	191.924	170.353	193.555	
38,00	1.496	15,00	.591	FDS36	364.016	170.350	191.916	170.355	191.924	170.353	193.555	
38,10	1.500	15,00	.591	FDS36	364.016	170.350	191.916	170.355	191.924	170.353	193.555	
39,00	1.535	16,00	.630	FDS36	364.010	170.345	191.916	170.355	191.924	170.353	193.555	
39,20	1.543	16,00	.630	FDS36	364.010	170.345	191.916	170.355	191.924	170.353	193.555	
39,70	1.563	17,00	.669	FDS36	364.010	170.345	191.916	170.355	191.924	170.353	193.555	
40,00	1.575	17,00	.669	FDS40	364.010	170.345	191.916	170.355	191.924	170.353	193.555	
41,00	1.614	18,00	.709	FDS40	364.010	170.345	191.916	170.355	191.924	170.353	193.555	
41,28	1.625	18,00	.709	FDS40	364.010	170.345	191.916	170.355	191.924	170.353	193.555	
42,00	1.654	19,00	.748	FDS40	364.010	170.345	191.916	170.355	191.924	170.353	193.555	
43,00	1.693	20,00	.787	FDS40	364.011	170.346	191.916	170.355	191.924	170.353	193.555	
44,00	1.732	21,00	.827	FDS40	364.011	170.346	191.916	170.355	191.924	170.353	193.555	
44,45	1.750	22,00	.866	FDS40	364.011	170.346	191.916	170.355	191.924	170.353	193.555	
45,00	1.772	18,00	.709	FDS45	364.010	170.345	191.916	170.355	191.924	170.353	193.555	
46,00	1.811	19,00	.748	FDS45	364.010	170.345	191.916	170.355	191.924	170.353	193.555	
47,00	1.850	20,00	.787	FDS45	364.011	170.346	191.916	170.355	191.924	170.353	193.555	
47,63	1.875	21,00	.827	FDS45	364.011	170.346	191.916	170.355	191.924	170.353	193.555	
48,00	1.890	21,00	.827	FDS45	364.011	170.346	191.916	170.355	191.924	170.353	193.555	
49,00	1.929	22,00	.866	FDS45	364.011	170.346	191.916	170.355	191.924	170.353	193.555	
50,00	1.969	23,00	.906	FDS50	364.011	170.346	191.916	170.355	191.916	170.355	193.556	
50,80	2.000	24,00	.945	FDS50	364.011	170.346	191.916	170.355	191.916	170.355	193.556	
51,00	2.008	24,00	.945	FDS50	364.011	170.346	191.916	170.355	191.916	170.355	193.556	
52,00	2.047	25,00	.984	FDS50	364.012	170.347	191.916	170.355	191.916	170.355	193.556	
53,00	2.087	26,00	1.024	FDS50	364.012	170.347	191.916	170.355	191.916	170.355	193.556	
53,98	2.125	27,00	1.063	FDS50	364.012	170.347	191.916	170.355	191.916	170.355	193.556	
54,00	2.126	27,00	1.063	FDS50	364.012	170.347	191.916	170.355	191.916	170.355	193.556	
55,00	2.165	28,00	1.102	FDS50	364.012	170.347	191.916	170.355	191.916	170.355	193.556	
56,00	2.205	20,00	.787	FDS56	364.011	170.346	191.726	170.356	191.916	170.355	193.556	
57,00	2.244	21,00	.827	FDS56	364.011	170.346	191.726	170.356	191.916	170.355	193.556	
57,15	2.250	21,00	.827	FDS56	364.011	170.346	191.726	170.356	191.916	170.355	193.556	
58,00	2.283	22,00	.866	FDS56	364.011	170.346	191.726	170.356	191.916	170.355	193.556	
59,00	2.323	23,00	.906	FDS56	364.011	170.346	191.726	170.356	191.916	170.355	193.556	
60,00	2.362	24,00	.945	FDS56	364.011	170.346	191.726	170.356	191.916	170.355	193.556	
60,33	2.375	24,00	.945	FDS56	364.011	170.346	191.726	170.356	191.916	170.355	193.556	
61,00	2.402	25,00	.984	FDS56	364.012	170.347	191.726	170.356	191.916	170.355	193.556	
62,00	2.441	26,00	1.024	FDS56	364.012	170.347	191.726	170.356	191.916	170.355	193.556	
63,00	2.480	27,00	1.063	FDS63	364.012	170.347	191.726	170.356	191.916	170.355	193.556	

(continued)

(KSEM PLUS B1 Heads 28–101,60mm (1.102–4") • Spare Parts — continued)

D1		PDD										
mm	in	mm	in	CSMS system size	KSEM insert screw	Torx wrench	DFC insert screw	Torx wrench	DPA guiding pad screw	Torx wrench	shim pack	
63,50	2.500	28,00	1.102	FDS63	364.012	170.347	191.726	170.356	191.916	170.355	193.556	
64,00	2.520	28,00	1.102	FDS63	364.012	170.347	191.726	170.356	191.916	170.355	193.556	
65,00	2.559	29,00	1.142	FDS63	364.013	170.348	191.726	170.356	191.916	170.355	193.556	
66,00	2.598	30,00	1.181	FDS63	364.013	170.348	191.726	170.356	191.916	170.355	193.556	
66,68	2.625	31,00	1.221	FDS63	364.013	170.348	191.726	170.356	191.916	170.355	193.556	
67,00	2.638	31,00	1.221	FDS63	364.013	170.348	191.726	170.356	191.916	170.355	193.556	
68,00	2.677	32,00	1.260	FDS63	364.013	170.348	191.726	170.356	191.916	170.355	193.556	
69,00	2.717	33,00	1.299	FDS63	364.015	170.348	191.726	170.356	191.916	170.355	193.556	
69,85	2.750	34,00	1.339	FDS63	364.015	170.348	191.726	170.356	191.916	170.355	193.556	
70,00	2.756	34,00	1.339	FDS63	364.015	170.348	191.726	170.356	191.916	170.355	193.556	
71,00	2.795	26,00	1.024	FDS71	364.012	170.347	191.916	170.356	191.916	170.355	193.556	
72,00	2.835	27,00	1.063	FDS71	364.012	170.347	191.916	170.356	191.916	170.355	193.556	
73,00	2.874	28,00	1.102	FDS71	364.012	170.347	191.916	170.356	191.916	170.355	193.556	
73,03	2.875	28,00	1.102	FDS71	364.012	170.347	191.916	170.356	191.916	170.355	193.556	
74,00	2.913	29,00	1.142	FDS71	364.013	170.365	191.916	170.356	191.916	170.355	193.556	
75,00	2.953	30,00	1.181	FDS71	364.013	170.365	191.916	170.356	191.916	170.355	193.556	
76,00	2.992	31,00	1.220	FDS71	364.013	170.365	191.916	170.356	191.916	170.355	193.556	
76,20	3.000	31,00	1.220	FDS71	364.013	170.365	191.916	170.355	191.916	170.356	193.556	
77,00	3.031	32,00	1.260	FDS71	364.013	170.365	191.916	170.355	191.916	170.356	193.556	
78,00	3.071	33,00	1.299	FDS71	364.015	170.365	191.916	170.355	191.916	170.356	193.556	
79,00	3.110	34,00	1.339	FDS71	364.015	170.365	191.916	170.355	191.916	170.356	193.556	
79,38	3.125	31,00	1.220	FDS80	364.013	170.365	191.916	170.355	191.916	170.356	193.556	
80,00	3.150	31,00	1.220	FDS80	364.013	170.365	191.916	170.355	191.916	170.356	193.556	
81,00	3.189	32,00	1.260	FDS80	364.013	170.365	191.916	170.355	191.916	170.356	193.556	
82,00	3.228	33,00	1.299	FDS80	364.015	170.365	191.916	170.355	191.916	170.356	193.556	
82,55	3.250	34,00	1.339	FDS80	364.015	170.355	191.916	170.355	191.916	170.356	193.556	
83,00	3.268	34,00	1.339	FDS80	364.015	170.355	191.916	170.355	191.916	170.356	193.556	
84,00	3.307	35,00	1.378	FDS80	364.015	170.355	191.916	170.355	191.916	170.356	193.556	
85,00	3.346	36,00	1.417	FDS80	364.015	170.355	191.916	170.355	191.916	170.356	193.556	
85,73	3.375	37,00	1.457	FDS80	364.015	170.355	191.916	170.355	191.916	170.356	193.556	
86,00	3.386	37,00	1.457	FDS80	364.015	170.355	191.916	170.355	191.916	170.356	193.556	
87,00	3.425	38,00	1.496	FDS80	364.015	170.355	191.916	170.355	191.916	170.356	193.556	
88,00	3.465	39,00	1.535	FDS80	364.015	170.355	191.916	170.355	191.916	170.356	193.556	
88,90	3.500	40,00	1.575	FDS80	364.015	170.355	191.916	170.355	191.916	170.356	193.556	
89,00	3.504	40,00	1.575	FDS80	364.015	170.355	191.916	170.355	191.916	170.356	193.556	
90,00	3.543	37,00	1.457	FDS90	364.015	170.355	191.916	170.355	191.916	170.356	193.556	
91,00	3.583	38,00	1.496	FDS90	364.015	170.355	191.916	170.355	191.916	170.356	193.556	
92,00	3.622	39,00	1.535	FDS90	364.015	170.355	191.916	170.355	191.916	170.356	193.556	
92,08	3.625	39,00	1.535	FDS90	364.015	170.355	191.916	170.355	191.916	170.356	193.556	
93,00	3.661	40,00	1.575	FDS90	364.015	170.355	191.916	170.355	191.916	170.356	193.556	
94,00	3.701	26,00	1.024	FDS90	364.012	170.355	191.916	170.355	191.916	170.356	193.556	
95,00	3.740	27,00	1.063	FDS90	364.012	170.355	191.916	170.355	191.916	170.356	193.556	
95,25	3.750	27,00	1.063	FDS90	364.012	170.355	191.916	170.355	191.916	170.356	193.556	
96,00	3.780	28,00	1.102	FDS90	364.012	170.355	191.916	170.355	191.916	170.356	193.556	
97,00	3.819	29,00	1.142	FDS90	364.013	170.355	191.916	170.355	191.916	170.356	193.556	
98,00	3.858	30,00	1.181	FDS90	364.013	170.355	191.916	170.355	191.916	170.356	193.556	
98,43	3.875	31,00	1.220	FDS90	364.013	170.355	191.916	170.355	191.916	170.356	193.556	
99,00	3.898	31,00	1.220	FDS90	364.013	170.355	191.916	170.355	191.916	170.356	193.556	
100,00	3.937	32,00	1.260	FDS90	364.013	170.355	191.916	170.355	191.916	170.356	193.556	
101,60	4.000	34,00	1.339	FDS90	364.015	170.365	191.916	170.355	191.916	170.356	193.556	



- Order KSEM PLUS heads according to the connection coupling size (CSWS).
- Order KSEM PLUS heads separately; see page H91–H96.
- Wrench will be shipped with KSEM PLUS head.
- Custom solution for cast iron application with twisted flutes available.

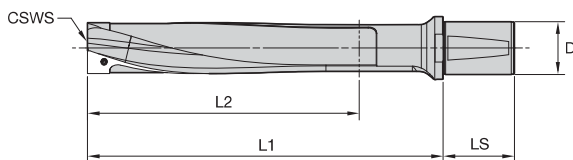

■ KSEM PLUS WD Shanks • 1.5 x D • Metric



1.5 x D catalogue number	CSWS system size	D	L1	L2	LS	clamp screw
WD32FDS28076M	FDS28	32	76	32	58	193.537
WD32FDS32082M	FDS32	32	82	34	58	193.523
WD32FDS36092M	FDS36	32	92	40	58	193.524
WD50FDS40100M	FDS40	50	100	43	68	193.524
WD50FDS45112M	FDS45	50	112	50	68	193.525
WD50FDS50122M	FDS50	50	122	54	68	193.525
WD50FDS56140M	FDS56	50	140	65	68	193.526
WD50FDS63154M	FDS63	50	154	71	68	193.526
WD50FDS71172M	FDS71	50	172	80	68	193.526
WD50FDS80192M	FDS80	50	192	90	68	193.545
WD50FDS90212M	FDS90	50	212	100	68	193.545

■ KSEM PLUS WD Shanks • 3 x D • Metric



3 x D catalogue number	CSWS system size	D	L1	L2	LS	clamp screw
WD32FDS28128M	FDS28	32	128	71	58	193.537
WD32FDS32146M	FDS32	32	146	85	58	193.523
WD32FDS36166M	FDS36	32	166	97	58	193.524
WD50FDS40183M	FDS40	50	183	107	68	193.524
WD50FDS45206M	FDS45	50	206	122	68	193.525
WD50FDS50228M	FDS50	50	228	135	68	193.525
WD50FDS56259M	FDS56	50	259	156	68	193.526
WD50FDS63289M	FDS63	50	289	174	68	193.526
WD50FDS71292M	FDS71	50	292	200	68	193.526
WD50FDS80327M	FDS80	50	327	225	68	193.545
WD50FDS90362M	FDS90	50	362	250	68	193.545

■ KSEM PLUS WD Shanks • 5 x D • Metric



5 x D							
catalogue number	CSWS system size	D	L1	L2	LS	clamp screw	
WD32FDS28190M	FDS28	32	190	133	58	193.537	
WD32FDS32216M	FDS32	32	216	155	58	193.523	
WD32FDS36244M	FDS36	32	244	175	58	193.524	
WD50FDS40271M	FDS40	50	271	195	68	193.524	
WD50FDS45304M	FDS45	50	304	220	68	193.525	
WD50FDS50338M	FDS50	50	338	245	68	193.525	
WD50FDS56383M	FDS56	50	383	280	68	193.526	
WD50FDS63429M	FDS63	50	429	314	68	193.526	
WD50FDS71452M	FDS71	50	452	360	68	193.526	
WD50FDS80507M	FDS80	50	507	405	68	193.545	
WD50FDS90562M	FDS90	50	562	450	68	193.545	

■ KSEM PLUS WD Shanks • 8 x D • Metric



8 x D							
catalogue number	CSWS system size	D	L1	L2	LS	clamp screw	
WD32FDS28283M	FDS28	32	283	226	58	193.537	
WD32FDS32321M	FDS32	32	321	260	58	193.523	
WD32FDS36361M	FDS36	32	361	292	58	193.524	
WD50FDS40403M	FDS40	50	403	327	68	193.524	
WD50FDS45451M	FDS45	50	451	367	68	193.525	
WD50FDS50503M	FDS50	50	503	410	68	193.525	
WD50FDS56569M	FDS56	50	569	466	68	193.526	
WD50FDS63639M	FDS63	50	639	524	68	193.526	

■ KSEM PLUS WD Shanks • 10 x D • Metric



10 x D							
catalogue number	CSWS system size	D	L1	L2	LS	clamp screw	
WD32FDS28345M	FDS28	32	345	288	58	193.537	
WD32FDS32391M	FDS32	32	391	330	58	193.523	
WD32FDS36439M	FDS36	32	439	370	58	193.524	
WD50FDS40491M	FDS40	50	491	415	68	193.524	
WD50FDS45549M	FDS45	50	549	465	68	193.525	
WD50FDS50613M	FDS50	50	613	520	68	193.525	
WD50FDS56693M	FDS56	50	693	590	68	193.526	
WD50FDS63779M	FDS63	50	779	664	68	193.526	

■ KSEM PLUS Carbide Insert Recommendations

Modular Drills

Material Group	Outboard/ Inboard	Insert Style	Grade	Page(s)	Comments	
P	O	DFR-GD	KCU25, KCU40	H89	Recommended outboard insert style for working in all P-materials. Start with KCU40™ and use KCU25™ in stable conditions to achieve higher tool life.	
		DFC-/DFT-HP		H90, H88		
	I	DFC-/DFT-DS	KCU40	H90, H88	Reduce feed rate by 10% to further improve chip formation in long-chipping steels and low carbon steel.	
	I	KSEMP-HPG	KC7315	H87	Must use KSEMP centre inserts in P-materials to avoid excessive wear on head & inserts.	
M	O	DFR-MD	KC7140	H89	Recommended outboard insert style for working in all M-materials.	
		DFC-/DFT-MD		H90, H89		
		I	DFC-/DFT-DS	KCU40	H90, H88	Reduce feed rate by 20% to further improve chip formation and/or run with lower power consumption.
	I	KSEMP-HPG	KC7315	H87	Recommended inboard insert style for working in all M-materials.	
		KSEM-PC	KC7135	H56, H87	For unstable conditions in stainless steel, use KSEM PC inserts.	
	KSEM-HPL	KC7320	H50	If chip control issue resulting from centre insert occurs in M-materials, use KSEM HPL insert inboard. Reduction of feed rate up to 20% is recommended.		
K	O	DFR-LD	KCU25	H89	Recommended insert styles for working in all K-Materials.	
		DFC-/DFT-HP		H90, H88		
	I	KSEM-HPCCL	KC7410	H48, H87		
N	O	DFR-GD	KC7225	H89	Recommended outboard insert styles for working in all non-ferrous materials.	
		DFC-/DFT-HP	KCU40	H90, H88		
		I	DFC-/DFT-DS	KCU40	H90, H88	Reduce feed rate by 15% for diameters <56mm and up to 50% for larger diameters to improve chip formation.
			DFR/DFT-ST	KD1425	J85	Use PCD tipped outboard when working with CFRP, CFRP/metal stacks and plastics (N3, N5, and N6).
	I	KSEMP-HPG	KC7315	H87	Recommended inboard insert style for working in all non-ferrous materials.	
	KSEM-HPS	K715	—	This is a made-to-order item (uncoated/sharp) — use it to improve your results in N3, N5, and N6, if required.		
S	O	DFR-GD	KC7140	H89	Recommended outboard insert style for working in all S-materials.	
		DFC-/DFT-HP	KCU40	H90, H88		
		I	DFC-/DFT-DS	KCU40	H90, H88	Reduce feed rate by 20% to further improve chip formation and/or run with lower power consumption.
		KSEM-PC	KC7135	H56, H87	If centre breakage is an issue in S-materials, use KSEM PC insert inboard.	

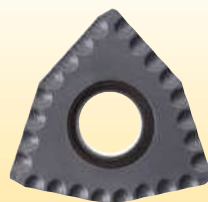

Need help with bad chip formation?

Our new DS geometry for DFT™ and DFC™ inserts on KSEM PLUS helps you to improve your performance in long chipping materials.

If chip formation is an issue, you may use our new DFT and DFC DS style inserts with the recommendations for feed rate adjustments given as indicated.

Modular Drill • KSEM PLUS™ • Metric • A1 and B1 Style

		Metric									
Material Group	Condition	Cutting Speed – vc Range – m/min			Recommended Feed Rate (fz) by Diameter						
		min	Starting Value	max	Ø	KSEM 14....17 DFR/DFC04... 28,00–31,74	KSEM 15....18 DFT/DFC05... 31,74–35,99	KSEM 13....22 DFT/DFC06... 36,00–44,99	KSEM 18....28 DFT/DFC07... 45,00–55,99	KSEM 20....34 DFT/DFC09... 56,00–102,35	
P	1	S	115	235	290	mm/r	0,130–0,250	0,130–0,250	0,160–0,280	0,160–0,320	0,200–0,360
		U	90	160	215	mm/r	0,130–0,250	0,130–0,250	0,160–0,280	0,160–0,320	0,200–0,360
		I	65	100	140	mm/r	0,130–0,250	0,130–0,250	0,160–0,280	0,160–0,320	0,200–0,360
	2	S	90	190	230	mm/r	0,160–0,280	0,160–0,280	0,200–0,360	0,200–0,400	0,200–0,450
		U	71	130	170	mm/r	0,160–0,280	0,160–0,280	0,200–0,360	0,200–0,400	0,200–0,450
		I	50	80	110	mm/r	0,160–0,280	0,160–0,280	0,200–0,320	0,200–0,400	0,200–0,450
	3	S	90	180	230	mm/r	0,160–0,280	0,160–0,280	0,200–0,320	0,200–0,400	0,200–0,450
		U	70	120	170	mm/r	0,160–0,280	0,160–0,280	0,200–0,320	0,200–0,400	0,200–0,450
		I	50	70	106	mm/r	0,160–0,280	0,160–0,280	0,200–0,320	0,200–0,400	0,200–0,450
	4	S	90	140	220	mm/r	0,160–0,280	0,160–0,280	0,200–0,320	0,200–0,400	0,200–0,450
		U	70	110	160	mm/r	0,160–0,280	0,160–0,280	0,200–0,320	0,200–0,400	0,200–0,450
		I	50	80	110	mm/r	0,160–0,280	0,160–0,280	0,200–0,320	0,200–0,400	0,200–0,450
	5	S	90	130	210	mm/r	0,160–0,280	0,160–0,280	0,200–0,320	0,200–0,400	0,200–0,450
		U	70	100	150	mm/r	0,160–0,280	0,160–0,280	0,200–0,320	0,200–0,400	0,200–0,450
		I	50	70	100	mm/r	0,160–0,280	0,160–0,280	0,200–0,320	0,200–0,400	0,200–0,450
	6	S	70	90	180	mm/r	0,160–0,280	0,160–0,280	0,200–0,320	0,200–0,400	0,200–0,450
		U	50	75	120	mm/r	0,160–0,280	0,160–0,280	0,200–0,320	0,200–0,400	0,200–0,450
		I	40	60	100	mm/r	0,160–0,280	0,160–0,280	0,200–0,320	0,200–0,400	0,200–0,450
M	1	S	60	110	135	mm/r	0,130–0,250	0,130–0,250	0,160–0,280	0,160–0,320	0,200–0,360
		U	40	70	90	mm/r	0,130–0,250	0,130–0,250	0,160–0,280	0,160–0,320	0,200–0,360
		I	30	50	65	mm/r	0,130–0,250	0,130–0,250	0,160–0,280	0,160–0,320	0,200–0,360
	2	S	60	100	135	mm/r	0,130–0,250	0,130–0,250	0,160–0,280	0,160–0,320	0,200–0,360
		U	40	60	90	mm/r	0,130–0,250	0,130–0,250	0,160–0,280	0,160–0,320	0,200–0,360
		I	30	50	65	mm/r	0,130–0,250	0,130–0,250	0,160–0,280	0,160–0,320	0,200–0,360
	3	S	50	90	135	mm/r	0,130–0,250	0,130–0,250	0,160–0,280	0,160–0,320	0,200–0,360
		U	40	60	90	mm/r	0,130–0,250	0,130–0,250	0,160–0,280	0,160–0,320	0,200–0,360
		I	25	40	65	mm/r	0,130–0,250	0,130–0,250	0,160–0,280	0,160–0,320	0,200–0,360
K	1	S	90	170	230	mm/r	0,180–0,300	0,180–0,300	0,216–0,360	0,240–0,420	0,300–0,480
		U	60	120	160	mm/r	0,180–0,300	0,180–0,300	0,216–0,360	0,240–0,420	0,300–0,480
		I	40	70	90	mm/r	0,180–0,300	0,180–0,300	0,216–0,360	0,240–0,420	0,300–0,480
	2	S	90	160	220	mm/r	0,180–0,300	0,180–0,300	0,216–0,360	0,240–0,420	0,300–0,480
		U	60	110	160	mm/r	0,180–0,300	0,180–0,300	0,216–0,360	0,240–0,420	0,300–0,480
		I	40	70	100	mm/r	0,180–0,300	0,180–0,300	0,216–0,360	0,240–0,420	0,300–0,480
	3	S	90	150	210	mm/r	0,180–0,300	0,180–0,300	0,216–0,360	0,240–0,420	0,300–0,480
		U	60	100	150	mm/r	0,180–0,300	0,180–0,300	0,216–0,360	0,240–0,420	0,300–0,480
		I	35	60	90	mm/r	0,180–0,300	0,180–0,300	0,216–0,360	0,240–0,420	0,300–0,480
N	1	S	150	240	360	mm/r	0,120–0,200	0,120–0,200	0,144–0,280	0,160–0,320	0,200–0,400
		U	100	160	240	mm/r	0,120–0,200	0,120–0,200	0,144–0,280	0,160–0,320	0,200–0,400
		I	60	100	160	mm/r	0,120–0,200	0,120–0,200	0,144–0,280	0,160–0,320	0,200–0,400
	2	S	150	220	360	mm/r	0,120–0,200	0,120–0,200	0,144–0,280	0,160–0,320	0,200–0,400
		U	100	150	240	mm/r	0,120–0,200	0,120–0,200	0,144–0,280	0,160–0,320	0,200–0,400
		I	60	100	160	mm/r	0,120–0,200	0,120–0,200	0,144–0,280	0,160–0,320	0,200–0,400
	3	S	150	200	360	mm/r	0,120–0,200	0,120–0,200	0,144–0,280	0,160–0,320	0,200–0,400
		U	100	140	240	mm/r	0,120–0,200	0,120–0,200	0,144–0,280	0,160–0,320	0,200–0,400
		I	60	90	160	mm/r	0,120–0,200	0,120–0,200	0,144–0,280	0,160–0,320	0,200–0,400
	4	S	150	200	360	mm/r	0,120–0,200	0,120–0,200	0,144–0,280	0,160–0,320	0,200–0,400
		U	100	140	240	mm/r	0,120–0,200	0,120–0,200	0,144–0,280	0,160–0,320	0,200–0,400
		I	60	90	160	mm/r	0,120–0,200	0,120–0,200	0,144–0,280	0,160–0,320	0,200–0,400
	5	S	150	200	360	mm/r	0,120–0,200	0,120–0,200	0,144–0,280	0,160–0,320	0,200–0,400
		U	100	140	240	mm/r	0,120–0,200	0,120–0,200	0,144–0,280	0,160–0,320	0,200–0,400
		I	60	90	160	mm/r	0,120–0,200	0,120–0,200	0,144–0,280	0,160–0,320	0,200–0,400
	6	S	150	200	360	mm/r	0,120–0,200	0,120–0,200	0,144–0,280	0,160–0,320	0,200–0,400
		U	100	140	240	mm/r	0,120–0,200	0,120–0,200	0,144–0,280	0,160–0,320	0,200–0,400
		I	60	90	160	mm/r	0,120–0,200	0,120–0,200	0,144–0,280	0,160–0,320	0,200–0,400
7	S	110	220	260	mm/r	0,120–0,200	0,120–0,200	0,144–0,280	0,160–0,320	0,200–0,400	
	U	70	140	170	mm/r	0,120–0,200	0,120–0,200	0,144–0,280	0,160–0,320	0,200–0,400	
	I	45	90	110	mm/r	0,120–0,200	0,120–0,200	0,144–0,280	0,160–0,320	0,200–0,400	
S	1	S	25	50	75	mm/r	0,130–0,250	0,130–0,250	0,160–0,280	0,160–0,320	0,200–0,360
		U	20	40	60	mm/r	0,130–0,250	0,130–0,250	0,160–0,280	0,160–0,320	0,200–0,360
		I	15	30	50	mm/r	0,130–0,250	0,130–0,250	0,160–0,280	0,160–0,320	0,200–0,360
	2	S	20	40	60	mm/r	0,130–0,250	0,130–0,250	0,160–0,280	0,160–0,320	0,200–0,360
		U	15	30	45	mm/r	0,130–0,250	0,130–0,250	0,160–0,280	0,160–0,320	0,200–0,360
		I	12	25	35	mm/r	0,130–0,250	0,130–0,250	0,160–0,280	0,160–0,320	0,200–0,360
	3	S	20	40	60	mm/r	0,130–0,250	0,130–0,250	0,160–0,280	0,160–0,320	0,200–0,360
		U	15	30	45	mm/r	0,130–0,250	0,130–0,250	0,160–0,280	0,160–0,320	0,200–0,360
		I	12	25	40	mm/r	0,130–0,250	0,130–0,250	0,160–0,280	0,160–0,320	0,200–0,360
	4	S	20	40	60	mm/r	0,130–0,250	0,130–0,250	0,160–0,280	0,160–0,320	0,200–0,360
		U	15	30	45	mm/r	0,130–0,250	0,130–0,250	0,160–0,280	0,160–0,320	0,200–0,360
		I	12	25	40	mm/r	0,130–0,250	0,130–0,250	0,160–0,280	0,160–0,320	0,200–0,360



Modular Drills



KSEM PLUS Customised Solution Capabilities:

Application	Workpiece Shape	A1 Head	B1 Head
Flat Face		✓	✓
Cored Hole		✗	✓
Stacked Plates		✗	✓
Angled Exit (exit only!)		✓ <math><3^\circ</math>	✓ max 15°
Angled Entrance		✓ <math><3^\circ</math>	✓ <math><3^\circ</math>
Cross Holes		✗	✓ max 50% of D1

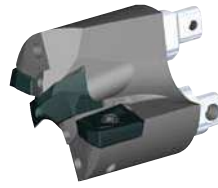

- Intermediate head Ø.
- Custom head to use reground KSEM™ inserts.
- Heads for cross holes $\text{Ø} = d1$.

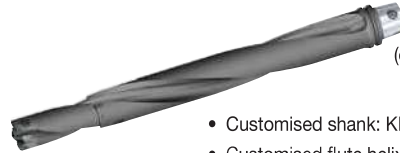

(example)

- Customised shank: KM™, HSK, VDI, ISO taper, etc.
- Customised flute helix.
- Step drill.



- Drill body up to $L1 = 20 \times D$ and total length of 1250mm.

Mounting DPA Guiding Pads on B1 Heads

All B1 heads are delivered with preset guiding pads.

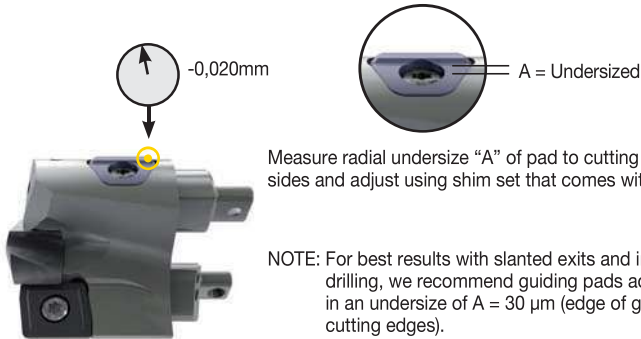

Coolant Recommendations

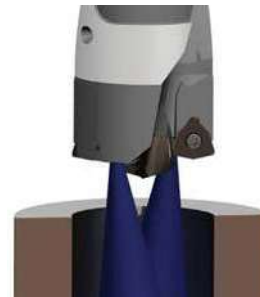

Internal coolant is recommended for optimum chip flow and tool life.

KSEM PLUS Piloting Insert SHOULD NOT Be Reground:

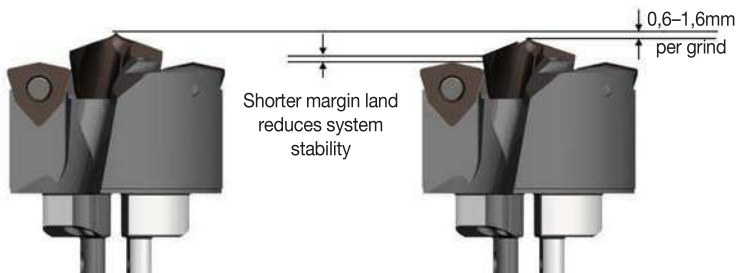

Only new KSEM PLUS inserts will provide consistency and process security on a KSEM PLUS modular drill system. If you want to regrind, refer to our custom solution A1 and B1 heads.

NOTE: Reground KSEM PLUS inserts can be used in KSEM™ drills.

Piloting Instructions:

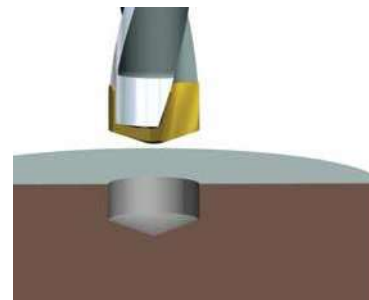

1. KSEM...PC Pilot drill Ø equal KSEMP Ø PDD
2. Drill 1mm deep from full diameter

Mobile App

The Kennametal mobile app makes it easy to access product information, calculators, and much more from iPhone® and Android™ devices.



FEATURES

Scan a Kennametal tool package barcode or search a product catalogue number to access complete product information.

Product information includes tool image, dimensions, grades, and product highlights.

View product availability at global locations.

Get speed and feed information in inch and metric values for all metalcutting products.

View tech tips for helpful solutions to common machining questions.

Contact Customer Support directly from the app.

MACHING CALCULATORS

View data for milling and drilling applications.

Inch and metric values calculated.

ORDERING

Login using your Konnect credentials to complete a purchase.

WHERE TO FIND IT

Download the free app today from iTunes® or the Google Play™ store.

